

Back-UPS™ Uninterruptible Power Supply

BE500G2-FR/BE500G2-GR/BE500G2-IT/BE500G2-UK

BE650G2-FR/BE650G2-GR/BE650G2-IT/BE650G2-UK

BE850G2-FR/BE850G2-GR/BE850G2-IT/BE850G2-UK

BE1050G2-FR/BE1050G2-GR/BE1050G2-IT/BE1050G2-UK

User Manual

EN TME37615

03/2024

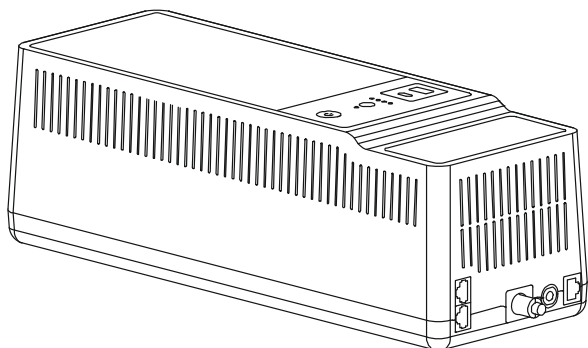

Legal Information

The APC brand and any trademarks of Schneider Electric SE and its subsidiaries referred to in this guide are the property of Schneider Electric SE or its subsidiaries. All other brands may be trademarks of their respective owners.

This guide and its content are protected under applicable copyright laws and furnished for informational use only. No part of this guide may be reproduced or transmitted in any form or by any means (electronic, mechanical, photocopying, recording, or otherwise), for any purpose, without the prior written permission of APC.

APC does not grant any right or license for commercial use of the guide or its content, except for a non-exclusive and personal license to consult it on an "as is" basis. APC products and equipment should be installed, operated, serviced, and maintained only by qualified personnel.

As standards, specifications, and designs change from time to time, information contained in this guide may be subject to change without notice.

To the extent permitted by applicable law, no responsibility or liability is assumed by APC and its subsidiaries for any errors or omissions in the informational content of this material or consequences arising out of or resulting from the use of the information contained herein.

Important Safety Instructions

SAVE THESE INSTRUCTIONS - This manual contains important instructions that should be followed during installation and operation of the Back-UPS and batteries.



This is the “Read user manual” symbol. Read the instructions in the Safety Guide supplied with the UPS before trying to install or operate it.

Read these instructions carefully and look at the equipment to become familiar with the device before trying to install or operate it.

The following special messages may appear throughout this bulletin or on the equipment to warn of potential hazards or to call attention to information that clarifies or simplifies a procedure.



The addition of this symbol either to a “Danger” or “Warning” safety label indicates that an electrical hazard exists which will result in personal injury if the instructions are not followed.



This is the safety alert symbol. It is used to alert you to potential personal injury hazards. Obey all safety messages that follow this symbol to avoid possible injury or death.

DANGER

DANGER indicates a hazardous situation which, if not avoided, **will result** in death or serious injury.

WARNING

WARNING indicates a hazardous situation which, if not avoided, **could result** in death or serious injury.

CAUTION

CAUTION indicates a hazardous situation which, if not avoided, **could result** in minor or moderate injury.







NOTICE

NOTICE is used to address practices not related to physical injury.

This user manual is available online and can be downloaded either by scanning the QR Code on the UPS or from URL

<https://www.go2se.com/ref=<UPS model number>/DownloadDocuments>.

Product Handling Guidelines

					
<18 kg <40 lb	18-32 kg 40-70 lb	32-55 kg 70-120 lb	>55 kg >120 lb		

Electrical equipment should be installed and operated only by qualified personnel. No responsibility is assumed by Schneider Electric for any consequences arising out of the use of this material.

Safety and General Information

- This UPS is for indoor use only.
- Do not operate this UPS in direct sunlight, in contact with fluids, or where there is excessive dust or high humidity.
- Do not operate the UPS near open windows or doors.
- Be sure the air vents on the UPS are not blocked. Allow adequate space for proper ventilation.
NOTE: Allow a minimum of 20 cm clearance on both front and rear sides of the UPS.
- Environmental factors impact battery life. Elevated ambient temperatures, poor quality utility power, and frequent discharges will shorten battery life. Follow the battery manufacturer recommendations.
- Connect the UPS power cable directly to a wall outlet. Do not use surge protectors or extension cords.
- Connect the UPS input power cord to an earthed mains socket.
- **CAUTION:** Before installing or replacing the batteries, remove jewelry such as wristwatches and rings.
High short circuit current through conductive materials could cause severe burns.
- **CAUTION:** Do not open or mutilate batteries. Released material is harmful to the skin and eyes and may be toxic.
- **Changes and modifications to this unit not expressly approved by Schneider Electric could void the warranty.**

Battery Safety

CAUTION

RISK OF HYDROGEN SULPHIDE GAS AND EXCESSIVE SMOKE

- Replace the battery at least every 5 years or at the end of its service life, whichever is earlier.
- Replace the battery immediately when the UPS indicates battery replacement is necessary.
- Replace batteries with the same number and type of batteries as originally installed in the equipment.
- Replace the battery immediately when the UPS indicates a battery overtemperature condition, or when there is evidence of electrolyte leakage. Power OFF the UPS, unplug it from the AC input, and disconnect the batteries. Do not operate the UPS until the batteries have been replaced.

Failure to follow these instructions can result in minor or moderate injury and equipment damage.

- Servicing of batteries should be performed or supervised by personnel knowledgeable about batteries and required precautions.
- Schneider Electric uses Sealed Maintenance-Free Lead Acid batteries. Under normal use and handling, there is no contact with the internal components of the batteries. Over charging, over heating or other misuse of batteries can result in leakage of battery electrolyte. Released electrolyte is toxic and may be harmful to the skin and eyes.
- The battery typically lasts for 3 to 5 years. Environmental factors impact battery life. Elevated ambient temperatures, poor quality utility power, and frequent short duration discharges will shorten battery life. Batteries should be replaced before end of life.
- **CAUTION:** Do not dispose of batteries in a fire. The batteries may explode.

- CAUTION: Do not open or mutilate batteries. Released material is harmful to the skin and eyes. It may be toxic.
- CAUTION: Before installing or replacing the batteries, remove conductive jewelry such as chains, wrist watches, and rings. High energy through conductive materials could cause severe burns.
- CAUTION: Failed batteries can reach temperatures that exceed the burn thresholds for touchable surfaces.
- CAUTION: A battery can present a risk of electrical shock and high short-circuit current. The following precautions should be taken when working on batteries:
 - Disconnect the charging source prior to connecting or disconnecting battery terminals.
 - Do not wear any metal objects including watches and rings.
 - Do not lay tools or metal parts on top of batteries.
 - Use tools with insulated handles.
 - Wear rubber gloves and boots.
 - Determine if battery is either intentionally or inadvertently grounded. Contact with any part of a grounded battery can result in electric shock and burns by high short-circuit current. The risk of such hazards can be reduced if grounds are removed during installation and maintenance by a skilled person.

Electrical Safety

- Use tools with insulated handles.
- Do not handle any metallic connector before power has been disconnected.
- In order to maintain compliance with the EMC regulations, output cords and network attached to the UPS must not exceed 10 meters in length.
- The protective earth conductor for the UPS carries the leakage current from the load devices (computer equipment). An insulated ground conductor is to be installed as part of the branch circuit that supplies the UPS. The conductor must have the same size and insulation material as the grounded and ungrounded branch circuit supply conductors. The conductor will typically be green, with or without a yellow stripe.
- Leakage current for a pluggable, Type A UPS may exceed 3.5 mA when a separate ground terminal is used.
- The UPS input ground conductor must be properly bonded to protective earth at the service panel.
- If the UPS input power is supplied by a separately derived system, the ground conductor must be properly bonded at the supply transformer or motor generator set.

Inventory

Inspect the package contents upon receipt. Notify the carrier and dealer if there is any damage.

Back-UPS

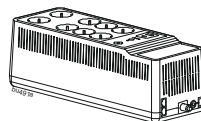

USB cable



Quick start guide



* When input power cord is provided, the length of input power cord is 1.5 m. For best operation, do not use output cable longer than 2m.

** The length of USB communication cable is 1.2 m. For best operation, do not use USB communication and DC charging cable longer than 3 m.

Connect the Battery

⚠ CAUTION

RISK OF FALLING EQUIPMENT
 Always practice safe lifting techniques adequate for the weight of the equipment.
Failure to follow these instructions can result in minor or moderate injury and equipment damage.

500 VA models

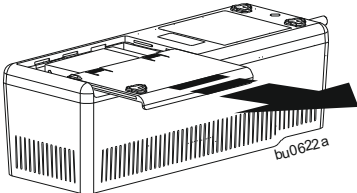
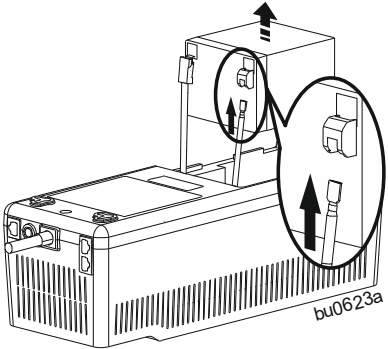
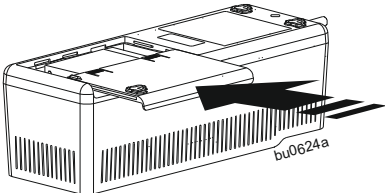
1	Remove the “⚠ <i>Connect Battery First</i> ” label from the top cover.	
2	Invert the Back-UPS. Press the battery compartment cover and release the tabs. Slide open the battery cover.	
3	Lift the battery up and connect the battery cable securely to the battery terminal. NOTE: It is normal for small sparks to be seen when the battery cable is connected to the battery terminal.	
4	Reinstall the battery compartment cover. Be sure that the release tabs lock into place.	

650/850/1050 VA models

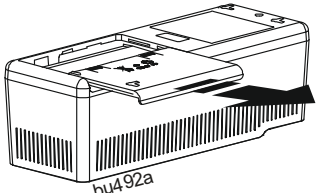
1	Remove the “⚠ <i>Connect Battery First</i> ” label from the top cover.	
2	Invert the Back-UPS. Press the battery compartment cover and release the tabs. Slide open the battery cover.	

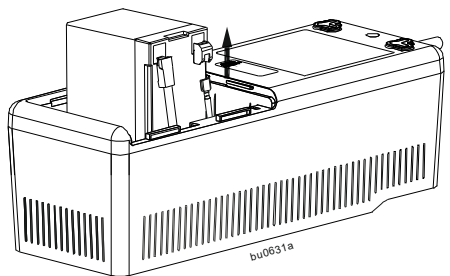
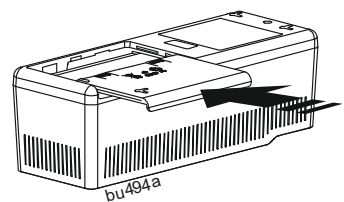
<p>③ Connect the battery cable securely to the battery terminal.</p> <p>NOTE: It is normal for small sparks to be seen when the battery cable is connected to the battery terminal.</p>	
<p>④ Reinstall the battery compartment cover. Be sure that the release tabs lock into place.</p>	

Wall Mount Installation

 CAUTION	
<p>RISK OF FALLING EQUIPMENT</p> <p>Always practice safe lifting techniques adequate for the weight of the equipment.</p> <p>Failure to follow these instructions can result in minor or moderate injury and equipment damage.</p>	

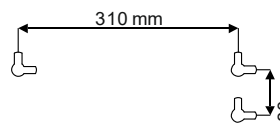
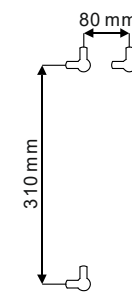
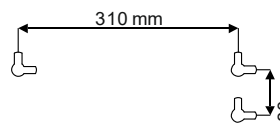
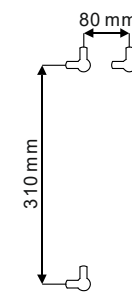
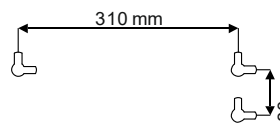
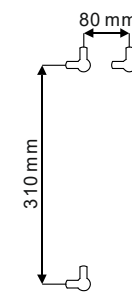
<ol style="list-style-type: none"> ① Secure 3 screws of appropriate size (not supplied) as per dimensions shown in the horizontal/vertical mounting illustrations. ② Allow the screw to protrude out 8mm from the wall. ③ Mount the Back-UPS on to the screws. 	<table border="0"> <tr> <td style="text-align: center;"> <p>Horizontal mounting</p>  </td> <td style="text-align: center;"> <p>Vertical mounting</p>  </td> </tr> </table>	<p>Horizontal mounting</p> 	<p>Vertical mounting</p> 
<p>Horizontal mounting</p> 	<p>Vertical mounting</p> 		

Panel Features

Top panel

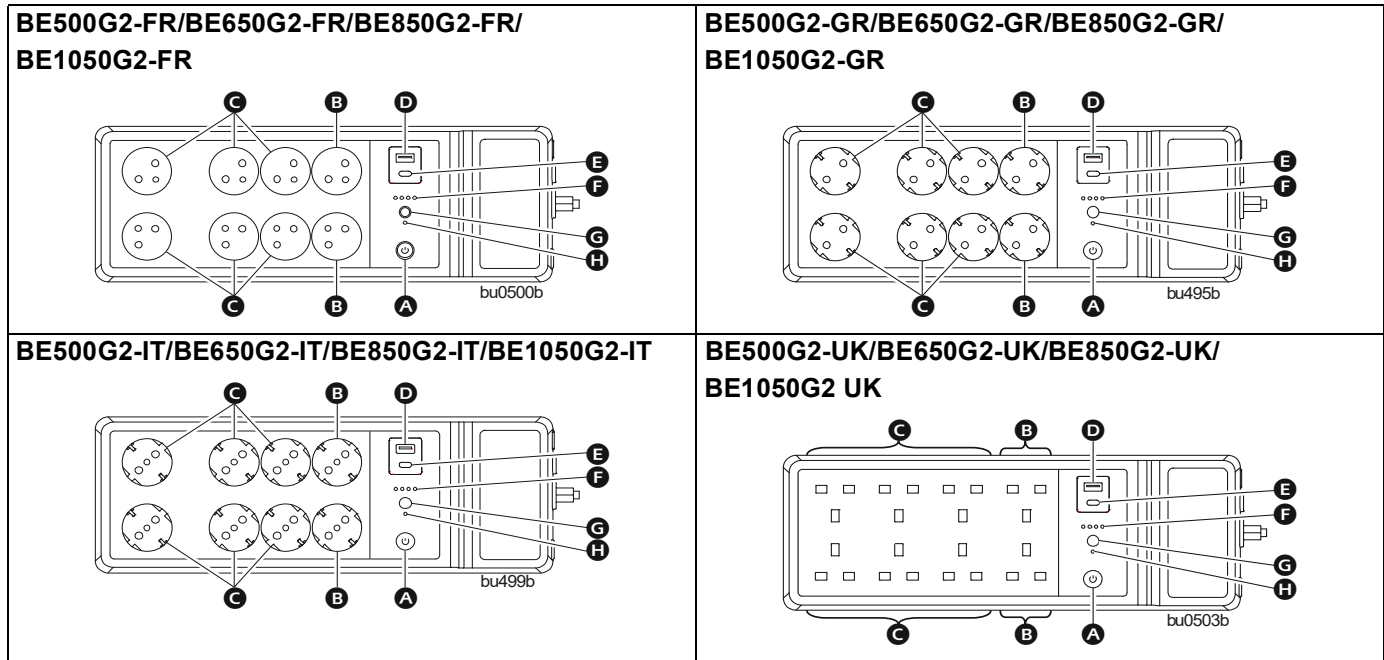

A POWER ON/OFF button with LED	Use to switch the Back-UPS on or off. The LED illuminates green indicating that power is supplied to the connected equipment both on utility power and on battery.
B Surge protection outlets	Surge protection outlets help to provide protection to connected equipment from power surges or spikes, when the Back-UPS is turned on and connected to utility power. Connect peripheral devices (such as printer, scanner, etc.) that do not need to remain on during power outages or brownout condition, to these outlets.
C Battery backup + surge protection outlets	Battery backup outlets provide power from the battery for a limited period of time during power outage, or brownout condition. Battery backup outlets help to provide protection to connected equipment from power surges or spikes, when the Back-UPS is turned on and connected to utility power. Connect a computer, monitor and other peripheral devices which need to remain on during power outages or brownout condition, to these outlets.
D Type A USB charging port	This USB charging port provides a maximum of 2.4 A DC power. The port will charge the connected equipment when the Back-UPS is turned on.
E Type C USB charging port †	
F Battery status LED	The four Battery status LEDs indicate the remaining runtime. When battery is fully charged, all four LEDs illuminate.
G MUTE button	Press MUTE button to Enable or Disable the mute function.
H Mute status LED	Illuminates when the mute function is enabled.

† Type C USB charging port is available only in 850 VA and 1050 VA models.

Side panel

❶	Input power cord	Connect the Input power cord to a wall outlet (utility power). Do not connect the power cord to a surge protector or power strip.	
❷	DSL/modem network/fax port	Connect a DSL or dial-up modem, phone, fax machine, or 10/100 Base-T Ethernet equipment. NOTE: Do not connect the UPS telephone protection ports to both the telephone and network system cables at the same time.	
❸	Wall outlet	Connect the Back-UPS to a data line wall outlet.	
❹	Data port	Connect a RJ45/USB cable (not supplied) to connect the Back-UPS to a computer for installing the software. Refer "PowerChute™ Serial Shutdown" below, for details.	
❺	Circuit breaker	Trips when the Back-UPS experiences an overload condition.	

Specifications

		BE500G2-FR/ BE500G2-IT/ BE500G2-GR/ BE500G2-UK	BE650G2-FR/ BE650G2-IT/ BE650G2-GR/ BE650G2-UK	BE850G2-FR/ BE850G2-IT/ BE850G2-GR/ BE850G2-UK	BE1050G2-FR/ BE1050G2-IT/ BE1050G2-GR/ BE1050G2-UK
Input	Voltage	220 - 240 Vac			
	Frequency	50/60 Hz			
	Brownout Transfers	180 Vac Typical			
	Over-voltage Transfer	266 Vac Typical			
Output	UPS Capacity	500 VA / 300 W	650 VA /400 W	850 VA / 520 W	1050 VA, 600 W
	Short Circuit Current	Approx. 150 Apeak	Approx. 230 Apeak	Approx. 370 Apeak	Approx. 230 Apeak
		6.1 Arms	9.7 Arms	25 Arms	12.9 Arms
		Outlets	6 battery back up outlets and 2 surge protected outlets		
	Total Amperage	5.7 A			
	Voltage - On Battery	230 Vac \pm 8%			
	Frequency - On Battery	50/60 Hz \pm 1 Hz			
	Transfer Time	6 milliseconds Typical, 10 milliseconds maximum			
USB Port	Charging Rating [†]	5 VDC; 2.40 A			
	Charger compatibility	USB Battery Charging Specification 1.2			
Protection and Filtering	AC Surge Protection	Full time, 310 Joules			
	EMI/RFI Filter	Full time			
	Utility Power Input	Resettable circuit breaker			
Battery	Type	Sealed, maintenance-free, lead acid 12 VDC (1 battery)			
	Average Life	3 - 5 years, depending upon the number of discharge cycles and environmental temperature			
	Charging Time	16 hours.			
Physical	Net Weight	7.1 lb (3.2 kg)	9.1 lb (4.1 kg)	10.0 lb (4.5 kg)	10.2 lb (4.6 kg)
	Dimensions - W x H x D	5.1 in x 4.7 in x 14.4 in (13 cm x 12 cm x 36.5 cm)			
Environmental	Operating Temperature	32 °F to 104 °F (0 °C to 40 °C)			
	Storage Temperature	5 °F to 113 °F (-15 °C to 45 °C)			
	Storage Elevation	0 to 9,842 ft (0 to 3,000 m)			
	Operating Elevation	0 to 9,842 ft (0 to 3,000 m)			
	Humidity	0 to 95% RH; non-condensing			
	Pollution Degree	2			
	International Protection Code	IP20			
Overvoltage Category	II				
Applicable power grid power distribution system	TN Power System				
Applicable standard	IEC 62040-1				

[†] Power output is dependent on the power drawn by the connected device. Check with the device manufacturer to understand the maximum charging current for a given USB specification.

Operation

Turn On the Back-UPS

Press the POWER ON/OFF button located on the top of the Back-UPS.

The **Power On/Off** LED will illuminate green and a single short beep will indicate that the Back-UPS is on and providing protection to the connected equipment.

The Back-UPS battery charges to capacity during the first 24 hours while connected to the utility power. The Back-UPS battery will charge while the Back-UPS is turned on or off and as long as it is connected to utility power.

Do not expect the battery to run for its expected capacity during the initial charge period. The UPS will have full runtime capability after the initial charging period.

Turn Off the Back-UPS

Press the POWER ON/OFF button for at least 2 seconds to turn off the Back-UPS. At the first beep, release the button and the UPS will turn off.

A 2 second delay has been added to mitigate unintentional contact with the POWER ON/OFF button.

Mute

The audible alarms of the Back-UPS can be muted. Press the MUTE button to enable or disable the mute function. The **Mute status** LED illuminates when the mute function is enabled.

UPS Self-Test

Press and hold the POWER ON/OFF button for 4 to 8 seconds to initiate the UPS Self-Test.

PowerChute™ Serial Shutdown

Overview

Use PowerChute™ Serial Shutdown software to configure the UPS settings and help to protect your computer and other equipment during a utility power outage. During a power outage, PowerChute will save any open files on your computer and shut it down. When utility power is restored, it will restart the computer.

NOTE: PowerChute is only compatible with a Windows operating system. If you are using Mac OSX, use the native shutdown feature to protect your system. See the documentation provided with your computer.

Installation

Use the USB cable to connect the Data port on the UPS to the USB port on your computer. Download PowerChute Serial Shutdown Software from www.apc.com/pcss and follow the directions to install the software.

Status Indicators

Visual indicator	Audible Indicator	Condition	Audible Indicator Terminates
Power On/Off LED illuminates green	None	Power On - The Back-UPS is supplying utility power to the connected equipment.	Not applicable.
Power On/Off LED flashes green twice every 2 seconds	4 beeps approx. every 30 seconds.	On Battery - The Back-UPS is supplying battery power to the battery backup outlets.	Beeping stops when utility power is restored or the Back-UPS is turned off.
Power On/Off LED flashes green in quick succession.	Rapid beeping (1 beep every 0.5 second)	Low Battery notification The Back-UPS is supplying battery power to the battery backup outlets and the battery is nearing a total discharge state.	
Power On/Off does not illuminate	1 beep every 4 seconds	Low Battery shutdown - The battery has been completely discharged while the Back-UPS is on battery, the Back-UPS will shutdown.	Beeping stops when utility power is restored or the Back-UPS is turned off.
	None	Sleep Mode - The Back-UPS has shutdown and will return to normal operation once utility power is restored.	Not applicable.
Power On/Off LED flashes green and red alternatively	Constant tone	Battery disconnected.	Back-UPS is turned off.
Power On/Off LED flashes green and red alternately	Constant tone	Replace battery - The battery needs to be charged or replaced.	Back-UPS is turned off.
Power On/Off LED does not illuminate	Constant tone	Overload shutdown - An overload condition in one or more of the battery back up outlets when the Back-UPS is operating on battery power.	Back-UPS is turned off.
Mute status LED illuminates	None	Mute function enabled.	Not applicable.
Mute status LED does not illuminate	None	Mute function disabled.	Not applicable.
When the Back-UPS is operating on battery power and the battery is getting discharged			
Battery status LEDs (Illuminated or not illuminated)	None	Refer table "Remaining battery capacity (when UPS is working in on-battery mode)" on page 13below for details.	Not applicable.
When the Back-UPS is on utility power and the battery is charging			
Battery status LEDs (Illuminated or not illuminated or flashing)	None	Refer table "Battery charging status (when UPS is working in on-line mode)" on page 13below for details.	Not applicable.

Remaining battery capacity (when UPS is working in on-battery mode)

Battery Status LED				Description
First	Second	Third	Fourth	
Illuminated	Not Illuminated	Not Illuminated	Not Illuminated	Remaining battery capacity is 0% to 24%
Illuminated	Illuminated	Not Illuminated	Not Illuminated	Remaining battery capacity is 25% to 49%
Illuminated	Illuminated	Illuminated	Not Illuminated	Remaining battery capacity is 50% to 74%
Illuminated	Illuminated	Illuminated	Illuminated	Remaining battery capacity is 75% to 100%

Battery charging status (when UPS is working in on-line mode)

Battery Status LED				Description
First	Second	Third	Fourth	
Flashes	Not Illuminated	Not Illuminated	Not Illuminated	Battery charge is 0% to 24%
Illuminated	Flashes	Not Illuminated	Not Illuminated	Battery charge is 25% to 49%
Illuminated	Illuminated	Flashes	Not Illuminated	Battery charge is 50% to 74%
Illuminated	Illuminated	Illuminated	Flashes	Battery charge is 75% to 99%
Illuminated	Illuminated	Illuminated	Illuminated	Battery fully charged and Back-UPS is on utility power

Voltage Sensitivity Adjustment

The Back-UPS will switch to battery power if the utility input voltage level or distortions go out of range or if the utility power is experiencing voltage fluctuations, to help protect connected equipment. In situations where either the Back-UPS or the connected equipment is too sensitive for the utility input voltage level, it is necessary to adjust the transfer voltage.

1. Turn off the Back-UPS while connected to a wall outlet.
2. Press and hold the POWER ON/OFF button for 10 seconds. The **Power On/Off** LED will alternately illuminate green and red to indicate that the Back-UPS is in Program mode.
3. The **Power On/Off** LED will flash either green, amber, or red to indicate the current sensitivity level. Refer to the table below for an explanation of the transfer voltage sensitivity levels.
4. To exit Program mode wait five seconds and all LED indicators will turn off. Program mode is no longer active.

LED Flashes	Sensitivity Setting	Input Voltage Range (Utility Power Operation)	Recommended Use
Green	LOW	160 Vac to 278Vac	Use this setting when connected equipment is less sensitive to fluctuations in voltage or waveform distortions.
Red	MEDIUM	180 Vac to 266 Vac	Factory default setting. Use this setting under normal conditions.
Amber	HIGH	196 Vac to 256 Vac	Use this setting when connected equipment is sensitive to voltage and waveform fluctuations.

Replace Battery

Replacement batteries can be ordered through our Web site, www.apc.com.

Model	Replacement battery part number
BE500G2-FR/BE500G2-GR/BE500G2-IT/BE500G2-UK	RBC46
BE650G2-FR/BE650G2-GR/BE650G2-IT/BE650G2-UK	APCRBC110
BE850G2-FR/BE850G2-GR/BE850G2-IT/BE850G2-UK	RBC17
BE1050G2-FR/BE1050G2-GR/BE1050G2-IT/BE1050G2-UK	



Deliver the used battery to a recycling facility.

Troubleshooting

Problem / Possible Cause	Corrective Action
The Back-UPS will not turn on.	
The Back-UPS has not been turned on.	Press the POWER ON/OFF button.
The Back-UPS is not connected to utility power, or there is no utility power available at the wall outlet, or the utility power is experiencing a brownout or over voltage condition.	Be sure that the power cord is securely connected to the wall outlet, and that the utility power is available at the wall outlet. Where applicable, be sure that the wall outlet is switched on.
The Back-UPS will not turn on.	
Back-UPS circuit breaker tripped.	Disconnect all non-essential equipment connected to the outlets. Reset the circuit breaker by pushing in the circuit breaker button fully inwards until it latches. If the circuit breaker resets, switch On the Back-UPS and reconnect one equipment at a time to the Back-UPS. If the circuit breaker trips again, it is likely that one of the connected devices is causing the overload.
The Back-UPS is on, the Power on/off LED flashes green/red alternatively and the unit emits a constant tone.	
The battery is disconnected.	Connect the battery. Refer to “Connect the Battery” on page 6 for details.
Connected equipment loses power.	
A Back-UPS overload condition has occurred.	Disconnect all nonessential equipment connected to the outlets. Reconnect one equipment at a time to the Back-UPS. Be sure that at least one Battery status LED is illuminating. Charge the battery for 16 hours to make sure it is fully charged. If the overload condition still occurs, replace the battery.
The Back-UPS battery is completely discharged.	Connect the Back-UPS to utility power and allow the battery to recharge for 16 hours.
PowerChute software has performed a shutdown due to a power outage.	This is a normal Back-UPS operation.
Connected equipment does not accept the step-approximated sine waveform from the Back-UPS.	The output waveform is intended for computers and peripheral devices. It is not intended for use with motor driven equipment.
The Back-UPS may require service.	Contact Schneider Electric Technical Support for more in-depth troubleshooting.
The Power On/Off LED is green and flashes twice every 2 seconds.	
The Back-UPS is operating on battery power.	The Back-UPS is operating normally on battery power. Save all open files, and shutdown the computer. When utility power is restored the battery will recharge.
The Power On/Off LED flashes green in rapid succession.	
The Back-UPS battery has approximately two minutes of remaining runtime.	The Back-UPS battery is nearing total discharge state. Save all open files, and shutdown the computer. When utility power is restored the battery will recharge.

Problem / Possible Cause	Corrective Action
The Back-UPS has an inadequate battery runtime.	
The battery is not fully charged.	Leave the Back-UPS connected to utility power for 16 hours while the battery charges to full capacity.
The battery is near the end of useful life and should be replaced.	As a battery ages, the runtime capability decreases. See APC by Schneider Electric Web site www.apc.com , to order replacement batteries.
USB charging is slow.	
Charging a device using the Back-UPS USB charger is slower than the device's original USB charger.	The connected USB cable does not support the charging speed for the device. Use appropriate USB cable.
The Back-UPS is off but the Back-UPS beeps once every 4 seconds.	
The voltage is not low enough to shutdown the Back-UPS but not high enough to start the Back-UPS and power the outlets. There is however enough voltage to charge the Back-UPS.	Mute the alarm by pressing the MUTE button. The UPS will return to normal operation once the utility input voltage has returned to normal range.

Warranty Registration

Register your product on-line at <http://warranty.apc.com>.

The standard warranty is three (3) years from the date of purchase valid in European Community. For all other regions, the standard warranty is two (2) years from the date of purchase. Schneider Electric IT (SEIT) standard procedure is to replace the original unit with a factory reconditioned unit. Customers who must have the original unit back due to the assignment of asset tags and set depreciation schedules must declare such a need at first contact with an SEIT Technical Support representative. SEIT will ship the replacement unit once the defective unit has been received by the repair department, or cross ship upon the receipt of a valid credit card number. The customer pays for shipping the unit to SEIT. SEIT pays ground freight transportation costs to ship the replacement unit to the customer.

Service

If the unit requires service, do not return it to the dealer. Follow these steps:

1. Review the Troubleshooting section of the manual to eliminate common problems.
2. If the problem persists, contact Schneider Electric IT (SEIT) Customer Support through the Web site, www.apc.com.
 - a. Note the model number and serial number and the date of purchase. The model and serial numbers are located on the rear panel of the unit and are available through the LCD display on select models.
 - b. Call SEIT Customer Support and a technician will attempt to solve the problem over the phone. If this is not possible, the technician will issue a Returned Material Authorization Number (RMA#).

If the unit is under warranty, the repairs are free.
 - c. Service procedures and returns may vary internationally. Refer to the APC by Schneider Electric Web site for country specific instructions.
3. Pack the unit in the original packaging whenever possible to avoid damage in transit. Never use foam beads for packaging. Damage sustained in transit is not covered under warranty.
4. **Always DISCONNECT THE UPS BATTERIES before shipping. The United States Department of Transportation (DOT), and the International Air Transport Association (IATA) regulations require that UPS batteries be disconnected before shipping. The internal batteries may remain in the UPS.**
5. Write the RMA# provided by Customer Support on the outside of the package.
6. Return the unit by insured, pre-paid carrier to the address provided by Customer Support

Worldwide Customer Support

For country specific customer support, go to our Web site, www.apc.com.

Schneider Electric

35 rue Joseph Monier
92500 Rueil Malmaison - France
Phone: +33 (0) 1 41 29 70 00
www.apc.com

As standards, specifications, and designs change from time to time,
please ask for confirmation of the information given in this publication.

© 2024 Schneider Electric. All Rights Reserved.

EN TME37615