

ASUS All-in-One PC

User Guide

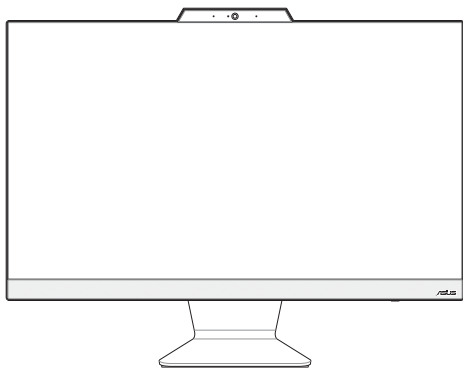

A3402/M3402/E3402/F3402 Series

HDMI™
HIGH-DEFINITION MULTIMEDIA INTERFACE

COPYRIGHT INFORMATION

No part of this manual, including the products and software described in it, may be reproduced, transmitted, transcribed, stored in a retrieval system, or translated into any language in any form or by any means, except documentation kept by the purchaser for backup purposes, without the express written permission of ASUSTeK COMPUTER INC. ("ASUS").

ASUS PROVIDES THIS MANUAL "AS IS" WITHOUT WARRANTY OF ANY KIND, EITHER EXPRESS OR IMPLIED, INCLUDING BUT NOT LIMITED TO THE IMPLIED WARRANTIES OR CONDITIONS OF MERCHANTABILITY OR FITNESS FOR A PARTICULAR PURPOSE. IN NO EVENT SHALL ASUS, ITS DIRECTORS, OFFICERS, EMPLOYEES OR AGENTS BE LIABLE FOR ANY INDIRECT, SPECIAL, INCIDENTAL, OR CONSEQUENTIAL DAMAGES (INCLUDING DAMAGES FOR LOSS OF PROFITS, LOSS OF BUSINESS, LOSS OF USE OR DATA, INTERRUPTION OF BUSINESS AND THE LIKE), EVEN IF ASUS HAS BEEN ADVISED OF THE POSSIBILITY OF SUCH DAMAGES ARISING FROM ANY DEFECT OR ERROR IN THIS MANUAL OR PRODUCT.

Products and corporate names appearing in this manual may or may not be registered trademarks or copyrights of their respective companies, and are used only for identification or explanation and to the owners' benefit, without intent to infringe.

SPECIFICATIONS AND INFORMATION CONTAINED IN THIS MANUAL ARE FURNISHED FOR INFORMATIONAL USE ONLY, AND ARE SUBJECT TO CHANGE AT ANY TIME WITHOUT NOTICE, AND SHOULD NOT BE CONSTRUED AS A COMMITMENT BY ASUS. ASUS ASSUMES NO RESPONSIBILITY OR LIABILITY FOR ANY ERRORS OR INACCURACIES THAT MAY APPEAR IN THIS MANUAL, INCLUDING THE PRODUCTS AND SOFTWARE DESCRIBED IN IT.

Copyright © 2022 ASUSTeK COMPUTER INC. All Rights Reserved.

LIMITATION OF LIABILITY

Circumstances may arise where because of a default on ASUS' part or other liability, you are entitled to recover damages from ASUS. In each such instance, regardless of the basis on which you are entitled to claim damages from ASUS, ASUS is liable for no more than damages for bodily injury (including death) and damage to real property and tangible personal property; or any other actual and direct damages resulted from omission or failure of performing legal duties under this Warranty Statement, up to the listed contract price of each product.

ASUS will only be responsible for or indemnify you for loss, damages or claims based in contract, tort or infringement under this Warranty Statement.

This limit also applies to ASUS' suppliers and its reseller. It is the maximum for which ASUS, its suppliers, and your reseller are collectively responsible.

UNDER NO CIRCUMSTANCES IS ASUS LIABLE FOR ANY OF THE FOLLOWING: (1) THIRD-PARTY CLAIMS AGAINST YOU FOR DAMAGES; (2) LOSS OF, OR DAMAGE TO, YOUR RECORDS OR DATA; OR (3) SPECIAL, INCIDENTAL, OR INDIRECT DAMAGES OR FOR ANY ECONOMIC CONSEQUENTIAL DAMAGES (INCLUDING LOST PROFITS OR SAVINGS), EVEN IF ASUS, ITS SUPPLIERS OR YOUR RESELLER IS INFORMED OF THEIR POSSIBILITY.

SERVICE AND SUPPORT

Visit our multi-language web site at <https://www.asus.com/support>

Contents

About this manual.....	6
Conventions used in this manual	7
Typography.....	7
Icons	8
Safety information.....	9
Setting up your system.....	9
Care during use	10
Sound Pressure Warning.....	11
Adapter.....	11
DC Fan Warning.....	11
Package contents	12

Chapter 1: Hardware Setup

ASUS All-in-One PC	13
Front view.....	13
Bottom view	15
Rear view	17

Chapter 2: Using your ASUS All-in-One PC

Positioning your ASUS All-in-One PC	21
Setting up your ASUS All-in-One PC.....	22
Connecting the wireless keyboard and mouse	22
Connecting a wired keyboard and mouse	24
Powering on the system.....	25
Using the touch screen (on selected models only)	27
Gestures for the touch screen panel.....	28
Using touch screen panel gestures.....	28
Using the keyboard.....	30
Function keys	30

Chapter 3: Working with Windows

Starting for the first time.....	33
Start menu	34
Launching the Start menu	35
Opening programs from the Start menu.....	35
Windows apps	36
Launching Windows apps from the Start menu.....	36
MyASUS Splendid.....	37
Connecting to wireless networks	39
Wi-Fi.....	39
Bluetooth.....	40
Connecting to wired networks	41
Turning your ASUS All-in-One PC off.....	42
Putting your ASUS All-in-One PC to sleep	43

Chapter 4: Recovering your system

Entering the BIOS Setup.....	45
Quickly enter the BIOS.....	45
Recovering your system.....	46
Performing a recovery option.....	47

Appendices

Notices.....	49
Federal Communication Commission Interference Statement	49
RF exposure warning.....	50
Compliance Statement of Innovation, Science and Economic Development Canada (ISED)	51
Déclaration de conformité de Innovation, Sciences et Développement économique Canada (ISED)	51
Radio Frequency (RF) Exposure Information	52
Coating Notice	52
Prevention of Hearing Loss	52
Declaration of Compliance for Product Environmental Regulation.....	54
EU REACH and Article 33.....	54
EU RoHS.....	55
Japan JIS-C-0950 Material Declarations	55
India RoHS.....	55
ASUS Recycling/Takeback Services	55
Ecodesign Directive	55
ENERGY STAR Qualified Product	56
EPEAT Registered Products	56
Simplified EU Declaration of Conformity	57
Simplified UKCA Declaration of Conformity.....	58

About this manual

This manual provides information about the hardware and software features of your ASUS All-in-One PC, organized through the following chapters:

Chapter 1: Hardware Setup

This chapter details the hardware components of your ASUS All-in-One PC.

Chapter 2: Using your ASUS All-in-One PC

This chapter provides you with information on using your ASUS All-in-One PC.

Chapter 3: Working with Windows

This chapter provides an overview of using Windows in your ASUS All-in-One PC.

Chapter 4: Recovering your system

This chapter provides recovery options for your ASUS All-in-One PC.

Appendices

This section includes notices and safety statements for your ASUS All-in-One PC.

Conventions used in this manual

To highlight key information in this manual, some texts are presented as follows:

IMPORTANT! This message contains vital information that must be followed to complete a task.

NOTE: This message contains additional information and tips that can help complete tasks.

WARNING! This message contains important information that must be followed to keep you safe while performing tasks and prevent damage to your device's data and components.

Typography

Bold = This indicates a menu or an item that must be selected.

Italic = This indicates sections that you can refer to in this manual.

Icons

The icons below indicate the devices you can use for completing a series of tasks or procedures on your ASUS All-in-One PC.



= Use the touch screen panel (on selected models).



= (optional) Use the wired/wireless mouse.



= (optional) Use the wired/wireless keyboard.

All illustrations and screenshots in this manual are for reference only. Actual product specifications and software screen images may vary with territories. Visit the ASUS website at www.asus.com for the latest information.

Safety information

Your All-in-One ASUS All-in-One PC is designed and tested to meet the latest standards of safety for information technology equipment. However, to ensure your safety, it is important that you read the following safety instructions.

Setting up your system

- Read and follow all instructions in the documentation before you operate your system.
- Do not use this product near water or a heated source such as a radiator.
- Be cautious while moving the system to prevent injuries.
- Set up the system on a stable surface.
- Openings on the chassis are for ventilation. Do not block or cover these openings. Ensure that you leave plenty of space around the system for ventilation. Never insert objects of any kind into the ventilation openings.
- Use this product in environments with ambient temperatures between 0°C and 40°C.
- If you use an extension cord, ensure that the total ampere rating of the devices plugged into the extension cord does not exceed its ampere rating.

Care during use

- Do not walk on the power cord or allow anything to rest on it.
- Do not spill water or any other liquids on your system.
- When the system is turned off, a small amount of electrical current still remains in the product. Always unplug all power, modem, and network cables from the power outlets before cleaning the system.
- The touch screen requires periodic cleaning to perform at optimal touch sensitivity. Keep the screen clean from foreign objects or excessive dust accumulation. To clean the screen:
 - Turn off the system and disconnect the power cord from the wall.
 - Spray a small amount of household glass cleaner on the supplied cleaning cloth and gently wipe the surface of the screen.
 - Do not spray the cleaner directly on the screen.
- Do not use an abrasive cleaner or a coarse cloth when cleaning the screen.
- If you encounter the following technical problems with the product, unplug the power cord and contact a qualified service technician or your retailer.
 - The power cord or plug is damaged.
 - Liquid has been spilled into the system.
 - The system does not function properly even if you follow the operating instructions.
 - The system was dropped or the cabinet is damaged.
 - The system performance changes.

Sound Pressure Warning

Excessive sound pressure from earphones or headphones can cause hearing loss or permanent damage to hearing. Increasing the volume and equalizer beyond default levels increases the output voltage and sound pressure produced by the earphones or headphones.

Adapter

1. Adapter specifications:

Input voltage: 100–240Vac

Rating output: 19Vdc, 4.74A

2. It is recommended that the power socket is in close proximity to the ASUS All-in-One PC.

DC Fan Warning

Please note that the DC fan is a moving part and can cause harm when used improperly. Keep away from the fan when using the product.

Package contents



ASUS All-in-One PC

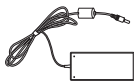

AC adapter



Power cord



Warranty card



Keyboard (optional)



Mouse (optional)



Quick Start Guide



KBM USB receiver
dongle (optional)

NOTE:

- If any of the items is damaged or missing, contact your retailer.
 - The ASUS All-in-One PC illustration is for reference only. Actual product specifications may vary with models.
 - The keyboard, mouse, and power supply illustrations are for reference only. Actual product specifications may vary with territories.
-

Chapter 1: Hardware Setup

ASUS All-in-One PC

Front view

NOTE: The illustrations in this section are for reference only. The appearance of your ASUS All-in-One PC may vary depending on model.

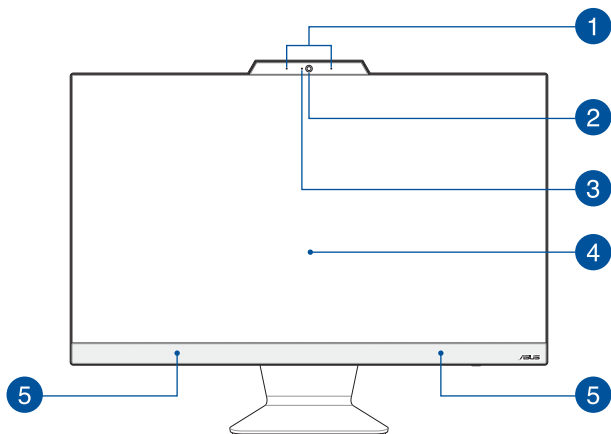

1 Array microphones

The array microphones feature echo canceling, noise suppression, and beam forming functions for better voice recognition and audio recording.

2 Camera

The built-in camera allows you to take pictures or record videos using your ASUS All-in-One PC.

3 Camera indicator

The camera indicator lights up when the built-in camera is in use.

4 LCD display panel

The LCD display panel provides excellent viewing features for photos, videos, and other multimedia files.

On selected models, multi-touch is supported. You can operate your ASUS All-in-One PC using touch gestures.

5 Audio speakers

The built-in audio speaker allows you to hear audio straight from the ASUS All-in-One PC. Audio features are software-controlled.

Bottom view

NOTE: The illustrations in this section are for reference only. The appearance of your ASUS All-in-One PC may vary depending on model.

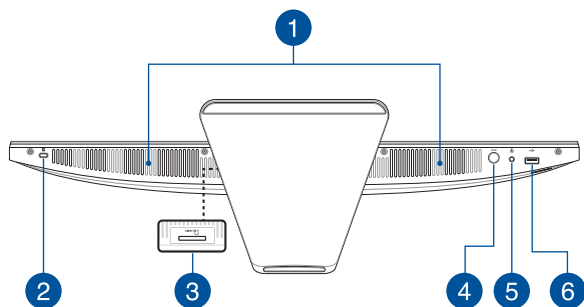

- 1 Audio speakers**

The built-in audio speaker allows you to hear audio straight from the ASUS All-in-One PC. Audio features are software-controlled.
- 2 Kensington® security slot**

The Kensington® security slot allows you to secure your ASUS All-in-One PC using Kensington® compatible security products.
- 3 Memory card reader (on selected models)**

This ASUS All-in-One PC has a built-in memory card reader slot that supports MMC and SD cards.
- 4 Mode button**

Touch to switch the display signal source. When switched to HDMI-in, the ASUS All-in-One PC can be used as a standard desktop LCD monitor. Press and hold then use the mode button to adjust the brightness in HDMI Input mode.
- 5 Headphone/Headset/Microphone jack**

This port allows you to connect amplified speakers or headphones. You can also use this port to connect your headset or an external microphone.
- 6 USB 2.0 port**

This USB (Universal Serial Bus) port is compatible with USB 2.0 or USB 1.1 devices such as keyboards, pointing devices, flash disk drives, external HDDs, speakers, cameras and printers.

Rear view

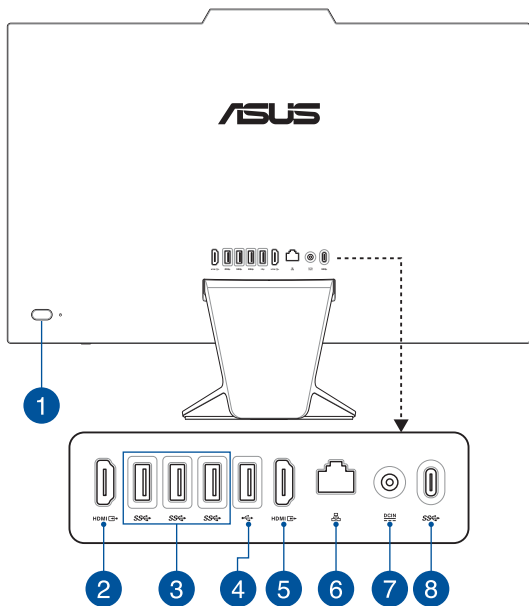

- 1 Power button**
Press this button to turn on your ASUS All-in-One PC.
- 2 HDMI input port**
This port allows you to use your ASUS All-in-One PC as an external display.
- 3 USB 3.2 Gen 1 port**
This USB 3.2 Gen 1 (Universal Serial Bus) port provides a transfer rate of up to 5 Gbit/s.
- 4 USB 2.0 port**
This USB (Universal Serial Bus) port is compatible with USB 2.0 or USB 1.1 devices such as keyboards, pointing devices, flash disk drives, external HDDs, speakers, cameras and printers.
- 5 HDMI output port**
This port allows you to connect your ASUS All-in-One PC to another HDMI-compatible device for file sharing or extending your display monitor.

6

LAN port

This 8-pin RJ-45 LAN port supports a standard Ethernet cable for connection to a local network.

7

Power input

The bundled power adapter converts AC power to DC power for use with this jack. Power supplied through this jack supplies power to the ASUS All-in-One PC. To prevent damage to the ASUS All-in-One PC, always use the bundled power adapter.

WARNING! The power adapter may become warm or hot when in use. Do not cover the adapter and keep it away from your body.

8

USB 3.2 Gen 1 Type-C® port

The USB 3.2 (Universal Serial Bus 3.2) Gen 1 Type-C® port provides a transfer rate of up to 5 Gbit/s.

Chapter 2:

Using your ASUS All-in-One PC

Positioning your ASUS All-in-One PC

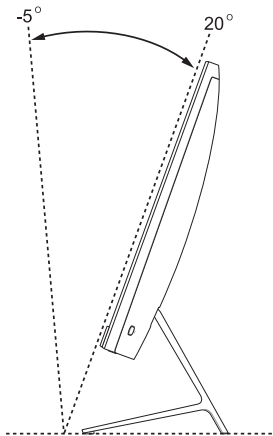

1. Place your ASUS All-in-One PC on a flat surface such as a table or desk.
2. Tilt the display to an angle between -5° to 20° .

IMPORTANT!

- Use both hands when setting up your ASUS All-in-One PC.
 - Avoid adjusting the display to an angle beyond the recommended values or you may risk damaging the ASUS All-in-One PC.
-

Setting up your ASUS All-in-One PC

NOTE: The illustrations in this section are for reference only. The appearance of your ASUS All-in-One PC may vary depending on model.

Connecting the wireless keyboard and mouse

1. Install batteries into the wireless keyboard and mouse.

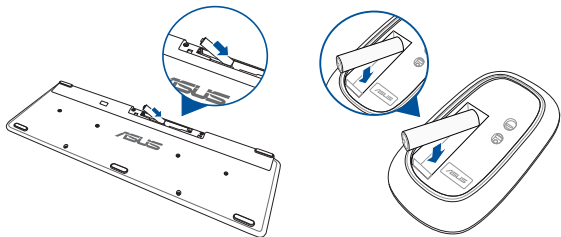

2. Connect the wireless dongle for keyboard and mouse to a USB port to automatically pair both devices to your ASUS All-in-One PC.

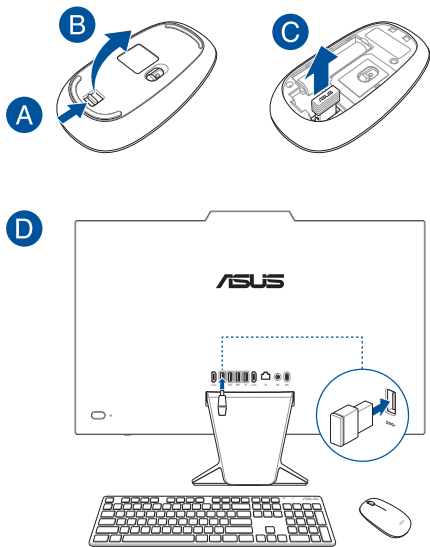

3. You can begin using the wireless keyboard and mouse.

NOTE: Reconnect the wireless keyboard and mouse with the wireless dongle if they lose connection. Avoid using either devices alongside other wireless devices. Position the mouse and keyboard at least 20 cm away from other wireless hardware to avoid interference.

Connecting a wired keyboard and mouse

Connect the keyboard and the mouse to the USB ports on the rear panel.

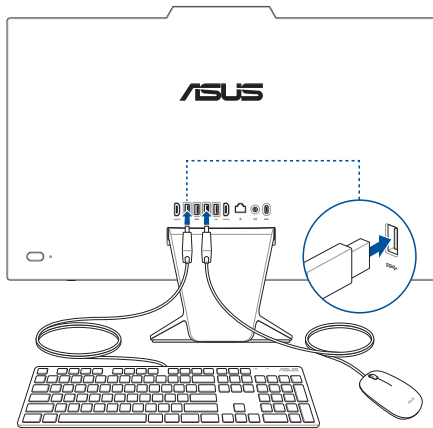

NOTE: The illustrations above are for reference only. Actual hardware and specifications of the optional wired or wireless keyboard and mouse may vary.

Powering on the system

- A. Connect the DC power connector into your ASUS All-in-One PC's power (DC) input.
- B. Connect the AC power cord to the AC/DC adapter.
- C. Plug the AC power adapter into a 100V~240V power source.

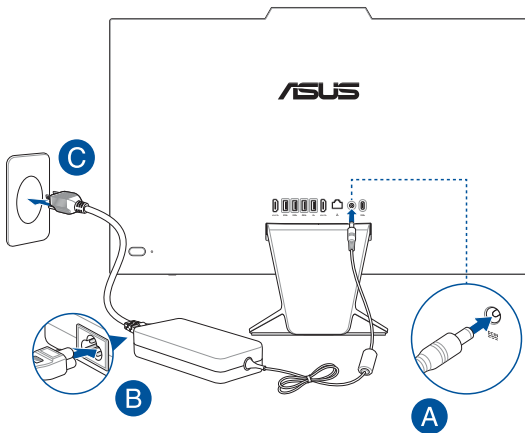

- D. Press the power button.

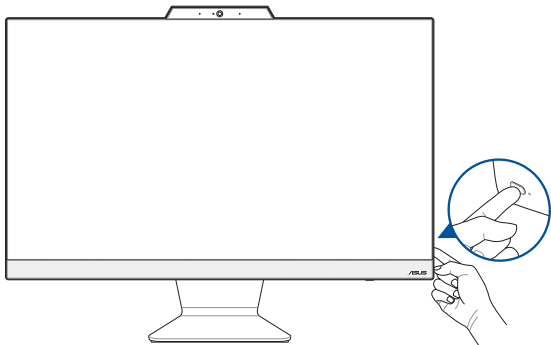

NOTE: For details on turning off your ASUS All-in-One PC, refer to the section *Turning your ASUS All-in-One PC off in Working with Windows*.

Using the touch screen (on selected models only)

The touch screen panel of your ASUS All-in-One PC provides excellent viewing features for photos, videos, and other multimedia files on your ASUS All-in-One PC. It also supports the 10-point multi-touch feature that facilitates smoother and more accurate touch gestures allowing you to operate your ASUS All-in-One PC faster and easier.

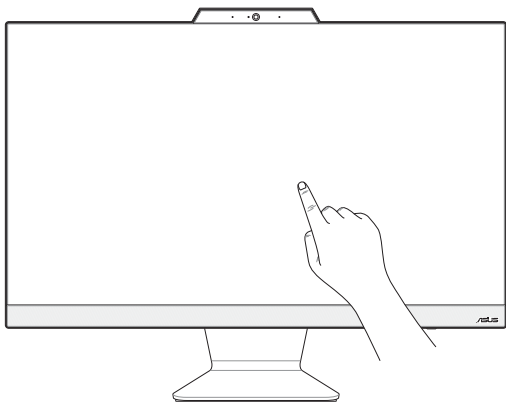

IMPORTANT! Do not use sharp objects such as scissors or ballpoint pens on the touch screen to prevent dents and scratches which may cause the touchscreen to become unresponsive.

NOTE: The illustration above is for reference only. The appearance of your ASUS All-in-One PC may vary depending on model.

Gestures for the touch screen panel

Gestures allow you to launch programs and access the settings of your ASUS All-in-One PC. Refer to the following illustrations when using hand gestures on your touch screen panel.

NOTE: The following screenshots are for reference only. The touch screen panel's appearance may vary depending on model.

Using touch screen panel gestures

The gestures allow you to launch programs and access the settings of your ASUS All-in-One PC. The functions can be activated by using the hand gestures on your ASUS All-in-One PC's touch screen panel.

Tap/Double-tap

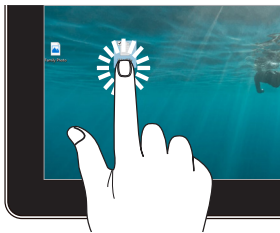

- Tap an app to select it.
- Double-tap an app to launch it.

Press and hold



Press and hold to open the right-click menu.

Zoom in



Spread apart your two fingers on the touch screen panel.

Zoom out

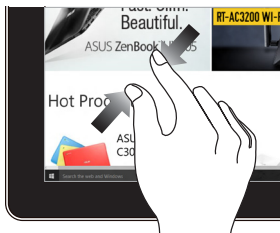

Bring together your two fingers on the touch screen panel.

Finger slide



Slide your finger to scroll up and down and slide your finger to pan the screen left or right.

Drag

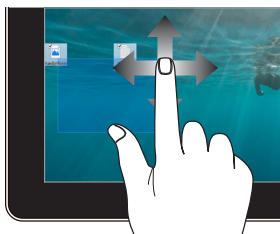





- Drag to create a selection box around multiple items.
- Drag and drop an item to move it to a new location.



Using the keyboard



Function keys



The function keys on the keyboard can trigger the following commands:

 +  Turns the speaker on or off

 +  Turns the speaker volume down

 +  Turns the speaker volume up



 +  Decreases display brightness

 +  Increases display brightness



 +  Toggles the display mode



NOTE: Ensure that the second display is connected to your ASUS All-in-One PC.

 +  Activates the Lock screen

 +  Skips to previous track or rewind

 +  Play or pause

 +  Skips to next track or fast forward

 +  Activates screen capture tool

Other key combination



Turns the microphone on or off



Toggles ASUS AI Noise-Canceling for built-in or external audio speakers



Microphone

Toggles between single presenter conference call mode or multi presenter conference call mode.

Mode	Description
Single presenter conference call	Reduces background noise
Multi presenter conference call	Reduces background noise for larger area

Chapter 3:

Working with Windows

Starting for the first time

When you start your ASUS All-in-One PC for the first time, a series of screens appear to guide you in configuring your Windows operating system. Follow the onscreen instructions to configure the following basic items:

- Personalize
- Get online
- Settings
- Your account

After configuring the basic items, Windows proceeds to install your apps and preferred settings. Ensure that your ASUS All-in-One PC is kept powered on during the setup process. Once the setup process is complete, the Desktop appears.

NOTE: The screenshots in this chapter are for reference only.

Start menu

The Start menu is the main gateway to your ASUS All-in-One PC's programs, Windows apps, folders, and settings. You can use the Start menu to do these common activities:

- Start programs or Windows apps
- Open commonly used programs or Windows apps
- Adjust ASUS All-in-One PC settings
- Get help with the Windows operating system
- Turn off your ASUS All-in-One PC
- Log off from Windows or switch to a different user account

Launching the Start menu



Tap the Start icon on your desktop.



Position your mouse pointer over the Start icon on your desktop then click it.



Press the Windows logo key on your keyboard.

Opening programs from the Start menu

One of the most common uses of the Start menu is opening programs installed on your ASUS All-in-One PC.



Tap the program to launch it.



Position your mouse pointer over the program then click to launch it.



Use the arrow keys to browse through the programs.

Press  to launch it.

Windows apps

NOTE: Some Windows apps require signing in to your Microsoft account before they are fully launched.

Launching Windows apps from the Start menu



Tap the app to launch it.



Position your mouse pointer over the app then click to launch it.



Use the arrow keys to browse through the apps. Press



to launch an app.

MyASUS Splendid

MyASUS Splendid ensures that all ASUS display panels show identical and accurate colors. You may select Vivid, Eye Care, or Manual Mode beside Normal Mode to adjust the display settings.

- **Normal Mode:** Through Gamma and Color temperature correction, the image output from the panel is as close as possible as what your eye can naturally see. For model with OLED panel, this mode is compliant with TÜV Low Blue Light Certification.
- **Vivid Mode:** This mode allows you to adjust the saturation of the image, making it more vivid and vibrant.
- **Manual Mode:** This mode allows you to adjust the color temperature value to your personal needs, ranging from -50 to +50.
- **Eye Care Mode:** This mode reduces blue light emission by up to 30%, helping to protect your eyes.

Level 1-5: The higher the level, the more blue light emission is reduced. For model with LCD panel, Level 5 is the optimized setting, and is compliant with TÜV Low Blue Light Certification.

NOTE: Enable **HDR** from **Settings > System > Display** for a better viewing experience with your OLED panel (on selected models), and is compliant with TÜV Flicker Free Certification.

Please refer to the following tips to alleviate eye strain:

- Take some time away from the display if working for long hours. It is advised to take short breaks (at least 5 minutes) after around 1 hour of continuous working at the computer. Taking short and frequent breaks is more effective than a long break.
- To minimize eye strain and eye dryness, rest your eyes periodically by focusing on objects that are far away.
- Repeat the following exercises to reduce eye strain:
 - (1) Look up and down repeatedly
 - (2) Slowly roll your eyes
 - (3) Move your eyes diagonally

If eye strain persists, please consult a physician.

- High energy blue light may lead to eye strain and AMD (Age-Related Macular Degeneration). Blue light Filter reduces 30% (max.) harmful blue light to avoid CVS (Computer Vision Syndrome).

Connecting to wireless networks

Wi-Fi

Access emails, surf the Internet, and share applications via social networking sites using your ASUS All-in-One PC's Wi-Fi connection.

Connecting Wi-Fi

Connect your ASUS All-in-One PC to a Wi-Fi network by using the following steps:



or



1. Click/Tap the **Wi-Fi** icon from the taskbar to enable Wi-Fi.
2. Select an access point from the list of available Wi-Fi connections.
3. Select **Connect** to start the network connection.

NOTE: You may be prompted to enter a security key to activate the Wi-Fi connection.

Bluetooth

Use Bluetooth to facilitate wireless data transfers with other Bluetooth-enabled devices.

Pairing with other Bluetooth-enabled devices

You need to pair your ASUS All-in-One PC with other Bluetooth-enabled devices to enable data transfers. Connect your devices by using the following steps:



or



1. Launch **Settings** from the Start menu.
2. Select **Devices > Bluetooth** to search for Bluetooth-enabled devices. *(for Windows 10)*
Select **Bluetooth & devices > Add device** to search for Bluetooth-enabled devices. *(for Windows 11)*
3. Select a device from the list to pair your ASUS All-in-One PC with the device.

NOTE: For some Bluetooth-enabled devices, you may be prompted to key in the passcode of your ASUS All-in-One PC.

Connecting to wired networks

You can also connect to wired networks, such as local area networks and broadband Internet connection, using your ASUS All-in-One PC's LAN port.

NOTE: Contact your Internet Service Provider (ISP) for details or your network administrator for assistance in setting up your Internet connection.



Turning your ASUS All-in-One PC off

You can turn off your ASUS All-in-One PC by doing either of the following procedures:



or



- Launch the Start menu, select the power icon then select **Shut down** to do a normal shutdown.
- From the log-in screen, select the power icon then select **Shut down**.
- Press  +  to launch Shut Down Windows. Select **Shut down** from the drop-down list then select **OK**.
- If your ASUS All-in-One PC is unresponsive, press and hold the power button for at least four (4) seconds until your ASUS All-in-One PC turns off.

Putting your ASUS All-in-One PC to sleep

To put your ASUS All-in-One PC to Sleep mode:



or



- Launch the Start menu, select the power icon then select **Sleep** to put your ASUS All-in-One PC to sleep.
- From the log-in screen, select the power icon then select **Sleep**.



Press + to launch Shut Down Windows.

Select **Sleep** from the drop-down list then select **OK**.

NOTE: You can also put your ASUS All-in-One PC to Sleep mode by pressing the power button once.

Chapter 4:

Recovering your system

Entering the BIOS Setup

BIOS (Basic Input and Output System) stores system hardware settings that are needed for system startup in the ASUS All-in-One PC.

In normal circumstances, the default BIOS settings apply to most conditions to ensure optimal performance. Do not change the default BIOS settings except in the following circumstances:

- An error message appears on the screen during the system bootup and requests you to run the BIOS Setup.
- You have installed a new system component that requires further BIOS settings or update.

WARNING! Inappropriate BIOS settings may result to instability or boot failure. We strongly recommend that you change the BIOS settings only with the help of a trained service personnel.

Quickly enter the BIOS

To access the BIOS:

- When your ASUS All-in-One PC is off, press the power button for at least four (4) seconds to access the BIOS directly.
- Press the power button to turn on your ASUS All-in-One PC then press <F2> or during POST.

NOTE: POST (Power-On Self-Test) is a series of software controlled diagnostic tests that run when you turn on your ASUS All-in-One PC.

Recovering your system

Using recovery options on your ASUS All-in-One PC allows you to restore the system to its original state or simply refresh its settings to help improve performance.

IMPORTANT!

- Backup all your data files before doing any recovery option on your ASUS All-in-One PC.
 - Note down important customized settings such as network settings, user names, and passwords to avoid data loss.
 - Ensure that your ASUS All-in-One PC is plugged in to a power source before resetting your system.
-

Windows allows you to do any of the following recovery options:

- **Keep my files** - This option allows you to refresh your ASUS All-in-One PC without affecting personal files (photos, music, videos, documents).

Using this option, you can restore your ASUS All-in-One PC to its default settings and delete other installed apps.

- **Remove everything** - This option resets your ASUS All-in-One PC to its factory settings. You must backup your data before doing this option.

- **Advanced startup** - Using this option allows you to perform other advanced recovery options on your ASUS All-in-One PC such as:
 - Using a USB drive, network connection or Windows recovery DVD to startup your ASUS All-in-One PC.
 - Using **Troubleshoot** to enable any of these advanced recovery options: Startup Repair, Uninstall Updates, Startup Settings, UEFI Firmware Settings, Command Prompt, System Restore, and System Image Recovery.

Performing a recovery option

Refer to the following steps if you want to access and use any of the available recovery options for your ASUS All-in-One PC.

1. Launch **Settings** > **Update and security**. *(for Windows 10)*
Launch **Settings** > **System** > **Recovery**. *(for Windows 11)*
2. Select the recovery option you would like to perform.

Appendices

Notices

Federal Communication Commission Interference Statement

This equipment has been tested and found to comply with the limits for a Class B digital device, pursuant to Part 15 of the FCC Rules. These limits are designed to provide reasonable protection against harmful interference in a residential installation. This equipment generates, uses and can radiate radio frequency energy and, if not installed and used in accordance with the instructions, may cause harmful interference to radio communications. However, there is no guarantee that interference will not occur in a particular installation. If this equipment does cause harmful interference to radio or television reception, which can be determined by turning the equipment off and on, the user is encouraged to try to correct the interference by one or more of the following measures:

- Reorient or relocate the receiving antenna.
- Increase the separation between the equipment and receiver.
- Connect the equipment into an outlet on a circuit different from that to which the receiver is connected.
- Consult the dealer or an experienced radio/TV technician for help.

FCC Caution: Any changes or modifications not expressly approved by the party responsible for compliance could void the user's authority to operate this equipment.

This device complies with Part 15 of the FCC Rules. Operation is subject to the following two conditions: (1) This device may not cause harmful interference, and (2) this device must accept any interference received, including interference that may cause undesired operation.

This device is restricted to indoor use when operated in the 5.15 to 5.25 GHz frequency range.

RF exposure warning

This equipment must be installed and operated in accordance with provided instructions and the antenna(s) used for this transmitter must be installed to provide a separation distance of at least 20 cm from all persons and must not be co-located or operating in conjunction with any other antenna or transmitter. End-users and installers must be provided with antenna installation instructions and transmitter operating conditions for satisfying RF exposure compliance.

IMPORTANT! Outdoor operations in the 5.15~5.25 GHz band is prohibited. This device has no Ad-hoc capability for 5250~5350 and 5470~5725 MHz.

CAUTION: Any changes or modifications not expressly approved by the guarantee of this device could void the user's authority to operate the equipment.

Compliance Statement of Innovation, Science and Economic Development Canada (ISED)

This device complies with Innovation, Science and Economic Development Canada licence exempt RSS standard(s). Operation is subject to the following two conditions: (1) this device may not cause interference, and (2) this device must accept any interference, including interference that may cause undesired operation of the device.

Operation in the band 5150–5250 MHz is only for indoor use to reduce the potential for harmful interference to co-channel mobile satellite systems.

CAN ICES-003(B)/NMB-003(B)

Déclaration de conformité de Innovation, Sciences et Développement économique Canada (ISED)

Le présent appareil est conforme aux CNR d'Innovation, Sciences et Développement économique Canada applicables aux appareils radio exempts de licence. L'exploitation est autorisée aux deux conditions suivantes : (1) l'appareil ne doit pas produire de brouillage, et (2) l'utilisateur de l'appareil doit accepter tout brouillage radioélectrique subi, même si le brouillage est susceptible d'en compromettre le fonctionnement.

La bande 5150–5250 MHz est réservée uniquement pour une utilisation à l'intérieur afin de réduire les risques de brouillage préjudiciable aux systèmes de satellites mobiles utilisant les mêmes canaux.

CAN ICES-003(B)/NMB-003(B)

電波法により 5GHz 帯は屋内使用に限ります。

Radio Frequency (RF) Exposure Information

The radiated output power of the wireless device is below the Industry Canada (IC) radio frequency exposure limits. The wireless device should be used in such a manner such that the potential for human contact during normal operation is minimized.

This device has also been evaluated and shown compliant with the IC RF Exposure limits under mobile exposure conditions (antennas are greater than 20cm from a person's body).

Coating Notice

IMPORTANT! To provide electrical insulation and maintain electrical safety, a coating is applied to insulate the device except on the areas where the I/O ports are located.

Prevention of Hearing Loss

To prevent possible hearing damage, do not listen at high volume levels for long periods.



A pleine puissance, l'écoute prolongée du baladeur peut endommager l'oreille de l'utilisateur.

- By means of a power cord connected to a socket-outlet with earthing connection.
- Disposal of a battery into fire or a hot oven, or mechanically crushing or cutting of a battery, that can result in an explosion;
- Leaving a battery in an extremely high temperature surrounding environment that can result in an explosion or the leakage of flammable liquid or gas;
- A battery subjected to extremely low air pressure that may result in an explosion or the leakage of flammable liquid or gas.

NO DISASSEMBLY

The warranty does not apply to the products that have been disassembled by users

Lithium-Ion Battery Warning

CAUTION: Danger of explosion if battery is incorrectly replaced. Replace only with the same or equivalent type recommended by the manufacturer. Dispose of used batteries according to the manufacturer's instructions.

No Exposure to Liquids

DO NOT expose to or use near liquids, rain, or moisture.
This product is not waterproof or oil-proof.



This symbol of the crossed out wheeled bin indicates that the product (electrical, electronic equipment, and mercury-containing button cell battery) should not be placed in municipal waste. Check local regulations for disposal of electronic products.



DO NOT throw the battery in municipal waste. The symbol of the crossed out wheeled bin indicates that the battery should not be placed in municipal waste.

Declaration of Compliance for Product Environmental Regulation

ASUS follows the green design concept to design and manufacture our products, and makes sure that each stage of the product life cycle of ASUS product is in line with global environmental regulations. In addition, ASUS disclose the relevant information based on regulation requirements.

Please refer to <http://csr.asus.com/Compliance.htm> for information disclosure based on regulation requirements ASUS is complied with.

EU REACH and Article 33

Complying with the REACH (Registration, Evaluation, Authorization, and Restriction of Chemicals) regulatory framework, we publish the chemical substances in our products at ASUS REACH website at <http://csr.asus.com/english/REACH.htm>.

EU RoHS

This product complies with the EU RoHS Directive. For more details, see <http://csr.asus.com/english/article.aspx?id=35>.

Japan JIS-C-0950 Material Declarations

Information on Japan RoHS (JIS-C-0950) chemical disclosures is available on <http://csr.asus.com/english/article.aspx?id=19>.

India RoHS

This product complies with the "India E-Waste (Management) Rules, 2016" and prohibits use of lead, mercury, hexavalent chromium, polybrominated biphenyls (PBBs) and polybrominated diphenyl ethers (PBDEs) in concentrations exceeding 0.1% by weight in homogenous materials and 0.01% by weight in homogenous materials for cadmium, except for the exemptions listed in Schedule II of the Rule.

ASUS Recycling/Takeback Services

ASUS recycling and takeback programs come from our commitment to the highest standards for protecting our environment. We believe in providing solutions for you to be able to responsibly recycle our products, batteries, other components as well as the packaging materials. Please go to <http://csr.asus.com/english/Takeback.htm> for detailed recycling information in different regions.

Ecodesign Directive

European Union announced a framework for the setting of ecodesign requirements for energy-related products (2009/125/EC). Specific Implementing Measures are aimed at improving environmental performance of specific products or across multiple product types. ASUS provides product information on the CSR website. Further information could be found at <https://csr.asus.com/english/article.aspx?id=1555>.

ENERGY STAR Qualified Product



ENERGY STAR is a joint program of the U.S. Environmental Protection Agency and the U.S. Department of Energy helping us all save money and protect the environment through energy efficient products and practices.

All ASUS products with the ENERGY STAR logo comply with the ENERGY STAR standard, and the power management feature is enabled by default. The monitor is automatically set to sleep within 10 minutes of user inactivity; the computer is automatically set to sleep within 30 minutes of user inactivity. To wake your computer, click the mouse, press any key on the keyboard, or press the power button.

Please visit <http://www.energystar.gov/powermanagement> for detail information on power management and its benefits to the environment. In addition, please visit <http://www.energystar.gov> for detail information on the ENERGY STAR joint program.

NOTE: Energy Star is NOT supported on FreeDOS and Linux-based operating systems.

EPEAT Registered Products

The public disclosure of key environmental information for ASUS EPEAT (Electronic Product Environmental Assessment Tool) registered products is available at <https://csr.asus.com/english/article.aspx?id=41>. More information about EPEAT program and purchase guidance can be found at www.epeat.net.

Simplified EU Declaration of Conformity

ASUSTek Computer Inc. hereby declares that this device is in compliance with the essential requirements and other relevant provisions of Directive 2014/53/EU. Full text of EU declaration of conformity is available at <https://www.asus.com/support/>.

The WiFi operating in the band 5150-5350 MHz shall be restricted to indoor use for countries listed in the table below:

AT	BE	BG	CZ	DK	EE	FR
DE	IS	IE	IT	EL	ES	CY
LV	LI	LT	LU	HU	MT	NL
NO	PL	PT	RO	SI	SK	TR
FI	SE	CH	HR	UK(NI)		



Simplified UKCA Declaration of Conformity

ASUSTek Computer Inc. hereby declares that this device is in compliance with the essential requirements and other relevant provisions of The Radio Equipment Regulations 2017 (S.I. 2017/1206). Full text of UKCA declaration of conformity is available at

<https://www.asus.com/support/>.

The WiFi operating in the band 5150-5350 MHz shall be restricted to indoor use for the country listed below:

UK

FCC COMPLIANCE INFORMATION

Per FCC Part 2 Section 2.1077



Responsible Party: Asus Computer International
Address: 48720 Kato Rd., Fremont, CA 94538
Phone/Fax No: (510)739-3777/(510)608-4555

hereby declares that the product

Product Name : ASUS All-in-One PC
Model Number : A3402WBA, E3402WBA, A3402WB, E3402WB

compliance statement:

This device complies with part 15 of the FCC Rules. Operation is subject to the following two conditions: (1) This device may not cause harmful interference, and (2) this device must accept any interference received, including interference that may cause undesired operation.

Ver. 180620

Manufacturer	ASUSTek COMPUTER INC.
Address	1F., No. 15, Lide Rd., Beitou Dist., Taipei City 112, Taiwan
Authorized Representative in Europe	ASUS COMPUTER GmbH
Address	Harkortstrasse 21-23, 40880 Ratingen, Germany