

USER MANUAL

ProLite

LCD Monitor

ENGLISH

ProLite TF3239AS
ProLite TF4339AS
ProLite TF5039AS
ProLite TF5539AS
ProLite TF6539AS

Thank you very much for choosing the iiyama LCD monitor for signage. We recommend that you take a few minutes to read this comprehensive manual carefully before installing and switching on the monitor. Please keep this manual in a safe place for your future reference.



Dear user, we congratulate you on the purchase of your iiyama LCD.

For details on warranty and locally used pixel policies that apply directly after installation of your product please check the iiyama website.

To report a fault, please contact your local support centre found at <https://iiyama.com>

Things to check before you call the iiyama information line

- | if the power cable is connected securely and turned on?
- | if the display has been turned on?
- | if the signal cable is connected securely and the correct input selected?
- | if the computer has been restarted with the display connected?
- | if the graphics card is correctly installed with the latest drivers possible?
- | if the correct native resolution has been selected via 'Display Properties'?
- | If the R/G/B signal configuration is correct?
- | if the displays On Screen Menu is shown?
- | if the correct brightness and contrast settings have been set?
- | if given display tolerances and compatibility have been considered?
- | if via the On Screen Menu you have performed a Factory Reset/Recall?

Before reporting the screen defect, please prepare the following information/evidence:

- | model number *
- | purchase receipt and serial number *
- | name and address for collection
- | telephone/fax number, for availability during the day
- | convenient collection date (date, time)
- | short description of the defect

Important Note:

If there is no fault found in the collected equipment after inspection, the transferring party shall incur charges for transport and administration.

If you have checked all of the above and there is still no picture, call our information line for assistance in your country.

Feedback on health and safety issues

If you have any health and safety concerns or questions about the product (including when using the product), please contact iiyama support through our website. You can also contact us by calling +31 204460404. After receiving your feedback, we will ask the responsible unit to handle it as soon as possible and a dedicated person will get back to you. Your feedback will also be recorded and incorporated into our evaluation for improvements

* see the identification plate on the back of the case.

TABLE OF CONTENTS

FOR YOUR SAFETY.....	1
SAFETY PRECAUTIONS.....	1
SPECIAL NOTES ON LCD MONITORS	3
CUSTOMER SERVICE	5
CLEANING	5
BEFORE YOU OPERATE THE MONITOR	6
FEATURES.....	6
CHECKING THE CONTENTS OF THE PACKAGE	6
UNPACKING	6
SPECIAL NOTES ON TOUCH PANEL.....	7
CONTROLS AND CONNECTORS.....	7
INSTALLATION	11
CONNECTING YOUR MONITOR.....	13
FUNCTIONS OF THE REMOTE CONTROL	15
PREPARING THE REMOTE CONTROL.....	16
REMOTE CONTROL ID	17
BASIC OPERATIONS USING THE REMOTE CONTROL.....	18
COMPUTER SETTING	20
SCREEN SETUP.....	21
OPERATING THE MONITOR.....	22
ADJUSTMENT MENU CONTENTS	23
STANDBY FEATURE	42
TROUBLE SHOOTING	43
RECYCLING INFORMATION.....	44
APPENDIX	45
SPECIFICATIONS : ProLite TF3239AS-B1AG	45
SPECIFICATIONS : ProLite TF4339AS-B1AG	46
SPECIFICATIONS : ProLite TF5039AS-B1AG	47
SPECIFICATIONS : ProLite TF5539AS-B1AG	48
SPECIFICATIONS : ProLite TF6539AS-B1AG	49
DIMENSIONS : ProLite TF3239AS	50
DIMENSIONS : ProLite TF4339AS	50
DIMENSIONS : ProLite TF5039AS	51
DIMENSIONS : ProLite TF5539AS	51
DIMENSIONS : ProLite TF6539AS	52
COMPLIANT TIMING	53

FOR YOUR SAFETY

SAFETY PRECAUTIONS

WARNING

STOP OPERATING THE MONITOR WHEN YOU SENSE TROUBLE

If you notice any abnormal phenomena such as smoke, strange sounds or fumes, unplug the monitor and contact your dealer or iiyama service center immediately. Further use may be dangerous and can cause fire or electric shock.

NEVER REMOVE THE CABINET

High voltage circuits are inside the monitor. Removing the cabinet may expose you to the danger of fire or electric shock.

DO NOT PUT ANY OBJECT INTO THE MONITOR

Do not put any solid objects or liquids such as water into the monitor. In case of an accident, unplug your monitor immediately and contact your dealer or iiyama service center. Using the monitor with any object inside may cause fire, electric shock or damage.

INSTALL THE MONITOR ON A FLAT, STABLE SURFACE

The monitor may cause an injury if it falls or is dropped.

DO NOT USE THE MONITOR NEAR WATER

Do not use where water may be splashed or spilt onto the monitor as it may cause fire or electric shock.

OPERATE UNDER THE SPECIFIED POWER SUPPLY

Be sure to operate the monitor only with the specified power supply. Use of an incorrect voltage will cause malfunction and may cause fire or electric shock.

PROTECT THE CABLES

Do not pull or bend the power cable and signal cable. Do not place the monitor or any other heavy objects on the cables. If damaged, the cables may cause fire or electric shock.

ADVERSE WEATHER CONDITIONS

It is advisable not to operate the monitor during a heavy thunder storm as the continual breaks in power may cause malfunction. It is also advised not to touch the plug in these circumstances as it may cause electric shock.

CAUTION

INSTALLATION LOCATION

Do not install the monitor where sudden temperature changes may occur, or in humid, dusty or smoky areas as it may cause fire, electric shock or damage. You should also avoid areas where the sun shines directly on the monitor.

DO NOT PLACE THE MONITOR IN A HAZARDOUS POSITION

The monitor may topple and cause injury if not suitably located. Please also ensure that you do not place any heavy objects on the monitor, and that all cables are routed such that children may not pull the cables and possibly cause injury.

MAINTAIN GOOD VENTILATION

Ventilation slots are provided to keep the monitor from overheating. Covering the slots may cause fire. To allow adequate air circulation, place the monitor at least 10 cm (or 4 inches) from any walls. In case the monitor will be installed inside a kiosk or any other equipment, please make sure enough ventilation is available to avoid overheating of the monitor. Contact the iiyama service center in case you need advice.

DISCONNECT THE CABLES WHEN YOU MOVE THE MONITOR

When you move the monitor, turn off the power switch, unplug the monitor and be sure the signal cable is disconnected. If you do not disconnect them, it may cause fire or electric shock.

UNPLUG THE MONITOR

If the monitor is not in use for a long period of time it is recommended that it is left unplugged to avoid accidents.

HOLD THE PLUG WHEN DISCONNECTING

To disconnect the power cable or signal cable, always pull it by the plug. Never pull on the cable itself as this may cause fire or electric shock.

DO NOT TOUCH THE PLUG WITH WET HANDS

Pulling or inserting the plug with wet hands may cause electric shock.

WHEN YOU INSTALL THE MONITOR ON YOUR COMPUTER

Be sure the computer is strong enough to hold the weight of the monitor, otherwise, you may damage your computer.

OTHERS

ERGONOMIC RECOMMENDATIONS

To eliminate eye fatigue, do not operate the monitor against a bright background or in a dark room. For optimal viewing comfort, the monitor should be just below eye level and 40-60 cm (16-24 inches) away from your eyes. When using the monitor over a prolonged time, a ten minute break every hour is recommended as looking at the screen continuously can cause eye strain.

SPECIAL NOTES ON LCD MONITORS

- The following symptoms are normal with LCD monitors and do not indicate a problem.

NOTE

- When you first turn on the LCD monitor, the picture may not fit in the display area because of the type of computer that is used. In this case, adjust the picture position to the correct position.
 - You may find slightly uneven brightness on the screen depending on the desktop pattern you use.
 - Due to the nature of the LCD screen, an afterimage of the previous screen may remain after switching the image, when the same image is displayed for hours. In this case, the screen is recovered slowly by changing the image or turning off the Power Switch for hours.
- This LCD cannot be used outdoors.
 - If you use a cable longer than the supplied one, the picture quality is not guaranteed. Touch function can be disrupted if the USB cable length exceeds 3m.

USAGE CONFIRMATION

Product maximum non-stop usage hours following the installation guidelines in a clean and temperature-controlled environment: 24/7

The monitor is compatible for usage in Landscape/Portrait and Tabletop (face-up) applications. If being used in Tabletop application, please utilise the Fan-On function.

IMAGE PERSISTENCE / IMAGE STICKING

Please be aware that all LCD screens can experience Image Persistence or Image Sticking. This occurs when a residual image remains visible on a screen when static images are displayed for long periods of time. LCD Image Persistence is not permanent but constant images being displayed for a long period of time should be avoided.

To counteract Image Persistence, turn off the monitor for as long as the previous image was displayed, so if an image was on the monitor for 1 hour and there is evidence of a residual or “ghost” image, you should turn off the monitor for 1 hour in order to clear the residual image.

For all LFD products, iiyama recommends displaying moving images and utilising a moving screen saver at regular intervals whenever the screen is idle. You could also turn off the monitor when not in use to assist the prevention.

Other ways to reduce the risk of Image Persistence will be to utilise the Fan-On function (if available), Low Backlight and Low Brightness settings.

FOR EXTENDED USE AS A PUBLIC MONITOR

■ Image Sticking on LCD Panel

When a static image is displayed for hours, an electric charge trace remains near the electrode inside the LCD producing a “ghost” image. (Image Persistence).

Image Persistence is not a permanent feature.

■ Recommendations

To prevent Image Sticking and promote longer life expectancy of monitor, we recommend the following:

1. Avoid static images displayed for long periods – change static images on continuous loop.
2. Turn off monitor when not in use, either by remote control or use Standby or Schedule functions.
3. Check the Monitor Menu Settings for “Pixel Shift” or “White wash” and activate it when available. This will reduce the Image Sticking Effect.
4. When monitor is installed in high ambient temperature environment(s) or in an enclosed position, utilise the Cooling Fan, Screen Saver and Low Brightness functions.
5. Suitable ventilation for any monitor is an expectation of any installation – climate control systems may need to be employed.
6. We strongly recommend utilisation of active cooling with fans for long operation times or high ambient temperature environments.

CUSTOMER SERVICE

NOTE

- If you have to return your unit for service and the original packaging has been discarded, please contact your dealer or iiyama service center for advice or replacement packaging.

CLEANING

WARNING

- If you drop any materials or liquids such as water into the monitor when cleaning, unplug the power cable immediately and contact your dealer or iiyama service center.

CAUTION

- For safety reasons, turn off the power switch and unplug the monitor before you clean it.

NOTE

- To protect the LCD panel, do not scratch or rub the screen with a hard object.
- Never use any of the following strong solvents. These will damage the cabinet and the LCD screen.

Thinner	Benzine	Abrasive cleaner
Spray-type cleaner	Wax	Acid or Alkaline solvent

- Touching the cabinet with any product made from rubber or plastic for a long time may cause degeneration or loss of paint on the cabinet.

CABINET

Stains can be removed with a cloth lightly moistened with a mild detergent solvent. Then wipe the cabinet with a soft dry cloth.

LCD

Periodic cleaning with a soft dry cloth is recommended.

SCREEN

Don't use tissue paper etc. because these will damage the LCD screen.

BEFORE YOU OPERATE THE MONITOR

FEATURES

- ◆ **Supports Resolutions up to**
1920 × 1080 ProLite TF3239AS
3840 × 2160 ProLite TF4339AS / ProLite TF5039AS / ProLite TF5539AS / ProLite TF6539AS
- ◆ **High Contrast**
1200:1 (Typical) ProLite TF3239AS / ProLite TF4339AS / ProLite TF5539AS / ProLite TF6539AS
5000:1 (Typical) ProLite TF5039AS
- ◆ **Brightness 500cd/m² (Typical without touch panel)**
- ◆ **Digital Character Smoothing**
- ◆ **2 × 10W Stereo Speakers**
- ◆ **Standby Feature**
- ◆ **VESA Mounting Standard Compliant**
200mm×200mm ProLite TF3239AS / ProLite TF4339AS
400mm×400mm ProLite TF5039AS / ProLite TF5539AS / ProLite TF6539AS
- ◆ **Glass with AG Coating**

CHECKING THE CONTENTS OF THE PACKAGE

The following accessories are included in your package. Check to see if they are enclosed with the monitor. If anything is missing or damaged, please contact your local iiyama dealer or regional iiyama office.

- | | | |
|-----------------------------|----------------------|-------------------|
| ■ Power Cable (2 pcs)* | ■ HDMI Cable | ■ RS-232C Cable |
| ■ USB Cable | ■ Remote Control | ■ Battery (2 pcs) |
| ■ Cable Cover with 2 screws | ■ EU/UK Energy Label | ■ Safety Guide |
| ■ Quick Start Guide | | |

CAUTION

* All guarantees and warranties are void for any problems or damage caused by a power cable not supplied by iiyama.

An approved power cable greater or equal to H05VVf, 3G, 0.75mm² must be used.

UNPACKING

CAUTION

Moving the monitor requires at least two people. If not, it may drop and could result in a serious injury.

SPECIAL NOTES ON TOUCH PANEL

CAUTION

Permanent damage can occur if Sharp Edged, Pointed or Metal items are used to activate Touch. This could invalidate any remaining warranty.

We recommend to use conductive rubber tip type stylus (tip R8.0 or over) or finger.

CONTROLS AND CONNECTORS

<Front>

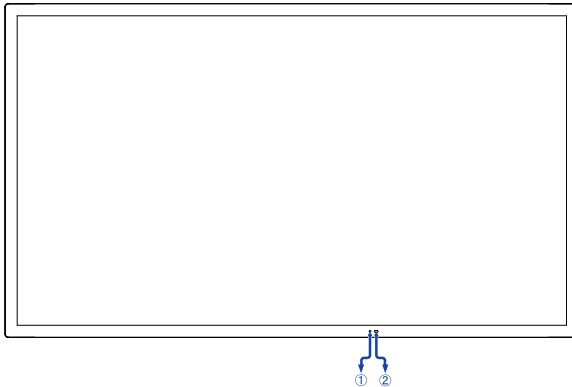

		State	LED
①	Power Indicator	Main Power Switch "Off"	Off
		Functionally "Off"	Off
		Normal operation	Solid blue
		Standby mode	Blinking blue
②	Remote Sensor		

<Back>

■ ProLite TF3239AS

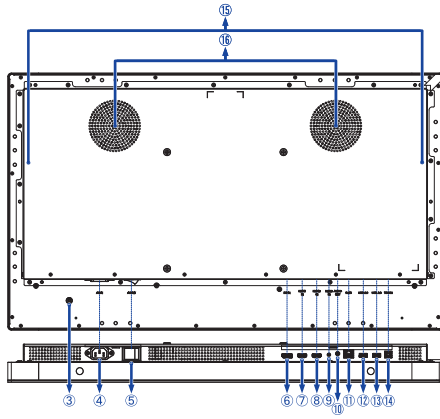

■ ProLite TF4339AS

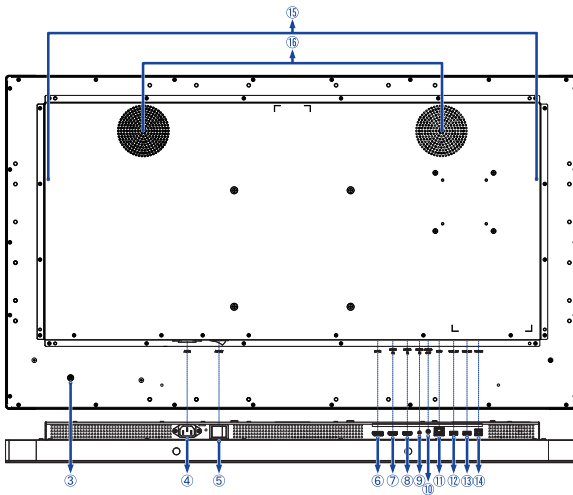

ENGLISH

■ ProLite TF5039AS

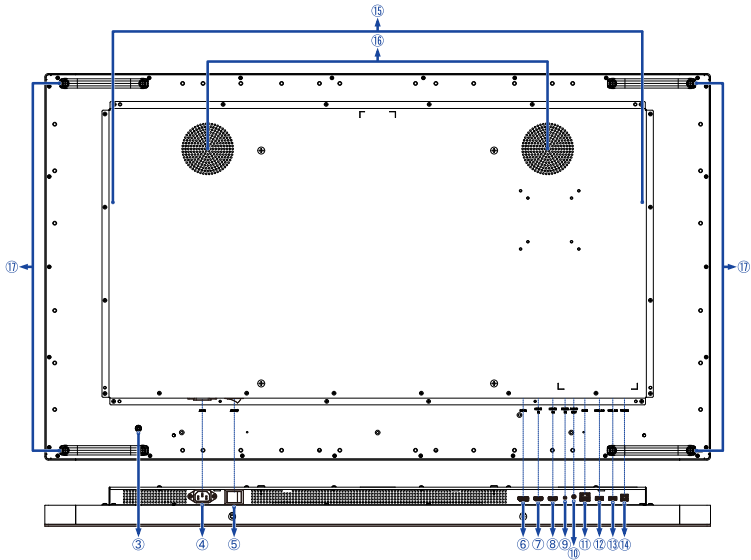

■ ProLite TF5539AS

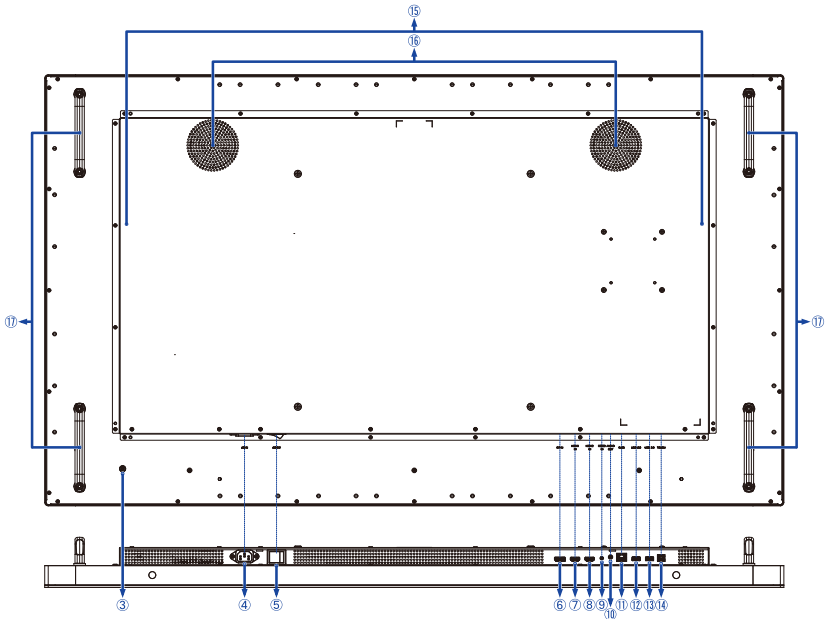

■ ProLite TF6539AS

ENGLISH

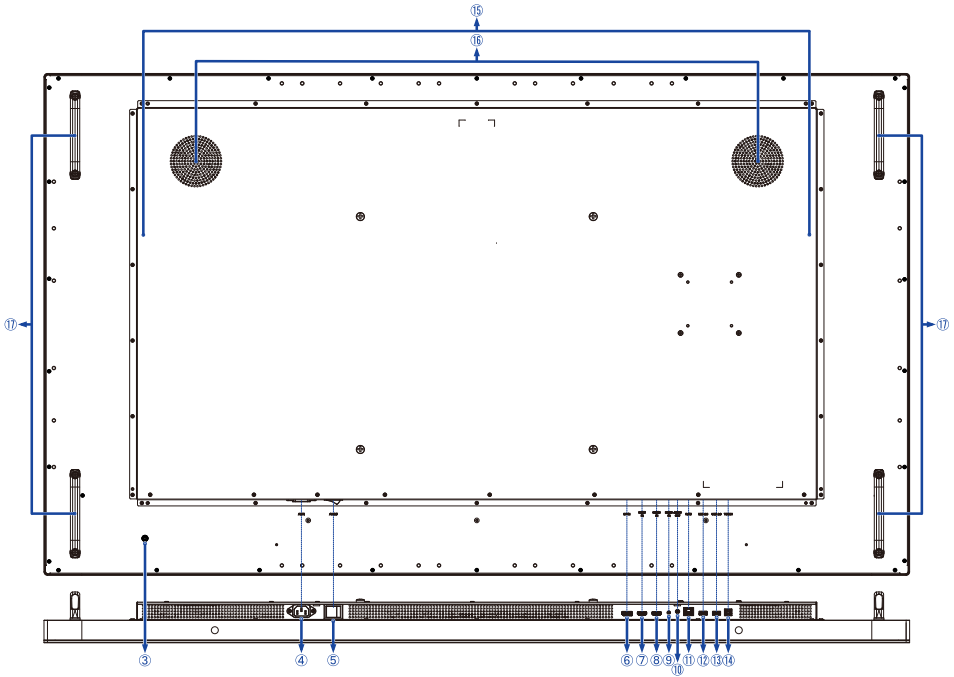

③		Power Button	
④	AC IN	AC Inlet	AC Connector (~: Alternating current)
⑤	AC-SW (ON) / ○ (OFF)	Main Power Switch	
⑥	DP IN	DisplayPort	DisplayPort Connector
⑦	HDMI1 IN	HDMI	HDMI Connector
⑧	HDMI2 IN	HDMI	HDMI Connector
⑨	RS232 IN	RS232C	RS232C Connector
⑩	AUDIO OUT	Mini Jack	Headphone Connector *
⑪	RJ45	RJ45	RJ45 Connector
⑫	USB2.0	USB2.0 (DC5V, 500mA)	USB Type-A Downstream Connector
⑬	USB2.0	USB2.0 (DC5V, 500mA)	USB Type-A Downstream Connector
⑭	TOUCH	USB Touch	USB Type-B Upstream Connector
⑮	Speakers		
⑯	Fans		
⑰	Handles		

* Proper operation of connected external devices other than headphones is not guaranteed.

INSTALLATION

CAUTION

- Follow the manual instructions for the type of mount you have selected. Refer all servicing to qualified service personnel.
- Moving the monitor requires at least two people.
- Before installing, please make sure the wall is strong enough to hold the necessary weight of the monitor and the mount.

[WALL MOUNTING]

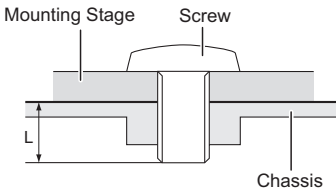

Model	Screw	"L" length
ProLite TF3239AS	M6	12mm
ProLite TF4339AS	M6	12mm
ProLite TF5039AS	M6	12mm
ProLite TF5539AS	M6	12mm
ProLite TF6539AS	M8	16mm

CAUTION

When using the wall mounting, consideration of thickness of the mounting stage needs to be taken. Tighten the screws to fasten the monitor. Using a screw not specified may cause electric shock or damage because it may contact with the electrical parts inside the monitor.

[ROTATING THE MONITOR]

This monitor is designed to be compatible in landscape, portrait and face-up modes.

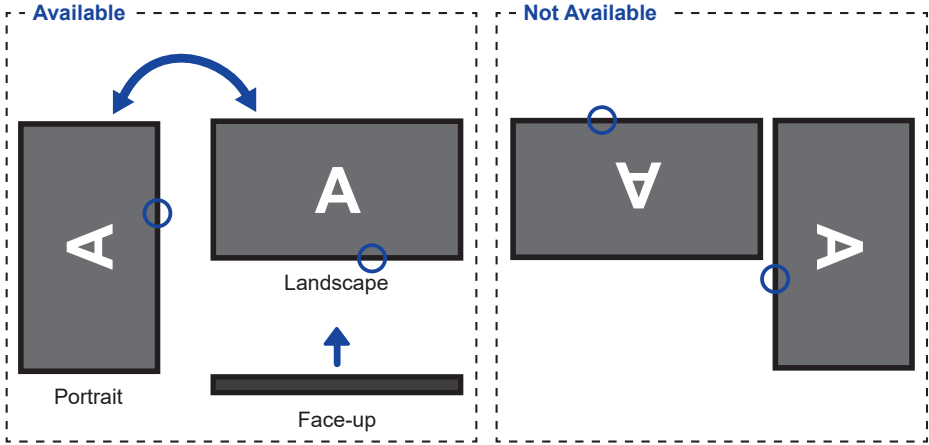

○ Power Indicator, Remote Sensor

[FAN]

CAUTION

If the screen is used in face-up position, please be sure to turn on the "Fan" function.

If you do not use the fan, the internal temperature rises and the product life cycle may get shorter.

If the screen is built into an external cabinet, please be sure to implement a cooling unit inside of the cabinet.

Dirt and dust may stick to the fan, reducing the cooling effect which may result in a shorter life cycle of the product. Please clean regularly.

CONNECTING YOUR MONITOR

- ① Ensure that both the computer and the monitor are switched off.
- ② Connect the computer to the monitor with the signal cable.
- ③ Connect the computer to the monitor with the USB Cable.
- ④ Connect the Power Cable to the monitor first and then to the power source.
- ⑤ Turn on your monitor (Main Power Switch and Power Button) and computer.
- ⑥ Follow the OOBE (Out of Box Experience) instructions to complete the screen setup.

NOTE

- Make sure that the building installation has a circuit breaker of 120/240V, 20A (maximum).
- The signal cables used for connecting the computer and monitor may vary with the type of computer used. An incorrect connection may cause serious damage to both the monitor and the computer. The cable supplied with the monitor is for a standard connector. If a special cable is required please contact your local iiyama dealer or regional iiyama office.
- Make sure you tighten the finger screws at each end of the signal cable.
- The touch function is ready for use about 8 seconds after connecting the USB cable and can be operated with a pen, finger or any other pointer.
- The Class I pluggable equipment Type A must be connected to protective earth.
- The socket-outlet shall be installed near the equipment and shall be easily accessible.
- Excessive sound pressure from ear-/headphones can cause hearing damage/hearing loss.

[Example of Connection]

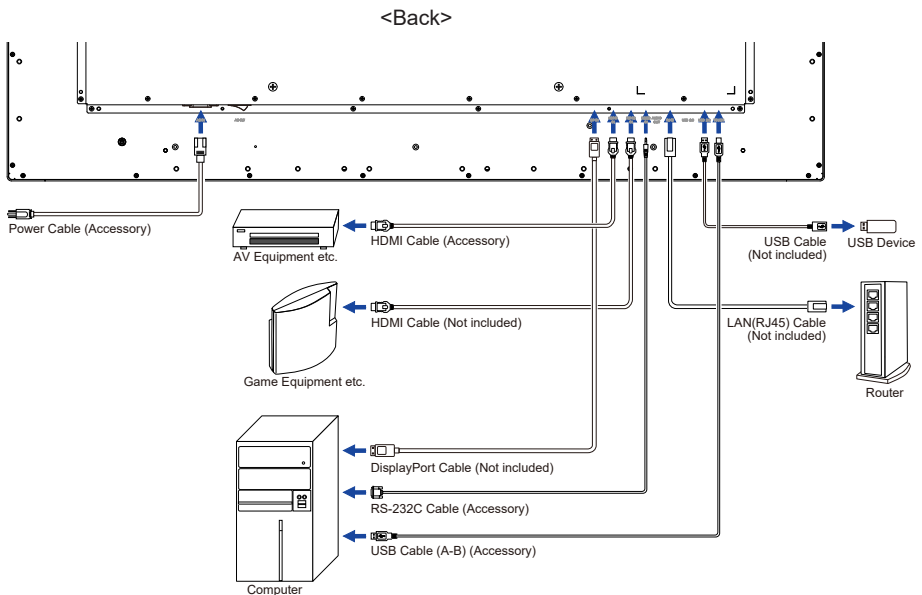

[Attaching the Cable Cover]

ENGLISH

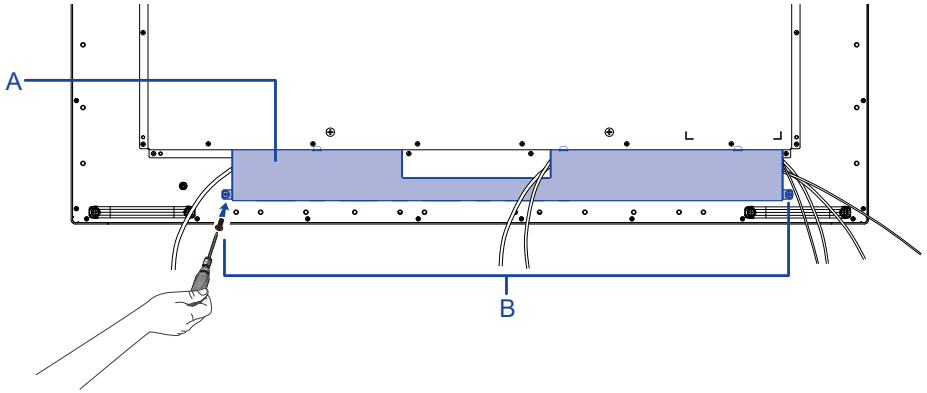

A : Cable Cover

B : Screws

FUNCTIONS OF THE REMOTE CONTROL

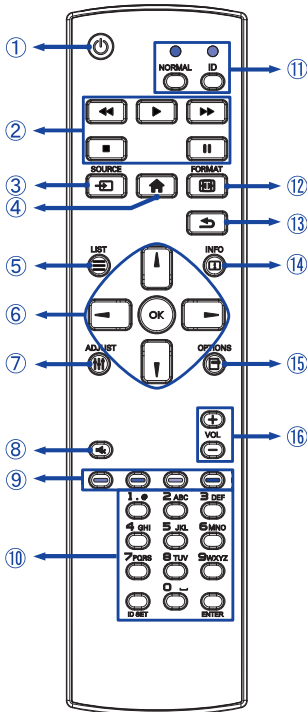

①		Turns the display ON and OFF.
②	[PLAY]	Control playback of media files. ▶ : Play ■ : Stop : Pause ◀◀ : Fast-Rewind ▶▶ : Fast-Forward
③	SOURCE	Selects the source. Press ▲ or ▼ button to select from HDMI1, HDMI2, DisplayPort, Browser, CMS, File Manager, Media Player, PDF Player or Custom. Press [OK] button to confirm and exit.
④	HOME	Opens the display's on-screen menu systems.
⑤	LIST	Returns to the previous menu. Only Browser, Media Player and PDF Player inputs.
⑥		Navigate through submenus and settings. ▲ : Up Button ▼ : Down Button ◀ : Left Button ▶ : Right Button In Media Player: ◀ : Previous file ▶ : Next file In PDF Player: ◀ : Previous page ▶ : Next page
	OK	Confirms your selection or saves changes.
⑦	ADJUST	Not available on this model.
⑧	MUTE	Turns on or off the mute function when the Menu is not displayed.
⑨	COLOR	Not available on this model.
⑩	NUMBER/ ID SET/ ENTER	Enter text for network setting or ID setting.
⑪	ID Mode	ID: To enter ID Mode NORMAL: To leave ID Mode
⑫	FORMAT	Changes picture format.
⑬	BACK	Returns to a previous menu or closes the OSD Menu.
⑭	INFO	Provides source and resolution information. Press the button for 6 seconds to unlock the remote control.
⑮	OPTIONS	Displays edit bar. Only Browser, Media Player and PDF Player inputs.
⑯	VOLUME + / -	VOLUME + : Increases the sound volume. VOLUME - : Decreases the sound volume.

PREPARING THE REMOTE CONTROL

To use the remote control, insert the two dry batteries.

CAUTION

- Do not use any other batteries other than those specified in this manual for the Remote Control.
- Do not insert old and new batteries together in the Remote Control.
- Make sure that the terminals match the “+” and “-” indications in the battery compartment.
- Remove the dead batteries immediately to prevent them from liquid leaking into the battery compartment.
- Burst batteries or the electrolyte from these batteries may cause stains, fire or injury.

- ① Open the battery cover.

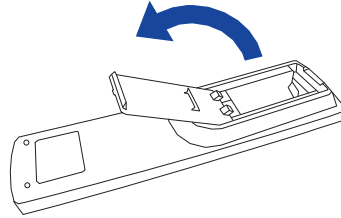

- ② Align and insert two AAA batteries according to their plus and minus ports (as indicated in the remote control).

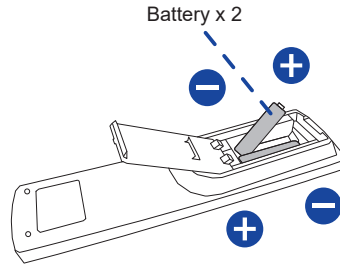

- ③ Close the battery cover.

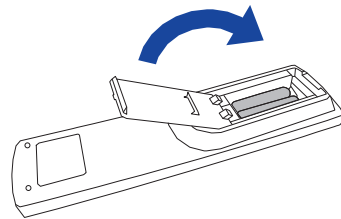

NOTE

- Refer to the above instructions when taking out the batteries.
- Replace with new batteries when the Remote Control does not work close to the monitor. Use AAA dry batteries. Risk of explosion if battery is replaced by an incorrect type.
- Operate the Remote Control by pointing it toward the Remote Sensor on the monitor.
- Other manufacturers remote control will not work with this monitor. Use the provided Remote Control ONLY.
- Used batteries needed to follow the city rule to be discarded. (suggestion: to dispose of used batteries, please follow correct policy as per your council regulations)
- Batteries shall not be exposed to excessive heat such as sunshine, fire or the like.
- If you do not intend to use the remote control for a long period, remove the batteries.

REMOTE CONTROL ID

You can set the remote control ID when you want to use the remote control on specific monitors.

ID Mode (To enter ID Mode) : Press and hold the ID button until the red LED blinks twice.

Normal Mode (To leave ID Mode) : Press and hold the Normal button until the green LED blinks twice.

■ Programming ID Mode

To assign an ID to a remote control.

1. Enter ID Mode.
2. Press and hold the ID SET button until the red LED turned on.
3. Using the number button, input the desired ID. (01 - 255)
4. Press the ENTER button to confirm ID.
5. The red LED will blink twice when ID has been confirmed.

NOTE

- Not pressing any button within 10 seconds will exit the ID Mode.
- If an error pressing of buttons other than the digits occurred, wait 1 second after the red LED lights off and then lights up again, then press the correct digits again.
- To cancel or stop programming an ID, press the ID SET button.
- It is necessary to set up the ID number for each monitor before selecting its ID number.

■ Use ID Mode

1. Enter ID Mode.
2. Input the ID of the monitor which would like to control by number button.
3. Press the ENTER button.

USING THE REMOTE CONTROL

■ Turning the monitor ON



The monitor is turned On and the Power Indicator turns Blue when you press the Power Button on the monitor or the Remote Control. The monitor is turned Off and the Power Indicator goes Off when you press the Power Button on the monitor or the Remote Control again.

NOTE

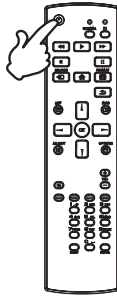
Even when using the standby mode or turning Off the Main Power Switch, the monitor will consume a small amount of electricity. Disconnect the Power Cable from the power supply whenever the monitor is not in use or during the night, to avoid unnecessary power consumption.



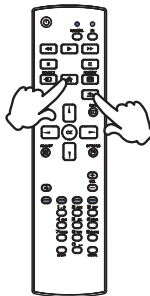

■ Display the adjustment menu page

The menu page appears on the screen when you press the  HOME button on the Remote Control. The menu page disappears when you press the  BACK button on the Remote Control again.



■ Move the cursor vertically

Select adjustment by pressing the  /  button on the remote control while the menu page is displayed on the screen.

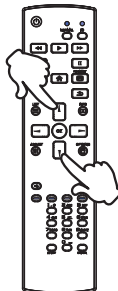

■ **Move the cursor horizontally**

Select menu or setting, or perform the adjustment by pressing the ◀ / ▶ button on the remote control while the menu page is displayed on the screen.

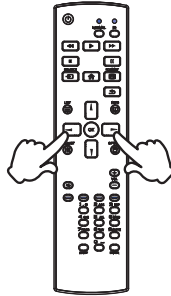

■ **Adjust the volume of sound**

Press the + / - button on the remote control to adjust the volume of sound when the menu page is not displayed on the screen.

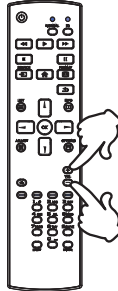

■ **Switch the input signal**

This is activated when you successively press the  SOURCE button on the remote control.

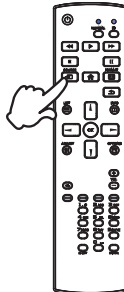

COMPUTER SETTING

■ Signal Timing

Change to the desired signal timing listed on page 53: COMPLIANT TIMING.

■ Windows 10/11 Plug & Play

The iiyama LCD monitor complies with DDC2B of VESA standard. The Plug & Play function runs on Windows 10/11 by connecting the monitor to DDC2B compliant computer with the Signal Cable supplied.

NOTE

- For additional information on how to download the driver for your touch screen monitor, please access the internet site: <https://iiyama.com>
- Monitor Drivers are not required in most cases for Macintosh or Unix operating systems. For further information, please contact your computer dealer first for advice.

■ Power-on sequence

Turn ON the monitor first, and then the computer.

■ TOUCH support operation system:

OS Version (Windows)	Windows		
	Win 8, 10, 11	Win 7	XP
Supported touches	Multi-touch		1
Supported Platform & IO Interface	I2C/USB	USB	
Note	Windows inbox driver (No need driver)		Single-touch (Need driver)

OS Version (Linux Distribution)	Android	Ubuntu	Fedora	Debian	RHEL	SUSE
		7.0~14	18.04~24.04	22~38	9~11	8~9.1
Supported touches	Multi-touch					
Supported Kernel version	4.4~6.2	4.15~6.8	4.0-6.2	4.19-5.10	4.18~5.10	3.10~5.14
Supported Platform & IO Interface	USB/I2C			x86 (USB)		
Note	Driver supports Multi-touch *					

OS Version (Mac OS)	Mac OS 10.14 ~14
Supported touches	Multi-touch
Supported Platform & IO Interface	USB
Note	Driver supports Multi-touch *

* For Multi-touch driver, please visit our web site (<https://iiyama.com>), or contact your dealer or iiyama service center.

SCREEN SETUP

Follow the OOBE (Out of Box Experience) instructions to complete the screen setup.

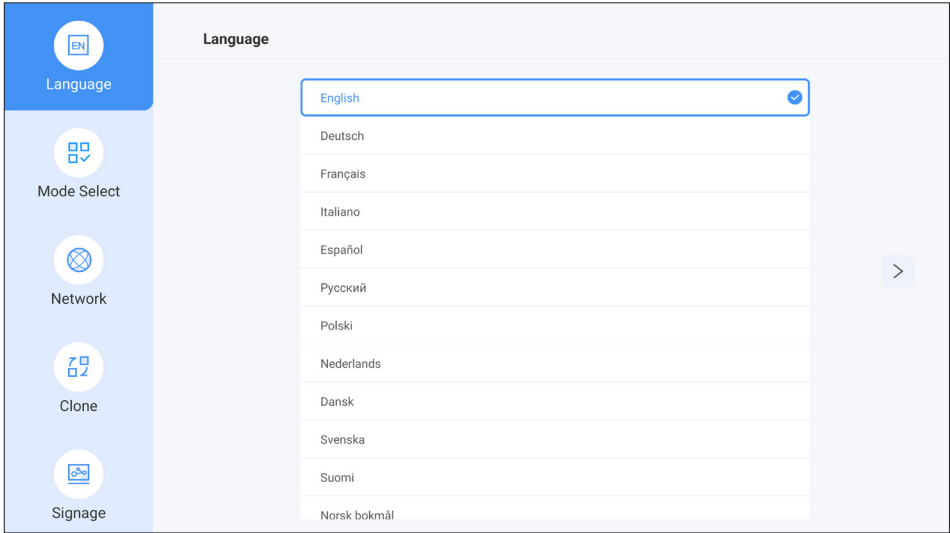
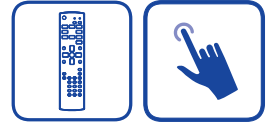

[PALM REJECTION FUNCTION]

Palm rejection is a way to disregard touch made with “a large contact area” while finger touch operation.

A large contact area: palm, clenched fist, elbow, arm, etc.

When you touch the screen with such a large contact area, palm rejection is activated and the touch action is not recognized by the screen.

OPERATING THE MONITOR

To create the best picture, your iiyama LCD monitor has been preset at the factory with the COMPLIANT TIMING shown on page 53. You can also adjust the picture using the following operations.

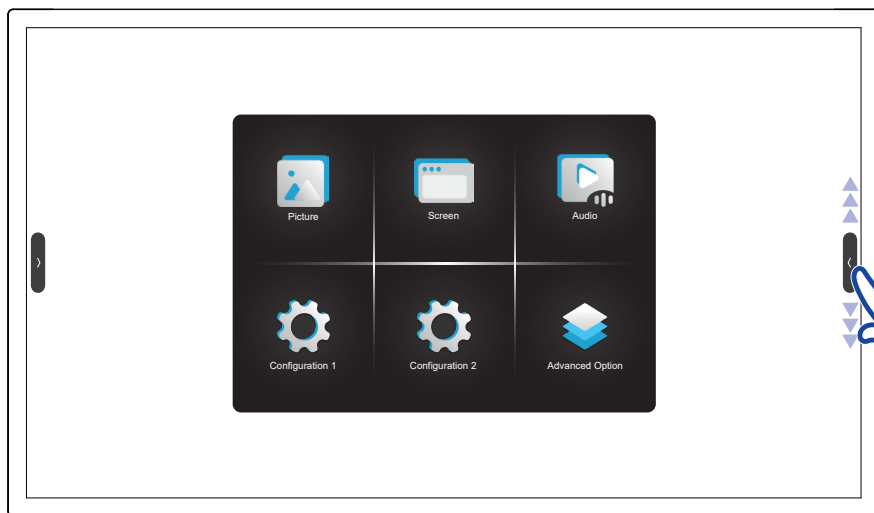
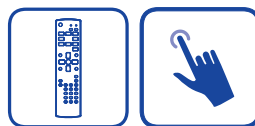

- ① Press the HOME button to start the On Screen Display feature.
- ② Select the menu to make an appropriate adjustment or setting.

NOTE ■ Touching either the left or right bar will reveal the Navigation Bar.

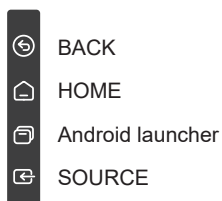

- Any changes are automatically saved in the memory when the On Screen Display disappears. Turning off the power should be avoided while using the Menu.
- All adjustments have only one setting which applies to all signal timings.

ADJUSTMENT MENU CONTENTS

Picture

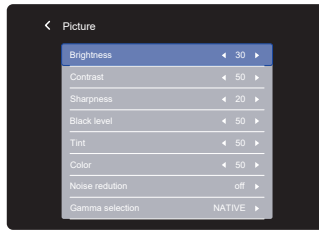

Adjustment Item	Problem / Option			
Brightness *1	Too dark Too bright		▶▶	
Contrast *2	Too dull Too intense		▶▶	
Sharpness *2	Too soft Too sharp		▶▶	
Black level *2	Black is too dark Black is too bright		▶▶	
Tint *2	Purplish Greenish		▶▶	
Color *2	Too weak Too strong		▶▶	
Noise reduction *2	Off	Noise Reduction is turned off.		
	Low	Electronic image noise caused by different media players is reduced.		
	Middle	Electronic image noise caused by different media players is reduced more than Low.		
	High	Electronic image noise caused by different media players is reduced more than Medium.		
Gamma selection	You can set the Gamma. Native / 2.2 / 2.4 / Sgamma / D-image			
Low blue light	Off	Return to normal.		
	On	Blue light is reduced.		
Color temperature	3000K	9300K		
	4000K	10000K		
	5000K	Native	Original color temperature	
	6500K	User1	User preset 1	
	7500K	User2	User preset 2	

Picture

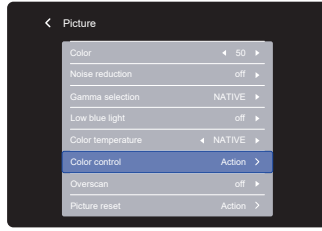

Adjustment Item	Option	
Color control * ³	Set user color.	
	<i>For User1</i>	R
		G
		B
<i>For User2</i>	2000K-10000K	
Overscan * ²	Off	Fix overscan.
	On	Edges of a screen are trimmed.
Picture reset	Cancel	Return to Menu.
	OK	Picture setting will be restored to factory-preset data.

- *¹ Adjust the Brightness when you are using the monitor in a dark room and feel the screen is too bright. Brightness adjustment is disabled when "Brightness" of "Panel saving" is on.
- *² Not available for Browser, CMS, File Manager, Media Player, PDF Player and Custom inputs.
- *³ Available only when "Color temperature" is set to "User1" or "User2".

Screen

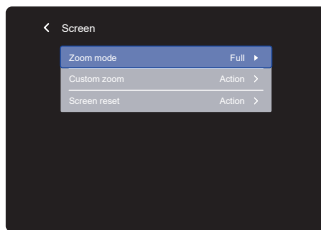

Adjustment Item	Option	
Zoom mode *1	Full	Enlarge the picture horizontally to fill the screen if the picture source is 4:3 (standard definition). When the picture source is 16:9 (high definition), it is not scaled.
	4:3	Display all pictures in 4:3 aspect ratio.
	Real	Display the picture dot by dot.
	21:9	Display all pictures in 21:9 aspect ratio.
	Custom	Customize zoom screen.
Custom zoom *2	Zoom	Zoom the horizontal and vertical size of the image simultaneously.
	H zoom	Zoom the horizontal size of the image.
	V zoom	Zoom the vertical size of the image.
	H position *3	Zoom / H Zoom values.
	V position *3	Zoom / V Zoom values.
Screen reset	Cancel	Return to Menu.
	OK	Screen setting will be restored to factory-preset data.

*1 Not available for Browser, CMS, File Manager, Media Player, PDF Player and Custom inputs.

*2 It can be chose only when "Zoom mode" is set to "Custom".

*3 Not available when the value of "Zoom", "H zoom" and "V zoom" is "0".

Audio

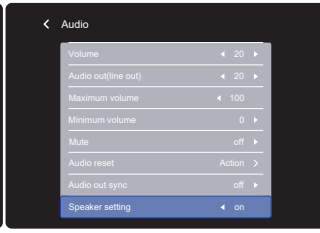

Adjustment Item	Problem / Option	
Balance	Left side speaker is louder. Right side speaker is louder. ▶▶	
Treble	Too weak ▶▶ Too strong ▶▶	
Bass	Too weak ▶▶ Too strong ▶▶	
Volume	Too soft ▶▶ Too loud ▶▶	
Audio out (line out)	Adjust audio output volume. Too soft ▶▶ Too loud ▶▶	
Maximum volume	Set the maximum volume. ▶▶	
Minimum volume	Set the minimum volume. ▶▶	
Mute	Off	Return the sound volume to the previous level.
	On	Turn off the sound temporarily.
Audio reset	Cancel	Return to Menu.
	OK	Audio setting will be restored to factory-preset data.
Audio out sync	Off	The speaker volume is different from the audio out (line-out) volume.
	On	The speaker volume is consistent with the audio out (line-out) volume.
Speaker setting	Off	Disable the built-in speaker.
	On	Enable the built-in speaker.

Configuration 1



Adjustment Item	Option		
Android launcher	Enable Android launcher in settings to access feature.		
Switch on state	Forced on	The monitor will turn on when the power cable is connected to a wall outlet.	
	Power off	The monitor will remain off when the power cable is connected to a wall outlet.	
	Last status	The monitor will return to the previous power status (on/off/standby) when removing and replacing the power cable.	
Touch lock	Off	Enable touch screen operation.	
	On	Disable touch screen operation.	
Touch mode * ¹	Off	Normal touch (with bare hands or stylus device)	
	Glove	Touch with gloved hand (Supports thickness +2mm)	
	Through glass	Touch through glass (Supports thickness +6mm)	
Mouse mode	Off	Mouse mode is turned off.	
	On	Multi-touch operation is switched to single touch operation.	
Panel saving	Brightness	Off	Backlight adjustment is off.
		On	The image brightness will be reduced to 40% of the maximum.
	Pixel shift	For the monitor to slightly shift the position of pixels in four directions (up, down, left or right).	
		Auto	Move the position of the image automatically.
		Off	Pixel shift is turned off.
	On	Move the position of the image at set intervals. 10 - 900 seconds	
	White wash	Display an entire white screen to reduce image burn-in. Recommended display time is 4 hours or more. Press  button to return to the menu.	

*¹ Turn on the power and set the “Touch mode” after the monitor installation is completed. Turning on the power and setting the “Touch mode” before the monitor installation may cause misalignment or malfunction of the touch calibration.

The maximum touch points change depending on the selected mode.

	Max. touch points
Off	40*
Glove	5
Through glass	2

* Normal setting on Windows OS allows up to 10 touch points.

Configuration 1

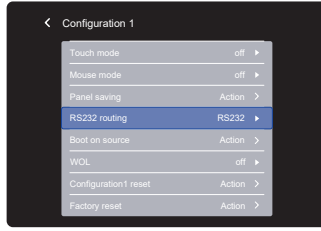

Adjustment Item	Option	
RS232 routing	Select the RS232 control port. RS232 / LAN RS232	
Boot on source * ²	Last input	When the power is turned on, it starts with the same setting as when the power was last turned off. Off / On
	Input	Select input source when boot up. HDMI1 / HDMI2 / DisplayPort / Browser / CMS / File Manager / Media Player / PDF Player / Custom
	Playlist	Select playlist index for Browser, Mediaplayer and PDF player.
WOL	Off	Disable wake on LAN function.
	On	Enable wake on LAN function.
Configuration1 reset	Cancel	Return to Menu.
	OK	Configuration1 setting will be restored to factory-preset data.
Factory reset	Cancel	Return to Menu.
	OK	Factory-preset data is restored.

*² No failover function, system will keep source even the source is no signal input.

Configuration 2

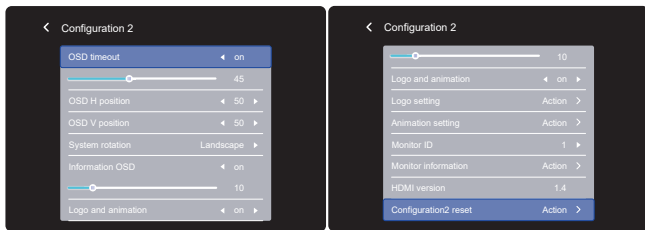

Adjustment Item	Problem / Option	
OSD timeout	You can set the OSD display duration time between 5 and 120 seconds. Off / On (5 - 120 seconds)	
OSD H position	OSD is too left OSD is too right	
OSD V position	OSD is too low OSD is too high	
System rotation	Landscape	Display the OSD in Landscape mode.
	Portrait	Display the OSD in Portrait mode.
Information OSD	Set the period of time the information is displayed on the upper right corner of the screen when the input source is switched. Off / On (1 - 60 seconds)	
Logo and animation	Off	iiyama Logo and animation does not display when the monitor is turned on.
	On	iiyama Logo and animation display when the monitor is turned on.
	User	Custom logo option in android is set, there will be only custom logo when the monitor is turned on.
Logo setting * ¹	Select boot logo.	
Animation setting * ¹	Select boot animation.	
Monitor ID	Set ID to the monitor. 1 - 255	
Monitor information	Show information about your monitor, including Model name, Serial No., Operation hours and Software version.	
HDMI version * ²	Set the version of the HDMI. 2.0 / 1.4 / Auto	
Configuration2 reset	Cancel	Return to Menu.
	OK	Configuration2 setting will be restored to factory-preset data.

*¹ The “Logo setting” and “Animation setting” are only available when you select “User” of “Logo and animation” function.

*² HDMI input only

Advanced Option



Adjustment Item	Option	
Kiosk mode * ¹	Restrict the functionality of the monitor so that it can only be used for specific purposes. Enter the password you set on the first screen setup. Kiosk mode (on/off) / Password change	
Side bar	Select the side bar display setting.	
	3s touch hold	Touch the screen for 3 seconds to display it.
	Always off	Always hide
	Always on	Always show
No signal image	Customize the image for the no signal screen. Image / Office meeting guide / Title / Room / Date & Time / Duration (30 mins / 1h / 1.5h / 2h / 2.5h / 3h / off) / Text color (White / Black) / Show current time	
Motorized stand * ²	When using a motorized stand, you can adjust and customized the height.	
	Up	Raise the motorized stand.
	Down	Lower the motorized stand.
	Slot 1 / Slot 2	Memorize your preferred height in Slot 1 or Slot 2.
IR control	Select the operation mode of the remote control.	
	Unlock * ³	Unlocked
	Lock All	Lock all of the remote control.
	Lock All but Power	Lock all except the power of the remote control.
	Lock All but Volume	Lock all except the volume of the remote control.
	Lock all except PWR & VOL	Lock all except the volume and power of the remote control.
Power LED light	Off	The Power Indicator is turned Off.
	On	The Power Indicator is turned On.
Fan * ⁴	Off	Fan is turned off.
	On	Fan is turned on.
	Auto	The fan turns on automatically when the monitor's internal temperature reaches 50°C or higher.
Off timer	Set when turn off the monitor. Off / 1 - 24 hours	

Advanced Option

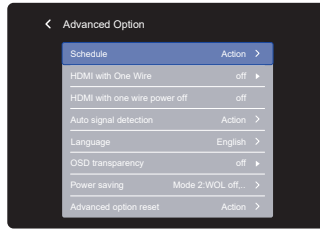

Adjustment Item	Option			
Schedule	Schedule list	Up to 7 schedules can be set.		
	Start time * ⁵	Set start time.		
	End time * ⁵	Set end time.		
	Input	Select default input source to use when the monitor is automatically turned on next time. HDMI1 / HDMI2 / DisplayPort / Browser / CMS / File Manager / Media Player / PDF Player / Custom		
	Playlist	Choose playlist for the Mediaplayer, PDF Player and Browser.		
	Days of the week	Set the day of the week. SUN / MON / TUE / WED / THU / FRI / SAT		
	Every week	Set whether to repeat every week. Off / On		
	Enable * ⁶	Enable / disable schedule.		
HDMI with One Wire	Off	HDMI with One Wire is turned off.		
	On	Control all devices connected by HDMI cable with one remote control.		
HDMI with one wire power off	Off	HDMI with One Wire Power Off is turned off.		
	On	Use the power button on the device connected with the HDMI cable to switch to standby mode.		
Auto signal detection * ⁷	Off	Disable the Auto signal detection.		
	All * ⁸	Detects all sources automatically if there is no signal on the default input and selects the available signal automatically.		
	Failover	Detects sources automatically with user-defined order if there is no signal on the default input and selects the available signal automatically.		
Language	English	English	Deutsch	German
	Français	French	Italiano	Italian
	Español	Spanish	Русский	Russian
	Polski	Polish	Nederlands	Dutch
	Dansk	Danish	Svenska	Swedish
	Suomi	Finnish	Norsk bokmål	Norwegian
	Čeština	Czech		

Advanced Option

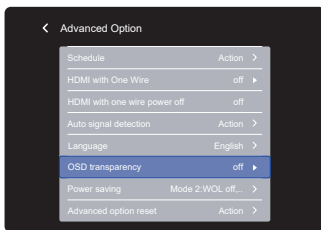

Adjustment Item	Option	
OSD Transparency	The background of OSD is made transparent. Off / 5 - 100	
Power saving	Mode1: WOL off, source input wake-up off, Backlight off Mode2: WOL off, source input wake-up on, Backlight off Mode3: WOL on, source input wake-up off, Backlight off Mode4: WOL on, source input wake-up on, Backlight off	
Advanced option reset	Cancel	Return to Menu.
	OK	Advanced Option setting will be restored to factory-preset data.

*1 Functions disabled in Kiosk mode

Configuration 1	Android launcher
Configuration 2	Logo and animation
	Logo setting
	Animation setting
Advanced Option	No signal image

*2 Disabled if not connected to a motorized stand.

*3 To unlock, press and hold the **i** INFO button on the remote control for 6 seconds.

*4 If the screen is used in face-up position, please be sure to turn on the "Fan" function.

*5 The "Start time" must be less than the "End time".

*6 Adjustments to "Enable" should be made only after "Start time", "End time", "Input" and "Days of the week" have been correctly set.

*7 The monitor detects and select available signal source automatically.



*8 Order of detection: HDMI1 → HDMI2 → DisplayPort → Browser → CMS → File Manager → Media Player → PDF Player → Custom

USING ANDROID LAUNCHER

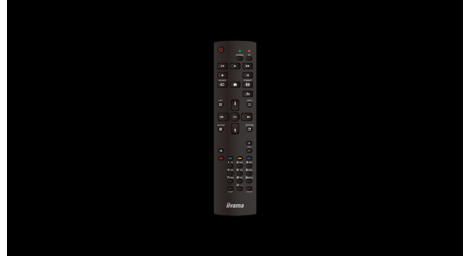
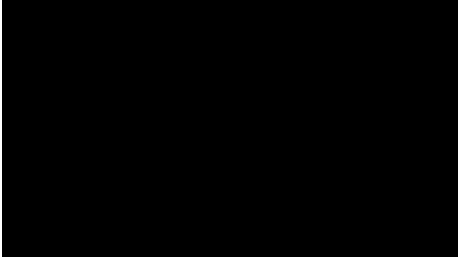
On-screen prompt



Display the Android launcher using one of the following methods:

- ➔ Press the  HOME button and number 1668 on the remote control.
- ➔ Select menu "Android launcher" in "Configuration1".
- ➔ Touch  "Android launcher" of Navigation Bar.

Android Launcher

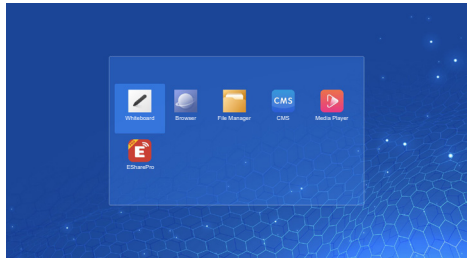
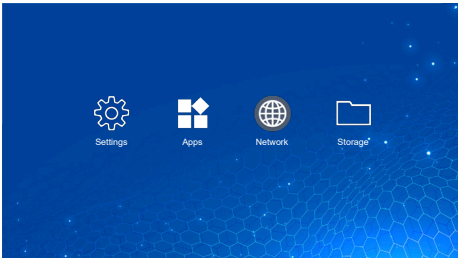

* Android upgrade is not available on this model.

- Settings : Go to settings app.
- Apps : Show all apps. (Whiteboard / Browser / File Manager / CMS / Media Player / ESharePro)
- Network : Set Ethernet.
- Storage : Display current Android storage information.

NOTE

■ Supported file system
FAT32

■ Supported file format

- Music: MP3, M4A, AAC, LPCM
- Video: 3G2, 3GP, AVI, F4V, FLV, MP4, M2TS, M2V, M4V, MKV, MOV, MPEG, MTS, OGM, PMP, TP, TS, VOB, WEBM
- Image: JPG, JPEG, BMP, PNG, GIF

Settings

ENGLISH

Network & internet

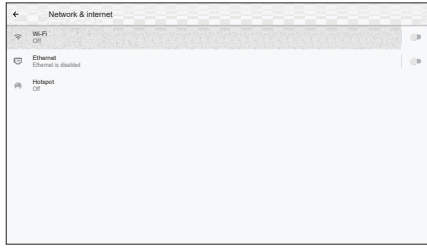

Item	Option		
Wi-Fi *	Set the wifi function On / Off and pairing to WiFi device.		
	Wifi list	Display a list of WiFi networks	
	Add network	Network name	
		Security	
		Advanced options	
	Wifi preferences	Turn on wifi automatically	
Notify for public networks			
Advanced			
Saved networks	Save wifi networks on this monitor.		
Ethernet	Set the wired network. Enable / Disable		
	IP address	Assign IP address for this monitor.	
	Netmask	Assign Netmask for this monitor.	
	Gateway	Assign Gateway for this monitor.	
	DNS1	Assign DNS server address.	
	DNS2		
	Ethernet IP mode	Static	
DHCP			
Hotspot *	Wifi hotspot	Set the Hotspot function. On / Off (Hotspot name / security / hotspot password / AP Band / Turn off hotspot automatically)	

* Available when connecting to Wifi Dongle.

Apps & notifications

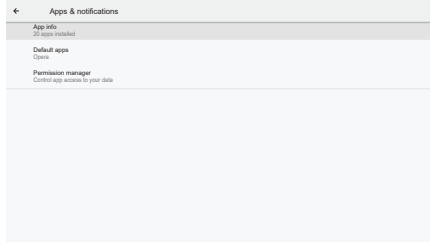

Item	Option	
App info	Display all applications.	
Default apps	Browser app	Set the default apps.
	Home app	
	Opening links	
Permission manager	App permissions	Set app permissions.

Display

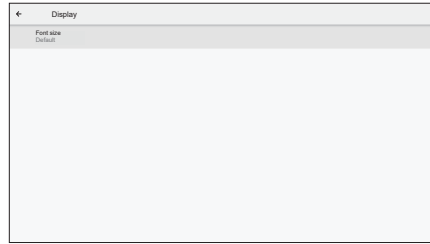

Item	Option	
Font size	Small	Set the font size.
	Default	
	Large	
	Largest	

Signage display

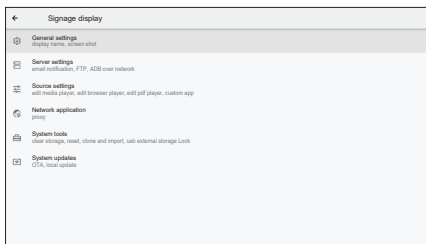

Item	Option			
General settings	Signage display name	Set the monitor name.		
	Screenshot	Enable / disable (Interval, Start time, End time, Repeat, Save to, Purge screenshots, Send screenshots via email)		
Server settings	Email notification	Enable / disable (SMTP, Manager email, Test)		
	FTP	Enable / disable (Account, Password, Storage path, Port)		
	ADB over network	Enable / disable ADB function.		
Source settings	Edit media player	Edit Media Player playlist and effect settings.		
	Edit browser player	Edit Browser list and effect settings.		
	Edit PDF player	Edit PDF Player playlist and effect settings.		
	Storage path	Set the Media player, PDF player, Browser storage location.		
	Custom app	Select app opened under the Custom channel.		
Network application	Proxy	Set the proxy server. Enable / disable (Proxy hostname: Proxy server IP Adress, Proxy port: Proxy server port number, Type: Proxy server type) Authentication / username / password		
System tools	Clear storage	Clear all data in signage folders. All / Internal storage / USB storage		
	Reset	Erase all data	Factory-preset data is restored.	
	Clone and import	Clone	Copy the signage display configuration, OSD setting and media files.*	
		Import	Import from signage folder. Internal storage / External storage	
	USB external storage Lock	Lock / unlock the USB External Storage.		
System updates	OTA	Firmware update.		
	Local update			

* Media files are the media contents that are copied to this device while creating playlists in Browser, Media Player and PDF player source.

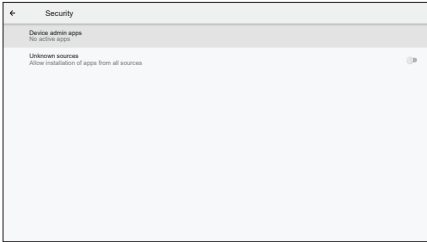
Security	
	
Item	Option
Device admin apps	Display credential storage information.
Unknown sources	Enable / disable installation of apps from unknown sources.

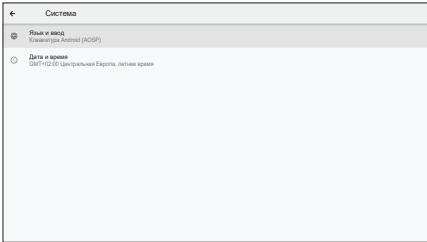
System		
		
Item	Option	
Language & input	Languages	Set display language, keyboard and input method.
	On-screen keyboard	Language: English / Deutsch / Français / Italiano / Español / Русский / Polski / Nederlands / Dansk / Svenska / Suomi / Norsk bokmål / Čeština
	Physical keyboard	
Date & time	Use network-provided time	Set the Date and Time. Use Automatic Date & Time, Date Format, 24-Hour Format.
	Time zone	
	Ntp server	

About device



Item	Option	
Legal information	Third-party licenses	Main info in About: Legal / Model / Android version / Build number / Build version Automatically search update .zip from USB. When you select the updated .zip file, the monitor will restart and the update will start.
	System WebView licenses	
Model	Model	
	Serial number	
	Hardware version	
Android version	Android version	
	Android security update	
	Kernel version	
	Build number	
Build number		
Build version		

■ Quick Info

Press the **i** INFO button and number 77 on the remote control to confirm the Network and the Monitor Information.

[Whiteboard]

The Whiteboard application is useful for business presentations, meetings, training sessions, and more. With touch operations, you can easily create lines, shapes, and tables, and you can also paste images and videos.

[Browser]

Search or enter address to go to the webpage you want.
Personalize your browser with an Opera account.

[File Manager]

Browse the files stored in the internal storage including USB.

[Media Player]

- Play file: Select the file to play
 - Play order: Set the play order of the files
 - Play mode: Set the playback mode
 - Picture style: Set the picture size
 - Create list: Create a new playlist
 - Play list: Edit playlist
- **Play file**
 1. Select "Play file" on the page.
 2. Select the file and press OK button.
 - Multiple files can be selected.
 3. Press the "Open" button to play.
 - **Play order**

Select "Play order" on the page.

 - **Sequences:** Play files in sequences.
 - **Reverse:** Play files in reverse.
 - **Random:** All files in the list play randomly.
 - **Cycle:** All files in the list play repeatedly.
 - **Play mode**

Select "Play mode" on the page.

 - **Auto:** Autoplay duration(s). 5s / 15s / 30s / 60s
 - **Manual:** Play the file manually.

- **Picture style**

Select "Picture style" on the page.

- **Scale:** Display the image in its original aspect ratio.
- **Full:** Enlarge the image to full screen











- **Create list**

1. Select "Create list" on the page.
2. Select "Add file".
3. Select the file and add to the list.

- **Play list**

1. Select "Play list" on the page.
2. Press the  **OPTIONS** button on the remote control to open the edit bar.
3. Add the file or edit the file.

- Remote control

- : Move up.
- : Move down.
-  **OK:** Select file.
-  **Play:** Play the media file.
-  **OPTIONS:** Display edit bar.
 - Delete all:** Delete all playlist files.
 - Back:** Return.
-  **Pause:** To pause the media file.
-  **Fast forward:** To skip forward 10 seconds.
-  **Fast rewind:** To skip backward 10 seconds.
-  **Stop:** To stop the playing file and return to Menu.
- : Previous file
- : Next file

[EShare Pro]

EShare is a multiscreen interaction application which makes the user experience natural and enjoyable for home entertainment, business presentation, and educational training.

[PDF Player]

● Play file

1. Select "Play file" on the page.
2. Select the file and press OK button.
Multiple files can be selected.
3. Press the "Open" button to play.

● Play order

Select "Play order" on the page.

- **Sequences:** Play files in sequences.
- **Reverse:** Play files in reverse.
- **Random:** All files in the list play randomly.
- **Cycle:** All files in the list play repeatedly.

● Play mode

Select "Play mode" on the page.

- **Auto:** Autoplay duration(s). 5s / 15s / 30s / 60s
- **Manual:** Adjust the file manually.









● Create list

1. Select "Create list" on the page.
2. Select "Add file".
3. Select the file and add to the list.

● Play list

1. Select "Play list" on the page.
2. Press the  OPTIONS button on the remote control to open the edit bar.
3. Add the file or edit the file.

■ Remote control

- : Move up.
- : Move down.
-  **OK:** Select file.
-  **Play:** Play the PDF file.
-  **OPTIONS:** Display edit bar.
 - Delete all:** Delete all playlist files.
 - Back:** Return.
-  **Pause:** To pause the PDF file.
-  **Stop:** Return.
- : Previous page
- : Next page

STANDBY FEATURE

This product features the standby function. When activated, it automatically reduces unnecessary power consumption of the monitor when your computer is not in use.

There is a standby step the monitor takes as described below. The standby function, including any timer settings is configured by the operating system. Check your operating system manual for information on how this can be configured.

■ Standby Mode

When the video signal from the computer is off, the monitor enters into Standby Mode which reduces the power consumption to less than 0.5W*. The screen becomes dark, and the power indicator blinks blue. From Standby Mode, the image reappears in several seconds when either the keyboard or the mouse are touched again.

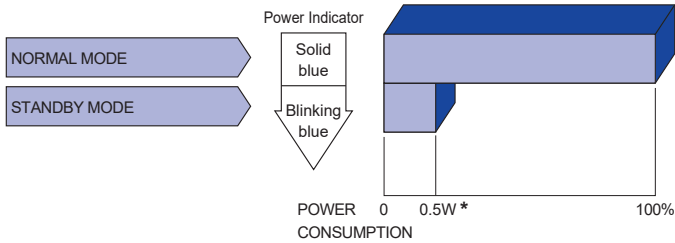

* When the USB devices are not connected.

TROUBLE SHOOTING

If the monitor fails to operate correctly, please follow the steps below for a possible solution.

1. Perform the adjustments described in OPERATING THE MONITOR, depending on the problem you have. If the monitor does not get a picture, skip to 2.
2. Consult the following items if you cannot find an appropriate adjustment item in OPERATING THE MONITOR or if the problem persists.
3. If you are experiencing a problem which is not described below or you cannot correct the problem, discontinue using the monitor and contact your dealer or iiyama service center for further assistance.

Problem	Check
<p>① The picture does not appear. (Power indicator does not light up.)</p> <p>(Power indicator is blue.)</p> <p>(Power indicator is blinking blue.)</p>	<ul style="list-style-type: none"> <input type="checkbox"/> The Power Cable is firmly seated in the socket. <input type="checkbox"/> The Power Switch is turned ON. <input type="checkbox"/> The AC socket is live. Please check with another piece of equipment. <input type="checkbox"/> If the blank screen saver is in active mode, touch the keyboard or the mouse. <input type="checkbox"/> Increase the Contrast and/or Brightness. <input type="checkbox"/> The computer is ON. <input type="checkbox"/> The Signal Cable is properly connected. <input type="checkbox"/> The signal timing of the computer is within the specification of the monitor. <input type="checkbox"/> If the monitor is in standby mode, touch the keyboard or the mouse. <input type="checkbox"/> The computer is ON. <input type="checkbox"/> The Signal Cable is properly connected. <input type="checkbox"/> The signal timing of the computer is within the specification of the monitor.
<p>② The screen is not synchronized.</p>	<ul style="list-style-type: none"> <input type="checkbox"/> The Signal Cable is properly connected. <input type="checkbox"/> The signal timing of the computer is within the specification of the monitor.
<p>③ The screen position is not in the center.</p>	<ul style="list-style-type: none"> <input type="checkbox"/> The signal timing of the computer is within the specification of the monitor.
<p>④ The screen is too bright or too dark.</p>	<ul style="list-style-type: none"> <input type="checkbox"/> The video output level of the computer is within the specification of the monitor.
<p>⑤ The screen is shaking.</p>	<ul style="list-style-type: none"> <input type="checkbox"/> The power voltage is within the specification of the monitor. <input type="checkbox"/> The signal timing of the computer is within the specification of the monitor.
<p>⑥ No sound.</p>	<ul style="list-style-type: none"> <input type="checkbox"/> The audio equipment (computer etc.) is ON. <input type="checkbox"/> The Audio Cable is properly connected. <input type="checkbox"/> The Volume is turned up. <input type="checkbox"/> The Mute is OFF. <input type="checkbox"/> The audio output level of the audio equipment is within the specification of the monitor.
<p>⑦ The sound is too loud or too quiet.</p>	<ul style="list-style-type: none"> <input type="checkbox"/> The audio output level of the audio equipment is within the specification of the monitor.
<p>⑧ A strange noise is heard.</p>	<ul style="list-style-type: none"> <input type="checkbox"/> The audio cable is properly connected.

RECYCLING INFORMATION

For better environment protection please don't dispose your monitor.
Please visit our web site: <https://iiyama.com> for monitor recycling.

APPENDIX

Design and specifications are subject to change without prior notice.

SPECIFICATIONS : ProLite TF3239AS-B1AG

Touch Screen	Technology	Projected capacitive 40 points	
	Light transmission	87%	
	Hardness	7H	
	Thickness	3mm	
	Communication system	USB serial transfer	
Size Category		32"	
LCD Panel	Panel technology	IPS	
	Size	Diagonal: 31.5" (80cm)	
	Pixel pitch	0.12125mm H × 0.36375mm V	
	Brightness	500cd/m ² (Typical without touch panel) 435cd/m ² (Typical with touch panel) 130cd/m ² (Default / Energy Saving)	
	Contrast ratio	1200 : 1 (Typical)	
	Viewable angle	Horizontal : 178°, Vertical: 178° (Typical)	
	Response time	8ms (Gray to Gray)	
Display Colors		Approx. 16.7 million	
Sync Frequency		Horizontal: 28.0-160.0kHz, Vertical: 23-85Hz	
Native Resolution		1920 × 1080, 2.1 MegaPixels	
Supported Max. Resolution		1920 × 1080, 60Hz	
Input Connector		HDMI × 2, DisplayPort × 1	
LAN		RJ45	
Serial Port		RS-232C In	
Input Video Signal		HDMI1, HDMI2, DisplayPort	
USB Standard		USB2.0 (DC5V, 500mA)	
Number of USB Ports Connector shape		1 Upstream: Type-B 2 Downstream: Type-A	
Headphone Connector ^{*1}		ø 3.5mm Mini jack (Stereo)	
Speakers		10W × 2 (Stereo speakers)	
Maximum Screen Size		698.40mm W × 392.85mm H / 27.5" W × 15.5" H	
Power Source		100-240VAC, 50-60Hz, 1.0A	
Power Consumption ^{*2}		50W (Typical) Standby mode: 0.5W maximum, Off mode: 0.3W maximum	
Dimensions Net Weight		746.0 × 440.5 × 62.5mm / 29.4 × 17.3 × 2.5" (W×H×D) 13.2kg / 29.1lbs	
Environmental Considerations		Operating: Temperature 0 to 40°C / 32 to 104°F Humidity 20 to 80% (No condensation) Storage: Temperature -20 to 60°C / 4 to 140°F Humidity 10 to 90% (No condensation)	
Approvals		CE, UKCA, TÜV-Bauart, EAC, cTUVus	

NOTE ^{*1} Proper operation of connected external devices other than headphones is not guaranteed.

^{*2} When the USB devices are not connected.

SPECIFICATIONS : ProLite TF4339AS-B1AG

Touch Screen	Technology	Projected capacitive 40 points
	Light transmission	87%
	Hardness	7H
	Thickness	3mm
	Communication system	USB serial transfer
Size Category		43"
LCD Panel	Panel technology	IPS
	Size	Diagonal: 42.5" (108cm)
	Pixel pitch	0.2451mm H × 0.2451mm V
	Brightness	500cd/m ² (Typical without touch panel) 435cd/m ² (Typical with touch panel) 105cd/m ² (Default / Energy Saving)
	Contrast ratio	1200 : 1 (Typical)
	Viewable angle	Horizontal : 178°, Vertical: 178° (Typical)
	Response time	8ms (Gray to Gray)
Display Colors		Approx. 1.07 billion
Sync Frequency		Horizontal: 28.0-160.0kHz, Vertical: 23-85Hz
Native Resolution		3840 × 2160, 8.3 MegaPixels
Supported Max. Resolution		3840 × 2160, 60Hz
Input Connector		HDMI × 2, DisplayPort × 1
LAN		RJ45
Serial Port		RS-232C In
Input Video Signal		HDMI1, HDMI2, DisplayPort
USB Standard		USB2.0 (DC5V, 500mA)
Number of USB Ports		1 Upstream: Type-B
Connector shape		2 Downstream: Type-A
Headphone Connector *1		ø 3.5mm Mini jack (Stereo)
Speakers		10W × 2 (Stereo speakers)
Maximum Screen Size		941.18mm W × 529.42mm H / 37.1" W × 20.8" H
Power Source		100-240VAC, 50-60Hz, 2.0A
Power Consumption *2		116W (Typical) Standby mode: 0.5W maximum, Off mode: 0.3W maximum
Dimensions		997.0 × 585.5 × 63.5mm / 39.3 × 23.1 × 2.5" (W×H×D)
Net Weight		22.1kg / 48.7lbs
Environmental Considerations		Operating: Temperature 0 to 40°C / 32 to 104°F Humidity 20 to 80% (No condensation) Storage: Temperature -20 to 60°C / 4 to 140°F Humidity 10 to 90% (No condensation)
Approvals		CE, UKCA, TÜV-Bauart, EAC, cTÜVus

NOTE *1 Proper operation of connected external devices other than headphones is not guaranteed.

*2 When the USB devices are not connected.

SPECIFICATIONS : ProLite TF5039AS-B1AG

Touch Screen	Technology	Projected capacitive 40 points
	Light transmission	87%
	Hardness	7H
	Thickness	3mm
	Communication system	USB serial transfer
Size Category		50"
LCD Panel	Panel technology	VA
	Size	Diagonal: 49.5" (126cm)
	Pixel pitch	0.285375mm H × 0.285375mm V
	Brightness	500cd/m ² (Typical without touch panel) 435cd/m ² (Typical with touch panel) 120cd/m ² (Default / Energy Saving)
	Contrast ratio	5000 : 1 (Typical)
	Viewable angle	Horizontal : 178°, Vertical: 178° (Typical)
	Response time	9.5ms (Gray to Gray)
Display Colors		Approx. 1.07 billion
Sync Frequency		Horizontal: 28.0-160.0kHz, Vertical: 23-85Hz
Native Resolution		3840 × 2160, 8.3 MegaPixels
Supported Max. Resolution		3840 × 2160, 60Hz
Input Connector		HDMI × 2, DisplayPort × 1
LAN		RJ45
Serial Port		RS-232C In
Input Video Signal		HDMI1, HDMI2, DisplayPort
USB Standard		USB2.0 (DC5V, 500mA)
Number of USB Ports		1 Upstream: Type-B
Connector shape		2 Downstream: Type-A
Headphone Connector *1		ø 3.5mm Mini jack (Stereo)
Speakers		10W × 2 (Stereo speakers)
Maximum Screen Size		1095.84mm W × 616.41mm H / 43.1" W × 24.3" H
Power Source		100-240VAC, 50-60Hz, 2.2A
Power Consumption *2		137W (Typical) Standby mode: 0.5W maximum, Off mode: 0.3W maximum
Dimensions		1149.5 × 670.0 × 64.0mm / 45.3 × 26.4 × 2.5" (W×H×D)
Net Weight		28.6kg / 63.1lbs
Environmental Considerations		Operating: Temperature 0 to 40°C / 32 to 104°F Humidity 20 to 80% (No condensation) Storage: Temperature -20 to 60°C / 4 to 140°F Humidity 10 to 90% (No condensation)
Approvals		CE, UKCA, TÜV-Bauart, EAC, cTÜVus

NOTE *1 Proper operation of connected external devices other than headphones is not guaranteed.

*2 When the USB devices are not connected.

SPECIFICATIONS : ProLite TF5539AS-B1AG

ENGLISH

Touch Screen	Technology	Projected capacitive 40 points
	Light transmission	87%
	Hardness	7H
	Thickness	4mm
	Communication system	USB serial transfer
Size Category		55"
LCD Panel	Panel technology	IPS
	Size	Diagonal: 54.6" (139cm)
	Pixel pitch	0.315mm H × 0.315mm V
	Brightness	500cd/m ² (Typical without touch panel) 435cd/m ² (Typical with touch panel) 140cd/m ² (Default / Energy Saving)
	Contrast ratio	1200 : 1 (Typical)
	Viewable angle	Horizontal : 178°, Vertical: 178° (Typical)
	Response time	8ms (Gray to Gray)
Display Colors		Approx. 1.07 billion
Sync Frequency		Horizontal: 28.0-160.0kHz, Vertical: 23-85Hz
Native Resolution		3840 × 2160, 8.3 MegaPixels
Supported Max. Resolution		3840 × 2160, 60Hz
Input Connector		HDMI × 2, DisplayPort × 1
LAN		RJ45
Serial Port		RS-232C In
Input Video Signal		HDMI1, HDMI2, DisplayPort
USB Standard		USB2.0 (DC5V, 500mA)
Number of USB Ports		1 Upstream: Type-B
Connector shape		2 Downstream: Type-A
Headphone Connector *1		ø 3.5mm Mini jack (Stereo)
Speakers		10W × 2 (Stereo speakers)
Maximum Screen Size		1209.6mm W × 680.4mm H / 47.6" W × 26.8" H
Power Source		100-240VAC, 50-60Hz, 2.3A
Power Consumption *2		139W (Typical) Standby mode: 0.5W maximum, Off mode: 0.3W maximum
Dimensions		1274.0 × 745.0 × 65.0mm / 50.2 × 29.3 × 2.6" (W×H×D)
Net Weight		39.6kg / 87.3lbs
Environmental Considerations		Operating: Temperature 0 to 40°C / 32 to 104°F Humidity 20 to 80% (No condensation) Storage: Temperature -20 to 60°C / 4 to 140°F Humidity 10 to 90% (No condensation)
Approvals		CE, UKCA, TÜV-Bauart, EAC, cTÜVus

NOTE *1 Proper operation of connected external devices other than headphones is not guaranteed.

*2 When the USB devices are not connected.

SPECIFICATIONS : ProLite TF6539AS-B1AG

Touch Screen	Technology	Projected capacitive 40 points
	Light transmission	87%
	Hardness	7H
	Thickness	4mm
	Communication system	USB serial transfer
Size Category		65"
LCD Panel	Panel technology	IPS
	Size	Diagonal: 64.5" (164cm)
	Pixel pitch	0.372mm H × 0.372mm V
	Brightness	500cd/m ² (Typical without touch panel) 435cd/m ² (Typical with touch panel) 140cd/m ² (Default / Energy Saving)
	Contrast ratio	1200 : 1 (Typical)
	Viewable angle	Horizontal : 178°, Vertical: 178° (Typical)
	Response time	8ms (Gray to Gray)
Display Colors		Approx. 1.07 billion
Sync Frequency		Horizontal: 28.0-160.0kHz, Vertical: 23-85Hz
Native Resolution		3840 × 2160, 8.3 MegaPixels
Supported Max. Resolution		3840 × 2160, 60Hz
Input Connector		HDMI × 2, DisplayPort × 1
LAN		RJ45
Serial Port		RS-232C In
Input Video Signal		HDMI1, HDMI2, DisplayPort
USB Standard		USB2.0 (DC5V, 500mA)
Number of USB Ports		1 Upstream: Type-B
Connector shape		2 Downstream: Type-A
Headphone Connector *1		ø 3.5mm Mini jack (Stereo)
Speakers		10W × 2 (Stereo speakers)
Maximum Screen Size		1428.48mm W × 803.52mm H / 56.2" W × 31.6" H
Power Source		100-240VAC, 50-60Hz, 2.9A
Power Consumption *2		183W (Typical) Standby mode: 0.5W maximum, Off mode: 0.3W maximum
Dimensions		1495.0 × 870.0 × 66.0mm / 58.9 × 34.3 × 2.6" (W×H×D)
Net Weight		53.7kg / 118.4lbs
Environmental Considerations		Operating: Temperature 0 to 40°C / 32 to 104°F Humidity 20 to 80% (No condensation) Storage: Temperature -20 to 60°C / 4 to 140°F Humidity 10 to 90% (No condensation)
Approvals		CE, UKCA, TÜV-Bauart, EAC, cTÜVus

NOTE *1 Proper operation of connected external devices other than headphones is not guaranteed.

*2 When the USB devices are not connected.

DIMENSIONS : ProLite TF3239AS

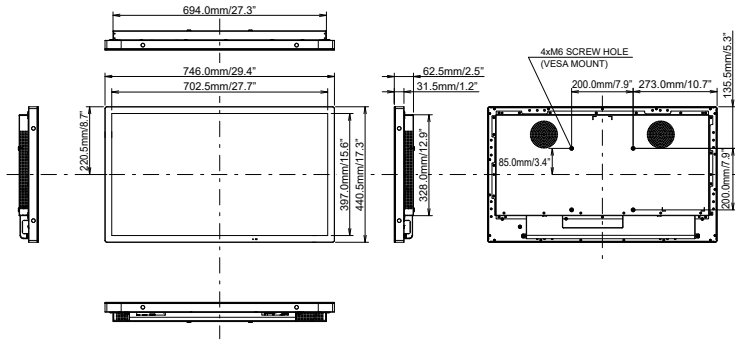

DIMENSIONS : ProLite TF4339AS

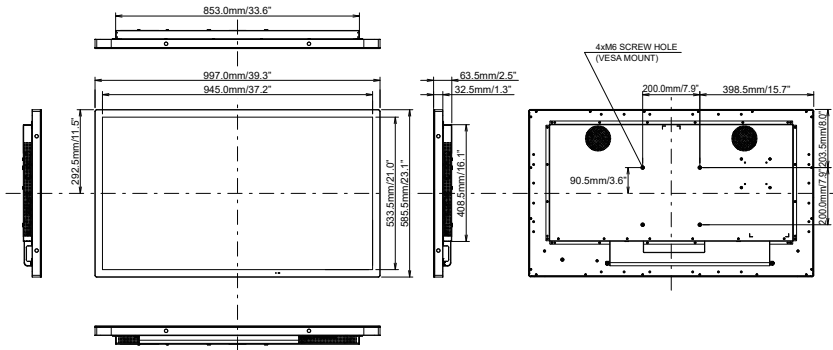

DIMENSIONS : ProLite TF5039AS

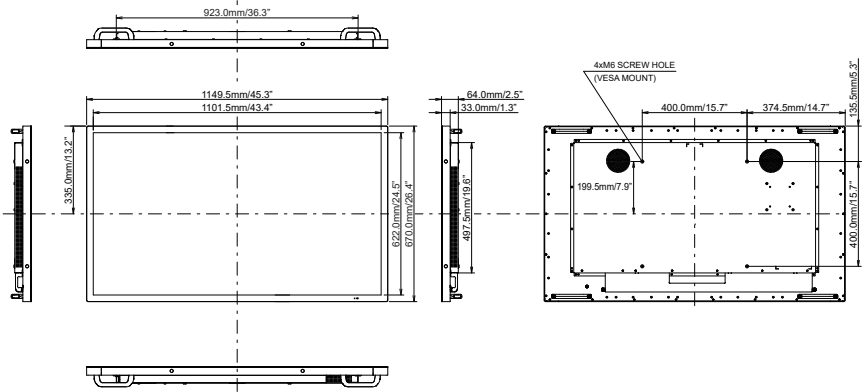

DIMENSIONS : ProLite TF5539AS

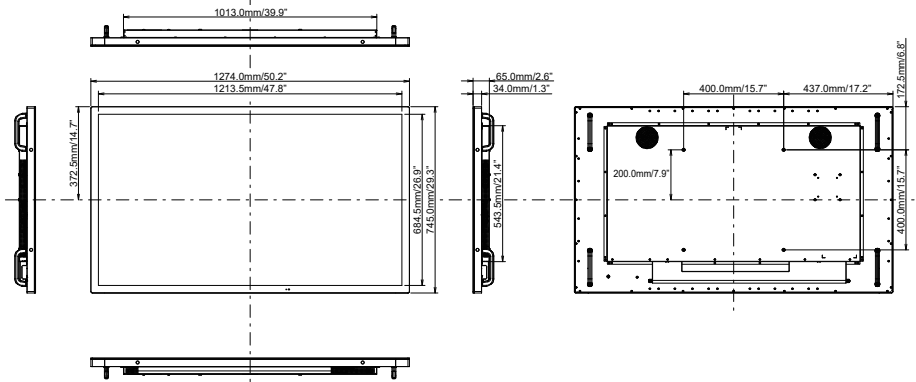

DIMENSIONS : ProLite TF6539AS

ENGLISH

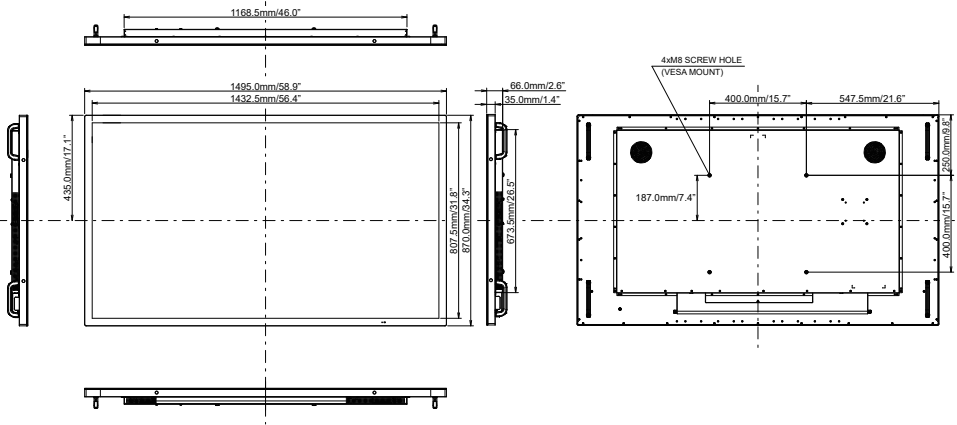

COMPLIANT TIMING

Timing		fH (kHz)	V (Hz)	Dot clock (MHz)	HDMI1	HDMI2	DisplayPort	
VESA	VGA	640x480	31.5	60.0	25.175	○	○	○
	SVGA	800x600	37.9	60.0	40.000	○	○	○
	XGA	1024x768	48.4	60.0	65.000	○	○	○
	QVGA	1280x960	64.0	60.0	108.000	○	○	○
	SXGA	1280x1024	64.0	60.0	108.000	○	○	○
	WXGA	1366x768	47.7	60.0	85.500	Ver1.4	Ver1.4	
	CVT	1440x900	55.9	60.0	106.500	○	○	○
	UXGA	1680x1050	65.3	60.0	146.250	○	○	○
	FHD	1920x1080	67.5	60.0	148.500	○	○	○
		2048x1152 *2	70.9	60.0	156.750	○	○	○
		2560x1080 *2	66.0	60.0	198.000	○	○	○
		2560x1440 *2	88.8	60.0	241.700	○	○	○
		2560x1600 *2	98.7	60.0	268.500	○	○	○
		3200x1800 *2	111.1	60.0	391.140	○	○	○
IBM		4K 3840x2160 *2	67.5	30.0	297.000	○	○	○
			135.0	60.0	594.000	○	○	○
IBM	720x400		31.5	70.0	28.320	○	○	○
SD	480i	60Hz	15.7	60.0	27.000	○	○	
	576i	50Hz	15.6	50.0	13.500	○	○	
	480p	60Hz	31.5	60.0	27.000	○	○	○
	576p	50Hz	31.3	50.0	27.000	○	○	○
HD	720p	50Hz	37.5	50.0	27.000	○	○	○
		60Hz	45.0	60.0	74.250	○	○	○
	1080i	50Hz	28.1	50.0	74.250	○	○	○
		60Hz	33.7	60.0	74.250	○	○	○
	1080p	50Hz	56.3	50.0	148.500	○	○	○
		60Hz	67.5	60.0	148.500	○	○	○

*1 ○ : Supported

*2 Not available for ProLite TF3239AS