

# USER MANUAL

# *ProLite*

## LCD Monitor

ENGLISH

*ProLite TF1015MC*  
*ProLite TF1215MC*  
*ProLite TF1515MC*  
*ProLite TF1615MC*  
*ProLite TF2215MC*  
*ProLite TF2415MC*

Thank you very much for choosing the iiyama LCD monitor.

We recommend that you take a few minutes to read this comprehensive manual carefully before installing and switching on the monitor.

Please keep this manual in a safe place for your future reference.



## Dear user, we congratulate you on the purchase of your iiyama LCD.

For details on warranty and locally used pixel policies that apply directly after installation of your product please check the iiyama website.

## To report a fault, please contact your local support centre found at <https://iiyama.com>

### Things to check before you call the iiyama information line

- | if the power cable is connected securely and turned on?
- | if the display has been turned on?
- | if the signal cable is connected securely and the correct input selected?
- | if the computer has been restarted with the display connected?
- | if the graphics card is correctly installed with the latest drivers possible?
- | if the correct native resolution has been selected via 'Display Properties'?
- | If the R/G/B signal configuration is correct?
- | if the displays On Screen Menu is shown?
- | if the correct brightness and contrast settings have been set?
- | if given display tolerances and compatibility have been considered?
- | if via the On Screen Menu you have performed a Factory Reset/Recall?

### Before reporting the screen defect, please prepare the following information/evidence:

- | model number \*
- | purchase receipt and serial number \*
- | name and address for collection
- | telephone/fax number, for availability during the day
- | convenient collection date (date, time)
- | short description of the defect

### Important Note:

If there is no fault found in the collected equipment after inspection, the transferring party shall incur charges for transport and administration.

If you have checked all of the above and there is still no picture, call our information line for assistance in your country.

### Feedback on health and safety issues

If you have any health and safety concerns or questions about the product (including when using the product), please contact iiyama support through our website. You can also contact us by calling +31 204460404. After receiving your feedback, we will ask the responsible unit to handle it as soon as possible and a dedicated person will get back to you. Your feedback will also be recorded and incorporated into our evaluation for improvements

\* see the identification plate on the back of the case.

## CE MARKING DECLARATION OF CONFORMITY

This LCD monitor complies with the requirements of the EC/EU Directive 2014/30/EU "EMC Directive", 2014/35/EU "Low Voltage Directive", 2009/125/EC "ErP Directive" and 2011/65/EU "RoHS Directive".

The electro-magnetic susceptibility has been chosen at a level that gives correct operation in residential areas, business and light industrial premises and small-scale enterprises, inside as well as outside of the buildings. All places of operation are characterised by their connection to the public low voltage power supply system.

IYAMA CORPORATION: Wijkmeesterstraat 8, 2131 HA Hoofddorp, The Netherlands

Model No. : PLF1015, PLF1215, PLF1515, PLF1615, PLF2215, PLF2415



We recommend recycling of used product. Please contact your dealer or iiyama service center. Recycle information is obtained via the Internet, using the address: <https://iiyama.com>

You can access the Web page of different countries from there.

- We reserve the right to change specifications without notice.
- All trademarks used in this user manual are the property of their respective owners.
- Eprel registration number

TF1015MC-B2 B	1255532	TF1015MC-B3	1834678	TF1015MC-B3 R	1834709
TF1215MC-B1 A	1266982	TF1215MC-B1 B	1607701		
TF1515MC-B2 B	1251335	TF1515MC-B2 C	1851373		
TF1615MC-B1	1355204				
TF2215MC-B2 B	1255900				
TF2415MC-B2 B	1260611				

# TABLE OF CONTENTS

FOR YOUR SAFETY.....	1
SAFETY PRECAUTIONS.....	1
SPECIAL NOTES ON LCD MONITORS.....	3
CUSTOMER SERVICE.....	3
CLEANING.....	3
BEFORE YOU OPERATE THE MONITOR.....	4
FEATURES.....	4
SPECIAL NOTES ON THE TOUCH PANEL.....	4
CHECKING THE CONTENTS OF THE PACKAGE.....	5
INSTALLATION.....	7
CONTROLS AND CONNECTORS.....	8
CONNECTING YOUR MONITOR.....	9
COMPUTER SETTING.....	11
OPERATING THE MONITOR.....	13
ADJUSTMENT MENU CONTENTS.....	15
SCREEN ADJUSTMENTS.....	19
STANDBY FEATURE.....	22
TROUBLE SHOOTING.....	23
RECYCLING INFORMATION.....	24
APPENDIX.....	25
SPECIFICATIONS : ProLite TF1015MC-B2 B.....	25
SPECIFICATIONS :	
ProLite TF1015MC-B3 / ProLite TF1015MC-B3 R.....	26
SPECIFICATIONS :	
ProLite TF1215MC-B1 A / ProLite TF1215MC-B1 B.....	27
SPECIFICATIONS :	
ProLite TF1515MC-B2 B / ProLite TF1515MC-B2 C.....	28
SPECIFICATIONS : ProLite TF1615MC-B1.....	29
SPECIFICATIONS : ProLite TF2215MC-B2 B.....	30
SPECIFICATIONS : ProLite TF2415MC-B2 B.....	31
DIMENSIONS : ProLite TF1015MC.....	32
DIMENSIONS : ProLite TF1215MC.....	32
DIMENSIONS : ProLite TF1515MC.....	33
DIMENSIONS : ProLite TF1615MC.....	33
DIMENSIONS : ProLite TF2215MC.....	34
DIMENSIONS : ProLite TF2415MC.....	34
COMPLIANT TIMING : ProLite TF1015MC.....	35
COMPLIANT TIMING :	
ProLite TF1215MC / ProLite TF1515MC / ProLite TF1615MC /	
ProLite TF2215MC / ProLite TF2415MC.....	35

# FOR YOUR SAFETY

## SAFETY PRECAUTIONS

### WARNING

#### **STOP OPERATING THE MONITOR WHEN YOU SENSE TROUBLE**

If you notice any abnormal phenomena such as smoke, strange sounds or fumes, unplug the monitor and contact your dealer or iiyama service center immediately. Further use may be dangerous and can cause fire or electric shock.

#### **NEVER REMOVE THE CABINET**

High voltage circuits are inside the monitor. Removing the cabinet may expose you to the danger of fire or electric shock.

#### **DO NOT PUT ANY OBJECT INTO THE MONITOR**

Do not put any solid objects or liquids such as water into the monitor. In case of an accident, unplug your monitor immediately and contact your dealer or iiyama service center. Using the monitor with any object inside may cause fire, electric shock or damage.

#### **INSTALL THE MONITOR ON A FLAT, STABLE SURFACE**

The monitor may cause an injury if it falls or is dropped.

#### **DO NOT USE THE MONITOR NEAR WATER**

Do not use where water may be splashed or spilt onto the monitor as it may cause fire or electric shock.

#### **OPERATE UNDER THE SPECIFIED POWER SUPPLY**

Be sure to operate the monitor only with the specified power supply. Use of an incorrect voltage will cause malfunction and may cause fire or electric shock.

#### **CORRECT USE OF THE AC ADAPTER**

Use only the AC Adapter provided by iiyama. Any deviation from this by using another type of adapter may result in damage to the accessory and the monitor by fire or electric shock.

#### **DO NOT DISASSEMBLE THE AC ADAPTER**

Disassembling the AC Adapter may expose you to the danger of fire or electric shock.

#### **PROTECT THE CABLES**

Do not pull or bend the AC adapter, the power cable and signal cable. Do not place the monitor or any other heavy objects on the cables. If damaged, the cables may cause fire or electric shock.

#### **ADVERSE WEATHER CONDITIONS**

It is advisable not to operate the monitor during a heavy thunder storm as the continual breaks in power may cause malfunction. It is also advised not to touch the plug in these circumstances as it may cause electric shock.

## CAUTION

### INSTALLATION LOCATION

Do not install the monitor where sudden temperature changes may occur, or in humid, dusty or smoky areas as it may cause fire, electric shock or damage. You should also avoid areas where the sun shines directly on the monitor.

### DO NOT PLACE THE MONITOR IN A HAZARDOUS POSITION

The monitor may topple and cause injury if not suitably located. Please also ensure that you do not place any heavy objects on the monitor, and that all cables are routed such that children may not pull the cables and possibly cause injury.

### MAINTAIN GOOD VENTILATION

Ventilation slots are provided to keep the monitor from overheating. Covering the slots may cause fire. To allow adequate air circulation, place the monitor at least 10 cm (or 4 inches) from any walls. In case the monitor will be installed inside a kiosk or any other equipment, please make sure enough ventilation is available to avoid overheating of the monitor. Contact the iiyama service center in case you need advice.

### DISCONNECT THE CABLES WHEN YOU MOVE THE MONITOR

When you move the monitor, turn off the power switch, unplug the monitor and be sure the signal cable is disconnected. If you do not disconnect them, it may cause fire or electric shock.

### UNPLUG THE MONITOR

If the monitor is not in use for a long period of time it is recommended that it is left unplugged to avoid accidents.

### HOLD THE PLUG WHEN DISCONNECTING

To disconnect the AC adapter, the power cable or signal cable, always pull it by the plug. Never pull on the cable itself as this may cause fire or electric shock.

### DO NOT TOUCH THE PLUG WITH WET HANDS

Pulling or inserting the plug with wet hands may cause electric shock.

### WHEN YOU INSTALL THE MONITOR ON YOUR COMPUTER

Be sure the computer is strong enough to hold the weight of the monitor, otherwise, you may damage your computer.

### REMARK FOR 24/7 USAGE

This product is not specifically designed for 24/7 usage in all environments.

## OTHERS

### ERGONOMIC RECOMMENDATIONS

To eliminate eye fatigue, do not operate the monitor against a bright background or in a dark room. For optimal viewing comfort, the monitor should be just below eye level and 40-60 cm (16-24 inches) away from your eyes. When using the monitor over a prolonged time, a ten minute break every hour is recommended as looking at the screen continuously can cause eye strain.

## SPECIAL NOTES ON LCD MONITORS

The following symptoms are normal with LCD monitors and do not indicate a problem.

### NOTE

- When you first turn on the LCD monitor, the picture may not fit in the display area because of the type of computer that is used. In this case, adjust the picture position to the correct position.
- You may find slightly uneven brightness on the screen depending on the desktop pattern you use.
- Due to the nature of the LCD screen, an afterimage of the previous screen may remain after switching the image, when the same image is displayed for hours. In this case, the screen is recovered slowly by changing the image or turning off the Power Switch for some hours.

## CUSTOMER SERVICE

### NOTE

- If you have to return your unit for service and the original packaging has been discarded, please contact your dealer or iiyama service center for advice or replacement packaging.

## CLEANING

### WARNING

- If you drop any materials or liquids such as water into the monitor when cleaning, unplug the power cable immediately and contact your dealer or iiyama service center.

### NOTE

- To protect the Touch screen surface, do not scratch or rub the screen with a hard object.
- Never use any of the following strong solvents. These will damage the cabinet and the Touch screen surface.  
Abrasive cleaner Wax Solvent
- Touching the cabinet with any product made from rubber or plastic for a long time may cause degeneration or loss of paint on the cabinet.

### CABINET

Stains can be removed with a cloth lightly moistened with a mild detergent solvent. Then wipe the cabinet with a soft dry cloth.

### TOUCH SCREEN

Touch screen surface may be cleaned using a soft clean cloth moistened with mild window glass commercial cleaners or 50/50 mixture of water and IPA(ISO-propyl-alcohol). Don't use acid or alkaline solvent to clean the surface of the panel (or screen).

# BEFORE YOU OPERATE THE MONITOR

## FEATURES

- ◆ Supports Resolutions up to 1280 × 800 : ProLite TF1015MC
- ◆ Supports Resolutions up to 1024 × 768 : ProLite TF1215MC / ProLite TF1515MC
- ◆ Supports Resolutions up to 1920 × 1080 : ProLite TF1615MC / ProLite TF2215MC / ProLite TF2415MC
- ◆ High Contrast 1300:1 (Typical) / Brightness 500cd/m<sup>2</sup> (Typical: without Touch panel) : ProLite TF1015MC-B2 B
- ◆ High Contrast 800:1 (Typical) / Brightness 500cd/m<sup>2</sup> (Typical: without Touch panel) : ProLite TF1015MC-B3
- ◆ High Contrast 1000:1 (Typical) / Brightness 600cd/m<sup>2</sup> (Typical: without Touch panel) : ProLite TF1215MC
- ◆ High Contrast 800:1 (Typical) / Brightness 350cd/m<sup>2</sup> (Typical: without Touch panel) : ProLite TF1515MC
- ◆ High Contrast 1000:1 (Typical) / Brightness 450cd/m<sup>2</sup> (Typical: without Touch panel) : ProLite TF1615MC
- ◆ High Contrast 1000:1 (Typical) / Brightness 350cd/m<sup>2</sup> (Typical: without Touch panel) : ProLite TF2215MC
- ◆ High Contrast 3000:1 (Typical) / Brightness 350cd/m<sup>2</sup> (Typical: without Touch panel) : ProLite TF2415MC
- ◆ Digital Character Smoothing
- ◆ Automatic Set-up
- ◆ Standby Feature
- ◆ VESA Mounting Standard (100mm×100mm) Compliant
- ◆ IP65 Standard Compliant (Only front face)
- ◆ Anti fingerprint finish
- ◆ Palm rejection support

### ■ Windows 8/8.1/10 touch environment

Basic touch operations can be performed under Windows 8/8.1/10.

However, please be informed that full touch functionality and normal operational performance are not guaranteed.

## SPECIAL NOTES ON THE TOUCH PANEL

### CAUTION

Permanent damage can occur if Sharp Edged, Pointed or Metal items are used to activate Touch. This could invalidate any remaining warranty.

We recommend you use a plastic stylus (tip R0.8 or over) or finger.



## CHECKING THE CONTENTS OF THE PACKAGE

The following accessories are included in your package. Check to see if they are enclosed with the monitor. If anything is missing or damaged, please contact your local iiyama dealer or regional iiyama office.

- Power Cable\*<sup>1</sup>
- DisplayPort Cable\*<sup>2</sup>
- Safety Guide
- AC Adapter\*<sup>1</sup>
- USB Cable
- Quick Start Guide
- HDMI Cable
- External control pad

### CAUTION

- \*<sup>1</sup> 1. All guarantees and warranties are void for any problems or damage caused by a power cable not supplied by iiyama.  
2. The AC Adapter has the specifications shown in the table below.  
3. An approved power cable greater or equal to H05VVF, 3G, 0.75mm<sup>2</sup> must be used.
- \*<sup>2</sup> Accessory for ProLite TF1015MC / ProLite TF1515MC / ProLite TF1615MC / ProLite TF2215MC / ProLite TF2415MC.

### < Mounting Kits >

Mounting Kits are available as an option.

If you need to incorporate a monitor into any enclosure or device, please contact the iiyama service center.

## AC Adapter Specifications

	<b>ProLite TF1015MC / ProLite TF1515MC / ProLite TF1615MC / ProLite TF2215MC / ProLite TF2415MC</b>	
<b>Type Name</b>	<b>ADP-36PH B</b>	<b>DCT36W120300ZZ-C1</b>
Manufacturer	DELTA ELECTRONICS, INC. 3 Tungyuan Road, Chungli Industrial Zone, Taoyuan City 32063, Taiwan	Zhuzhou Dachuan Electronic Technology Co., Ltd. Building A5, Nanzhou Industrial Park, Zhuzhou, Hunan, China
Input Voltage	100-240VAC	100-240VAC
Input AC Frequency	50-60Hz	50/60Hz
Output Voltage	12.0V	12.0V
Output Current	3.0A	3.0A
Output Power	36.0W	36.0W
Average Active Efficiency (230V/50Hz)	88.5% minimum	88.6% minimum
Efficiency at Low Load (10%) (230V/50Hz)	85.2% minimum	87.4% minimum
No-Load Power Consumption (230V/50Hz)	0.08W maximum	0.07W maximum
	<b>ProLite TF1215MC</b>	
<b>Type Name</b>	<b>IPU41A-105</b>	
Manufacturer	Sinpro Electronics Co., Ltd. No.5, Yuanxi St., P.E.P.Z. Pingtung City, Pingtung County 90093, Taiwan, R. O. C.	
Input Voltage	100-240VAC	
Input AC Frequency	47-63Hz	
Output Voltage	12.0V	
Output Current	3.33A	
Output Power	40.0W	
Average Active Efficiency (230V/50Hz)	88.6% minimum	
Efficiency at Low Load (10%) (230V/50Hz)	83.7% minimum	
No-Load Power Consumption (230V/50Hz)	0.07W maximum	

## INSTALLATION

- CAUTION** ■ Before installation, make sure the wall, ceiling or desktop arm is strong enough to hold the necessary weight of the display and the mount.

### < WALL MOUNTING >

- CAUTION** When you use with the wall mounting, in consideration of thickness of the mounting stage, tighten the M4 Screws (4pcs) which "L" length is 8mm to fasten the monitor. Using the screw longer than this may cause electric shock or damage because it may contact with the electrical parts inside the monitor.

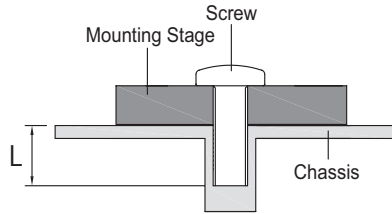

### < BUILT-IN EQUIPMENT >

- CAUTION** This product is not designed for the purpose of being used in high temperature environment. If the product is placed in an external cabinet, you need to design cooling fans and vents to keep the temperature low enough to fit in the product temperature specification.

### < ROTATING THE MONITOR >

This monitor is designed to be compatible in landscape, portrait and face-up modes.

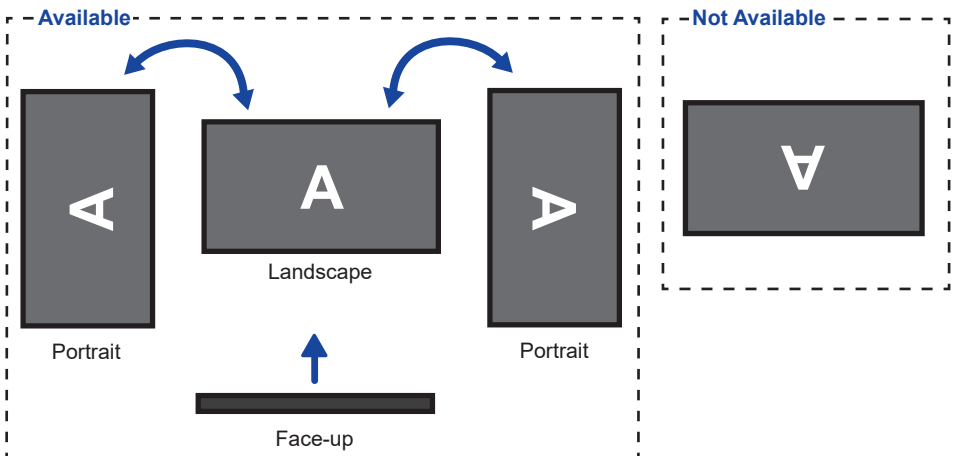

## CONTROLS AND CONNECTORS

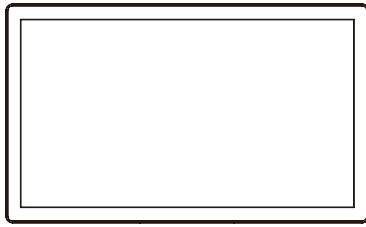

<Front>

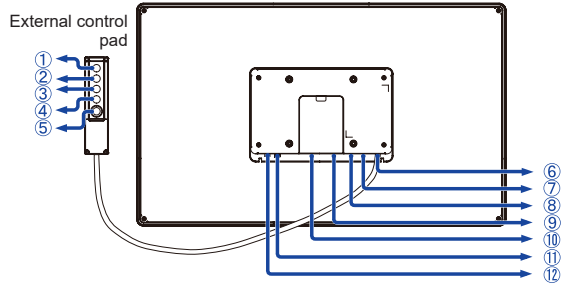

<Back>

- ① Menu Button (MENU)
- ② Scroll Up / Brightness Button (  $\Delta$  )
- ③ Scroll Down / Contrast Button (  $\nabla$  )
- ④ Select Button (SELECT)
- ⑤ Power Switch (  $\text{⏻}$  )
- ⑥ External control pad Connector (RJ45)
- ⑦ USB Connector (USB)
- ⑧ VGA Connector (VGA)
- ⑨ HDMI Connector (HDMI)
- ⑩ DisplayPort Connector (DP)
- ⑪ Connector for AC Adapter(  $\text{---}$  : Direct current) (DC)
- ⑫ Headphone Connector (AUDIO OUT)

## CONNECTING YOUR MONITOR

- ① Ensure that both the computer and the monitor are switched off.
- ② Connect the computer to the monitor with the signal cable.
- ③ Connect the computer to the monitor with the USB Cable.
- ④ Connect the monitor cable to the External control pad.
- ⑤ Connect the AC Adapter to the monitor and the Power Cable to the AC Adapter first and then connect to the power source.
- ⑥ Turn on your monitor and computer.

### NOTE

- Make sure that the building installation has a circuit breaker of 120/240V, 20A (maximum).
- The signal cables used for connecting the computer and monitor may vary with the type of computer used. An incorrect connection may cause serious damage to both the monitor and the computer. The cable supplied with the monitor is for a standard connector. If a special cable is required please contact your local iiyama dealer or regional iiyama office.
- Make sure you tighten the finger screws at each end of the Signal Cable.
- The Class I pluggable equipment Type A must be connected to protective earth.
- The socket-outlet shall be installed near the equipment and shall be easily accessible.
- Excessive sound pressure from ear-/headphones can cause hearing damage/hearing loss.

[Example of Connection]

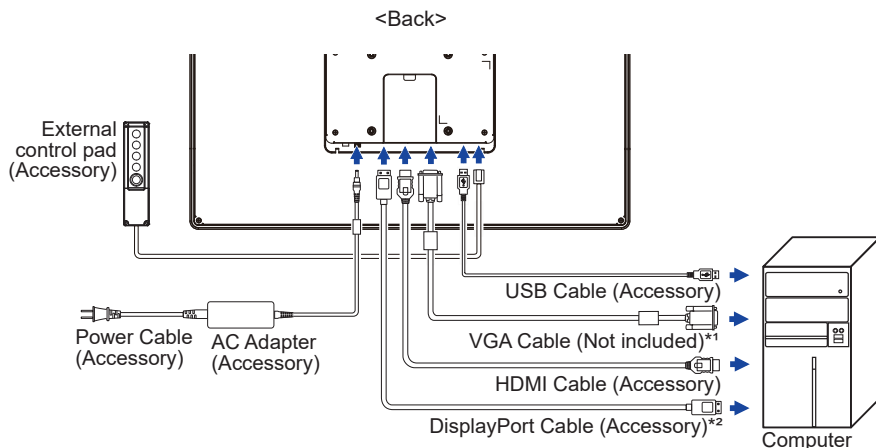

\*1 VGA cable is not supplied with the monitor. If you use low quality VGA cable, it may cause a result of electro-magnetic interference. Please contact the iiyama Support Centre in your country if you wish to connect the monitor via the VGA input.

\*2 Not included in the ProLite TF1215MC.

**[Fitting and Removal of Cable Cover]**

Put a piece of soft cloth on the table beforehand to prevent the monitor from being scratched. Lay the monitor flat on a table with front face down.

**< Removal >**

- ① Remove the screw of the cable cover and remove the cable cover from the monitor.

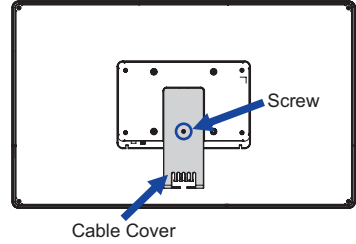
**< Fitting >**

- ① Connect the cables, place the cable cover and fix it firmly using a screw.

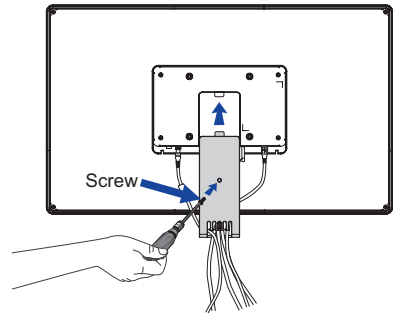

## COMPUTER SETTING

### ■ Signal Timing

Change to the desired signal timing listed on page 35: COMPLIANT TIMING.

### ■ Windows XP/Vista/7/8/8.1/10 Plug & Play

The iiyama LCD monitor complies with DDC2B of VESA standard. The Plug & Play function runs on Windows XP/Vista/7/8/8.1/10 by connecting the monitor to DDC2B compliant computer with the Signal Cable supplied.

For installation on Windows XP: The monitor Information File for iiyama monitors may be necessary for your computer and obtained via the Internet, using the address:

<https://iiyama.com>

### NOTE

- For additional information on how to download the driver for your touch screen monitor, please access the internet site noted above.
- Monitor Drivers are not required in most cases for Macintosh or Unix operating systems. For further information, please contact your computer dealer first for advice.

### ■ Procedure for turning ON the Power Switch

Turn ON the monitor first, and then the computer.

### ■ Touch screen driver software

Touch screen driver software and system may not start when you start your computer while touching the screen.

Touch screen driver software may not run due to the power saving function depending on the BIOS of your computer. In this case, set the power saving function to off.

### ■ TOUCH support operation system

Microsoft Windows XP (64 bit and 32 bit)

Microsoft Windows Vista (64 bit and 32 bit)

Microsoft Windows 7 (64 bit and 32 bit)

Microsoft Windows 8 / 8.1 / 10 (64 bit and 32 bit)

Microsoft Windows CE 6.0 / net (4.x / 5.0)

Mac OS X (Intel CPU) / 10.11 El Capitan / 10.12 Sierra

Kernel 2.6.24 upward & 3.x.x / 4.x.x

Not support earlier versions.

	Windows8/8.1/10	Windows7*5	Windows7*4	Vista	XP
Default mouse*1	○	○	○	○	○
Touch digitizer*2	○	○	○	○	×
Windows7 gestures*3	○	○	×	×	×

	2K	Windows CE	XP Embedded	Mac OS X	Linux
Default mouse*1	○	○	○	○	○
Touch digitizer*2	×	×	×	×	×
Windows7 gestures*3	×	×	×	×	×

\*1 Default mouse (click, drag, double-click and right-click)

\*2 Touch digitizer (click, drag /selection, double-click, right-click, flick and visual feedback)

\*3 Digitizer with Windows 7 touch gestures

\*4 Windows 7 - Starter and Home Basic version

\*5 Windows 7 - Home Premium, Professional, Enterprise and Ultimate versions

■ Touch Input Settings in Dual Screen Mode

- ① Connect the primary monitor to the computer first.  
 Set Control Panel > Hardware and Sound > Tablet PC Settings > Display > Setup.

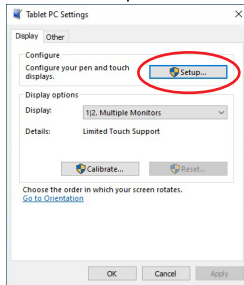
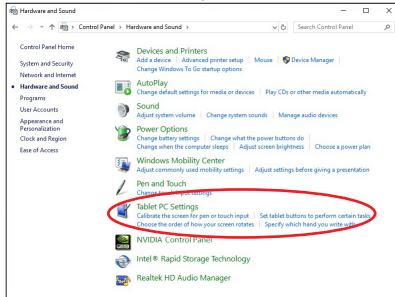
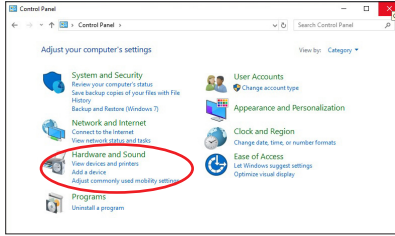

The following message will appear on the screen. Please follow the instructions.

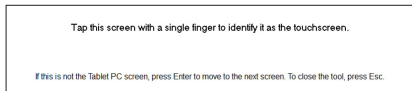

- ② After setting ①, connect a second monitor and perform the setup as in ①.

**NOTE** The monitors are recognized as dual-display, and touch operation cannot be performed on two monitors at the same time.  
 You can perform touch operation on only one of the monitors.



# OPERATING THE MONITOR

To create the best picture, your iiyama LCD monitor has been preset at the factory with the COMPLIANT TIMING shown on page 35. You are also able to adjust the picture by following the button operation shown below. For more detailed adjustments, see page 19 for SCREEN ADJUSTMENTS.

- 1 Press the MENU Button to start the On Screen Display feature. There are additional Menu items which can be switched by using the  $\Delta$  /  $\nabla$  Buttons.

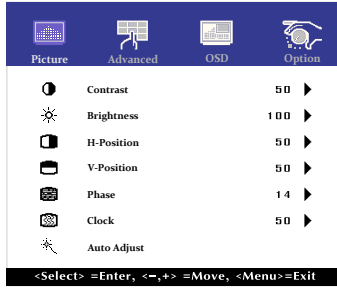

- 2 Select the Menu item which contains the adjustment icon relating to the adjustment you want to make. Use the SELECT Button to highlight the desired adjustment icon.
- 3 Use the  $\Delta$  /  $\nabla$  Buttons to make the appropriate adjustment or setting.
- 4 Press the MENU Button to leave the menu, and the settings you just made would be automatically saved.

For example, to correct for vertical position, select Menu item of Picture. Then, select V-Position by using the SELECT Button.

Use the  $\Delta$  /  $\nabla$  Buttons to change the vertical position settings. The vertical position of the overall display should be changing accordingly while you are doing this.

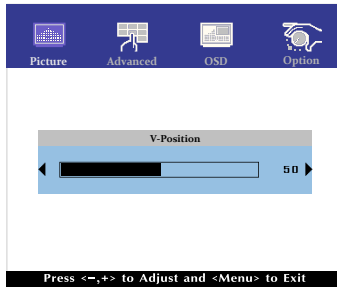

Press the MENU Button lastly, it ends, all changes are saved in the memory.

## NOTE

- When button operations are aborted during adjustment, On-Screen Display disappears when the time set for the OSD Timeout has passed.
- MENU button can be used to return previous menu item.
- Any changes are automatically saved in the memory when the On Screen Display disappears. Turning off the power should be avoided while using the Menu.
- Adjustments for H/V-Position, Clock and Phase are saved for each signal timing. Except for these adjustments, all other adjustments have only one setting which applies to all signal timings.

## Direct

### ● LOCK MODE:

Simultaneously press the MENU button and the ▽ button when an image is displayed through VGA, HDMI or DisplayPort.

\* The OSD menu is not displayed when the OSD is locked. Press the MENU button and the ▽ button simultaneously again.

The following OSD menu is displayed.

Adjustment Item	Problem / Option	
POWER	Active	The POWER SWITCH is Locked.
	Inactive	The POWER SWITCH is Unlocked.
OSD	Active	The OSD menu is Locked.
	Inactive	The OSD menu is Unlocked.

**NOTE** When the lock function is enabled and there is no signal (standby mode), pressing the menu button displays the input selection menu and enables input selection.

### ● TOUCH FUNCTION DISABLE:

ON: Pressing and holding of the MENU Button and the SELECT Button at the same time when the Menu is not displayed, message "TOUCH DISABLE" will appear on the top right corner.

OFF: Pressing and holding of the MENU Button and the SELECT Button at the same time for about 5 seconds when the Menu is not displayed, till "TOUCH DISABLE" disappears.

# ADJUSTMENT MENU CONTENTS

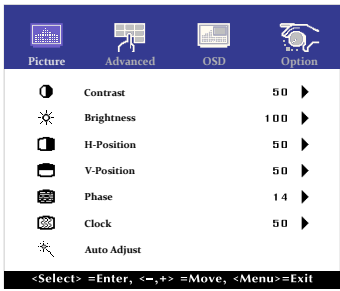
Adjustment Item	Problem / Option	Button to Press
<b>Picture</b> 		
Contrast <b>Direct</b>	Too dull Too intense	 
Brightness* <sup>1</sup> <b>Direct</b>	Too dark Too bright	 
H-Position* <sup>4</sup>	Too left Too right	 
V-Position* <sup>4</sup>	Too low Too high	 
Phase* <sup>2,4</sup>	To correct flickering text or lines	 
Clock* <sup>2,4</sup>	Too narrow Too wide	 
Auto Adjust* <sup>3,4</sup>	Adjust H/V-Position, Clock and Phase automatically.	

\*<sup>1</sup> Adjust the Brightness when you are using the monitor in a dark room and feel the screen is too bright.

\*<sup>2</sup> See page 19 for SCREEN ADJUSTMENTS.



\*<sup>3</sup> For best results, use the Auto Adjust in conjunction with the adjustment pattern. See page 19 for SCREEN ADJUSTMENTS.

\*<sup>4</sup> Only Analog Input.

## Direct

You can skip the Menu items and directly display an adjustment scale by using the following button operations.

- Contrast: Press the Button when the Menu is not displayed.
- Brightness: Press the Button when the Menu is not displayed.

Adjustment Item	Problem / Option		Button to Press			
Color Temp	5500	Greenish white				
	6500	Reddish white				
	7500	Yellowish white				
	9300	Bluish white				
	User	<table border="1"> <tr><td>Red</td></tr> <tr><td>Green</td></tr> <tr><td>Blue</td></tr> </table>	Red	Green	Blue	Too weak Too strong
Red						
Green						
Blue						
Sharpness	You can change the picture quality from 0 to 100 (soft to sharp). Press the  Button to change the picture quality in numerical order. Press the  Button to change the picture quality in reverse numerical order. Adjust the picture quality at resolutions of less 1280 x 800(ProLite TF1015MC) / 1024 x 768(ProLite TF1215MC / ProLite TF1515MC) / 1920 x 1080(ProLite TF1615MC / ProLite TF2215MC / ProLite TF2415MC). You can change the picture quality.					



Advanced

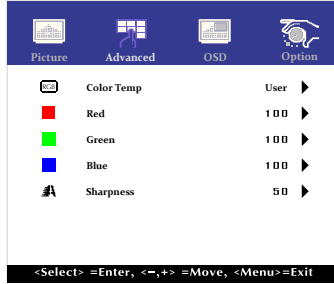

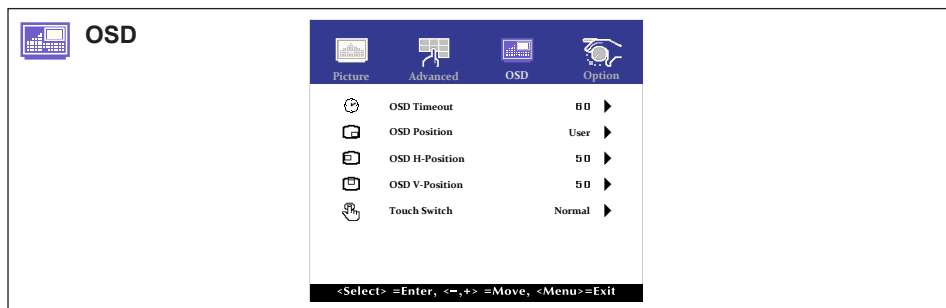

Adjustment Item	Problem / Option	Button to Press
OSD Timeout	You can set the OSD display duration time between 5 and 60 seconds.	
OSD Position	You can set the OSD position. User (Upper left / Lower left / Upper right / Lower right / Center)	
OSD H-Position	OSD is too left	
	OSD is too right	
OSD V-Position	OSD is too low	
	OSD is too high	
Touch Switch *	Normal	Normal touch (with bare hands or stylus device)
	Glove	Touch with gloved hand (Supports thickness +2mm)
	Through-Glass	Touch through glass (Supports thickness +6mm)

\* Please turn on the power and set the Touch Switch after the monitor installation is completed. Turning on the power and setting the Touch Switch before the monitor installation may cause misalignment or malfunction of the touch calibration.  
The maximum touch points change depending on the selected mode.

Max. touch points	
Off(Normal)	10
Glove	5
Through-Glass	2

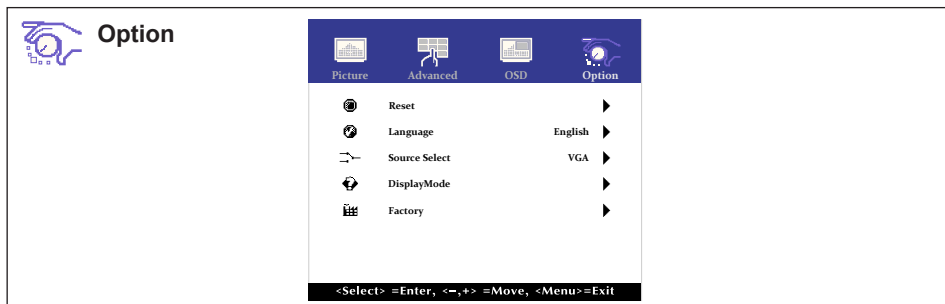

Adjustment Item	Problem / Option		Button to Press	
Reset	No	Return to Menu.		
	Yes	Factory-preset data is restored.		
Language	English	English	Español	Spanish
	Français	French	日本語	Japanese
	Deutsch	German	繁體中	Traditional Chinese
	Italiano	Italian	簡中	Simplified Chinese
Source Select <b>Direct</b>	Auto	Search for an available input source and select automatically.		
	VGA	Select the analog input.		
	HDMI	Select the digital(HDMI) input.		
	DP	Select the digital(DisplayPort) input.		
<p><b>NOTE</b> However it will automatically be selected when just one source is using. In Standby Mode input switching is disabled. Input source is fixed, not selected automatically when VGA, HDMI and DisplayPort which are selected.</p>				
Display Mode	Displays information regarding the current input signal coming from the graphic card in your computer.			
	<p><b>NOTE</b> See your graphic card user guide for more information about changing the resolution and refresh.</p>			
Factory	This function is for service personnel only and therefore the operation is not available.			

**Direct**

You can skip the Menu items and directly display an option setting screen by using the following button operations.

- Source Select : Pressing and holding of the SELECT Button for about 5 seconds when the Menu is not displayed.  
By pressing the SELECT Button during Standby Mode, the Source Selected menu will be displayed.

## SCREEN ADJUSTMENTS

Adjust the image by following the procedure below to get the desired picture when selecting Analog input.

- The screen adjustments described in this manual are designed to set image position and minimize flicker or blur for the particular computer in use.
- ProLite TF1015MC is designed to provide the best performance at resolution of 1280 × 800, but can not provide the best at resolutions of less than 1280 × 800 because the picture is automatically stretched to fit the full screen. It is recommended to operate at resolution of 1024 × 768 in normal use.
- ProLite TF1215MC / ProLite TF1515MC is designed to provide the best performance at resolution of 1024 × 768, but can not provide the best at resolutions of less than 1024 × 768 because the picture is automatically stretched to fit the full screen. It is recommended to operate at resolution of 1024 × 768 in normal use.
- ProLite TF1615MC / ProLite TF2215MC / ProLite TF2415MC are designed to provide the best performance at resolution of 1920 × 1080, but can not provide the best at resolutions of less than 1920 × 1080 because the picture is automatically stretched to fit the full screen. It is recommended to operate at resolution of 1920 × 1080 in normal use.
- Displayed text or lines will be blurred or irregular in thickness when the picture is stretched due to the screen enlargement process.
- It is preferable to adjust the image position and frequency with the monitor controls, rather than the computer software or utilities.
- Perform adjustments after a warm-up period of at least thirty minutes.
- Additional adjustments may be required after the Auto Adjust depending on the resolution or signal timing.
- The Auto Adjust may not work correctly when displaying the picture other than the screen adjustment pattern. In this case, manual adjustments are required.

There are two ways to adjust the screen. One way is automatic adjustment for H/V-Position, Clock and Phase. The other way is performing each adjustment manually.

Perform the Auto Adjust first when the monitor is connected to a new computer, or resolution is changed. If the screen has a flicker or blur, or the picture does not fit in the display area after performing the Auto Adjust, manual adjustments are required. Both adjustments should be made by using the screen adjustment pattern (Test.bmp) obtained via the iiyama web site (<https://iiyama.com>).

Adjust the image by following the procedure below to get the desired picture.

This manual explains adjustment under Windows® OS.

- ① **Display the picture at the optimum resolution.**
- ② **Enter the Test.bmp (screen adjustment pattern) to wallpaper.**

### NOTE

- Consult the appropriate documentation for doing this.
- Set the display position to center in the wallpaper setting dialogue box.

[Adjustment pattern]

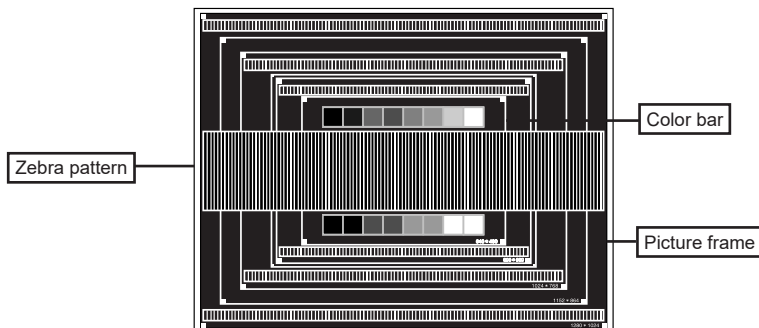

- ③ Perform the auto adjustment. (Auto Adjust)
- ④ Adjust the image manually by following procedure below when the screen has a flicker or blur, or the picture does not fit in the display area after performing the Auto Adjust.
- ⑤ Adjust the V-Position so that the top and bottom of the picture frame will fit to the display area.

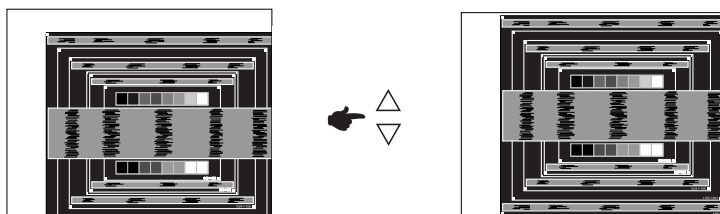

- ⑥ 1) Adjust the H-Position so that the left side of the picture frame will move to the left edge of the display area.

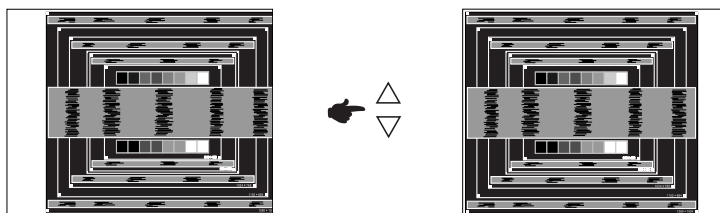

- 2) Stretch the right side of the picture frame to the right edge of the display area by adjusting the Clock.

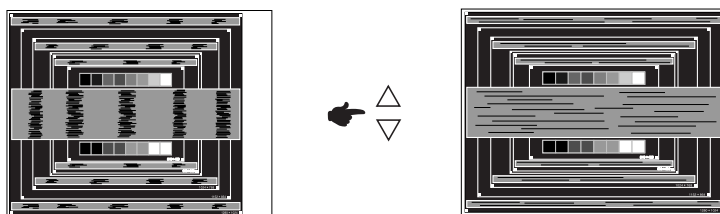
**NOTE**

- When the left side of the picture frame moves apart from the left edge of the display area during the Clock adjustment, adjust steps 1) and 2).
- Another way to make the Clock adjustment is to correct the vertical wavy lines in the zebra pattern.
- The picture may flicker during the Clock, H/V-Position adjustment.
- In case the picture frame is bigger or smaller than the data display area after the Clock adjustment, repeat steps from ③.



- ⑦ **Adjust the Phase to correct horizontal wavy noise, flicker or blur in the zebra pattern.**

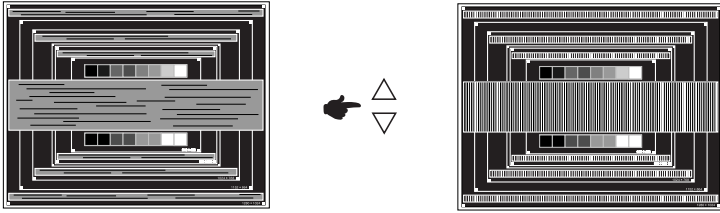

**NOTE**

- In case the strong flicker or blurs remain on a part of the screen, repeat steps ⑥ and ⑦ because the Clock may not be adjusted correctly.
- Adjust the H-Position after the Phase adjustment if the horizontal position moves during the adjustment.

- ⑧ **Adjust the Brightness and Color to get the desired picture after you complete the Clock and Phase adjustments.**

**Put back your favorite wallpaper.**

## STANDBY FEATURE

This product features the standby function. When your computer is not in use, the standby feature will automatically reduce the power consumption of your monitor.

There is a standby step the monitor takes as described below. The standby function, including any timer settings is configured by the operating system. Check your operating system manual for information on how this can be configured.

### ■ Standby Mode

When the video signal from the computer is off, the monitor enters into Standby Mode which reduces the power consumption to less than 1.5W\*. The screen becomes dark. From Standby Mode, the image reappears in several seconds when either the keyboard or the mouse are touched again.

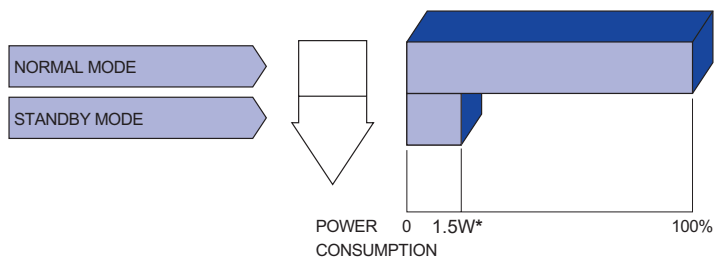

\* When the USB devices are not connected.

# TROUBLE SHOOTING

If the monitor fails to operate correctly, please follow the steps below for a possible solution.

1. Perform the adjustments described in OPERATING THE MONITOR, depending on the problem you have. If the monitor does not get a picture, skip to 2.
2. Consult the following items if you cannot find an appropriate adjustment item in OPERATING THE MONITOR or if the problem persists.
3. If you are experiencing a problem which is not described below or you cannot correct the problem, discontinue using the monitor and contact your dealer or iiyama service center for further assistance.

<b>Problem</b>	<b>Check</b>
① The picture does not appear.	<input type="checkbox"/> The AC Adapter is firmly seated in the connector. <input type="checkbox"/> The Power Cable is firmly seated in the socket of the AC Adapter. <input type="checkbox"/> The Power Cable is firmly seated in the socket. <input type="checkbox"/> The Power Switch is turned ON. <input type="checkbox"/> The AC socket is live. Please check with another piece of equipment. <input type="checkbox"/> If the blank screen saver is in active mode, touch the keyboard or the mouse. <input type="checkbox"/> Increase the Contrast and/or Brightness. <input type="checkbox"/> The computer is ON. <input type="checkbox"/> The Signal Cable is properly connected. <input type="checkbox"/> The signal timing of the computer is within the specification of the monitor. <input type="checkbox"/> If the monitor is in standby mode, touch the keyboard or the mouse.
② The screen is not synchronized.	<input type="checkbox"/> The Signal Cable is properly connected. <input type="checkbox"/> The signal timing of the computer is within the specification of the monitor.
③ The screen position is not in the center.	<input type="checkbox"/> The signal timing of the computer is within the specification of the monitor.
④ The screen is too bright or too dark.	<input type="checkbox"/> The video output level of the computer is within the specification of the monitor.
⑤ The screen is shaking.	<input type="checkbox"/> The power voltage is within the specification of the monitor. <input type="checkbox"/> The signal timing of the computer is within the specification of the monitor.
⑥ The touch screen shows no response.	<input type="checkbox"/> The USB Cable is firmly seated in the socket. <input type="checkbox"/> Touch screen driver software is installed.
⑦ The touch position does not deviate.	<input type="checkbox"/> The calibration function set up correctly.

# RECYCLING INFORMATION

For better environment protection please don't dispose your monitor.  
Please visit our web site: <https://iiyama.com> for monitor recycling.

# APPENDIX

Design and specifications are subject to change without prior notice.

## SPECIFICATIONS : ProLite TF1015MC-B2 B

Touch Screen	Technology	Projected capacitive 10pt touch
	Light transmission	90%
	Communication system	USB
	Surface finish	Anti fingerprint coating
Size Category		10.1"
LCD Panel	Panel technology	MVA
	Size	Diagonal: 10.1" (25.7cm)
	Pixel pitch	0.1695mm H × 0.1695mm V
	Brightness	500cd/m <sup>2</sup> (Typical: without Touch panel), 450cd/m <sup>2</sup> (Typical: with Touch panel), 280cd/m <sup>2</sup> (Default / Energy Saving, with Touch panel)
	Contrast ratio	1300 : 1 (Typical)
	Viewable angle	Horizontal : 170 degrees, Vertical: 170 degrees (Typical)
	Response time	25ms (Black, White, Black Typical)
Display Colors		Approx.16.2M
Sync Frequency		Horizontal: 31.4-49.7kHz, Vertical: 60Hz
Maximum Resolution		1280 × 800, 1.0 MegaPixels
Input Connector		VGA, HDMI, DisplayPort
Input Sync Signal		Separate sync: TTL, Positive or Negative
Input Video Signal		Analog: 0.7Vp-p (Standard), 75Ω, Positive Digital: HDMI, DisplayPort
Headphone connector		ø 3.5mm mini jack (Stereo)
External control pad Connector		RJ45
Maximum Screen Size		216.96mm W × 135.60mm H / 8.5" W × 5.3" H
Power Source		12VDC, 1A
AC Adapter (accessory)		Input: 100-240VAC, 50/60Hz or 50-60Hz
Power Consumption* <sup>1</sup>		10W typical Standby mode: 1.5W maximum, Off mode: 0.3W maximum
Dimensions / Net Weight		260.5 × 183.5 × 39.5mm / 10.3 × 7.2 × 1.5" (W×H× <sup>3</sup> D) 1.4kg / 3.1lbs (Excluding the AC Adapter)
Environmental Considerations		Operating: Temperature 0 to 40°C / 32 to 104°F Humidity 20 to 80% (No condensation) Storage: Temperature -20 to 60°C / -4 to 140°F Humidity 10 to 90% (No condensation)
Approvals		CE, UKCA, EAC, cULus, IP65* <sup>2</sup>

### NOTE

\*<sup>1</sup> When the USB devices are not connected.

\*<sup>2</sup> IP65 Standard Compliant : Only front face

\*<sup>3</sup> Excluding the Cable cover.

## SPECIFICATIONS : ProLite TF1015MC-B3 / ProLite TF1015MC-B3 R

ENGLISH

Touch Screen	Technology	Projected capacitive 10pt touch
	Light transmission	85%
	Communication system	USB
	Surface finish	Anti fingerprint coating
Size Category		10.1"
LCD Panel	Panel technology	IPS (In-Plane-Switching)
	Size	Diagonal: 10.1" (25.7cm)
	Pixel pitch	0.1695mm H × 0.1695mm V
	Brightness	500cd/m <sup>2</sup> (Typical: without Touch panel), 425cd/m <sup>2</sup> (Typical: with Touch panel), 350cd/m <sup>2</sup> (Default / Energy Saving, with Touch panel)
	Contrast ratio	800 : 1 (Typical)
	Viewable angle	Horizontal : 178 degrees, Vertical: 178 degrees (Typical)
	Response time	29ms (Black, White, Black Typical)
Display Colors		Approx. 16.7M
Sync Frequency		Horizontal: 30.0-49.7kHz, Vertical: 60Hz
Maximum Resolution		1280 × 800, 1.0 MegaPixels
Input Connector		VGA, HDMI, DisplayPort
Input Sync Signal		Separate sync: TTL, Positive or Negative
Input Video Signal		Analog: 0.7Vp-p (Standard), 75Ω, Positive Digital: HDMI, DisplayPort
Headphone connector		ø 3.5mm mini jack (Stereo)
External control pad Connector		RJ45
Maximum Screen Size		216.96mm W × 135.60mm H / 8.5" W × 5.3" H
Power Source		12VDC, 1A
AC Adapter (accessory)		Input: 100-240VAC, 50/60Hz or 50-60Hz
Power Consumption* <sup>1</sup>		6W typical Standby mode: 1.5W maximum, Off mode: 0.3W maximum
Dimensions / Net Weight		260.5 × 183.5 × 39.5mm / 10.3 × 7.2 × 1.5" (W×H* <sup>3</sup> ×D) 1.4kg / 3.1lbs (Excluding the AC Adapter)
Environmental Considerations		Operating: Temperature 0 to 40°C / 32 to 104°F Humidity 20 to 80% (No condensation) Storage: Temperature -20 to 60°C / -4 to 140°F Humidity 10 to 90% (No condensation)
Approvals		CE, UKCA, EAC, cULus, IP65* <sup>2</sup>

**NOTE** \*<sup>1</sup> When the USB devices are not connected.

\*<sup>2</sup> IP65 Standard Compliant : Only front face

\*<sup>3</sup> Excluding the Cable cover.

## SPECIFICATIONS : ProLite TF1215MC-B1 A / ProLite TF1215MC-B1 B

		ProLite TF1215MC-B1 A	ProLite TF1215MC-B1 B
Touch Screen	Technology	Projected capacitive 10pt touch	
	Light transmission	>85%	
	Communication system	USB	
	Surface finish	Anti fingerprint coating	
Size Category		12.1"	
LCD Panel	Panel technology	IPS technology	
	Size	Diagonal: 12.1" (31.0cm)	
	Pixel pitch	0.24mm H × 0.24mm V	
	Brightness	600cd/m <sup>2</sup> (Typical: without Touch panel), 510cd/m <sup>2</sup> (Typical: with Touch panel)	
		205cd/m <sup>2</sup> (Default / Energy Saving, with Touch panel)	180cd/m <sup>2</sup> (Default / Energy Saving, with Touch panel)
	Contrast ratio	1000 : 1 (Typical)	
	Viewable angle	Horizontal : 178 degrees, Vertical: 178 degrees (Typical)	
Response time	25ms (Black, White, Black Typical)		
Display Colors		Approx.16.2M	
Sync Frequency		Horizontal: 31.4-60.0kHz, Vertical: 57-63Hz	
Maximum Resolution		1024 × 768, 0.8 MegaPixels	
Input Connector		VGA, HDMI, DisplayPort	
Input Sync Signal		Separate sync: TTL, Positive or Negative	
Input Video Signal		Analog: 0.7Vp-p (Standard), 75Ω, Positive Digital: HDMI, DisplayPort	
Headphone connector		ø 3.5mm mini jack (Stereo)	
External control pad Connector		RJ45	
Maximum Screen Size		245.76mm W × 184.32mm H / 9.7" W × 7.2" H	
Power Source		12VDC, 1.5A	
AC Adapter (accessory)		Input: 100-240VAC, 47-63Hz	
Power Consumption* <sup>1</sup>		10W typical Standby mode: 1.5W maximum, Off mode: 0.3W maximum	
Dimensions / Net Weight		308.5 × 248.0 × 41.5mm / 12.1 × 9.8 × 1.6" (W×H× <sup>3</sup> D) 2.09kg / 4.6lbs (Excluding the AC Adapter)	
Environmental Considerations		Operating:	Temperature -20 to 60°C / -4 to 140°F Humidity 20 to 80% (No condensation)
		Storage:	Temperature -20 to 60°C / -4 to 140°F Humidity 10 to 90% (No condensation)
Approvals		CE, UKCA, EAC, cULus, IP65* <sup>2</sup>	

- NOTE** \*<sup>1</sup> When the USB devices are not connected.  
\*<sup>2</sup> IP65 Standard Compliant : Only front face  
\*<sup>3</sup> Excluding the Cable cover.

## SPECIFICATIONS : ProLite TF1515MC-B2 B / ProLite TF1515MC-B2 C

		ProLite TF1515MC-B2 B	ProLite TF1515MC-B2 C
Touch Screen	Technology	Projected capacitive 10pt touch	
	Light transmission	90%	
	Communication system	USB	
	Surface finish	Anti fingerprint coating	
Size Category		15"	
LCD Panel	Panel technology	TN	
	Size	Diagonal: 15" (38.0cm)	
	Pixel pitch	0.297mm H × 0.297mm V	
	Brightness	350cd/m <sup>2</sup> (Typical: without Touch panel), 315cd/m <sup>2</sup> (Typical: with Touch panel)	
		280cd/m <sup>2</sup> (Default / Energy Saving, with Touch panel)	265cd/m <sup>2</sup> (Default / Energy Saving, with Touch panel)
	Contrast ratio	800 : 1 (Typical)	
	Viewable angle	Horizontal : 160 degrees, Vertical: 150 degrees (Typical)	
Response time	8ms (Black, White, Black Typical)		
Display Colors		Approx.16.2M	
Sync Frequency		Horizontal: 31.4-60.0kHz, Vertical: 56-75Hz	
Maximum Resolution		1024 × 768, 0.8 MegaPixels	
Input Connector		VGA, HDMI, DisplayPort	
Input Sync Signal		Separate sync: TTL, Positive or Negative	
Input Video Signal		Analog: 0.7Vp-p (Standard), 75Ω, Positive Digital: HDMI, DisplayPort	
Headphone connector		ø 3.5mm mini jack (Stereo)	
External control pad Connector		RJ45	
Maximum Screen Size		304.1mm W × 228.1mm H / 12.0" W × 9.0" H	
Power Source		12VDC, 1.5A	
AC Adapter (accessory)		Input: 100-240VAC, 50/60Hz or 50-60Hz	
Power Consumption*1		16W typical Standby mode: 1.5W maximum, Off mode: 0.3W maximum	
Dimensions / Net Weight		364.0 × 291.0 × 41.5mm / 14.3 × 11.5 × 1.6" (W×H×D) 2.9kg / 6.4lbs (Excluding the AC Adapter)	
Environmental Considerations		Operating: Temperature 0 to 40°C / 32 to 104°F Humidity 20 to 80% (No condensation) Storage: Temperature -20 to 60°C / -4 to 140°F Humidity 10 to 90% (No condensation)	
Approvals		CE, UKCA, EAC, cULus, IP65*2	

**NOTE** \*1 When the USB devices are not connected.

\*2 IP65 Standard Compliant : Only front face



## SPECIFICATIONS : ProLite TF1615MC-B1

Touch Screen	Technology	Projected capacitive 10pt touch
	Light transmission	90%
	Communication system	USB
	Surface finish	Anti fingerprint coating
Size Category		15.6"
LCD Panel	Panel technology	IPS (In-Plane-Switching)
	Size	Diagonal: 15.6" (39.5cm)
	Pixel pitch	0.17925mm H × 0.17925mm V
	Brightness	450cd/m <sup>2</sup> (Typical: without Touch panel), 405cd/m <sup>2</sup> (Typical: with Touch panel), 245cd/m <sup>2</sup> (Default / Energy Saving, with Touch panel)
	Contrast ratio	1000 : 1 (Typical)
	Viewable angle	Horizontal : 178°, Vertical: 178° (Typical)
	Response time	25ms (Typical)
Display Colors		Approx.16.2M
Sync Frequency		Horizontal: 31.5-67.5kHz, Vertical: 56-60Hz
Maximum Resolution		1920 × 1080, 2.1 MegaPixels
Input Connector		VGA, HDMI, DisplayPort
Input Sync Signal		Separate sync: TTL, Positive or Negative
Input Video Signal		Analog: 0.7Vp-p (Standard), 75Ω, Positive Digital: HDMI, DisplayPort
Headphone connector		ø 3.5mm mini jack (Stereo)
External control pad Connector		RJ45
Maximum Screen Size		345.2mm W × 194.6mm H / 13.6" W × 7.7" H
Power Source		12VDC, 1.5A
AC Adapter (accessory)		Input: 100-240VAC, 50/60Hz or 50-60Hz
Power Consumption* <sup>1</sup>		18W typical Standby mode: 1.5W maximum, Off mode: 0.3W maximum
Dimensions / Net Weight		398.5 × 246.0 × 42.0mm / 15.7 × 9.7 × 1.6" (W×H×D) 2.5kg / 5.4lbs(Excluding the AC Adapter)
Environmental Considerations		Operating: Temperature 0 to 40°C / 32 to 104°F Humidity 20 to 80% (No condensation) Storage: Temperature -20 to 60°C / -4 to 140°F Humidity 10 to 90% (No condensation)
Approvals		CE, UKCA, EAC, cULus, IP65* <sup>2</sup>

### NOTE

\*<sup>1</sup> When the USB devices are not connected.

\*<sup>2</sup> IP65 Standard Compliant : Only front face

## SPECIFICATIONS : ProLite TF2215MC-B2 B

Touch Screen	Technology	Projected capacitive 10pt touch
	Light transmission	90%
	Communication system	USB
	Surface finish	Anti fingerprint coating
Size Category		22"
LCD Panel	Panel technology	IPS
	Size	Diagonal: 21.5" (54.6cm)
	Pixel pitch	0.24795mm H × 0.24795mm V
	Brightness	350cd/m <sup>2</sup> (Typical: without Touch panel), 315cd/m <sup>2</sup> (Typical: with Touch panel), 200cd/m <sup>2</sup> (Default / Energy Saving, with Touch panel)
	Contrast ratio	1000 : 1 (Typical)
	Viewable angle	Horizontal: 178 degrees, Vertical: 178 degrees (Typical)
	Response time	14ms (Black, White, Black Typical)
Display Colors		Approx. 16.7M
Sync Frequency		Horizontal: 31.4-82.0kHz, Vertical: 56-75Hz
Maximum Resolution		1920 × 1080, 2.1 MegaPixels
Input Connector		VGA, HDMI, DisplayPort
Input Sync Signal		Separate sync: TTL, Positive or Negative
Input Video Signal		Analog: 0.7Vp-p (Standard), 75Ω, Positive Digital: HDMI, DisplayPort
Headphone connector		ø 3.5mm mini jack (Stereo)
External control pad Connector		RJ45
Maximum Screen Size		476.064mm W × 267.786mm H / 18.7" W × 10.5" H
Power Source		12VDC, 2A
AC Adapter (accessory)		Input: 100-240VAC, 50/60Hz or 50-60Hz
Power Consumption* <sup>1</sup>		19W typical Standby mode: 1.5W maximum, Off mode: 0.3W maximum
Dimensions / Net Weight		520.0 × 315.0 × 42.5mm / 20.5 × 12.5 × 1.7" (W×H×D) 4.4kg / 9.7lbs (Excluding the AC Adapter)
Environmental Considerations		Operating: Temperature 0 to 40°C / 32 to 104°F Humidity 20 to 80% (No condensation) Storage: Temperature -20 to 60°C / -4 to 140°F Humidity 10 to 90% (No condensation)
Approvals		CE, UKCA, EAC, cULus, IP65* <sup>2</sup>

**NOTE** \*<sup>1</sup> When the USB devices are not connected.

\*<sup>2</sup> IP65 Standard Compliant : Only front face

## SPECIFICATIONS : ProLite TF2415MC-B2 B

Touch Screen	Technology	Projected capacitive 10pt touch
	Light transmission	90%
	Communication system	USB
	Surface finish	Anti fingerprint coating
Size Category		23.8"
LCD Panel	Panel technology	VA
	Size	Diagonal: 23.8" (60.5cm)
	Pixel pitch	0.2745mm H × 0.2745mm V
	Brightness	350cd/m <sup>2</sup> (Typical: without Touch panel), 315cd/m <sup>2</sup> (Typical: with Touch panel), 175cd/m <sup>2</sup> (Default / Energy Saving, with Touch panel)
	Contrast ratio	3000 : 1 (Typical)
	Viewable angle	Horizontal: 178 degrees, Vertical: 178 degrees (Typical)
	Response time	16ms (Black, White, Black Typical)
Display Colors		Approx. 16.7M
Sync Frequency		Horizontal: 31.4-82.0kHz, Vertical: 56-75Hz
Maximum Resolution		1920 × 1080, 2.1 MegaPixels
Input Connector		VGA, HDMI, DisplayPort
Input Sync Signal		Separate sync: TTL, Positive or Negative
Input Video Signal		Analog: 0.7Vp-p (Standard), 75Ω, Positive Digital: HDMI, DisplayPort
Headphone connector		ø 3.5mm mini jack (Stereo)
External control pad Connector		RJ45
Maximum Screen Size		527.04mm W × 296.46mm H / 20.7" W × 11.7" H
Power Source		12VDC, 2.5A
AC Adapter (accessory)		Input: 100-240VAC, 50/60Hz or 50-60Hz
Power Consumption* <sup>1</sup>		25W typical Standby mode: 1.5W maximum, Off mode: 0.3W maximum
Dimensions / Net Weight		575.0 × 347.0 × 42.5mm / 22.6 × 13.7 × 1.7" (W×H×D) 5.8kg / 12.8lbs (Excluding the AC Adapter)
Environmental Considerations		Operating: Temperature 0 to 40°C / 32 to 104°F Humidity 20 to 80% (No condensation) Storage: Temperature -20 to 60°C / -4 to 140°F Humidity 10 to 90% (No condensation)
Approvals		CE, UKCA, EAC, cULus, IP65* <sup>2</sup>

### NOTE

\*<sup>1</sup> When the USB devices are not connected.

\*<sup>2</sup> IP65 Standard Compliant : Only front face

**DIMENSIONS : ProLite TF1015M**

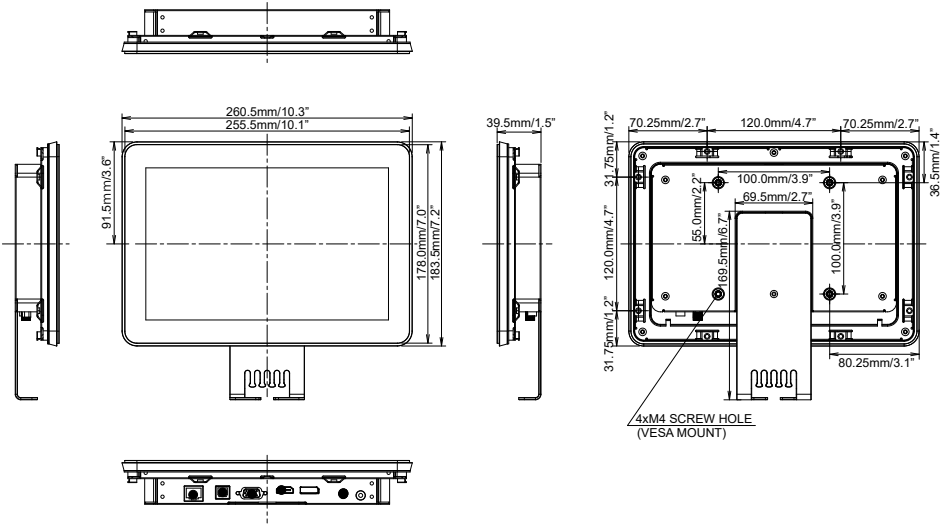

**DIMENSIONS : ProLite TF1215M**

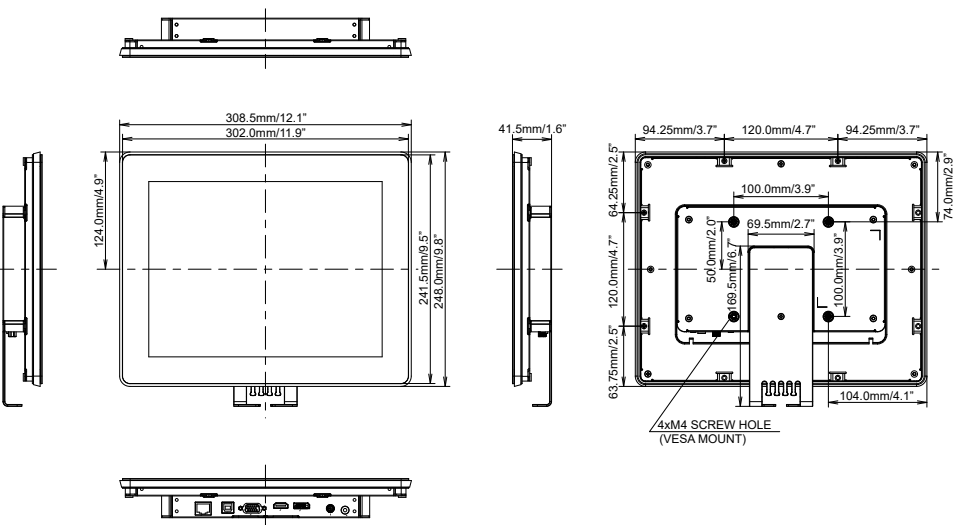

## DIMENSIONS : ProLite TF1515MC

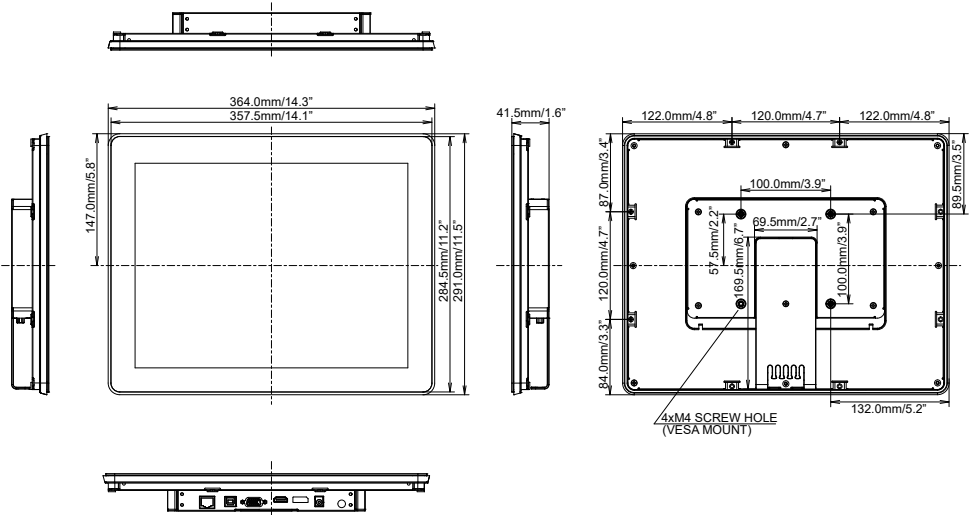

ENGLISH

## DIMENSIONS : ProLite TF1615MC

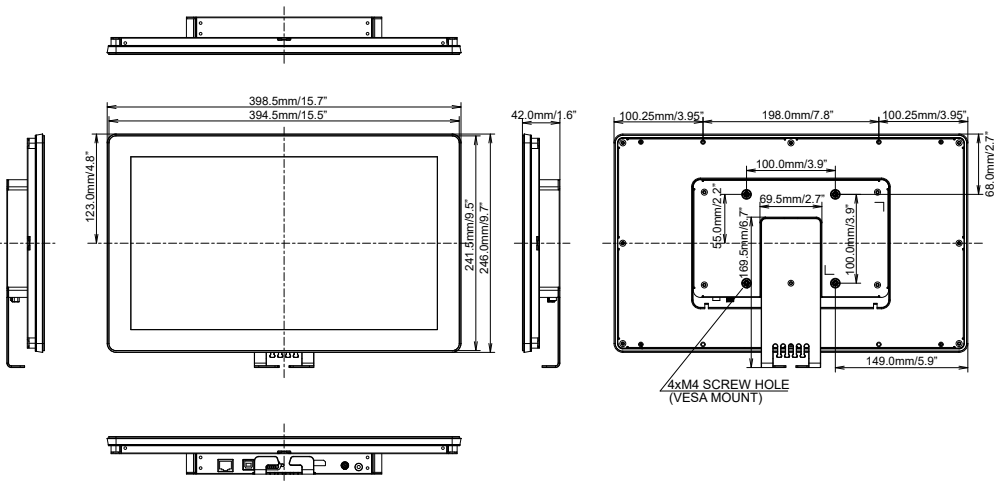

## DIMENSIONS : ProLite TF2215MC

ENGLISH

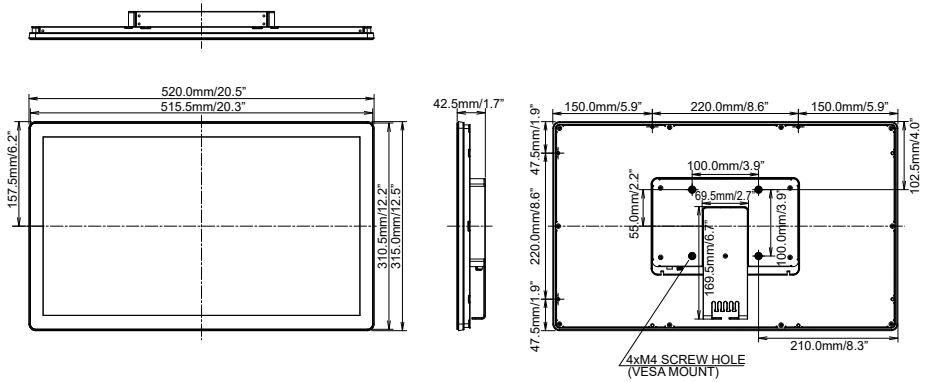

## DIMENSIONS : ProLite TF2415MC

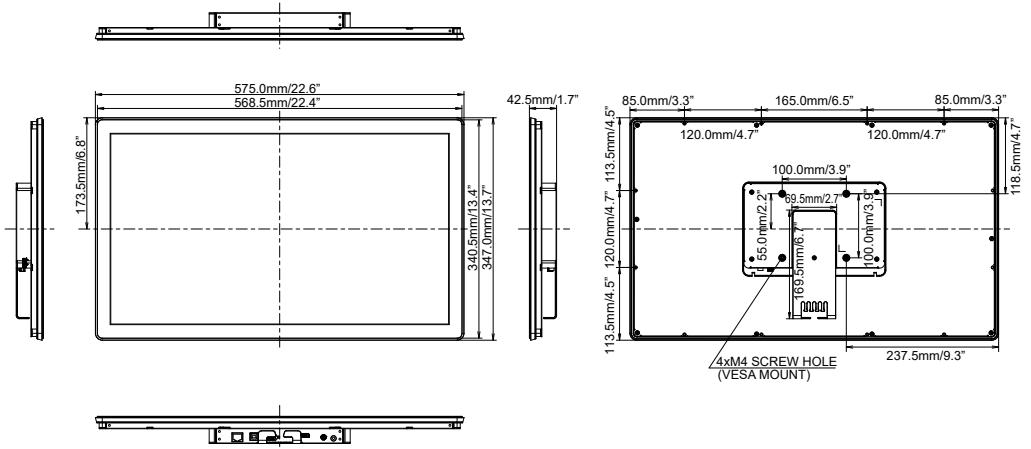

## COMPLIANT TIMING : ProLite TF1015MC

Video Mode	Horizontal Frequency	Vertical Frequency	Dot Clock
640 × 480	31.469kHz	59.940Hz	25.175MHz
800 × 600	37.879kHz	60.317Hz	40.000MHz
1024 × 768	48.363kHz	60.004Hz	65.000MHz
1280 × 800	49.702kHz	59.910Hz	83.500MHz

## COMPLIANT TIMING : ProLite TF1215MC / ProLite TF1515MC / ProLite TF1615MC / ProLite TF2215MC / ProLite TF2415MC

Video Mode	Horizontal Frequency	Vertical Frequency	Dot Clock	
640 × 480	31.469kHz	59.940Hz	25.175MHz	
	37.500kHz	75.000Hz	31.500MHz	*1
	37.861kHz	72.809Hz	31.500MHz	*1
800 × 600	35.156kHz	56.250Hz	36.000MHz	
	37.879kHz	60.317Hz	40.000MHz	
	46.875kHz	75.000Hz	49.500MHz	*1
	48.077kHz	72.188Hz	50.000MHz	*1
1024 × 768	48.363kHz	60.004Hz	65.000MHz	
	56.476kHz	70.069Hz	75.000MHz	*1
	60.023kHz	75.029Hz	78.750MHz	*1
1280 × 1024	63.981kHz	60.020Hz	108.000MHz	*2
	79.976kHz	75.025Hz	135.000MHz	*2,3
1280 × 800	49.702kHz	59.910Hz	83.500MHz	*2
1680 × 1050	65.290kHz	60.000Hz	146.250MHz	*2
1920 × 1080	66.590kHz	59.930Hz	138.500MHz	*2

**NOTE** \*1 Not compliant to ProLite TF1215MC / ProLite TF1615MC.

\*2 Not compliant to ProLite TF1215MC / ProLite TF1515MC.

\*3 Not compliant to ProLite TF1615MC.