

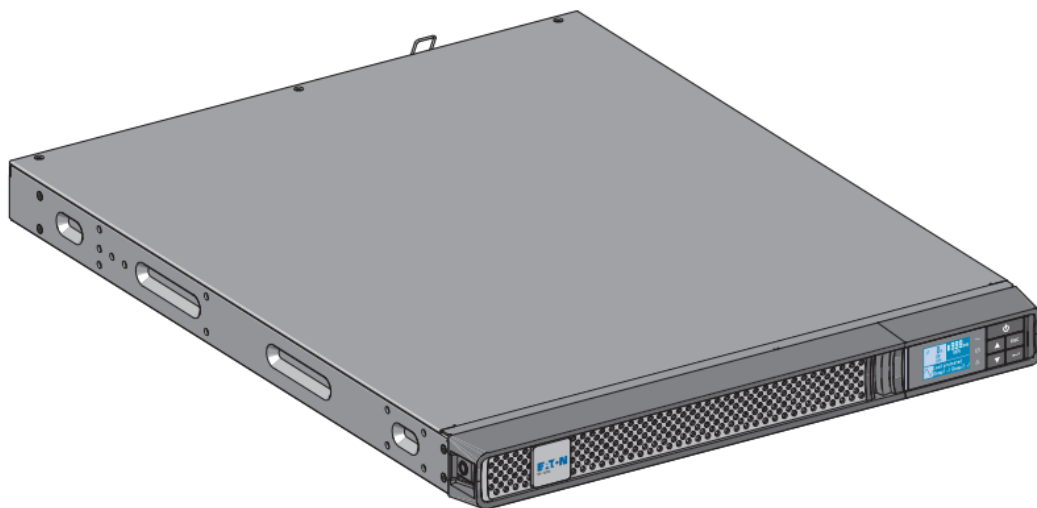

Eaton 5P Rack Gen2

Advanced User Guide



5P650IRG2

5P650IRNG2

5P850IRG2

5P850IRNG2

5P1150IRG2

5P1150IRNG2

5P1550IRG2

5P1550IRNG2

Copyright © 2024 EATON

All rights reserved.

DSD-5P2208

English











Table of Content

1	Special symbols	1
2	Introduction	2
2.1	Environmental protection	2
2.2	Benefits.....	3
3	Presentation.....	4
3.1	Weights and dimensions.....	4
3.2	Standard installation	4
3.3	Rear panel.....	5
3.4	Optional accessories.....	5
4	Installation	6
4.1	Inspecting the equipment	6
4.2	Recommended positions.....	7
4.3	UPS connection.....	8
4.4	Register warranty.....	8
5	Interfaces and communication	8
5.1	Control panel.....	8
5.2	LCD description.....	10
5.3	Display functions.....	11
5.4	User settings.....	12
5.5	Advanced Battery Management +	18
5.6	Communication ports.....	18
5.7	UPS remote control functions	19
5.8	Eaton Intelligent Power Software suite	20
5.9	Cybersecurity	20
6	Operation	20
6.1	Start-up and normal operation	20
6.2	Starting the UPS on battery.....	21
6.3	UPS shutdown.....	21
6.4	Operating modes	21
6.5	Return of AC input power	22
7	UPS maintenance.....	22

7.1	Equipment care.....	22
7.2	Storing the equipment.....	22
7.3	When to replace batteries.....	23
7.4	Replacing batteries	23
7.5	Recycling the used equipment.....	25
8	Troubleshooting.....	26
8.1	Silencing the alarm	26
8.2	Service and support.....	26
9	Specification and technical characteristics.....	26
9.1	Electrical input	26
9.2	Electrical output.....	27
9.3	Battery	28
9.4	Environmental and safety	28
10	Glossary	30

1 Special symbols

The following are examples of symbols used on the UPS or accessories to alert you to important information:

	DANGER: Dangerous voltage levels are present within the UPS. The UPS has its own internal power source (the battery). Consequently, the power outlets may be energized even if the UPS is disconnected from the AC power source.
	Important instructions that must always be followed. CAUTION: Batteries present a risk of energy or electrical shock or burn from high short circuit current. Observe proper precaution. Batteries may contain HIGH VOLTAGE and CORROSIVE, TOXIC and EXPLOSIVE substances.
	Information, advice, help.
	Read the documentation provided.
	Disconnect input plug.
	Before maintenance, first shut down the UPS then disconnect the AC power source, internal and external batteries then discharge capacitors by pressing the ON button and wait 5 minutes.
	This equipment should only be used in a dry indoor environment.
	Operating range of temperature.
	Operating range of humidity.
	The UPS and their batteries must be kept in a ventilated place.

2 Introduction

Thank you for selecting an Eaton 5P Gen2 product to protect your electrical equipment.

The Eaton 5P Gen2 range has been designed with the utmost care. We recommend that you take the time to read this advanced user guide to take full advantage of the many features of your UPS (Uninterruptible Power System).

Before installing your Eaton 5P Gen2, please read the information and safety instructions provided. Follow the instructions in the quick start guide and if necessary, refer to this advance user guide.

To discover the entire range of Eaton products, we invite you to visit our web site at eaton.com or contact your Eaton local representative.

2.1 Environmental protection

Eaton has implemented an environmental-protection policy. Products are developed according to an eco-design approach.

Substances

This product contains no CFC, HCFC or asbestos. This product is compliant with regulations on the restriction of the use of substances in electrical and electronic equipment.

Packaging

To improve waste treatment and facilitate recycling, separate the various packing components.

- Packing materials are recyclable and bear the appropriate identification symbol. 
- The cardboard we use comprises over 50% of recycled cardboard.
- Plastic bags are made of polyethylene.

Materials	Abbreviations	Number in the symbols 
Polyethylene terephthalate	PET	01
High-density polyethylene	HDPE	02
Polyvinyl chloride	PVC	03
Low-density polyethylene	LDPE	04
Polypropylene	PP	05
Polystyrene	PS	06

Follow all local regulations for the disposal of packing materials.

End of life

Eaton will process products at the end of their service life in compliance with local regulations. Eaton works with companies in charge of collecting and eliminating our products at the end of their service life.

Product

The product is made from materials that can be recycled. Dismantling and destruction must take place in compliance with all local regulations concerning waste. At the end of its service life, the product must be transported to a processing center for electrical and electronic waste. eaton.com/recycling

Battery

The product contains lead-acid batteries that must be processed according to applicable local regulations concerning batteries. The battery may be removed to comply with regulations and in view of correct disposal.

2.2 Benefits

The Eaton 5P Gen2 uninterruptible power system (UPS) protects your sensitive electronic equipment from the most common power problems, including power outages, voltage sags, impulsive transients, line noise, and long-term under and over voltage conditions.

Power outages can occur when you least expect it and power quality can be erratic. These power problems have the potential to corrupt critical data, destroy unsaved work sessions, and damage hardware - causing hours of lost productivity and expensive repairs.

With the Eaton 5P Gen2, you can safely eliminate the effects of power disturbances and guard the integrity of your equipment. Providing outstanding performance and reliability, the Eaton 5P Gen2's unique benefits include:

- ABM® technology that uses advanced battery management to increase battery service life, optimize recharge time, and provide a warning before the end of useful battery life.
- ABM+ (Advanced Battery Management) implements a machine learning algorithm providing battery health status.
- Optional connectivity cards with enhanced communication capabilities.
- Remote on/off (ROO) and remote power off (RPO).
- Backed by worldwide agency approvals.

3 Presentation

3.1 Weights and dimensions

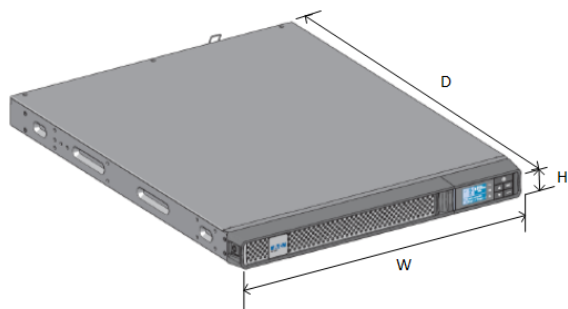

Description (UPS)	Weights (kg / lbs)	Dimensions (mm / inch) D x W x H
5P650IRG2 5P650IRNG2	8.6 / 19	361 x 438 x 43.2 / 14.2 x 17.2 x 1.7
5P850IRG2 5P850IRNG2	13.7 / 30.2	509 x 438 x 43.2 / 20.0 x 17.2 x 1.7
5P1150IRG2 5P1150IRNG2	14.2 / 31.3	509 x 438 x 43.2 / 20.0 x 17.2 x 1.7
5P1550IRG2 5P1550IRNG2	18.7 / 41.2	555 x 438 x 43.2 / 21.9 x 17.2 x 1.7

3.2 Standard installation

3.3 Rear panel

5P650iR

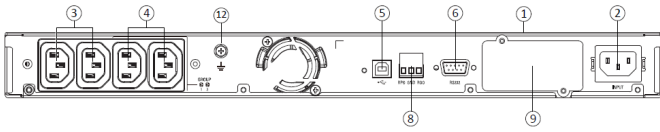

5P850iR

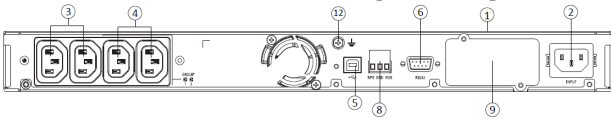

5P1150i

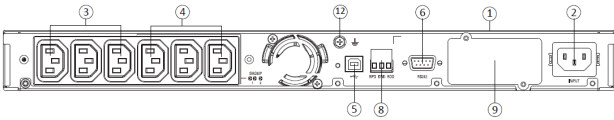

5P1550i

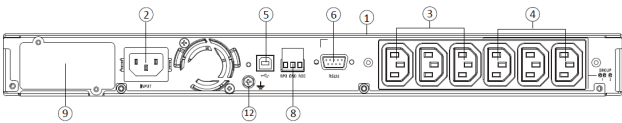

- ① UPS
- ② Input AC power source
- ③ Primary group (critical equipment)
- ④ Outlet group (programmable outlets)
- ⑤ USB communication port
- ⑥ RS232 communication port
- ⑧ Connector for ROO (Remote On/Off) control and RPO (Remote Power Off)
- ⑨ Slot for optional communication card
- ⑫ Ground screw

3.4 Optional accessories

Part number	Description
Network-M2 Network-M3	Eaton Gigabit Network Card (SNMP v1/v3 and IP v4/v6 // Ethernet 10/100/1000BaseT)
INDGW-M2	Eaton Industrial Gateway Card (Modbus TCP / RTU)
Relay-MS	Eaton Relay card (1 x RS232 or 5 x Relay output)
INDRELAY-MS	Eaton Industrial relay card (5x relay outputs with dry contacts for remote alarm information)
EMPDT1H1C2	Environmental Monitoring Probe Gen2 Compatibility : Gigabit Network Card (Network-M2, Network-M3) / Industrial Gateway Card (INDGW-M2) / Eaton ePDU G3/G3+

4.2 Recommended positions

Installation in rack position

Follow steps below for module mounting on the rails.

i The rails and necessary hardware are supplied by Eaton.

Wall installation of models **5P650iR**; **5P850iR**; **5P1150iR**

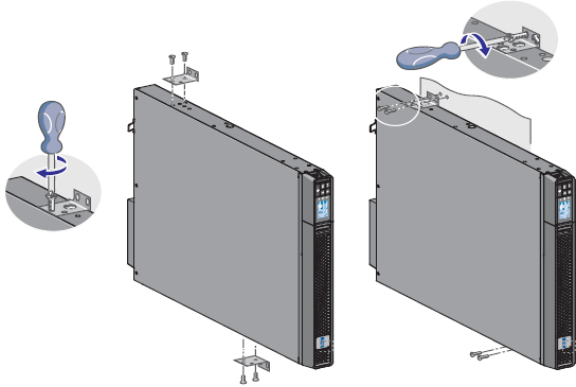

- ① Screw the rail on the back of the rack.
- ② Screw the rail on the front of the rack using the two holes at the bottom.
- ③ Screw the ears plate to the UPS.
- ④ Place the UPS on the rails and screw the ears plate to the top hole of the rail.

Follow steps 1 to 3 for rack installation of **5P650iR** model :

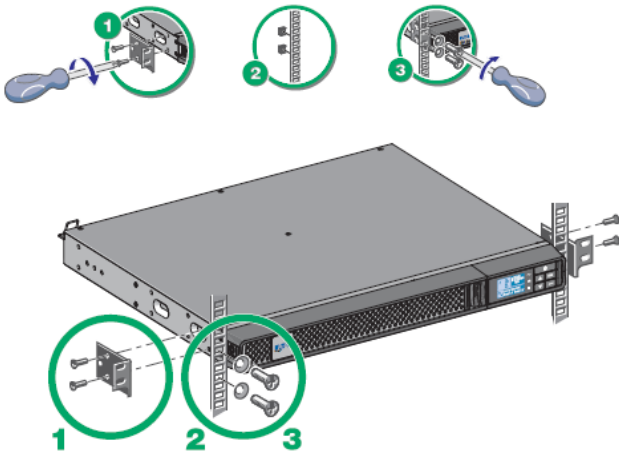

Follow steps 1 to 4 for the other rack models :

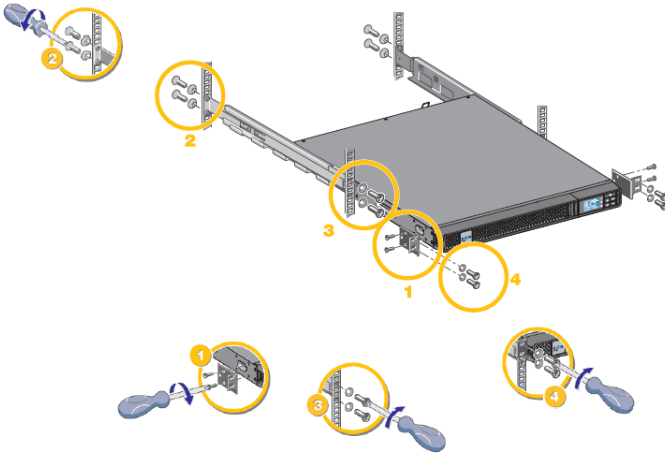

4.3 UPS connection

Power supply connection

! Check that the indications on the name plate located on the back of the UPS correspond to the AC-power source and the true electrical consumption of the total load.

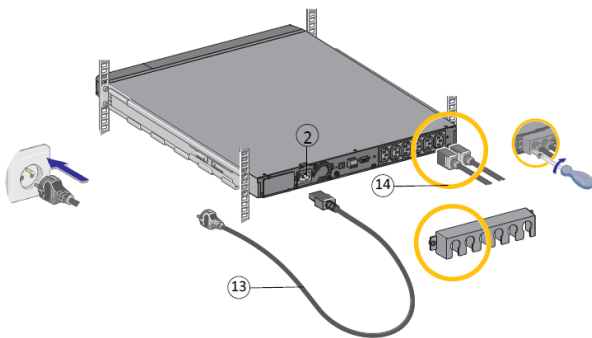

1. Connect the UPS input socket (2) to the AC power source using the cable of the protected equipment.
2. Connect the loads to the UPS using the cables (14). It is preferable to connect the priority loads to the outlets marked (3) and the non-priority loads to the outlets Group1, Group2 (4) that can be programmed.
3. To program shutdown and startup of the Group 1 and Group 2 outlets in order to extend battery runtime and perform scheduled shutdowns, please see the "[In/Out settings](#)" section.

Fit the connection securing system that prevents the plugs from being pulled out accidentally.

4.4 Register warranty

Register warranty at <https://www.pqproductregistration.eaton.com>

5 Interfaces and communication

5.1 Control panel

The screen provides useful information about the UPS itself, load status, events, measurements and settings.

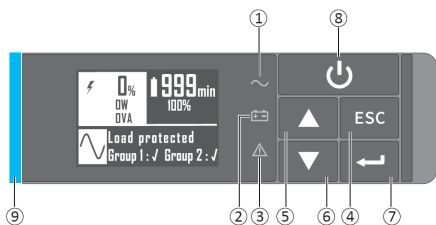



- ① Power ON indicator (green)
- ② On battery indicator (orange)
- ③ Alarm Indicator (red)
- ④ Escape
- ⑤ Up
- ⑥ Down
- ⑦ Enter
- ⑧ On/Off button
- ⑨ Led bar (Horizontally for Rack / Vertically for Tower)

Led indicator

The following table shows the indicator status and description :

The LED bar ⑨ has been implemented to provide a quick visual reference of UPS status "at-a-glance".

Indicator	Status	Description
 Green	On	The UPS is "ON" and the load is protected.
 Orange	On	The UPS is in battery mode and the load is protected.
	Flashing	The battery voltage is below the warning level.
 Red	On	The UPS has an active alarm or fault. See troubleshooting page for additional information.
Led bar	Static blue	The UPS is "ON" and the load is protected.
	Flashing blue	The UPS is on battery or the battery service age warning is reached.
	Static red	The UPS has an active alarm or fault.
	Flashing red	The UPS output has stopped due to a fault.

5.2 LCD description









- ① Load status and measurements
- ② Equipment status icon
- ③ Status / Message
- ④ Battery status

By default, or after 5 minutes of inactivity, the LCD displays the screen saver.
The backlight LCD automatically dims after 5 minutes of inactivity. Press any button to restore the screen.

i Note. If other indicator appears, see troubleshooting page for additional information.

The following table describes the status information provided by the UPS :

Operation status	Possible cause	Action
Standby mode 	The UPS is OFF, waiting for start-up command from user	Equipment is not powered until button  is pressed during start up and the green "normal mode" LED indicator is illuminated.
Normal mode 	The UPS is operating normally.	The UPS is powering and protecting the equipment.
On Battery  One beep every 10 seconds	A utility failure has occurred and the UPS is operating in Battery mode.	The UPS is powering the equipment with battery power. Prepare your equipment for shutdown.
End of backup time  1 beep every 3 seconds	The UPS is in Battery mode and the battery is running low.	This warning is approximate, and the actual time to shutdown may vary significantly. Depending on the UPS Load, the "Battery Low" warning may occur before the battery reaches 20% capacity remaining.

<p>In AVR mode</p>  <p>No beep</p>	<p>The UPS is operating normally but the utility voltage is outside Normal mode thresholds.</p>	<p>The UPS is powering the equipment through the Automatic Voltage Regulation device. The equipment is still normally protected.</p>
---	---	---

5.3 Display functions

Press the Enter (↵) button to activate the menu options. Use the two middle buttons (▲ and ▼) to scroll through the menu structure. Press the Enter (↵) button to select an option. Press the (ESC) button to cancel or return to the previous menu.

Menu map for display functions

Main menu	Submenu	Display information or Menu function
Measurements		Load: W, A, VA, pF [Input/Output] : V, f [Efficiency] : % [Battery Info] : %, min, V, Age service, Age Warning, Replacement Battery Packs [Average power usage] : Total Wh [Cumulative power] : Total KWh, Since
Control	Load Segments	Group 1: ON / OFF Group 2: ON / OFF These commands overrule user settings for load segments.
	Start battery test	Starts a manual battery test (possible if load >10% and battery >80%)
	Change battery	Disable charger, Replace battery, Update settings
	Connectivity test	Dry contacts test, Relay card test, Line failure test, Battery low test
	Functions reset	Reset fault state, Reset power usage, Reset battery life, NMC Card reset, Restore factory settings
Settings	Local settings	Sets product general parameters, see User settings
	Input / output settings	Sets input and output parameters
	ON / OFF settings	Sets ON / OFF conditions

Main menu	Submenu	Display information or Menu function
	Battery settings	Sets battery configuration
	Communication settings	Sets communication parameters
Event log	View Alarms	Displays the alarms stored
	View Events	Displays the events stored
	View All	Displays the faults and events stored
	Reset All	Clears the faults and events stored
Fault log	Fault list	Displays the faults stored
	Reset fault list	Clears faults
Identification		Type / Model / Part Number / Serial Number / UPS Firmware / NMC Firmware / IPV4 Address / IPV6 Address / Com card MAC Address
Registration		Links to Eaton registration website

5.4 User settings

The following table displays the options that can be changed by the user.

	Submenu	Available settings	Default settings
Local settings	Language	[English] [Français] [Deutsch] [Español] [Polski] [Português] [Italiano] [Simplified Chinese] [Japanese] Menus, status, notices and alarms, UPS fault, Event Log data and settings are in all supported languages.	[English] Automatic message for user configuration when UPS is powered for the first time.
	Date / time	Format: [International] [US]	[International]
	LCD	Modify LCD screen brightness and contrast to be adapted to room light conditions.	[0]
	Audible alarm	[Enabled] [Disabled on battery] [Always disabled] Enable or disable the buzzer if an alarm occurs.	[Enabled]
		Level: [0-8]	[6]
Protected access	[Enabled] [Disabled] Allow the user to lock the settings modification. Password is: 000000	[Disabled]	
In/Out settings	Output voltage	[200 V] [208 V] [220 V] [230 V] [240 V]	[230 V]
	Power Quality	Mode :[Good] [Fair] [Poor] [Custom] Voltage : [Normal] [Extended] Frequency : [Normal] [Extended] Sensitivity : [High] [Normal] [Low] This setting selects the quality of the Main AC Input that is supported by the output load by defining the conditions beyond which the UPS will transfer to battery mode	Mode :[Good] Voltage : [Normal] Frequency : [Normal] Sensitivity : [High]
	Input thresholds	NA	
	Sensitivity	See the Power Quality above	
	Load segments	[Auto start delay]	UPS:[No delay]; Group1:[3s]; Group2: [6s]
[Auto shutdown delay]		UPS:[Disabled]; Group1:[Disabled]; Group2:[Disabled]	

	Submenu	Available settings	Default settings
	Overload prealarm	[10%] ... [105%] Load % when overload alarm occurs	[105%]
ON/OFF settings	Start/Restart	[Cold start] [Auto restart] [Auto start]	[Cold start] : ON [Auto restart] : ON [Auto start] : OFF
	Forced reboot	[Yes] [No] [Timer] [10s] ... [180s] When mains recovers during a shutdown sequence: If set to Enabled, shutdown sequence will complete and wait 10 seconds prior to restart, If set to Disabled, shutdown sequence will not complete, UPS stays on.	[Yes] [10s]
	Energy saving (W,%, delay)	[Yes] [No] [Time] [1min] ... [15min] [Level] [10W] ... [1000W-3000W] If Enabled, UPS will shut-down after defined duration of back-up time, if load is less than set value.	[No] [5min] [100W]
	Sleep Mode	[Enabled] [Disabled] [Timer] [10min] ... [120min] If Disabled, LCD and communication will turn OFF immediately after UPS is OFF. If Enabled, LCD and communication stays ON for the set time period after UPS is OFF (default 90 min).	[Enabled] [30min]
	Site Wiring Fault	[Enabled] [Disabled] Prevents the UPS from starting if the phase and neutral wires are swapped.	[Disabled]
	Power Off alert	[Yes] [No] If enabled, activates a confirmation screen that requires user confirmation after pressing the power button, before UPS shutdown occurs.	[Yes]
	Battery settings	Auto battery test	In ABM® cycling mode: [No test] [Every ABM® cycle] In constant charge mode: [No test] [Daily] [Weekly] [Monthly]
Battery age warning		[Disabled][Preventive][Predictive]	[Predictive] Refer to Advanced Battery Management + section

	Submenu	Available settings	Default settings
	Low battery warning	[Capacity] [0%] ... [100%] [Runtime] [0min] ... [60min] The alarm triggers when the set percentage of battery capacity or remaining back-up time is reached.	[0%] [3min]
	Restart batt. level	[0%] ... [100%] Automatic restart will occur only when the set percentage of battery charge is reached, and "Auto Restart" is enabled and set to ON. A setting of 0% allows immediate automatic restart when utility returns after a UPS shutdown due to an extended power outage.	[0%]
	Battery charge mode	[ABM® cycling] [Constant charge]	[ABM® cycling]
	External battery	[Auto detection] [Manual EBM set.] [Manual battery set.]	[Auto detection] Using standard EBM, UPS automatically detects the number of EBM connected
	Deep disch. protect.	[Enabled] [Disabled] If set to Enable, the UPS operates within the normal design range of the battery during discharge. If set to Disable, the UPS allows deeper battery discharge to extend battery runtime at the expense of long-term battery life (warranty is also void if set to disable).	[Enable]

	Submenu	Available settings	Default settings
Comm settings	Input signals	<p>[ROO] [RPO] [DB9-4] Sets Input signals parameters (function, delay, operation) through external contact connectors or RS232 port.</p> <p>ROO port: - [Function]: [No] [ROO] [RPO] [Building alarm]</p> <p>[Shutdown commands] - [Delay]: [0s] ... [999s] - [Active]: [Open] [Closed]</p> <p>RPO port: - [Function]: [No] [ROO] [RPO] [Building alarm]</p> <p>[Shutdown commands] - [Delay]: [0s] ... [999s] - [Active]: [Open] [Closed]</p> <p>DB9-4 port: - [Function]: [No] [ROO] [RPO] [Building alarm]</p> <p>[Shutdown Commands] - [Delay]: [0s] ... [999s] - [Active]: [Low] [High]</p>	<p>[No] [0s] [Closed]</p> <p>[No] [0s] [Open]</p> <p>[No] [0s] [High]</p>
	Outputs signals	<p>[DB9-1] [DB9-7] [DB9-8] Sets events or fault that will actuate Output signal parameters through external contact connector or RS232 port</p> <p>[DB9-1]: [On bat] [Low bat] [Bat fault] [UPS OK] [Load protected] [Load powered] [General alarm] [OVL pre-alarm] [Batt Disconn]</p> <p>[DB9-7]: [On bat] [Low bat] [Bat fault] [UPS OK] [Load protected] [Load powered] [General alarm] [OVL pre-alarm] [Batt Disconn]</p> <p>[DB9-8]: [On bat] [Low bat] [Bat fault] [UPS OK] [Load protected] [Load powered] [General alarm] [OVL pre-alarm] [Batt Disconn]</p>	<p>[DB9-1] : [Low bat] [DB9-7] : [UPS OK] [DB9-8] : [On bat]</p>
	Remote command	<p>[Yes] [No] If Yes, shutdown or restart commands from software are authorized.</p>	<p>[Yes]</p>

	Submenu	Available settings	Default settings
	Shutdown commands	<p>[Send CMD] [Output OFF] [OFF delay] [restart]</p> <p>Sets events or fault that will actuate Output signal parameters through external contact connector or RS232 port</p> <p>[Send CMD]: [Yes] [No]</p> <p>[Output OFF]: [No] [UPS] [Group 1] [Group 2] [Group 1 + 2]</p> <p>[OFF delay]: [0s] ...[999s]</p> <p>[Restart]: [Yes] [No]</p> <p>For a proper server shutdown please make sure that the Output OFF delay is long enough</p>	<p>Send CMD: [No]</p> <p>Output OFF: [No]</p> <p>OFF delay: [0s]</p> <p>Restart: [Yes]</p>
	On battery notice delay	<p>[0s] ... [99s]</p> <p>Sets delay before providing an on battery notice to software.</p>	[0s]
	General alarm	<p>[On battery] [Battery fault] [Overload pre-alarm] [Internal fault] [Ambient temp.] [Fan lock] [Current limit] [Short circuit] [Inverter overload] [Power overload] [Low battery] [UPS OK] [Load protected] [Load powered]</p> <p>Defines which event or fault will generate a general alarm through Output signal screen.</p>	[Internal fault]
	Set Comm Card IPv4	NA	NA

5.5 Advanced Battery Management +

Eaton ABM+ (Advanced Battery Management) implements a machine learning algorithm providing battery health status. When set to predictive mode, the UPS will be able to provide an accurate remaining service time prediction based on real UPS usage condition.

A battery replacement warning (that includes the battery P/N) will be triggered at the most appropriate time to help user keeping the UPS operating at its best performance.

5.6 Communication ports

Connection of RS232/USB communication port

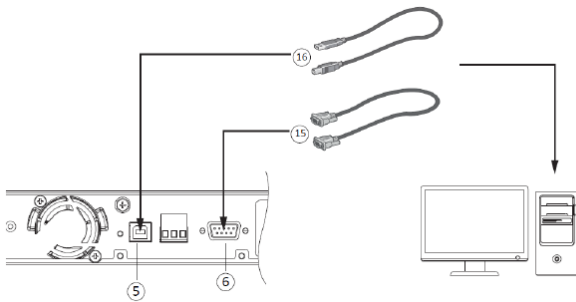

1. Connect the RS232 (15) or USB (16) communication cable to the serial or USB port on the computer equipment.
2. Connect the other end of the communication cable (15) or (16) to the USB (5) or RS232 (6) communication port on the UPS.

i The UPS can now communicate with Eaton power management software.

You can improve the remote monitoring and power management of the UPS by adding a [communication card](#) compatible with the 5P Gen2 product.

Characteristics of the contact RS232 communication port

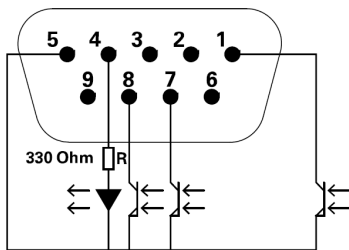

- Pins 1, 3, 4, 5, 6, 10: not used
- Pin 2: common (user)
- Pin 7: low battery
- Pin 8: operation on battery power
- Pin 9: UPS ON, equipment supplied

n.o.: normally open contact

When a signal is activated, the contact is closed between the common (pin 2) and the pin for the corresponding signal. Contact characteristics (optocoupler)

- Voltage: 48 V DC max
- Current: 25 mA max
- Power: 1.2 W

Installation of the communication cards

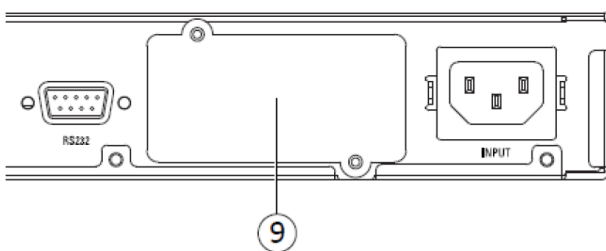

It is not necessary to shutdown the UPS before installing a communication card.

1. Remove the slot cover (9) secured by screws.
2. Insert the communication card in the slot.
3. **Secure the card cover with the two screws to connect the comm card to the ground.**

5.7 UPS remote control functions

Connectivity cards

Connectivity cards allow the UPS to communicate in a variety of networking environments and with different types of devices. The 5P Gen2 models have one available communication bay for the following connectivity cards:

- **Gigabit Network card (Network-M2, Network-M3)** : provides a Gigabit Ethernet connection and enables secure UPS monitoring over HTTPS web browser interface, SNMP v1/v3 protocol and email alarms. In addition, up to 3 Environmental Monitoring Probes can be attached to obtain humidity, temperature, smoke alarm, and security information.
- **Industrial Gateway card (INDGW-M2)** : Provides Modbus RTU and Modbus TCP communication support in addition to the same secure UPS monitoring, management and sensor capability as the Gigabit Network card.
- **Relay-MS card** : provides isolated dry contact (Form-C) relay outputs for UPS status: Utility failure, Battery low, UPS alarm/OK, or on Bypass.
- **INDRELAY-MS** : The Industrial relay Card-MS (INDRELAY-MS) provides a simple way to remotely input UPS information to an alarm system, PLC or a computer system via dry contacts. It offers five isolated dry contact outputs and one isolated dry contact input.

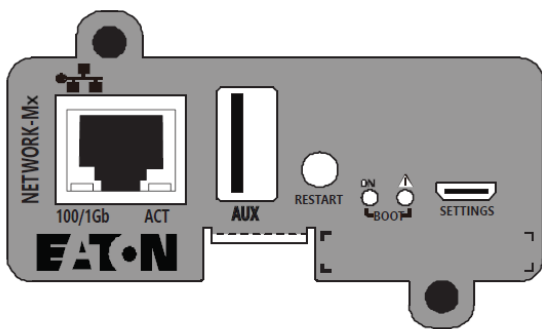

Network-M2, Network-M3 Card

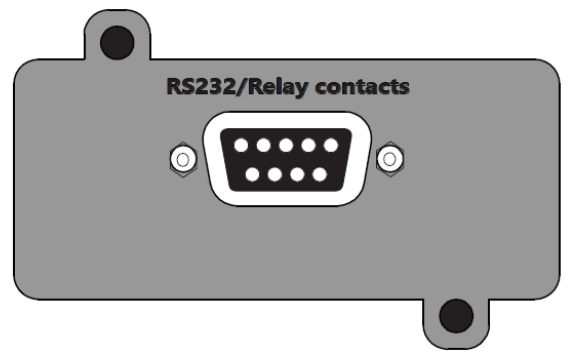

Relay-MS Card

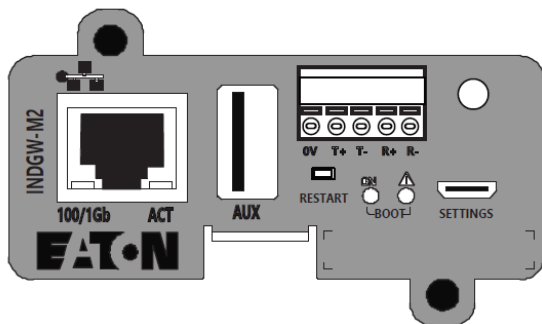

INDGW-M2

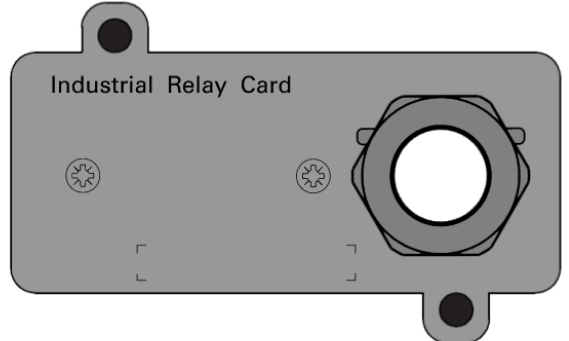

INDRELAY-MS

Remote control connection and test

Check that the UPS is OFF and disconnected from the AC input source.

Remove connector (4) after unscrewing the screws.

Connect a normally closed volt-free contact (60 V DC / 30 V AC max., 20 mA max., 0.75 mm² cable cross-section) between the two pins of connector (4) (see diagram).



Warning. This connector must only be connected to SELV (Safety Extra-Low Voltage) circuits.

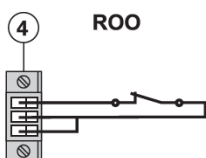

Contact open: UPS shutdown

Contact closed: UPS start-up (UPS connected to AC power and AC power is available)

Note. The local ON/OFF control using button  overrides the remote-control function.

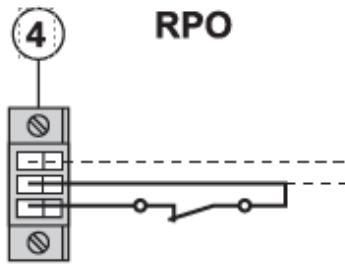

Contact open: UPS shutdown, LED  turns ON

To return to normal operation, deactivate the remote external contact and restart the UPS by pressing button 

5.8 Eaton Intelligent Power Software suite

Eaton Intelligent Power Software suite is available from eaton.com/downloads.

Eaton Software suite provides up-to-date graphics of UPS power and system data and power flow.

It also gives you a complete record of critical power events, and it notifies you of important UPS or power information.

If there is a power outage and the 5P Gen2 UPS battery power becomes low, Eaton Software suite can automatically shut down your computer system to protect your data before the UPS shutdown occurs.

5.9 Cybersecurity

Eaton is committed to minimizing the Cybersecurity risk in its products and employs cybersecurity best practices and the latest cybersecurity technologies in its products and solutions, making them more secure, reliable and competitive for our customers. Eaton also offers Cybersecurity Best Practices whitepapers to its customers, referenced at www.eaton.com/cybersecurity.

6 Operation

6.1 Start-up and normal operation



Check that the indications on the name plate located on the back of the UPS meets to the AC power source and the true electrical consumption of the total load.





Battery charge

The UPS charges the battery as soon as it is connected to the AC outlet, whether the ON/OFF button is pressed or not. It is recommended that the UPS be permanently connected to the AC power supply to ensure the best possible autonomy.



On the first startup of the UPS, you will need to configure the output voltage and time of the UPS.

To start the UPS:

1. Verify that the UPS power cord is plugged in.
2. The UPS front panel display illuminates and shows Eaton logo.
3. Verify that the UPS status screen shows .
4. Press the  button on the UPS front panel for at least few seconds.
5. Check the UPS front panel LED for active alarms or notices. Resolve any active alarms before continuing; if the  indicator is on, do not proceed until all alarms are clear (see "[Troubleshooting](#)" section). Check the UPS status from the front panel to view the active alarms. Correct the alarms and restart if necessary.
6. Verify that the  indicator illuminates solid, indicating that the UPS is operating normally and any loads are powered and protected. The UPS should be in Normal mode.

Grid power quality

This setting reflects the quality of the power that is applied to the application by defining the conditions before transferring to battery mode



- **Good** means that the application needs a perfect power signal quality (voltage, frequency and waveform distortion) to be able to work correctly.

- **Fair** means that power signal may show some slight voltage and frequency variation without disturbing the application.
- **Poor** means that the application can withstand extended threshold of voltage and frequency as well as some distorted input waveforms without any risk.
- Each of these settings will automatically adjust the UPS voltage and frequency thresholds in order to provide the best protection possible vs application need.
- A custom mode permits to adjust each setting independently.

Power Quality	Good	Fair	Poor
Voltage	Normal	Normal	Extended
Frequency	Normal	Normal	Extended
Sensitivity	High	Normal	Low



6.2 Starting the UPS on battery

To start the UPS on battery:

1. When the UPS is disconnected from the AC power source, press the  button on the UPS front panel. The UPS transfers from Standby mode to Battery mode. The   indicator illuminates solid. The UPS supplies power to your equipment.
2. Check the UPS front panel display for active alarms or notices besides the "Battery mode" and related notifications that indicates missing utility power. Resolve any active alarms before continuing. See "[Troubleshooting](#)". Check the UPS status from the front panel to view the active alarms. Correct the alarms and restart if necessary.

6.3 UPS shutdown

To shut down the UPS:

Press the  button on the front panel for two seconds. confirmation message will appear. When confirmed, the UPS starts to beep and shows a status of "UPS shutting OFF...". The UPS then transfers to Standby mode, and the  indicator turns off.



6.4 Operating modes

The Eaton 5P Gen2 front panel indicates the UPS status through the UPS indicators located above the LCD screen.

Normal mode

 When the green symbol is illuminated, the UPS is providing protected AC power output. The UPS monitors and charges the batteries as needed and provides power protection to your equipment.

Battery mode

  When the UPS is operating during a power outage, the alarm beeps once every ten seconds and the indicator illuminates solid.

The necessary energy is provided by the battery.



When the utility power returns, the UPS transfers to Normal mode operation while the battery recharges.

If battery capacity becomes low while in Battery mode, the audible alarm beeps faster.

This warning is approximate, and the actual time to shutdown may vary significantly; shutdown all applications on connected equipment due to imminent UPS shutdown.

When utility power is restored after the UPS shuts down, the UPS automatically restarts.

Low-battery warning

- The   indicator illuminates solid.
- The audio alarm beeps every three seconds.

The remaining battery power is low. Shut down all applications on the connected equipment because automatic UPS shutdown is imminent.

End of battery backup time

- LCD displays "End of backup time".
- All the LEDs go OFF.
- The audible alarm stops.

6.5 Return of AC input power

Following an outage, the UPS restarts automatically when AC input power returns and the load is supplied again.

7 UPS maintenance

7.1 Equipment care

For the best preventive maintenance, keep the area around the equipment clean and dust free. If the atmosphere is very dusty, clean the outside of the system with a vacuum cleaner.

For full battery life, keep the equipment at an ambient temperature of 25 °C (77 °F).

The batteries are rated for a 3-5 year service life. The length of service life varies, depending on the frequency of usage and ambient temperature (life divided by 2 each 10 °C above 25 °C).

If the UPS requires any type of transportation, verify that the UPS is turned off.

Batteries used beyond expected service life will often have severely reduced runtimes. Replace batteries at least every 4 years to keep units running at peak performance.

Batteries runtime will be reduced at low temperature (below 10 °C).

7.2 Storing the equipment

If you store the equipment for a long period, recharge the battery every 6 months by connecting the UPS to utility power. The internal batteries charge to 90% capacity in less than 3 hours. However, Eaton recommends that the batteries charge for 48 hours after long-term storage.

Check the battery recharge date on the shipping carton label. If the date has passed and the batteries were never recharged, do not use them. Contact your service representative.

7.3 When to replace batteries

Eaton 5P Gen2 batteries have an expected life span of 3-5 years.

After 4 years of operation, the UPS will provide a battery replacement notification reminding you that your batteries are nearing the end of their useful life. You should take proactive steps to ensure you replace your batteries for optimal operation and reliability.

Contact your service representative to order new batteries.

 Battery recommended replacement date and reference can be accessed through the LCD (Measurements > Battery).

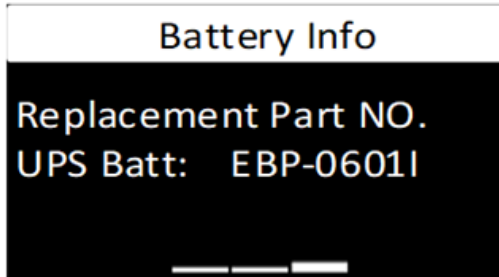

7.4 Replacing batteries

For battery replacement, follow Eaton instructions provided on www.eaton.eu/BatteryServices.

Servicing of batteries can be performed by **an ordinary person** only when the following instructions are understood and respected.

Batteries can be replaced easily without turning off the UPS or disconnecting the load.



DO NOT DISCONNECT the batterie while the UPS is in Battery mode.



Risk of Electric Shock : Disconnect the battery before opening battery compartment.

Consider all warnings, cautions, and notes before replacing batteries.

- Replace with the same type and number of batteries or battery packs. Contact your service representative to order new batteries.
- Batteries can present a risk of electrical shock or burn from high short circuit current.
- Do not wear any metal objects including watches and rings.
- Do not lay tools or metal parts on top of batteries.
- Proper disposal of batteries is required. Refer to your local codes for disposal requirements.
- Do not dispose of batteries in a fire. When exposed to flame, batteries may explode
- Do not open or mutilate the battery or batteries. Released electrolyte is harmful to the skin and eyes and may be extremely toxic.
- Determine if the battery is inadvertently grounded. If inadvertently grounded, remove source from ground. Contact with any part of a grounded battery can result in electrical shock. The likelihood of such shock can be reduced if such grounds are removed during installation and maintenance (applicable to equipment and remote battery supplies not having a grounded supply circuit).
- ELECTRIC ENERGY HAZARD. Do not attempt to alter any battery wiring or connectors. Attempting to alter wiring can cause injury.
- Failed batteries can reach temperatures that exceed the burn thresholds for touchable surfaces.

Replacing the internal battery :

The internal battery is heavy. Use caution when handling the heavy batteries.



A Phillips head screwdriver is needed to perform this procedure

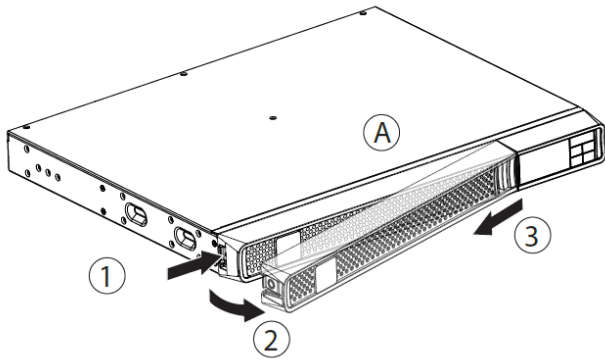

1 - Pull off the front panel by pressing the tabs and follow the step 2 and 3.A - Remove the front panel.

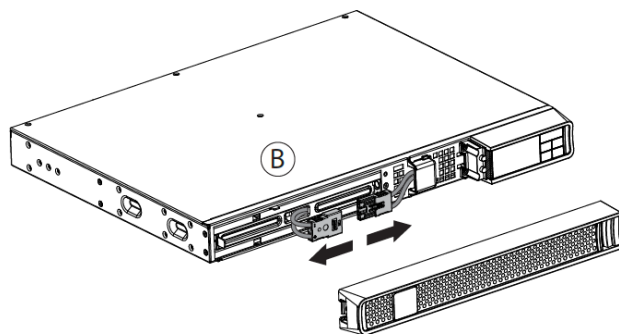
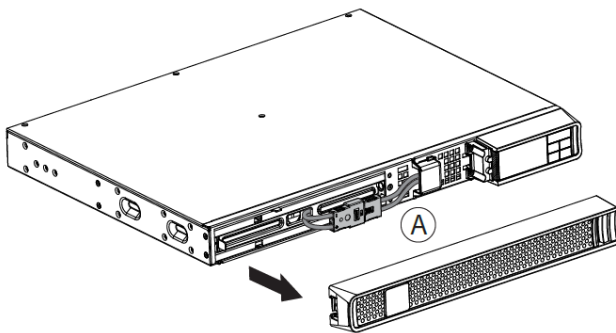

B - Disconnect the battery block by separating the two connectors (never pull on the wires).

C - Remove the protection cover in front of the battery

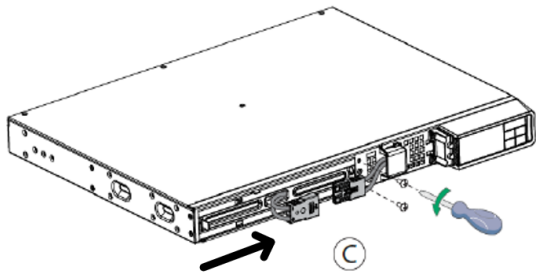

D - Pull the plastic tab to remove the battery block and replace it.

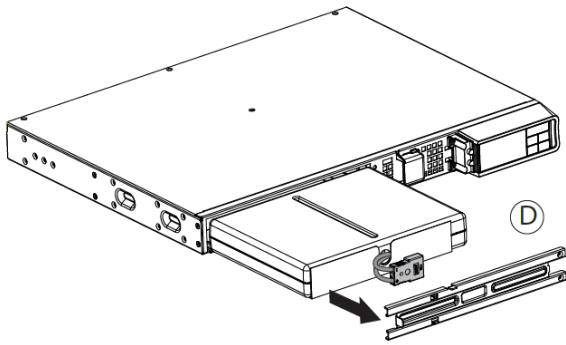

Testing new batteries :

To test new batteries:

1. Charge the batteries for 48 hours.
2. Press any button to activate the menu options.
3. Select Control then Start battery test. The UPS starts a battery test if the batteries are fully charged, the UPS is in Normal mode with no active alarms, and the bypass voltage is acceptable. During the battery test, the UPS transfers to Battery mode and discharges the batteries for 10 seconds. The front panel displays "Battery test in progress" and the percentage of the test completed.

7.5 Recycling the used equipment

Contact your local recycling or hazardous waste center for information on proper disposal of the used equipment.
eaton.com/recycling



Do not dispose the battery or batteries in a fire. Batteries may explode. Proper disposal of batteries is required. Refer to your local codes for disposal requirements.



Do not open or mutilate the battery or batteries. Released electrolyte is harmful to the skin and eyes. It may be toxic. Do not discard the UPS or the UPS batteries in the trash. This product contains sealed, lead acid batteries and must be disposed of properly. For more information, contact your local recycling/reuse or hazardous waste center.



Do not discard waste electrical or electronic equipment (WEEE) in the trash. For proper disposal, contact your local recycling/reuse or hazardous waste center.

8 Troubleshooting

The Eaton 5P Gen2 is designed for reliable, autonomous operation while providing you with notifications and alerts whenever a potential operational or performance issue occurs.

Usually the alarms shown by the control panel do not mean that the output power is affected. Instead, they are preventive alarms intended to alert the user.

- Events are silent status information that are recorded into the Event log. Example = "AC freq in range".
- Alarms are recorded into the Event log and displayed on the LCD status screen with the logo blinking. Some alarms may be announced by a beep every 3 seconds. Example = "Battery low".
- Faults are announced by a continuous beep and red LED, recorded into the Fault log and displayed on the LCD with a specific message box. Example = Out. short circuit.

Use the following troubleshooting chart to determine the UPS alarm condition.

8.1 Silencing the alarm

Press the ESC (Escape) button on the front panel display to silence the alarm. Check the alarm condition and perform the applicable action to resolve the condition. If the alarm status changes, the alarm beeps again, overriding the previous alarm silencing.

8.2 Service and support

If you have any question or problem with the UPS, call Eaton or your local service representative in your country / region. Please have the following information ready when you call for service:

- Model number
- Serial number
- Firmware version number
- Date of failure or problem
- Symptoms of failure or problem
- Customer return address and contact information

If repair is required, you will be given a Returned Material Authorization (RMA) number. This number must appear on the outside of the package and on the Bill Of Lading (if applicable). Use the original packaging or request packaging from the Help Desk or distributor. Units damaged in shipment as a result of improper packaging are not covered by warranty. A replacement or repair unit will be shipped freight prepaid for all warrantied units.

i For critical applications, immediate replacement may be available. Call the Help Desk for the dealer or distributor nearest you.

9 Specification and technical characteristics

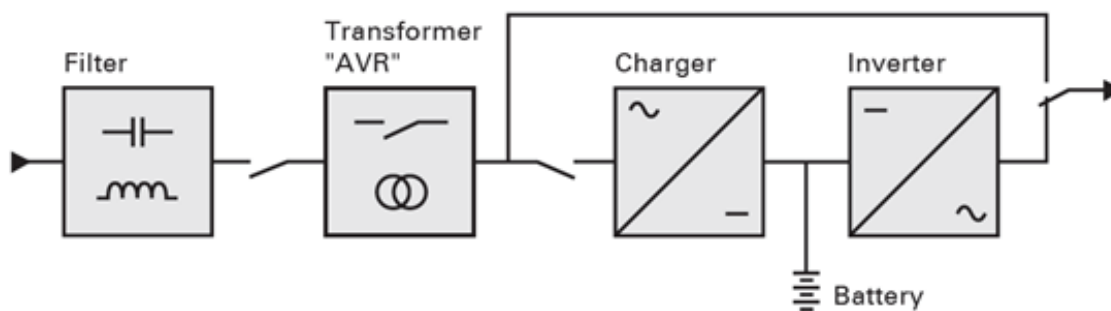

9.1 Electrical input

Default frequency	50Hz
--------------------------	------

Nominal frequency	50/60Hz
Frequency range	47-70Hz
Protective class	Protective class I
Rated Input Voltage	200-240V~
Input Voltage Range	160-294V~ adjustable to 150~294V~
Rated Input Current	10A
Nominal Input Current	5P650IRG2 : 3.1A 5P650IRNG2 : 3.1A 5P850IRG2 : 4.1A 5P850IRNG2 : 4.1A 5P1150IRG2 : 5.5A 5P1150IRNG2 : 5.5A 5P1550IRG2 : 7.5A 5P1550IRNG2 : 7.5A

9.2 Electrical output

All models	Normal mode	Battery mode
Voltage regulation	Boost : $V_{in} \times 1.17$ Buck : $V_{in} \times 0.85$	(-10% ,6%)
Efficiency	> 97%	Between 77% and 87%
Nominal output	200/208/220/ 230 /240V~	
Frequency	Follows input frequency range	50/60Hz +/-0.1 Hz
Output overload	[105%,120%] 30min [120%,150%]5min >150% 10S	[105% ~110%] 10s >110% 1s,

All models	Normal mode	Battery mode
Short circuit current limitation in battery mode	Depend on the external fuse or breaker in the upstream of UPS	<p>< 2.5 cycles</p> <p>5P650IRG2 : 15A 5P650IRNG2 : 15A 5P850IRG2 : 24A 5P850IRNG2 : 24A 5P1150IRG2 : 30A 5P1150IRNG2 : 30A 5P1550IRG2 : 39A 5P1550IRNG2 : 39A</p>
Transfer time Normal to Battery	<p>High Sensitivity mode 10ms max Low Sensitivity mode 13ms max</p>	<p>8ms Typical, 10ms Max for high & normal sensitivity 11ms Typical, 13ms Max for low sensitivity</p>
Transfer time Avr mode to Normal mode	6ms typical , 10ms maxi	/

9.3 Battery

	Internal batteries
Specifications	<p>650VA: 12Vdc - 2 x 6V, 9Ah 850VA: 24Vdc - 4 x 6V, 7Ah 1150VA: 24Vdc - 4 x 6V, 9Ah 1550VA: 36Vdc - 6 x 6V, 9Ah</p>
Type	<p>Valve Regulated Lead-Acid (VRLA) Sealed, maintenance-free, minimum 3-5 year float service life at 25°C (77°F)</p>
Monitoring	Advanced monitoring for earlier failure detection and warning

9.4 Environmental and safety

Standards	<p>IEC/EN 62040-1 Safety IEC/EN 62040-2 Electromagnetic Compatibility EMC IEC/EN 62040-3 Performance</p>
EMC (Emissions)	<p>CISPR32 Class B FCC part 15 Class B IEC/EN 62040-2 C1 IEC/EN 61000-3-2 Flickers IEC/EN 61000-3-3 Harmonics</p>

EMC (Immunity)	IEC 61000-4-2, (ESD): 8 kV Contact Discharge / 15 kV Air Discharge IEC 61000-4-3, (Radiated field): 10 V/m IEC 61000-4-4, (EFT): 4 kV IEC 61000-4-5, (Surges): 2 kV Differential Mode / 4 kV Common Mode IEC 61000-4-6, (Electromagnetic field): 10 V IEC 61000-4-8, (Conducted magnetic field): 30 A/m
UPS enclosure IP rating	IP20
Earthing system	This UPS can be connected to TN, TT, IT electrical supply system, same system is supplied to the load.
Overvoltage Category	Category II
Pollution degree	PD2
Operating temperature	0 to 40 °C (32 to 104 °F)
Storage temperature	-15 to 40°C (5 to 104 °F) with battery -15 to 50°C (5 to 122 °F) without battery
Relative humidity	0 to 90 % (without condensation)
Operating altitude	Up to 2,000 meters (6,562 ft) above sea level, no derating for 40°C (104°F) room temperature Above 2000 meters (6,562 ft) apply a derating 1% of Load per 100m
Transit altitude	Up to 10,000 meters (32,808 ft) above sea level
Audible noise	Line mode:<35dBA Buck/boost mode:<35 dBA Batt. Mode: <40dBA

10 Glossary

Backup time	Time during which the load can be supplied by the UPS operating on battery power.
Low-battery warning	This is a battery-voltage level indicating that battery power is low and that the user must take action before the UPS shuts down.
Load	Devices or equipment connected to the UPS output.
Normal mode	The normal UPS operating mode in which the AC source supplies the UPS which, in turn, provides AC power to the connected loads.
Normal AC source	Normal source of power for the UPS.
OVL	Overload. When the load exceeds 100% of the maximum load of the UPS.
UPS	Uninterruptible Power System.
AVR	The A utomatic V oltage R egulation maintains a constant voltage level for electrical equipment loads when the voltage falls outside the voltage tolerance range.