



TUF GAMING TR120 ARGB FAN [1-pack]

Quick Start Guide



Q22847 / First Edition / November 2023

Accessory Kit Contents

配備零組件內容物 | 配備組件內容物 | Obsah sady příslušenství | Contenu du kit d'accessoires |
Verpackungsinhalt des Zubehörsatzes | Accessori contenuti nel kit | アクセサリーキットの内容 |
액세서리 키트 내용물 | Zawartość zestawu akcesoriów | Conteúdo do kit de acessórios | Содержимое
комплекта | Contenido del kit de accesorios | Tillbehörsattsens innehåll | Aksesuar Kitinin İçindekiler |
תוכן ערכת האביזרים | محتويات طقم الملحقات

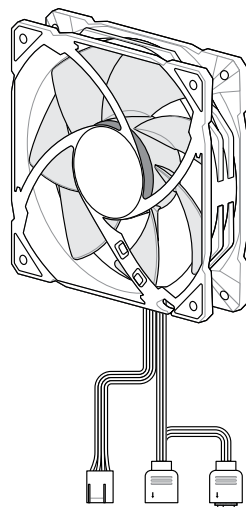

1 x TR120 ARGB fan



4 x Fan screws

Installation Guide

安裝指南 | 安裝指南 | Instalační příručka | Guide d'installation | Installationsanleitung | Guida
all'installazione | 組み立てガイド | 설치 설명서 | Instrukcja instalacji | Manual de instalação |
Руководство по установке | Guía de instalación | Installationsguide | Kurulum Kılavuzu | دليل التركيب |
מדריך ההתקנה

1

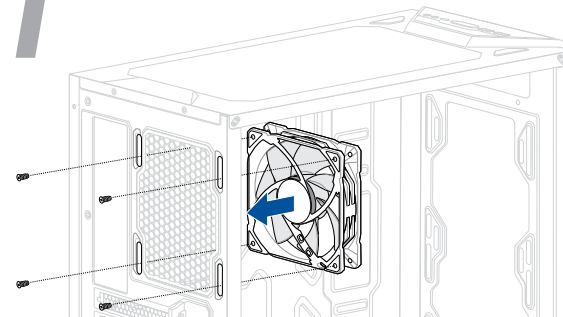

OR

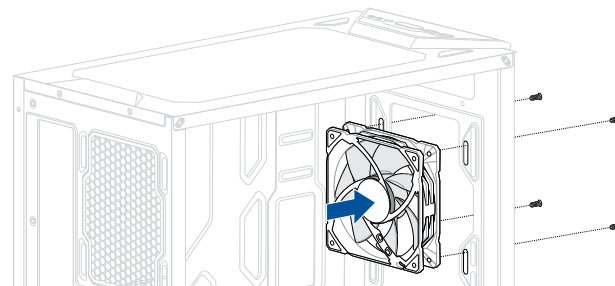

2

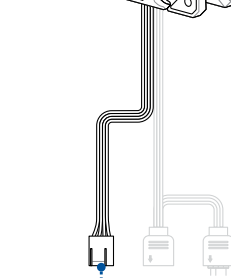
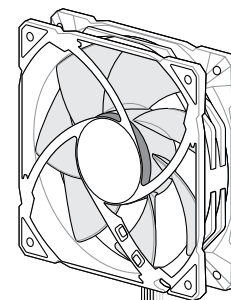

Motherboard fan header

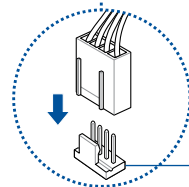

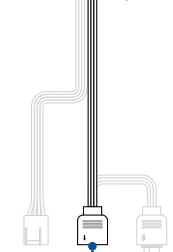
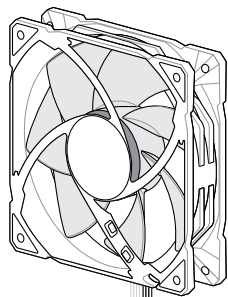

Motherboard ARGB header



电子电气产品有害物质限制使用标识：图中之数字为产品之环保使用期限。仅指电子电气产品中含有的有害物质不致发生外泄或突变，从而对环境造成污染或对人身、财产造成严重损害的期限。

部件名称	有害物质					
	铅 (Pb)	汞 (Hg)	镉 (Cd)	六价铬 (Cr (VI))	多溴联苯 (PBB)	多溴二苯醚 (PBDE)
橡胶垫片	○	○	○	○	○	○
方形框	○	○	○	○	○	○
VAPO	○	○	○	○	○	○
扣环	○	○	○	○	○	○
橡胶片	○	○	○	○	○	○
漆包线	○	○	○	○	○	○
定位PIN	○	○	○	○	○	○
绕线套	○	○	○	○	○	○
定子	○	○	○	○	○	○
磁浮片	○	○	○	○	○	○
PCB绝缘片	○	○	○	○	○	○
芯片电阻	X	○	○	○	○	○
晶体管二极管	X	○	○	○	○	○
HALL IC	○	○	○	○	○	○
PC Board	○	○	○	○	○	○
空扇叶	○	○	○	○	○	○
轴心	○	○	○	○	○	○
橡胶磁铁	○	○	○	○	○	○
螺丝	○	○	○	○	○	○
芯片电容	○	○	○	○	○	○
马达壳	○	○	○	○	○	○
商标	○	○	○	○	○	○
配线	○	○	○	○	○	○

本表格依据 SJ/T 11364 的规定编制。

○：表示该有害物质在该部件所有均质材料中的含量均在 GB/T 26572 标准规定的限量要求以下。

X：表示该有害物质至少在该部件的某一均质材料中的含量超出 GB/T 26572 规定的限量要求，然该部件仍符合欧盟指令 2011/65/EU 的规范。

备注：此产品所标示之环保使用期限，系指在一般正常使用状况下。

Declaration of compliance for product environmental regulation

ASUS follows the green design concept to design and manufacture our products, and makes sure that each stage of the product life cycle of ASUS product is in line with global environmental regulations. In addition, ASUS disclose the relevant information based on regulation requirements. Please refer to <http://csr.asus.com/Compliance.htm> for information disclosure based on regulation requirements. ASUS is complied with:

EU REACH and Article 33

Complying with the REACH (Registration, Evaluation, Authorisation, and Restriction of Chemicals) regulatory framework, we published the chemical substances in our products at ASUS REACH website at <http://csr.asus.com/english/REACH.htm>.

EU RoHS

This product complies with the EU RoHS Directive. For more details, see <http://csr.asus.com/english/article.aspx?id=35>

Japan JIS-C-0950 material declarations

Information on Japan RoHS (JIS-C-0950) chemical disclosures is available on <http://csr.asus.com/english/article.aspx?id=19>

India RoHS

This product complies with the "India E-Waste (Management) Rules, 2016" and prohibits use of lead, mercury, hexavalent chromium, polybrominated biphenyls (PBBs) and polybrominated diphenyl ethers (PBDEs) in concentrations exceeding 0.1% by weight in homogenous materials and 0.01% by weight in homogenous materials for cadmium, except for the exemptions listed in Schedule II of the Rule.

Vietnam RoHS

ASUS products sold in Vietnam, on or after September 23, 2011, meet the requirements of the Vietnam Circular 30/2011/TT-BCT. Các sản phẩm ASUS bán tại Việt Nam, vào ngày 23 tháng 9 năm 2011 trở về sau, đều phải đáp ứng các yêu cầu của Thông tư 30/2011/TT-BCT của Việt Nam.

Türkiye RoHS

AEEE Yönetmeliğine Uygundur

ASUS Recycling/Takeback Services

ASUS recycling and takeback programs come from our commitment to the highest standards for protecting our environment. We believe in providing solutions for you to be able to responsibly recycle our products, batteries, other components as well as the packaging materials. Please go to <http://csr.asus.com/english/Takeback.htm> for detailed recycling information in different regions.

Safety Precautions

Accessories that came with this product have been designed and verified for the use in connection with this product. Never use accessories for other products to prevent the risk of electric shock or fire.

安全上のご注意

付属品は当該専用品です。他の機器には使用しないでください。機器の破損もしくは、火災や感電の原因となることがあります。

France sorting and recycling information



FR

Cet appareil
et ses accessoires
se recyclent

À DÉPOSER
EN MAGASINÀ DÉPOSER
EN DÉCHÈTERIE

Points de collecte sur www.quefairedemesdechets.fr