

Service Manual–P2425HEB

Version: 01

Date:2023/12/26

Content Index

1. General Safety Instructions 3
 1.1 SAFETY: General Safety 3
 1.2 SAFETY: General Power Safety 5

2. Exploded view diagram with list of items 6

3. Wiring connectivity diagram 8

4. How to connect and disconnect power cable/ connectivity cable..... 9

5. Disassembly and Assembly Procedures 11
 5.1 Disassembly SOP 11
 5.2 Assembly SOP 15

6. Trouble shooting instructions 19

1. General Safety Instructions

Use the following safety guidelines to help ensure your own personal safety and to help protect your equipment and working environment from potential damage.

NOTE: In this section, equipment refers to monitors.

IMPORTANT NOTICE FOR USE IN HEALTHCARE ENVIRONMENTS:

Dell products are not medical devices and are not listed under UL or IEC 60601 (or equivalent). As a result, they must not be used within 6 feet of a patient or in a manner that directly or indirectly contacts a patient

1.1 SAFETY: General Safety

WARNING: To prevent the spread of fire, keep candles or other open flames away from this product at all times.

When setting up the equipment for use:

- Place the equipment on a hard, level surface. Leave 10.2 cm (4 in) minimum of clearance on all vented sides of the computer to permit the airflow required for proper ventilation.
- Restricting airflow can damage the computer or cause a fire.
- Do not stack equipment or place equipment so close together that it is subject to recirculated or preheated air.
- NOTE: Review the weight limits referenced in your computer documentation before placing a monitor or other devices on top of your computer.
- Ensure that nothing rests on your equipment's cables and that the cables are not located where they can be stepped on or tripped over.
- Ensure that all cables are connected to the appropriate connectors. Some connectors have a similar appearance and may be easily confused (for example, do not plug a telephone cable into the network connector).
- Do not place your equipment in a closed-in wall unit or on a bed, sofa, or rug.
- Keep your device away from radiators and heat sources.
- Keep your equipment away from extremely hot or cold temperatures to ensure that it is used within the specified operating range.
- Do not push any objects into the air vents or openings of your equipment. Doing so can cause fire or electric shock by shorting out interior components.
- Avoid placing loose papers underneath your device. Do not place your device in a closed-in wall unit, or on a soft, fabric surface such as a bed, sofa, carpet, or a rug.

When operating your equipment:

- Do not use your equipment in a wet environment, for example, near a bath tub, sink, or swimming pool or in a wet basement.
- Do not use AC powered equipment during an electrical storm. Battery powered devices may be used if all cables have been disconnected.
- Do not spill food or liquids on your equipment.
- Before you clean your equipment, disconnect it from the electrical outlet. Clean your device with a soft cloth dampened with water. Do not use liquids or aerosol cleaners, which may contain flammable substances.
- Clean the monitor display with a soft, clean cloth and water. Apply the water to the cloth, then stroke the cloth across the display in one direction, moving from the top of the display to the bottom. Remove moisture from the display quickly and keep the display dry.
- Long-term exposure to moisture can damage the display. Do not use a commercial window cleaner to clean your display.
- If your equipment does not operate normally - in particular, if there are any unusual sounds or smells coming from it - unplug it immediately and contact an authorized dealer or service center.

Protecting Against Electrostatic Discharge

Electrostatic discharge (ESD) events can harm electronic components inside your equipment. Under certain conditions, ESD may build up on your body or an object, such as a peripheral, and then discharge into another object, such as your computer. To prevent ESD damage, you should discharge static electricity from your body before you interact with any of your equipment's internal electronic components, such as a memory module. You can protect against ESD by touching a metal grounded object (such as an unpainted metal surface on your computer's I/O panel) before you interact with anything electronic. When connecting a peripheral (including handheld digital assistants) to your equipment, you should always ground both yourself and the peripheral before connecting it. In addition, as you work inside the equipment, periodically discharge any static charge your body may have accumulated.

You can also take the following steps to prevent damage from electrostatic discharge:

- When unpacking a static-sensitive component from its shipping carton, do not remove the component from the antistatic packing material until you are ready to install the component. Just before unwrapping the antistatic package, be sure to discharge static electricity from your body.
- When transporting a sensitive component, first place it in an antistatic container or packaging.
- Handle all electrostatic sensitive components in a static-safe area. If possible, use antistatic floor pads and work bench pads.

1.2 SAFETY: General Power Safety

Observe the following guidelines when connecting your equipment to a power source:

- Check the voltage rating before you connect the equipment to an electrical outlet to ensure that the required voltage and frequency match the available power source.
- Do not plug the equipment power cables into an electrical outlet if the power cable is damaged
- Norway and Sweden: If this product is provided with a 3-prong power cable, connect the power cable to a grounded electrical outlet only.
- If you use an extension power cable, ensure that the total ampere rating of the products plugged in to the extension power cable does not exceed the ampere rating of the extension cable.
- If you must use an extension cable or power strip, ensure the extension cable or power strip is connected to a wall power outlet and not to another extension cable or power strip. The extension cable or power strip must be designed for grounded plugs and plugged into a grounded wall outlet.
- If you are using a multiple-outlet power strip, use caution when plugging the power cable into the power strip. Some power strips may allow you to insert a plug incorrectly. Incorrect insertion of the power plug could result in permanent damage to your equipment, as well as risk of electric shock and/or fire. Ensure that the ground prong of the power plug is inserted into the mating ground contact of the power strip.
- Be sure to grasp the plug, not the cable, when disconnecting equipment from an electric socket.

If your equipment uses an AC adapter:

- Use only the Dell provided AC adapter approved for use with this device. Use of another AC adapter may cause a fire or explosion.
- NOTE: Refer to your system rating label for information on the proper adapter model approved for use with your device.
- Place the AC adapter in a ventilated area, such as a desk top or on the floor, when you use it to run the computer or to charge the battery. Do not cover the AC adapter with papers or other items that will reduce cooling; also, do not use the AC adapter inside a carrying case.
- The AC adapter may become hot during normal operation of your computer. Use care when handling the adapter during or immediately after operation.
- It is recommended that you lay the adapter on the floor or desk so that the green light is visible. This will alert you if the adapter should accidentally go off due to external effects. If for any reason the green light goes off, disconnect the AC power cord from the wall for a period of ten seconds, and then reconnect the power cord.
- Japan Only: Use only the Dell-provided AC power cable with the AC adapter. Use of any other power cable may damage the device or AC adapter or may present risk of fire or electric shock.

2. Exploded view diagram with list of items

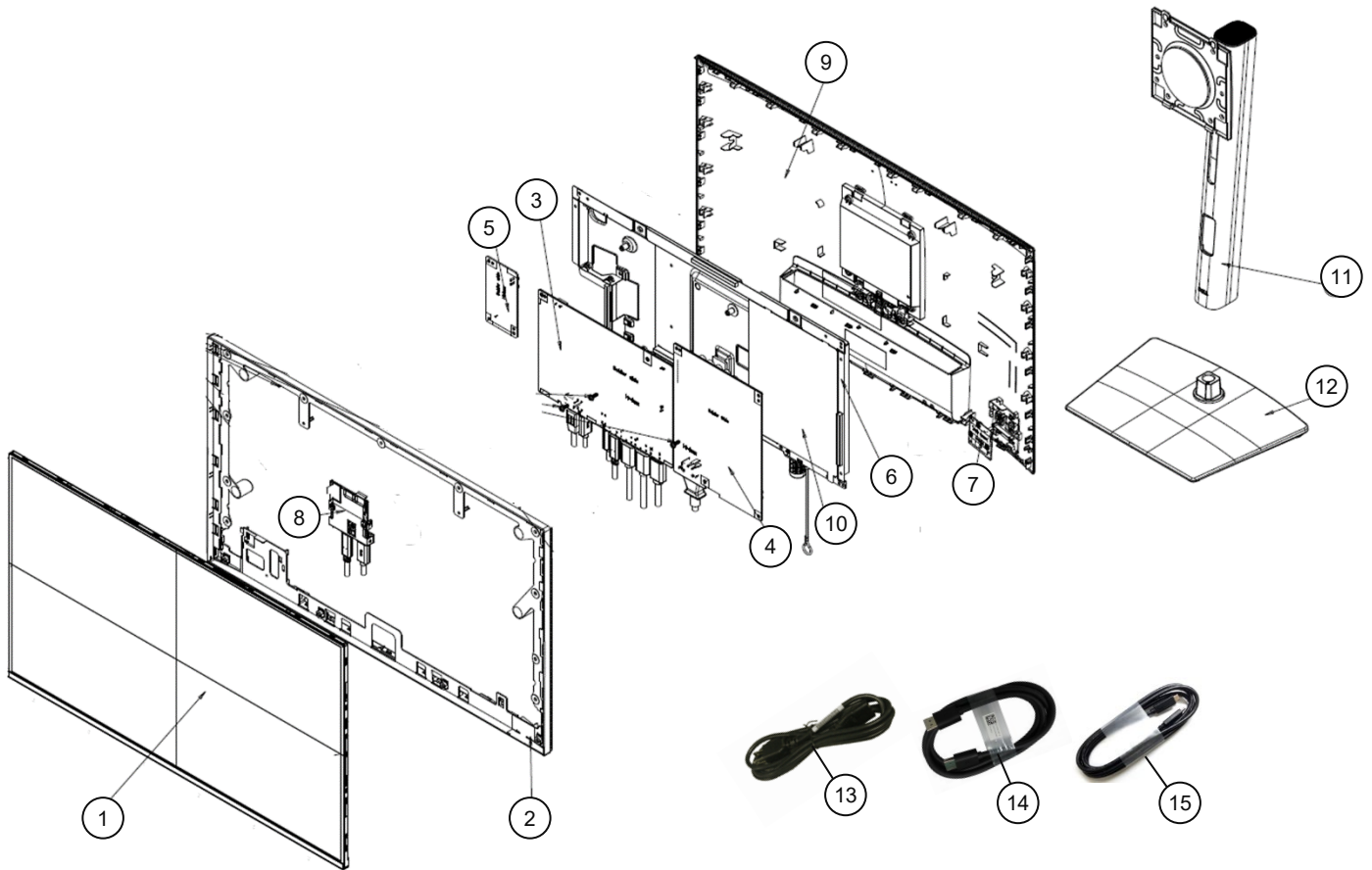

Item	DESCRIPTION	Q'ty	Remark
1	Panel	1	
2	Middle Frame	1	
3	Interface Board	1	
4	Power Board	1	
5	LED Driver Board	1	
6	Main Shielding	1	For EMEA Only, not for other regions
7	Control Board	1	
8	USB Board	1	
9	Rear Cover	1	
10	Mylar Power Board	1	
11	Column	1	
12	Base	1	
13	Power cable (varies by country)	1	See "NOTE"
14	DisplayPort 1.4 cable (DP to DP)	1	See "NOTE"
15	USB Type-C 3.2 Gen2 cable	1	See "NOTE"

NOTE:

For replacement of power cord, connectivity cable and external power supply (if applicable), contact Dell:

1. Go to <https://www.dell.com/support>.
2. Verify your country or region in the Choose A Country/Region drop-down menu at the bottom-right corner of the page.
3. Click Contact Us next to the country dropdown.
4. Select the appropriate service or support link based on your need.
5. Choose the method of contacting Dell that is convenient for you

3. Wiring connectivity diagram

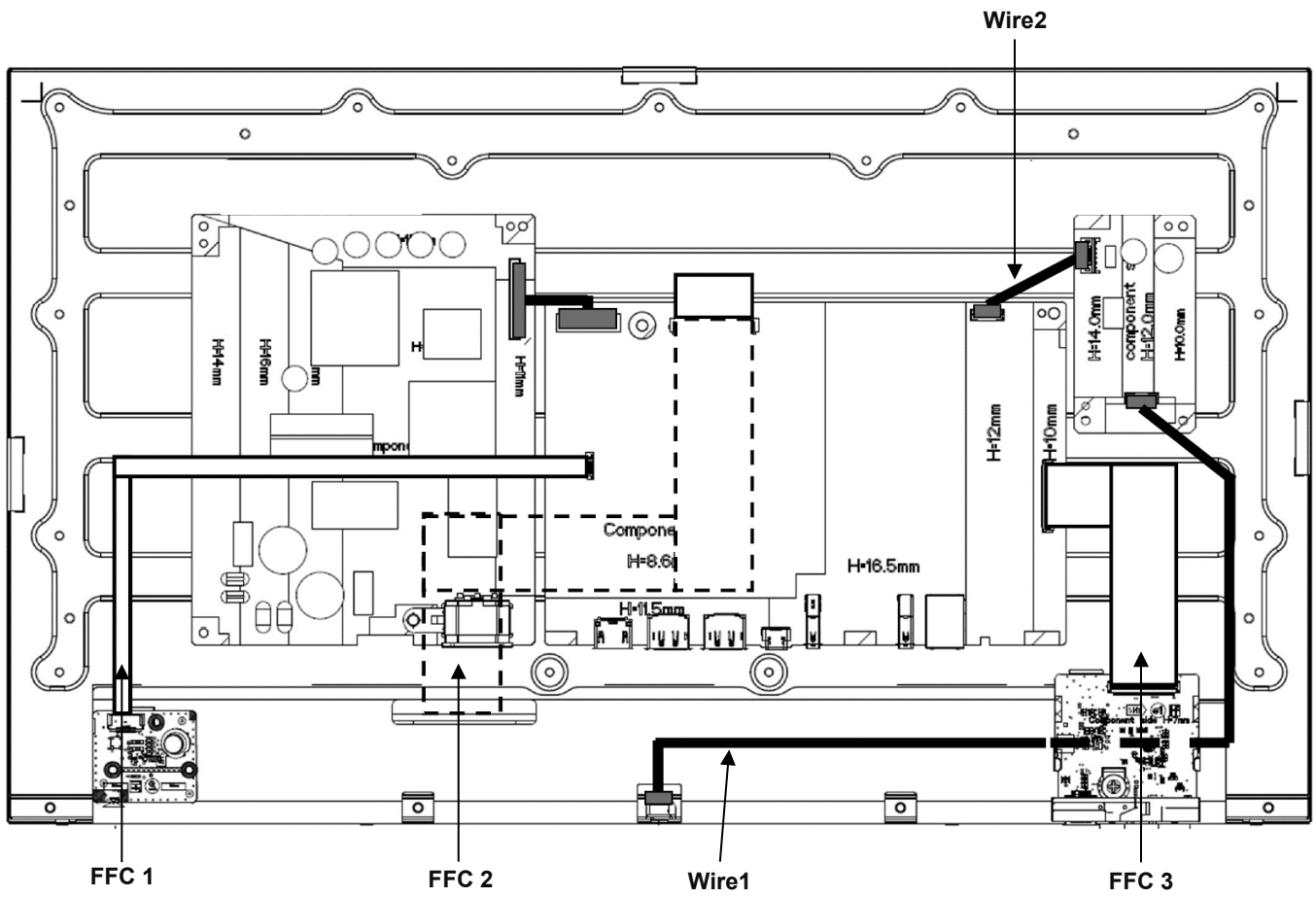

4. How to connect and disconnect power cable/ connectivity cable

WARNING: To change power cable/ connectivity cable, switch off power before unplugging the cable and replugging in required cable.

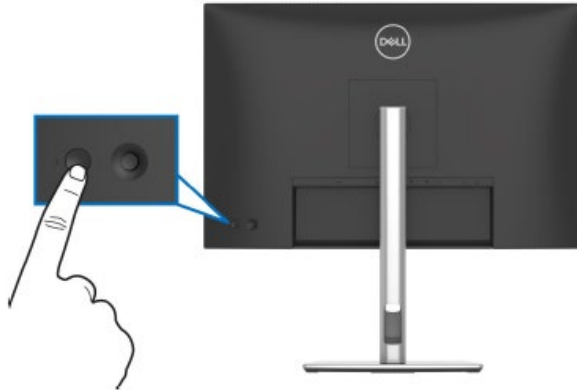

Connecting/ disconnecting the DisplayPort (DP to DP) cable and Power cable

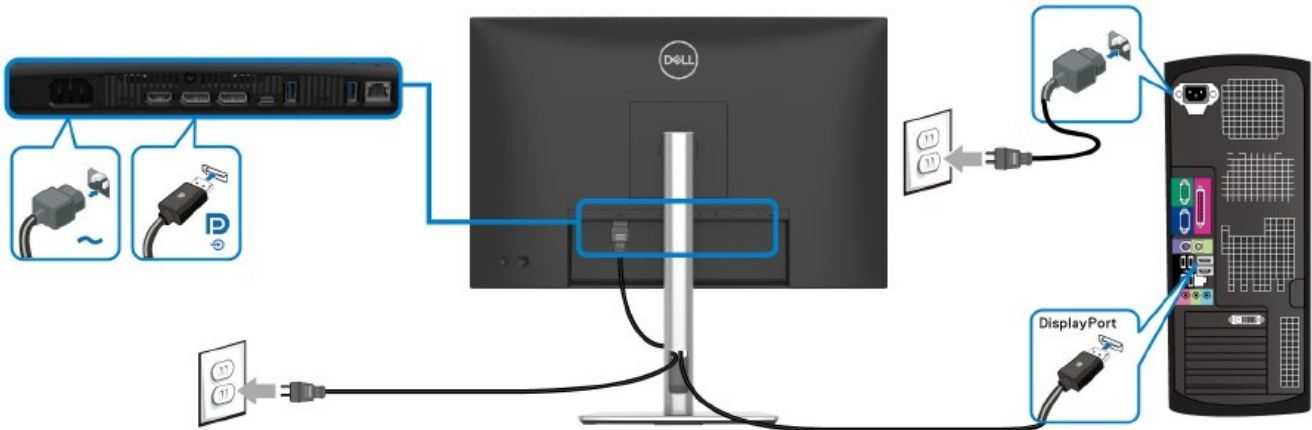

Connecting/ disconnecting the USB-C to USB-C cable and Power cable

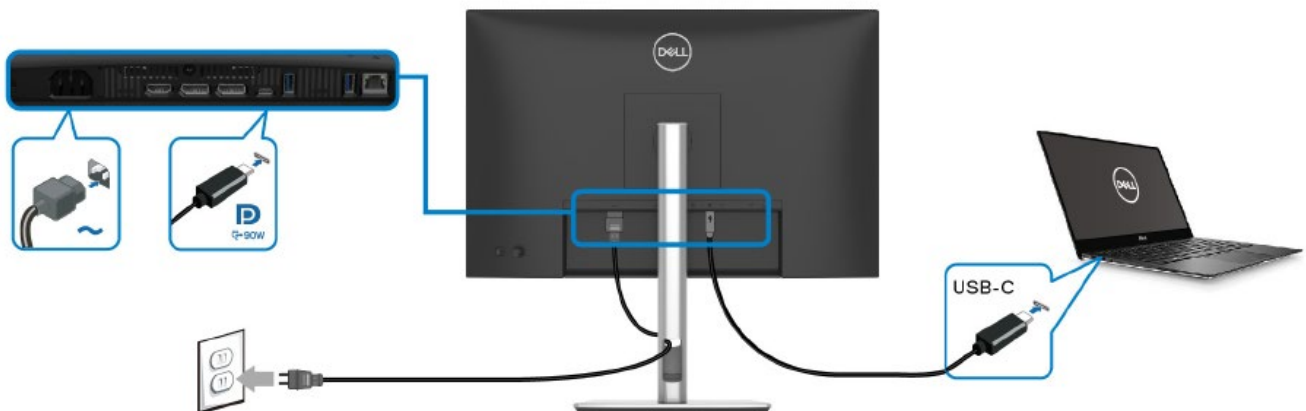

Connecting/ disconnecting the HDMI cable (optional) and Power cable

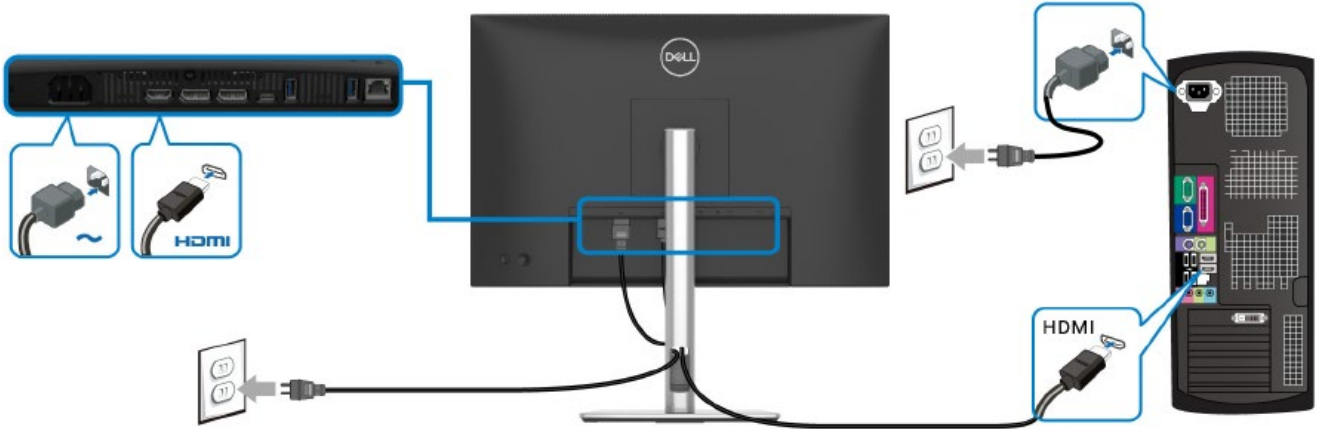

Connecting/ disconnecting the monitor for RJ45 cable (optional) and Power cable

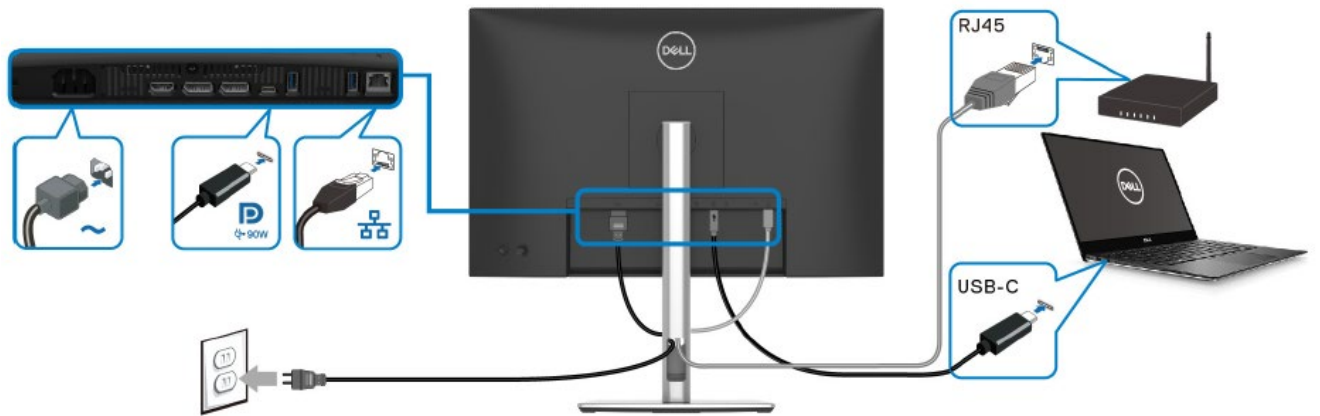

5. Disassembly and Assembly Procedures

NOTE:

This “Disassembly and Assembly Procedures” is for EMEA only, not for other regions. Please note that Dell will deem warranty void if any disassembly is done on the monitors.

5.1 Disassembly SOP

Preparation before disassembly

1. Clean the room for work
2. Identify the area for material
3. Prepare the implement, equipment, materials as bellow :
 - 1) Working table
 - 2) Philips-head screwdriver
 - 3) Gloves
 - 4) Cleaning cloth
 - 5) ESD protection

S1 Turn off the monitor.

S2 To remove the stand
1. Place the monitor on a soft cloth or cushion

2. Press and hold the stand release button at the back of the display

3. Lift the stand assembly up and away from the monitor



S3 Unlock 4 screws on “Rear Cover”

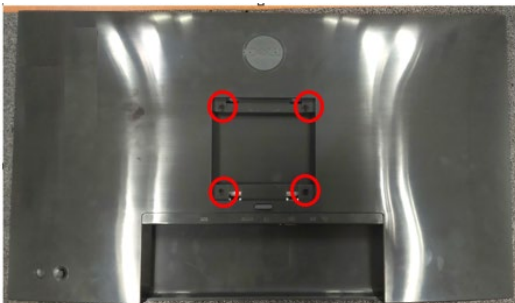

(Screw Torque: 9±1 kgf)

S4 Use hands or “Bar Scraper” to disassemble “Rear Cover” from “Middle Frame” according to the sequence shown in the picture

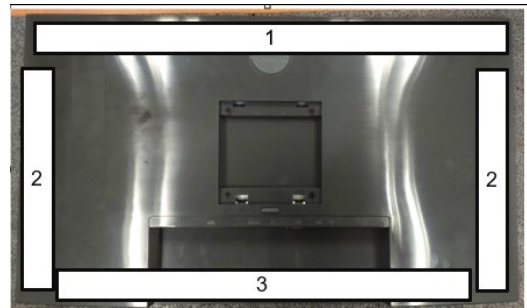

S5 Pull out “Control board FFC” from “Interface board” and tear off it from “Main Shielding” to take off “Rear Cover”



S6 Unlock 3 screws to disassemble
“Control board” from “Rear Cover”

Tear off “Control board FFC” from
“Rear Cover” and take off “Control
board” from “Rear Cover”



(Screw Torque: 1.6-1.8 kgf)

S7 Disassemble “Control board FFC” from
“Control board”



S8 Tear off 2 tapes from “Backlight wire”

Unplug “Backlight wire” from “LED
Driver board” and “Panel”

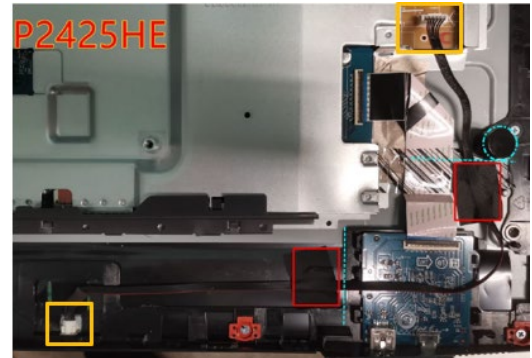

S9 Tear off a black tape from “USB board
FFC” and “Panel”

Disassemble “USB board FFC” from
“USB board” and “Interface board”

Unlock 1 screw on “USB board”

Disassemble “USB board” from “Middle
Frame”

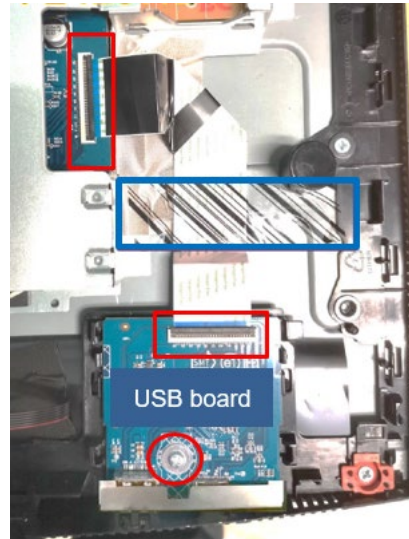

(Screw Torque: 4.5±0.5 kgf)

S10 Tear off a gasket from “USB Shielding”
(see pink mark)

Tear off a gasket from “USB board”
(see red mark)

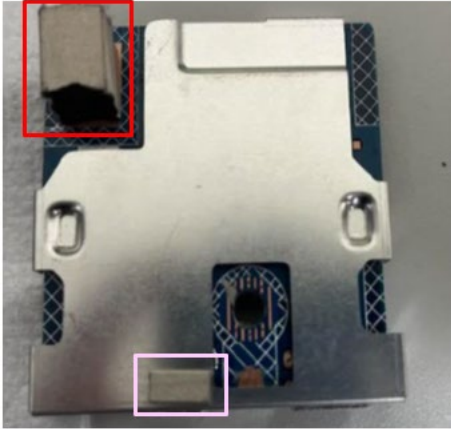

S11 Disassemble “USB board” from “USB Shielding”

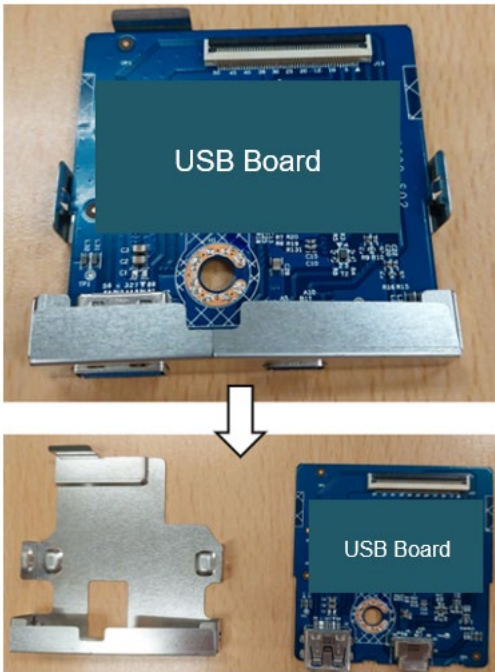

S12 Tear off 2 conductive tapes from “Main Shielding and “Panel”

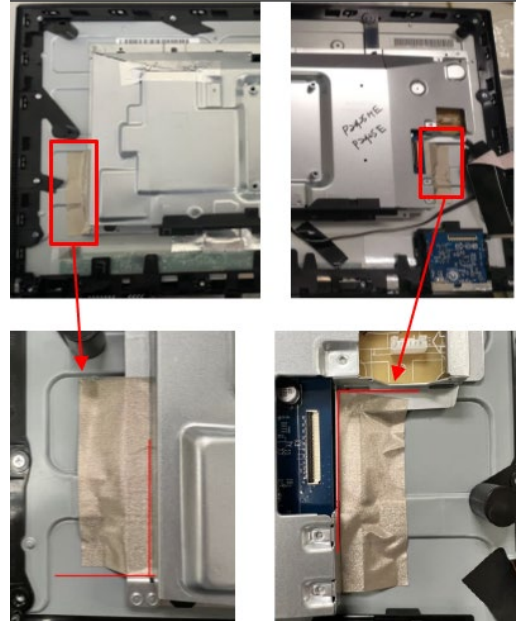

S13 Tear off an aluminum foil and a yellow tape from “LVDS FFC” on “Panel”



- S14** Disassemble "LVDS FFC" from "Panel"
Take off "Main Shielding" from "Panel"



- S15** Unlock 13 screws to disassemble "Middle Frame" from "Panel"
Take off "Middle Frame" from "Panel"



(Screw Torque: 4.5-5.0 kgf)

- S16** Tear off two acetate tapes from the convex holes on "Panel"

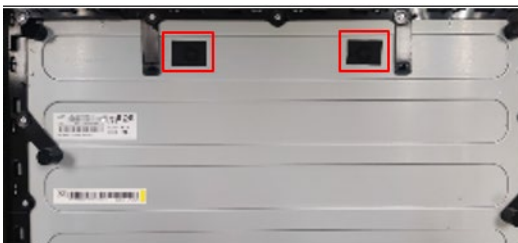

- S17** Disassemble "MYLAR" from "Main Shielding"

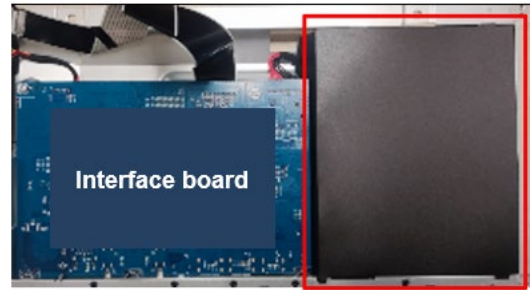

- S18** Unlock 7 PCBA screws

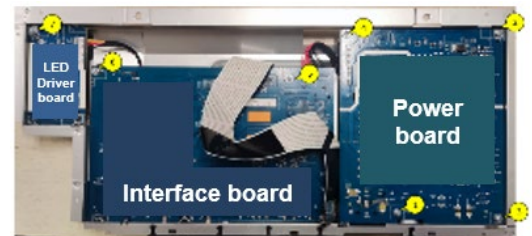

(Screw Torque: 9±1 kgf)

- S19** Disassemble "LED Driver board", "Interface board" and "Power board" from "Main Shielding"

Unplug all cables from "Interface board"

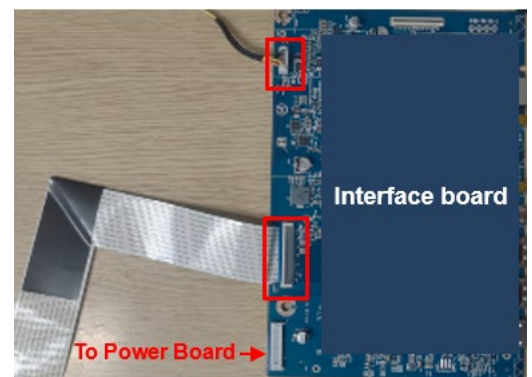

5.2 Assembly SOP

Preparation before assembly

1. Clean the room for work
2. Identify the area for material
3. Prepare the implement, equipment, materials as bellow:
 - 1) Working table
 - 2) Philips-head screwdriver
 - 3) Gloves
 - 4) Cleaning cloth
 - 5) ESD protection

S1 Assemble "Power board" to "Main Shielding"



S2 Insert "LVDS FFC" and "LED Driver board to Interface board wire" into "Interface board"

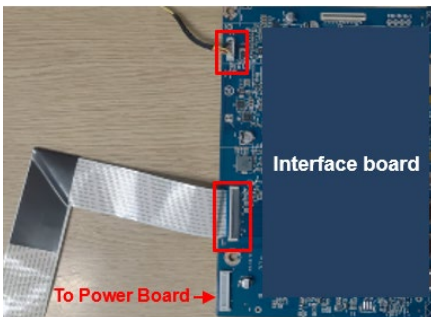

S3 Insert "Power board wire" to "Interface board" and assemble "Interface board" to "Main Shielding"

Insert "LED Driver board to Interface board wire" to "LED Driver board" and assemble "LED Driver board" to "Main Shielding"

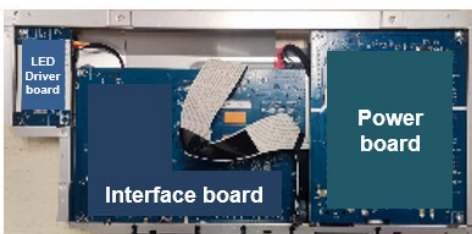

S4 Lock 7 PCBA screws

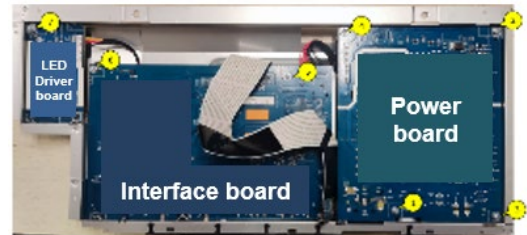

(Screw Torque: 9 ± 1 kgf)

S5 Assemble "MYLAR" to "Main Shielding"

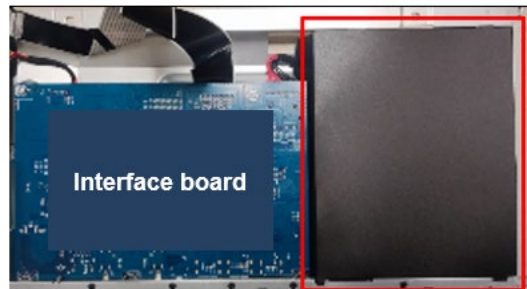

S6 Attach two acetate tapes to cover the convex holes on "Panel"



- S7** Assemble "Middle Frame" with "Panel"
 Lock 13 screws to fix "Middle Frame" with "Panel"



(Screw Torque: 4.5-5.0 kgf)

- S8** Insert "LVDS FFC" to "Panel"

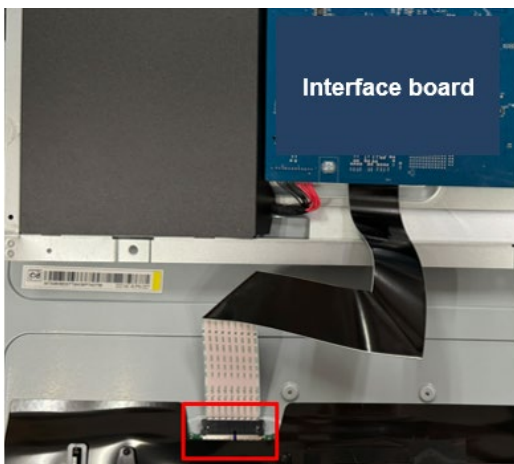

- S9** Attach a yellow tape to fix "LVDS FFC" on "Panel"

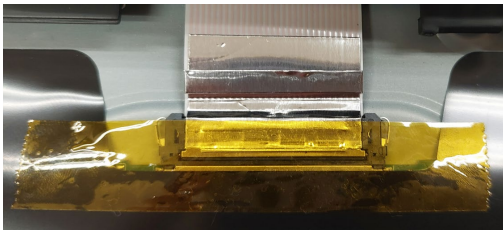

- S10** Attach an aluminum foil to cover the yellow tape

Place "Main Shielding" on "Panel"



- S11** Attach 2 conductive tapes on "Main Shielding" and "Panel"

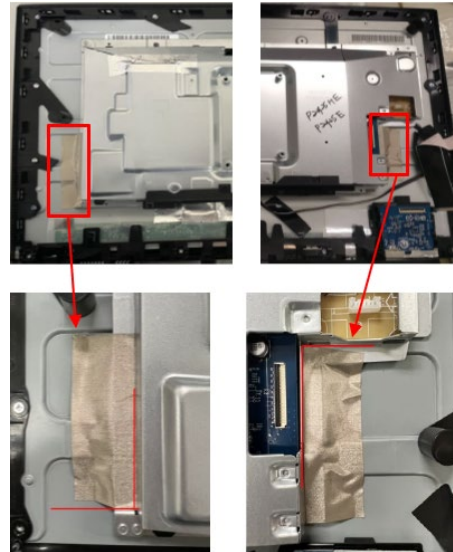

- S12** Assemble "USB board" with "USB Shielding"

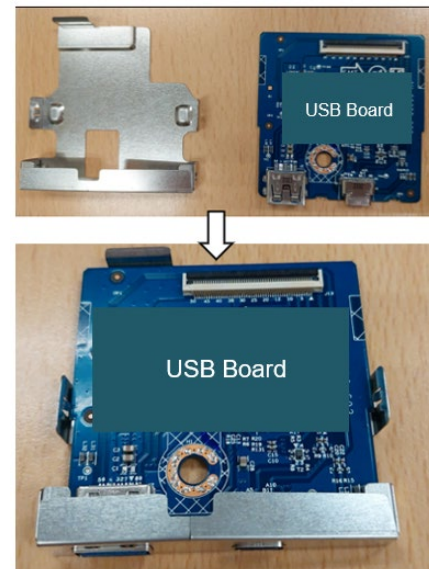

S13 Attach a gasket on “USB board” (see red mark)

Attach a gasket on “USB Shielding” (see pink mark)

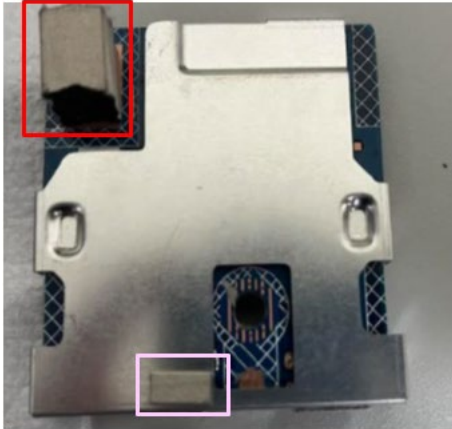

S14 Assemble “USB board” with “Middle Frame”

Lock 1 screw to fix “USB board” on “Middle Frame”

Insert “USB board FFC” to “USB board” and “Interface board”

Attach a black tape to fix “USB board FFC” on “Panel”

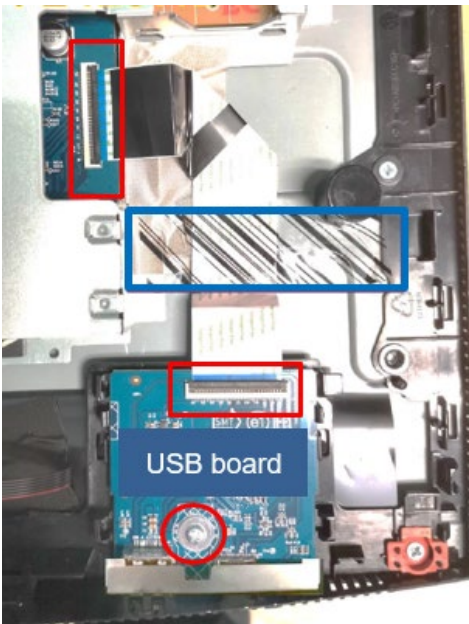

(Screw Torque: 4.5±0.5 kgf)

S15 Insert “Backlight wire” to “Panel” and “LED Drive board”

Attach 2 tapes to fix “Backlight wire” on “Panel”

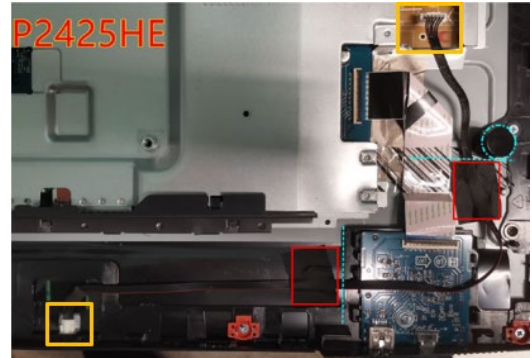

S16 Insert “Control board FFC” to “Control board”



S17 Assemble “Control board” to “Rear Cover”

Lock 3 screws to fix “Control board” on “Rear Cover”



(Screw Torque: 1.6-1.8 kgf)

- S18** Insert "Control board FFC" into "Interface board" and paste it on Main SHD

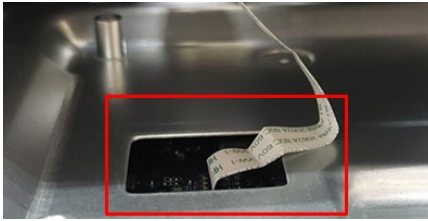

- S19** Assemble "Rear Cover" with "Middle Frame" according to the sequence shown in the picture

Lock 4 screws to fix "Rear Cover"

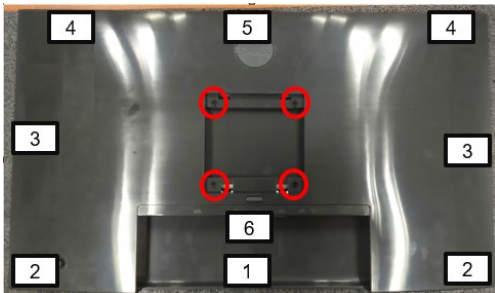

(Screw Torque: 9 ± 1 kgf)

- S20** Insert the stand base blocks fully into the stand slot

Lift the screw handle and turn the screw clockwise

After fully tightening the screw, fold the screw handle flat within the recess



- S21** Attach the stand assembly to the display

- Fit the two tabs on the upper part of the stand to the groove on the back of the display
- Press the stand down till it snaps into place



6. Trouble shooting instructions

Troubleshooting

 **WARNING:** Before you begin any of the procedures in this section, follow the [Safety instructions](#).

Self-test

Your monitor provides a self-test feature that allows you to check whether your monitor is functioning properly. If your monitor and computer are properly connected but the monitor screen remains dark, run the monitor self-test by performing the following steps:

1. Turn off both your computer and the monitor.
2. Unplug the video cable from the computer.
3. Turn on the monitor.

If the monitor cannot sense a video signal and is working correctly, the following message will appear:

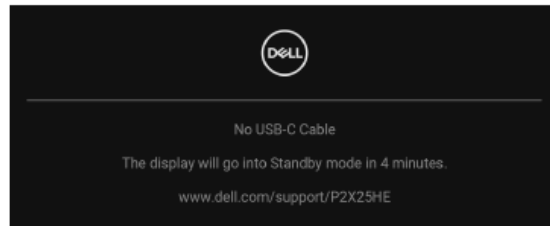

or

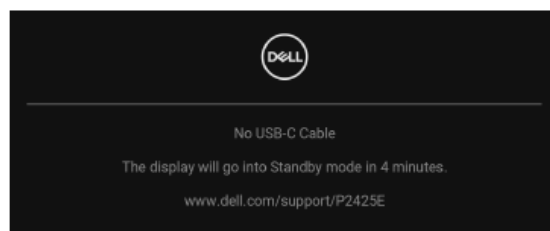

 **NOTE:** The message may be slightly different according to the connected input signal.

 **NOTE:** While in self-test mode, the power LED remains white.

4. This box also appears during normal system operation, if the video cable becomes disconnected or damaged.
5. Turn off your monitor and reconnect the video cable; then turn on both your computer and the monitor.

If your monitor screen remains blank after you use the previous procedure, check your video controller and computer, because your monitor is functioning properly.

Built-in diagnostics

Your monitor has a built-in diagnostic tool that helps you determine if the screen abnormality you are experiencing is an inherent problem with your monitor, or with your computer and video card.

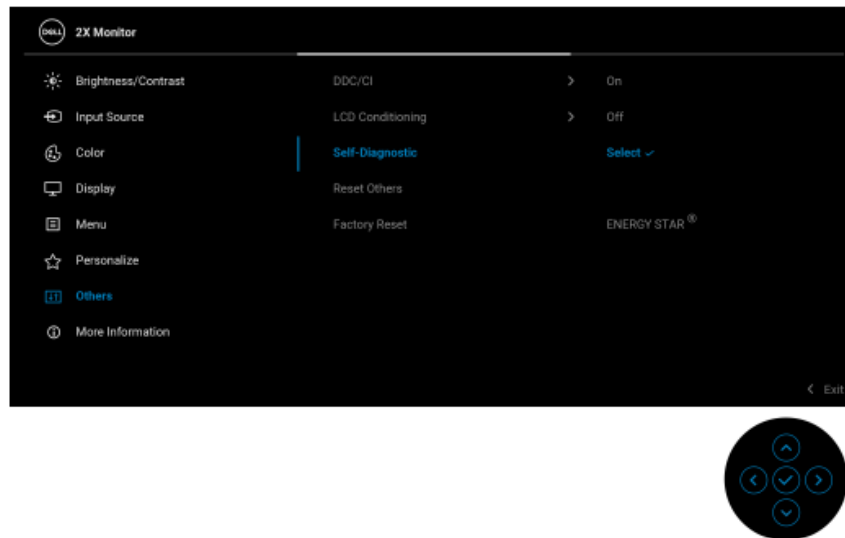

To run the built-in diagnostics:

1. Ensure that the screen is clean (no dust particles on the surface of the screen).
2. Move or press the joystick to launch the Menu Launcher.
3. Move the joystick up to select  and open the Main Menu.
4. Move the joystick to navigate and select **Others** and then **Self-Diagnostic**.
5. Press the joystick to initiate the built-in diagnostics. A gray screen is displayed.
6. Observe if the screen has any defects or abnormalities.
7. Toggle the joystick once again until a red screen is displayed.
8. Observe if the screen has any defects or abnormalities.
9. Repeat steps 7 and 8 until the screen displays green, blue, black, and white colors. Note any abnormalities or defects.

The test is complete when a text screen is displayed. To exit, toggle the joystick control again.

If you do not detect any screen abnormalities upon using the built-in diagnostic tool, the monitor is functioning properly. Check the video card and computer.

Common problems

The following table contains general information about common monitor problems you might encounter and the possible solutions:

Common symptoms	What you experience	Possible solutions
No video/power LED off	No picture	<ul style="list-style-type: none">• Ensure that the video cable connecting the monitor and the computer is properly connected and secure.• Verify that the power outlet is functioning properly using any other electrical equipment.• Ensure that the power button is pressed fully.• Ensure that the correct input source is selected in the Input Source menu.
No video/power LED on	No picture or no brightness	<ul style="list-style-type: none">• Increase brightness and contrast controls using the OSD.• Perform monitor self-test feature check.• Check for bent or broken pins in the video cable connector.• Run the built-in diagnostics. For more information, see Built-in diagnostics.• Ensure that the correct input source is selected in the Input Source menu.
Poor focus	Picture is fuzzy, blurry, or ghosting	<ul style="list-style-type: none">• Eliminate video extension cables.• Reset the monitor to factory settings.• Change the video resolution to the correct aspect ratio.
Shaky/jittery video	Wavy picture or fine movement	<ul style="list-style-type: none">• Reset the monitor to factory settings.• Check environmental factors.• Relocate the monitor and test in another room.

Missing pixels	LCD screen has spots	<ul style="list-style-type: none"> • Cycle power On-Off. • Pixel that is permanently off is a natural defect that can occur in LCD technology. • For more information on Dell Monitor Quality and Pixel Policy, see Dell Support site at: www.dell.com/pixelguidelines.
Stuck-on pixels	LCD screen has bright spots	<ul style="list-style-type: none"> • Cycle power On-Off. • Pixel that is permanently off is a natural defect that can occur in LCD technology. • For more information on Dell Monitor Quality and Pixel Policy, see Dell Support site at: www.dell.com/pixelguidelines.
Brightness problems	Picture too dim or too bright	<ul style="list-style-type: none"> • Reset the monitor to factory settings. • Adjust brightness and contrast controls using the OSD.
Geometric distortion	Screen not centered correctly	Reset the monitor to factory settings.
Horizontal/vertical lines	Screen has one or more lines	<ul style="list-style-type: none"> • Reset the monitor to factory settings. • Perform monitor self-test feature check and determine if these lines are also in self-test mode. • Check for bent or broken pins in the video cable connector. • Run the built-in diagnostics. For more information, see Built-in diagnostics.

Synchronization problems	Screen is scrambled or appears torn	<ul style="list-style-type: none"> • Reset the monitor to factory settings. • Perform monitor self-test feature check to determine if the scrambled screen appears in self-test mode. • Check for bent or broken pins in the video cable connector. • Restart the computer in the safe mode.
Safety related issues	Visible signs of smoke or sparks	<ul style="list-style-type: none"> • Do not perform any troubleshooting steps. • Contact Dell immediately.
Intermittent problems	Monitor malfunctions on and off	<ul style="list-style-type: none"> • Ensure that the video cable connecting the monitor to the computer is connected properly and is secure. • Reset the monitor to factory settings. • Perform monitor self-test feature check to determine if the intermittent problem occurs in self-test mode.
Missing color	Picture missing color	<ul style="list-style-type: none"> • Perform monitor self-test feature check. • Ensure that the video cable connecting the monitor to the computer is connected properly and is secure. • Check for bent or broken pins in the video cable connector.
Wrong color	Picture color not good	<ul style="list-style-type: none"> • Change the settings of the Preset Modes in the Color menu OSD depending on the application. • Adjust the R/G/B values under Custom Color in the Color menu OSD. • Change the Input Color Format to RGB or YCbCr/YPbPr in the Color settings OSD. • Run the built-in diagnostics. For more information, see Built-in diagnostics.

Image retention from a static image left on the monitor for a long period of time	Faint shadow from the static image displayed appears on the screen	<ul style="list-style-type: none"> • Set the screen to turn off after a few minutes of screen idle time. These can be adjusted in Windows Power Options or Mac Energy Saver setting. • Alternatively, use a dynamically changing screensaver.
Video ghosting or overshooting	Video ghosting, shadows or color smear while scrolling	Change the Response Time in the Display menu OSD to Normal or Fast , depending on your application and usage.
Picture quality (Refresh rate of native resolution changes from 60 Hz to 30 Hz; or color depth drops to 18 bits)	Issues of incorrect refresh rate or missing colors	<ul style="list-style-type: none"> • Set USB-C Prioritization to High Resolution. • Check the resolution settings of your graphic card.

Product specific problems

Specific symptoms	What you experience	Possible solutions
Screen image is too small	Image is centered on screen, but does not fill the entire viewing area	<ul style="list-style-type: none">• Check the Aspect Ratio setting in the Display menu OSD.• Reset the monitor to factory settings.
Cannot adjust the monitor with the joystick	OSD does not appear on the screen	<ul style="list-style-type: none">• Turn off the monitor, unplug the power cord, plug it back, and then turn on the monitor.• Check whether the OSD menu is locked. If yes, move and hold the joystick up/down/left/right for 4 seconds to unlock (see Lock and Locking the control buttons).
No input signal when you press the power button or toggle the joystick	No picture, the LED light is white	<ul style="list-style-type: none">• Check the signal source. Ensure the computer is not in the power saving mode by moving the mouse or pressing any key on the keyboard.• Check whether the signal cable is plugged in properly. Re-plug the signal cable if necessary.• Reset the computer or video player.
The picture does not fill the entire screen	The picture cannot fill the height or width of the screen	<ul style="list-style-type: none">• Due to different video formats (aspect ratio) of DVDs, the monitor may display in full screen.• Run the built-in diagnostics. For more information, see Built-in diagnostics.

No video at HDMI/DisplayPort/USB Type-C port	When connected to some dongle/docking device at the port, there is no video when unplugging/plugging the cable from the notebook	Unplug the HDMI/DisplayPort/USB Type-C cable from dongle/docking device, then plug the docking HDMI/DisplayPort/USB Type-C cable into the notebook.
No network connection	Network dropped or intermittent	<ul style="list-style-type: none"> • Check to ensure USB-C Prioritization is set to High Data Speed. • Do not turn off the display during network connection.
The LAN port is not functioning	OS setting or cable connection issue	<ul style="list-style-type: none"> • Ensure that the latest BIOS and drivers for your computer are installed on your computer. • Ensure that the RealTek Gigabit Ethernet Controller is installed in the Windows Device Manager. • If your BIOS Setup has a LAN/GBE Enabled/Disabled option, make sure it is set to Enabled. • Ensure that the Ethernet cable is connected securely on the monitor and the hub/router/firewall. • Check the status LED of the Ethernet cable to confirm connectivity. Re-connect both ends of the Ethernet cable if the LED is not lit. • First power off the computer and unplug the USB Type-C cable and the power cord from the monitor. Then, power on the computer and plug the power cord and the USB Type-C cable into the monitor.

When a PS console is connected, the monitor is not compatible with the 1080i (interlaced) video timing	A message appears to notify you that the monitor does not support the current input timing.	Change the resolution of the PS console in Safe Mode. For the information about setting up the resolution, go to the official website of PlayStation.
When the first monitor is connected to your PC or laptop using the USB-C connection, you might not be able to select the optimal resolution* for the 3rd (or more) monitor in Daisy chain mode in DP1.4 (DSC Disabled)	When MST is On and USB-C Prioritization is set to High Data Speed , the displayed pictures on the 3rd (or more) daisy chained monitor are not at the optimal resolution*	Switch USB-C Prioritization from High Data Speed to High Resolution (USB speed reduced to 2.0).

*The optimal resolution for **P2425HE/P2425HE WOST/P2725HE** is **1920 x 1080** at 60 Hz; the optimal resolution for **P2425E** is **1920 x 1200** at 60 Hz.

Universal Serial Bus (USB) specific problems

Specific symptoms	What you experience	Possible solutions
USB interface is not working	USB peripherals are not working	<ul style="list-style-type: none"> • Check that your monitor is turned On. • Reconnect the upstream cable to your computer. • Reconnect the USB peripherals (downstream connector). • Switch off and then turn on the monitor again. • Reboot the computer. • Some USB devices like external portable HDD require higher electric current; connect the device directly to the computer system.
USB Type-C port does not supply power	USB peripherals can not be charged	<ul style="list-style-type: none"> • Check that the connected device is compliant with the USB-C specification. The USB Type-C port (video and data) with  icon supports USB 3.2 Gen1 and an output of 90 W. • Check that you use the USB Type-C cable shipped with your monitor.
Super speed USB 5 Gbps (USB 3.2 Gen1) interface is slow	Super speed USB 5 Gbps (USB 3.2 Gen1) peripherals working slowly or not working at all	<ul style="list-style-type: none"> • Check that your computer is super speed USB 5 Gbps (USB 3.2 Gen1)-compatible. • Some computers have USB 3.2, USB 2.0, and USB 1.1 ports. Ensure that the correct USB port is used. • Reconnect the upstream cable to your computer. • Reconnect the USB peripherals (downstream connector). • Reboot the computer.

Wireless USB peripherals stop working when a USB 3.2 device is plugged in	Wireless USB peripherals responding slowly or only working as the distance between itself and its receiver decreases	<ul style="list-style-type: none"> • Increase the distance between the USB 3.2 peripherals and the wireless USB receiver. • Position your wireless USB receiver as close as possible to the wireless USB peripherals. • Use a USB-extender cable to position the wireless USB receiver as far away as possible from the USB 3.2 port.
Wireless USB mouse does not work properly	When plugged into one of the USB ports on the rear side of the monitor, the Wireless USB mouse lags or freezes during use	Unplug the Wireless USB Mouse receiver and re-plug it into one of the Quick Access USB ports at the bottom of the monitor.