

Wireless Speaker
ULT FIELD 1

Model: YY7862E

Design and specifications are subject to change without notice.

Quick Start Guide**Download the app**

By using "Sony | Music Center," you can adjust an equalizer and the sound quality on the speaker connected via a BLUETOOTH® connection. You can also operate and play from various audio sources connected to the speaker. To use all the functions and performance enhancements, use the latest versions of "Sony | Music Center" and the internal software for the speaker. For details, see the following.

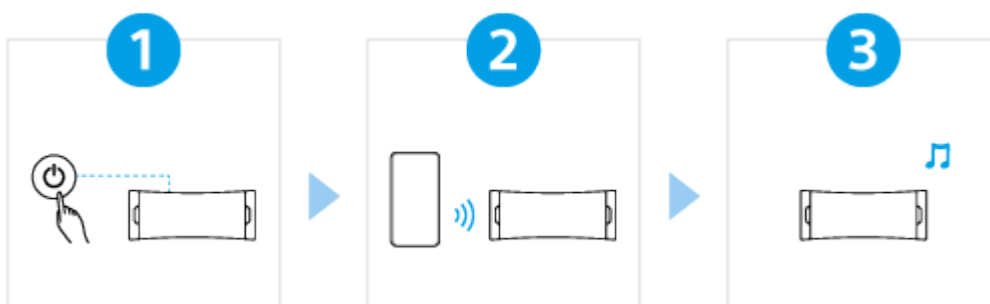

<https://www.sony.net/elesupport/>

Let's start to use

1

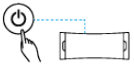
Turning the power on



Press the  (power) button. When you use the speaker for the first time after purchase, the speaker automatically enters pairing mode and the  (BLUETOOTH) indicator starts double flashing (pairing mode).

2

Connecting with BLUETOOTH devices



Operate the BLUETOOTH device to perform the pairing procedure and/or to establish a BLUETOOTH connection.

When a BLUETOOTH connection is established, you hear the notification sound from the speaker and the activity of the  (BLUETOOTH) indicator changes from flashing to lit.

3

Listening to music



Start playback on a BLUETOOTH device.

SRS-ULT10

Getting started

[Parts and controls](#)

[Placing the speaker](#)

Included items

- [Using the strap](#)

Power source/charging

- [Charging the speaker](#)
- [Turning the power on](#)
- [Turning the power off](#)
- [Auto Standby \(power saving\) function](#)
- [Using the speaker with less power consumption of the rechargeable battery \(STAMINA\)](#)

Making connections

BLUETOOTH device

- [How to make wireless connections to BLUETOOTH devices](#)
- [Connecting to BLUETOOTH devices easily with "Sony | Music Center" via a BLUETOOTH connection](#)
- [Pairing and connecting with BLUETOOTH devices](#)
- [Connecting with a computer via a BLUETOOTH connection \(Windows®\)](#)

[Connecting with a computer via a BLUETOOTH connection \(Mac\)](#)

Listening to music

BLUETOOTH device

[Listening to music of a device via a BLUETOOTH connection](#)

[Selecting the quality for music playback via a BLUETOOTH connection \(Codec\)](#)

[Supported codecs](#)

[Terminating the BLUETOOTH connection \(After use\)](#)

[Enjoying switching the sound effects](#)

Stereo Pair function

[Listening to music wirelessly with 2 speakers \(Stereo Pair function\)](#)

Phone calls

[Making a video call on a computer](#)

[Receiving a call](#)

[Making a call](#)

Using “Sony | Music Center”

[What you can do with “Sony | Music Center”](#)

[Installing “Sony | Music Center”](#)

Using the voice assist function

[Using the voice assist function \(Google™ app\)](#)

[Using the voice assist function \(Siri\)](#)

Information

[About the indicators](#)

[Updating the pre-installed software](#)

Notes on use

[Precautions](#)

[Notes on charging](#)

[Notes on waterproof and dustproof features](#)

[How to care for the speaker](#)

[About the BLUETOOTH wireless technology.](#)

[Licenses](#)

[Trademarks](#)

Troubleshooting

[What can I do to solve a problem?](#)

Power supply

[Unable to charge the speaker](#)

[Unable to turn on the speaker or the speaker suddenly turns off](#)

Sound

[No sound/Sound from only one speaker/Low sound level/Distorted sound/Humming or noise in the speaker output/No voice or low voice from callers](#)

[Sound becomes low while in use](#)

BLUETOOTH connection

[Unable to pair the speaker with a BLUETOOTH device](#)

[Speaker output is interrupted](#)

[Unable to connect a BLUETOOTH device with the speaker for the Stereo Pair function](#)

Reset

[Restarting the speaker](#)

[Initializing the speaker](#)

Specifications

[Specifications](#)

Parts and controls

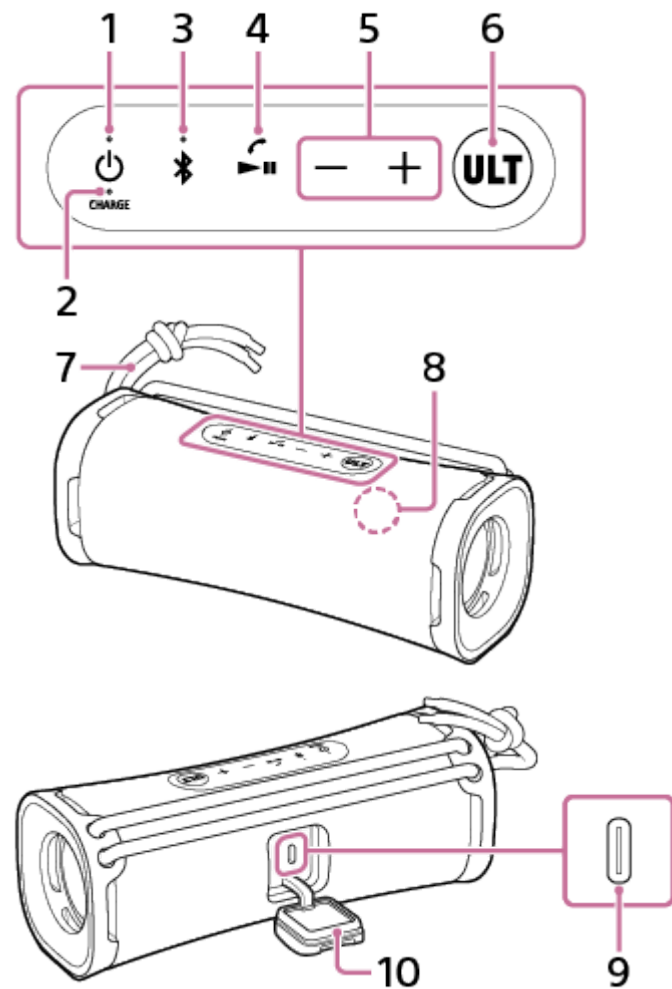

1. ⏻ (power) button with indicator
2. CHARGE indicator
3. 📶 (BLUETOOTH) button with indicator
4. ▶|| (play) button/ 📞 (call) button
5. -/+ (volume) buttons
6. ULT button
7. Strap
8. Microphone
9. DC input port (USB Type-C®)*
10. Cap

* This port is not compatible with music playback.

Related Topic

- [About the indicators](#)

5-057-417-11(1) Copyright 2024 Sony Corporation

Wireless Speaker
ULT FIELD 1

Placing the speaker

The speaker can be placed in the vertical orientation as well.

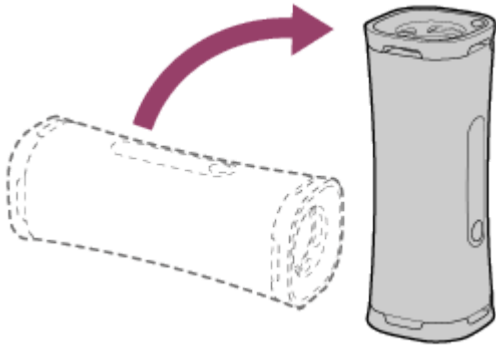

Using the strap

You can carry around the speaker effortlessly by holding the strap attached to the speaker.

1 Adjust the length of the strap.

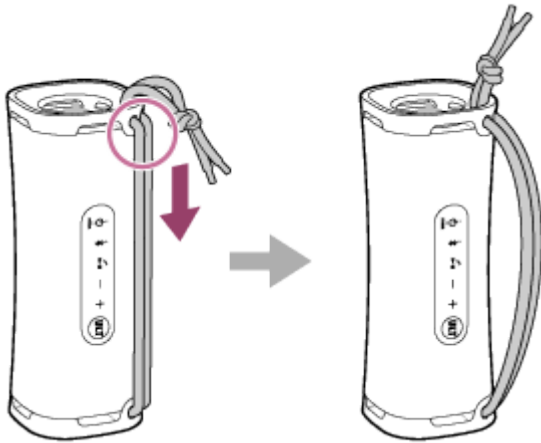

Note

- Do not use anything other than the supplied strap.
- Do not pull hard on the strap attached to the speaker or swing the speaker around.
- Do not use the strap with any device other than the speaker.

Charging the speaker

The speaker is capable of running on power either from an AC outlet connected by a USB AC adaptor (commercially available) and the supplied USB Type-C cable or from the rechargeable built-in battery.

When using the speaker for the first time, be sure to charge the built-in battery for more than 1 hour before turning on the speaker.

With the built-in battery charged in advance, you can use the speaker solely with battery power.

1 Connect the speaker to an AC outlet to charge it.

Connect one end of the supplied USB Type-C cable to the DC input port on the speaker and the other end to a USB AC adaptor (commercially available), and then connect the USB AC adaptor to an AC outlet.

The speaker supports USB AC adaptors that are capable of delivering an output current of 3.0 A or 1.5 A. When using a USB AC adaptor with an output current of 3.0 A for battery charging, be sure to use a USB Type-C cable (compliant with the USB standard) that supports an output current of 3.0 A. The supplied USB cable supports an output current of up to 1.5 A. Use of any other devices is not guaranteed for battery charging. The charging time may vary depending on the ambient temperature or the usage of the speaker as well.

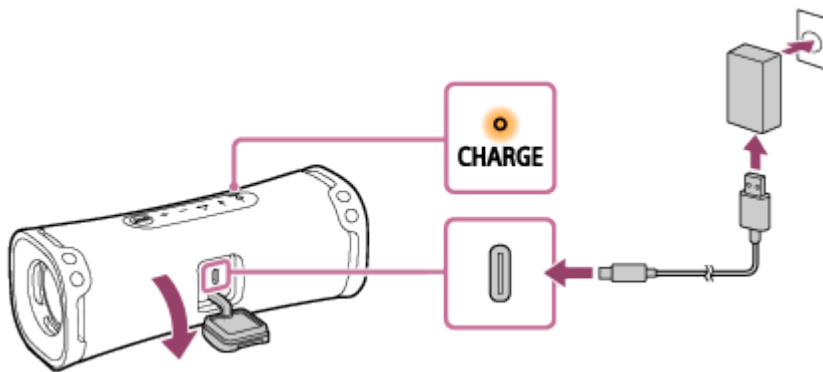

The CHARGE indicator lights up in orange while charging is in progress.

The estimated charging time varies depending on the power output capacity of the connected USB AC adaptor (commercially available). In addition, it may take longer than the charging time stated below depending on the type and specification of the USB AC adaptor and USB cable. The charging time may differ from the time stated below depending on the ambient temperature or the usage of the speaker as well.

The following time is stated as a reference.

- When a commercially available USB AC adaptor capable of delivering an output current of 1.5 A is connected, charging completes in about 5 hours* and the CHARGE indicator turns off.
- When using a commercially available USB AC adaptor, make sure that it is capable of delivering an output current of 1.5 A or more. You can use a USB AC adaptor with an output current of 500 mA or more and less than 1.5 A as well, but it may take a very long time before charging completes. When using such a USB AC adaptor, it is recommended that you turn off the speaker before battery charging.
Use of a USB AC adaptor with an output current of less than 500 mA is not guaranteed for battery charging.

* Time required for the empty battery to be fully charged (100%) while the speaker is turned off.

After you disconnect the USB cable from the speaker upon completion of battery charging, be sure to close the cap securely.

The cap plays a very important role in maintenance of the waterproof and dustproof performance.

Checking the charging completion

If the built-in battery is fully charged when you connect the speaker to an AC outlet with a USB AC adaptor (commercially available), the CHARGE indicator lights up in orange then turns off after about 1 minute.

- **When using the Android™ smartphone with Android 8.1 or later installed**

When the speaker is connected with the Android smartphone via an HFP (Hands-free Profile) BLUETOOTH connection, tap [Settings] - [Device connection] - [Bluetooth] on the smartphone. The remaining battery power of the speaker is displayed along with the connected BLUETOOTH device name. For details, refer to the operating instructions supplied with the Android smartphone.

Note that the remaining battery power displayed on the smartphone may vary from the actual remaining battery power of the speaker. Consider this information as a reference.

- **When using the iPhone**

While the speaker is connected with the iPhone via an HFP (Hands-free Profile) BLUETOOTH connection, the remaining battery power of the speaker is displayed on the widget screen of the iPhone. For details, refer to the operating instructions supplied with the iPhone.

Note that the remaining battery power displayed on the iPhone may vary from the actual remaining battery power of the speaker. Consider this information as a reference.

Built-in battery life

- Approx. 12 hours

- Volume level: 25

- Sound: ULT POWER SOUND on

- Approx. 3 hours

- Volume level: 50 (MAX.)

- Sound: ULT POWER SOUND on

The built-in battery life above is measured using our specified music source.

Actual performance time may vary from the listed time due to the volume, songs played, surrounding temperature, and usage conditions.

When the built-in battery is running low

When the CHARGE indicator starts flashing slowly, the built-in battery is running low and needs to be charged.

If the CHARGE indicator flashes 3 times in orange and goes out when you turn on the speaker, the built-in battery is empty and needs to be charged.

Hint

- You can charge the speaker's built-in battery by connecting the speaker to a computer that comes equipped with a USB charging port as well. However, not all the computers are tested and found compatible with this procedure and the procedure is not applicable to home-built computers.
- As long as the speaker is connected to an AC outlet by a USB AC adaptor (commercially available) or to a computer that comes equipped with a USB charging port, the speaker's built-in battery is capable of charging itself even while music playback from the speaker is in progress. However, it may take a long time before charging completes depending on the usage of the speaker. It is recommended that you turn off the speaker before battery charging.
- Turn on STAMINA on "Sony | Music Center" to reduce the power consumed while using the rechargeable built-in battery so you can enjoy playing music for a longer time.

Note



- Depending on the type or specifications of the USB AC adaptor, if you use the speaker at a loud volume, the remaining power of the rechargeable built-in battery may decrease or the speaker may turn off even while the speaker is connected to an AC outlet by the USB AC adaptor. This, however, does not indicate a malfunction. If such a case occurs, turn off the speaker and let the battery fully charge itself before you use the speaker.
- The maximum power output of the speaker may be lower when the built-in battery is running low.
- In an extremely cold or hot environment, charging stops for safety. If charging takes a long time, it also makes charging of the speaker stop. To resolve these issues, disconnect the USB cable, and then connect it again within an operating temperature between 5 °C and 35 °C (41 °F and 95 °F).
- Do not charge the speaker's built-in battery in places where water may splash on it. The supplied USB Type-C cable as well as the USB port behind the cap are designed neither for waterproof nor for dustproof.
- Even if you do not intend to use the speaker for a long time, charge the built-in battery sufficiently once every 6 months to maintain its performance.
- When the Android smartphone is configured to use only A2DP (Advanced Audio Distribution Profile) for establishing BLUETOOTH connections, the remaining battery power of the speaker is not displayed on the smartphone.

Related Topic

- [Turning the power on](#)
- [What you can do with "Sony | Music Center"](#)
- [Notes on charging](#)

Turning the power on

1 Press the (power) button.

You hear the notification sound from the speaker, the  (power) indicator lights up in green, and the  (BLUETOOTH) indicator flashes slowly in blue.

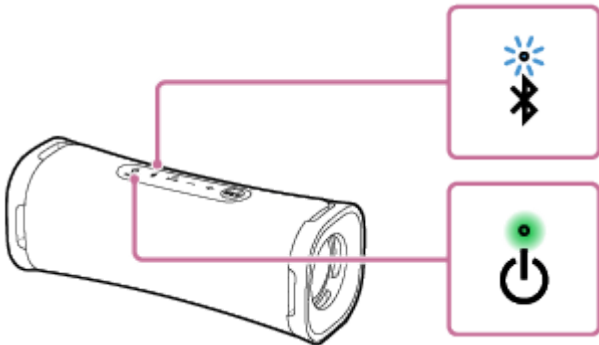

When the speaker has no pairing information, for example when you use the BLUETOOTH function for the first time after purchase, the  (BLUETOOTH) indicator keeps double flashing in blue.

Note

- If the CHARGE indicator flashes 3 times and the speaker turns off after you turn it on, the rechargeable built-in battery is empty. Charge the built-in battery.
- When the CHARGE indicator starts flashing slowly, the built-in battery is running low and needs to be charged.



Related Topic

- [Charging the speaker](#)
- [Turning the power off](#)

Wireless Speaker
ULT FIELD 1

Turning the power off

1 Press the (power) button.

You hear the notification sound from the speaker, and the  (power) indicator and the  (BLUETOOTH) indicator turn off.

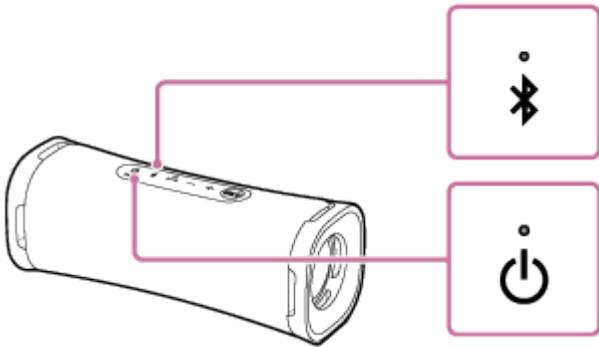

Related Topic

- [Auto Standby \(power saving\) function](#)

Wireless Speaker
ULT FIELD 1

Auto Standby (power saving) function

In the event of the following, the speaker automatically turns off in 15 minutes to conserve the power of the rechargeable built-in battery.

At the time of purchase, the Auto Standby function is set to on.

- No operation on the speaker.
- The hands-free function of the connected smartphone or mobile phone is set to off and the smartphone or mobile phone is not playing music (audio), nor is it being operated. For details, refer to the operating instructions supplied with the smartphone or mobile phone.
- The connected BLUETOOTH device is not playing music (audio), nor is it being operated.





Hint

- You can turn on or off the Auto Standby function by using "Sony | Music Center."

Note

- Disabling this function will increase the power consumption because the product will not turn off automatically when not being used.
- While the speaker is connected with an Android smartphone or an iPhone via an HFP (Hands-free Profile) BLUETOOTH connection, the Auto Standby function is turned off.

Turning on/off the Auto Standby function

- 1 Turn on the speaker.
- 2 Press and hold the  (play)/  (call) button and the – (volume) button simultaneously for about 5 seconds.
 - When the Auto Standby function is turned off, the  (power) indicator flashes 3 times in green.
 - When the Auto Standby function is turned on, the  (power) indicator flashes twice in green.

Wireless Speaker
ULT FIELD 1

Using the speaker with less power consumption of the rechargeable battery (STAMINA)

Reduce the power consumed while the speaker is running on the rechargeable built-in battery so you can use the speaker for a longer period of time.

To use STAMINA

At the time of purchase, the STAMINA power option is set to off.

On "Sony | Music Center," tap [ULT FIELD 1] - [Settings] - [Power Option] - [STAMINA], and then set it to on.

While the STAMINA power option is set to on, the sound effects, including the ULT POWER SOUND, are set to off.

Wireless Speaker
ULT FIELD 1

How to make wireless connections to BLUETOOTH devices

You can enjoy music with the speaker wirelessly by using your BLUETOOTH device's BLUETOOTH function.

Pairing

Pairing is the process required to mutually register the information on BLUETOOTH devices to be connected wirelessly. To pair with a second or subsequent BLUETOOTH device, perform the following pairing procedure for each device. Pair the speaker and the device manually.

Connecting to a paired device

Once a device is paired, it is not necessary to pair it again. Connect to devices already paired with the speaker using the methods necessary for each device.

For details about pairing and connection operations, see the related topics below.

Related Topic

- [Connecting to BLUETOOTH devices easily with "Sony | Music Center" via a BLUETOOTH connection](#)
- [Pairing and connecting with BLUETOOTH devices](#)
- [Connecting with a computer via a BLUETOOTH connection \(Windows®\)](#)
- [Connecting with a computer via a BLUETOOTH connection \(Mac\)](#)

Wireless Speaker
ULT FIELD 1

Connecting to BLUETOOTH devices easily with “Sony | Music Center” via a BLUETOOTH connection

Launch the “Sony | Music Center” on your Android smartphone/iPhone to connect the speaker to a smartphone or iPhone. For details about “Sony | Music Center,” refer to the following URL:

<https://www.sony.net/smcqa/>



Sony Music Center



Note

- The connection with some smartphones and iPhone devices may become unstable when connecting using the “Sony | Music Center.” In that case, follow the procedures in “[Pairing and connecting with BLUETOOTH devices](#)” to connect to the speaker.

Related Topic

- [How to make wireless connections to BLUETOOTH devices](#)
- [Pairing and connecting with BLUETOOTH devices](#)
- [Connecting with a computer via a BLUETOOTH connection \(Windows®\)](#)
- [Connecting with a computer via a BLUETOOTH connection \(Mac\)](#)
- [What you can do with “Sony | Music Center”](#)
- [Installing “Sony | Music Center”](#)

Wireless Speaker
ULT FIELD 1

Pairing and connecting with BLUETOOTH devices

Pairing is the process required to mutually register the information on BLUETOOTH devices to be connected wirelessly. To use multiple BLUETOOTH devices in combination with the speaker, perform the following pairing procedure for each device.

The pairing information of the BLUETOOTH devices is stored on the speaker when the speaker is turned off.

Before operating the speaker, be sure to do the following:

- Place the BLUETOOTH device within 1 m (3.2 ft) of the speaker.
- Connect the speaker to an AC outlet via a USB AC adaptor (commercially available). Or charge the built-in battery sufficiently.
- To avoid any sudden loud sound output from the speaker, turn down the volume of both the BLUETOOTH device and the speaker or stop music playback.
Depending on the BLUETOOTH device, the volume of the device may be synchronized with the speaker volume when music playback starts after a BLUETOOTH connection is established between the BLUETOOTH devices and the speaker.
- Prepare the operating instructions supplied with the BLUETOOTH device for reference.

1 Turn on the speaker.

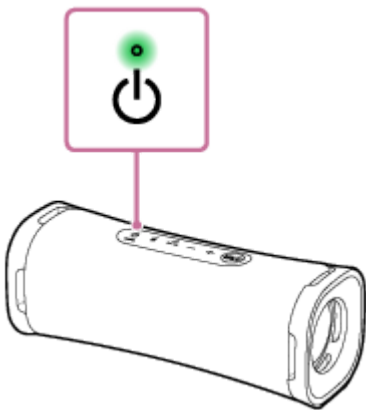

2 Check the status of the (BLUETOOTH) indicator.

When the indicator is double flashing

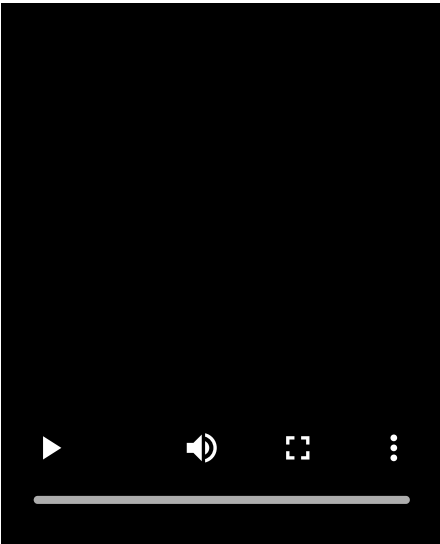

In the event that the speaker is paired with a BLUETOOTH device for the first time after purchase or in the event after the speaker is initialized (the speaker has no pairing information), the speaker automatically enters pairing mode when it is turned on. Proceed to step 4 .

When the indicator is flashing slowly

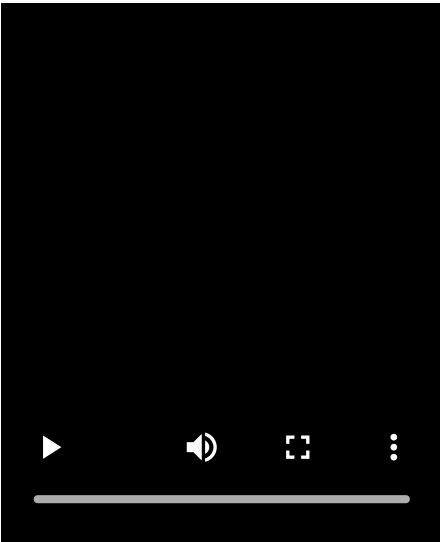

The speaker is searching for a BLUETOOTH device.

- To pair the speaker with a second or subsequent BLUETOOTH device (when the speaker has pairing information of other BLUETOOTH devices), proceed to step 3 .
- To reconnect the speaker with one of the BLUETOOTH devices that have been paired with the speaker before, proceed to step 4 . The speaker will automatically be connected just by turning on the BLUETOOTH function on the BLUETOOTH device. Depending on the BLUETOOTH device, the speaker may be reconnected with the device right after it is turned on. For details, refer to the operating instructions supplied with your BLUETOOTH device.

When the indicator stays lit

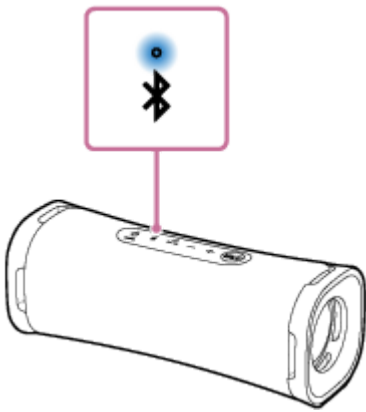

The speaker has been connected to the BLUETOOTH device.

To connect to other BLUETOOTH devices, follow one of the procedures below.

- To pair the speaker with a second or subsequent BLUETOOTH device (when the speaker has pairing information of other BLUETOOTH devices), proceed to step 3 .
- To reconnect the speaker with one of the BLUETOOTH devices that have been paired with the speaker before, proceed to step 4 . The speaker will automatically be connected just by turning on the BLUETOOTH function on the BLUETOOTH device.

3 Press the  (BLUETOOTH) button.

You hear voice guidance (Pairing) from the speaker and the  (BLUETOOTH) indicator starts double flashing (pairing mode).

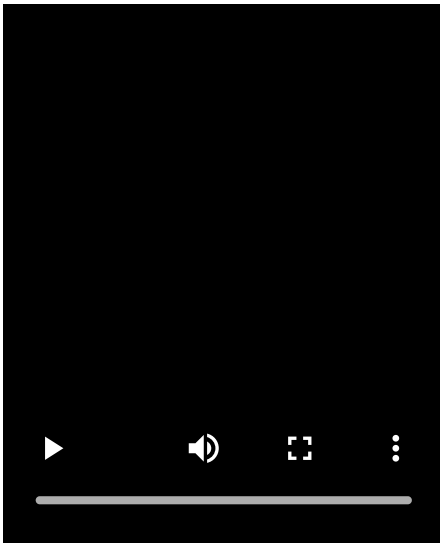

4 Perform the pairing procedure on the BLUETOOTH device to detect the speaker.

When a list of detected devices appears on the display of the BLUETOOTH device, select “ULT FIELD 1.”

If a passkey* is required on the display of the BLUETOOTH device, enter “0000.”

* The passkey may be called a “passcode,” “PIN code,” “PIN number,” or “password.”

5 Make the BLUETOOTH connection from the BLUETOOTH device.

When the BLUETOOTH connection is established, you hear the notification sound from the speaker and the activity of the  (BLUETOOTH) indicator changes from flashing to lit.

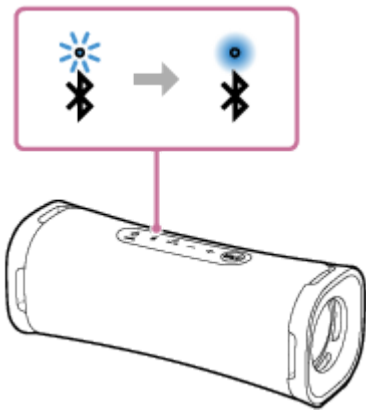

If the BLUETOOTH connection is not established, repeat from step ③.

Hint

- As long as the BLUETOOTH function is activated on a BLUETOOTH device that has previously been connected with the speaker, the speaker is reconnected with the device right after the speaker is turned on.
- The above instructions on the BLUETOOTH device are provided as an example. For details, refer to the operating instructions supplied with the BLUETOOTH device.

Note

- The pairing mode of the speaker is released after about 5 minutes and the  (BLUETOOTH) indicator flashes slowly. However, when the speaker has no pairing information, such as at the factory settings, the pairing mode is not released. If the pairing mode is released before finishing the process, repeat from step ③.
- The passkey of the speaker is "0000." If a passkey besides "0000" is set on the BLUETOOTH device, pairing cannot be done with the speaker.
- Once the BLUETOOTH devices are paired, there is no need to pair them again, except in the following cases:
 - Pairing information has been deleted after repair, etc.
 - The speaker is already paired with 8 devices and another device is to be paired.
The speaker can be paired with up to 8 devices. When a new device is paired in addition to 8 paired devices, the pairing information of the earliest device connected via a BLUETOOTH connection is replaced by the information of the new one.
 - The pairing information with the speaker has been deleted from the BLUETOOTH device.
 - The speaker is initialized.
All pairing information will be deleted. If you initialize the speaker, it may not be able to connect your BLUETOOTH device. In this case, erase the pairing information of the speaker on your BLUETOOTH device, and then perform the pairing procedure again.
- The speaker can be paired with multiple devices, but can only play music from one paired device at a time.

Related Topic

- [Listening to music of a device via a BLUETOOTH connection](#)
- [Terminating the BLUETOOTH connection \(After use\)](#)

Wireless Speaker
ULT FIELD 1

Connecting with a computer via a BLUETOOTH connection (Windows®)

Pairing is the process required to mutually register the information on BLUETOOTH devices to be connected wirelessly. To use multiple BLUETOOTH devices in combination with the speaker, perform the following pairing procedure for each device.

The pairing information of the BLUETOOTH devices is stored on the speaker when the speaker is turned off.

Supported operation systems

Windows 11, Windows 10

Do the following before starting.

- Place your computer within 1 m (3.2 ft) of the speaker.
- Connect the speaker to an AC outlet via a USB AC adaptor (commercially available). Or charge the built-in battery sufficiently.
- Prepare the operating instructions supplied with the computer for reference.
- To avoid any sudden loud sound output from the speaker, turn down the volume of both the computer and the speaker or stop music playback.
- Set the speaker of your computer to on.
If the speaker of your computer is set to  (mute), sound does not output on the BLUETOOTH speaker.

– When the speaker of your computer is set to on:



1 Turn on the speaker.

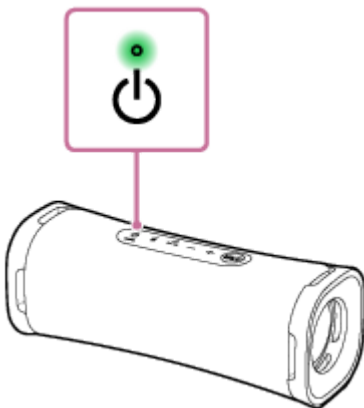

2 Check the (BLUETOOTH) indicator for activity.

When the indicator is double flashing

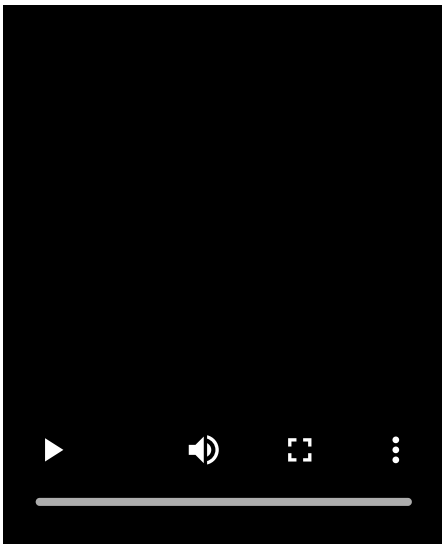

In the event that the speaker is paired with a BLUETOOTH device for the first time after purchase or in the event after the speaker is initialized (the speaker has no pairing information), the speaker automatically enters pairing mode when it is turned on. Proceed to step ④ .

When the indicator is flashing slowly

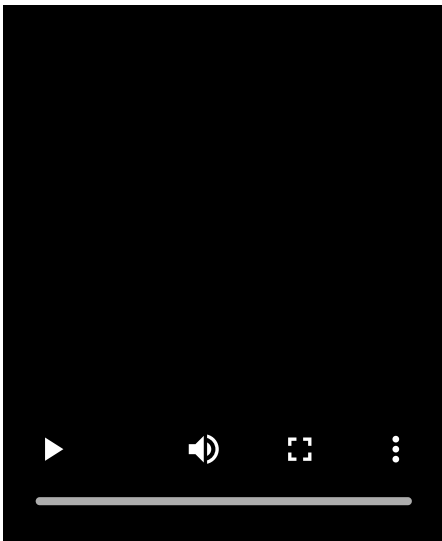

The speaker is searching for BLUETOOTH connections.

- To pair the speaker with a second or subsequent BLUETOOTH device (when the speaker has pairing information of other BLUETOOTH devices), proceed to step ③ .
- To reconnect the speaker with one of the BLUETOOTH devices that have been paired with the speaker before, proceed to step ⑥ .
The speaker will automatically be connected with the computer just by turning on the BLUETOOTH function on the computer.
Depending on the BLUETOOTH device, the speaker may be reconnected with the device right after it is turned on. For details, refer to the operating instructions supplied with your BLUETOOTH device.

When the indicator stays lit

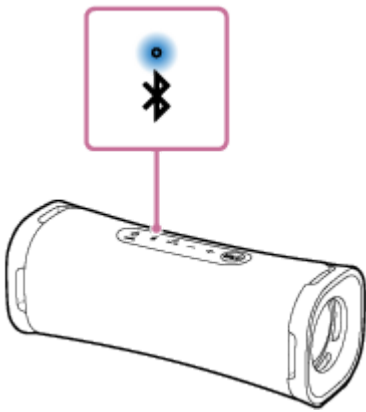

The speaker is already connected with one of the BLUETOOTH devices.

To connect the speaker with another BLUETOOTH device, do either of the following:

- To pair the speaker with a second or subsequent BLUETOOTH device (when the speaker has pairing information of other BLUETOOTH devices), proceed to step **3**.
- To reconnect the speaker with one of the BLUETOOTH devices that have been paired with the speaker before, proceed to step **6**.
The speaker will automatically be connected with the computer just by turning on the BLUETOOTH function on the computer.

3 Press the  (BLUETOOTH) button.

You hear voice guidance (Pairing) from the speaker and the  (BLUETOOTH) indicator starts double flashing (pairing mode).

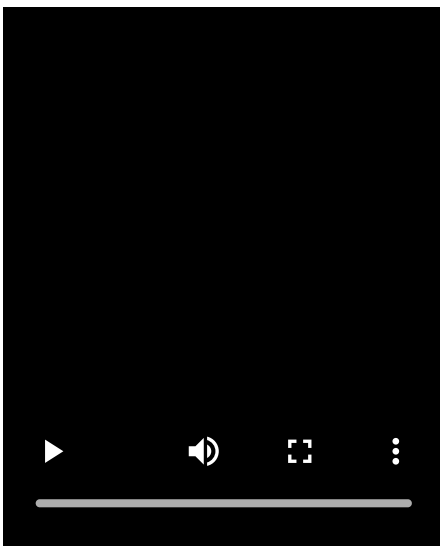

4 Wake the computer up if the computer is in standby (sleep) or hibernation mode.

5 Register the speaker to the computer.

On Windows 11

1. Click the [Start] button, then [Settings].
2. Click [Bluetooth & devices].

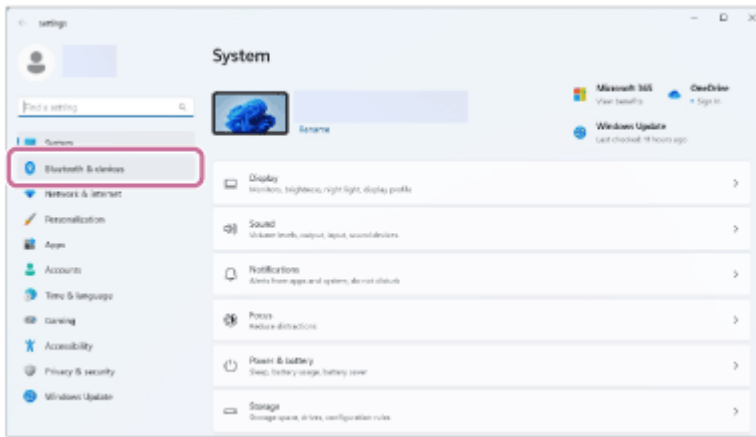

3. Click the [Bluetooth] switch to turn on the BLUETOOTH function, and then click [Add device].

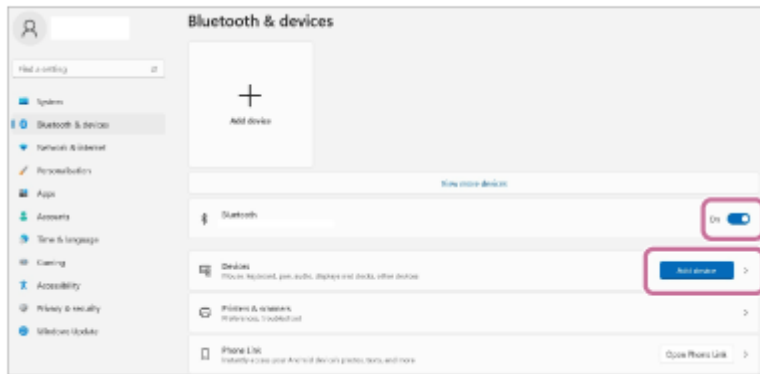

4. Click [Bluetooth].

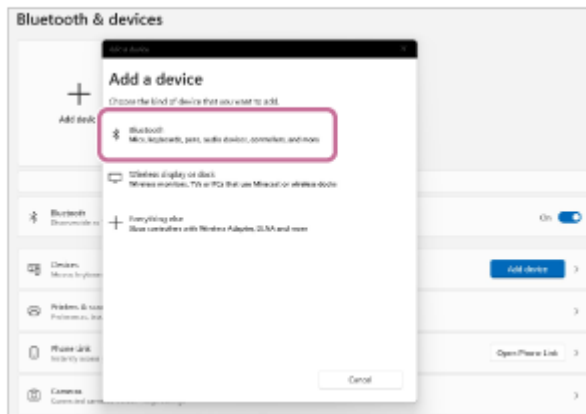

5. Select [ULT FIELD 1].

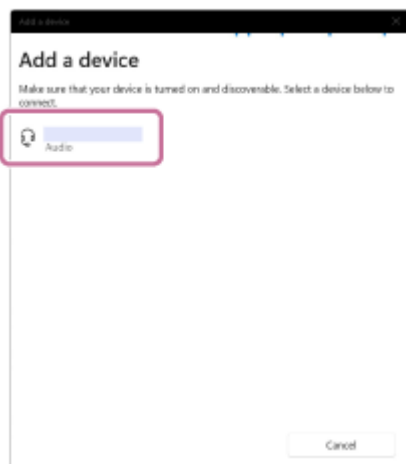

If a passkey* is required, enter "0000."

If [ULT FIELD 1] does not appear, perform the operation again from step 3.

* The passkey may be called a "passcode," "PIN code," "PIN number," or "password."

6. After pairing, the BLUETOOTH connection establishes automatically and [Connected music] or [Connected voice, music] will be displayed on the screen. Proceed to step 7 .



On Windows 10

1. Click the [Start] button, then [Settings].
2. Click [Devices].

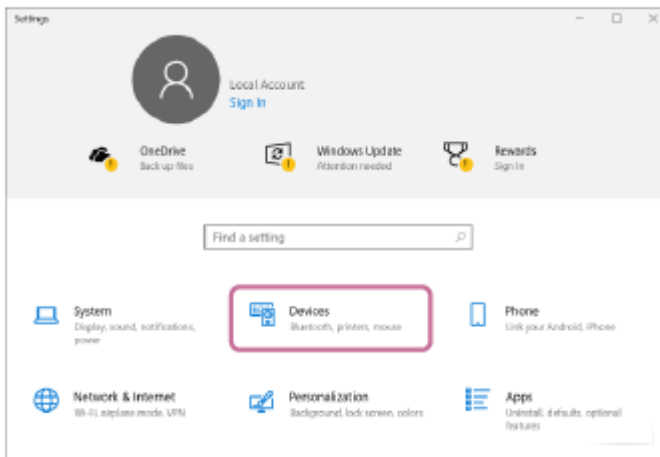

3. Click the [Bluetooth & other devices] tab, click the [Bluetooth] switch to turn on the BLUETOOTH function, and then click [Add Bluetooth or other device].

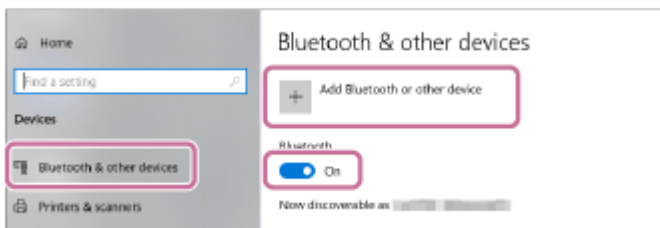

4. Click [Bluetooth].

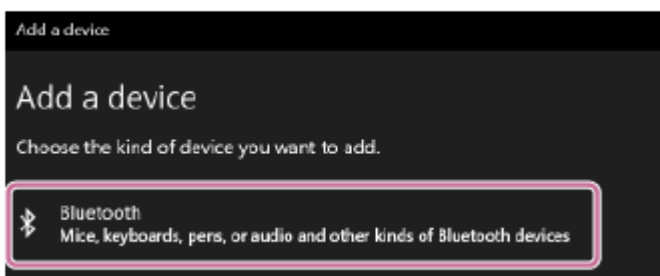

5. Select [ULT FIELD 1].

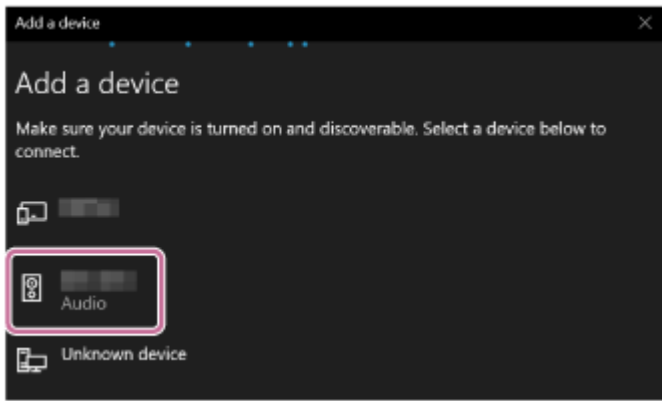

If a passkey* is required, enter "0000."

If [ULT FIELD 1] does not appear, perform the operation again from step 3 .

* The passkey may be called a "passcode," "PIN code," "PIN number," or "password."

6. After pairing, the BLUETOOTH connection establishes automatically and [Connected music] or [Connected voice, music] will be displayed on the screen. Proceed to step 7 .

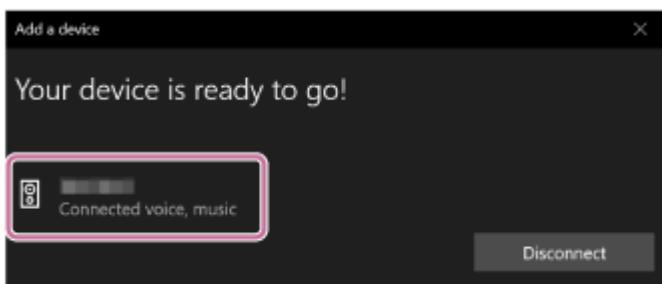

6 Select the speaker on the computer.

On Windows 11

1. Click the [Start] button, then [Settings].
2. Click [Bluetooth & devices].
3. Select [ULT FIELD 1] and click [Connect].

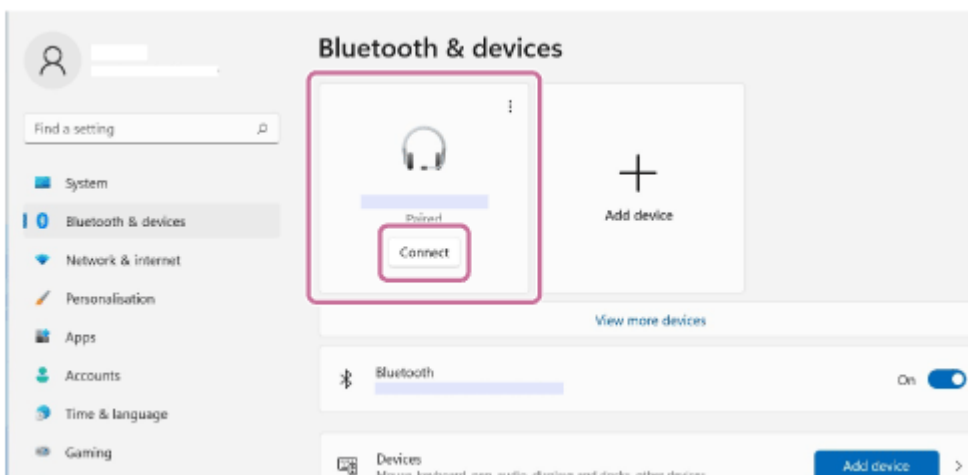

The icon on the screen may look different from what you actually see.

When a BLUETOOTH connection is established, [Connected music] or [Connected voice, music] will be displayed on the screen. Proceed to step 7 .

On Windows 10

1. Click the [Start] button, then [Settings].

2. Click [Devices].

3. Select [ULT FIELD 1] under “Audio” on the [Bluetooth & other devices] tab, and then click [Connect].

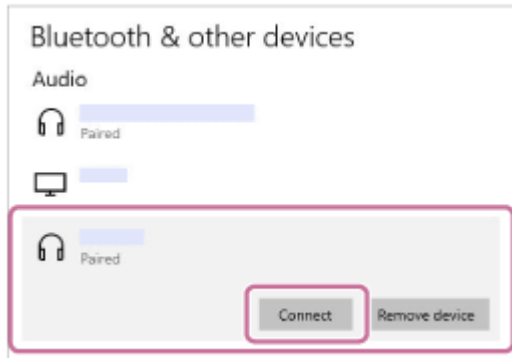

The icon on the screen may look different from what you actually see.

When a BLUETOOTH connection is established, [Connected music] or [Connected voice, music] will be displayed on the screen. Proceed to step 7 .

7 Follow the on-screen instructions to establish a BLUETOOTH connection.

When the BLUETOOTH connection is established, you hear the notification sound from the speaker and the activity of the  (BLUETOOTH) indicator changes from flashing to lit.

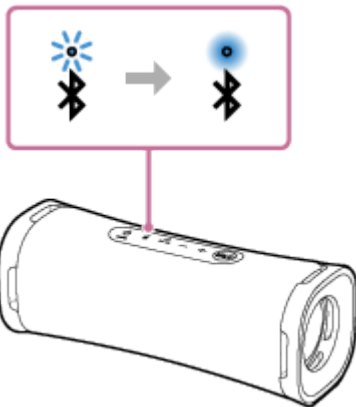

If the connection attempt fails, repeat the procedure from step 3 .

Hint

- The above instructions on the computer are provided as an example. For details, refer to the operating instructions supplied with your computer. In addition, not all the computers are tested and found compatible with the above procedure and the procedure is not applicable to home-built computers.

Note

- The pairing mode of the speaker is released after about 5 minutes and the  (BLUETOOTH) indicator flashes slowly. However, when the speaker has no pairing information, such as at the factory settings, the pairing mode is not released. If the pairing mode is released before finishing the process, repeat from step 3 .
- Once BLUETOOTH devices are paired, there is no need to pair them again, except in the following cases:
 - Pairing information has been deleted after repair, etc.
 - The speaker is already paired with 8 devices and another device is to be paired.
The speaker can be paired with up to 8 devices. When a new device is paired in addition to 8 paired devices, the pairing information of the earliest device connected via a BLUETOOTH connection is replaced by the information of the new one.

- The pairing information with the speaker has been deleted from the BLUETOOTH device.
- The speaker is initialized.
All pairing information will be deleted. If you initialize the speaker, it may not be able to connect your computer. In this case, erase the pairing information of the speaker on your computer, and then perform the pairing procedure again.
- The speaker can be paired with multiple devices, but can only play music from one paired device at a time.
- The passkey of the speaker is “0000.” If a passkey besides “0000” is set on the BLUETOOTH device, pairing cannot be done with the speaker.

Related Topic

- [Listening to music of a device via a BLUETOOTH connection](#)
- [Terminating the BLUETOOTH connection \(After use\)](#)

5-057-417-11(1) Copyright 2024 Sony Corporation

Wireless Speaker
ULT FIELD 1

Connecting with a computer via a BLUETOOTH connection (Mac)

Pairing is the process required to mutually register the information on BLUETOOTH devices to be connected wirelessly. To use multiple BLUETOOTH devices in combination with the speaker, perform the following pairing procedure for each device.

The pairing information of the BLUETOOTH devices is stored on the speaker when the speaker is turned off.

Supported operation systems

macOS Monterey (version 12.6)

Do the following before starting.

- Place your computer within 1 m (3.2 ft) of the speaker.
- Connect the speaker to an AC outlet via a USB AC adaptor (commercially available). Or charge the built-in battery sufficiently.
- Prepare the operating instructions supplied with the computer for reference.
- To avoid any sudden loud sound output from the speaker, turn down the volume of both the computer and the speaker or stop music playback.
- Set the speaker of your computer to on.
If the speaker of your computer is set to  (mute), sound does not output on the BLUETOOTH speaker.

– When the speaker of your computer is set to on:



1 Turn on the speaker.

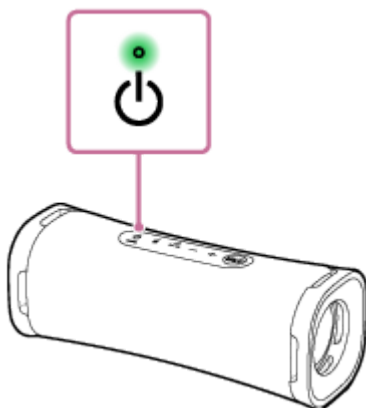

2 Check the (BLUETOOTH) indicator for activity.

When the indicator is double flashing

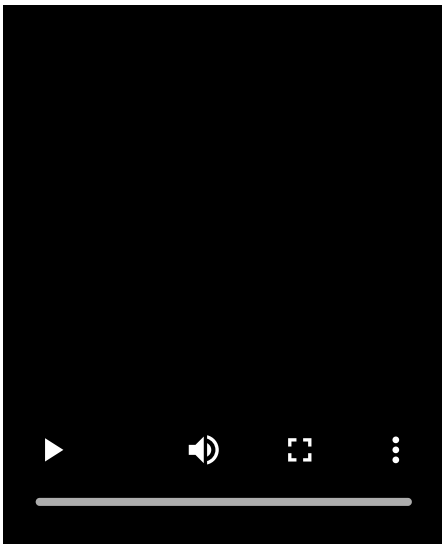

In the event that the speaker is paired with a BLUETOOTH device for the first time after purchase or in the event after the speaker is initialized (the speaker has no pairing information), the speaker automatically enters pairing mode when it is turned on. Proceed to step 4 .

When the indicator is flashing slowly

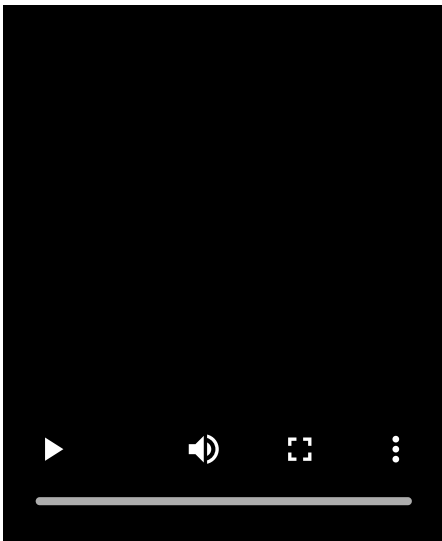

The speaker is searching for BLUETOOTH connections.

- To pair the speaker with a second or subsequent BLUETOOTH device (when the speaker has pairing information of other BLUETOOTH devices), proceed to step 3 .
- To reconnect the speaker with one of the BLUETOOTH devices that have been paired with the speaker before, proceed to step 4 .
The speaker will automatically be connected with the computer just by turning on the BLUETOOTH function on the computer.
Depending on the BLUETOOTH device, the speaker may be reconnected with the device right after it is turned on. For details, refer to the operating instructions supplied with your BLUETOOTH device.

When the indicator stays lit

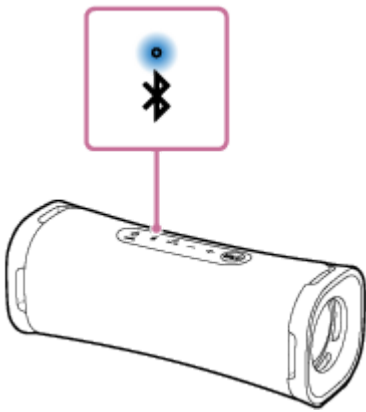

The speaker is already connected with one of the BLUETOOTH devices.

To connect the speaker with another BLUETOOTH device, do either of the following:

- To pair the speaker with a second or subsequent BLUETOOTH device (when the speaker has pairing information of other BLUETOOTH devices), proceed to step **3**.
- To reconnect the speaker with one of the BLUETOOTH devices that have been paired with the speaker before, proceed to step **4**.
The speaker will automatically be connected with the computer just by turning on the BLUETOOTH function on the computer.

3 Press the  (BLUETOOTH) button.

You hear voice guidance (Pairing) from the speaker and the  (BLUETOOTH) indicator starts double flashing (pairing mode).

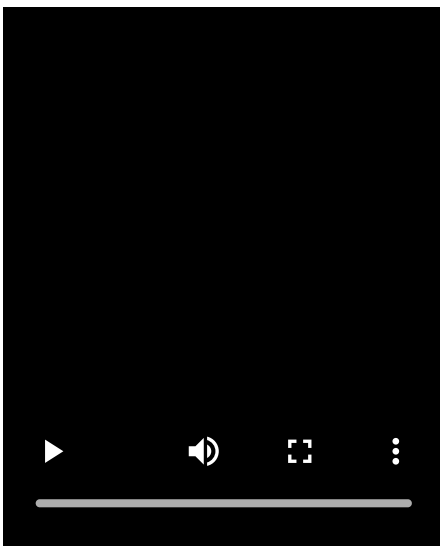

4 Search for the speaker on the computer.

1. Click [ (System Preferences)] - [Bluetooth] in the taskbar on the right-bottom of the screen.



2. Select [ULT FIELD 1] from the Bluetooth screen, then click [Pair].

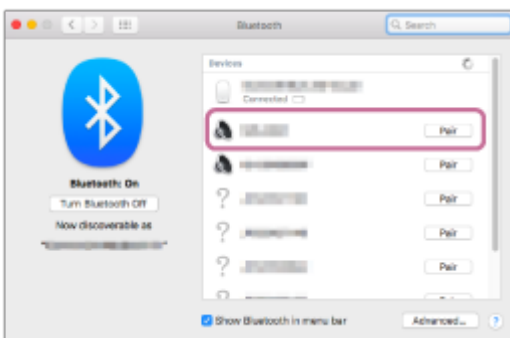

5 Follow the on-screen instructions to establish a BLUETOOTH connection.

When the BLUETOOTH connection is established, you hear the notification sound from the speaker and the activity of the  (BLUETOOTH) indicator changes from flashing to lit.

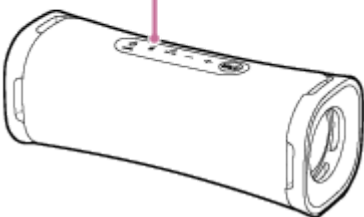

If the connection attempt fails, repeat the procedure from step 3 .

6 Click the speaker icon in the top-right of the screen and select [ULT FIELD 1] from [Output Device].

You can enjoy playing back music, etc. from your computer.

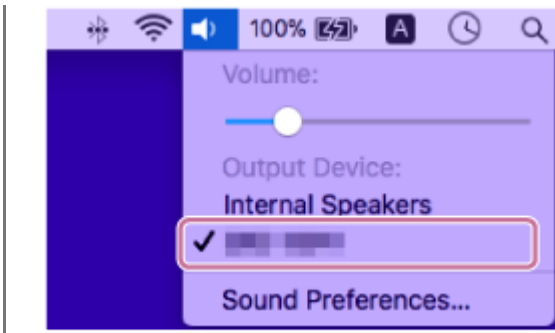

Hint

- The above instructions on the computer are provided as an example. For details, refer to the operating instructions supplied with your computer. In addition, not all the computers are tested and found compatible with the above procedure and the procedure is not applicable to home-built computers.

Note

- The pairing mode of the speaker is released after about 5 minutes and the  (BLUETOOTH) indicator flashes slowly. However, when the speaker has no pairing information, such as at the factory settings, the pairing mode is not released. If the pairing mode is released before finishing the process, repeat from step **3**.
- Once BLUETOOTH devices are paired, there is no need to pair them again, except in the following cases:
 - Pairing information has been deleted after repair, etc.
 - The speaker is already paired with 8 devices and another device is to be paired.
The speaker can be paired with up to 8 devices. When a new device is paired in addition to 8 paired devices, the pairing information of the earliest device connected via a BLUETOOTH connection is replaced by the information of the new one.
 - The pairing information with the speaker has been deleted from the BLUETOOTH device.
 - The speaker is initialized.
All pairing information will be deleted. If you initialize the speaker, it may not be able to connect your computer. In this case, erase the pairing information of the speaker on your computer, and then perform the pairing procedure again.
- The speaker can be paired with multiple devices, but can only play music from one paired device at a time.
- The passkey of the speaker is “0000.” If a passkey besides “0000” is set on the BLUETOOTH device, pairing cannot be done with the speaker.

Related Topic

- [Listening to music of a device via a BLUETOOTH connection](#)
- [Terminating the BLUETOOTH connection \(After use\)](#)

Wireless Speaker
ULT FIELD 1

Listening to music of a device via a BLUETOOTH connection

You can enjoy listening to music of a BLUETOOTH device and operate it by the speaker via a BLUETOOTH connection if it supports the following BLUETOOTH profiles.

A2DP (Advanced Audio Distribution Profile)

Enables you to enjoy high-quality audio contents wirelessly.

AVRCP (Audio Video Remote Control Profile)

Enables you to adjust the volume and operate to play, pause or skip to the beginning of the next/current track.

Operations may vary depending on the BLUETOOTH device. Refer also to the operating instructions supplied with the BLUETOOTH device.

Note

- Make sure beforehand that the volume on the BLUETOOTH device and speaker are set to a moderate level to avoid sudden loud sound output from the speaker.
Depending on the BLUETOOTH device, adjusting the volume of the speaker may not be possible on the BLUETOOTH device while playback on the device is stopped/paused.

1 Connect the speaker with the BLUETOOTH device.

When the BLUETOOTH connection is established, you hear the notification sound from the speaker and the activity of the  (BLUETOOTH) indicator changes from flashing to lit.

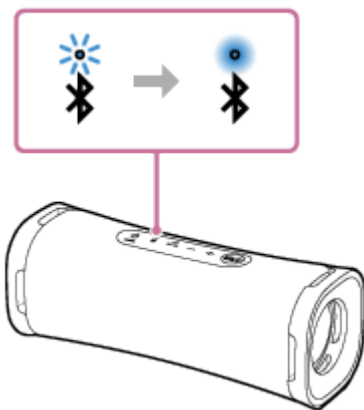

2 Start playback on the BLUETOOTH device.

3 Adjust the volume by pressing the $-/+$ (volume) buttons on the speaker or operating the BLUETOOTH device.

When you press the $-/+$ (volume) buttons on the speaker or adjust the volume on the BLUETOOTH device, the  (power) indicator flashes once or 3 times.

Depending on the BLUETOOTH device you are using, the  (power) indicator on the speaker may not flash even if you adjust the volume on the BLUETOOTH device.

Press and hold the $-/+$ (volume) buttons for rapid adjustments.

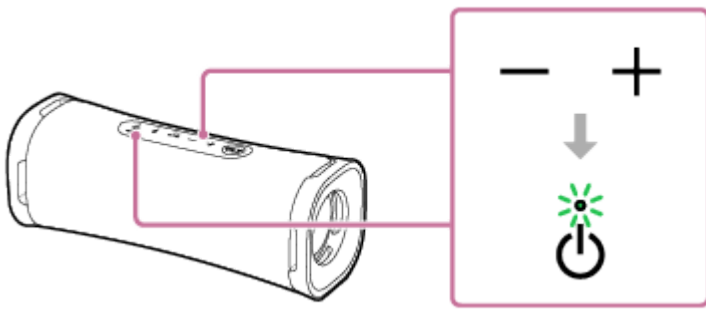

During playback, you can use the ►|| (play)/ ⤴ (call) button to perform the following operations.

Pause

Press the ►|| (play)/ ⤴ (call) button during playback to pause. Press it again to cancel pause.

Skip to the beginning of the next track

Press the ►|| (play)/ ⤴ (call) button twice quickly during playback.

Skip to the beginning of the current or previous track *

Press the ►|| (play)/ ⤴ (call) button 3 times quickly during playback.

* The above operations vary depending on the BLUETOOTH device in use.

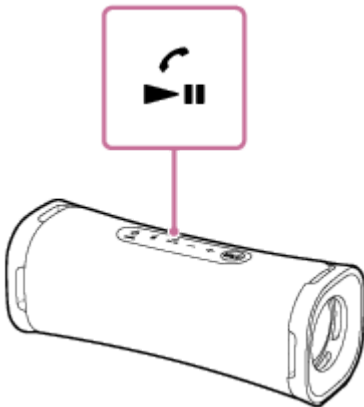

Hint

- As long as the speaker is connected to an AC outlet by a USB AC adaptor (commercially available), the speaker's built-in battery is capable of charging itself even while music playback from the speaker is in progress. Depending on the type or specifications of the USB AC adaptor or the usage of the speaker, however, it may take a long time before charging completes. When you intend to use the speaker while charging the battery, turn down the speaker volume, or turn off the speaker and let the battery fully charge itself before using the speaker.
- The speaker supports content protection by the SCMS-T method. You can listen to music (or audio) from the smartphone or mobile phone, which supports the SCMS-T method, through the speaker.
- When you set the volume to the maximum or minimum level on the speaker, the ⏻ (power) indicator flashes 3 times.

Note

- If the communication condition is poor, the BLUETOOTH device may react incorrectly to the operations on the speaker.
- When using in a place with a high temperature, the volume may decrease to protect the built-in battery.
- When the built-in battery is running low, the maximum speaker volume decreases.
- Depending on the BLUETOOTH device, it may be necessary to adjust the volume or set the audio output setting on the connected device.

- Noise or sound interruption may occur depending on the BLUETOOTH device connected with the speaker, the communication environment or the usage environment.

Related Topic

- [Charging the speaker](#)
- [Terminating the BLUETOOTH connection \(After use\)](#)

5-057-417-11(1) Copyright 2024 Sony Corporation

Wireless Speaker
ULT FIELD 1**Selecting the quality for music playback via a BLUETOOTH connection (Codec)**

The “Priority on Sound Quality” and “Priority on Stable Connection” preferences are available on the speaker for the BLUETOOTH connection quality. The “Priority on Sound Quality” preference provides compatibility not only with SBC but also with AAC for music playback of high sound quality, whereas the “Priority on Stable Connection” preference enables music playback via more stable BLUETOOTH connections. At the time of purchase, the “Priority on Sound Quality” preference is selected.





- Priority on Sound Quality (default setting): Optimal codec is automatically selected from AAC and SBC.
- Priority on Stable Connection: SBC is selected.

1 Turn on the speaker.

You hear the notification sound from the speaker, and the  (BLUETOOTH) indicator flashes* in blue.

* If the BLUETOOTH device which has been connected before is nearby, the speaker may be connected to the device automatically, and then the  (BLUETOOTH) indicator may be lit in blue.

2 Change the BLUETOOTH connection quality.**When using the buttons of the speaker**

1. Press and hold the  (play)/  (call) button and the + (volume) button simultaneously for about 2 seconds. When the setting is changed to the “Priority on Stable Connection” preference, the  (power) indicator flashes 3 times in green. When the setting is changed to the “Priority on Sound Quality” preference, the  (power) indicator flashes twice in green. When the speaker is connected with BLUETOOTH devices, all the connections are automatically disconnected and reestablished, and then the preference turns effective.

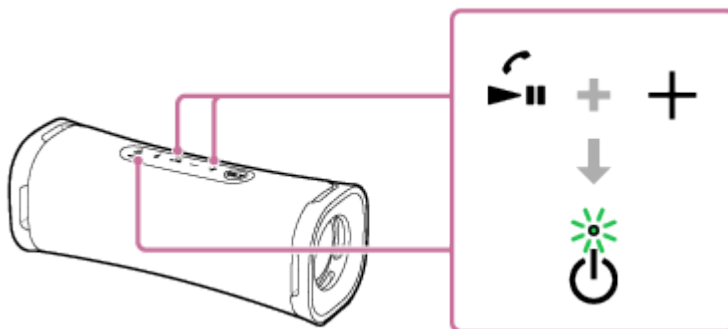
**When using “Sony | Music Center”**

1. Pair the speaker with a BLUETOOTH device, such as a smartphone. When a BLUETOOTH connection is established, you hear the notification sound from the speaker.
2. Tap [Music Center] on your smartphone, etc. to start up the application.



Music Center

3. Tap [ULT FIELD 1].

4. Tap [Settings] - [Sound] - [Bluetooth Connection Quality], and then select [Priority on Sound Quality] or [Priority on Stable Connection].

All the connections with BLUETOOTH devices are automatically disconnected and reestablished, and then the preference turns effective.

Hint

- As long as the speaker is connected to an AC outlet by a USB AC adaptor (commercially available), you can change the BLUETOOTH connection quality while the speaker is turned off as well.
- When using the Stereo Pair function, the codec automatically switches to SBC.

Note

- While the “Priority on Sound Quality” preference is selected, noise or sound interruption may occur depending on the setting of your BLUETOOTH device and ambient conditions. In such a case, change the BLUETOOTH connection quality to the “Priority on Stable Connection” preference.

Related Topic

- [Supported codecs](#)
- [What you can do with “Sony | Music Center”](#)

Wireless Speaker
ULT FIELD 1

Supported codecs

A codec is an audio coding algorithm used for wirelessly transmitting audio via BLUETOOTH connections. The speaker supports the following 2 codecs for music playback via an A2DP connection: SBC and AAC.

- SBC

This is an abbreviation for Subband Codec.

SBC is the standard audio coding technology used by BLUETOOTH devices.

All BLUETOOTH devices support SBC.

- AAC

This is an abbreviation for Advanced Audio Coding.

AAC is mainly used by Apple products such as iPhone that can provide a higher sound quality than that of SBC.

When music in one of the above codecs is transmitted from a connected device, the speaker switches to that codec automatically and plays back the music in the same codec.

If the connected device supports a codec of higher sound quality than SBC, you may need to set the device beforehand to enjoy music with the desired codec from the supported codecs.

Refer to the operating instructions supplied with the device regarding setting the codec.

Related Topic

- [Selecting the quality for music playback via a BLUETOOTH connection \(Codec\)](#)

Wireless Speaker
ULT FIELD 1

Terminating the BLUETOOTH connection (After use)

When you finish playing music with the BLUETOOTH device, perform any of the following operations to terminate the BLUETOOTH connection.

When the BLUETOOTH connection is disconnected, you hear the notification sound from the speaker.

- Turn off the BLUETOOTH function on the BLUETOOTH device. For details, refer to the operating instructions supplied with the device.
- Turn off the BLUETOOTH device.
- Turn off the speaker.

Hint

- When using the Stereo Pair function, if you turn off one speaker, the other speaker is automatically turned off. The BLUETOOTH connection between them is disconnected.
- When you finish playing music, the BLUETOOTH connection may terminate automatically depending on the BLUETOOTH device.

Related Topic

- [Turning the power off](#)
- [Auto Standby \(power saving\) function](#)

Wireless Speaker
ULT FIELD 1

Enjoying switching the sound effects

You can enjoy switching the sound effects on the speaker.

Enjoying enhanced bass sound (ULT button)

You can take either of the following procedures for setup. At the time of purchase, the ULT POWER SOUND setting is turned on.

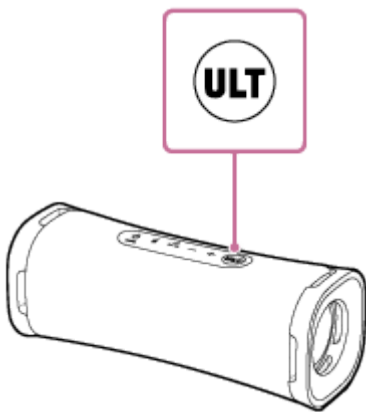

- Press the ULT button.
Each time you press the ULT button, the ULT POWER SOUND setting turns on or off.
Each time the setting is changed, you hear the notification sound from the speaker, and the ULT button lights up or lights out.



ULT POWER SOUND: Emphasizes bass sound.

- Use “Sony | Music Center.”
On “Sony | Music Center,” tap [ULT FIELD 1] - [Settings] - [Sound] - [Sound Effect], then select [OFF] or [ULT POWER SOUND].

Hint

- By pressing and holding the ULT button and the – (volume) button on the speaker simultaneously for about 2 seconds, you can turn on or off the notification sound.
When the notification sound is turned off, the  (power) indicator flashes 3 times in green.
When the notification sound is turned on, the  (power) indicator flashes twice in green.

Adjusting the equalizer setting to your preference (CUSTOM)

On “Sony | Music Center,” tap [ULT FIELD 1] - [Settings] - [Sound] - [Sound Effect] - [CUSTOM].
Tap [Custom EQ], and then adjust the equalizer setting to suit your preference.

Wireless Speaker
ULT FIELD 1

Listening to music wirelessly with 2 speakers (Stereo Pair function)

To use the Stereo Pair function, 2 ULT FIELD 1 speakers are required. By connecting 2 speakers via a BLUETOOTH connection, you can enjoy more powerful sound.

2 speakers connected via a BLUETOOTH connection play sounds in stereo, where 1 speaker plays the sound on the right channel (right side) and the other plays the sound on the left channel (left side).

Before operating the speaker, make sure of the following:

- Update the pre-installed software to the latest version on each and every speaker to connect for the function. (For details about the update procedure, see [Updating the pre-installed software](#).)
- When setting up the speakers for the Stereo Pair function, make sure that the 2 speakers to connect for the function are located within 1 m (3.2 ft) from each other. Stop music playback if it is in progress.
- When playing music, make sure that all of the devices to connect for the function are located within 30 m (98.4 ft) in your line of sight.
Maximum communication range may shorten under the following conditions.

- There is an obstacle such as a person, metal, or wall between the speaker and BLUETOOTH device.
- A wireless LAN device is in use near the speaker.
- A microwave oven is in use near the speaker.
- A device that generates electromagnetic radiation is in use near the speaker.

1 Use “Sony | Music Center” to set up the speaker for the Stereo Pair function.

For details about “Sony | Music Center,” refer to the following URL:
<https://www.sony.net/smcqa/>

To terminate the Stereo Pair function

Use “Sony | Music Center.”

Hint

- Use of the Stereo Pair function automatically switches the codec to SBC.
- Turning off the speakers does not turn off the Stereo Pair function. When one of the speakers is turned back on, it attempts to establish a connection for the Stereo Pair function. To use the Stereo Pair function, turn on the other speaker within 1 minute.

Note

- To avoid any sudden loud sound output from the speaker, turn down the volume of the speaker and a BLUETOOTH device or stop the playback on the BLUETOOTH device before establishing a connection with the BLUETOOTH device.

Related Topic

- [Installing “Sony | Music Center”](#)
- [Updating the pre-installed software](#)

Wireless Speaker
ULT FIELD 1

Making a video call on a computer

During a video call on a computer, you can use the speaker for wireless phone talking.

- 1 **Connect the speaker with a computer via a BLUETOOTH connection.**
- 2 **Start up a video call application on the computer.**
- 3 **View the settings^{*1} of the video call application.**
 - For video calls on the computer, select the BLUETOOTH profile not for music playback (A2DP) but for phone talking (HFP/HSP connection). While the BLUETOOTH profile for music playback (A2DP connection) is selected, phone talking may not be available.
 - For the speaker settings, select [Headset earphone (ULT FIELD 1 Hands-Free)]^{*2}, the BLUETOOTH profile for phone talking (HFP/HSP connection). ([Speakers (ULT FIELD 1 Stereo)]^{*2} is the BLUETOOTH profile for music playback.)
 - For the microphone settings, select [Headset microphone (ULT FIELD 1 Hands-Free)]^{*2}, the BLUETOOTH profile for phone talking (HFP/HSP connection).
 - Depending on your video call application, selection of [Headset earphone (ULT FIELD 1 Hands-Free)]^{*2} or [Headset microphone (ULT FIELD 1 Hands-Free)]^{*2}, the BLUETOOTH profile for phone talking (HFP/HSP connection), or [Speakers (ULT FIELD 1 Stereo)]^{*2}, the BLUETOOTH profile for music playback (A2DP connection), may not be available for the speaker or microphone settings, and only [ULT FIELD 1] may be displayed. In such a case, select [ULT FIELD 1].
 - For frequently asked questions and the answers to them, visit the customer support website.

*1 Depending on your video call application, this function may not be available.

*2 Labels may vary depending on your computer or video call application.

Hint

- When you cannot view the settings of the video call application or select [Headset earphone (ULT FIELD 1 Hands-Free)] or [Headset microphone (ULT FIELD 1 Hands-Free)], the BLUETOOTH profile for phone talking (HFP/HSP connection), select [Headset earphone (ULT FIELD 1 Hands-Free)] or [Headset microphone (ULT FIELD 1 Hands-Free)] for the settings on the computer, and then establish a connection. For details, see the following topics.
 - [Connecting with a computer via a BLUETOOTH connection \(Windows®\)](#)
 - [Connecting with a computer via a BLUETOOTH connection \(Mac\)](#)
- On a Mac computer, the BLUETOOTH profiles both for music playback (A2DP) and for phone talking (HFP/HSP connection) are used for video calls and profile selection is not required.

- Terminating the BLUETOOTH connection (After use)
- What can I do to solve a problem?

5-057-417-11(1) Copyright 2024 Sony Corporation

Wireless Speaker
ULT FIELD 1

Receiving a call

You can enjoy hands-free calls with a smartphone or mobile phone that supports the BLUETOOTH profile HFP (Hands-free Profile) or HSP (Headset Profile) via a BLUETOOTH connection.

- If your smartphone or mobile phone supports both HFP and HSP, set it to HFP.
- Operations may vary depending on the smartphone or mobile phone. Refer to the operating instructions supplied with the smartphone or mobile phone.

About ring tones

When an incoming call arrives, playback pauses and a ring tone will be heard via the speaker. The ring tone varies in the following ways, depending on your smartphone or mobile phone.

- Ring tone set on the speaker
- Ring tone set on the smartphone or mobile phone
- Ring tone set on the smartphone or mobile phone only for a BLUETOOTH connection

1 Connect the speaker with a smartphone or mobile phone.

When the BLUETOOTH connection is established, you hear the notification sound from the speaker and the activity of the  (BLUETOOTH) indicator changes from flashing to lit.

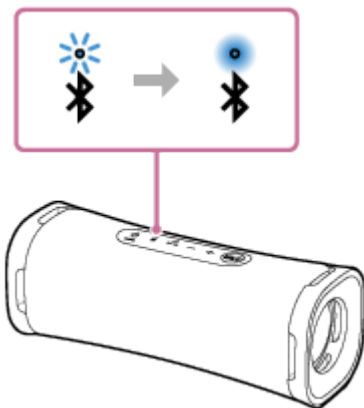

When using the Stereo Pair function

Connect to the speaker of which the  (BLUETOOTH) indicator flashes in blue. In the following steps and operations during a hands-free call, operate the speaker that is connected to the smartphone or mobile phone.

2 Press the (play)/ (call) button when a call is received.

Talk into the microphone () of the speaker.

When an incoming call arrives, playback pauses and a ring tone is heard via the speaker.

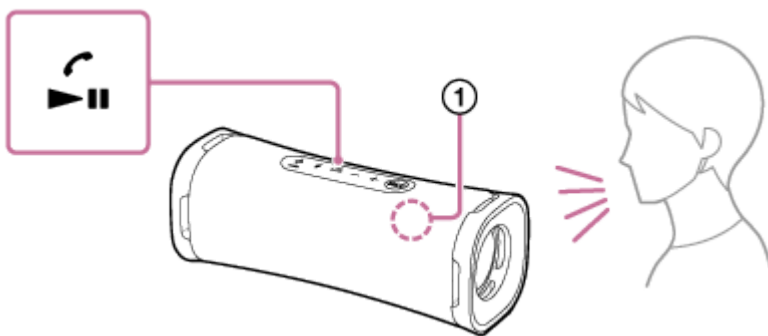

If no ring tone is heard via the speaker

The speaker may not be connected with a smartphone or mobile phone with HFP or HSP. Check the connection status on the smartphone or mobile phone.

3 While the phone is ringing or a phone conversation is in progress, adjust the volume by pressing the **-/+** (volume) buttons on the speaker or operating the smartphone or mobile phone.

When you press the **-/+** (volume) buttons on the speaker or adjust the volume on the smartphone or mobile phone, the **⏻** (power) indicator flashes once or 3 times.

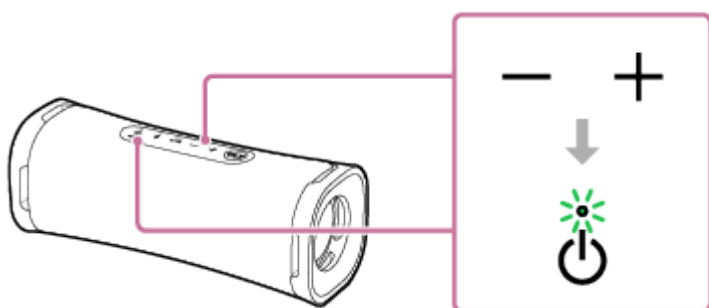

4 To end a call, press the **▶||** (play)/ **📞** (call) button.

If you were listening to music before the call, playback will resume when the call ends. If you end a call by operating the smartphone or mobile phone, playback will also resume when the call ends if you were listening to music before the call.

Hint

- Some smartphones or mobile phones have handset use priority when receiving a call. In the case of the HFP/HSP connection, switch the call device to the speaker by operating your smartphone or mobile phone.
- When the caller is unable to hear or having trouble with hearing your voice, lean closer to the speaker and then talk into its microphone.
- The volume of music playback and calling is set independently in the speaker.

Note

- When using the Stereo Pair function, the sound of the phone call is output from only the speaker with the blue lit **📶** (BLUETOOTH) indicator.
- Depending on the smartphone or mobile phone, playback may not pause when an incoming call arrives.
- Use a smartphone or mobile phone at least 50 cm (1.6 ft) away from the speaker. Noise may result if the speaker and the smartphone or mobile phone are too close.

- Depending on the model of your smartphone or mobile phone, the operation system or applications installed, some functions of hands-free calling may not be used correctly.

Related Topic

- [Pairing and connecting with BLUETOOTH devices](#)
- [Terminating the BLUETOOTH connection \(After use\)](#)
- [Making a call](#)

5-057-417-11(1) Copyright 2024 Sony Corporation

Wireless Speaker
ULT FIELD 1

Making a call

You can enjoy hands-free calls with a smartphone or mobile phone that supports the BLUETOOTH profile HFP (Hands-free Profile) or HSP (Headset Profile) via a BLUETOOTH connection.

- If your smartphone or mobile phone supports both HFP and HSP, set it to HFP.
- Operations may vary depending on the smartphone or mobile phone. Refer to the operating instructions supplied with the smartphone or mobile phone.

1 Connect the speaker with a smartphone or mobile phone.

When the BLUETOOTH connection is established, you hear the notification sound from the speaker and the activity of the  (BLUETOOTH) indicator changes from flashing to lit.

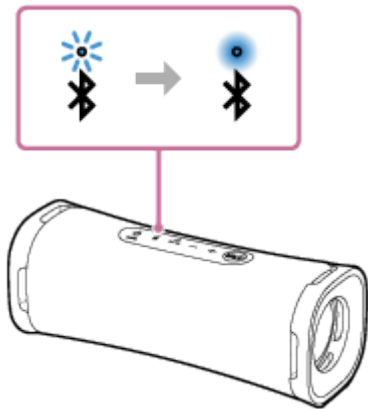

When using the Stereo Pair function

Connect to the speaker of which the  (BLUETOOTH) indicator flashes in blue. In the following steps and operations during a hands-free call, operate the speaker that is connected to the smartphone or mobile phone.



2 Operate the smartphone or mobile phone to make a call.

When you make a call, playback pauses and the dial tone is heard via the speaker.

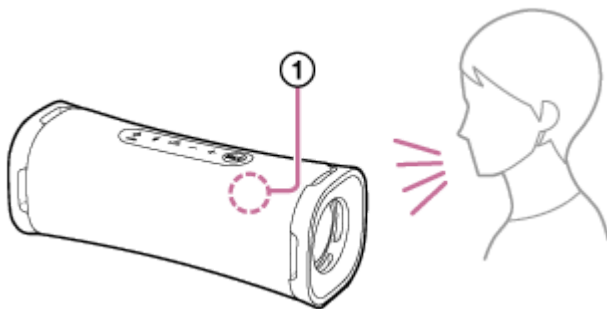
When the receiver takes the call, talk into the microphone () of the speaker.



If no dial tone is heard via the speaker

- The speaker may not be connected with a smartphone or mobile phone with HFP or HSP. Check the connection status on the smartphone or mobile phone.
- Switch the call device to the speaker by pressing and holding the  (play)/  (call) button for about 2 seconds.

- 3 While the phone is ringing or a phone conversation is in progress, adjust the volume by pressing the **-/+** (volume) buttons on the speaker or operating the smartphone or mobile phone.

When you press the **-/+** (volume) buttons on the speaker or adjust the volume on the smartphone or mobile phone, the **⏻** (power) indicator flashes once or 3 times.

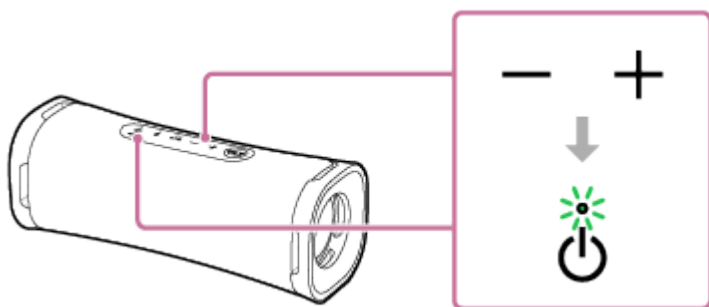

- 4 To end a call, press the **▶||** (play)/ **📞** (call) button.

If you were listening to music before the call, playback will resume when the call ends. If you end a call by operating the smartphone or mobile phone, playback will also resume when the call ends if you were listening to music before the call.

Hint

- When the receiver is unable to hear or having trouble with hearing your voice, lean closer to the speaker and then talk into its microphone.
- The volume of music playback and calling is set independently in the speaker.

Note

- When using the Stereo Pair function, the sound of the phone call is output only from the speaker with the blue lit **ⓧ** (BLUETOOTH) indicator.
- Depending on the smartphone or mobile phone, playback may not pause when making a call.
- Use a smartphone or mobile phone at least 50 cm (1.6 ft) away from the speaker. Noise may result if the speaker and the smartphone or mobile phone are too close.

Related Topic

- [Pairing and connecting with BLUETOOTH devices](#)
- [Terminating the BLUETOOTH connection \(After use\)](#)
- [Receiving a call](#)

Wireless Speaker
ULT FIELD 1

What you can do with “Sony | Music Center”

“Sony | Music Center” is an app for controlling Sony audio devices which are compatible with “Sony | Music Center” using your smartphone, etc.

For details about “Sony | Music Center,” refer to the following URL:

<https://www.sony.net/smcqa/>

Operations that can be performed on a speaker with “Sony | Music Center”

- Setting up the Stereo Pair function, swapping the right (right side) and left (left side) audio channels
- Sound quality setting and equalizer adjustment
- Power Option settings (STAMINA/Auto Standby)
- Switching Bluetooth Connection Quality (Priority on Sound Quality/Priority on Stable Connection)
- Viewing the update or version of the speaker’s software
- Playing music files stored on the smartphone
- Built-in battery level indication

etc.

Note

- What you can control with “Sony | Music Center” varies depending on the connected device. The specifications and design of the app may change without notice.
- Be sure to use the latest version of “Sony | Music Center.” If you cannot connect the speaker and a BLUETOOTH device via a BLUETOOTH connection, or if there is a problem such as no sound being emitted, uninstall “Sony | Music Center” and try to connect via the BLUETOOTH connection again.
For details about “Sony | Music Center,” refer to Google Play (Play Store) or the App Store.
- Be aware that “Sony | Music Center” and “Music Center for PC” are different apps.

Related Topic

- [Installing “Sony | Music Center”](#)
- [Charging the speaker](#)
- [Selecting the quality for music playback via a BLUETOOTH connection \(Codec\)](#)
- [Listening to music wirelessly with 2 speakers \(Stereo Pair function\)](#)
- [Updating the pre-installed software](#)

Wireless Speaker
ULT FIELD 1

Installing “Sony | Music Center”

Install “Sony | Music Center” on your smartphone, etc. from Google Play (Play Store) or the App Store. For Apple iOS devices, “Sony | Music Center” can be installed on the devices with iOS 11.0 or later. Installation is not available on the devices with iOS 10.x or earlier.

- 1 Download “Sony | Music Center” from Google Play (Play Store) or the App Store and install it.



Sony Music Center



- 2 When the installation is complete, start “Sony | Music Center.”

Note

- Be aware that “Sony | Music Center” and “Music Center for PC” are different apps.
- Be sure to use the latest version of “Sony | Music Center.” If you cannot connect the speaker and a BLUETOOTH device via a BLUETOOTH connection, or if there is a problem such as no sound being emitted, uninstall “Sony | Music Center” and try to connect via the BLUETOOTH connection again.
For details about “Sony | Music Center,” refer to Google Play (Play Store) or the App Store.

Related Topic

- [What you can do with “Sony | Music Center”](#)

Wireless Speaker
ULT FIELD 1

Using the voice assist function (Google™ app)

By using the Google app feature that comes with the Android smartphone, you can speak to the speaker's microphone to operate the Android smartphone.

The following shows how to use the Google app.

1 Select the Google app for [Assist App] in [Assist & Voice input].

On the Android smartphone, select [Settings] - [Apps & notifications] - [Advanced] - [Default apps] - [Assist & Voice input] and select the Google app for [Assist App].

The operation above is an example. For details, refer to the operating instructions supplied with the Android smartphone.

For details on the Google app, refer to the operating instructions or support website of the Android smartphone or website of Google Play (Play Store).

Note

- The latest version of the app may be required.
- The Google app may not be activated from the speaker depending on specifications of the Android smartphone.

2 Connect the speaker to the Android smartphone via a BLUETOOTH connection.

3 While the speaker is connected with the Android smartphone via a BLUETOOTH connection and the Android smartphone is in standby or playing music, press and hold the (play)/ (call) button for about 2 seconds.

The Google app is activated and you will hear the start-up sound.

4 Make a request to the Google app through the speaker's microphone.

For details on the Google app, such as apps which work with the Google app, refer to the operating instructions supplied with the Android smartphone.

Note

- The Google app cannot be activated when you say "OK Google" through the speaker's microphone even when the Android smartphone's [OK Google] setting is on.

Wireless Speaker
ULT FIELD 1

Using the voice assist function (Siri)

By using the Siri function that comes with the iPhone, you can speak to the speaker's microphone to operate the iPhone. The following shows how to use Siri.

1 Turn on Siri.

On the iPhone, select [Settings] - [Siri & Search] and enable [Listen for "Hey Siri"].

The operation above is an example. For details, refer to the operating instructions supplied with the iPhone.

For details on Siri, refer to the operating instructions or support website of the iPhone.

2 Connect the speaker to the iPhone via a BLUETOOTH connection.

3 While the speaker is connected with the iPhone via a BLUETOOTH connection and the iPhone is in standby or playing music, press and hold the (play)/ (call) button for about 2 seconds.

The Siri is activated and you will hear the start-up sound.

4 Make a request to Siri through the speaker's microphone.

For details on Siri, such as apps which work with Siri, refer to the operating instructions supplied with the iPhone.

Note

- Siri cannot be activated when you say "Hey Siri" through the speaker's microphone even when the iPhone's [Listen for "Hey Siri"] setting is on.

About the indicators

CHARGE indicator (orange)

Turns off	The speaker is finished with charging.
Lights up	The speaker is being charged.
Flashes slowly	The built-in battery is running at less than 20% and needs to be charged.
Flashes 3 times and turns off	If the CHARGE indicator flashes 3 times and turns off when you turn on the speaker, the built-in battery is empty and needs to be charged.
Flashes quickly	An abnormality in the interior temperature or in the built-in rechargeable battery is detected. Turn off the speaker, disconnect the USB cable, wait for a while, and then restart the speaker. For details, see Notes on charging .

Note

- As long as the speaker is connected to an AC outlet by a USB AC adaptor (commercially available), the speaker's built-in battery is capable of charging itself even while the speaker is turned on. Depending on the usage of the speaker, however, it may take a long time before charging completes. It is recommended that you turn off the speaker before battery charging.
- Depending on the type or specifications of the USB AC adaptor, if you use the speaker at a loud volume, the remaining power of the rechargeable built-in battery may decrease or the speaker may turn off even while the speaker is connected to an AC outlet by the USB AC adaptor. This, however, does not indicate a malfunction. If such a case occurs, turn off the speaker and let the battery fully charge itself before you use the speaker.
- If the ambient temperature is extremely low or high, the built-in battery will stop charging itself for safety reasons. It may also stop charging if charging continues for a long period of time. If such a case occurs, bring the temperature up or down to an operating temperature between 5 °C and 35 °C (41 °F and 95 °F), disconnect and connect the USB cable, and then let the battery charge itself once again.

(power) indicator (green)

Turns off	The speaker is turned off.
Lights up	The speaker is turned on.

Flashes	<ul style="list-style-type: none"> ● Each time you press the –/+ (volume) buttons, the indicator flashes once. ● When you operate the –/+ (volume) buttons and the volume is set at the lowest (0) or highest (50 for music playback/15 for phone calling) level, the indicator flashes 3 times. ● When the ▶ (play)/ ☎ (call) button and the – (volume) button are pressed and held simultaneously for about 5 seconds and the Auto Standby function is turned off, the indicator flashes 3 times. ● When the ▶ (play)/ ☎ (call) button and the – (volume) button are pressed and held simultaneously for about 5 seconds and the Auto Standby function is turned on, the indicator flashes twice. ● When the ▶ (play)/ ☎ (call) button and the + (volume) button are pressed and held simultaneously for about 2 seconds and the “Priority on Stable Connection” preference is selected for the BLUETOOTH connection quality, the indicator flashes 3 times. ● When the ▶ (play)/ ☎ (call) button and the + (volume) button are pressed and held simultaneously for about 2 seconds and the “Priority on Sound Quality” preference is selected for the BLUETOOTH connection quality, the indicator flashes twice. ● When the ULT button and the – (volume) button are pressed and held simultaneously for about 2 seconds and the ULT POWER SOUND notification sound is turned off, the indicator flashes 3 times. ● When the ULT button and the – (volume) button are pressed and held simultaneously for about 2 seconds and the ULT POWER SOUND notification sound is turned on, the indicator flashes twice.
---------	--

⌘ (BLUETOOTH) indicator (blue)

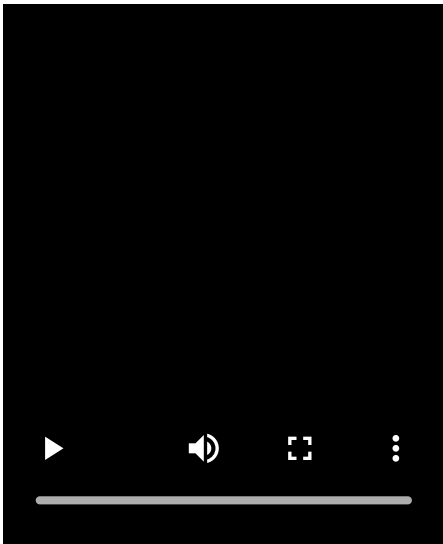
Lights up	The speaker is connected to a BLUETOOTH device.
Double flashes	<p>The speaker enters the pairing mode.</p> 

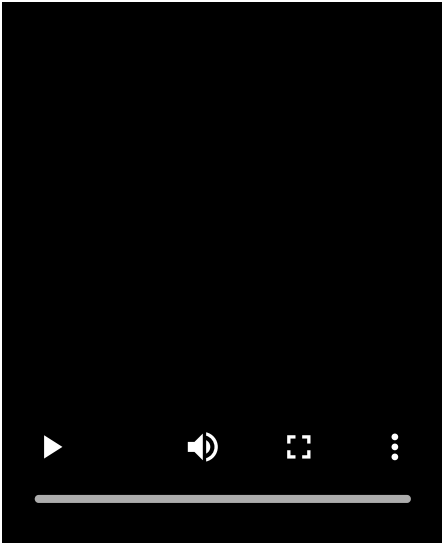











Flashes slowly	<p>The speaker is waiting for a BLUETOOTH connection to be established.</p> 
----------------	---

ULT button (pink^{*})

Turns off	The sound mode is set to other than ULT POWER SOUND.
Lights up	The sound mode is set to ULT POWER SOUND.

^{*} The lighting color of the ULT button varies depending on the viewing angle.

Other activities of the indicators (indications pertaining to updates to the pre-installed software)

While an update is in progress	As a software update progresses, the  (power) indicator changes its green flashing pattern (5-time flashing, 4-time flashing, 1-time flashing, unlit [*]).
Upon completion of an update	When the speaker turns on for the first time after a software update, the green  (power) indicator and the blue  (BLUETOOTH) indicator flash simultaneously 3 times.
When an update is canceled	<ul style="list-style-type: none"> ● When [Cancel] is tapped on “Sony Music Center” while an update is in progress Depending on the progress of the update, either of the following indicator activities are presented: <ul style="list-style-type: none"> – The  (power) indicator goes out and the blue  (BLUETOOTH) indicator starts flashing. – The  (power) indicator goes out, and the blue  (BLUETOOTH) indicator and the orange CHARGE indicator simultaneously start flashing. Then, while the blue  (BLUETOOTH) indicator keeps flashing, the orange CHARGE indicator starts 4-time flashing. ● When the  (power) button on the speaker is pressed while an update is in progress The blue  (BLUETOOTH) indicator starts flashing. At the same time, the orange CHARGE indicator flashes 9 times[*] and then the speaker turns off.
When an update fails	When the transfer of update data fails, the  (power) indicator goes out and the  (BLUETOOTH) indicator flashes in blue.

^{*} Depending on the situation, you may not be able to see all flashing patterns.

Related Topic

- [Parts and controls](#)
- [What you can do with “Sony | Music Center”](#)
- [Updating the pre-installed software](#)

5-057-417-11(1) Copyright 2024 Sony Corporation

Updating the pre-installed software

When a new version of the software is released, you can update your speaker's pre-installed software by using the following methods.

By updating the software, new features will be added enabling you to experience more convenient and stable use.

1 Connect the speaker to an AC outlet with a USB AC adaptor (commercially available).

Software updates cannot be applied while the speaker is running on power from the built-in battery.

2 Turn on the speaker.

You hear the notification sound from the speaker, and the  (power) indicator lights up in green.

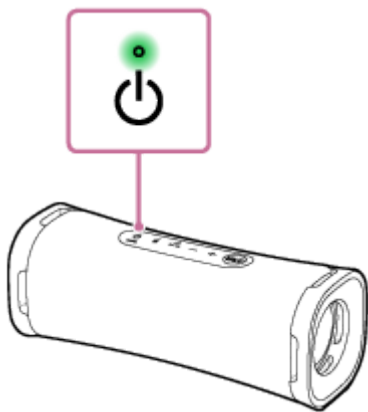

3 Tap [Music Center] on the device to start up the application.



Music Center



4 Tap [ULT FIELD 1].

When a new version of the software is released, an update notice is displayed on the "Sony | Music Center" screen.

5 Follow the instructions on the screen to update.

As a software update progresses, the  (power) indicator changes its green flashing pattern (5-time flashing, 4-time flashing, 1-time flashing, unlit).

Depending on the situation, you may not be able to see all flashing patterns.

When the speaker turns on for the first time after a software update, the green  (power) indicator and the blue  (BLUETOOTH) indicator flash simultaneously 3 times to inform you that the update is complete.

6 Confirm the version of the speaker's software.

On "Sony | Music Center," tap [ULT FIELD 1] - [Settings] - [System].

“XXXX” displayed under “ULT FIELD 1” indicates the software version.

Hint

- When a software update fails, turn off the speaker and then turn it back on. The speaker will recover from the error state.
- For details on activities of the indicators on the speaker pertaining to software updates, see “Other activities of the indicators (indications pertaining to updates to the pre-installed software)” in [About the indicators](#).

Note

- When an attempt to update the software fails, charge the rechargeable built-in battery until it is charged 40% or more. You can view the remaining power of the rechargeable built-in battery on “Sony | Music Center.”

Related Topic

- [Charging the speaker](#)

5-057-417-11(1) Copyright 2024 Sony Corporation

Precautions

On safety

- Refer to the Reference Guide supplied with the speaker.
- The nameplate and important information concerning safety are attached in the following locations:
 - the inner surface of the cap on the rear side of the speaker

On placement

- To eliminate the risk of malfunctions, avoid the following locations when placing or leaving this speaker.
 - A place subject to high temperatures, such as under direct sunlight or lighting equipment, near a heat source, or in a sauna
 - Inside a vehicle with the windows closed (especially in summertime)
 - A place exposed to hot air, such as from a hair dryer
 - A place subject to excessive dust
 - A place subject to strong vibration
- Place this speaker on a flat, level surface. When placed on a sloped surface, the speaker may fall over or fall off the surface due to its own vibration, resulting in injuries, malfunctions, or performance degradation.
- Depending on the conditions where this speaker is placed, it may fall over or fall off the surface. Do not leave any valuables near the speaker.
- This speaker is not anti-magnetic. Keep objects susceptible to magnetism (recorded tapes, watches, cash cards and credit cards with magnetic coding, etc.) away from the speaker. When you carry around the speaker, keep this in mind as well.

Other notes

- Do not use or leave the speaker in an extremely cold or hot environment (temperature outside the range of 5 °C - 35 °C (41 °F - 95 °F)). If the speaker is used or left in outside the above range, the speaker may automatically stop to protect internal circuitry.
- If you use this speaker for a long time, the temperature of this speaker may rise, but it is not a malfunction.
- At high temperature, the charging may stop or the volume may reduce to protect the battery.
- Even if you do not intend to use the speaker for a long time, charge the battery to its full capacity once every 6 months to maintain its performance.
- If you have any questions or problems concerning this speaker that are not covered in this manual, please consult your nearest Sony dealer.

Notes on charging

Life span of the built-in lithium ion battery

- Even if you do not intend to use the speaker for a long time, charge the built-in battery sufficiently once every 6 months to maintain its performance.
- If the speaker is not used for a long time, it may take longer to charge the built-in battery.
- The rechargeable built-in battery has a life span. As time passes and the number of times that the built-in battery is used increases, the capacity of the rechargeable built-in battery slowly decreases. When the amount of time that the built-in battery can be used seems significantly shorter, despite having been fully charged, contact your nearest Sony dealer.
- When the amount of time that the built-in battery can be used seems significantly shorter, it could mean that the rechargeable built-in battery has expired.
- The life span of the rechargeable built-in battery differs depending on the usage, environment, and storage method.

Caution

When the speaker detects an abnormality in the interior temperature or in the built-in rechargeable battery, the CHARGE indicator (orange) flashes quickly.

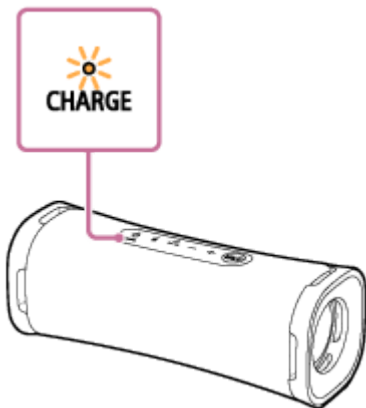

If an abnormality is detected, disconnect the USB cable, wait for a while, and then restart the speaker (by pressing and holding the  (power) button for about 10 seconds). If the problem persists, contact your nearest Sony dealer.

Note

- Charging time varies depending on built-in battery usage conditions.
- Charge the speaker in an ambient temperature between 5 °C and 35 °C (41 °F and 95 °F). Be aware that the room temperature may fall to 5 °C (41 °F) or lower depending on the season, for example, especially in wintertime.
- The speaker becomes warm during charging. This is not a malfunction.
- Avoid exposure to rapid temperature change, direct sunlight, mist, sand, dust, or mechanical shock. Also, never leave the speaker in a car parked in the sun.
- As long as the speaker is connected to an AC outlet by a USB AC adaptor (commercially available), the speaker's built-in battery is capable of charging itself even while the speaker is turned on. However, it may take a long time before charging completes depending on the usage of the speaker. It is recommended that you turn off the speaker before battery charging.

- You can charge the speaker's built-in battery by connecting the speaker to a computer that comes equipped with a USB charging port as well. However, not all the computers are tested and found compatible with this procedure and the procedure is not applicable to home-built computers.
- In an extremely cold or hot environment, charging stops for safety. If charging takes a long time, it also makes charging of the speaker stop. To resolve these issues, disconnect the USB cable from the speaker and connect it again within an operating temperature between 5 °C and 35 °C (41 °F and 95 °F).
- At high temperature, the charging may stop or the volume may reduce to protect the battery.
- Charging from a USB hub is only guaranteed when you use a self-powered USB hub that carries an authorized logo.
- While the speaker is connected with a computer that is not connected to an AC outlet, the speaker consumes the battery power of the computer. Do not leave the computer with the speaker connected for a long period of time to prevent the computer's battery from running out of power.

Related Topic

- [Charging the speaker](#)
- [Restarting the speaker](#)

Wireless Speaker
ULT FIELD 1

Notes on waterproof and dustproof features

On waterproof and dustproof performance of the speaker

The speaker, with the cap fastened securely, has a waterproof specification of IPX7^{*1} as specified in “Degree of protection against water immersion” of the IEC60529 “Ingress Protection Rating (IP Code)”^{*3}, and a dustproof specification of IP6X^{*2} as specified in “Degrees of protection against solid foreign objects”^{*3}.

Liquids that the waterproof performance specifications apply to

Applicable	fresh water, tap water, pool water, salt water
Not applicable	liquids other than the above (soapy water, water with detergent or bath agents, shampoo, hot spring water, etc.)

*1 IPX7 equivalency: The speaker has been tested to and maintains its operability when gently submersed in water to a depth of 1 m (3.2 ft) and left for 30 minutes.

*2 IP6X equivalency: The speaker has been tested to and continues to block dust after stirring for 8 hours in a testing device which contains dust particles that are up to 75 µm in diameter.

*3 The supplied accessories and the connector of this speaker (USB) are neither waterproof nor dustproof. To reduce the risk of fires or electric shocks, do not expose the speaker to water or droplets while using the connector (USB).

The waterproof and dustproof performance of the speaker is based on our measurements under the conditions herein described. Note that malfunctions as a result of water immersion or dust intrusion caused by misuse by the customer are not covered by the warranty.

To maintain waterproof and dustproof performance

Carefully note the precautions below to ensure proper use of the speaker.

- The speaker passes the drop test from 1.22 m (4.0 ft) on plywood of 5 cm (1.97 in) thickness conforming to MIL-STD810H Method 516.8-Shock. However, this does not guarantee no damage, no breakdown, or waterproof and dustproof performance in all conditions. Deformation or damage from dropping the speaker or subjecting it to mechanical shock may cause deterioration of the waterproof and dustproof performance.
- This speaker does not have a design that is resistant to water pressure. Use of the speaker in a location where high water pressure is applied, such as in the shower, may cause a malfunction.
- Do not pour high-temperature water or blow hot air from a hair dryer or any other appliance on the speaker directly. Also never use the speaker in a place subject to high temperatures, such as in a sauna or near a heat source.
- Handle the cap (①) with care. The cap plays a very important role in maintenance of the waterproof and dustproof performance. When using the speaker, make sure that the cap is closed completely. When closing the cap, be careful not to allow foreign objects inside. If the cap is not closed completely the waterproof and dustproof performance may deteriorate and may cause a malfunction of the speaker as a result of water or dust particles entering the speaker.

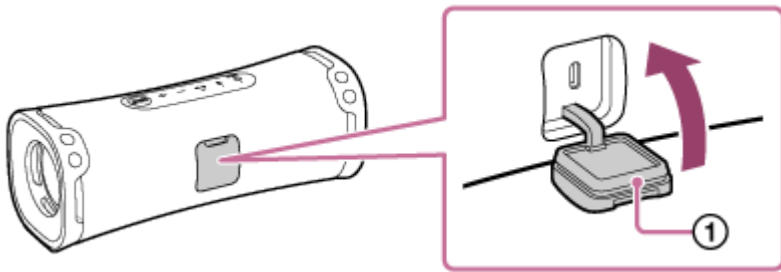

5-057-417-11(1) Copyright 2024 Sony Corporation

Wireless Speaker
ULT FIELD 1

How to care for the speaker

Although the fabric part of the speaker has water repellent treatment applied, you can use the speaker more comfortably and for a longer period of time by following the maintenance procedure below.

- If the surface of the speaker gets dirty in the following cases, wash the speaker with fresh water (tap water, etc.) promptly to remove the dirt. Leaving dirt on its surface may cause the fabric part or the passive radiator section (①) to discolor or deteriorate, or the speaker to malfunction.

Ex.

- When salt, sand, etc. is stuck on the speaker after using it on a beach, pool side, etc.
- When the speaker is stained with sweat or foreign substances (sunscreen, suntan oil, etc.)

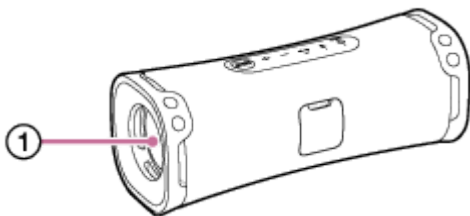

- Wipe off the moisture on its surface, and put the speaker on a dry soft cloth to drain the collected water inside the speaker. Then, dry the speaker in an airy place until no moisture remains.
- The sound quality may change when water enters the speaker or passive radiator section of the speaker. It is not malfunction. Wipe off the moisture on its surface, and put the speaker on a dry soft cloth to drain the collected water inside the speaker. Then, dry the speaker in an airy place until no moisture remains.

Note

- If the surface of the speaker gets dirty, do not use detergent, thinner, benzine, alcohol, etc. to clean the speaker because it will affect the water repellent function of the fabric part of the speaker.
- Especially in cold regions, be sure to wipe off the moisture after using the speaker. Leaving moisture on its surface may cause the speaker to freeze and malfunction.
- If sand grains, etc. enter the fabric or other part of the speaker, remove them carefully. Never use a vacuum cleaner, etc. on the speaker. It may cause damage of the speaker section or other part of the speaker.

Wireless Speaker
ULT FIELD 1

About the BLUETOOTH wireless technology

The BLUETOOTH wireless technology is a short-range wireless technology that enables communication between digital devices, such as smartphones and computers.

Supported version and profiles of the BLUETOOTH standard

A profile is a set of functions standardized for every characteristic of BLUETOOTH devices. The speaker supports the following version and profiles of the BLUETOOTH standard.

Supported BLUETOOTH version: BLUETOOTH standard, version 5.3

Supported BLUETOOTH profiles:

- A2DP (Advanced Audio Distribution Profile): Enables transmission and reception of high-quality music contents.
- AVRCP (Audio Video Remote Control Profile): Enables volume adjustment and operations to play/pause music and skip to the beginning of the next/current track.
- HFP (Hands-free Profile)*: Enables hands-free phone call making and smartphone or mobile phone operations.
- HSP (Headset Profile)*: Enables phone call making and smartphone or mobile phone operations.

* If the smartphone or mobile phone with the BLUETOOTH function supports both HFP and HSP, use HFP (Hands-free Profile).

Maximum communication range

Use the BLUETOOTH wireless technology between the speaker and a device that are located within about 30 m (98.4 ft) from each other.

Maximum communication range may shorten under the following conditions.

- There is an obstacle such as a person, metal, or wall between the speaker and BLUETOOTH device.
- A wireless LAN device is in use near the speaker.
- A microwave oven is in use near the speaker.
- A device that generates electromagnetic radiation is in use near the speaker.

Frequency band

2.4 GHz band (2.400 0 GHz - 2.483 5 GHz)

Corresponding content protection

SCMS-T

Transmission range (A2DP)

20 Hz - 20 000 Hz (Sampling frequency 44.1 kHz)

Interference from other devices

Because BLUETOOTH devices and wireless LAN (IEEE802.11ax/b/g/n) use the same frequency (2.4 GHz), microwave interference may occur and result in communication speed deterioration, noise, or invalid connection if the speaker is used near a wireless LAN device.

Interference to other devices

Microwaves emitted from a BLUETOOTH device may affect the operation of electronic medical devices. Turn off the speaker and other BLUETOOTH devices in the following locations, as it may cause an accident.

- Where inflammable gas is present, in a hospital, train, airplane, or a gas station
- Near automatic doors or a fire alarm

Note

- Depending on the network environment, there may be an interruption at the high bitrate transmission.
- To be able to use the BLUETOOTH function, the BLUETOOTH device to be connected requires the same profile as the speaker's. Note also that even if the same profile exists, devices may vary in function depending on their specifications.
- Due to the characteristic of BLUETOOTH wireless technology, the sound played on the speaker is slightly delayed from the sound played on the BLUETOOTH device while talking on the telephone or listening to music.
- The speaker supports security capabilities that comply with the BLUETOOTH standard to provide a secure connection when the BLUETOOTH wireless technology is used, but security may not be enough depending on the setting. Be careful when communicating using BLUETOOTH wireless technology.
- We do not take any responsibility for the leakage of information during BLUETOOTH communication.
- A device featuring the BLUETOOTH function is required to conform to the BLUETOOTH standard specified by the Bluetooth SIG, Inc. and be authenticated. Even if the connected device conforms to the above mentioned BLUETOOTH standard, some devices may not be connected or work correctly, depending on the features or specifications of the device.
- Noise or sound interruption may occur depending on the BLUETOOTH device connected with the speaker, the communication environment or the usage environment.
- A device with a built-in radio or tuner cannot be connected to the speaker via a BLUETOOTH connection since noise may occur in broadcasts.
- Locate the speaker farther away from a TV, radio or tuner, etc. since noise may occur in broadcasts.

Wireless Speaker
ULT FIELD 1

Licenses

- This product contains software that Sony uses under a licensing agreement with the owner of its copyright. We are obligated to announce the contents of the agreement to customers under requirement by the owner of copyright for the software. Please access the following URL and read the contents of the license.
<https://rd1.sony.net/help/speaker/sl/24/>
- Use of the Made for Apple badge means that an accessory has been designed to connect specifically to the Apple product(s) identified in the badge, and has been certified by the developer to meet Apple performance standards. Apple is not responsible for the operation of this device or its compliance with safety and regulatory standards.
- Services offered by third parties may be changed, suspended, or terminated without prior notice. Sony does not bear any responsibility in these sorts of situations.

Wireless Speaker
ULT FIELD 1

Trademarks

- Google, Android and Google Play are trademarks of Google LLC.
- Apple, the Apple logo, iPhone, iPod, iPod touch, Mac, macOS and Siri are trademarks of Apple Inc., registered in the U.S. and other countries.
- App Store is a service mark of Apple Inc., registered in the U.S. and other countries.
- IOS is a trademark or registered trademark of Cisco in the U.S. and other countries and is used under license.
- Microsoft and Windows are registered trademarks or trademarks of Microsoft Corporation in the United States and/or other countries.
- The BLUETOOTH® word mark and logos are registered trademarks owned by Bluetooth SIG, Inc. and any use of such marks by Sony Group Corporation and its subsidiaries is under license.
- USB Type-C® and USB-C® are registered trademarks of USB Implementers Forum.

All other trademarks and registered trademarks are trademarks or registered trademarks of their respective holders. In this manual, ™ and ® marks are not specified.

Wireless Speaker
ULT FIELD 1

What can I do to solve a problem?

If the speaker does not function as expected, try the following steps to resolve the issue.

- Find the symptoms of the issue in this Help Guide and try any corrective actions listed.
- Charge the speaker.
You may be able to resolve some issues by charging the built-in battery.
- Restart the speaker.
- Initialize the speaker.
This operation restores the settings such as volume, etc. to the default settings, and deletes all pairing information.
- Look up information on the issue on the customer support website.
- Access the following support home pages to get support information about your speaker:
 - For customers in Americas:
<https://www.sony.com/am/support>
 - For customers in Europe:
<https://www.sony.eu/support>
 - For customers in China:
<https://service.sony.com.cn>
 - For customers in other countries/regions:
<https://www.sony-asia.com/support>

If the operations above do not work, consult your nearest Sony dealer.

Related Topic

- [Restarting the speaker](#)
- [Initializing the speaker](#)

Unable to charge the speaker

- When a USB AC adaptor (commercially available) is in use, make sure that the USB cable is connected securely to the speaker and the USB AC adaptor. Then, make sure that the USB AC adaptor is connected securely to an AC outlet.
- When using a USB AC adaptor (commercially available), make sure that it is capable of delivering an output current of 1.5 A or more. You can use a USB AC adaptor with an output current of 500 mA or more and less than 1.5 A as well, but it may take a very long time before charging completes. When using such a USB AC adaptor, it is recommended that you turn off the speaker before battery charging. Use of a USB AC adaptor with an output current of less than 500 mA is not guaranteed for battery charging. The charging time may vary depending on the ambient temperature or the usage of the speaker as well.
- The speaker supports USB AC adaptors that are capable of delivering an output current of 3.0 A or 1.5 A. When using a USB AC adaptor with an output current of 3.0 A for battery charging, be sure to use a USB Type-C cable (compliant with the USB standard) that supports an output current of 3.0 A. The supplied USB cable supports an output current of up to 1.5 A. Use of any other devices is not guaranteed for battery charging. The charging time may vary depending on the ambient temperature or the usage of the speaker as well.
- Charge the speaker in an ambient temperature between 5 °C and 35 °C (41 °F and 95 °F). Be aware that the room temperature may fall to 5 °C (41 °F) or lower depending on the season, for example, especially in wintertime.
- You can charge the speaker's built-in battery by connecting the speaker to a computer that comes equipped with a USB charging port as well. However, not all the computers are tested and found compatible with this procedure and the procedure is not applicable to home-built computers.
- Depending on the type or specifications of the USB AC adaptor, if you use the speaker at a loud volume, the remaining power of the rechargeable built-in battery may decrease or the speaker may turn off even while the speaker is connected to an AC outlet by the USB AC adaptor. This, however, does not indicate a malfunction. If such a case occurs, turn off the speaker and let the battery fully charge itself before you use the speaker.

Related Topic

- [Charging the speaker](#)
- [About the indicators](#)
- [Notes on charging](#)

Unable to turn on the speaker or the speaker suddenly turns off

- The rechargeable built-in battery may be empty or running low. Connect the speaker to an AC outlet with a USB AC adaptor (commercially available) for battery charging.
 - Depending on the type or specifications of the USB AC adaptor, if you use the speaker at a loud volume, the remaining power of the rechargeable built-in battery may decrease or the speaker may turn off even while the speaker is connected to an AC outlet by the USB AC adaptor. This, however, does not indicate a malfunction. If such a case occurs, turn off the speaker and let the battery fully charge itself before you use the speaker.
 - The Auto Standby function may have been activated. Turn off the Auto Standby function.
-

Related Topic

- [Charging the speaker](#)
- [Auto Standby \(power saving\) function](#)

No sound/Sound from only one speaker/Low sound level/Distorted sound/Humming or noise in the speaker output/No voice or low voice from callers

- Check that both the speaker and the connected device are turned on.
- Turn up the volume of the speaker and the connected device.
- Depending on the connected BLUETOOTH device, volume adjustment on the BLUETOOTH device may not change the volume level of the speaker (i.e. the \cup (power) indicator does not flash).
When the volume of the speaker sounds low, adjust the volume level of the BLUETOOTH device to an appropriate one, and then adjust the volume level of the speaker with the $-/+$ (volume) buttons on the speaker.
- Check that the connected device is playing.
- To use a video call application on a computer, operate the computer to change the BLUETOOTH profile to HFP or HSP.
During a video call, the sound quality may deteriorate depending on the conditions of the communication link.
- If you are connecting a computer to the speaker, make sure the audio output setting of the computer is set for a BLUETOOTH device.
- Check that the speaker has established a BLUETOOTH connection with the BLUETOOTH device.
- Pair the speaker and the BLUETOOTH device again.
- Before connecting 2 speakers via a BLUETOOTH connection for the Stereo Pair function, update the pre-installed software to the latest version on each speaker.
- If the connected device has an equalizer function, set it to off.
- Move the speaker away from a device such as a microwave oven and a wireless LAN access point.
- Bring the BLUETOOTH device closer to the speaker. If there is any obstacle between the speaker and the BLUETOOTH device, move it out of the way.
- If the CHARGE indicator starts flashing slowly, turn off the speaker and charge the built-in battery sufficiently.
- A device with a built-in radio or tuner cannot be connected to the speaker via a BLUETOOTH connection since noise may occur in broadcasts.
- Locate the speaker farther away from a TV, radio or tuner, etc. since noise may occur in broadcasts.
- When using the Stereo Pair function or the phone call function, if any other BLUETOOTH device(s) such as a BLUETOOTH mouse or BLUETOOTH keyboard is connected to the BLUETOOTH device, terminate the connection between them.
- There are some BLUETOOTH devices that can have the BLUETOOTH connection quality changed. If your device is compatible with this function, select "Priority on Stable Connection (SBC)" for the BLUETOOTH connection quality. For details, refer to the operating instructions supplied with the device.
- Select "Priority on Stable Connection (SBC)" for the BLUETOOTH connection quality of the speaker.

- Install the latest version of “Sony | Music Center” on the connected device. If you cannot use the latest version of “Sony | Music Center” or you cannot connect the speaker and a BLUETOOTH device via a BLUETOOTH connection, uninstall “Sony | Music Center” and install it again.
- When receiving/making a phone call, check that output of the BLUETOOTH device is set for the speaker.
- Depending on the app being used on the connected BLUETOOTH device, you may hear no sound. In such a case, close the app and start it once again. This may help for solving the issue.

Related Topic

- [Charging the speaker](#)
- [Pairing and connecting with BLUETOOTH devices](#)
- [Listening to music of a device via a BLUETOOTH connection](#)
- [Selecting the quality for music playback via a BLUETOOTH connection \(Codec\)](#)
- [About the indicators](#)
- [Receiving a call](#)
- [Making a call](#)





Sound becomes low while in use

- The sound may become low in the following cases. This is not a malfunction.
 - When the built-in battery is running low and the CHARGE indicator flashes slowly, while the speaker is being powered by the built-in battery only.
 - When the rechargeable built-in battery is running low as a result of long-time use of the speaker at a loud volume even though the speaker was connected to an AC outlet by a USB AC adaptor (commercially available) or to a computer that comes equipped with a USB charging port.
 - When the ambient temperature of the speaker is high.
- If the sound becomes low while in use, follow the procedure below.
 1. Turn off the speaker.
 2. Charge the built-in battery sufficiently.

Related Topic

- [Charging the speaker](#)

Unable to pair the speaker with a BLUETOOTH device

- Place the speaker and the BLUETOOTH device within 1 m (3.2 ft) of each other.
 - To use the Stereo Pair function, pair with the speaker of which the  (BLUETOOTH) indicator flashes in blue.
 - If the  (BLUETOOTH) indicator is not double flashing in blue, press the  (BLUETOOTH) button. You hear voice guidance (Pairing) and the  (BLUETOOTH) indicator starts double flashing (pairing mode).
 - Once the speaker is initialized, an iPhone may not be able to connect to the speaker. In this case, delete pairing information on the iPhone, then pair them again.
 - Check that the BLUETOOTH device is turned on and the BLUETOOTH function is activated on the device.
 - If the speaker is not displayed on the BLUETOOTH device, turn off the BLUETOOTH function on the device, and then turn on the BLUETOOTH function again. It may improve symptoms.
-

Related Topic

- [Pairing and connecting with BLUETOOTH devices](#)
- [About the indicators](#)
- [Initializing the speaker](#)

Wireless Speaker
ULT FIELD 1

Speaker output is interrupted

While the “Priority on Sound Quality” preference is selected for the BLUETOOTH connection quality, signal reception on the speaker may fluctuate depending on the combination of the setup on your BLUETOOTH device and the ambient conditions. In such a case, the following may help for solving the issue.

- Move the speaker away from a device such as a microwave oven and a wireless LAN access point.
 - There are some BLUETOOTH devices that can have the BLUETOOTH connection quality changed. If your device is compatible with this function, select “Priority on Stable Connection (SBC)” for the BLUETOOTH connection quality. For details, refer to the operating instructions supplied with the device.
 - Select “Priority on Stable Connection (SBC)” for the BLUETOOTH connection quality of the speaker.
-

Related Topic

- [Selecting the quality for music playback via a BLUETOOTH connection \(Codec\)](#)

Unable to connect a BLUETOOTH device with the speaker for the Stereo Pair function

- Update the pre-installed software to the latest version on each speaker to connect for the function. (For details about the update procedure, see [Updating the pre-installed software.](#))
 - Update “Sony | Music Center” to the latest version before setting up the Stereo Pair function. For details about “Sony | Music Center,” refer to the following URL: <https://www.sony.net/smcqa/>
 - Make sure that the 2 speakers to connect for the function are located within 1 m (3.2 ft) from each other.
 - While music playback is in progress, stop the playback before setting up the Stereo Pair function.
-

Related Topic

- [Listening to music wirelessly with 2 speakers \(Stereo Pair function\)](#)
- [What you can do with “Sony | Music Center”](#)
- [Updating the pre-installed software](#)

Wireless Speaker
ULT FIELD 1

Restarting the speaker

In the event such as the following, among others, press and hold the  (power) button for about 10 seconds to restart the speaker.

- You cannot operate the speaker after you turn it on.
- You cannot operate the speaker after you troubleshoot pairing issues.

The speaker is turned off during the restart process, and then turned back on upon completion of the process.

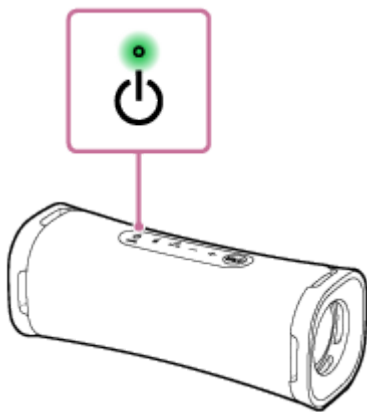

Note

- Restarting the speaker does not delete its pairing information. The pairing information, however, is stored on the speaker when the speaker is turned off. After pairing the speaker with a new device, turn off the speaker and turn it back on, and then restart the speaker.
- Restarting the speaker may change its volume, function, or sound settings.

Wireless Speaker
ULT FIELD 1

Initializing the speaker

If the speaker fails to operate successfully after you restart it, initialize the speaker to resume its default settings. While the speaker is turned on, press and hold the – (volume) button and the  (BLUETOOTH) button until the speaker turns off (5 seconds or more).

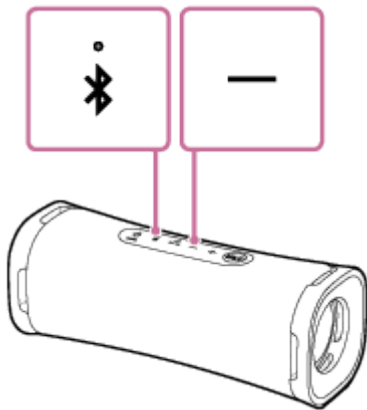

The speaker is initialized. Settings such as volume, etc., are restored to the default settings, and all pairing information is deleted.

Note

- The speaker cannot be initialized while the power is off.

Related Topic

- [Pairing and connecting with BLUETOOTH devices](#)
- [Restarting the speaker](#)

Wireless Speaker
ULT FIELD 1

Specifications

Speaker

Speaker unit

Woofer unit: Approx. 83 mm × 42 mm (3.3 in × 1.7 in) (1)

Tweeter unit: Approx. 16 mm (0.7 in) dia. (1)

Enclosure type

Passive radiator model

Microphone

Built-in microphone specifications

Type: Electret condenser

Directional characteristic: Omni directional

Effective frequency range: 100 Hz - 7 000 Hz

General

Power

DC 5 V 3 A (using a commercially-available USB AC adaptor capable of feeding in 3.0 A) or, using built-in lithium-ion battery

Operating temperatures

5 °C - 35 °C (41 °F - 95 °F)

Dimensions (including projecting parts and controls)

Approx. 206 mm × 77 mm × 76 mm (8.1 in × 3.1 in × 3.0 in) (w/h/d)

Mass (including battery)

Approx. 650 g (23 oz)

Hint

- For the time required for charging the built-in rechargeable battery and the built-in battery life while audio playback from a BLUETOOTH device is in progress, see [Charging the speaker](#).

System requirements for charging battery using USB

Using a commercially-available USB AC adaptor capable of delivering an output current of 1.5 A or 3.0 A*
(Use of a USB AC adaptor capable of delivering an output current of 3.0 A reduces the battery charging time.)

* When using a USB AC adaptor with an output current of 3.0 A, be sure to use a USB Type-C cable that conforms to the USB standard and supports an output current of 3.0 A. The supplied USB cable supports an output current of up to 1.5 A.

Compatible iPhone/iPod models

iPhone 14 Pro Max, iPhone 14 Pro, iPhone 14 Plus, iPhone 14, iPhone SE (3rd generation), iPhone 13 Pro Max, iPhone 13 Pro, iPhone 13, iPhone 13 mini, iPhone 12 Pro Max, iPhone 12 Pro, iPhone 12, iPhone 12 mini, iPhone SE (2nd

generation), iPhone 11 Pro Max, iPhone 11 Pro, iPhone 11, iPhone XS Max, iPhone XS, iPhone XR, iPhone X, iPhone 8 Plus, iPhone 8, iPhone 7 Plus, iPhone 7, iPod touch (7th generation)
(As of November 2023)

5-057-417-11(1) Copyright 2024 Sony Corporation