

Dell USB-C Hub Monitor

P2425HE/P2425HE WOST/P2425E/ P2725HE/P2725HE WOST

User's Guide

Model: P2425HE/P2425HE WOST/P2425E/P2725HE/P2725HE WOST
Regulatory model: P2425HEb,P2425HEc/P2425Eb/P2725HEt



 **NOTE: A NOTE indicates important information that helps you make better use of your computer.**

 **CAUTION: A CAUTION indicates potential damage to hardware or loss of data if instructions are not followed.**

 **WARNING: A WARNING indicates a potential for property damage, personal injury, or death.**

Copyright © 2024 Dell Inc. or its subsidiaries. All rights reserved. Dell, EMC, and other trademarks are trademarks of Dell Inc. or its subsidiaries. Other trademarks may be trademarks of their respective owners.

2024 - 03

Rev. A00

Contents

Safety instructions	6
About your monitor	7
Package contents	7
Product features	9
Operating system compatibility	13
Identifying parts and controls	13
Front view	13
Back view	14
Rear and bottom view	15
Monitor specifications	17
Resolution specifications	23
Supported video modes	23
Preset display modes	24
Multi-Stream Transport (MST) Modes	26
Electrical specifications	27
Physical characteristics	29
Environmental characteristics	33
Pin assignments	34
DisplayPort connector (in)	34
DisplayPort connector (out)	35
HDMI connector	36
Universal Serial Bus (USB) interface	37
RJ45 connector	41
Plug and play capability	43
LCD monitor quality and pixel policy	44
Ergonomics	44



Handling and moving your display	46
Maintenance guidelines	47
Cleaning your monitor	47
Setting up the monitor	49
Attaching the stand	49
Connecting your monitor	52
Connecting the DisplayPort (DP to DP) cable.	53
Connecting the USB-C to USB-C cable.	53
Connecting the HDMI cable (optional)	53
Connecting the monitor for DP Multi-Stream Transport (MST) function	54
Connecting the monitor for USB-C Multi-Stream Transport (MST) function	54
Connecting the monitor for RJ45 cable (optional)	55
Dell Power Button Sync (DPBS)	55
Connecting the monitor for DPBS for the first time	58
Using DPBS function	59
Connecting the monitor for USB-C Multi-Stream Transport (MST) function	61
Connecting the monitor for USB-C	62
Organizing your cables.	64
Securing your monitor using Kensington lock (optional).	64
Removing the monitor stand	65
VESA wall mounting (optional)	66
Operating the monitor	67
Turn on the monitor	67
Using the joystick control	67
Using the On-Screen Display (OSD) menu	68
Accessing the Menu Launcher.	68
Using the navigation keys	69
Accessing the menu system	70



OSD messages	84
Initial Setup	84
OSD warning message	85
Locking the control buttons	88
Setting the maximum resolution	89
Using the tilt, swivel, pivot and height adjustment	90
Tilt and swivel adjustment	90
Height adjustment	90
Pivot adjustment	91
Rotate clockwise	91
Rotate counterclockwise	92
Adjusting the rotation display settings of your system	93
Troubleshooting	94
Self-test	94
Built-in diagnostics	95
Common problems	96
Product specific problems	100
Universal Serial Bus (USB) specific problems	103
Regulatory information	105
FCC notices (U.S. only) and other regulatory information	105
EU product database for energy label and product information sheet	105
Contacting Dell	106



Safety instructions

Use the following safety guidelines to protect your monitor from potential damage and to ensure your personal safety. Unless otherwise noted, each procedure included in this document assumes that you have read the safety information that shipped with your monitor.

 **NOTE: Before using the monitor, read the safety information that is shipped with your monitor and printed on the product. Keep the documentation at a secure location for future reference.**

 **WARNING: Use of controls, adjustments, or procedures other than those specified in this documentation may result in exposure to shock, electrical hazards, and/or mechanical hazards.**

 **WARNING: The possible long-term effect of listening to audio at high volume through the headphones (on monitor that support it) may cause damage to your hearing ability.**

- Place the monitor on a solid surface and handle it carefully. The screen is fragile and can be damaged if dropped or hit with a sharp object.
- Ensure that your monitor is electrically rated to operate with the AC power available in your location.
- Keep the monitor in room temperature. Excessive cold or hot conditions can have an adverse effect on the liquid crystals of the display.
- Connect the power cable from the monitor to a wall outlet that is near and accessible. See [Connecting your monitor](#).
- Do not place and use the monitor on a wet surface or near water.
- Do not subject the monitor to severe vibration or high impact conditions. For example, do not place the monitor inside a car trunk.
- Unplug the monitor when it is going to be left unused for an extended period.
- To avoid electric shock, do not attempt to remove any cover or touch the inside of the monitor.
- Read these instructions carefully. Keep this document for future reference. Follow all warnings and instructions marked on the product.
- Certain monitors can be wall mounted using the VESA mount that is sold separately. Ensure to use the correct VESA specifications as mentioned in the wall mounting section of the *User's Guide*.

For information on safety instructions, see the *Safety, Environmental, and Regulatory Information (SERI)* document that is shipped with your monitor.







About your monitor



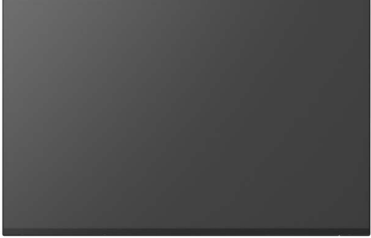

Package contents

The following table provides the list of components that are shipped with your monitor. If any component is missing, contact Dell. For more information, see [Contacting Dell](#).

 **NOTE: Some items may be optional and may not ship with your monitor. Some features may not be available in certain countries.**

Component image	Component description
	Display
	Stand riser
	Stand base
	Power cable (varies by country)



	<p>DisplayPort 1.4 cable (DP to DP) Cable length: 1.80 M</p>
	<p>USB Type-C 3.2 Gen2 cable Cable length: 1 M</p>
	<p>Cable tie</p>
	<ul style="list-style-type: none"> • Quick Setup Guide • Safety, Environmental, and Regulatory Information



Product features

The **Dell P2425HE/P2425HE WOST/P2425E/P2725HE/P2725HE WOST** monitor has an active matrix, Thin-Film Transistor (TFT), Liquid Crystal Display (LCD) and LED backlight. The monitor features include:

- **P2425HE/P2425HE WOST:** 604.70 mm (23.81 in.) viewable area (measured diagonally). 1920 x 1080 (16:9) resolution, plus full-screen support for lower resolutions.
- **P2425E:** 611.32 mm (24.07 in.) viewable area (measured diagonally). 1920 x 1200 (16:10) resolution, plus full-screen support for lower resolutions.
- **P2725HE/P2725HE WOST:** 686 mm (27 in.) viewable area (measured diagonally). 1920 x 1080 (16:9) resolution, plus full-screen support for lower resolutions.
- Wide viewing angle to allow viewing from a sitting or standing position.
- Color gamut of 99% sRGB (typical).
- Digital connectivity with DisplayPort, HDMI, and USB Type-C (with DP Alternate Mode).
- Single USB Type-C to supply power (PD 90 W) to a compatible notebook while receiving video and data signal.
- Tilt, swivel, height, and pivot adjustment capabilities.
- Ultra-thin bezel minimizes the bezel gap in multi-monitor usage, enabling easier setup with an elegant viewing experience.
- Removable stand and Video Electronics Standards Association (VESA™) 100 mm mounting holes for flexible mounting solutions.
- Equipped with:
 - One super speed USB Type-C upstream port (video and data; DP1.4 with Alternate mode, PD up to 90 W)
 - One super speed USB 5 Gbps (USB 3.2 Gen1) Type-C downstream port
 - Three super speed USB 5 Gbps (USB 3.2 Gen1) Type-A downstream ports
- USB-C and RJ45 ports enable a single-cable, network-connected experience.
- Plug-and-play capability if supported by your computer.
- On-Screen Display (OSD) adjustments for ease of set-up and screen optimization.
- Power button and OSD menu lock.
- Security-lock slot.
- Stand lock.



- **P2425HE/P2425HE WOST/P2425E:** ≤ 0.3 W in Standby Mode.
P2725HE/P2725HE WOST: ≤ 0.5 W in Standby Mode.
- Dell ComfortView Plus is an integrated low blue light screen feature that improves eye comfort by reducing potentially harmful blue light emissions without compromising color. Through ComfortView Plus technology, Dell has reduced harmful blue light exposure from $\leq 50\%$ to $\leq 35\%$. This monitor is certified with TÜV Rheinland Eye Comfort 3.0 with a 4-star rating. It incorporates key technologies that also deliver a flicker-free screen, up to 100 Hz refresh rate, a color gamut of minimum 95% sRGB. Dell ComfortView Plus feature is enabled by default on your monitor.
- This monitor uses a low blue light panel. When the monitor is reset to factory settings or default setting, it is in compliance with TÜV Rheinland's hardware low blue light certification.*

Blue light ratio:

The ratio of light in the range from 415nm-455nm compared to 400nm-500nm shall be less than 50%.

Category	Blue light ratio
1	$\leq 20\%$
2	$20\% < R \leq 35\%$
3	$35\% < R \leq 50\%$

- Decreases the level of hazard blue light emitted from the screen to make viewing more comfortable for your eyes without distortion of color accuracy.
- The monitor adopts Flicker-Free technology, which clears the eye visible flicker, brings comfort viewing experience and preventing users suffer from eye strain and fatigue.

*This monitor is in compliance with TÜV Rheinland hardware low blue light certification under Category 2.



About TÜV Rheinland Eye Comfort 3.0

TÜV Rheinland Eye Comfort 3.0 certification program presents a consumer-friendly star rating scheme to the display industry promoting eye wellness from safety to eye care. Compared to existing certifications, the 5-star-rating program adds rigorous testing requirements on overall eye care attributes such as low blue-light, flicker-free, refresh rate, color gamut, color accuracy and ambient light sensor performance. It lays out requirement metrics and rates the product performance on five levels, and the sophisticated technical assessment process provides consumers and buyers with indicators that are easier to judge.

The eye wellness factors being considered remain constant, however, the standards for the various star ratings are different. The higher the star rating, the more stringent the standards. The table below lists the major eye comfort requirements which apply in addition to the basic eye comfort requirements (such as pixel density, uniformity of luminance and color, and freedom of movement).

For more information around **TÜV Eye Comfort certification** please refer to:
<https://www.tuv.com/world/en/eye-comfort.html>



Eye Comfort 3.0 Requirements and Star Rating Scheme for Monitors

Category	Test item	Star Rating Scheme		
		3-star	4-star	5-star
Eye Care	Low Blue Light	TÜV Hardware LBL Category III ($\leq 50\%$) or Software LBL solution ¹	TÜV Hardware LBL Category II ($\leq 35\%$) or Category I ($\leq 20\%$)	TÜV Hardware LBL Category II ($\leq 35\%$) or Category I ($\leq 20\%$)
	Flicker Free	TÜV Flicker Reduced or TÜV Flicker Free	TÜV Flicker Reduced or TÜV Flicker Free	Flicker Free
Ambient Light Management	Ambient Light Sensor performance	No sensor	No sensor	Ambient light sensor
	Intelligent CCT control	No	No	Yes
	Intelligent Luminance control	No	No	Yes
Image quality	Refresh Rate	≥ 60 Hz	≥ 75 Hz	≥ 120 Hz
	Luminance uniformity	Luminance uniformity $\geq 75\%$		
	Color Uniformity	Color uniformity $\Delta u'v' \leq 0.02$		
	Freedom of movement	Luminance changes shall decrease less than 50%; The color shift shall be less than 0.01.		
	Gamma difference	Gamma difference $\leq \pm 0.2$	Gamma difference $\leq \pm 0.2$	Gamma difference $\leq \pm 0.2$
	Wide color gamut ²	NTSC ³ Min.72% (CIE 1931) or sRGB ⁴ Min.95% (CIE 1931)	sRGB ⁴ Min.95% (CIE 1931)	DCI-P3 ⁵ Min.95% (CIE 1976) & sRGB ⁴ Min.95% (CIE 1931) or Adobe RGB ⁶ Min.95% (CIE 1931) & sRGB ⁴ Min.95% (CIE 1931)
Eye Comfort User Guide	User guide	Yes	Yes	Yes
Remark	¹ Software controls the blue light emission by reducing excessive blue light, resulting in a more yellow tone. ² Color gamut describes the availability of colors in the display. Various standards were developed for specific purposes. 100% corresponds to the full color space as defined in the standard. ³ NTSC stands for National Television Standards Committee, which developed a color space for the television system that is used in the United States. ⁴ sRGB is a standard red, green, and blue color space that is in use on monitors, printers, and the World Wide Web. ⁵ DCI-P3, short for Digital Cinema Initiatives - Protocol 3, is a color space used in digital cinema that encompasses a wider range of colors than the standard RGB color space. ⁶ Adobe RGB is a color space created by Adobe Systems that encompasses a broader range of colors than the standard RGB color model, particularly in the cyans and greens.			



Operating system compatibility

- Windows 10 and later*
- macOS 12* and macOS 13*

*The operating system compatibility on Dell and Alienware branded monitors may vary based on factors such as:

- Specific release date(s) when operating system versions, patches, or updates are available.
- Specific release date(s) when Dell and Alienware branded monitor firmware, software application, or driver updates are available on the Dell support website.

Identifying parts and controls

Front view



Label	Description	Use
1	Power LED indicator	Solid white light indicates that the monitor is turned on and functioning normally. Blinking white light indicates that the monitor is in Standby Mode.



Back view



Back view with monitor stand





Label	Description	Use
1	VESA mounting holes (100 mm x 100 mm - behind attached VESA cover)	Wall mount monitor using VESA-compatible wall mount kit (100 mm x 100 mm).
2	Regulatory label	Lists the regulatory approvals.
3	Stand release button	Releases stand from the monitor.
4	Barcode, serial number, and Service Tag label	See this label if you need to contact Dell for technical support. The Service Tag is a unique alphanumeric identifier that enables Dell service technicians to identify the hardware components in your monitor and access warranty information.
5	Power button	To turn the monitor on or off.
6	Joystick	Use to control the OSD menu. For more information, see Operating the monitor .
7	Cable-management slot	Use to organize cables by inserting them through the slot.

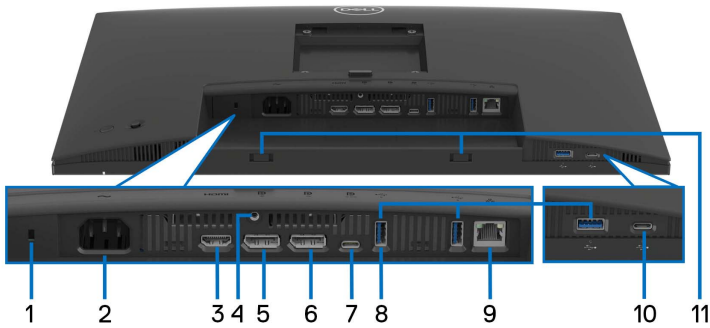





Rear and bottom view



Rear and bottom view without monitor stand

Label	Description	Use
1	Security-lock slot (based on Kensington Security Slot)	Secure your monitor using a security lock (to be purchased separately) to prevent unauthorized movement of your monitor.
2	 Power connector	Connect the power cable (shipped with your monitor).
3	 HDMI port	Connect your computer with the HDMI cable.
4	Stand-lock feature	Lock the stand to the monitor using a M3x6 mm screw (screw not included).
5	 DisplayPort (in)	Connect your computer with the DisplayPort cable (shipped with your monitor).
6	 DisplayPort (out) 	DisplayPort output for MST (multi-stream transport) capable monitor. To enable MST, see Connecting the monitor for DP Multi-Stream Transport (MST) function . NOTE: Remove the rubber plug when using DisplayPort out connector.



<p>7</p>  <p>Super speed USB 5 Gbps (USB 3.2 Gen1) Type-C upstream port (video and data)</p>	<p>Connect the USB Type-C cable that came with your monitor to the computer or mobile device. This port supports USB Power Delivery, Data, and DisplayPort video signal.</p> <p>The super speed USB 5 Gbps (USB 3.2 Gen1) Type-C port supports Alternate Mode DP1.4 with a maximum resolution of 1920 x 1200 (P2425E)/ 1920 x 1080 (P2425HE/P2425HE WOST/ P2725HE/P2725HE WOST) at 100 Hz, PD 20 V/ 4.5 A, 15 V/3 A, 9 V/3 A, 5 V/3 A.</p> <p>NOTE: USB Type-C is not supported on versions of Windows prior to Windows 10.</p>
<p>8</p>  <p>Super speed USB 5 Gbps (USB 3.2 Gen1) Type-A downstream port (3)</p>	<p>Connect your USB device* or charge your device.</p> <p>NOTE: To use these ports, you must connect the USB Type-C cable (shipped with your monitor) to the USB Type-C upstream port on the monitor and to your computer.</p>
<p>9</p>  <p>RJ45 port</p>	<p>Supports Ethernet connection 10/100/1000 Mbps. Connect the Internet. You can surf the Internet via RJ45 only after you have connected the USB Type-C cable (shipped with your monitor) from your computer to the monitor.</p>
<p>10</p>  <p>Super speed USB 5 Gbps (USB 3.2 Gen1) Type-C downstream port (data only)</p>	<p>Connect your USB device.*</p> <p>NOTE: To use these ports, you must connect the USB Type-C cable (shipped with your monitor) to the USB Type-C upstream port on the monitor and to your computer.</p>
<p>11</p> <p>Soundbar slots</p>	<p>Attach your external Soundbar (sold separately) to the monitor by aligning the magnetic tabs on the soundbar with the slots on the monitor.</p>

*To avoid signal interference, when a wireless USB device has been connected to a USB downstream port, it is NOT recommended to connect any other USB devices to the adjacent port(s).



Monitor specifications

Model	P2425HE/P2425HE WOST
Screen type	Active matrix - TFT LCD
Panel technology	In-Plane Switching Technology
Aspect ratio	16:9
Viewable image	
Diagonal	604.70 mm (23.81 in.)
Horizontal (active area)	527.04 mm (20.75 in.)
Vertical (active area)	296.46 mm (11.67 in.)
Area	156246.28 mm ² (242.18 in. ²)
Pixel pitch	0.2745 mm x 0.2745 mm
Pixel per inch (PPI)	92.53
Viewing angle	
Vertical	178° (typical)
Horizontal	178° (typical)
Luminance output	250 cd/m ² (typical)
Contrast ratio	1,500:1 (typical)
Faceplate coating	Anti-Glare with 3H hardness
Backlight	LED edgelight system
Response time	8 ms gray-to-gray (Normal) 5 ms gray-to-gray (Fast)
Color depth	Up to 16.70 million colors
Color gamut	99% sRGB (typical)



Connectivity	<ul style="list-style-type: none"> • 1 x HDMI 1.4 port (HDCP1.4)* • 1 x DP 1.4 (HDCP1.4) • 1 x DP (Out) with MST (HDCP 1.4) • 1 x Super speed USB 5 Gbps (USB 3.2 Gen1) Type-C upstream port (video and data) (Alternate mode with DisplayPort 1.4, Power Delivery PD up to 90 W)** • 2 x Super speed USB 5 Gbps (USB 3.2 Gen1) Type-A downstream ports • 1 x RJ45 port <p>Quick Access</p> <ul style="list-style-type: none"> • 1 x Super speed USB 5 Gbps (USB 3.2 Gen1) Type-A downstream port • 1 x Super speed USB 5 Gbps (USB 3.2 Gen1) Type-C downstream port with charging capability of up to 15 W PD
Border width (edge of monitor to active area)	
Top	5.80 mm
Left/Right	5.80 mm
Bottom	12 mm
Adjustability	
Height adjustable stand	150 mm
Tilt	-5° to 21°
Swivel	-45° to 45°
Pivot	-90° to 90°
Cable management	Yes (applicable for P2425HE only)
Dell Display Manager compatibility	Easy Arrange and other key features
Security	Security-lock slot (cable lock sold separately)

*Supports up to FHD 1920 x 1080 100 Hz TMDS as per specified in HDMI 1.4.

**DisplayPort and USB Type-C (Alternate mode with DisplayPort 1.4): HBR3/DisplayPort 1.4 is supported.



Model	P2425E
Screen type	Active matrix - TFT LCD
Panel technology	In-Plane Switching Technology
Aspect ratio	16:10
Viewable image	
Diagonal	611.32 mm (24.07 in.)
Horizontal (active area)	518.40 mm (20.41 in.)
Vertical (active area)	324 mm (12.76 in.)
Area	167961.60 mm ² (260.34 in. ²)
Pixel pitch	0.2700 mm x 0.2700 mm
Pixel per inch (PPI)	94.07
Viewing angle	
Vertical	178° (typical)
Horizontal	178° (typical)
Luminance output	300 cd/m ² (typical)
Contrast ratio	1,500:1 (typical)
Faceplate coating	Anti-Glare with 3H hardness
Backlight	LED edgelight system
Response time	8 ms gray-to-gray (Normal) 5 ms gray-to-gray (Fast)
Color depth	Up to 16.70 million colors
Color gamut	99% sRGB (typical)



Connectivity	<ul style="list-style-type: none"> • 1 x HDMI 1.4 port (HDCP1.4)* • 1 x DP 1.4 (HDCP1.4) • 1 x DP (Out) with MST (HDCP 1.4) • 1 x Super speed USB 5 Gbps (USB 3.2 Gen1) Type-C upstream port (video and data) (Alternate mode with DisplayPort 1.4, Power Delivery PD up to 90 W)** • 2 x Super speed USB 5 Gbps (USB 3.2 Gen1) Type-A downstream ports • 1 x RJ45 port <p>Quick Access</p> <ul style="list-style-type: none"> • 1 x Super speed USB 5 Gbps (USB 3.2 Gen1) Type-A downstream port • 1 x Super speed USB 5 Gbps (USB 3.2 Gen1) Type-C downstream port with charging capability of up to 15 W PD
Border width (edge of monitor to active area)	
Top	6.70 mm
Left/Right	6.70 mm
Bottom	13 mm
Adjustability	
Height adjustable stand	150 mm
Tilt	-5° to 21°
Swivel	-45° to 45°
Pivot	-90° to 90°
Cable management	Yes
Dell Display Manager compatibility	Easy Arrange and other key features
Security	Security-lock slot (cable lock sold separately)

*Supports up to WUXGA 1920 x 1200 100 Hz TMDS as per specified in HDMI 1.4.

**DisplayPort and USB Type-C (Alternate mode with DisplayPort 1.4): HBR3/DisplayPort 1.4 is supported.



Model	P2725HE/P2725HE WOST
Screen type	Active matrix - TFT LCD
Panel technology	In-Plane Switching Technology
Aspect ratio	16:9
Viewable image	
Diagonal	686 mm (27 in.)
Horizontal (active area)	597.89 mm (23.54 in.)
Vertical (active area)	336.31 mm (13.24 in.)
Area	201076.39 mm ² (311.67 in. ²)
Pixel pitch	0.3114 mm x 0.3114 mm
Pixel per inch (PPI)	81.57
Viewing angle	
Vertical	178° (typical)
Horizontal	178° (typical)
Luminance output	300 cd/m ² (typical)
Contrast ratio	1,500:1 (typical)
Faceplate coating	Anti-Glare with 3H hardness
Backlight	LED edgelight system
Response time	8 ms gray-to-gray (Normal) 5 ms gray-to-gray (Fast)
Color depth	Up to 16.70 million colors
Color gamut	99% sRGB (typical)



Connectivity	<ul style="list-style-type: none"> • 1 x HDMI 1.4 port (HDCP1.4)* • 1 x DP 1.4 (HDCP1.4) • 1 x DP (Out) with MST (HDCP 1.4) • 1 x Super speed USB 5 Gbps (USB 3.2 Gen1) Type-C upstream port (video and data) (Alternate mode with DisplayPort 1.4, Power Delivery PD up to 90 W)** • 2 x Super speed USB 5 Gbps (USB 3.2 Gen1) Type-A downstream ports • 1 x RJ45 port <p>Quick Access</p> <ul style="list-style-type: none"> • 1 x Super speed USB 5 Gbps (USB 3.2 Gen1) Type-A downstream port • 1 x Super speed USB 5 Gbps (USB 3.2 Gen1) Type-C downstream port with charging capability of up to 15 W PD
Border width (edge of monitor to active area)	
Top	6.40 mm
Left/Right	6.40 mm
Bottom	12 mm
Adjustability	
Height adjustable stand	150 mm
Tilt	-5° to 21°
Swivel	-45° to 45°
Pivot	-90° to 90°
Cable management	Yes (applicable for P2725HE only)
Dell Display Manager compatibility	Easy Arrange and other key features
Security	Security-lock slot (cable lock sold separately)

*Supports up to FHD 1920 x 1080 100 Hz TMDS as per specified in HDMI 1.4.

**DisplayPort and USB Type-C (Alternate mode with DisplayPort 1.4): HBR3/DisplayPort 1.4 is supported.



Resolution specifications

Model	P2425HE/P2425HE WOST/P2725HE/ P2725HE WOST
Horizontal scan range	30 kHz to 110 kHz (automatic)
Vertical scan range	48 Hz to 100 Hz (automatic)
Maximum preset resolution	1920 x 1080 at 100 Hz

Model	P2425E
Horizontal scan range	30 kHz to 122 kHz (automatic)
Vertical scan range	48 Hz to 100 Hz (automatic)
Maximum preset resolution	1920 x 1200 at 100 Hz

Supported video modes

Model	P2425HE/P2425HE WOST/P2425E/ P2725HE/P2725HE WOST
Video display capabilities (HDMI & DisplayPort & USB Type-C alternate mode)	1080p, 720p, 576p, 480p



Preset display modes

P2425HE/P2425HE WOST/P2725HE/P2725HE WOST

Display mode	Horizontal frequency (kHz)	Vertical frequency (Hz)	Pixel clock (MHz)	Sync polarity (Horizontal/Vertical)
VESA, 640 x 480	31.5	59.9	25.2	-/-
VESA, 640 x 480	37.5	75.0	31.5	-/-
VESA, 720 x 400	31.5	70.1	28.3	-/+
VESA, 800 x 600	37.9	60.3	40.0	+/+
VESA, 800 x 600	46.9	75.0	49.5	+/+
VESA, 1024 x 768	48.4	60.0	65.0	-/-
VESA, 1024 x 768	60.0	75.0	78.8	+/+
VESA, 1152 x 864	67.5	75.0	108.0	+/+
1280 x 720	45.0	60.0	74.3	-/+
1280 x 720	56.5	74.8	95.8	-/+
VESA, 1280 x 1024	64.0	60.0	108.0	+/+
VESA, 1280 x 1024	80.0	75.0	135.0	+/+
VESA, 1600 x 900	60.0	60.0	108.0	+/+
VESA, 1920 x 1080	67.5	60.0	148.5	+/+
VESA, 1920 x 1080	110.0	100.0	228.8	+/-

 **NOTE: The monitor will also support other display resolutions not listed in the preset mode.**



P2425E

Display mode	Horizontal frequency (kHz)	Vertical frequency (Hz)	Pixel clock (MHz)	Sync polarity (Horizontal/Vertical)
VESA, 640 x 480	31.5	59.9	25.2	-/-
VESA, 640 x 480	37.5	75.0	31.5	-/-
VESA, 720 x 400	31.5	70.1	28.3	-/+
VESA, 800 x 600	37.9	60.3	40.0	+/+
VESA, 800 x 600	46.9	75.0	49.5	+/+
VESA, 1024 x 768	48.4	60.0	65.0	-/-
VESA, 1024 x 768	60.0	75.0	78.8	+/+
VESA, 1152 x 864	67.5	75.0	108.0	+/+
1280 x 720	45.0	60.0	74.3	-/+
1280 x 720	56.5	74.8	95.8	-/+
VESA, 1280 x 1024	64.0	60.0	108.0	+/+
VESA, 1280 x 1024	80.0	75.0	135.0	+/+
VESA, 1600 x 1200	75.0	60.0	162.0	+/+
VESA, 1920 x 1080	67.5	60.0	148.5	+/+
1920 x 1200	74.0	60.0	154.0	+/-
1920 x 1200	121.6	100.0	249.3	+/+

 **NOTE: The monitor will also support other display resolutions not listed in the preset mode.**



Multi-Stream Transport (MST) Modes

P2425HE/P2425HE WOST/P2725HE/P2725HE WOST

Using USB-Type-C

MST source monitor	Maximum number of external monitors can be supported
	1920 x 1080 at 100 Hz
1920 x 1080 at 100 Hz	3* (with USB-C DP Alt mode)

Using DisplayPort

MST source monitor	Maximum number of external monitors can be supported
	1920 x 1080 at 100 Hz
1920 x 1080 at 100 Hz	3*

*Host DP/USB-C port is HBR3 4 Lane condition.

P2425E

Using USB-Type-C

MST source monitor	Maximum number of external monitors can be supported
	1920 x 1200 at 100 Hz
1920 x 1200 at 100 Hz	3* (with USB-C DP Alt mode)

Using DisplayPort

MST source monitor	Maximum number of external monitors can be supported
	1920 x 1200 at 100 Hz
1920 x 1200 at 100 Hz	3*

*Host DP/USB-C port is HBR3 4 Lane condition.



Electrical specifications

Model	P2425HE/P2425HE WOST/P2425E/P2725HE/ P2725HE WOST
Video input signals	<ul style="list-style-type: none"> • HDMI 1.4 (TMDS)*/DisplayPort 1.4**, 600 mV for each differential line, 100 ohm input impedance per differential pair • USB-C (with Alternate mode) signal input support
AC input voltage/ frequency/current	100 VAC to 240 VAC / 50 Hz or 60 Hz \pm 3 Hz / 2 A (typical)
Inrush current	<ul style="list-style-type: none"> • 120 V: 30 A (Max.) at 0°C (cold start) • 240 V: 60 A (Max.) at 0°C (cold start)
Power consumption	
P2425HE/P2425HE WOST	<ul style="list-style-type: none"> • 0.3 W (Off mode)¹ • 0.3 W (Standby mode)¹ • 1.0 W (Networked Standby mode)¹ • 13.9 W (On mode)¹ • 180 W (Max.)² • 15.2 W (P_{on})³ • 49.8 kWh (TEC)³
P2425E	<ul style="list-style-type: none"> • 0.3 W (Off mode)¹ • 0.3 W (Standby mode)¹ • 1.0 W (Networked Standby mode)¹ • 15.0 W (On mode)¹ • 190 W (Max.)² • 15.2 W (P_{on})³ • 49.5 kWh (TEC)³
P2725HE/P2725HE WOST	<ul style="list-style-type: none"> • 0.3 W (Off mode)¹ • 0.4 W (Standby mode)¹ • 1.9 W (Networked Standby mode)¹ • 16.2 W (On mode)¹ • 180 W (Max.)² • 16.6 W (P_{on})³ • 54.9 kWh (TEC)³



***P2425HE/P2425HE WOST/P2725HE/P2725HE WOST**: Supports up to FHD 1920 x 1080 100 Hz TMDS as per specified in HDMI 1.4.

***P2425E**: Supports up to WUXGA 1920 x 1200 100 Hz TMDS as per specified in HDMI 1.4.

**HBR3/DisplayPort 1.4 is supported.

¹ As defined in EU 2019/2021 and EU 2019/2013.

² Max brightness and contrast setting with maximum power loading on all USB ports.

³ P_{on}: Power consumption of On mode as defined in Energy Star 8.0 version.

TEC: Total energy consumption in kWh as defined in Energy Star 8.0 version.

This document is informational only and reflects laboratory performance. Your product may perform differently, depending on the software, components and peripherals you ordered and shall have no obligation to update such information.

Accordingly, the customer should not rely upon this information in making decisions about electrical tolerances or otherwise. No warranty as to accuracy or completeness is expressed or implied.



NOTE: This monitor is ENERGY STAR certified.

This product qualifies for ENERGY STAR in the factory default settings which can be restored by “Factory Reset” function in the OSD menu. Changing the factory default settings or enabling other features may increase power consumption that could exceed the ENERGY STAR specified limit.



Physical characteristics

Model	P2425HE/P2425HE WOST
Signal cable type	<ul style="list-style-type: none"> • Digital: DisplayPort, 20 pins • Digital: HDMI, 19 pins (cable not included) • Universal Series Bus: Type-C, 24 pins
<p>NOTE: Dell monitors are designed to work optimally with the video cables that are shipped with your monitor. As Dell does not have control over the different cable suppliers in the market, the type of material, connector and process used to manufacture these cables, Dell does not guarantee video performance on cables that are not shipped with your Dell monitor.</p>	
Dimensions (with stand)	P2425HE
Height (extended)	496.53 mm (19.55 in.)
Height (compressed)	364 mm (14.33 in.)
Width	538.64 mm (21.21 in.)
Depth	181.75 mm (7.16 in.)
Dimensions (without stand)	P2425HE/P2425HE WOST
Height	314.23 mm (12.37 in.)
Width	538.64 mm (21.21 in.)
Depth	50.03 mm (1.97 in.)
Stand dimensions	P2425HE
Height (extended)	410.80 mm (16.17 in.)
Height (compressed)	364 mm (14.33 in.)
Width	249.80 mm (9.83 in.)
Depth	181.75 mm (7.16 in.)
Base	249.80 mm (9.83 in.) x 177 mm (6.97 in.)
Weight	P2425HE
Weight with packaging	7.24 kg (15.96 lb)
Weight with stand assembly and cables	5.44 kg (11.99 lb)



Weight without stand assembly (For wall mount or VESA mount considerations - no cables)	3.69 kg (8.13 lb)
Weight of stand assembly	1.49 kg (3.28 lb)
Weight	P2425HE WOST
Weight with packaging	5.80 kg (12.79 lb)
Weight without stand assembly and with cables	4 kg (8.82 lb)
Weight without stand assembly (For wall mount or VESA mount considerations - no cables)	3.69 kg (8.13 lb)

Model	P2425E
Signal cable type	<ul style="list-style-type: none"> • Digital: DisplayPort, 20 pins • Digital: HDMI, 19 pins (cable not included) • Universal Series Bus: Type-C, 24 pins
<p>NOTE: Dell monitors are designed to work optimally with the video cables that are shipped with your monitor. As Dell does not have control over the different cable suppliers in the market, the type of material, connector and process used to manufacture these cables, Dell does not guarantee video performance on cables that are not shipped with your Dell monitor.</p>	
Dimensions (with stand)	
Height (extended)	511.20 mm (20.13 in.)
Height (compressed)	364 mm (14.33 in.)
Width	531.80 mm (20.94 in.)
Depth	181.75 mm (7.16 in.)
Dimensions (without stand)	
Height	343.70 mm (13.53 in.)
Width	531.80 mm (20.94 in.)
Depth	50.03 mm (1.97 in.)



Stand dimensions	
Height (extended)	410.80 mm (16.17 in.)
Height (compressed)	364 mm (14.33 in.)
Width	249.80 mm (9.83 in.)
Depth	181.75 mm (7.16 in.)
Base	249.80 mm (9.83 in.) x 177 mm (6.97 in.)
Weight	
Weight with packaging	7.12 kg (15.70 lb)
Weight with stand assembly and cables	5.33 kg (11.75 lb)
Weight without stand assembly (For wall mount or VESA mount considerations - no cables)	3.51 kg (7.75 lb)
Weight of stand assembly	1.51 kg (3.33 lb)

Model	P2725HE/P2725HE WOST
Signal cable type	<ul style="list-style-type: none"> • Digital: DisplayPort, 20 pins • Digital: HDMI, 19 pins (cable not included) • Universal Series Bus: Type-C, 24 pins
<p>NOTE: Dell monitors are designed to work optimally with the video cables that are shipped with your monitor. As Dell does not have control over the different cable suppliers in the market, the type of material, connector and process used to manufacture these cables, Dell does not guarantee video performance on cables that are not shipped with your Dell monitor.</p>	
Dimensions (with stand)	P2725HE
Height (extended)	534.56 mm (21.05 in.)
Height (compressed)	384.56 mm (15.14 in.)
Width	610.68 mm (24.04 in.)
Depth	192.28 mm (7.57 in.)



Dimensions (without stand)	P2725HE/P2725HE WOST
Height	354.71 mm (13.97 in.)
Width	610.68 mm (24.04 in.)
Depth	50.03 mm (1.97 in.)
Stand dimensions	P2725HE
Height (extended)	428.30 mm (16.86 in.)
Height (compressed)	381.50 mm (15.02 in.)
Width	272.80 mm (10.74 in.)
Depth	192.28 mm (7.57 in.)
Base	272.80 mm (10.74 in.) x 189 mm (7.44 in.)
Weight	P2725HE
Weight with packaging	8.67 kg (19.11 lb)
Weight with stand assembly and cables	6.32 kg (13.93 lb)
Weight without stand assembly (For wall mount or VESA mount considerations - no cables)	4.36 kg (9.61 lb)
Weight of stand assembly	1.65 kg (3.64 lb)
Weight	P2725HE WOST
Weight with packaging	7.02 kg (15.48 lb)
Weight without stand assembly and with cables	4.67 kg (10.30 lb)
Weight without stand assembly (For wall mount or VESA mount considerations - no cables)	4.36 kg (9.61 lb)



Environmental characteristics

Model	P2425HE/P2425HE WOST/P2425E/ P2725HE/P2725HE WOST
Compliant standards	
<ul style="list-style-type: none"> ENERGY STAR certified monitor EPEAT registered where applicable. EPEAT registration varies by country. See www.epeat.net for registration status by country. RoHS-compliant TCO Certified & TCO Certified Edge BFR/PVC free monitor (excluding external cables) Arsenic-free glass and Mercury-free for the panel only 	
Temperature	
Operating	0°C to 40°C (32°F to 104°F)
Non-operating	<ul style="list-style-type: none"> Storage: -20°C to 60°C (-4°F to 140°F) Shipping: -20°C to 60°C (-4°F to 140°F)
Humidity	
Operating	10% to 80% (non-condensing)
Non-operating	<ul style="list-style-type: none"> Storage: 5% to 90% (non-condensing) Shipping: 5% to 90% (non-condensing)
Altitude	
Operating	5000 m (16404 ft) (maximum)
Non-operating	12192 m (40000 ft) (maximum)
Thermal dissipation	
P2425HE/P2425HE WOST	<ul style="list-style-type: none"> 614.2 BTU/Hour (Maximum) 47.4 BTU/Hour (On mode)
P2425E	<ul style="list-style-type: none"> 648.3 BTU/Hour (Maximum) 51.2 BTU/Hour (On mode)
P2725HE/P2725HE WOST	<ul style="list-style-type: none"> 614.2 BTU/Hour (Maximum) 55.3 BTU/Hour (On mode)



Pin assignments

DisplayPort connector (in)

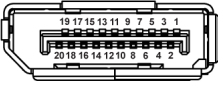

Pin number	20-pin side of the connected signal cable
1	ML3 (n)
2	GND
3	ML3 (p)
4	ML2 (n)
5	GND
6	ML2 (p)
7	ML1 (n)
8	GND
9	ML1 (p)
10	ML0 (n)
11	GND
12	ML0 (p)
13	GND
14	GND
15	AUX (p)
16	GND
17	AUX (n)
18	Hot Plug Detect
19	Re-PWR
20	+3.3 V DP_PWR



DisplayPort connector (out)

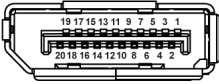

Pin number	20-pin side of the connected signal cable
1	ML0 (p)
2	GND
3	ML0 (n)
4	ML1 (p)
5	GND
6	ML1 (n)
7	ML2 (p)
8	GND
9	ML2 (n)
10	ML3 (p)
11	GND
12	ML3 (n)
13	CONFIG1
14	CONFIG2
15	AUX CH (p)
16	GND
17	AUX CH (n)
18	Hot Plug Detect
19	Return
20	DP_PWR



HDMI connector

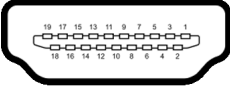

Pin number	19-pin side of the connected signal cable
1	TMDS DATA 2+
2	TMDS DATA 2 SHIELD
3	TMDS DATA 2-
4	TMDS DATA 1+
5	TMDS DATA 1 SHIELD
6	TMDS DATA 1-
7	TMDS DATA 0+
8	TMDS DATA 0 SHIELD
9	TMDS DATA 0-
10	TMDS CLOCK+
11	TMDS CLOCK SHIELD
12	TMDS CLOCK-
13	CEC
14	Reserved (N.C. on device)
15	DDC CLOCK (SCL)
16	DDC DATA (SDA)
17	DDC/CEC Ground
18	+5 V POWER
19	HOT PLUG DETECT



Universal Serial Bus (USB) interface

This section gives you information about the USB ports that are available on the monitor.

Super speed USB 5 Gbps (USB 3.2 Gen1)

Transfer speed	Data rate	Maximum power supported
Super speed	5 Gbps	4.5 W
High speed	480 Mbps	4.5 W
Full speed	12 Mbps	4.5 W

 **NOTE: This monitor is super speed USB 5 Gbps (USB 3.2 Gen1) compatible.**

USB Type-C

USB Type-C	Description
Video	DisplayPort 1.4*
Data	Super speed USB 5 Gbps (USB 3.2 Gen1)
Power Delivery (PD)	Up to 90 W

*HBR3 is supported.



USB 3.2 downstream connector

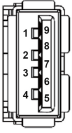

(Rear)

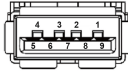

(Bottom)

Pin number	Signal name	Pin number	Signal name
1	VBUS	6	StdA_SSRX+
2	D-	7	GND_DRAIN
3	D+	8	StdA_SSTX-
4	GND	9	StdA_SSTX+
5	StdA_SSRX-	Shell	Shield

USB Type-C connector

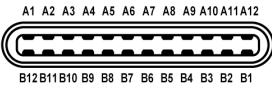



Pin number	Signal name	Pin number	Signal name
A1	GND	B1	GND
A2	TX1+	B2	TX2+
A3	TX1-	B3	TX2-
A4	VBUS	B4	VBUS
A5	CC1	B5	CC2
A6	D+	B6	D+
A7	D-	B7	D-
A8	SBU1	B8	SBU2
A9	VBUS	B9	VBUS
A10	RX2-	B10	RX1-
A11	RX2+	B11	RX1+
A12	GND	B12	GND



USB ports

- 1 super speed USB 5 Gbps (USB 3.2 Gen1) Type-C upstream - rear
- 3 super speed USB 5 Gbps (USB 3.2 Gen1) Type-A downstream - rear (2) and bottom (1)
- 1 super speed USB 5 Gbps (USB 3.2 Gen1) Type-C downstream - bottom

 **NOTE: Super speed USB 5 Gbps (USB 3.2 Gen1) functionality requires a super speed USB 5 Gbps (USB 3.2 Gen1)-capable computer.**

 **NOTE: The USB ports on the monitor work only when the monitor is turned on or in Standby mode. If you turn Off the monitor and then turn it on, the attached peripherals may take a few seconds to resume normal functionality.**

Video bandwidth

Host	Video cable	USB-C prioritization	Color depth	Resolution
USB-C (Alt Mode DP1.4)	USB-C Gen2 cable	High Data Speed	8 Bits	P2425HE/P2425HE WOST/P2725HE/P2725HE WOST: 1920 x 1080 @ 100 Hz P2425E: 1920 x 1200 @ 100 Hz
		High Resolution	8 Bits	
HDMI 1.4	HDMI cable	N/A	8 Bits	
DP 1.2	DP cable	N/A	8 Bits	
DP 1.4	DP cable	N/A	8 Bits	

 **NOTE: Color depth and resolution may change depending on the behavior of host.**



USB speed bandwidth

Host	USB upstream cable	USB-C prioritization	USB device connected to USB-A or C downstream
USB-C (Alt Mode DP1.2)	USB-C Gen2 cable	High Data Speed	Supported, USB 2.0/3.2 Gen1
		High Resolution	Supported, USB 2.0
USB-C (Alt Mode DP1.4)	USB-C Gen2 cable	High Data Speed	Supported, USB 2.0/3.2 Gen1
		High Resolution	Supported, USB 2.0
USB-A 2.0	USB A - C cable	N/A	Supported, USB 2.0
USB-A 3.2 Gen1	USB A - C cable	N/A	Supported, USB 2.0/3.2 Gen1
USB-C 3.2 Gen1 (Data only)	USB-C Gen2 cable	N/A	Supported, USB 2.0/3.2 Gen1
USB-C 3.2 Gen2 (Data only)	USB-C Gen2 cable	N/A	Supported, USB 2.0/3.2 Gen1



RJ45 connector

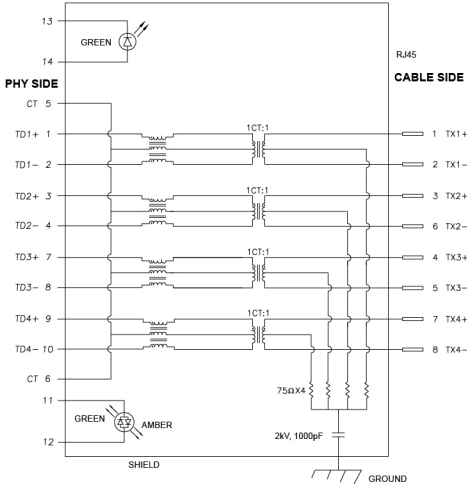

Pin number	Signal	
1	MDI0+	
2	MDI0-	
3	MDI1+	
4	MDI1-	
5	CT	
6	CT	
7	MDI2+	
8	MDI2-	
9	MDI3+	
10	MDI3-	
Pin number	Amber	Green
11	-	+
12	+	-
13	N/A	+
14	N/A	-



Driver installation

Install the Realtek USB GBE Ethernet Controller Driver available for your system. This is available for download at www.dell.com/support under the “Driver and download” section.

Network (RJ45) data rate through USB-C max speed is 1000 Mbps.

Wake-on-LAN behavior

Computer power save state	System behavior after receiving Wake-on-Lan (WOL) command
Modern Standby (S0ix)	Computer and monitor remain in Standby mode but the network communication is enabled.
Standby/Sleep (S3)	Both the computer and monitor are turned ON.
Hibernate (S4)	Both the computer and monitor are turned ON.
OFF/Shutdown (S5)	Both the computer and monitor are turned ON.

 **NOTE: The computer BIOS must be configured to enable WOL function.**

 **NOTE: This LAN port is 1000Base-T IEEE 802.3az compliant, supporting Mac Address (Printed on model label) Pass-thru (MAPT), Wake-on-LAN (WOL) from standby mode (S3) and UEFI* PXE Boot function [UEFI PXE Boot is not supported on Dell Desktop PC's (except for OptiPlex 7090/3090 Ultra Desktop)], these 3 features depend on BIOS settings and version of the OS. Functionality may vary with non-Dell PC's.**

*UEFI stands for Unified Extensible Firmware Interface.

 **NOTE: WOL S4 and WOL S5 are capable only with Dell Systems that support DPBS and are with USB-C (MFDP) interface connection.**

 **NOTE: Any issue related to WOL, users should debug the computer without the monitor. After the problem is solved, then connect to the Monitor.**



RJ45 connector LED status



Label	LED color	Description
1	Green	Link/Activity indicator: <ul style="list-style-type: none">• Blinking - Activity on the port.• Green On - Link is being established.• Off - Link is not established.
2	Amber or Green	Speed indicator: <ul style="list-style-type: none">• Amber On - 1000 Mbps• Green On - 100 Mbps• Off - 10 Mbps

 **NOTE: The RJ45 cable is non in-box standard accessory.**

Plug and play capability

You can connect the monitor to any Plug and Play-compatible system. The monitor automatically provides the computer with its Extended Display Identification Data (EDID) using Display Data Channel (DDC) protocols so that the computer can configure itself and optimize the monitor settings. Most monitor installations are automatic; you can select different settings as required. For more information about changing the monitor settings, see [Operating the monitor](#).



LCD monitor quality and pixel policy

During the LCD Monitor manufacturing process, it is not uncommon for one or more pixels to become fixed in an unchanging state which are hard to see and do not affect the display quality or usability. For more information on Dell Monitor Quality and Pixel Policy, see www.dell.com/pixelguidelines.

Ergonomics

 **CAUTION: Improper or prolonged usage of keyboard may result in injury.**

 **CAUTION: Viewing the monitor screen for extended periods of time may result in eye strain.**

For comfort and efficiency, observe the following guidelines when setting up and using your computer workstation:

- Position your computer so that the monitor and keyboard are directly in front of you as you work. Special shelves are commercially available to help you correctly position your keyboard.
- To reduce the risk of eye strain and neck, arm, back, or shoulder pain from using the monitor for long period, we recommend you to:
 1. Set the distance of the screen between 20 to 28 in. (50 - 70 cm) from your eyes.
 2. Blink frequently to moisten your eyes or wet your eyes with water after prolonged usage of the monitor.
 3. Take regular and frequent breaks for 20 minutes every two hours.
 4. Look away from your monitor and gaze at a distant object that is 20 feet away for at least 20 seconds during the breaks.
 5. Perform stretches to relieve tension in the neck, arm, back, and shoulders during the breaks.
- Ensure that the monitor screen is at eye level or slightly lower when you are sitting in front of the monitor.
- Adjust the tilt of the monitor, its contrast, and brightness settings.
- Adjust the ambient lighting around you (such as overhead lights, desk lamps, and the curtains or blinds on nearby windows) to minimize reflections and glare on the monitor screen.
- Use a chair that provides good lower-back support.
- Keep your forearms horizontal with your wrists in a neutral, comfortable position while using the keyboard or mouse.



- Always leave space to rest your hands while using the keyboard or mouse.
- Let your upper arms rest naturally on both sides.
- Ensure that your feet are resting flat on the floor.
- When sitting, make sure that the weight of your legs is on your feet and not on the front portion of your seat. Adjust your chair's height or use a footrest if necessary, to maintain a proper posture.
- Vary your work activities. Try to organize your work so that you do not have to sit and work for extended periods of time. Try to stand or get up and walk around at regular intervals.
- Keep the area under your desk clear of obstructions and cables or power cords that may interfere with comfortable seating or present a potential trip hazard.

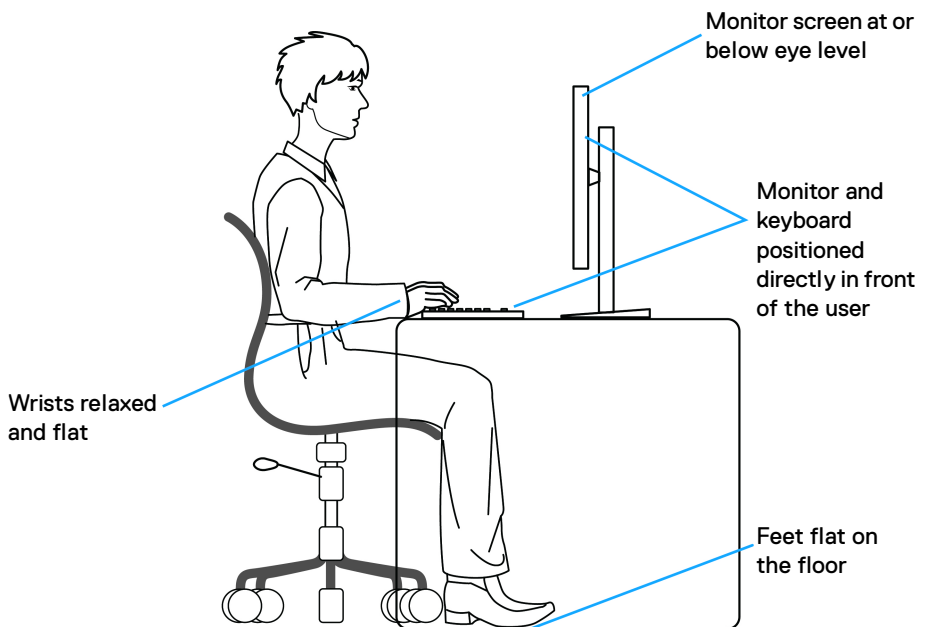

Handling and moving your display

To ensure that the monitor is handled safely when lifting or moving it, follow these guidelines:

- Before moving or lifting the monitor, turn off your computer and the monitor.
- Disconnect all cables from the monitor.
- Place the monitor in the original box with the original packing materials.
- Hold the bottom edge and the side of the monitor firmly without applying excessive pressure when lifting or moving the monitor.

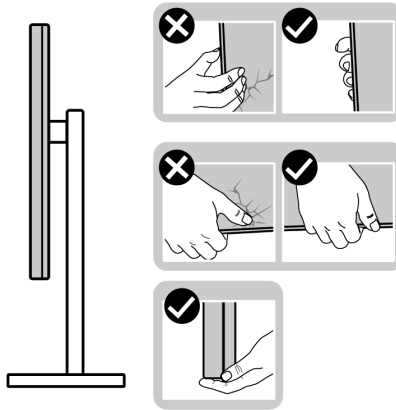

- When lifting or moving the monitor, ensure the screen is facing away from you and do not press on the display area to avoid any scratches or damage.

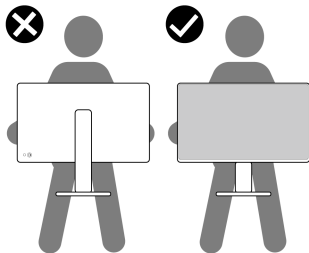

- When transporting the monitor, avoid any sudden shock or vibration to it.



- When lifting or moving the monitor, do not turn the monitor upside down while holding the stand base or stand riser. This may result in accidental damage to the monitor or cause personal injury.

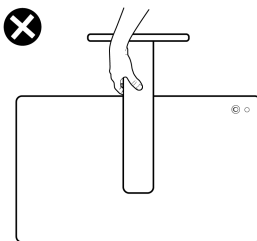

Maintenance guidelines

Cleaning your monitor

△ **CAUTION:** Read and follow the [Safety instructions](#) before cleaning the monitor.

△ **WARNING:** Before cleaning the monitor, unplug the monitor power cable from the electrical outlet.

For best practices, follow the instructions in the list below when unpacking, cleaning, or handling your monitor:

- Use a clean cloth that is slightly dampened with water to clean the stand assembly, the screen, and the chassis of your Dell monitor. If available, use a screen-cleaning tissue or solution suitable for cleaning Dell monitors.
- After cleaning the surface of the table, ensure that it is thoroughly dry and free from any moisture or cleaning agent before placing your Dell monitor on it.

△ **CAUTION:** Do not use detergents or other chemicals such as benzene, thinner, ammonia, abrasive cleaners, alcohol, or compressed air.

△ **CAUTION:** Using chemicals for cleaning may cause changes in the appearance of the monitor, such as color fading, milky film on the monitor, deformation, uneven dark shade, and peeling of screen area.

△ **WARNING:** Do not spray the cleaning solution or even water directly on the surface of the monitor. Doing so will allow liquids to accumulate at the bottom of the display panel and corrode the electronics resulting in permanent damage. Instead, apply the cleaning solution or water to a soft cloth and then clean the monitor.





 **NOTE: Monitor damage due to improper cleaning methods and the use of benzene, thinner, ammonia, abrasive cleaners, alcohol, compressed air, detergent of any kind will lead to a Customer Induced Damage (CID). CID is not covered under the standard Dell warranty.**

- If you notice white residual powder when you unpack your monitor, wipe it off with a cloth.
- Handle your monitor with care as a darker-colored monitor may get scratched and show white scuff marks more than a lighter-colored monitor.
- To help maintain the best image quality on your monitor, use a dynamically changing screen saver and turn off your monitor when not in use.



Setting up the monitor

Attaching the stand

-  **NOTE:** The stand assembly is not pre-installed when the monitor is shipped from the factory.
-  **NOTE:** The following instructions are applicable only for the stand that was shipped with your monitor. If you are attaching a stand that you purchased from any other source, follow the setup instructions that were included with the stand.

To attach the monitor stand:

1. Remove the stand riser and stand base from the packaging cushion.

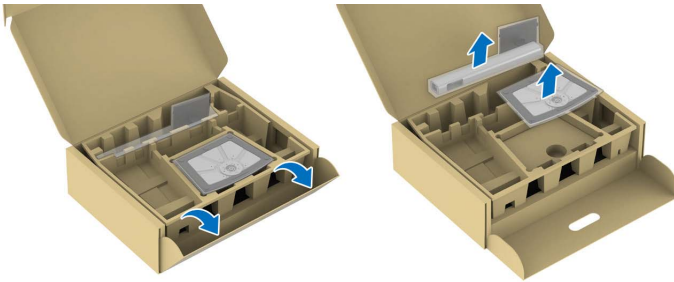

-  **NOTE:** The images are for the purpose of illustration only. The placement and appearance of the package cushion may vary by model.

2. Insert the stand base blocks fully into the stand slot.
3. Lift the screw handle and turn the screw clockwise.



4. After fully tightening the screw, fold the screw handle flat within the recess.

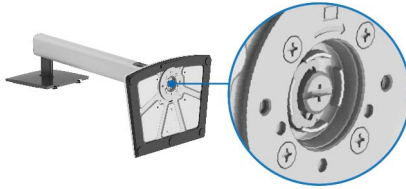

5. Lift the protective cover, as shown, to access the VESA area for stand assembly.



NOTE: Before attaching the stand assembly to the display, ensure that the front plate flap is fully opened, as shown below, to allow space for assembly.

6. Attach the stand assembly to the display.

- Fit the two tabs on the upper part of the stand to the groove on the back of the display.
- Press the stand down till it snaps into place.



7. Hold the stand riser and lift the monitor carefully, then place it on a flat surface.



NOTE: Lift the monitor carefully to prevent it from slipping or falling.

8. Remove the protective cover from the monitor.

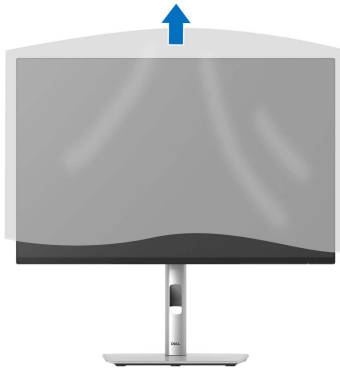

Connecting your monitor

⚠ WARNING: Before you begin any of the procedures in this section, follow the [Safety instructions](#).

🔪 NOTE: Dell monitors are designed to work optimally with the Dell-supplied cables inside the box. Dell does not guarantee the video quality and performance if non-Dell cables are used.

🔪 NOTE: Route the cables through the cable-management slot before connecting them.

🔪 NOTE: Do not connect all the cables to the computer at the same time.

🔪 NOTE: The images are for the purpose of illustration only. The appearance of the computer may vary.

To connect your monitor to the computer:

1. Turn off your computer and disconnect the power cable.
2. Connect the DisplayPort or HDMI cable, and the USB Type-C cable from your monitor to the computer.

⚠ CAUTION: To avoid bending the connectors of USB Type-C cable, gently hold both sides of the connector, and then vertically insert it into/pull it out from the USB Type-C port of the monitor.

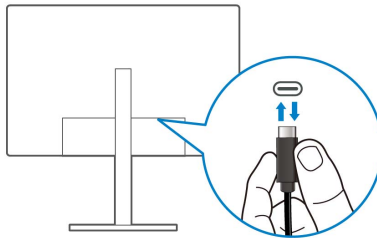

3. Connect the USB peripherals to the USB 3.2 Gen1 downstream ports on the monitor.
4. Plug the power cables for your computer and monitor into a nearby outlet.
5. Turn on the monitor and the computer.

If your monitor displays an image, installation is complete. If it does not display an image, see [Common problems](#).



Connecting the DisplayPort (DP to DP) cable

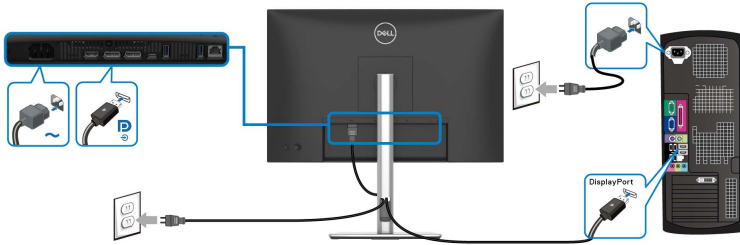

Connecting the USB-C to USB-C cable

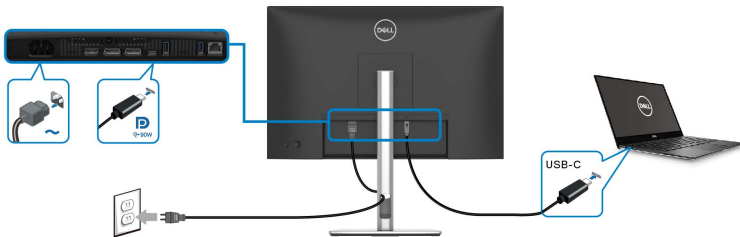

NOTE: Use the USB-C to USB-C cable shipped with your monitor only.

- This port supports DisplayPort Alternate Mode (DP1.4 standard only).
- The USB Type-C power delivery compliant port (PD Version 3.0) delivers up to 90 W of power.
- If your notebook requires more than 90 W to operate and the battery is drained, it may not be powered up or charged with the USB PD port of this monitor.

Connecting the HDMI cable (optional)

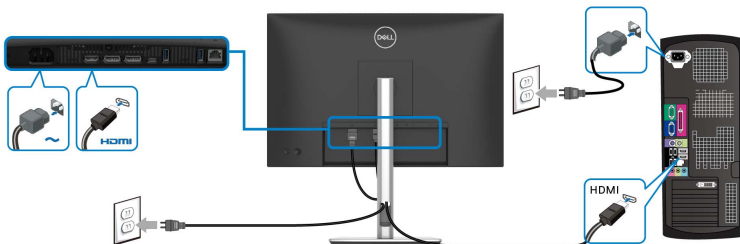

Connecting the monitor for DP Multi-Stream Transport (MST) function

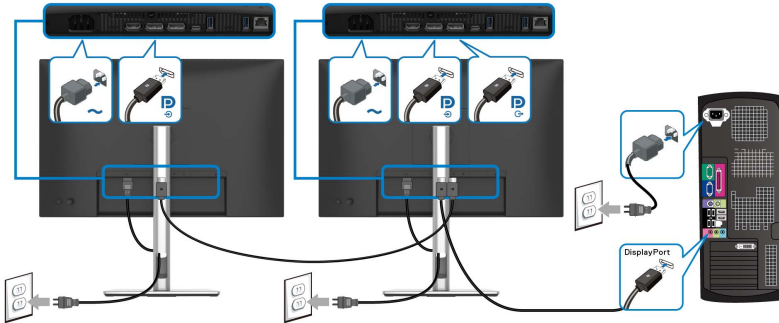

- NOTE: This monitor supports the DP MST feature. To make use of this feature, your PC graphics card must be certified to DP1.4 with MST option.
- NOTE: Remove the rubber plug when using the DP out downstream port.

Connecting the monitor for USB-C Multi-Stream Transport (MST) function

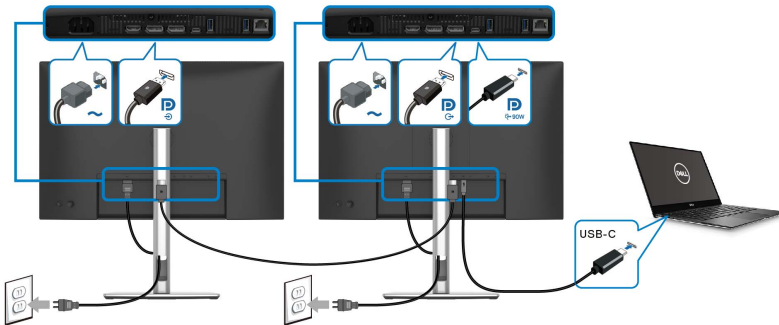

- NOTE: The maximum number of supported monitors through MST is subjected to the bandwidth of the USB-C source.
- NOTE: Remove the rubber plug when using the DP out downstream port.



Connecting the monitor for RJ45 cable (optional)

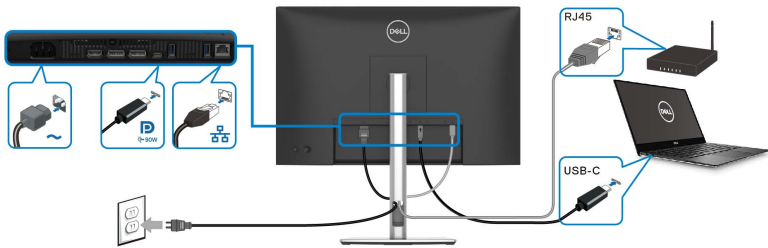

NOTE: The RJ45 cable is not an in-box standard accessory.

Dell Power Button Sync (DPBS)

Your monitor is designed with Dell Power Button Sync (DPBS) feature to allow you to control PC system power state from the monitor power button. This feature is only supported with Dell platform which has built-in DPBS function, and is only supported over USB-C interface.

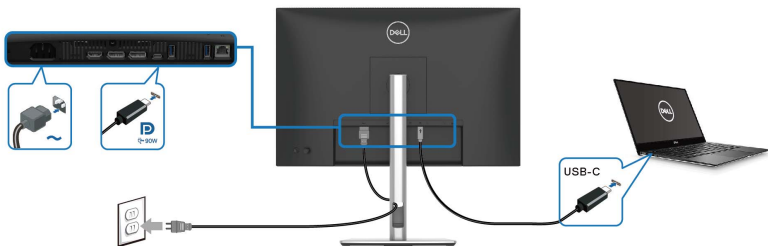

To make sure the DPBS function works for the first time, perform the following steps on the DPBS supported platform in the **Control Panel** first.

NOTE: DPBS only supports the USB Type-C upstream port with  icon.



1. Go to **Control Panel**.

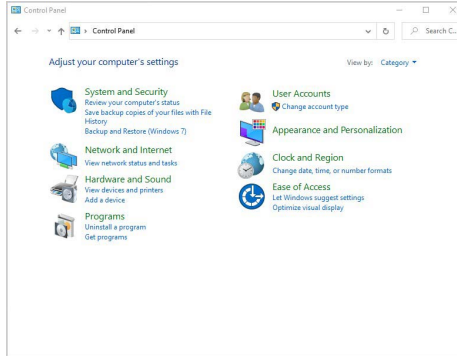

2. Select **Hardware and Sound**, followed by **Power Options**.

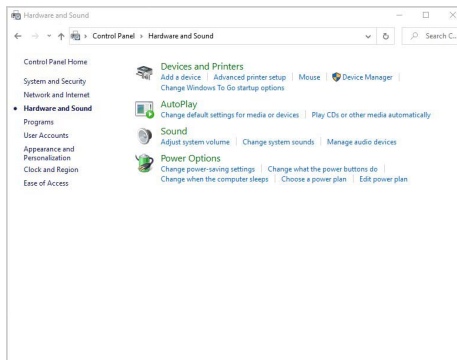

3. Go to **System Settings**.

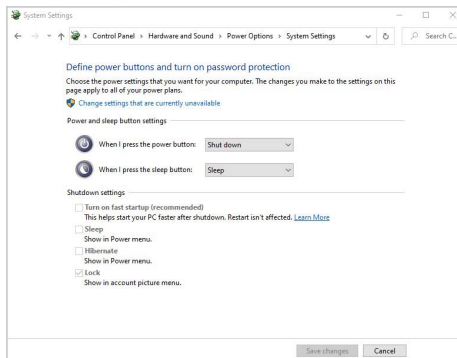

4. In the drop-down menu of **When I press the power button**, there are a few options for selection, namely **Do nothing/Sleep/Hibernate/Shut down**. You can select **Sleep/Hibernate/Shut down**.

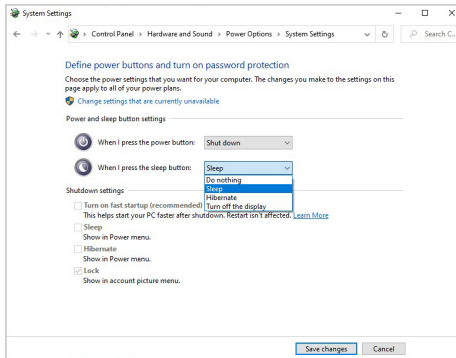
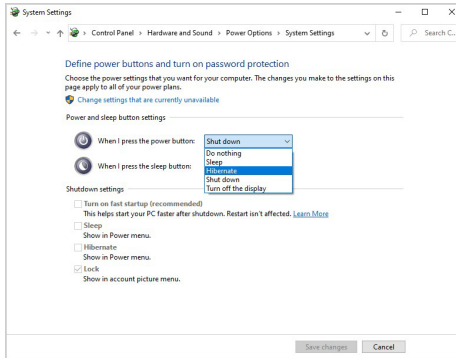

 **NOTE: Do not select “Do nothing”, otherwise the monitor power button will not be able to sync with PC system power state.**



Connecting the monitor for DPBS for the first time

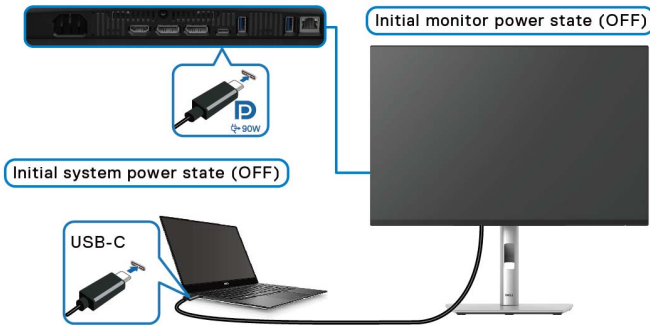

For the first time setting up the DPBS function:

1. Make sure both the PC and the monitor are OFF.
2. Press the monitor power button to turn ON the monitor.
3. Connect the USB-C cable (shipped with your monitor) from the PC to the monitor.
4. Both the monitor and PC will turn ON normally. If not, press the power button either on the monitor or the PC to boot up the system.

NOTE: Ensure that **Dell Power Button Sync** is set to **On**. See [Dell Power Button Sync](#).



Using DPBS function

Waking on the USB-C cable

When you connect the USB-C cable, the Monitor/PC state is as follows:

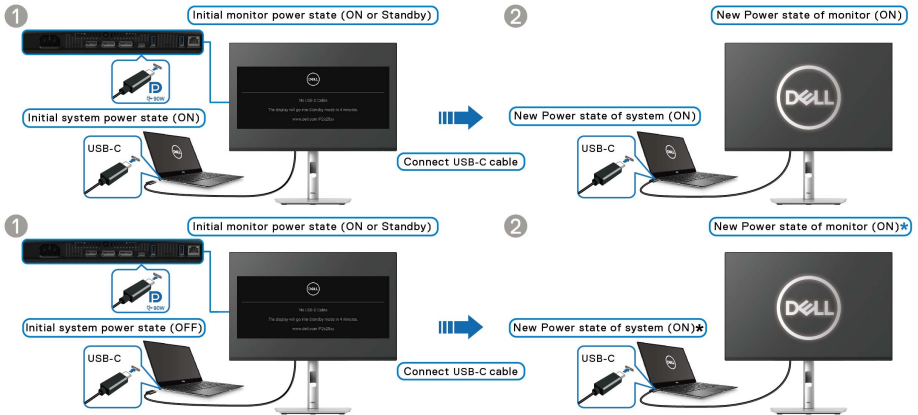

***Not all Dell PC systems support to wake up the platform through the monitor.**

***Upon USB-C cable connection, mouse movement or keyboard press might be required to wake the system/monitor up from sleep or hibernate.**

When you press the power button on the monitor or the PC, the Monitor/PC state is as follows:

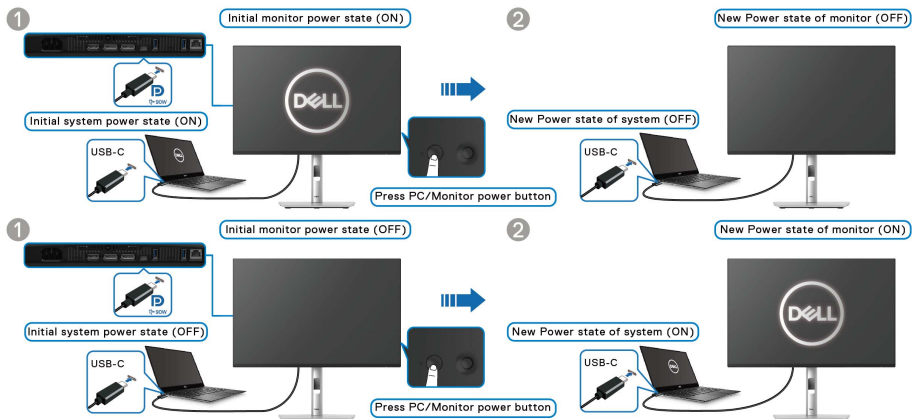

NOTE: You can enable or disable the **Dell Power Button Sync** function using the OSD.

- When the monitor and the PC power state are both ON, **press and hold the power button on the monitor for 4 seconds**, the screen prompt will ask if you would like to shut down the PC.

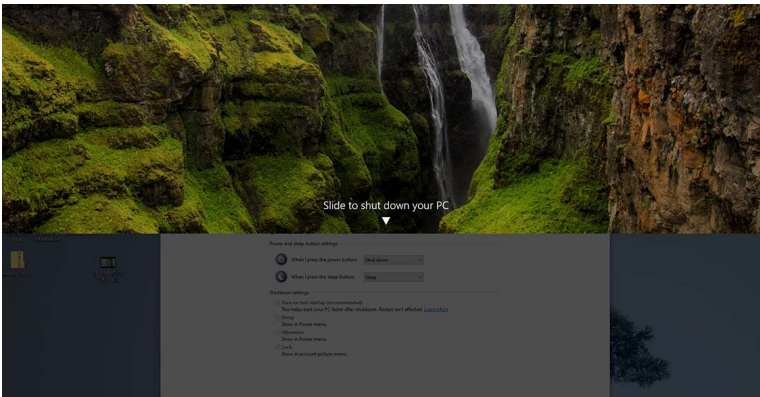
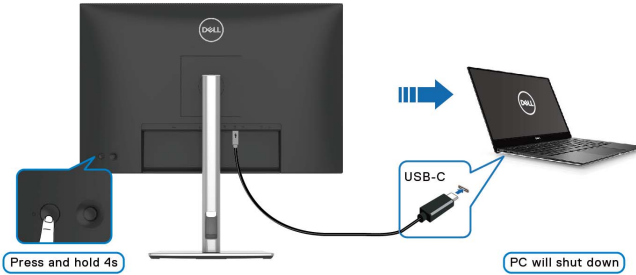

- When it is necessary to force shut down the system, **press and hold the power button on the monitor for 10 seconds**.

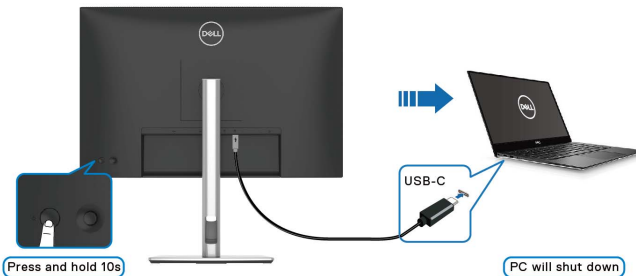

Connecting the monitor for USB-C Multi-Stream Transport (MST) function

A PC is connected to two monitors in an initially OFF power state, and the PC system power state is in sync with the power button on Monitor 1. When you press the power button on Monitor 1 or PC, both Monitor 1 and PC are turned ON. Meanwhile, Monitor 2 will remain OFF. To turn ON Monitor 2, you have to manually press the power button on it.

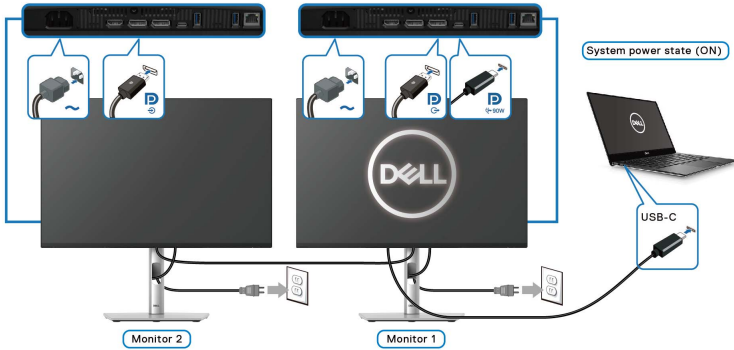

Similarly, a PC is connected to two monitors in an initially ON power state, and the PC system power state is in sync with the power button on Monitor 1. When you press the power button on Monitor 1 or PC, both Monitor 1 and PC are turned OFF. Meanwhile, Monitor 2 will be in Standby mode. To turn OFF Monitor 2, you have to manually press the power button on it.

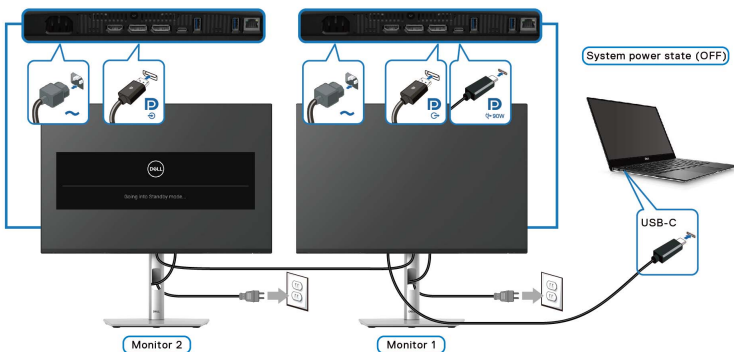

Connecting the monitor for USB-C

If the Dell PC* has more than two USB-C ports, the power state of each connected monitor will sync with the PC.

For example, when the PC and two monitors are in an initial ON power state, pressing the power button on Monitor 1 or Monitor 2 will turn OFF the PC, Monitor 1, and Monitor 2.

*Ensure to check the Dell PC for DPBS support.

NOTE: DPBS only supports the USB Type-C upstream port with  icon.

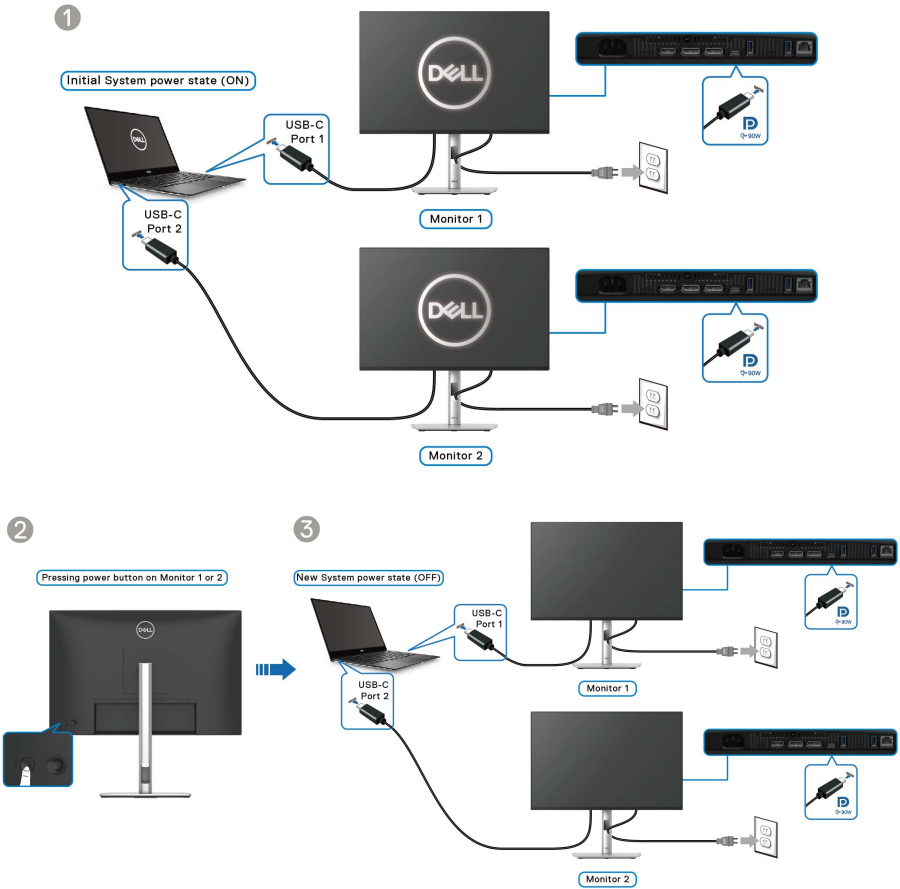

Ensure that **Dell Power Button Sync** is set to **On** (see [Dell Power Button Sync](#)). When the PC and two monitors are in an initial OFF power state, pressing the power button on Monitor 1 or Monitor 2 will turn ON the PC, Monitor 1, and Monitor 2.

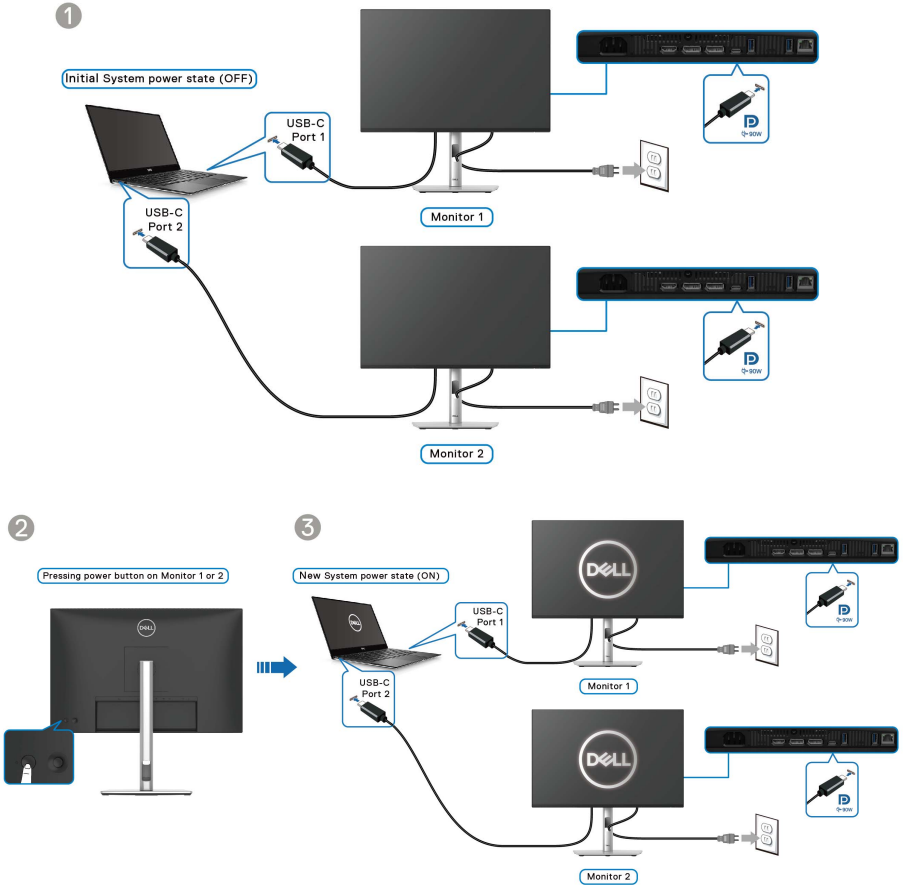

Organizing your cables



When connecting the necessary cables (see [Connecting your monitor](#) for cable attachment), organize all cables as shown above.

Securing your monitor using Kensington lock (optional)

The security-lock slot is located at the bottom of the monitor (see [Security-lock slot](#)). Secure your monitor to a table using the Kensington security lock.

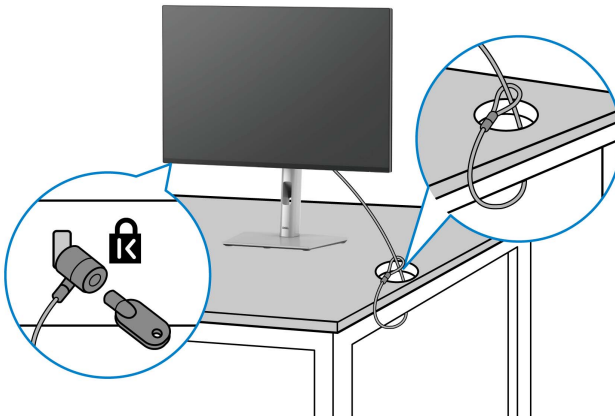

For more information on using the Kensington lock (sold separately), see the documentation that is shipped with the lock.



NOTE: The image is for the purpose of illustration only. The appearance of the lock may vary.



Removing the monitor stand

-  **NOTE:** To prevent scratches on the LCD screen when removing the stand, ensure that the monitor is placed on a soft surface and handle it carefully.
-  **NOTE:** The following steps are specifically for removing the stand that is shipped with your monitor. If you are removing a stand that you purchased from any other source, follow the setup instructions that are included with the stand.

To remove the stand:

1. Place the monitor on a soft cloth or cushion.
2. Press and hold the stand release button at the back of the display.
3. Lift the stand assembly up and away from the monitor.

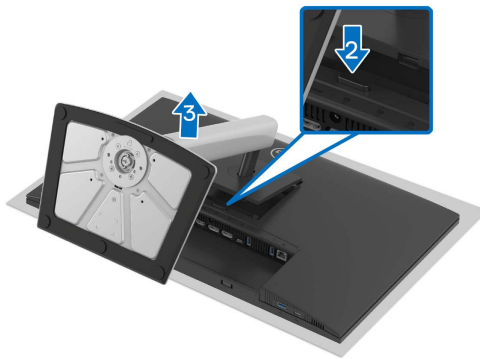

VESA wall mounting (optional)

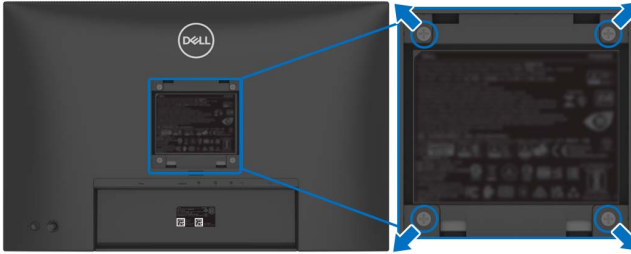

(Screw dimension: M4x10 mm).

Refer to the instructions that come with the VESA-compatible wall mounting kit.

1. Place the monitor panel on a soft cloth or cushion on a stable flat table.
2. Remove the stand (see [Removing the monitor stand](#)).
3. Use a Phillips crosshead screwdriver to remove the four screws securing the plastic cover.
4. Attach the mounting bracket from the wall mounting kit to the monitor.
5. Mount the monitor on the wall. For more information, see the documentation that is shipped with the wall mounting kit.

 **NOTE: For use only with UL or CSA or GS-listed wall mount bracket with minimum weight or load bearing capacity of 14.76 kg (P2425HE/P2425HE WOST)/14.04 kg (P2425E)/17.44 kg (P2725HE/P2725HE WOST).**



Operating the monitor

Turn on the monitor

Press the power button to turn on the monitor.

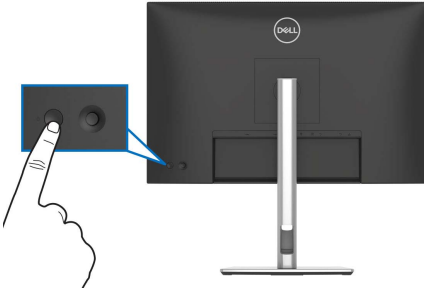

Using the joystick control

Use the joystick control on the rear of the monitor to make On-Screen Display (OSD) adjustments.

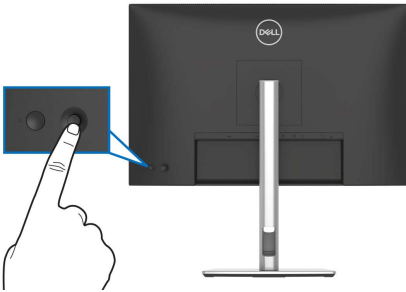

1. Press the joystick to launch the Menu Launcher.
2. Move the joystick up or down or left or right to toggle through options.
3. Press the joystick again to confirm the selection.

Joystick

Description



- When there is no OSD on the screen, press the joystick to launch the Menu Launcher. See [Accessing the Menu Launcher](#).
- When the OSD is displayed, press the joystick to confirm the selection or save the settings.





- For 2-way (right and left) directional navigation.
- Move right to enter the submenu.
- Move left to the upper-level menu or exit from the current menu.

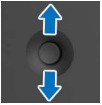

- For 2-way (up and down) directional navigation.
- Toggles between the menu items.
- Increases (up) or decreases (down) the parameters of selected menu item.

Using the On-Screen Display (OSD) menu

Accessing the Menu Launcher

When you toggle or press the joystick, the Menu Launcher appears to let you access the OSD main menu and shortcut functions,

To select a function, move the joystick.

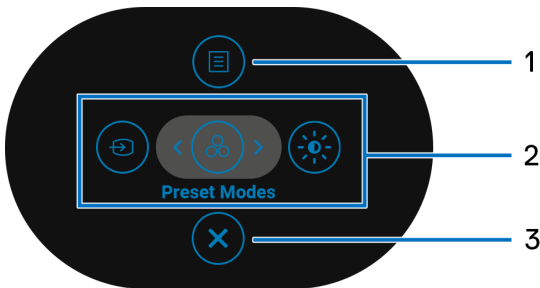

The following table describes the Menu Launcher functions:

Label	Icon	Description
1		To launch the On-Screen Display (OSD) main menu. See Accessing the menu system .
	Menu	



2



Shortcut functions

When you move the joystick to the left or right to toggle through the shortcut functions, the selected item will be highlighted and shifted to the center position. Press the joystick to enter its submenu.

- **Input Source:** To choose an input source from the listed video signals.
- **Preset Modes:** To choose a preferred color mode from the list of preset modes.
- **Brightness/Contrast:** To access the adjustment sliders of brightness and contrast.

NOTE: You can set your preferred shortcut keys. For more information, see [Personalize](#).

NOTE: After you change the settings, follow the navigation keys to confirm the changes before proceeding to another function or exiting.

3





Exit

To exit the Menu Launcher.

Using the navigation keys

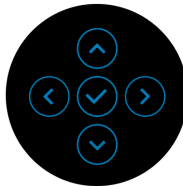
When the OSD main menu is active, move the joystick to configure the settings, following the navigation keys displayed below the OSD.



 **NOTE:** To exit the current menu item and return to the previous menu, move the joystick to the left until you exit.



Accessing the menu system

 **NOTE:** After you change the settings, press the joystick to save the changes before exiting or proceeding to another menu.

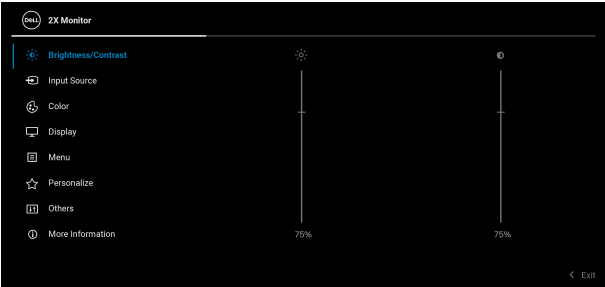
Icon	Menu and submenu	Description
	Brightness/Contrast	Adjusts the brightness and the contrast of the display. 
	Brightness	Brightness adjusts the luminance of the backlight. Move the joystick up or down to increase or decrease the brightness level (min. 0/max. 100).
	Contrast	Adjust the Brightness first, and then adjust the Contrast only if further adjustment is necessary. The Contrast function adjusts the degree of difference between darkness and lightness on the monitor screen. Move the joystick up or down to increase or decrease the contrast level (min. 0/max. 100).





Input Source

Select between the different video signals that may be connected to your monitor.

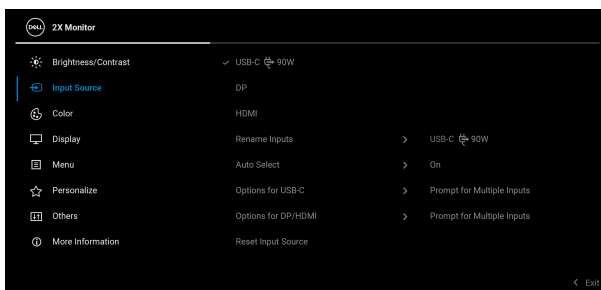

USB-C 90W

Select **USB-C 90W** when you are using the USB Type-C upstream port. Press the joystick to confirm the selection.

DP

Select **DP** when you are using the DisplayPort (DP) connector. Press the joystick to confirm the selection.

HDMI

Select **HDMI** when you are using the HDMI connector. Press the joystick to confirm the selection.

Rename Inputs

Allows you to specify a preset input name for the selected input source. The preset options are **PC**, **PC 1**, **PC 2**, **Laptop**, **Laptop 1**, and **Laptop 2**. The default setting is **Off**.

NOTE: When you perform a rename for the **USB-C (90W)** input, the wattage value remains after the specified option, e.g., **PC 1 (90W)**.

NOTE: It is not applicable for the input names shown in the warning messages and **Display Info**.

Auto Select

Automatically scans for available input sources. The default is **On**. Press the joystick to confirm the selection.



Options for USB-C

Allows you to set this function to:

- **Prompt for Multiple Inputs:** Always displays the “**Switch to USB-C Video Input**” message for you to choose whether to switch or not.
- **Always Switch:** Automatically switches to USB-C video input (without prompting) when the USB Type-C cable is connected.
- **Off:** Never automatically switches to USB-C video input when the USB Type-C cable is connected.

Press the joystick to confirm the selection.

NOTE: This function is not available when **Auto Select** is set to **Off**.

Options for DP/HDMI

Allows you to set this function to:

- **Prompt for Multiple Inputs:** Always displays the “**Switch to DP/HDMI Video Input**” message for you to choose whether to switch or not.
- **Always Switch:** Automatically switches to DP/HDMI video input (without prompting) when the DisplayPort or HDMI cable is connected.
- **Off:** Never automatically switches to DP/HDMI video input when the DisplayPort or HDMI cable is connected.

Press the joystick to confirm the selection.

NOTE: This function is not available when **Auto Select** is set to **Off**.

Reset Input Source

Resets your monitor input settings to the default settings.





Color

Adjusts the color setting mode.

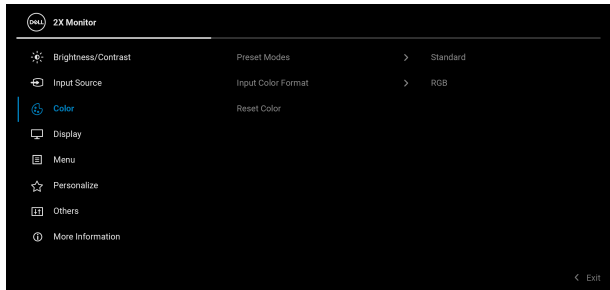

Preset Modes

Allows you to choose from the list of preset color modes. Press the joystick to confirm the selection.

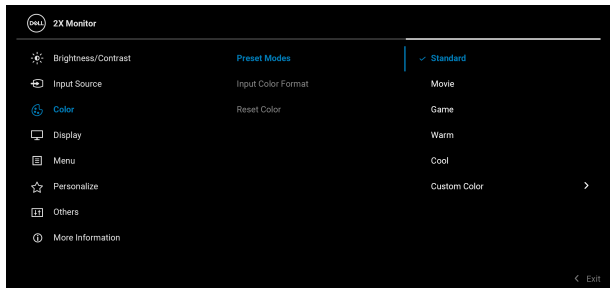

- **Standard:** This is the default setting. Using a low blue light panel, this monitor is certified by TÜV to reduce blue light output and create more relaxing and less stimulating images.
- **Movie:** Loads color settings ideal for movies.
- **Game:** Loads color settings ideal for most gaming applications.
- **Warm:** Presents colors at lower color temperatures. The screen appears warmer with a red/yellow tint.



Preset Modes

- **Cool:** Presents colors at higher color temperatures. The screen appears cooler with a blue tint.
- **Custom Color:** Allows you to manually adjust the color settings (R/G/B) and create your own preset color mode.

Input Color Format

Allows you to set the video input mode to:

- **RGB:** Select this option if your monitor is connected to a computer or a media player that supports RGB output.
- **YCbCr:** Select this option if your media player supports only YCbCr output.

Press the joystick to confirm the selection.

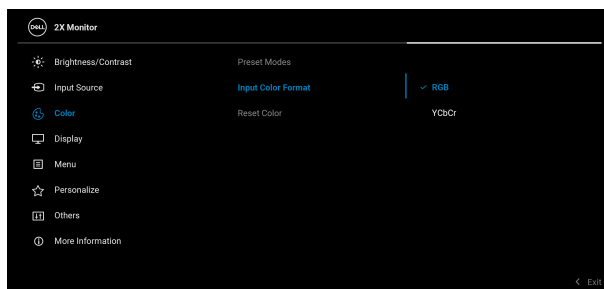

Hue

This function can shift the color of the video image to green or purple. This is used to adjust the desired flesh tone color. Move the joystick to adjust the hue level from '0' to '100'.

NOTE: The function is available only when you select **Movie** or **Game** preset mode.

Saturation

This function can adjust the color saturation of the video image. Move the joystick to adjust the saturation level from '0' to '100'.

NOTE: The function is available only when you select **Movie** or **Game** preset mode.

Reset Color

Resets the color settings to the default settings.





Display

Use **Display** to adjust the images.

P2425HE/P2425HE WOST/P2725HE/P2725HE WOST

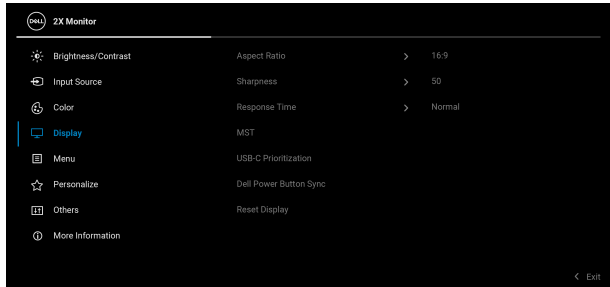

P2425E

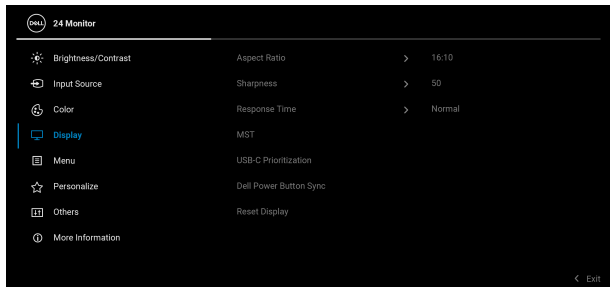

Aspect Ratio Adjusts the image ratio to **16:9** (P2425HE/P2425HE WOST/P2725HE/P2725HE WOST), **16:10** (P2425E), **4:3**, or **5:4**.

Sharpness This function can make the image look sharper or softer. Move the joystick to adjust the sharpness level from '0' to '100'.

Response Time Allows you to set the response time to **Normal** or **Fast**.



MST

DisplayPort Multi Stream Transport. The default setting is **Off**. To enable **MST** (DP out), select **On**.

NOTE: When the DisplayPort/USB Type-C cable and the DP downstream cable are connected, the OSD sets **MST** to **On** automatically. This action will only be done once after **Factory Reset** or **Reset Display** is selected.

USB-C Prioritization

Allows you to specify the priority to transfer the data with high resolution (**High Resolution**) or high speed (**High Data Speed**) when using the USB Type-C devices. If the current platform is DP 1.4 (HBR3), use **High Data Speed** to access full video performance with high data speed. If the current platform is DP 1.2 (HBR2) or below, select **High Resolution** for accessing full video performance with data and network speed drop.

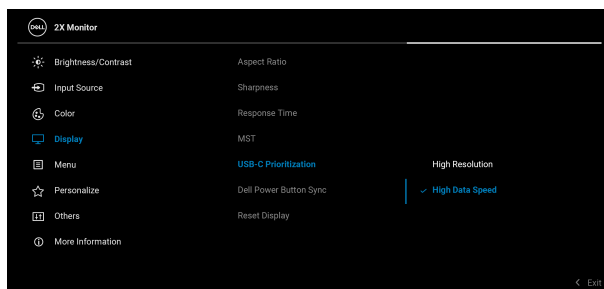

Dell Power Button Sync

Allows you to control PC system power state from the monitor power button.

NOTE: When **Off** is selected, the Wake-on-Connect function remains active. When USB-C connection is detected, the computer will be turned on.

NOTE: This function is only supported with Dell platform which has built-in DPBS function, and is only supported over USB-C interface.

Reset Display

Resets all display settings to the factory preset values.





Menu

Adjusts the settings of the OSD, such as the languages of the OSD, the amount of time the menu remains on screen, and so on.

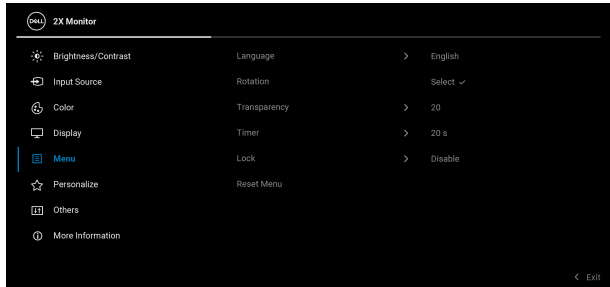

Language

Sets the OSD display to one of the eight languages (English, Spanish, French, German, Brazilian Portuguese, Russian, Simplified Chinese, or Japanese).

Rotation

Press the joystick to rotate the OSD by 0/90/270 degrees.

You can adjust the menu according to your display rotation.

Transparency

Select to change the menu transparency by moving the joystick (min. 0/max. 100).

Timer

Sets the length of time for the OSD to remain active after your last operation with the joystick.

Move the joystick to adjust the slider in 1 second increments, from 5 to 60 seconds.



Lock

With the control buttons on the monitor is locked, you can prevent others from accessing the controls.

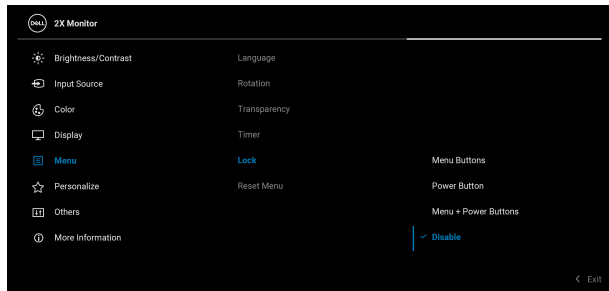

- **Menu Buttons:** All joystick functions are locked and not accessible by the user.
- **Power Button:** Only the Power button is locked and not accessible by the user.
- **Menu + Power Buttons:** Both the joystick & Power button are locked and not accessible by the user.

The default setting is **Disable**.

Alternative Lock Method: You can move and hold the joystick up or down or left or right for 4 seconds to set the lock options using the pop-up menu, and then press the joystick to confirm the configuration.

NOTE: To unlock, move and hold the joystick up or down or left or right for 4 seconds, and then press the joystick to confirm the changes and close the pop-up menu.

Reset Menu

Resets all OSD settings to the factory preset values.





Personalize

P2425HE/P2425HE WOST/P2425E

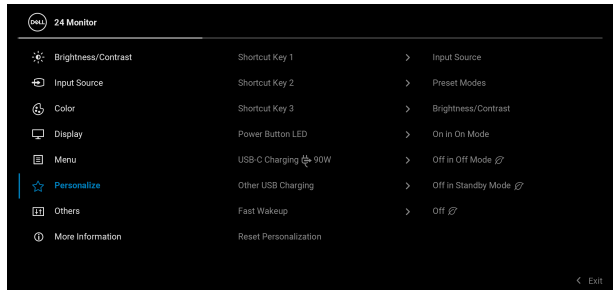

P2725HE/P2725HE WOST

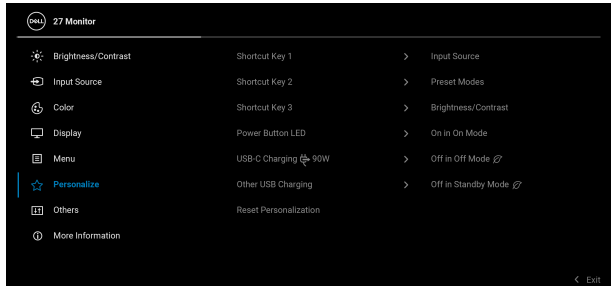

Shortcut Key 1

Shortcut Key 2

Shortcut Key 3

Power Button LED

Select a function from **Preset Modes, Brightness/Contrast, Input Source, Aspect Ratio, Rotation,** or **Display Info** and set it as a shortcut key.

Allows you to set the state of the power light to save energy.



**USB-C
Charging ⚡
90W**

Allows you to enable or disable the **USB-C Charging ⚡ 90W** function during monitor off mode. If **On in Off Mode** is selected, you will be able to charge your notebook or mobile devices through the USB Type-C cable even when the monitor is powered Off.

NOTE: The function is not selectable and will be defaulted to **On in Off Mode** if Monitor is connected to Dell Latitude and Precision notebooks that support Dell Power Button Sync through USB Type-C. Under this configuration, the monitor USB-C charging function is always available during Off Mode.

**Other USB
Charging**

Allows you to enable or disable USB Type-A and USB Type-C Downstream Ports charging function during monitor standby mode.

When this function is enabled, you will be able to charge your mobile devices through the USB-A cable even when the monitor is in powered off.

NOTE: This function is available when the USB Type-C cable is unplugged from the upstream port. If the USB Type-C cable is connected, **Other USB Charging** follows the USB host power status and the function is not accessible.

Fast Wakeup

Speeds up recovery time from standby mode (only for **P2425HE/P2425HE WOST/P2425E**).

**Reset
Personalization**

Resets all settings under the **Personalize** menu to the factory preset values.





Others

Adjusts the OSD settings, such as **DDC/CI**, **LCD Conditioning**, **Self-Diagnostic**, and so on.

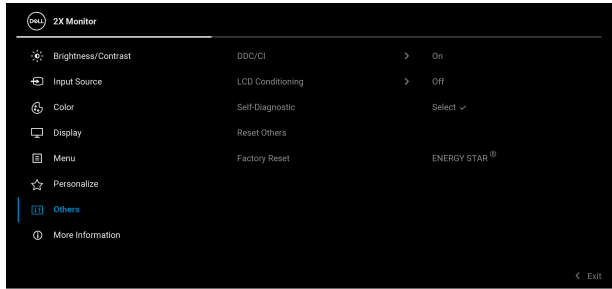

DDC/CI

DDC/CI (Display Data Channel/Command Interface) allows you to adjust the monitor settings using software on your computer. Enable this function for the best user experience and optimum performance of your monitor. You can disable this function by selecting **Off**.

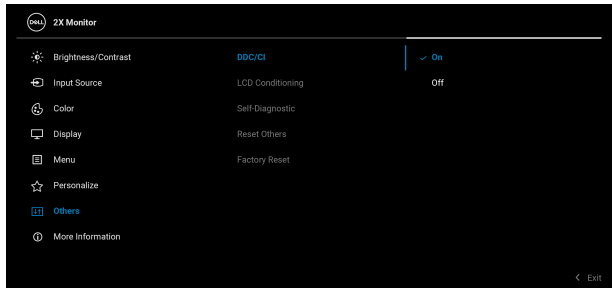

LCD Conditioning

Helps reduce minor cases of image retention. Depending on the degree of image retention, the program may take some time to run. You can enable this function by selecting **On**.

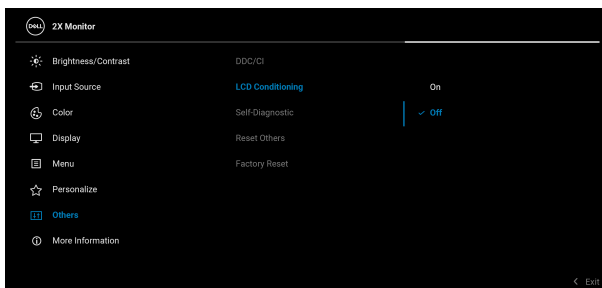

Self-Diagnostic

Select this function to run the built-in diagnostics, see [Built-in diagnostics](#).

Reset Others

Resets all settings under the **Others** menu to the factory preset values.

Factory Reset

Restore all preset values to the factory default settings. These are also the settings for ENERGY STAR® tests.

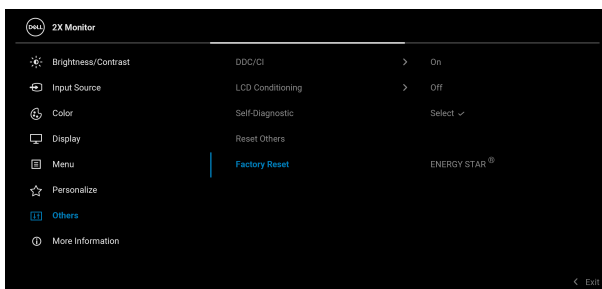



More Information

Use the menu to view the monitor's information or seek more monitor support.



Display Info

Select to display the current settings, firmware version, and service tag of your monitor.

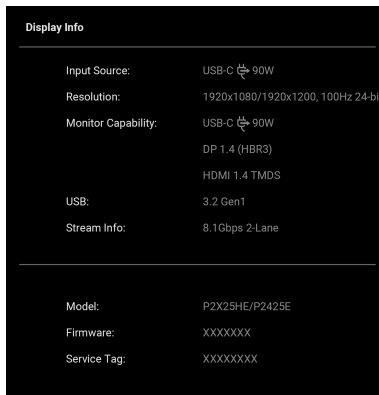

NOTE: The image shown above is for the purpose of illustration only. The information may vary depending on the model and current settings.

Dell Monitor Support

To access the general monitor support materials for your monitor, use your smartphone to scan the QR code.



OSD messages

Initial Setup

When **Factory Reset** is selected, the following message appears:

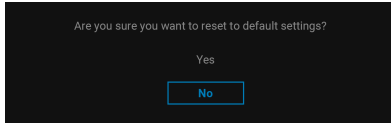

If you select **Yes** to reset to default settings, the following message appears:

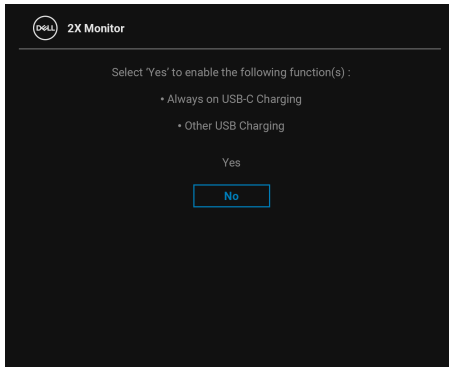

OSD warning message

When the monitor does not support a particular resolution mode, you will see the following message:

P2425HE/P2425HE WOST/P2725HE/P2725HE WOST

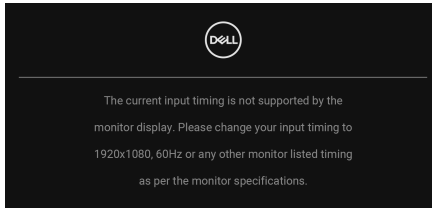

P2425E

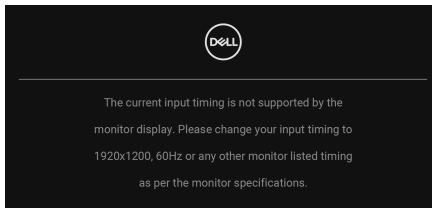

This means that the monitor cannot synchronize with the signal that it is receiving from the computer. See [Monitor specifications](#) for the Horizontal and Vertical frequency ranges addressable by this monitor. The recommended mode is **1920 x 1080 (P2425HE/P2425HE WOST/P2725HE/P2725HE WOST)/1920 x 1200 (P2425E)**.

When you adjust the **Brightness** level above the default level for the first time, the following message appears:

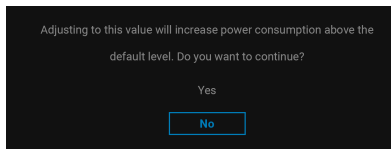

 **NOTE: If you select Yes, the message will not appear the next time you change the Brightness setting.**



You will see the following message before the **Lock** function is activated:

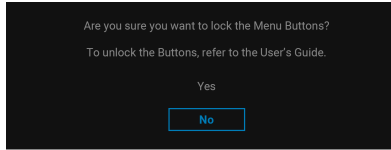

NOTE: The message may be slightly different according to the selected settings.

When you change the default setting of power saving features for the first time, such as **USB-C Charging @ 90W**, **Other USB Charging**, or **Fast Wakeup** (only for **P2425HE/P2425HE WOST/P2425E**), the following message appears:

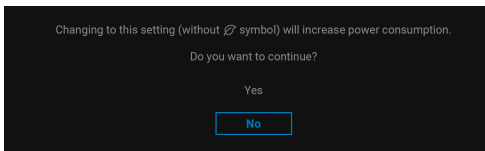

NOTE: If you select **Yes** for either one of the functions mentioned above, the message will not appear the next time you change the settings of these functions. When you perform the factory reset (see **Factory Reset**), the message will appear again.

You will see the following message before the **DDC/CI** function is disabled:

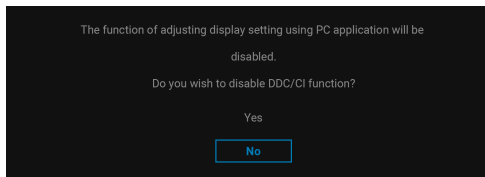

When the monitor goes into Standby mode, the following message appears:

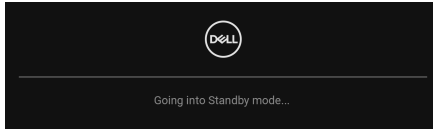

Activate the computer and wake up the monitor to gain access to the [OSD](#).

The OSD functions only in the normal operation mode. If you press the joystick during the Standby mode, the following message will appear depending on the selected input:

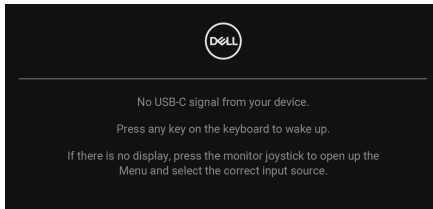

Activate the computer and the monitor to gain access to the [OSD](#).

 **NOTE: The message may be slightly different according to the connected input signal.**

If USB-C, DisplayPort, or HDMI input is selected and the corresponding cable is not connected, the following message will appear:

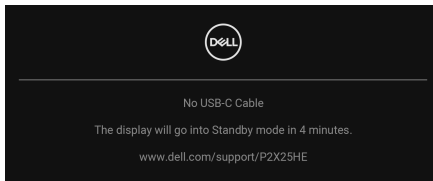

or

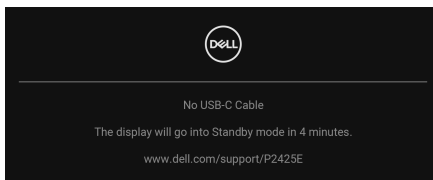

 **NOTE: The message may be slightly different according to the selected input signal.**

See [Troubleshooting](#) for more information.





Locking the control buttons

You can lock the monitor control buttons to prevent access to the OSD menu and/or power button.

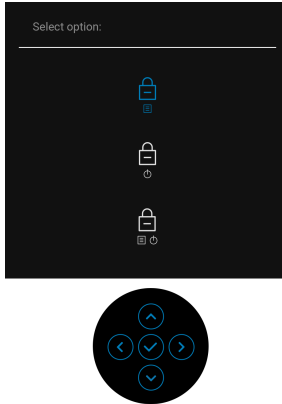
1. Move and hold the joystick up or down or left or right for about 4 seconds until a pop-up menu appears.



2. Move the joystick to select one of the following options:

-  : The OSD menu settings are locked and not accessible.
-  : The power button is locked.
-  : The OSD menu settings are not accessible and the power button is locked.

3. Press the joystick to confirm the configuration.

To unlock, move and hold the joystick up or down or left or right for about 4 seconds until a menu appears, and then select  to unlock and close the pop-up menu.



Setting the maximum resolution

 **NOTE: The steps may vary slightly depending on the version of Windows you have.**

To set the maximum resolution for the monitor:

In Windows 8.1:

1. For Windows 8.1, select the Desktop tile to switch to classic desktop.
2. Right-click on the desktop and click **Screen resolution**.
3. If you have more than one monitor connected, ensure that you select **P2425HE/P2425E/P2725HE**.
4. Click the **Screen Resolution** dropdown list and select **1920 x 1080 (P2425HE/P2425HE WOST/P2725HE/P2725HE WOST)/1920 x 1200 (P2425E)**.
5. Click **OK**.

In Windows 10 and Windows 11:

1. Right-click on the desktop and click **Display settings**.
2. If you have more than one monitor connected, ensure to select **P2425HE/P2425E/P2725HE**.
3. Click the **Display Resolution** dropdown list and select **1920 x 1080 (P2425HE/P2425HE WOST/P2725HE/P2725HE WOST)/1920 x 1200 (P2425E)**.
4. Click **Keep changes**.

If you do not see 1920 x 1080/1920 x 1200 as an option, you must update your graphics driver to the latest version. Depending on your computer, complete one of the following procedures:

If you have a Dell desktop or laptop:

- Go to www.dell.com/support, enter your service tag, and download the latest driver for your graphics card.

If you are using a non-Dell computer (laptop or desktop):

- Go to the support site for your non-Dell computer and download the latest graphic card drivers.
- Go to the graphics card's website and download the latest graphic card drivers.



Using the tilt, swivel, pivot and height adjustment

NOTE: The following instructions are applicable only for attaching the stand that was shipped with your monitor. If you are attaching a stand that you purchased from any other source, follow the setup instructions that were included with the stand.

Tilt and swivel adjustment

With the stand attached to the monitor, you can tilt and swivel the monitor for the most comfortable viewing angle.

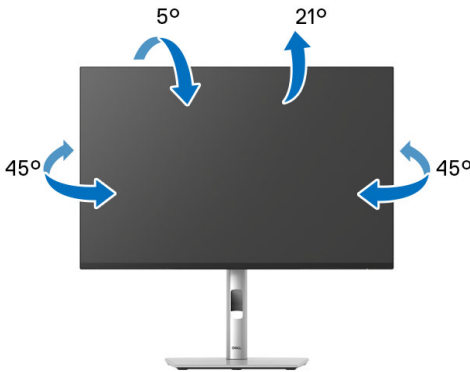

NOTE: The stand assembly is not pre-installed when the monitor is shipped from the factory.

Height adjustment

NOTE: The stand extends vertically up to 150 mm. The following image illustrates how to extend the stand vertically.

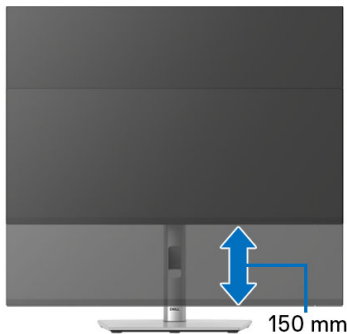

Pivot adjustment

Before you rotate the display, ensure it is completely extended vertically and completely tilted up to avoid hitting the bottom edge of the monitor.

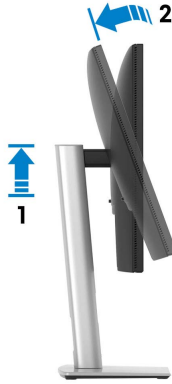

Rotate clockwise



Rotate counterclockwise



- NOTE:** To use the Display Rotation function (Landscape versus Portrait view) with your Dell computer, you require an updated graphics driver that is not included with this monitor. To download the graphics driver, go to www.dell.com/support and see the Download section for Video Drivers for latest driver updates.
- NOTE:** In the Portrait mode, you may experience performance degradation when using graphic-intensive applications such as 3D gaming.



Adjusting the rotation display settings of your system

After you have rotated your monitor, you need to complete the procedure below to adjust the Rotation Display Settings of your system.

 **NOTE: If you are using the monitor with a non-Dell computer, you need to go to the graphics driver website or your computer manufacturer website for information on rotating the 'contents' on your display.**

To adjust the Rotation Display Settings:

1. Right-click on the desktop and click **Properties**.
2. Select the **Settings** tab and click **Advanced**.
3. If you have an AMD graphics card, select the **Rotation** tab and set the preferred rotation.
4. If you have an NVIDIA graphics card, click the **NVIDIA** tab, in the left-hand column select **NVRotate**, and then select the preferred rotation.
5. If you have an Intel graphics card, select the **Intel** graphics tab, click **Graphic Properties**, select the **Rotation** tab, and then set the preferred rotation.

 **NOTE: If you do not see the rotation option or it is not working correctly, go to www.dell.com/support and download the latest driver for your graphics card.**



Troubleshooting

 **WARNING:** Before you begin any of the procedures in this section, follow the [Safety instructions](#).

Self-test

Your monitor provides a self-test feature that allows you to check whether your monitor is functioning properly. If your monitor and computer are properly connected but the monitor screen remains dark, run the monitor self-test by performing the following steps:

1. Turn off both your computer and the monitor.
2. Unplug the video cable from the computer.
3. Turn on the monitor.

If the monitor cannot sense a video signal and is working correctly, the following message will appear:

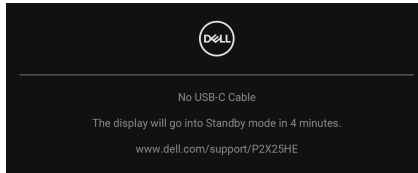

or

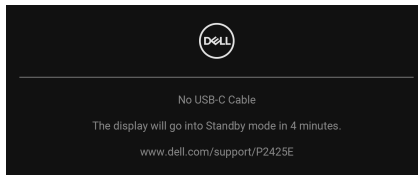

 **NOTE:** The message may be slightly different according to the connected input signal.

 **NOTE:** While in self-test mode, the power LED remains white.

4. This box also appears during normal system operation, if the video cable becomes disconnected or damaged.
5. Turn off your monitor and reconnect the video cable; then turn on both your computer and the monitor.

If your monitor screen remains blank after you use the previous procedure, check your video controller and computer, because your monitor is functioning properly.



Built-in diagnostics

Your monitor has a built-in diagnostic tool that helps you determine if the screen abnormality you are experiencing is an inherent problem with your monitor, or with your computer and video card.

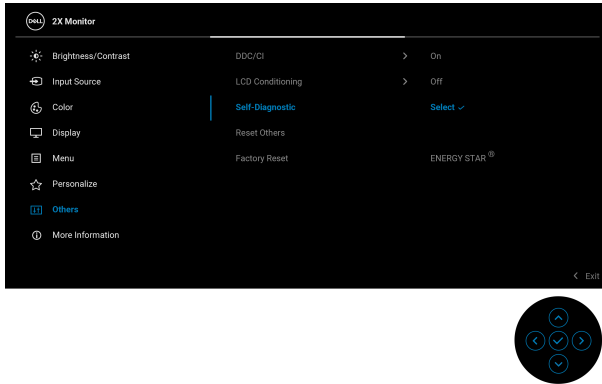

To run the built-in diagnostics:

1. Ensure that the screen is clean (no dust particles on the surface of the screen).
2. Move or press the joystick to launch the Menu Launcher.
3. Move the joystick up to select  and open the Main Menu.
4. Move the joystick to navigate and select **Others** and then **Self-Diagnostic**.
5. Press the joystick to initiate the built-in diagnostics. A gray screen is displayed.
6. Observe if the screen has any defects or abnormalities.
7. Toggle the joystick once again until a red screen is displayed.
8. Observe if the screen has any defects or abnormalities.
9. Repeat steps 7 and 8 until the screen displays green, blue, black, and white colors. Note any abnormalities or defects.

The test is complete when a text screen is displayed. To exit, toggle the joystick control again.

If you do not detect any screen abnormalities upon using the built-in diagnostic tool, the monitor is functioning properly. Check the video card and computer.



Common problems

The following table contains general information about common monitor problems you might encounter and the possible solutions:

Common symptoms	What you experience	Possible solutions
No video/power LED off	No picture	<ul style="list-style-type: none">• Ensure that the video cable connecting the monitor and the computer is properly connected and secure.• Verify that the power outlet is functioning properly using any other electrical equipment.• Ensure that the power button is pressed fully.• Ensure that the correct input source is selected in the Input Source menu.
No video/power LED on	No picture or no brightness	<ul style="list-style-type: none">• Increase brightness and contrast controls using the OSD.• Perform monitor self-test feature check.• Check for bent or broken pins in the video cable connector.• Run the built-in diagnostics. For more information, see Built-in diagnostics.• Ensure that the correct input source is selected in the Input Source menu.
Poor focus	Picture is fuzzy, blurry, or ghosting	<ul style="list-style-type: none">• Eliminate video extension cables.• Reset the monitor to factory settings.• Change the video resolution to the correct aspect ratio.
Shaky/jittery video	Wavy picture or fine movement	<ul style="list-style-type: none">• Reset the monitor to factory settings.• Check environmental factors.• Relocate the monitor and test in another room.



Missing pixels	LCD screen has spots	<ul style="list-style-type: none"> • Cycle power On-Off. • Pixel that is permanently off is a natural defect that can occur in LCD technology. • For more information on Dell Monitor Quality and Pixel Policy, see Dell Support site at: www.dell.com/pixelguidelines.
Stuck-on pixels	LCD screen has bright spots	<ul style="list-style-type: none"> • Cycle power On-Off. • Pixel that is permanently off is a natural defect that can occur in LCD technology. • For more information on Dell Monitor Quality and Pixel Policy, see Dell Support site at: www.dell.com/pixelguidelines.
Brightness problems	Picture too dim or too bright	<ul style="list-style-type: none"> • Reset the monitor to factory settings. • Adjust brightness and contrast controls using the OSD.
Geometric distortion	Screen not centered correctly	Reset the monitor to factory settings.
Horizontal/vertical lines	Screen has one or more lines	<ul style="list-style-type: none"> • Reset the monitor to factory settings. • Perform monitor self-test feature check and determine if these lines are also in self-test mode. • Check for bent or broken pins in the video cable connector. • Run the built-in diagnostics. For more information, see Built-in diagnostics.



Synchronization problems	Screen is scrambled or appears torn	<ul style="list-style-type: none"> Reset the monitor to factory settings. Perform monitor self-test feature check to determine if the scrambled screen appears in self-test mode. Check for bent or broken pins in the video cable connector. Restart the computer in the safe mode.
Safety related issues	Visible signs of smoke or sparks	<ul style="list-style-type: none"> Do not perform any troubleshooting steps. Contact Dell immediately.
Intermittent problems	Monitor malfunctions on and off	<ul style="list-style-type: none"> Ensure that the video cable connecting the monitor to the computer is connected properly and is secure. Reset the monitor to factory settings. Perform monitor self-test feature check to determine if the intermittent problem occurs in self-test mode.
Missing color	Picture missing color	<ul style="list-style-type: none"> Perform monitor self-test feature check. Ensure that the video cable connecting the monitor to the computer is connected properly and is secure. Check for bent or broken pins in the video cable connector.
Wrong color	Picture color not good	<ul style="list-style-type: none"> Change the settings of the Preset Modes in the Color menu OSD depending on the application. Adjust the R/G/B values under Custom Color in the Color menu OSD. Change the Input Color Format to RGB or YCbCr/YPbPr in the Color settings OSD. Run the built-in diagnostics. For more information, see Built-in diagnostics.



Image retention from a static image left on the monitor for a long period of time	Faint shadow from the static image displayed appears on the screen	<ul style="list-style-type: none"> Set the screen to turn off after a few minutes of screen idle time. These can be adjusted in Windows Power Options or Mac Energy Saver setting. Alternatively, use a dynamically changing screensaver.
Video ghosting or overshooting	Video ghosting, shadows or color smear while scrolling	Change the Response Time in the Display menu OSD to Normal or Fast , depending on your application and usage.
Picture quality (Refresh rate of native resolution changes from 60 Hz to 30 Hz; or color depth drops to 18 bits)	Issues of incorrect refresh rate or missing colors	<ul style="list-style-type: none"> Set USB-C Prioritization to High Resolution. Check the resolution settings of your graphic card.



Product specific problems

Specific symptoms	What you experience	Possible solutions
Screen image is too small	Image is centered on screen, but does not fill the entire viewing area	<ul style="list-style-type: none">• Check the Aspect Ratio setting in the Display menu OSD.• Reset the monitor to factory settings.
Cannot adjust the monitor with the joystick	OSD does not appear on the screen	<ul style="list-style-type: none">• Turn off the monitor, unplug the power cord, plug it back, and then turn on the monitor.• Check whether the OSD menu is locked. If yes, move and hold the joystick up/down/left/right for 4 seconds to unlock (see Lock and Locking the control buttons).
No input signal when you press the power button or toggle the joystick	No picture, the LED light is white	<ul style="list-style-type: none">• Check the signal source. Ensure the computer is not in the power saving mode by moving the mouse or pressing any key on the keyboard.• Check whether the signal cable is plugged in properly. Re-plug the signal cable if necessary.• Reset the computer or video player.
The picture does not fill the entire screen	The picture cannot fill the height or width of the screen	<ul style="list-style-type: none">• Due to different video formats (aspect ratio) of DVDs, the monitor may display in full screen.• Run the built-in diagnostics. For more information, see Built-in diagnostics.



No video at HDMI/DisplayPort/USB Type-C port	When connected to some dongle/docking device at the port, there is no video when unplugging/plugging the cable from the notebook	Unplug the HDMI/DisplayPort/USB Type-C cable from dongle/docking device, then plug the docking HDMI/DisplayPort/USB Type-C cable into the notebook.
No network connection	Network dropped or intermittent	<ul style="list-style-type: none"> • Check to ensure USB-C Prioritization is set to High Data Speed. • Do not turn off the display during network connection.
The LAN port is not functioning	OS setting or cable connection issue	<ul style="list-style-type: none"> • Ensure that the latest BIOS and drivers for your computer are installed on your computer. • Ensure that the RealTek Gigabit Ethernet Controller is installed in the Windows Device Manager. • If your BIOS Setup has a LAN/GBE Enabled/Disabled option, make sure it is set to Enabled. • Ensure that the Ethernet cable is connected securely on the monitor and the hub/router/firewall. • Check the status LED of the Ethernet cable to confirm connectivity. Re-connect both ends of the Ethernet cable if the LED is not lit. • First power off the computer and unplug the USB Type-C cable and the power cord from the monitor. Then, power on the computer and plug the power cord and the USB Type-C cable into the monitor.



When a PS console is connected, the monitor is not compatible with the 1080i (interlaced) video timing	A message appears to notify you that the monitor does not support the current input timing.	Change the resolution of the PS console in Safe Mode. For the information about setting up the resolution, go to the official website of PlayStation.
When the first monitor is connected to your PC or laptop using the USB-C connection, you might not be able to select the optimal resolution* for the 3rd (or more) monitor in Daisy chain mode in DP1.4 (DSC Disabled)	When MST is On and USB-C Prioritization is set to High Data Speed , the displayed pictures on the 3rd (or more) daisy chained monitor are not at the optimal resolution*	Switch USB-C Prioritization from High Data Speed to High Resolution (USB speed reduced to 2.0).

*The optimal resolution for **P2425HE/P2425HE WOST/P2725HE/P2725HE WOST** is **1920 x 1080** at 60 Hz; the optimal resolution for **P2425E** is **1920 x 1200** at 60 Hz.



Universal Serial Bus (USB) specific problems

Specific symptoms	What you experience	Possible solutions
USB interface is not working	USB peripherals are not working	<ul style="list-style-type: none">• Check that your monitor is turned On.• Reconnect the upstream cable to your computer.• Reconnect the USB peripherals (downstream connector).• Switch off and then turn on the monitor again.• Reboot the computer.• Some USB devices like external portable HDD require higher electric current; connect the device directly to the computer system.
USB Type-C port does not supply power	USB peripherals can not be charged	<ul style="list-style-type: none">• Check that the connected device is compliant with the USB-C specification. The USB Type-C port (video and data) with  icon supports USB 3.2 Gen1 and an output of 90 W.• Check that you use the USB Type-C cable shipped with your monitor.
Super speed USB 5 Gbps (USB 3.2 Gen1) interface is slow	Super speed USB 5 Gbps (USB 3.2 Gen1) peripherals working slowly or not working at all	<ul style="list-style-type: none">• Check that your computer is super speed USB 5 Gbps (USB 3.2 Gen1)-compatible.• Some computers have USB 3.2, USB 2.0, and USB 1.1 ports. Ensure that the correct USB port is used.• Reconnect the upstream cable to your computer.• Reconnect the USB peripherals (downstream connector).• Reboot the computer.



Wireless USB peripherals stop working when a USB 3.2 device is plugged in	Wireless USB peripherals responding slowly or only working as the distance between itself and its receiver decreases	<ul style="list-style-type: none"> • Increase the distance between the USB 3.2 peripherals and the wireless USB receiver. • Position your wireless USB receiver as close as possible to the wireless USB peripherals. • Use a USB-extender cable to position the wireless USB receiver as far away as possible from the USB 3.2 port.
Wireless USB mouse does not work properly	When plugged into one of the USB ports on the rear side of the monitor, the Wireless USB mouse lags or freezes during use	Unplug the Wireless USB Mouse receiver and re-plug it into one of the Quick Access USB ports at the bottom of the monitor.



Regulatory information

FCC notices (U.S. only) and other regulatory information

For FCC notices and other regulatory information, see the regulatory compliance website located at www.dell.com/regulatory_compliance.

EU product database for energy label and product information sheet

P2425HE: <https://eprel.ec.europa.eu/qr/1865677>

P2425HE WOST: <https://eprel.ec.europa.eu/qr/1865680>

P2425E: <https://eprel.ec.europa.eu/qr/1870769>



P2725HE: <https://eprel.ec.europa.eu/qr/1874340>

P2725HE WOST: <https://eprel.ec.europa.eu/qr/1910290>



Contacting Dell

To contact Dell for sales, technical support, or customer service issues, see www.dell.com/contactdell.

-  **NOTE: Availability varies by country and product, and some services may not be available in your country.**
-  **NOTE: If you do not have an active internet connection, you can find contact information on your purchase invoice, packing slip, bill, or Dell product catalog.**

