

USER MANUAL

ProLite

LCD Monitor

ENGLISH

ProLite XUB2497HSN
ProLite XUB2797HSN
ProLite XUB2797QSN

Thank you very much for choosing the iiyama LCD monitor.

We recommend that you take a few minutes to read this comprehensive manual carefully before installing and switching on the monitor. Please keep this manual in a safe place for your future reference.



Dear user, we congratulate you on the purchase of your iiyama LCD.

For details on warranty and locally used pixel policies that apply directly after installation of your product please check the iiyama website.

To report a fault, please contact your local support centre found at <https://iiyama.com>

Things to check before you call the iiyama information line

- | if the power cable is connected securely and turned on?
- | if the display has been turned on?
- | if the signal cable is connected securely and the correct input selected?
- | if the computer has been restarted with the display connected?
- | if the graphics card is correctly installed with the latest drivers possible?
- | if the correct native resolution has been selected via 'Display Properties'?
- | If the R/G/B signal configuration is correct?
- | if the displays On Screen Menu is shown?
- | if the correct brightness and contrast settings have been set?
- | if given display tolerances and compatibility have been considered?
- | if via the On Screen Menu you have performed a Factory Reset/Recall?

Before reporting the screen defect, please prepare the following information/evidence:

- | model number *
- | purchase receipt and serial number *
- | name and address for collection
- | telephone/fax number, for availability during the day
- | convenient collection date (date, time)
- | short description of the defect

Important Note:

If there is no fault found in the collected equipment after inspection, the transferring party shall incur charges for transport and administration.

If you have checked all of the above and there is still no picture, call our information line for assistance in your country.

Feedback on health and safety issues

If you have any health and safety concerns or questions about the product (including when using the product), please contact iiyama support through our website. You can also contact us by calling +31 204460404. After receiving your feedback, we will ask the responsible unit to handle it as soon as possible and a dedicated person will get back to you. Your feedback will also be recorded and incorporated into our evaluation for improvements

* see the identification plate on the back of the case.

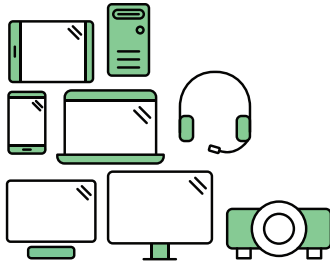

Say hello to a more sustainable product

IT products are associated with a wide range of sustainability risks throughout their life cycle. Human rights violations are common in the factories. Harmful substances are used both in products and their manufacture. Products can often have a short lifespan because of poor ergonomics, low quality and when they are not able to be repaired or upgraded.

This product is a better choice. It meets all the criteria in TCO Certified, the world's most comprehensive sustainability certification for IT products. Thank you for making a responsible product choice, that help drive progress towards a more sustainable future!

Criteria in TCO Certified have a life-cycle perspective and balance environmental and social responsibility. Conformity is verified by independent and approved verifiers that specialize in IT products, social responsibility or other sustainability issues. Verification is done both before and after the certificate is issued, covering the entire validity period. The process also includes ensuring that corrective actions are implemented in all cases of factory non-conformities. And last but not least, to make sure that the certification and independent verification is accurate, both TCO Certified and the verifiers are reviewed regularly.

Want to know more?

Read information about TCO Certified, full criteria documents, news and updates at [tcocertified.com](https://www.tcocertified.com). On the website you'll also find our Product Finder, which presents a complete, searchable listing of certified products.

CE MARKING DECLARATION OF CONFORMITY

This LCD monitor complies with the requirements of the EC/EU Directive 2014/30/EU "EMC Directive", 2014/35/EU "Low Voltage Directive", 2009/125/EC "ErP Directive" and 2011/65/EU "RoHS Directive".

The electro-magnetic susceptibility has been chosen at a level that gives correct operation in residential areas, business and light industrial premises and small-scale enterprises, inside as well as outside of the buildings. All places of operation are characterised by their connection to the public low voltage power supply system.

IİYAMA CORPORATION: Wijkermeerstraat 8, 2131 HA Hoofddorp, The Netherlands

Model No. : PL2497H, PL2797H, PL2797Q



We recommend recycling of used product. Please contact your dealer or iiyama service center. Recycle information is obtained via the Internet, using the address: <https://iiyama.com>

You can access the Web page of different countries from there.

- We reserve the right to change specifications without notice.
- All trademarks used in this user manual are the property of their respective owners.
- The terms HDMI and HDMI High-Definition Multimedia Interface, and the HDMI Logo are trademarks or registered trademarks of HDMI Licensing Administrator, Inc. in the United States and other countries.
- Eprel registration number XUB2497HSN-B1 : 1847573 XUB2497HSN-W1 : 1847582
XUB2797HSN-B1 : 1865679
XUB2797QSN-B1 : 1881083 XUB2797QSN-W1 : 1881133

TABLE OF CONTENTS

FOR YOUR SAFETY.....	1
SAFETY PRECAUTIONS.....	1
SPECIAL NOTES ON LCD MONITORS.....	3
CUSTOMER SERVICE.....	3
CLEANING.....	3
BEFORE YOU OPERATE THE MONITOR.....	4
FEATURES.....	4
CHECKING THE CONTENTS OF THE PACKAGE.....	4
USING ARM OR STAND.....	5
FITTING AND REMOVAL OF STAND.....	7
CONTROLS AND CONNECTORS.....	9
CONNECTING YOUR MONITOR.....	10
DISCONNECTING YOUR MONITOR.....	12
COMPUTER SETTING.....	12
ADJUSTING THE HEIGHT AND THE VIEWING ANGLE.....	12
OPERATING THE MONITOR.....	13
ADJUSTMENT MENU CONTENTS.....	14
STANDBY FEATURE.....	25
TROUBLE SHOOTING.....	26
RECYCLING INFORMATION.....	27
APPENDIX.....	28
SPECIFICATIONS :	
ProLite XUB2497HSN-B1 / ProLite XUB2497HSN-W1.....	28
SPECIFICATIONS : ProLite XUB2797HSN-B1.....	29
SPECIFICATIONS :	
ProLite XUB2797QSN-B1 / ProLite XUB2797QSN-W1.....	30
DIMENSIONS : ProLite XUB2497HSN.....	31
DIMENSIONS : ProLite XUB2797HSN.....	32
DIMENSIONS : ProLite XUB2797QSN.....	32
COMPLIANT TIMING.....	33

FOR YOUR SAFETY

SAFETY PRECAUTIONS

WARNING

STOP OPERATING THE MONITOR WHEN YOU SENSE TROUBLE

If you notice any abnormal phenomena such as smoke, strange sounds or fumes, unplug the monitor and contact your dealer or iiyama service center immediately. Further use may be dangerous and can cause fire or electric shock.

NEVER REMOVE THE CABINET

High voltage circuits are inside the monitor. Removing the cabinet may expose you to the danger of fire or electric shock.

DO NOT PUT ANY OBJECT INTO THE MONITOR

Do not put any solid objects or liquids such as water into the monitor. In case of an accident, unplug your monitor immediately and contact your dealer or iiyama service center. Using the monitor with any object inside may cause fire, electric shock or damage.

INSTALL THE MONITOR ON A FLAT, STABLE SURFACE

The monitor may cause an injury if it falls or is dropped.

DO NOT USE THE MONITOR NEAR WATER

Do not use where water may be splashed or spilt onto the monitor as it may cause fire or electric shock.

OPERATE UNDER THE SPECIFIED POWER SUPPLY

Be sure to operate the monitor only with the specified power supply. Use of an incorrect voltage will cause malfunction and may cause fire or electric shock.

PROTECT THE CABLES

Do not pull or bend the power cable and signal cable. Do not place the monitor or any other heavy objects on the cables. If damaged, the cables may cause fire or electric shock.

ADVERSE WEATHER CONDITIONS

It is advisable not to operate the monitor during a heavy thunder storm as the continual breaks in power may cause malfunction. It is also advised not to touch the plug in these circumstances as it may cause electric shock.

CAUTION

INSTALLATION LOCATION

Do not install the monitor where sudden temperature changes may occur, or in humid, dusty or smoky areas as it may cause fire, electric shock or damage. You should also avoid areas where the sun shines directly on the monitor.

DO NOT PLACE THE MONITOR IN A HAZARDOUS POSITION

The monitor may topple and cause injury if not suitably located. Please also ensure that you do not place any heavy objects on the monitor, and that all cables are routed such that children may not pull the cables and possibly cause injury.

MAINTAIN GOOD VENTILATION

Ventilation slots are provided to keep the monitor from overheating. Covering the slots may cause fire. To allow adequate air circulation, place the monitor at least 10cm (or 4 inches) from any walls.

When removing the tilt stand, the ventilation slots on the back side of the monitor can be blocked. This may overheat the monitor and may cause fire or damage. Make sure to allow enough ventilation when removing the tilt stand. Operating the monitor on its back, side, upside down or on a carpet or any other soft material may also cause damage.

DISCONNECT THE CABLES WHEN YOU MOVE THE MONITOR

When you move the monitor, turn off the power switch, unplug the monitor and be sure the signal cable is disconnected. If you do not disconnect them, it may cause fire or electric shock.

UNPLUG THE MONITOR

If the monitor is not in use for a long period of time it is recommended that it is left unplugged to avoid accidents.

HOLD THE PLUG WHEN DISCONNECTING

To disconnect the power cable or signal cable, always pull it by the plug. Never pull on the cable itself as this may cause fire or electric shock.

DO NOT TOUCH THE PLUG WITH WET HANDS

Pulling or inserting the plug with wet hands may cause electric shock.

WHEN YOU INSTALL THE MONITOR ON YOUR COMPUTER

Be sure the computer is strong enough to hold the weight of the monitor, otherwise, you may damage your computer.

CAREFUL! PROTECT YOUR HANDS AND FINGERS

- Be careful not to hurt your fingers or hands when you change the height or the angle.
- Injury can occur if care is not taken to avoid finger contact with the displays base when adjusting the height.

REMARK FOR 24/7 USAGE

This product is not specifically designed for 24/7 usage in all environments.

REMARK SPECIFIC TO DESKTOP USE

This product is designed for desktop use, not for digital signage (electronic signboard) applications such as ceiling hanging or wall mounting.

OTHERS

ERGONOMIC RECOMMENDATIONS

To eliminate eye fatigue, do not operate the monitor against a bright background or in a dark room. For optimal viewing comfort, the monitor should be just below eye level and 40-60cm (16-24 inches) away from your eyes. When using the monitor over a prolonged time, a ten minute break every hour is recommended as looking at the screen continuously can cause eye strain.

SPECIAL NOTES ON LCD MONITORS

The following symptoms are normal with LCD monitors and do not indicate a problem.

NOTE

- When you first turn on the LCD monitor, the picture may not fit in the display area because of the type of computer that is used. In this case, adjust the picture position to the correct position.
- You may find slightly uneven brightness on the screen depending on the desktop pattern you use.
- Due to the nature of the LCD screen, an afterimage of the previous screen may remain after switching the image, when the same image is displayed for hours. In this case, the screen can be recovered slowly by changing the image or turning off the Power Switch for some hours.

CUSTOMER SERVICE

NOTE

- If you have to return your unit for service and the original packaging has been discarded, please contact your dealer or iiyama service center for advice or replacement packaging.

CLEANING

WARNING

- If you drop any materials or liquids such as water into the monitor when cleaning, unplug the power cable immediately and contact your dealer or iiyama service center.

CAUTION

- For safety reasons, turn off the power switch and unplug the monitor before you clean it.

NOTE

- To protect the LCD panel, do not scratch or rub the screen with a hard object.
- Never use any of the following strong solvents. These will damage the cabinet and the LCD screen.

Thinner	Spray-type cleaner
Benzine	Wax
Abrasive cleaner	Acid or Alkaline solvent

- Touching the cabinet with any product made from rubber or plastic for a long time may cause degeneration or loss of paint on the cabinet.

CABINET

Stains can be removed with a cloth lightly moistened with a mild detergent solvent. Then wipe the cabinet with a soft dry cloth.

LCD SCREEN

Periodic cleaning with a soft dry cloth is recommended.

Don't use tissue paper etc. because these will damage the LCD screen.

BEFORE YOU OPERATE THE MONITOR

FEATURES

- ◆ Supports Resolutions up to 1920 × 1080 2560 × 1440 *ProLite XUB2497HSN / ProLite XUB2797HSN*
ProLite XUB2797QSN
- ◆ High Contrast 1000:1 (Typical) 1300:1 (Typical) *ProLite XUB2797HSN*
ProLite XUB2497HSN / ProLite XUB2797QSN
- ◆ Advanced Contrast Function Available
- ◆ Brightness 250cd/m² (Typical)
- ◆ Moving Picture Response Time 1ms
- ◆ Blue Light Reducer
- ◆ Digital Character Smoothing
- ◆ Automatic Set-up
- ◆ USB Type-C / RJ45 / DP Out - Connectors
- ◆ USB Power Delivery supports up to 65W
- ◆ 2 × 2W Stereo Speakers
- ◆ Ergonomic Design TCO Certified
- ◆ Standby Feature
- ◆ VESA Mounting Standard (100mm×100mm) Compliant
- ◆ Keyhole for Security Lock

CHECKING THE CONTENTS OF THE PACKAGE

The following accessories are included in your package. Check to see if they are enclosed with the monitor. If anything is missing or damaged, please contact your local iiyama dealer or regional iiyama office.

- | | | |
|---------------------------|---------------|------------------------|
| ■ Power Cable *1 | ■ HDMI Cable | ■ DisplayPort Cable *2 |
| ■ USB Type-C Cable (C-C) | ■ VESA Plate | ■ Stand-Neck |
| ■ Stand-Base with a screw | ■ Screwdriver | ■ Safety Guide |
| ■ Quick Start Guide | | |

CAUTION *1 All guarantees and warranties are void for any problems or damage caused by a power cable not supplied by iiyama.

An approved power cable greater or equal to H05VVf, 3G, 0.75mm² must be used.

*2 For **ProLite XUB2797QSN**

USING ARM OR STAND

CAUTION

- This product is designed for desktop use, not for digital signage (electronic signboard) applications such as ceiling hanging or wall mounting.
- Before installation, make sure the display arm or desk arm stand is strong enough to hold the necessary weight of the monitor and the mount.
- Panel angle adjustment range : 23° upward and 5° downward
- This product cannot be used with the monitor screen facing downward/upward.

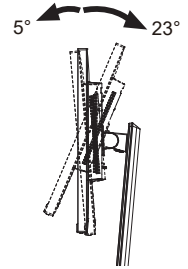

ENGLISH

< DISPLAY ARM OR DESK ARM STAND >

CAUTION

When you use with the display arm or desk arm stand, in consideration of thickness of the mounting stage, tighten the M4 Screws (4pcs) which "L" length is 11mm to fasten the monitor. Using the screw longer than this may cause electric shock or damage because it may contact with the electrical parts inside the monitor.

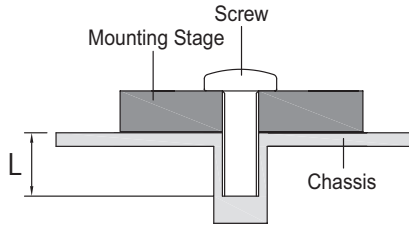

< ROTATING THE MONITOR >

The monitor is designed to be compatible with both landscape and portrait modes. Portrait display must be adjusted using the display settings of the connected device.

ENGLISH

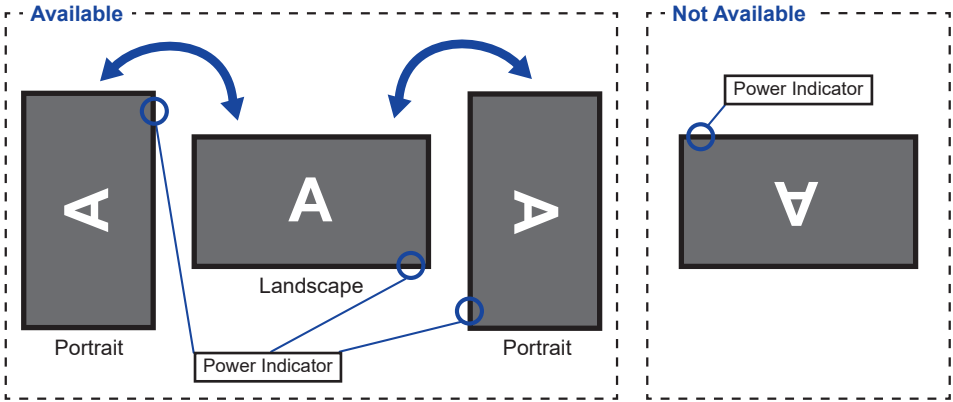

With Stand:

NOTE

- Adjust the monitor's height before panel rotation.
- Attempting to rotate the panel forcibly without adjusting the stand height may cause damage to the panel or the stand.

FITTING AND REMOVAL OF STAND

CAUTION

- Put the monitor on a stable surface. The monitor may cause injury or damage if it falls or is dropped.
- Do not give a strong impact to the monitor. It may cause damage.
- Unplug the monitor before removal or installation to avoid an electric shock or a damage.

<Installation>

- ① Attach the Stand-Neck to the VESA Plate and then tighten the 'thumb screw' with the provided screwdriver to secure them.

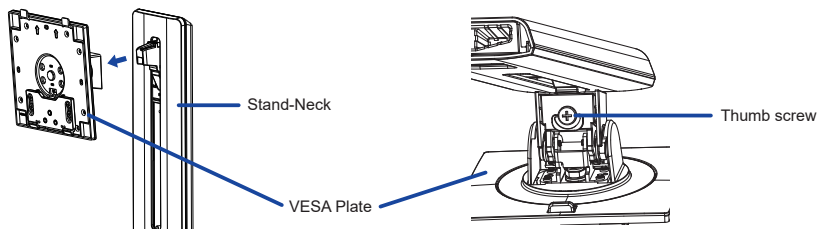

- ② Install the Stand-Neck to the Stand-Base and then tighten the 'thumb screw' to secure them.

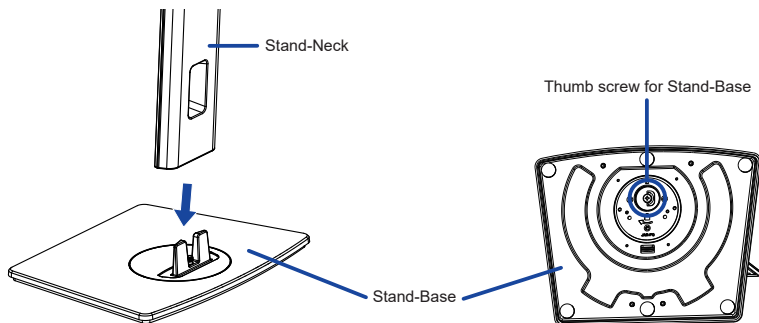

- ③ Put a piece of soft cloth on the table beforehand to prevent the monitor from being scratched. Lay the monitor flat on a table with front face down.
- ④ Hold the monitor and install the assembled stand to the monitor until it clicks to secure.

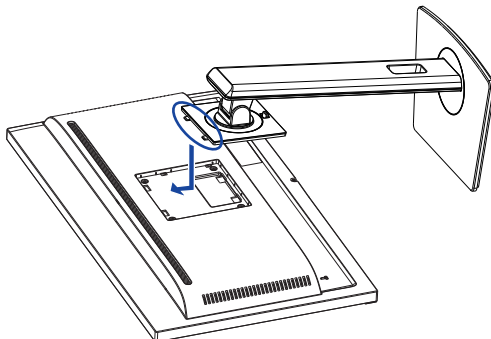

<Removal>

- ① Put a piece of soft cloth on the table beforehand to prevent the monitor from being scratched. Lay the monitor flat on a table with front face down.
- ② Press the release button to remove the stand.

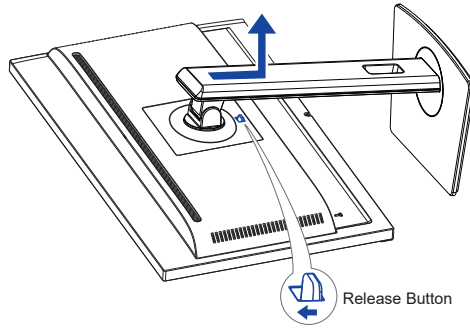



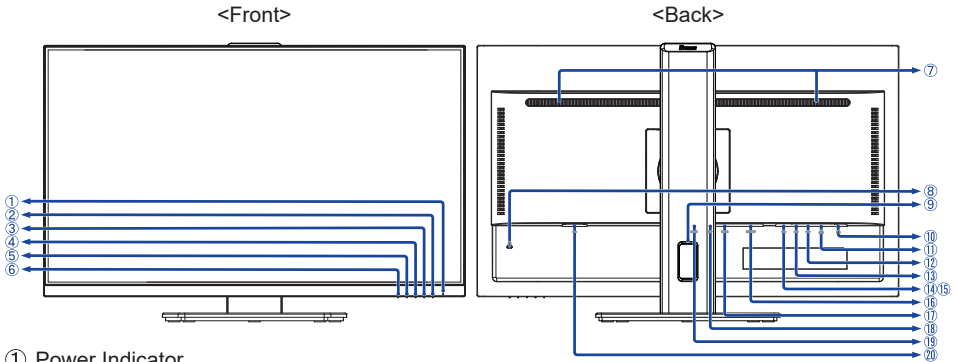

- ③ Loosen the 'thumb screw' with the provided screwdriver to remove the Stand-Neck from the VESA Plate.
- ④ Loosen the 'thumb screw' to remove the Stand-Base from the Stand-Neck.

CONTROLS AND CONNECTORS



- ① Power Indicator

NOTE Blue: Normal operation
Orange: Standby Mode







- ② Power Button ()
 ③ Menu Button (MENU)
 ④ Up / Right / Volume Button ( / )
 ⑤ Down / Left / Shortcut Button ( / ) *¹
 ⑥ Input Select / Exit Button (INPUT / EXIT)
 ⑦ Speakers

- ⑧ Keyhole for Security Lock ()

NOTE You can fasten a security lock and cable to prevent the monitor from being removed without your permission.

- ⑨ Cable Hole
 ⑩ Headphone Connector ()

NOTE Proper operation of connected external devices other than headphones is not guaranteed.

- ⑪ LAN(RJ45) Connector ()
 ⑫ USB Type-C Downstream Connector
 ( USB3.2 Gen 1: 5Gbps, 5V, 1.5A) **ProLite XUB2497HSN / ProLite XUB2797HSN**
 ( USB3.2 Gen 1: 5Gbps, 5V, 3A) **ProLite XUB2797QSN**
 ⑬ USB Type-A Downstream Connector ( USB3.2 Gen 1: 5Gbps, 5V, 900mA)
 ⑭ USB Type-A Downstream Connector ( USB3.2 Gen 1: 5Gbps, 5V, 900mA)
 ⑮ USB Type-A Downstream Connector ( USB3.2 Gen 1: 5Gbps, 5V, 900mA)
 ⑯ DisplayPort Out Connector (DP OUT) *²
 ⑰ USB Type-C Upstream Connector (USB C USB3.2 Gen 1: 5Gbps, 5V/3A, 9V/3A, 10V/3A, 12V/3A, 15V/3A, 20V/3.25A)
 ⑱ DisplayPort Connector (DP)
 ⑲ HDMI Connector (HDMI)
 ⑳ AC Connector (~ : Alternating current)

*¹ Shortcut menu: i-Style Color / Eco / Blue Light Reducer

*² DP OUT Connector has a black rubber cap already attached. Remove the cap before connection.

CONNECTING YOUR MONITOR

- ① Ensure that both the computer and the monitor are switched off.
- ② Connect the computer to the monitor with the signal cable.
- ③ Connect the computer to the monitor with the USB Type-C Cable when viewing images on your monitor through the USB Type-C Connector or when using the monitor's USB hub function.*
- ④ Connect the Power Cable to the monitor first and then to the power source.
- ⑤ Turn on your monitor and computer.

- * ● When charging connected device via USB Type-C Connector, check if the device is equipped with a USB Type-C Connector that supports charging function via USB PD (=Power Delivery).
- The connected device can be charged via USB Type-C Connector even when the monitor is in standby mode. See page 20 for USB Battery Charge (USB BC) function.
 - The USB power delivery is up to 65W. If the connected device required more than 65W for operation or for boot up (when the battery is drained), use the original power adapter that came with the device.
 - If a separately purchased USB Type-C cable is used, make sure the cable is certified by USB-IF and is full-featured with power delivery and video / audio / data transfer functions.
 - If the monitor is in standby mode, it will not display a picture automatically in the following situations:
 1. First boot of the PC
 2. When the PC is resuming from standby modeTo display a picture, press the INPUT Button. This is normal behaviour to minimize power consumption during standby mode. To prevent this behaviour, please access the OSD menu and set "USB BC" to "ON".
 - USB cable (A-C) is not included with the monitor. If you use a USB cable (A-C), please note that you can only transfer data.
 - Compatibility with all connected devices is not guaranteed due to different user environments.

NOTE

- Make sure that the building installation has a circuit breaker of 120/240V, 20A (maximum).
- The signal cables used for connecting the computer and monitor may vary with the type of computer used. An incorrect connection may cause serious damage to both the monitor and the computer. The cable supplied with the monitor is for a standard connector. If a special cable is required please contact your local iiyama dealer or regional iiyama office.
- The Class I pluggable equipment Type A must be connected to protective earth.
- The socket-outlet shall be installed near the equipment and shall be easily accessible.
- Excessive sound pressure from ear-/headphones can cause hearing damage/hearing loss.

[Example of Connection]

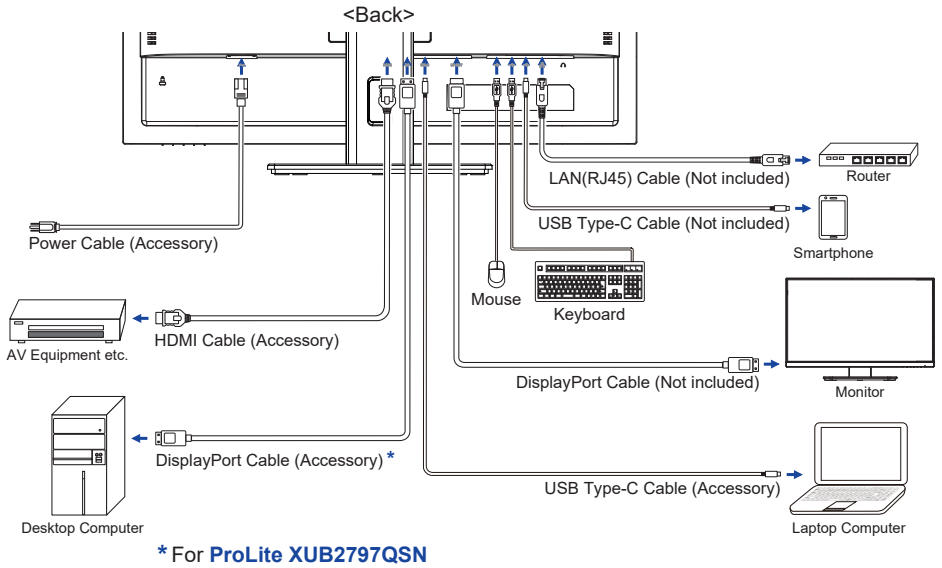

[Collect Cables]

Put the cables through the cable hole to bundle them.

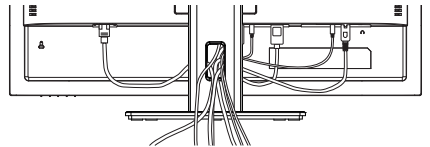

DISCONNECTING YOUR MONITOR

- ① Ensure that both the computer and the monitor are switched off.
- ② Disconnect the power source first and then the Power Cable from the monitor.
- ③ Disconnect the USB cable from the computer and the monitor.
- ④ Disconnect the signal cable from the computer and the monitor.

COMPUTER SETTING

- Signal Timing
Change to the desired signal timing listed on page 33: COMPLIANT TIMING.

ADJUSTING THE HEIGHT AND THE VIEWING ANGLE

- For optimal viewing it is recommended to position yourself directly opposite to the full face of the monitor, then adjust the monitor's height and angle to your own preference.
- Hold the panel so that the monitor does not topple when you change the monitor's height or angle.
- You are able to adjust the monitor's height up to 150mm, angle up to 45° right and left, 23° upward and 5° downward.

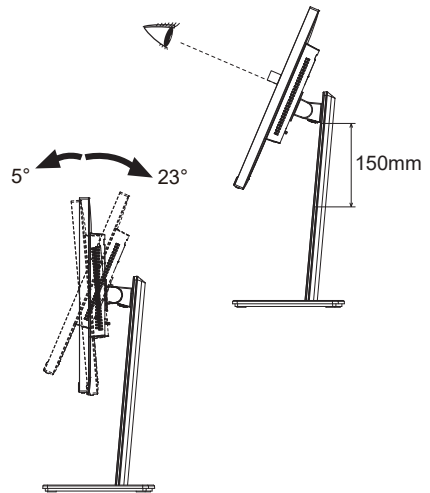

- NOTE**
- Do not touch the LCD screen when you change the height or the angle. It may cause damage or break the LCD screen.
 - Careful attention is required not to pinch your fingers or hands into the moving part of the stand when you change the height or the angle.
 - Injury can occur if care is not taken to avoid finger contact with the displays base when adjusting the height.

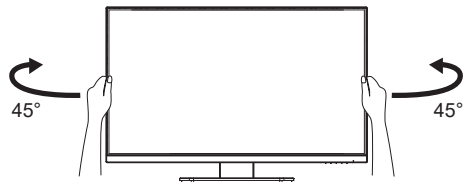
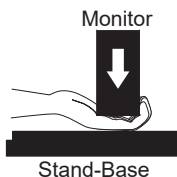

OPERATING THE MONITOR

To create the best picture, your iiyama LCD monitor has been preset at the factory with the COMPLIANT TIMING shown on page 33. You are also able to adjust the picture by following the button operation shown below.

- 1 Press the **MENU Button** to start the **On Screen Display (OSD)** feature. There are additional Menu items which can be switched by using the **◀ / ▶ Buttons**.

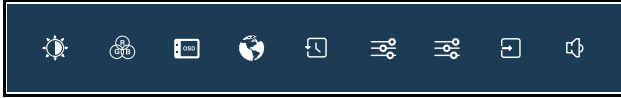

- 2 Select the Menu item which contains the adjustment icon relating to the adjustment you want to make. Press the **MENU Button**. Then, use the **◀ / ▶ Buttons** to highlight the desired adjustment icon.
- 3 Press the **MENU Button** again. Use the **◀ / ▶ Buttons** to make the appropriate adjustment or setting.
- 4 Press the **EXIT Button** to leave the menu, and the settings you just made would be automatically saved.

For example, to correct for OSD vertical position, select Menu item of “OSD” and press the MENU Button. Then, select “OSD Vertical Position” by using the **◀ / ▶ Buttons** and press the MENU Button. Use the **◀ / ▶ Buttons** to change the OSD vertical position settings. The OSD vertical position should be changing accordingly while you are doing this.

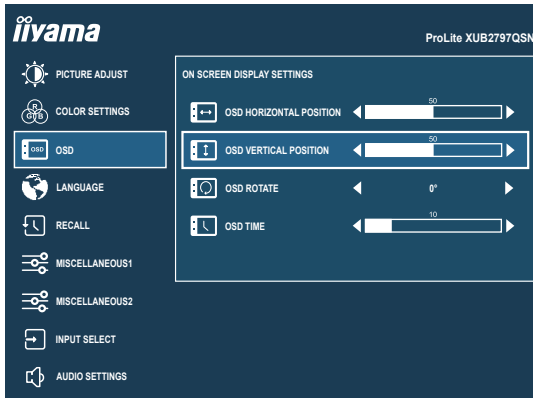

When you press the EXIT Button to end the adjustment, all changes are saved in the memory.

NOTE

- When button operations are aborted during adjustment, On Screen Display disappears when the time set for the “OSD Time” has passed. Also, the EXIT Button can be used to return previous menu and turn off the On Screen Display.
- Any changes are automatically saved in the memory when the On Screen Display disappears. Turning off the power should be avoided while using the Menu.

ADJUSTMENT MENU CONTENTS

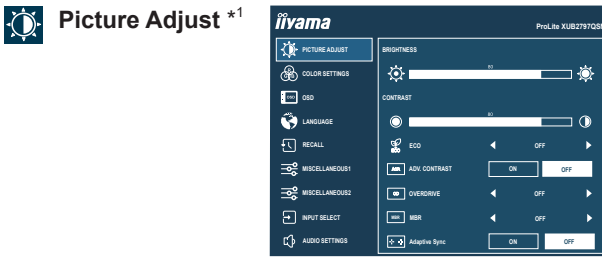

Adjustment Item	Problem / Option		Button to Press
Brightness *2	Too dark Too bright		
Contrast	Too dull Too intense		
Eco Shortcut	Off	Normal	
	Mode 1	Brightness of back-light is reduced.	
	Mode 2	Brightness of back-light is reduced more than Mode 1.	
	Mode 3	Brightness of back-light is reduced more than Mode 2.	
Adv. Contrast	On	Increased Contrast Ratio	
	Off	Typical Contrast Ratio	
Overdrive	Off / 1 / 2 / 3 Improves the gray level response time of the LCD panel. A higher level results in a faster response time.		
MBR *3	Off / 1 / 2 / 3 / 4 / 5 / 6 / 7 Reduces motion blur on the LCD panel.		
Adaptive Sync	On	Activates the Adaptive Sync function.	
	Off	The Adaptive Sync function is turned off.	

*1 Selected adjustments and settings may not be possible due to other items that are enabled. See page 15 **Function Correlation Matrix** for more details.

*2 Adjust the “Brightness” when you are using the monitor in a dark room and feel the screen is too bright.

*3 Disabled when “Adaptive Sync” is activated. Available when the refresh rate is 75Hz or higher. 100Hz is recommended.

Shortcut

You can take a shortcut to the specific menu by the following button operations.

- Eco : Press the Button with no Menu displayed and select “Eco”.

■ Function Correlation Matrix

Active item Selected item	Picture Adjust			Color Settings	
	Eco	Adv.Contrast	MBR	i-Style Color	Blue Light Reducer
				Standard Game Cinema Scenery Text	
Brightness	–	–	–	–	✓
Contrast	✓	–	✓	–	✓
Eco	✓	–	–	–	✓
Adv. Contrast	✓	–	–	–	✓
Overdrive	✓	✓	–	–	✓
MBR	–	–	–	–	–
Adaptive Sync	✓	✓	✓	✓	✓

✓ : Available

– : Not available



Color Settings

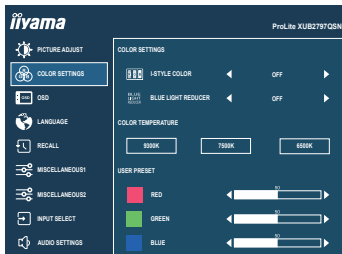

Adjustment Item	Problem / Option		Button to Press	
i-Style Color * ¹	Off	Returns to a state set by color adjustment except i-Style Color.		
	Standard	Standard	For general windows environment and monitor default setting	
		Game	For PC game environment	
		Cinema	For movie and video environment	
		Scenery	For displaying outdoor scenery images	
		Text	For text editing and viewing in a word processing environment	
Blue Light Reducer * ^{2,3}	Off	Typical		
	Mode 1	Blue light is reduced.		
	Mode 2	Blue light is reduced more than Mode 1.		
	Mode 3	Blue light is reduced more than Mode 2.		
Color Temperature * ^{1,3}	9300K	Cool color		
	7500K	Normal color		
	6500K	Warm color		
User Preset * ^{1,3}	Red	Too weak Too strong	← →	
	Green		← →	
	Blue		← →	

*¹ Disabled when “Blue Light Reducer” is activated.

*² Disabled when “i-Style Color” is activated.









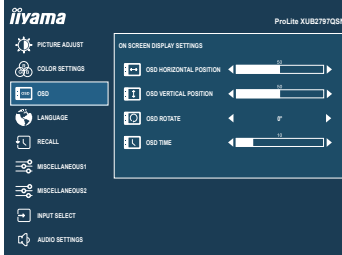





*³ Disabled when “MBR” is activated.

Shortcut

You can take a shortcut to the specific menu by the following button operations.

- i-Style Color : Press the **i** Button with no Menu displayed and select “i-Style Color”.
- Blue Light Reducer : Press the **i** Button with no Menu displayed and select “Blue Light Reducer”.



Adjustment Item	Problem / Option	Button to Press
OSD Horizontal Position	OSD is too left OSD is too right	   
OSD Vertical Position	OSD is too high OSD is too low	   
OSD Rotate *	Rotates the OSD. 0° / +90° / -90°	  
OSD Time	You can set the OSD display duration time between 5 and 30 seconds.	  

* +90°: Appropriate for portrait mode with the monitor rotated to the right.
 -90°: Appropriate for portrait mode with the monitor rotated to the left.

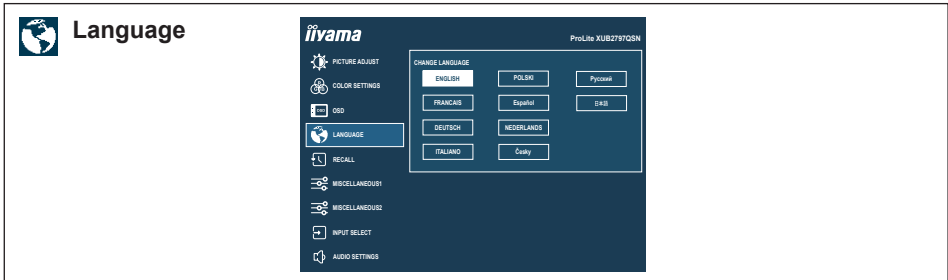

Adjustment Item	Option			
Language	English	English	Español	Spanish
	Français	French	Nederlands	Dutch
	Deutsch	German	Český	Czech
	Italiano	Italian	Русский	Russian
	Polski	Polish	日本語	Japanese

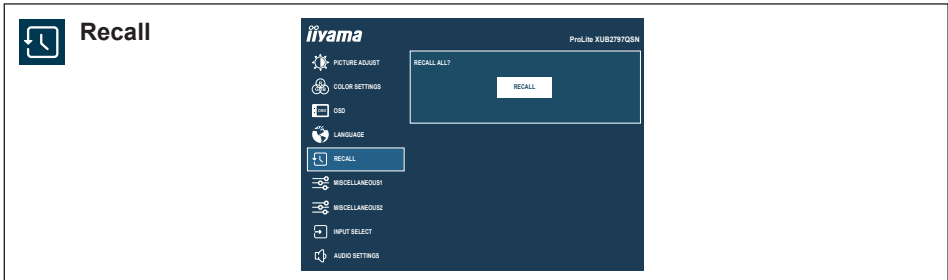

Adjustment Item	Option
Recall	Factory-preset data is restored.



Miscellaneous1



Adjustment Item	Problem / Option		Button to Press
Sharp and Soft	1 2 3 4 5 6 You can change the picture quality from 1 to 6 (sharp to soft). Press the ► Button to change the picture quality in numerical order. Press the ◀ Button to change the picture quality in reverse numerical order.		
Video Mode Adjust *	Full	Full screen display	
	Aspect	Expansion display of Aspect	
Opening Logo	On	iiyama Logo is displayed when the monitor is turned on.	
	Off	iiyama Logo is not displayed when the monitor is turned on.	
RGB Range	Auto	Automatically selects color scale signal.	
	Full	For full-range color scale signal	
	Limited	For limited color scale signal	

* Disabled with 16:9 resolution.



Miscellaneous2

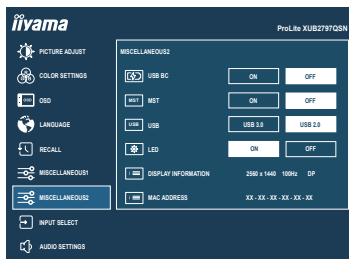

Adjustment Item	Option	
USB BC	On	USB devices can be charged even when the monitor is in the standby mode.
	Off	USB devices can not be charged when the monitor is in the standby mode.
<p>NOTE When the monitor is turned off, USB devices cannot be charged even when the USB BC function is on.</p> <p>While this function is off, USB devices do not operate even when the monitor is in standby mode to save standby electricity. When operating USB devices, turn this function on.</p>		
MST *1,2,3	On	Video signal from computer can be extended on multiple monitors.
	Off	Video signal from computer is cloned on the other monitor.
<p>NOTE Clone mode will be disabled when “Adaptive Sync” is “On” by default.</p>		
USB *4,5	USB 3.0	Selects USB 3.0.
	USB 2.0	Selects USB 2.0.
LED	On	The Power Indicator is turned On.
	Off	The Power Indicator is turned Off.
<p>NOTE Turn Off the Power Indicator when you are bothered by the light.</p>		
Display Information	Displays information regarding the current input signal coming from the graphics card in your computer.	
	<p>NOTE See your graphics card user guide for more information about changing the resolution and refresh.</p>	
MAC Address	Displays the LAN MAC address.	

*1 Available for DisplayPort or USB Type-C input only.

*2 On/Off of the "MST" function is not dependent on input signal switching.

*3 Maximum monitor quantity that can be connected in a daisy chain using DP OUT connector

ProLite XUB2497HSN / ProLite XUB2797HSN

Video format: 1920 × 1080 @60Hz/75Hz

Input source	MST : On Extension mode	MST : Off Clone mode
USB Type-C	2	4
DisplayPort	4	4

ProLite XUB2797QSN

Video format: 2560 × 1440 @60Hz/75Hz

Input source	MST : On Extension mode	MST : Off Clone mode
USB Type-C	2	2
DisplayPort	2	2

- Total number of monitors including the first one connected directly to the computer
- Connected monitor quantity may differ depending on the specification of the computer used.
- Clone mode will be disabled when "Adaptive Sync" is "On" by default.
- 2×2560×1440 @60Hz/75Hz in "MST" mode is available only if "USB" is set to 2.0.

*4 For ProLite XUB2797QSN

*5 Available for USB Type-C input only.



Input Select
Direct

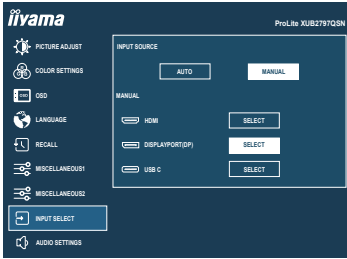

Adjustment Item	Option		
Input Source	Auto *	Search for an available input source and select automatically.	
	Manual	HDMI	Select the Digital (HDMI) input.
		DisplayPort	Select the Digital (DisplayPort) input.
		USB C	Select the Digital (USB Type-C) input.

NOTE "Auto" function enables automatic selection of the input sources available. The input source from the computer in standby mode can not be selected. If you manually select one of the input sources, the other source is not automatically selected.

* Disabled when "MST" is activated.

Direct

You can skip the Menu items and directly display an option setting screen by the following button operations.

- Input Select : Press the INPUT Button with no Menu displayed.



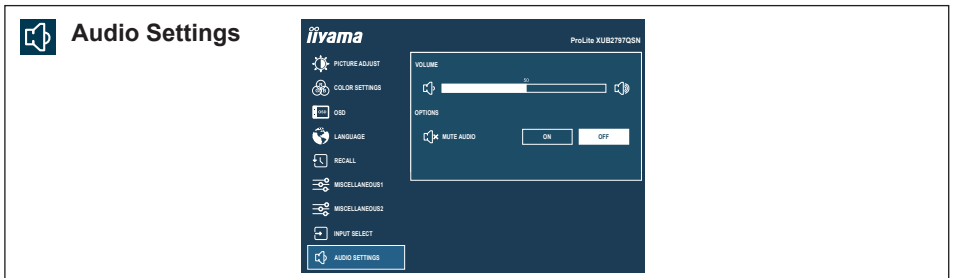

Adjustment Item	Problem / Option		Button to Press
Volume Direct	Too soft Too loud		
Mute Audio Direct	On	Turns off the sound temporarily.	
	Off	Returns the sound volume to the previous level.	

Direct

You can skip the Menu items and directly display an option setting screen by the following button operations.

- Volume : Press the Button with no Menu displayed.
- Mute Audio : Press the Button for 3 seconds with no Menu displayed.

● Lock Mode

<OSD Menu>

1. The OSD lock will be activated by pressing the MENU Button for 10 seconds. If you try to access the OSD by pressing any of the buttons, message "OSD LOCKED" will appear on the screen.
2. The OSD lock will be deactivated by pressing the MENU Button again for 10 seconds.

<Power Button>

1. The Power Button lock will be activated by pressing the EXIT Button for 10 seconds. Locking the Power Button means that won't be able to turn off the Monitor while the Power Button is locked. If you press the Power Button, message "POWER BUTTON LOCKED" will appear on the screen.
2. The Power Button lock will be deactivated by pressing the EXIT Button again for 10 seconds.

STANDBY FEATURE

This product features the standby function. When activated, it automatically reduces unnecessary power consumption of the monitor when your computer is not in use.

There is a standby step the monitor takes as described below. The standby function, including any timer settings is configured by the operating system. Check your operating system manual for information on how this can be configured.

■ Standby Mode

When the video signal from the computer is off, the monitor enters into Standby Mode which reduces the power consumption to 0.5W or less*. The screen becomes dark, and the power indicator turns to orange. From Standby Mode, the image reappears in several seconds when either the keyboard or the mouse are touched again.

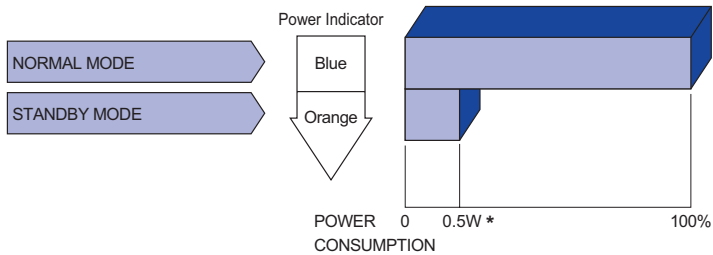

* When the USB devices are not connected.

TROUBLE SHOOTING

If the monitor fails to operate correctly, please follow the steps below for a possible solution.

1. Perform the adjustments described in OPERATING THE MONITOR, depending on the problem you have. If the monitor does not get a picture, skip to 2.
2. Consult the following items if you cannot find an appropriate adjustment item in OPERATING THE MONITOR or if the problem persists.
3. If you are experiencing a problem which is not described below or you cannot correct the problem, discontinue using the monitor and contact your dealer or iiyama service center for further assistance.

Problem

Check

- ① The picture does not appear.

(Power indicator does not light up.)

(Power indicator is blue.)

(Power indicator is orange.)

- ② The screen is not synchronized.

- ③ The screen position is not in the center.

- ④ The screen is too bright or too dark.

- ⑤ The screen is shaking.

- ⑥ No sound.

- ⑦ The sound is too loud or too quiet.

The Power Cable is firmly seated in the socket.

The Power Button is turned ON.

The AC socket is live. Please check with another piece of equipment.

If the blank screen saver is in active mode, touch the keyboard or the mouse.

Increase the Contrast and/or Brightness.

The computer is ON.

The Signal Cable is properly connected.

The signal timing of the computer is within the specification of the monitor.

If the monitor is in standby mode, touch the keyboard or the mouse.

The computer is ON.

The Signal Cable is properly connected.

The signal timing of the computer is within the specification of the monitor.

The Signal Cable is properly connected.

The signal timing of the computer is within the specification of the monitor.

The signal timing of the computer is within the specification of the monitor.

The video output level of the computer is within the specification of the monitor.

The power voltage is within the specification of the monitor.

The signal timing of the computer is within the specification of the monitor.

The audio equipment (computer etc.) is ON.

The Volume is turned up.

The Mute is OFF.

The audio output level of the audio equipment is within the specification of the monitor.

The audio output level of the audio equipment is within the specification of the monitor.

RECYCLING INFORMATION

For better environment protection please don't dispose your monitor.
Please visit our web site: <https://iiyama.com> for monitor recycling.

APPENDIX

Design and specifications are subject to change without prior notice.

SPECIFICATIONS : ProLite XUB2497HSN-B1 / ProLite XUB2497HSN-W1

ENGLISH

Size Category	24"	
LCD Panel	Panel technology	IPS (In-Plane-Switching)
	Size	Diagonal: 23.8" (60.5cm)
	Pixel pitch	0.275mm H × 0.275mm V
	Brightness	250cd/m ² (Typical), 160cd/m ² (Default / Energy Saving)
	Contrast ratio	1300 : 1 (Typical), Advanced Contrast Function Available
	Viewable angle	Right / Left: 89° each, Up / Down: 89° each (Typical)
	MPRT	1ms
Display Colors	Approx. 16.7 Million	
Sync Frequency	Horizontal: 30.0-110.0kHz, Vertical: 55-100Hz	
Native Resolution	1920 × 1080, 2.1 MegaPixels	
Support max. resolution	HDMI: 1920 × 1080, 100Hz DisplayPort: 1920 × 1080, 100Hz USB Type-C: DP Alt mode 1920 × 1080, 100Hz	
Input Connector	HDMI, DisplayPort, USB Type-C	
Input Video Signal	HDMI, DisplayPort, USB Type-C (DP Alt mode)	
USB Standard	USB3.2 Gen 1 (5Gbps), USB Power Delivery (65W)	
Number of USB Ports	1 Upstream: Type-C	
Connector shape	4 Downstream: Type-A (DC5V, 900mA) × 3, Type-C (DC5V, 1.5A) × 1	
LAN Port	RJ45	
Output Video Connector	DisplayPort	
Headphone Connector *1	ø 3.5mm mini jack (Stereo)	
Speakers	2W × 2 (Stereo speakers)	
Maximum Screen Size	527.0mm W × 296.5mm H / 20.7" W × 11.7" H	
Power Source	100-240VAC, 50/60Hz, 2.5A	
Power Consumption *2	18W typical Standby mode: 0.5W maximum, Off mode: 0.3W maximum	
Dimensions	538.5 × 350.0 - 500.0 × 209.5mm / 21.2 × 13.8 - 19.7 × 8.2" (W×H×D)	
Net Weight	5.3kg / 11.7lbs	
Height Adjustment Range	150mm	
Angle	Tilt: Upward: 23°, Downward: 5° Swivel: Left / Right: 45° each Rotation: Clockwise / Counterclockwise: 90° each	
Environmental Considerations	Operating:	Temperature 5 to 35°C / 41 to 95°F Humidity 10 to 90% (No condensation)
	Storage:	Temperature -20 to 60°C / -4 to 140°F Humidity 10 to 90% (No condensation)
Approvals	TCO Certified, CE, UKCA, TÜV-Bauart, EAC, VCCI, PSE	

NOTE

*1 Proper operation of connected external devices other than headphones is not guaranteed.

*2 When the USB devices are not connected.

SPECIFICATIONS : ProLite XUB2797HSN-B1

Size Category	27"	
LCD Panel	Panel technology	IPS (In-Plane-Switching)
	Size	Diagonal: 27" (68.6cm)
	Pixel pitch	0.311mm H × 0.311mm V
	Brightness	250cd/m ² (Typical), 160cd/m ² (Default / Energy Saving)
	Contrast ratio	1000 : 1 (Typical), Advanced Contrast Function Available
	Viewable angle	Right / Left: 89° each, Up / Down: 89° each (Typical)
	MPRT	1ms
Display Colors	Approx. 16.7 Million	
Sync Frequency	Horizontal: 30.0-110.0kHz, Vertical: 55-100Hz	
Native Resolution	1920 × 1080, 2.1 MegaPixels	
Support max. resolution	HDMI: 1920 × 1080, 100Hz DisplayPort: 1920 × 1080, 100Hz USB Type-C: DP Alt mode 1920 × 1080, 100Hz	
Input Connector	HDMI, DisplayPort, USB Type-C	
Input Video Signal	HDMI, DisplayPort, USB Type-C (DP Alt mode)	
USB Standard	USB3.2 Gen 1 (5Gbps), USB Power Delivery (65W)	
Number of USB Ports	1 Upstream: Type-C	
Connector shape	4 Downstream: Type-A (DC5V, 900mA) × 3, Type-C (DC5V, 1.5A) × 1	
LAN Port	RJ45	
Output Video Connector	DisplayPort	
Headphone Connector *1	ø 3.5mm mini jack (Stereo)	
Speakers	2W × 2 (Stereo speakers)	
Maximum Screen Size	597.8mm W × 336.3mm H / 23.5" W × 13.2" H	
Power Source	100-240VAC, 50/60Hz, 2.5A	
Power Consumption *2	22W typical Standby mode: 0.5W maximum, Off mode: 0.3W maximum	
Dimensions	611.5 × 400.5 - 550.5 × 209.5mm / 24.1 × 15.8 - 21.7 × 8.2" (W×H×D)	
Net Weight	6.0kg / 13.2lbs	
Height Adjustment Range	150mm	
Angle	Tilt: Upward: 23°, Downward: 5° Swivel: Left / Right: 45° each Rotation: Clockwise / Counterclockwise: 90° each	
Environmental Considerations	Operating: Temperature 5 to 35°C / 41 to 95°F Humidity 10 to 90% (No condensation) Storage: Temperature -20 to 60°C / -4 to 140°F Humidity 10 to 90% (No condensation)	
Approvals	TCO Certified, CE, UKCA, TÜV-Bauart, EAC, VCCI, PSE	

NOTE *1 Proper operation of connected external devices other than headphones is not guaranteed.

*2 When the USB devices are not connected.

SPECIFICATIONS : ProLite XUB2797QSN-B1 / ProLite XUB2797QSN-W1

Size Category	27"	
LCD Panel	Panel technology	IPS (In-Plane-Switching)
	Size	Diagonal: 27" (68.5cm)
	Pixel pitch	0.233mm H × 0.233mm V
	Brightness	250cd/m ² (Typical), 170cd/m ² (Default / Energy Saving)
	Contrast ratio	1300 : 1 (Typical), Advanced Contrast Function Available
	Viewable angle	Right / Left: 89° each, Up / Down: 89° each (Typical)
	MPRT	1ms
Display Colors	16,777,216	
Sync Frequency	Horizontal: 30.0-151.0kHz, Vertical: 55-100Hz	
Native Resolution	2560 × 1440, 3.7 MegaPixels	
Support max. resolution	HDMI: 2560 × 1440, 100Hz DisplayPort: 2560 × 1440, 100Hz USB Type-C: DP Alt mode 2560 × 1440, 100Hz	
Input Connector	HDMI, DisplayPort, USB Type-C	
Input Video Signal	HDMI, DisplayPort, USB Type-C (DP Alt mode)	
USB Standard	USB3.2 Gen 1 (5Gbps), USB Power Delivery (65W)	
Number of USB Ports	1 Upstream: Type-C	
Connector shape	4 Downstream: Type-A (DC5V, 900mA) × 3, Type-C (DC5V, 3A) × 1	
LAN Port	RJ45	
Output Video Connector	DisplayPort	
Headphone Connector *1	ø 3.5mm mini jack (Stereo)	
Speakers	2W × 2 (Stereo speakers)	
Maximum Screen Size	596.7mm W × 335.7mm H / 23.5" W × 13.2" H	
Power Source	100-240VAC, 50/60Hz, 2.5A	
Power Consumption *2	26W typical Standby mode: 0.5W maximum, Off mode: 0.3W maximum	
Dimensions	613.5 × 400.5 - 550.5 × 209.5mm / 24.2 × 15.8 - 21.7 × 8.2" (W×H×D)	
Net Weight	6.1kg / 13.4lbs	
Height Adjustment Range	150mm	
Angle	Tilt: Upward: 23°, Downward: 5° Swivel: Left / Right: 45° each Rotation: Clockwise / Counterclockwise: 90° each	
Environmental Considerations	Operating: Temperature 5 to 35°C / 41 to 95°F Humidity 10 to 90% (No condensation) Storage: Temperature -20 to 60°C / -4 to 140°F Humidity 10 to 90% (No condensation)	
Approvals	TCO Certified, CE, UKCA, TÜV-Bauart, EAC, VCCI, PSE	

NOTE *1 Proper operation of connected external devices other than headphones is not guaranteed.
*2 When the USB devices are not connected.

DIMENSIONS : ProLite XUB2497HSN

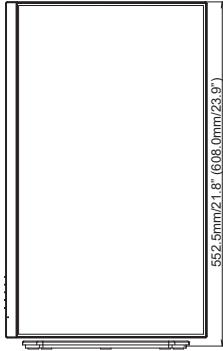
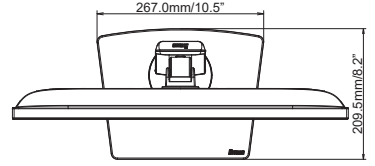
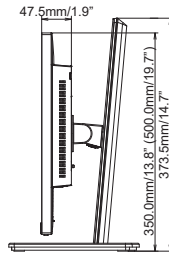
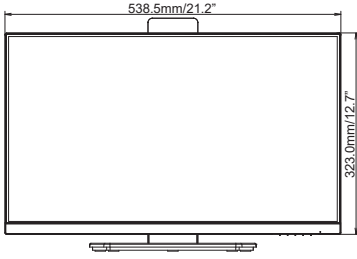

() : Maximum adjustment range

DIMENSIONS : ProLite XUB2797HSN

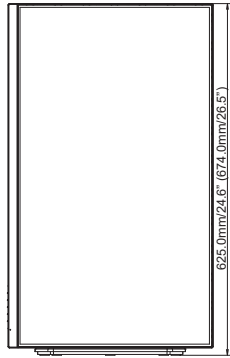
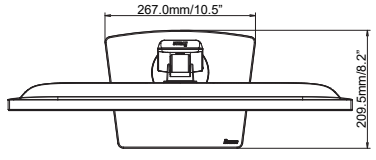
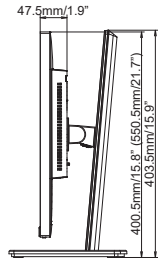
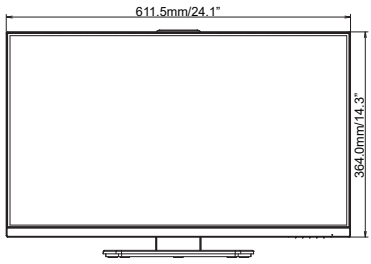

() : Maximum adjustment range

DIMENSIONS : ProLite XUB2797QSN

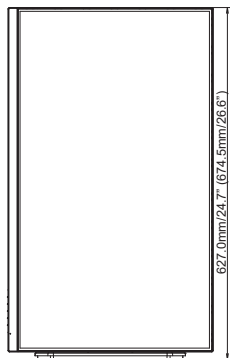
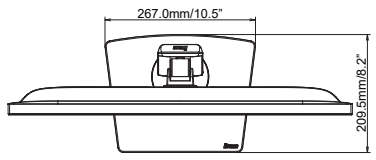
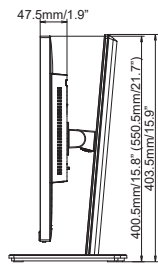
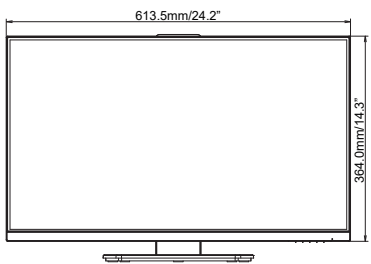

() : Maximum adjustment range

COMPLIANT TIMING

Video Mode	Horizontal Frequency	Vertical Frequency	Dot Clock
800 × 600	37.879kHz	60.317Hz	40.000MHz
	46.875kHz	75.000Hz	49.500MHz
1024 × 768	48.363kHz	60.004Hz	65.000MHz
	60.023kHz	75.029Hz	78.750MHz
1280 × 1024	79.980kHz	75.020Hz	135.000MHz
1680 × 1050	65.290kHz	60.000Hz	146.250MHz
1920 × 1080	67.500kHz	60.000Hz	148.500MHz
	83.890kHz	74.970Hz	174.500MHz
	95.430kHz	84.910Hz	198.500MHz
	110.000kHz	100.000Hz	228.800MHz
2560 × 1440	88.787kHz	59.951Hz	241.500MHz
	111.788kHz	74.925Hz	298.470MHz
	150.849kHz	99.900Hz	398.242MHz
	150.918kHz	99.900Hz	410.500MHz

NOTE *1 Only available for **ProLite XUB2497HSN / ProLite XUB2797HSN**.

*2 Only available for **ProLite XUB2797QSN**.

*3 Only available with DisplayPort or USB Type-C input.

*4 Only available with HDMI input.