

datavideo

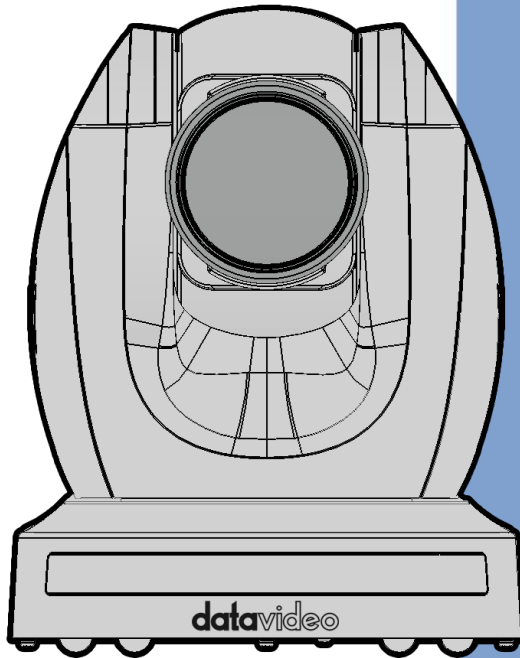

4K TRACKING PTZ
CAMERA
PTC-145
Instruction Manual

www.datavideo.com

Table of Contents

FCC COMPLIANCE STATEMENT	5
WARNINGS AND PRECAUTIONS	5
WARRANTY	6
<i>STANDARD WARRANTY</i>	6
<i>THREE YEAR WARRANTY</i>	7
DISPOSAL	7
1. PRODUCT OVERVIEW	9
FEATURES.....	9
SYSTEM DIAGRAM	10
2. LOCATION AND FUNCTION OF PARTS	11
FRONT	11
REAR	12
BOTTOM	14
3. INSTALLATION INSTRUCTIONS	15
4. NETWORK CONNECTION	19
DHCP MODE	19
STATIC IP	21
DVIP	22
5. BASIC SETUP	25
POWER-ON INITIALIZATION.....	25
VIDEO OUTPUT	25
<i>DVIP/POE Port</i>	25
<i>HDMI Video OUT</i>	27
<i>3G-SDI Video Output</i>	27
6. IR REMOTE CONTROL AND ON-SCREEN MENU.....	28
IR REMOTE CONTROL.....	28
OSD MENU.....	32
7. WEB USER INTERFACE	39
CAMERA CONTROL.....	39

<i>Focus</i>	39
<i>Zoom</i>	40
<i>Pan and Tilt</i>	40
<i>Speed</i>	40
<i>AT</i>	40
<i>Home</i>	40
<i>Presets</i>	41
CAMERA SETUP	41
<i>Basic Image Settings (Page 1)</i>	41
<i>Exposure (Page 1)</i>	41
<i>White Balance (Page 1)</i>	43
<i>Advanced Image Settings (Page 2)</i>	43
VIDEO OUTPUT	45
STREAM	46
<i>RTP Multicast</i>	48
<i>RTSP</i>	50
<i>RTMP(S)</i>	51
<i>SRT</i>	59
<i>ONVIF</i>	65
NETWORK	65
<i>Network Settings</i>	66
<i>NTP Settings</i>	66
AUDIO	67
<i>Audio Input</i>	67
<i>Encode Type</i>	67
<i>Sample Rate</i>	67
<i>Bitrate</i>	67
<i>Soundtrack</i>	67
<i>ADTS Options</i>	68
SYSTEM	68
<i>General</i>	68
<i>Firmware</i>	69
<i>Account and Password</i>	69
AUTO-TRACKING	69
<i>Mode</i>	70
<i>Figure Size</i>	70
<i>AT Speed</i>	71
8. REMOTE CONTROL	72
RS-422/485	72

RS-232	73
Wi-Fi	74
9. FIRMWARE UPDATE.....	76
ETHERNET PORT	76
<i>Requirements</i>	76
<i>Procedure</i>	76
10. FREQUENTLY-ASKED QUESTIONS.....	78
11. DIMENSIONS.....	80
12. SPECIFICATIONS.....	81
SERVICE AND SUPPORT	84

Disclaimer of Product and Services

The information offered in this instruction manual is intended as a guide only. At all times, Datavideo Technologies will try to give correct, complete and suitable information. However, Datavideo Technologies cannot exclude that some information in this manual, from time to time, may not be correct or may be incomplete. This manual may contain typing errors, omissions or incorrect information. Datavideo Technologies always recommend that you double check the information in this document for accuracy before making any purchase decision or using the product. Datavideo Technologies is not responsible for any omissions or errors, or for any subsequent loss or damage caused by using the information contained within this manual. Further advice on the content of this manual or on the product can be obtained by contacting your local Datavideo Office or dealer.

FCC Compliance Statement

This device complies with part 15 of the FCC rules. Operation is subject to the following two conditions:

- (1) This device may not cause harmful interference, and
- (2) This device must accept any interference received, including interference that may cause undesired operation.

Warnings and Precautions

1. Read all of these warnings and save them for later reference.
2. Follow all warnings and instructions marked on this unit.
3. Unplug this unit from the wall outlet before cleaning. Do not use liquid or aerosol cleaners. Use a damp cloth for cleaning.
4. Do not use this unit in or near water.
5. Do not place this unit on an unstable cart, stand, or table. The unit may fall, causing serious damage.
6. Slots and openings on the cabinet top, back, and bottom are provided for ventilation. To ensure safe and reliable operation of this unit, and to protect it from overheating, do not block or cover these openings. Do not place this unit on a bed, sofa, rug, or similar surface, as the ventilation openings on the bottom of the cabinet will be blocked. This unit should never be placed near or over a heat register or radiator. This unit should not be placed in a built-in installation unless proper ventilation is provided.
7. This product should only be operated from the type of power source indicated on the marking label of the AC adapter. If you are not sure of the type of power available, consult your Datavideo dealer or your local power company.
8. Do not allow anything to rest on the power cord. Do not locate this unit where the power cord will be walked on, rolled over, or otherwise stressed.
9. If an extension cord must be used with this unit, make sure that the total of the ampere ratings on the products plugged into the extension cord do not exceed the extension cord's rating.



10. Make sure that the total amperes of all the units that are plugged into a single wall outlet do not exceed 15 amperes.
11. Never push objects of any kind into this unit through the cabinet ventilation slots, as they may touch dangerous voltage points or short out parts that could result in risk of fire or electric shock. Never spill liquid of any kind onto or into this unit.
12. Except as specifically explained elsewhere in this manual, do not attempt to service this product yourself. Opening or removing covers that are marked “Do Not Remove” may expose you to dangerous voltage points or other risks, and will void your warranty. Refer all service issues to qualified service personnel.
13. Unplug this product from the wall outlet and refer to qualified service personnel under the following conditions:
 - a. When the power cord is damaged or frayed;
 - b. When liquid has spilled into the unit;
 - c. When the product has been exposed to rain or water;
 - d. When the product does not operate normally under normal operating conditions. Adjust only those controls that are covered by the operating instructions in this manual; improper adjustment of other controls may result in damage to the unit and may often require extensive work by a qualified technician to restore the unit to normal operation;
 - e. When the product has been dropped or the cabinet has been damaged;
 - f. When the product exhibits a distinct change in performance, indicating a need for service.

Warranty

Standard Warranty

- Datavideo equipment are guaranteed against any manufacturing defects for one year from the date of purchase.
- The original purchase invoice or other documentary evidence should be supplied at the time of any request for repair under warranty.
- The product warranty period begins on the purchase date. If the purchase date is unknown, the product warranty period begins on the thirtieth day after shipment from a Datavideo office.

- All non-Datavideo manufactured products (product without Datavideo logo) have only one year warranty from the date of purchase.
- Damage caused by accident, misuse, unauthorized repairs, sand, grit or water is not covered under warranty.
- Viruses and malware infections on the computer systems are not covered under warranty.
- Any errors that are caused by unauthorized third-party software installations, which are not required by our computer systems, are not covered under warranty.
- All mail or transportation costs including insurance are at the expense of the owner.
- All other claims of any nature are not covered.
- All accessories including headphones, cables, and batteries are not covered under warranty.
- Warranty only valid in the country or region of purchase.
- Your statutory rights are not affected.

Three Year Warranty

- All Datavideo products purchased after July 1st, 2017 are qualified for a free two years extension to the standard warranty, providing the product is registered with Datavideo within 30 days of purchase.
- Certain parts with limited lifetime expectancy such as LCD panels, DVD drives, Hard Drive, Solid State Drive, SD Card, USB Thumb Drive, Lighting, Camera module, PCIe Card are covered for 1 year.
- The three-year warranty must be registered on Datavideo's official website or with your local Datavideo office or one of its authorized distributors within 30 days of purchase.



Disposal



For EU Customers only - WEEE Marking

This symbol on the product or on its packaging indicates that this product must not be disposed of with your other household waste. Instead, it is your responsibility to dispose of your waste equipment by handing it over to a designated

collection point for the recycling of waste electrical and electronic equipment. The separate collection and recycling of your waste equipment at the time of disposal will help to conserve natural resources and ensure that it is recycled in a manner that protects human health and the environment. For more information about where you can drop off your waste equipment for recycling, please contact your local city office, your household waste disposal service or the shop where you purchased the product.

1. Product Overview

The PTC-145 series builds upon the success of its predecessor, the PTC-140 series, maintaining high-quality output with a 20x optical zoom ideal for auditoriums, classrooms, and conference halls. Featuring built-in AI Tracking for smooth object tracking, it offers instant activation via the camera controller or infrared remote control, ensuring seamless operation without delay.

The camera is capable of delivering the output video to HDMI, 3G-SDI, and stream ports at the same time. Additionally, the camera supports dual-platform streaming and encoding in H.264, H.265, and Motion JPEG formats. The camera accepts external audio via a 3.5 mm Line-IN port which can be activated via the web GUI. With standard PoE (Power over Ethernet) configuration serving to simplify power wiring, on-site audio devices can be easily integrated.

Designed to meet diverse workflow requirements, the PTC-145 series definitely offers versatility.

Features

- PTZ camera with 3.5 mm line-in audio input
- Supports 4K video interfaces: 3G-SDI, HDMI, and Stream ports
- Allows simultaneous video streaming to two platforms
- Easy activation of AI tracking for smooth PTZ operation without cameramen
- Features 1/2.8" CMOS sensor, 20x optical zoom, and 8x digital zoom
- Available in white color model

System Diagram

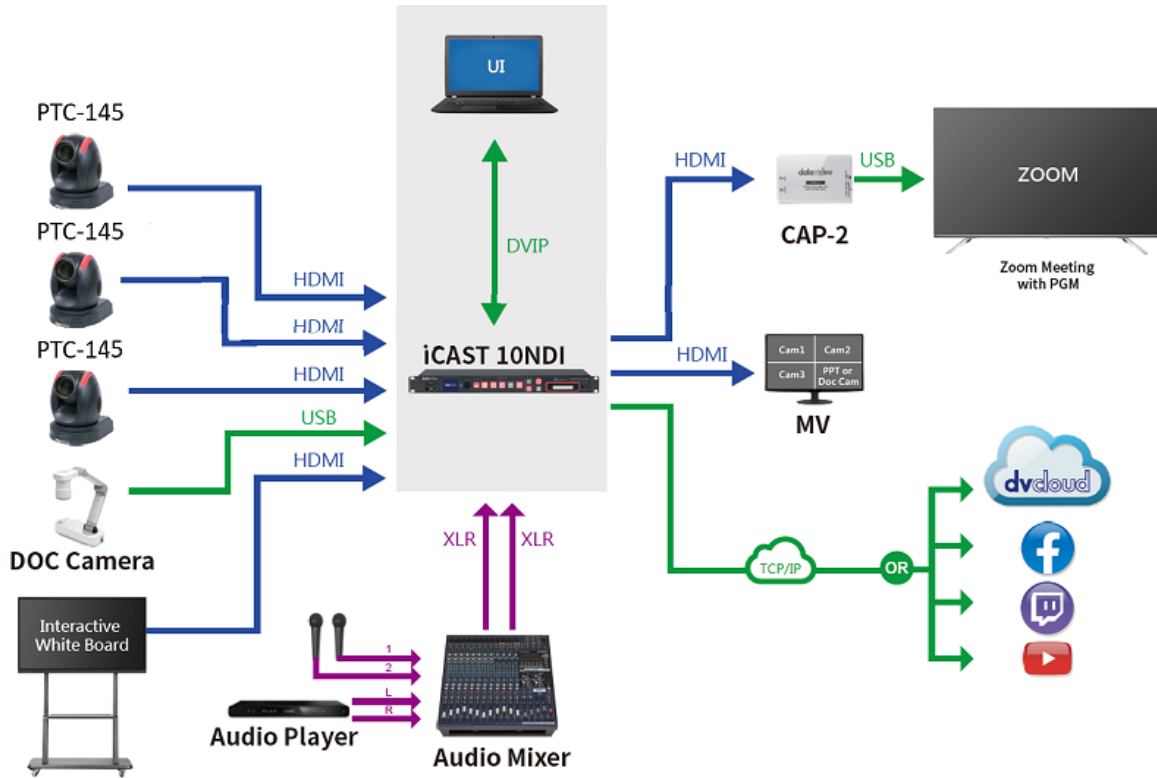

2. Location and Function of Parts

Front



1	Lens Built-in 1/2.8" 2.07M Pixel CMOS HD color camera with white balance control, backlight compensation, automatic gain, etc.
2	Tally LED Tally lamp will be turned ON upon receiving the ON signal.
3	Sensor for Remote Control Remote control IR receiver

Rear



1	<p>Power Input</p> <p>DC in socket connects the supplied 12V PSU. The connection can be secured by screwing the outer fastening ring of the DC In plug to the socket.</p>
2	<p>DVIP/POE Interface</p> <p>The DVIP interface is a protocol designed by Datavideo to allow the user to access the camera's Web UI by simply connecting a PC to the camera using a standard Ethernet cable. See Network Connection for establishing connection and Web User Interface for accessing the camera's internal settings.</p> <p>This bidirectional port also allows you to connect the camera to a network for video streaming.</p>

3	<p>HDMI OUT</p> <p>The HDMI OUT allows you to connect an external HDMI monitor via an HDMI cable.</p>
4	<p>3G-SDI OUT</p> <p>The 3G-SDI OUT allows you to connect an external SDI monitor via an SDI cable.</p>
5	<p>LINE IN</p> <p>The 3.5mm audio input receives external audio.</p> <p>Note: Use the Web UI to select LINE IN.</p>
6	<p>RS-422/RS-485 Interface (RJ-45)</p> <p>The RS-422/RS-485 interface is designed to connect an external RS-422 or RS-485 device using a custom Ethernet cable. See the section on RS-422/485 for wiring pinouts.</p>
7	<p>RS-232 Interface (RJ-45)</p> <p>The RS-232 interface is designed to connect an external RS-232 device using a custom Ethernet cable. See the section on RS-232 for wiring pinouts.</p>

Bottom

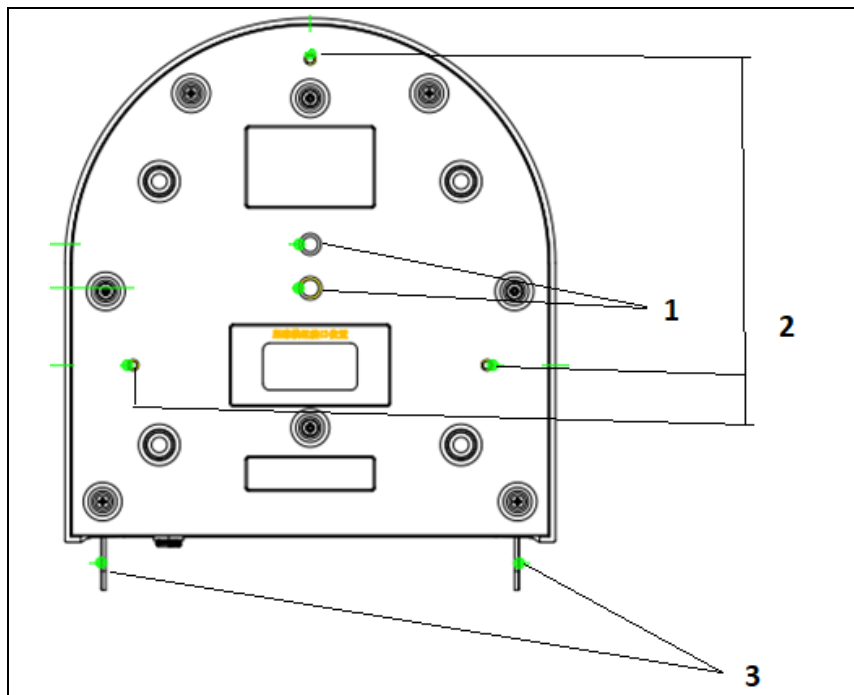

1	Tripod Screw Hole allows the user to mount the camera on the tripod.
2	Screw Hole Screw holes for ceiling bracket mounting.
3	For Safety Rope Ties safety ropes for securing the camera to the ceiling.

3. Installation Instructions

Note: Only mount the bracket on formwork or concrete surface. Do NOT mount the bracket on plasterboard.

In your product package, you should find

- PM3*5 screw x 6
- Ceiling bracket (upper and lower plates) x 1
- PTC-145 camera x 1

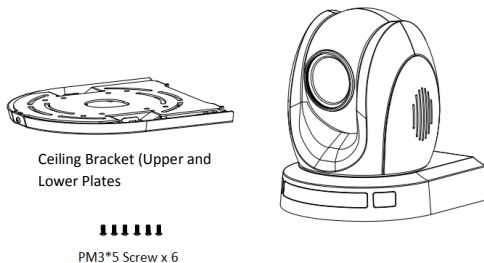

Additionally, you will also need the following to secure the ceiling bracket to the ceiling:

- PA4*30 self-tapping screw x 4
- PA4 plastic screw stopper x 4

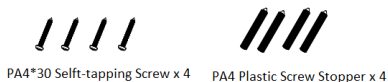

Step 1: The Ceiling Bracket

Separate the ceiling bracket into two parts (upper and lower plates) as depicted in the diagram below.

STEP 1

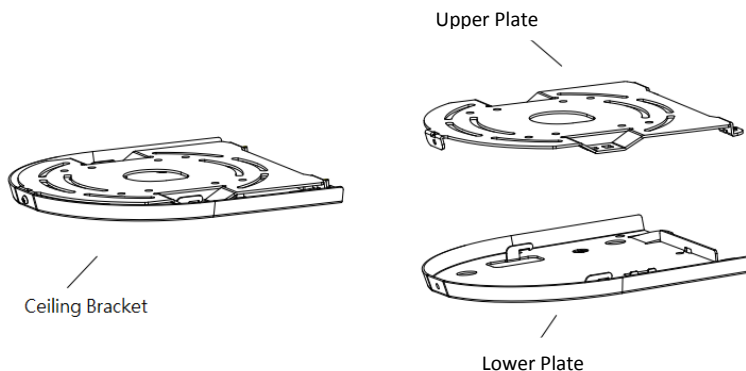

Step 2: Mount the bracket's upper plate to the ceiling

Insert the four PA4 plastic screw stoppers into the ceiling as shown in the diagram below.

Using four PA4*30 self-tapping screws, affix the bracket's upper plate to the ceiling.

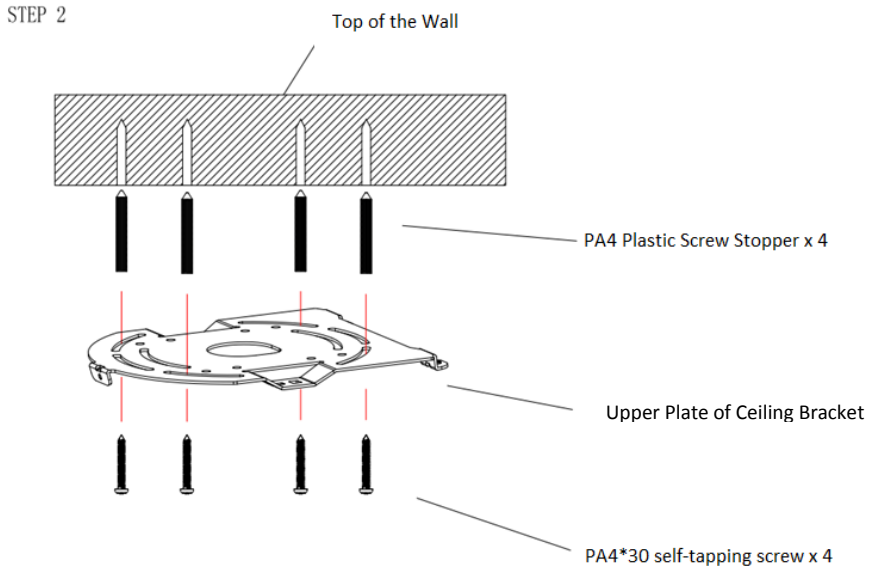

Step 3: Affix the bracket's lower plate to the bottom of PTC-145

As depicted in the diagram below, use three PM3*5 screws to affix the bracket's lower plate to the bottom of PTC-145.

STEP 3

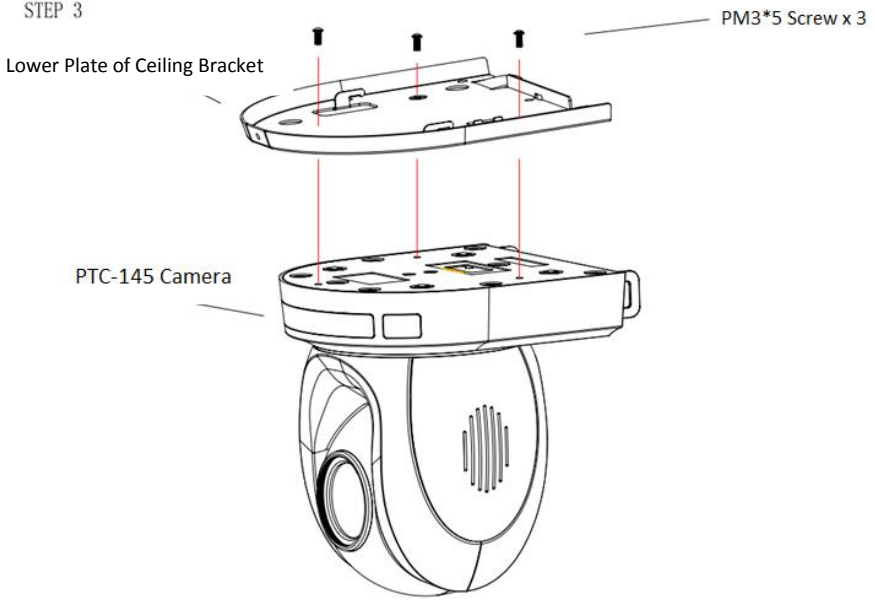

Step 4: Mount the PTC-145 Camera to the ceiling

Now push the PTC-145 camera into the bracket's upper plate in the direction as indicated by the arrow in the diagram below. Make sure the two plates click into place.

Finally, secure the PTC-145 camera to the upper plate with three PM3*5 screws.

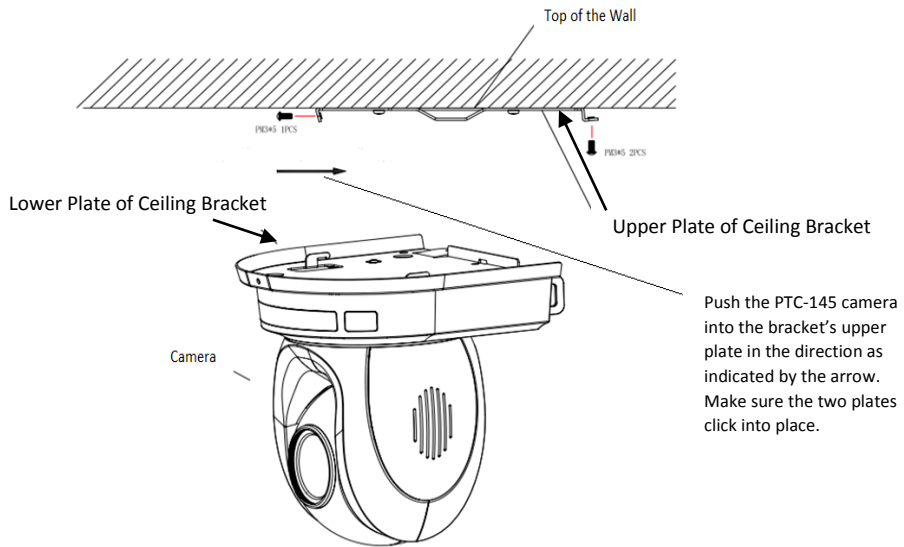

Step 5: Final

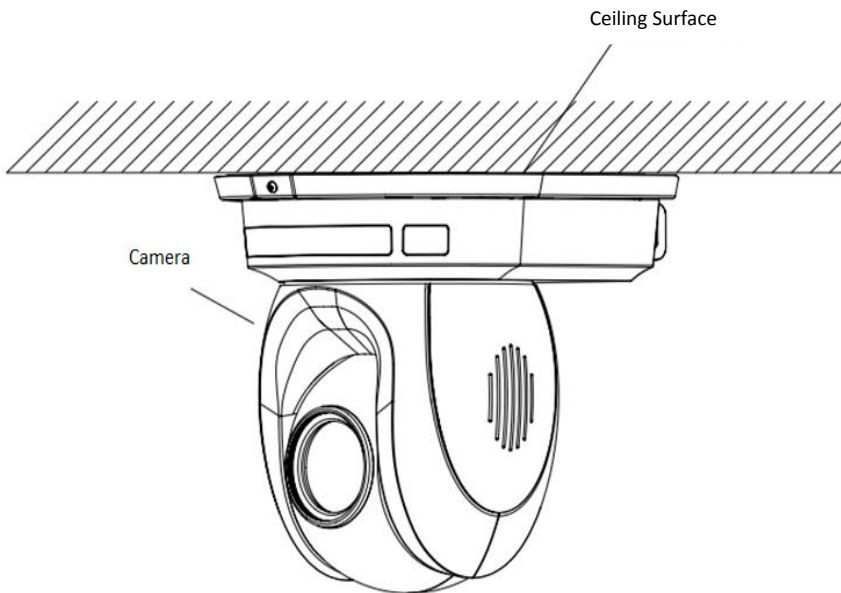

4. Network Connection

The Ethernet port on the back panel of your PTC-145 allows you to connect a PC/laptop to the camera with a static or dynamic IP address. To access and modify these network settings, you will need to log in to the camera's web interface.

If this is your first time using the device, please note that the camera's default connection mode is static IP with an IP address of 192.168.100.100. This allows you to connect to the camera directly from a PC and configure the device's network settings accordingly.

In this chapter, we will show you how to use the web UI to configure DHCP and Static IP modes in two separate sections.

DHCP Mode

Dynamic Host Configuration Protocol (DHCP) is a network protocol that enables a server to allocate an IP address to a DHCP client device from defined IP address pools configured for a given network. An example DHCP server setup is illustrated in the diagram below.



After connection has been successfully established, on your PC/laptop, use DVIP Configuration Tool to search for the camera's IP address. If you are new to DVIP, see the [DVIP](#) section for more descriptions of the tool.

Open a web browser and in the address bar, enter the camera's IP address then press the **ENTER** key which should take you to the login page of the web interface.

The default login credentials are:

- User Name: admin
- Password: admin

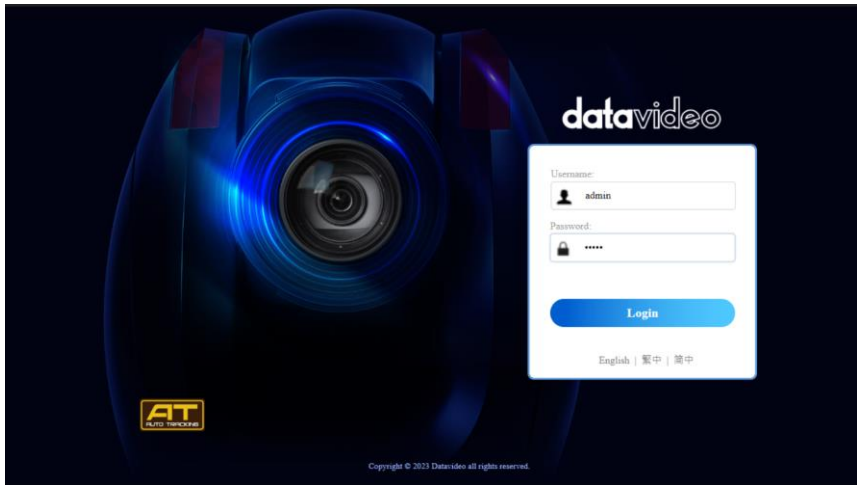

Once you are logged in, open the Network page to modify the network settings accordingly.

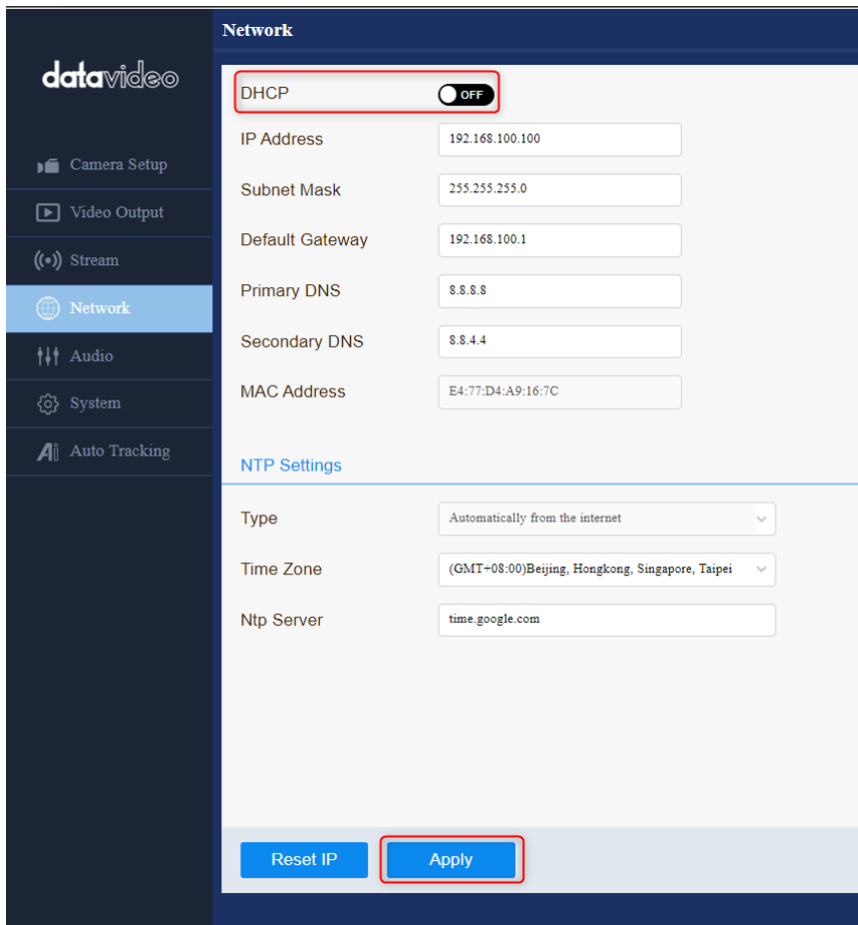

Static IP

A static IP address is a fixed address manually assigned to PTC-145. First disable DHCP mode then enter an IP address for the camera, as well as the subnet mask and the gateway IP.

Note: Never assign an address that ends in .0 or .255 as these addresses are typically reserved for network protocols. An address to the very start of the IP pool is also not recommended as it is always reserved for the router.

After you've configured the camera's static IP mode, click the "Apply" button to save the new settings then reboot PTC-145.

Now set up direct connection between the camera and your PC/laptop as depicted in the diagram below; remember to manually assign an IP address to your PC/laptop. The first three octets of the IP addresses should be the same.

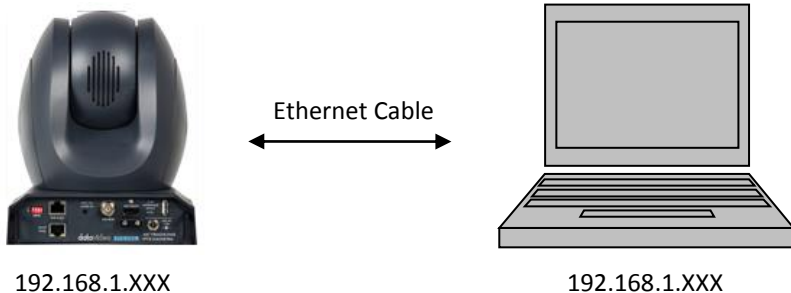

DVIP

DVIP is an Ethernet-based protocol designed by Datavideo to connect a network of Datavideo devices. DVIP Configuration Tool is a special network configuration software tool designed for DVIP device search on the same network and configuring device network settings such as Hostname, DHCP mode, IP address, subnet mask, gateway IP, and primary and secondary DNS.

Depending on your operating system, download DVIP Configuration Tool from the respective sites listed as follows:

PC: <https://www.microsoft.com/en-us/p/dvip-network-config/9p6gtz839k6s?activetab=pivot%3Aoverviewtab>

Android:

https://play.google.com/store/apps/details?id=com.datavideo.dvipnetconfig&hl=en_US

iOS: <https://itunes.apple.com/tw/app/dvip-network-config/id1177895983?mt=8>

After you've installed the DVIP Network Configuration Tool, follow the steps outlined below to scan for online DVIP devices and configure their corresponding settings.

Step 1: Open the DVIP Network Configuration Tool then select your PC or laptop's network interface card from the drop-down menu in the pop-up window as shown in the diagram below.



Step 2: The DVIP Network Configuration Tool interface is shown below and you should see a list of the connected cameras.

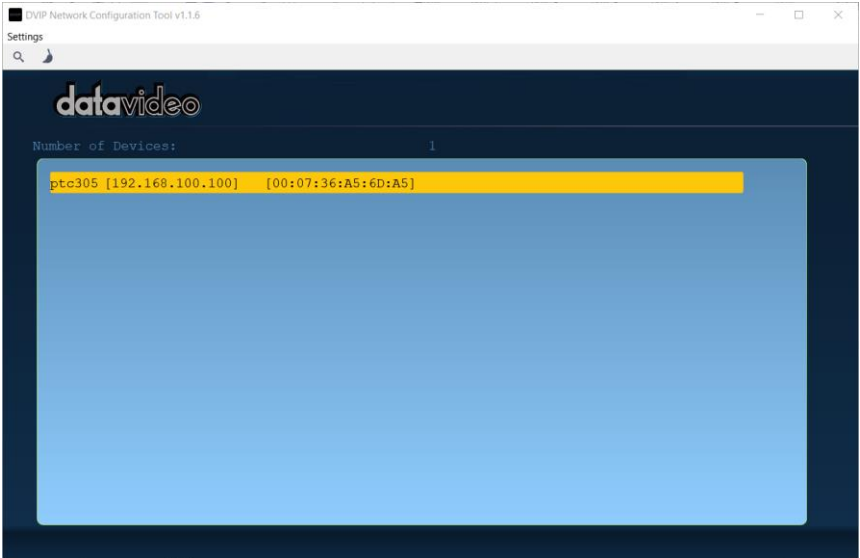

Step 3: Click one of the connected cameras to show the device information and its network settings in the pop-up window shown in the diagram below.

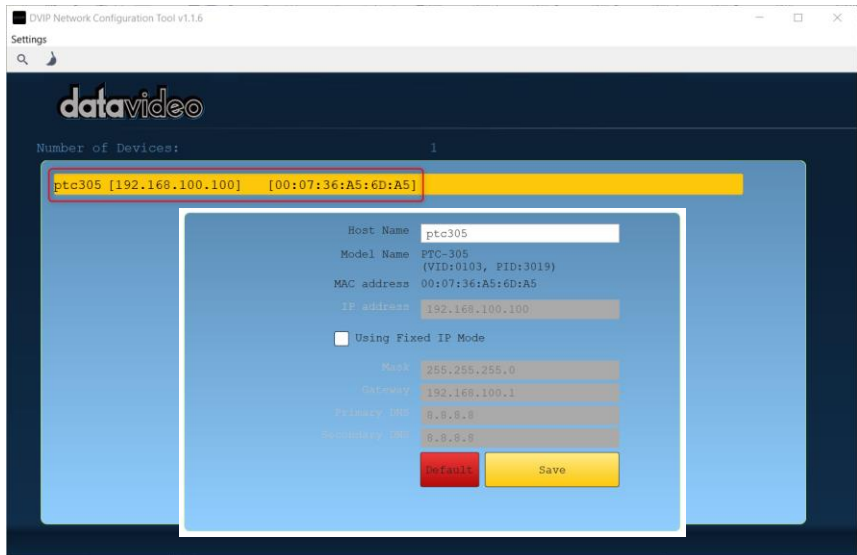

Step 4: You are allowed to change the device name in the Host Name field and modify the device's network settings accordingly. Click the Save button to confirm the change. To reset, simply click the Default button.

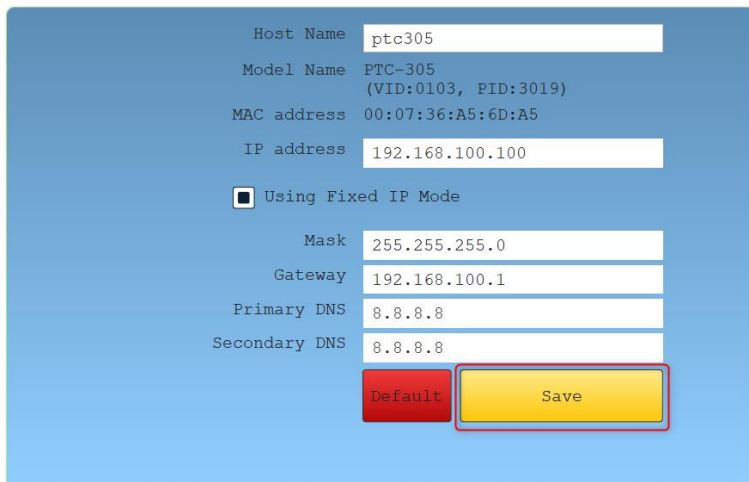

5. Basic Setup

Power-On Initialization

As shown in the diagram below, after you plug in the power cord, the tally light in the front, depending on your tally setting, will start flashing red, green or a mix of both and will be OFF as soon as the power-on initialization is complete. Please note that the power-on initialization should not take more than 45 seconds before the camera image is shown on the connected monitor. If this is your first time using the camera, the camera head should be at the HOME position with the lens facing front. If the camera has been used before, the camera head should be at the position right before the camera is shut down the last time.

Note: Use the [OSD menu](#) or [web UI](#) to select the tally light color.



Connect the DC 12 V power adapter

Video Output

You are allowed to view the camera video via **DVIP**, **4K HDMI OUT** and **3G-SDI OUT**.

DVIP/POE Port

DVIP is an Ethernet-based protocol for bidirectional video and audio transmission. See [Network Connection](#) for detailed network information if you are new to DVIP.



Follow the instructions below to view the camera video on the web user interface.

Connect the PTC-145 camera to your PC/Notebook PC over a network

1. With Ethernet cables, establish connection between the PTC-145 and a PC/Notebook via a router.

Note: Assuming that the PTC-145NDI's connection mode is DHCP.

2. On the PC/Notebook, open the DVIP Network Configuration Tool and search for the PTC-145 then on a web browser, enter the camera's IP address into the address bar.
3. On the login page, enter the default username and password which are admin/admin respectively.
4. Once logged in, you should be able to see a preview window on which the video is shown.

Connect the PTC-145 camera directly to your PC/Notebook PC

1. While still connected to the PTC-145 via a router in DHCP mode, open the camera's web UI on the PC/Notebook then the network page.
2. Disable DHCP then enter a static address in the **IP Address** textbox. Remember to enter a network mask and the rest are simply optional.
3. Do the same thing to your PC/Notebook. Make sure both IP addresses have the same first three octets.
4. Now connect the PTC-145 directly to the PC/Notebook using an Ethernet cable.
5. On your PC/Notebook, open the web browser and enter the camera's static IP address into the address bar.
6. On the Login page enter the default username and password which are admin/admin respectively.
7. Once logged in, you should be able to see a preview window on which the video is shown.

HDMI Video OUT

Connect the 4K HDMI OUT to an external monitor using an HDMI cable.



3G-SDI Video Output

Connect the 3G-SDI OUT to an external monitor using an SDI cable.









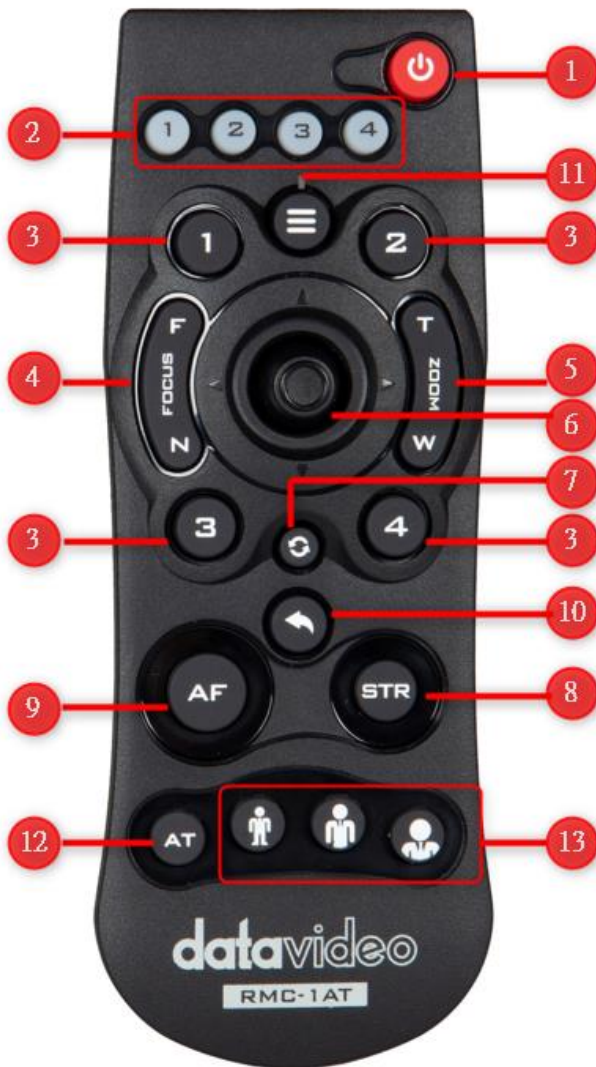

6. IR Remote Control and On-Screen Menu





Chapter 6 provides an overview of remote control functions and the OSD menu.

IR Remote Control



No	Function Keys	Descriptions
1		<p>Power Button Press to switch between Standby and Operation modes.</p> <p>Note: The power consumption in Standby Mode is approximately half of the power consumption in Operation Mode.</p>
2		<p>Camera Select Keys 1-4 In a multi-camera environment, use the camera select keys (CAM1 – CAM4) to navigate between the four cameras.</p> <p>To assign an ID number (from 1 to 4) to the cameras intended for operation, follow these steps:</p> <ol style="list-style-type: none"> 1. Press and hold any one of the camera select keys until all four keys light up. 2. Press a number key to finalize the assignment.
3		<p>Preset Keys 1 – 4 Use the preset keys to save and recall PTZ settings.</p> <p>Saving to the Preset Key: First configure the camera's focus, zoom, pan and tilt settings, then press the STR key followed by one of the preset keys to save to the selected preset.</p> <p>Recalling the Preset: Simply press one of the preset keys to load the settings saved therein.</p>
4		<p>Focus Button Auto focus will be disabled as the Focus button (either F or N) is pressed. Press F to focus on a far object and N to focus on a near object.</p> <p>Note: You can also adjust the focus using the web UI. See Focus for more details.</p>

No	Function Keys	Descriptions
5		<p>Zoom Button The zoom function adjusts the size of the image. Press T (telephoto lens) to zoom in on a subject from far away and W (wide-angled lens) to zoom out.</p> <p>Note: You can also adjust the zoom using the web UI. See Zoom for more details.</p>
6		<p>PT Joystick Use the joystick to pan and tilt the camera head. Press the up and down arrow keys to tilt; press the left and right arrow keys to pan.</p> <p>While the OSD menu is opened, press the up and down keys to move between options. Press the right and left keys to toggle between values. Press the center button to enter a sub menu or confirm a selection. To exit a sub menu, press the MENU or Back button.</p>
7		<p>Reset IP Button Press and hold for about 3 seconds to reset the camera's network settings to DHCP.</p> <p>Note: If there is no DHCP server on your network, the camera will use static IP to connect after the reset. The default IP address is 192.168.100.100.</p>
8		<p>STR Button Use the STR button along with the preset keys to save the PTZ settings. See Preset Keys 1 – 4 for more information.</p>
9		<p>AF Button Press to enable Auto Focus.</p>

No	Function Keys	Descriptions
10		<p>Back Button Press to return the camera head to its default position. When the OSD menu is opened, press to return to the previous item on the menu.</p>
11		<p>MENU Button Press the “MENU” button to open the OSD menu on the connected monitor. See OSD Menu for descriptions of various menu options.</p>
12		<p>AT Button Press to enable auto-tracking.</p> <p>Note: Once auto-tracking is enabled, the message “Start Tracking” should appear on the monitor showing the camera video. See Auto-Tracking for various relevant settings.</p>
13		<p>Auto-Tracking Mode Selection Buttons From left to right, these three buttons select, in the respective order, full body, half body and close-up framing.</p>

OSD Menu

On-Screen Menu allows the user to modify various camera settings. Press **[MENU]** on the **remote control** to open the on-screen menu as shown below.

OSD Menu
Language
Tracking
Setup
Camera
P/T/Z
Video Format
Network Settings
Version
Restore Default

[↑↓] (Select) **[← →]** (Change value)

[Menu] (Back) **[Home]** OK

The table below summarizes the main option items and their sub-options.

Main Options									
Language	Tracking	Setup	Camera	P/T/Z	Video Format	Network Settings	Version	Restore Default	
Sub-Options	English	Tracking	Protocol	Exposure	SpeedByZoom	1080P60	DHCP	ARM	Restore Default
	Traditional Chinese	Tracking Mode	VISCA Address	Color	Zoom Speed	1080P50	IP Addr	SOC	
	Simplified Chinese	Figure Size	VISCA Address Fix	Image	Image Freezing	1080I60		AF	
		Full Presetting	PELCO-P Address	Focus	Acc Curve	1080I50			
		Customized Presetting	PELCO-D Address	Noise Reduction	Preset Speed	1080P30			
		Half-Body Presetting	Baudrate	Style	Joystick Pan Dir	1080P25			
		Near Body Presetting	Auto Flip		Joystick Tilt Dir	720P60			
		Track Speed	Tally Light			720P50			
		Character Position				1080P59.94			
						1080I59.94			
						1080P29.97			
					720P59.94				

Details of all options in the on-screen menu are listed in the table below.

Main Menu	Sub Menu	Options	Descriptions
Language	English		
	Traditional Chinese		
	Simplified Chinese		
Tracking	Tracking	ON	
		OFF	
	Tracking Mode	Presenter	
	Figure Size	Full	
		Customized	
		Half-Body	
		Close Up	
	Full Presetting	1	
		2	
		3	
	Customized Presetting	1	
		2	
		3	
		4	
		5	
		6	
		7	
		8	
	Half-Body Presetting	1	
		2	
		3	
Near Body Presetting	1		
	2		
	3		
Track Speed	Slow		
	Fast		
	Middle		
Character Position	Center		
	Right Half		
	Left Half		
Setup	Protocol	Auto	
		VISCA	
		PELCO-D	
		PELCO-P	
	VISCA Address	1	
		2	
		3	
		4	
		5	
		6	
7			
VISCA Address Fix	ON		
	OFF		
PELCO-P Address	1 – 255		

Main Menu	Sub Menu	Options	Descriptions
	PELCO-D Address	1 – 255	
	Baudrate	2400	
		4800	
		9600	
		38400	
		115200	
	Auto Flip	ON	
		OFF	
	Tally Light	Red/Green	
		Red	
		Green	
		OFF	
	Camera	Exposure	Mode
Manual			
SAE			
AAE			
Bright			
EV			ON
			OFF
EV Level			7
			6
			5
			4
			3
			2
			1
			0
			-1
			-2
			-3
BLC			ON
			OFF
Flicker			OFF
			50Hz
			60Hz
G. Limit			0 – 15; Step Size: 1
DRC			OFF
			1
			2
	3		
	4		
	5		
	6		
	7		
8			

Main Menu	Sub Menu	Options	Descriptions
		Iris	F1.8
			F2.0
			F2.4
			F2.8
			F3.4
			F4.0
			F4.8
			F5.6
			F6.8
			F8.0
			F9.6
			F11
			OFF
		Shutter	1/60
			1/90
			1/100
			1/125
			1/180
			1/250
			1/350
			1/500
	1/725		
	1/1000		
	1/1500		
	1/2000		
	1/3000		
	1/4000		
	1/6000		
	1/10000		
	Gain	0 – 36; Step Size: 1	
	Bright	0 – 14; Step Size: 1	
	Color	WB Mode	Auto
			Manual
Indoor			
Outdoor			
OnePush			
VAR			2400K – 7100K; Step Size: 100K
RG Tuning		-10 – 10; Step Size: 1	
BG Tuning		-10 – 10; Step Size: 1	
RG		0 – 255; Step Size: 1	
BG		0 – 255; Step Size: 1	
Saturation		60 – 200%; Step Size: 10%	
Hue	-15 – 15; Step Size: 1		
Image	Brightness	0 – 32; Step Size: 1	
	Contrast	0 – 14; Step Size: 1	
	Sharpness	0 – 11; Step Size: 1	
	B&W Mode	Color	
		B&W	

Main Menu	Sub Menu	Options	Descriptions
	Focus	DZoom	ON
			OFF
		Focus Mode	Auto
			Manual
			OnePush
		AF-Zone	All
			Top
			Center
			Bottom
		AF-Sensitivity	Low
			Middle
	High		
	Noise Reduction	NR-3D	OFF
			1
			2
			3
			4
			5
			6
			7
			8
9			
10			
11			
Style	Default		
	Meeting		
	Clarity		
	Bright		
	Soft		
P/T/Z	Speed By Zoom	ON	Pan and tilt speed as a function of zoom once enabled. The PTZ speed should increase and decrease gradually in a linear fashion.
		OFF	
	Zoom Speed	1	
		2	
		3	
		4	
		5	
		6	
		7	
		8	
	Image Freezing	ON	
		OFF	
	ACC Curve	Standard	
		Slow	
		Fast	
Preset Speed	Fast		
	Slow		

Main Menu	Sub Menu	Options	Descriptions
		Middle	
	Joystick Pan Dir	Positive	
		Negative	
	Joystick Tilt Dir	Positive	
		Negative	
Video Format	1080P60		
	1080P50		
	1080I60		
	1080I50		
	1080P30		
	1080P25		
	720P60		
	720P50		
	1080P59.94		
	1080I59.94		
	1080P29.97		
	720P59.94		
Network Settings	DHCP	ON	
		OFF	
	IP Addr	192.168.100.100	Static IP Mode
Version	ARM		Firmware information
	SOC		
	AF		
Restore Default	Restore Default	Yes/No	Factory reset

7. Web User Interface

The web based user interface allows you to set and control your PTC-145 devices. On any browser, enter the camera's IP address then hit the Enter key, after which you should be taken to the login page. The default login credentials are admin/admin. Please note that the password can be changed later.

Please note that in order to access the web UI, your PC needs to be connected to the camera via the DVIP interface. See [Network Connection](#) to connect.

Camera Control

Once logged in to the web UI, you will be able to find the control panel shown below in [Camera Setup](#) and [Auto-Tracking](#).



A preview window is positioned in the left half of the panel, allowing you to view the live camera video. On the right half, you will find various camera control options described as follows:

Focus

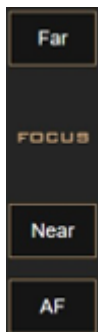

You can focus on objects at varying distances by adjusting its focal length to bring both near and far subjects into sharp focus. Click **Far** to focus on a far object and **Near** to focus on a near object.

You can also enable **Auto Focus** by clicking the AF button, allowing the camera to automatically set the focus on the center of the image.

Zoom

The zoom function adjusts the size of the image. Click Tele (telephoto lens) to zoom in on a subject from far away and Wide (wide-angled lens) to zoom out.

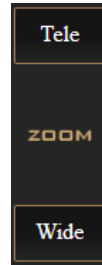

Pan and Tilt



Use the up/down arrows to tilt the camera head up and down and the left/right arrows to pan the camera head left and right. You can simply hover the mouse cursor over these arrow buttons.

Speed



Click the **Fast/Slow** buttons to increase/decrease the pan, tilt and zoom speed.

AT

Click the **AT** button to enable auto-tracking. Auto-tracking detects motion of objects and use the PTZ to follow it. See [Auto-Tracking](#) for in-depth setup.



Home



Click the **Home** button to return the PTZ position to the default settings.

Presets

There are 255 memory presets where you can save the PTZ and focus settings to. First enter a preset number (0 – 254) in the **PRESET** textbox then click the **Store** button to save the current PTZ and focus settings to the selected preset position. To access a preset position, simply enter the number in the **PRESET** textbox then click the **Call** button.



Camera Setup

In Camera Setup, you will be able to find various settings for the camera video. These options will be described in detail in this section.

Basic Image Settings (Page 1)

Contrast

Adjust image contrast from 0 – 14.

Brightness

Adjust image brightness from 0 – 32.

Saturation

Adjust image saturation from 60 – 200%.

Note: The higher the saturation, the more vivid the colors will be.

Hue

Adjust image hue from -15 – 15.

Sharpness

Adjust image sharpness from 0 – 11.

Exposure (Page 1)

Exposure modes are listed as follows:

Auto – Fully automatic settings for shutter speed and aperture.

Manual – Full iris, shutter speed and range control

Shutter Automatic Exposure – The camera will measure light and automatically set the aperture based on the selected shutter speed.

Aperture Automatic Exposure – The camera will measure light and automatically set the shutter speed based on the selected iris opening (aperture).

Bright – Manual adjustment of the brightness level.

Please note that every exposure mode has different settings. The table below summarizes the correlated settings of all exposure modes.

	Auto	Manual	SAE	AAE	Bright
Gain Limit	√		√	√	√
Shutter		√	√		
DRC	√	√	√	√	√
Iris		√		√	
Gain		√			

Gain Limit

Setting the gain limit allows you to cap the maximum gain to a value in the range of 1 – 15dB.

Accessible when **Exposure Mode** is set to **Auto**, **SAE**, **AAE**, and **Bright**.

Shutter

Select shutter speed from the drop-down menu.

1/60, 1/90, 1/100, 1/125, 1/180, 1/250, 1/350, 1/500, 1/725, 1/1000, 1/1500, 1/2000, 1/3000, 1/4000, 1/6000, 1/10000

Accessible when **Exposure Mode** is set to **Manual** and **SAE**.

DRC

DRC sets the amount of Dynamic Range Compression where higher values lead to more compression (**1 – 8** or **off**).

Iris

The Iris drop down menu allows you to select the iris setting from the list below:

F1.8, F2.0, F2.4, F2.8, F3.4, F4.0, F4.8, F5.6, F6.8, F8.0, F9.6, F11.0

Accessible when **Exposure Mode** is set to **Manual** and **AAE**.

Gain

The Gain can be adjusted from 0 to 34.

Accessible when **Exposure Mode** is set to **Manual**.

White Balance (Page 1)

Indoor: For indoor video production.

Outdoor: For outdoor video production.

Auto: When Auto is chosen, you are allowing the camera to constantly read the tones in your scene and set the brightest part of your image as the white point. You will be allowed to fine tune red (**RGTuning**) and blue (**BGTuning**) gains from **-10 to 10** in this mode.

Manual: In this mode, you will allowed to manually set the camera's white balance by adjusting red and blue gains. RGain sets intensity of red color from 0 to 225. BGain sets intensity of blue color from 0 to 225.

OnePush: One time auto white balance.

VAR: Select VAR if you would like to manually select color temperature.

Color temperature measures the physical property of light in Kelvin (K), ranging from 2400K to 7100K with a step size of 100. It varies between different light sources.

The following table is a rule-of-thumb guide to the correlated color temperature of some common light sources.

Color Temperature	Light Source
1000 – 2000 K	Candlelight
2500 – 3500 K	Tungsten Bulb (household variety)
3000 – 4000 K	Sunrise/Sunset (clear sky)
4000 – 5000 K	Fluorescent Lamps
5000 – 5500 K	Electronic Flash
5000 – 6500 K	Daylight with Clear Sky (sun overhead)
6500 – 8000 K	Moderately Overcast Sky
9000 – 10000 K	Shade or Heavily Overcast Sky

Advanced Image Settings (Page 2)

Gamma

Use gamma correction for more natural look of images and the ability to differentiate between dark tones in a darker images.

Mirror

The H option flips the camera video image horizontally, and the V option does it otherwise. Select H+V if you would like to flip the image horizontally and vertically at the same time.

Anti-Flicker

To avoid video flicker, you can set your camera flicker frequency to **50 Hz** or **60 Hz**.

AGC

Also known as **Automatic Gain Control**. Enable AGC in low-light conditions.

3DNR

3D noise reduction is applied in static areas of the field of view.

- OFF
- 1 – 11
- Auto

WDR

Also known as wide dynamic range, often used in situations where there is a large difference in foreground and background light levels.

Video Output

As shown in the diagram below, select a resolution for the camera video.

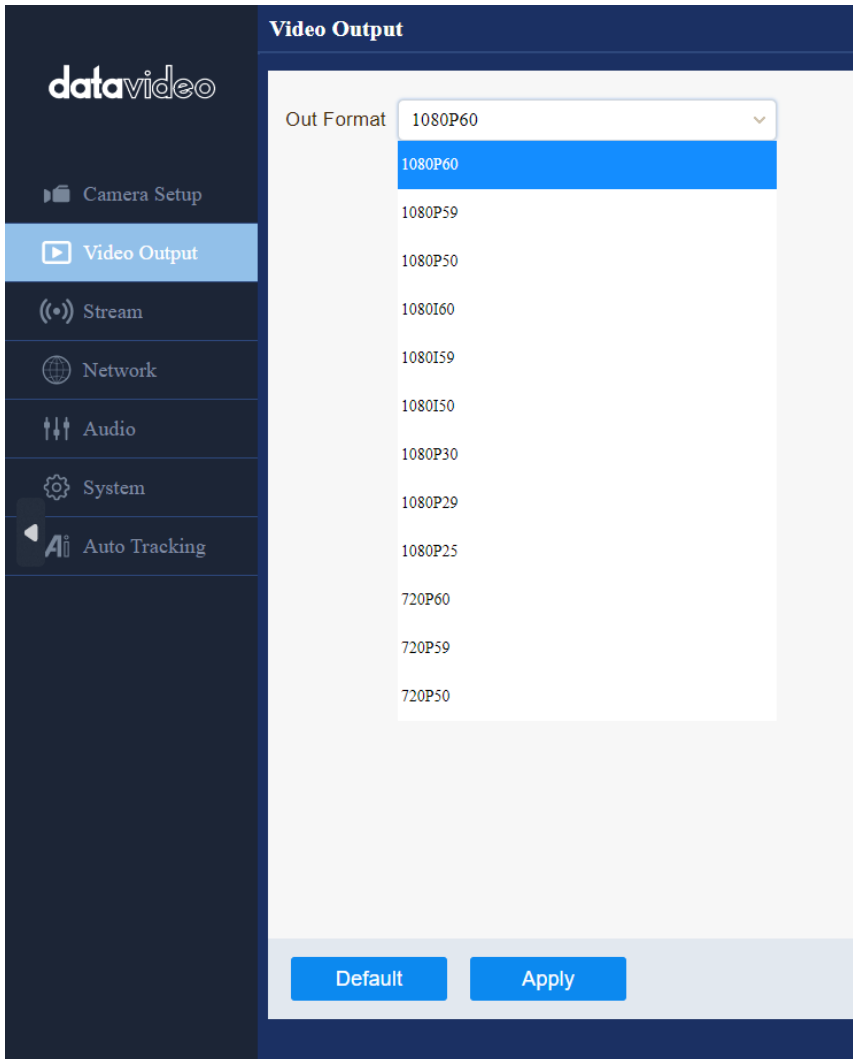

Stream

In this section, we will first show you all common streaming setup options then the settings specific to the respective streaming protocols.

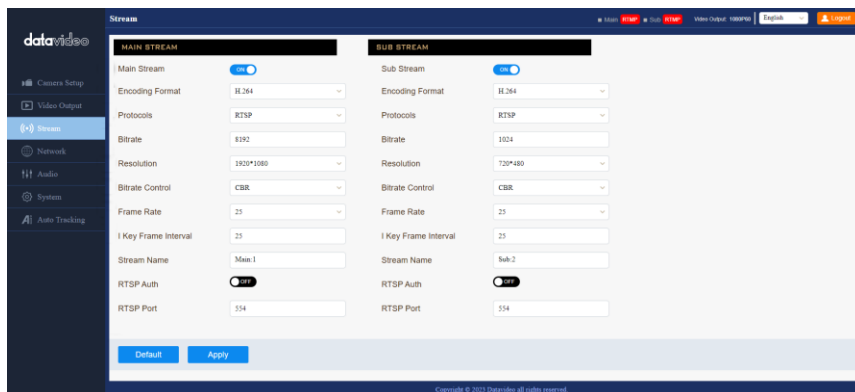

Encoding Format

First select either the H.264, H.265 or MPEG video codec after you've turned on the streaming server (main or sub).

If you're working with high-resolution video formats such as 4K and 8K, H.265 is the better choice due to its improved compression efficiency. However, if you're working with older devices or platforms that may not support H.265, or if you're streaming video over a limited bandwidth connection, H.264 may be the better option.

Protocol

Each streaming server offers the user multiple stream types. There are **RTP Multicast, RTSP, RTMP(S), SRT** and **ONVIF**.

Please note that when streaming, the server converts video into data, which are sent across an IP network. High bitrates consume more bandwidth across the IP network. In a gigabit office LAN, high bitrates may not be a concern and Speed/Bandwidth is therefore not a limitation.

If your available bandwidth is limited, you should reduce both your resolution and your bitrate accordingly. A good rule of thumb is for the bitrate of your stream to use no more than 50% of your available upload bandwidth capacity on a dedicated line. For example, if the result you get from a speed test shows

that you have 20Mbps of upload speed available, your combined audio and video bitrate should not exceed 10Mbps.

Bitrate

Enter the desired video bitrate for your video stream. The recommended video bitrates to use are listed as follows:

- 4,500 to 6,000 kbps for full HD videos with a high frame rate (1080p, 60fps)
- 3,500 to 5,000 kbps for full HD videos with a standard frame rate (1080p, 30fps)
- 3,500 to 5,000 kbps for HD videos with a high frame rate (720p, 60fps)
- 2,500 to 4,000 kbps for HD videos with a standard frame rate (720p, 30fps)

Resolution

Adjusting the image size is a critical step of encoder setup. It is best to either match your original video source or scale it down. For example, capture at HD 720 and stream at HD 720. Or capture at Full HD 1080 and stream at HD 720.

You should never be scaling up and streaming at a higher resolution than your original video source. For example, it does not make sense to capture at 720 and stream at 1080. Note that you will also have no gain in quality and you are using more bandwidth than is necessary for your viewers.

You should also be aware that higher resolutions require greater processing power to encode the stream. Attempting too high of a resolution on too little processing power can result in degraded image quality and corrupted or interrupted streams or recordings.

The available resolutions supported by main and sub encoders are listed in the table below:

Main Stream	Sub Stream
1920 x 1080	720 x 480
1080 x 720	640 x 480
	640 x 360
	320 x 240

Bitrate Control

There are two different bitrate types: CBR (constant) and VBR (variable). CBR is best for live streaming encoding and VBR is best for on-demand videos.

Frame Rate

Select a frame rate from the drop-down menu for video streaming. Note that frame rates should always match the frame rate of the video source. The default frame rate is 25.

Keyframe Interval

The keyframe interval in video encoding determines how often complete frames, called keyframes, are inserted into a video sequence. For live stream, a two-second keyframe interval is optimal, so if your frame rate is 30 fps, the keyframe interval would be every 60 frames.

Note: A short keyframe interval can result in stuttered playback.

Stream Name

Enter a name for your vide stream in the textbox.

RTP Multicast

RTP allows data transfer to multiple destinations through IP multicast in IP networks. Once selected, the device will automatically generate an RTP address and a port number which are respectively 224.1.2.3 and 4000 as depicted in the diagram below. Enter **rtp://224.1.2.3:4000** into the client device to view a live video streamed from the camera via RTP multicast.

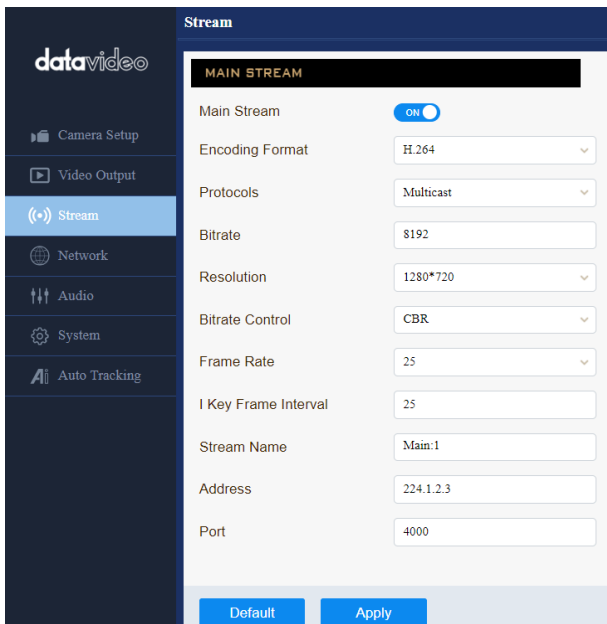

The screenshot shows the 'Stream' configuration page in the datavideo interface. The left sidebar contains navigation options: Camera Setup, Video Output, Stream (selected), Network, Audio, System, and Auto Tracking. The main content area is titled 'Stream' and features a 'MAIN STREAM' section. The 'Main Stream' toggle is turned ON. The configuration options are as follows:

Parameter	Value
Main Stream	ON
Encoding Format	H.264
Protocols	Multicast
Bitrate	8192
Resolution	1280*720
Bitrate Control	CBR
Frame Rate	25
I Key Frame Interval	25
Stream Name	Main:1
Address	224.1.2.3
Port	4000

At the bottom of the configuration area, there are two buttons: 'Default' and 'Apply'.

It is recommended to use VLC media player to view an RTP live stream. Open VLC on your PC, then click “Media” → “Open Network Stream”.

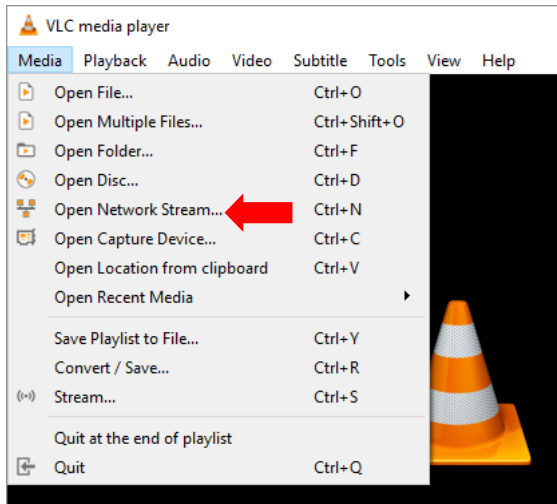

On the window that opens, enter **rtp://224.1.2.3:4000** as shown in the diagram below then click **Play** to start viewing.

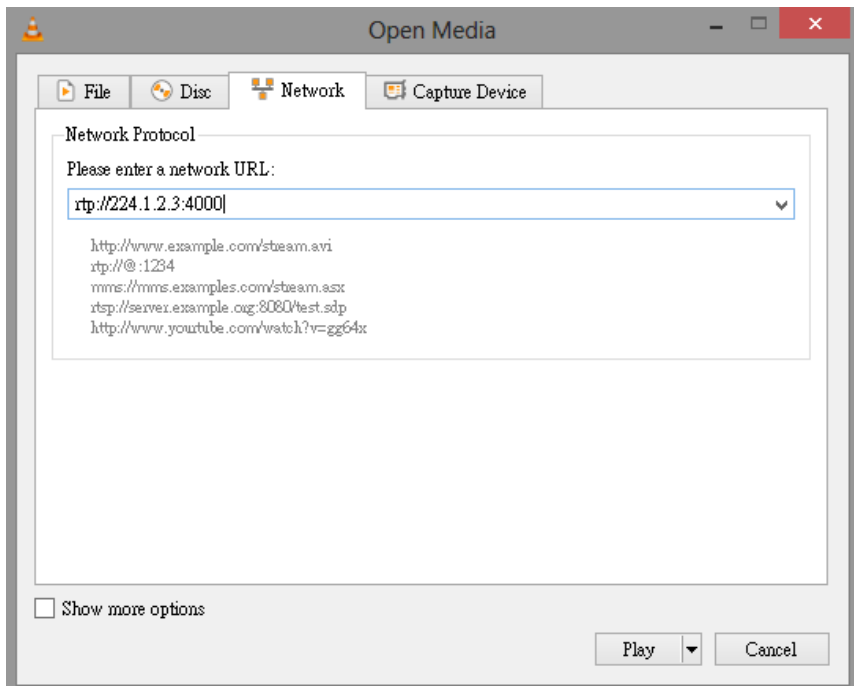

RTSP

RTSP (Real-Time Streaming Protocol) is a network protocol designed to transfer video over a network or to the internet with an easy-to-use link.

The default RTSP port number is 554. The alternate port number is 8551.

When RTSP Auth is enabled, only authorized users have access to the footage captured by the camera.

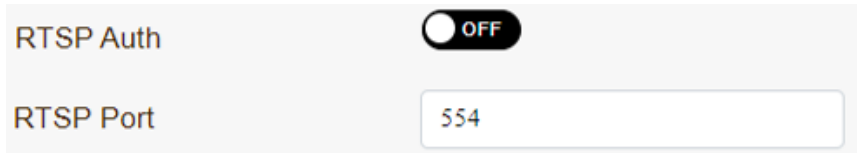

It is recommended to use VLC media player to view an RTSP live stream. Open VLC on your PC, then click “**Media**” → “**Open Network Stream**”.

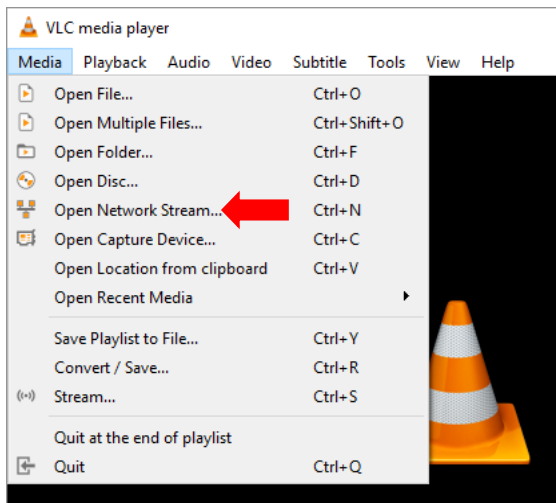

On the window that opens, enter **rtsp://IP address:554/channel number** as shown in the diagram below then click **Play** to start viewing.

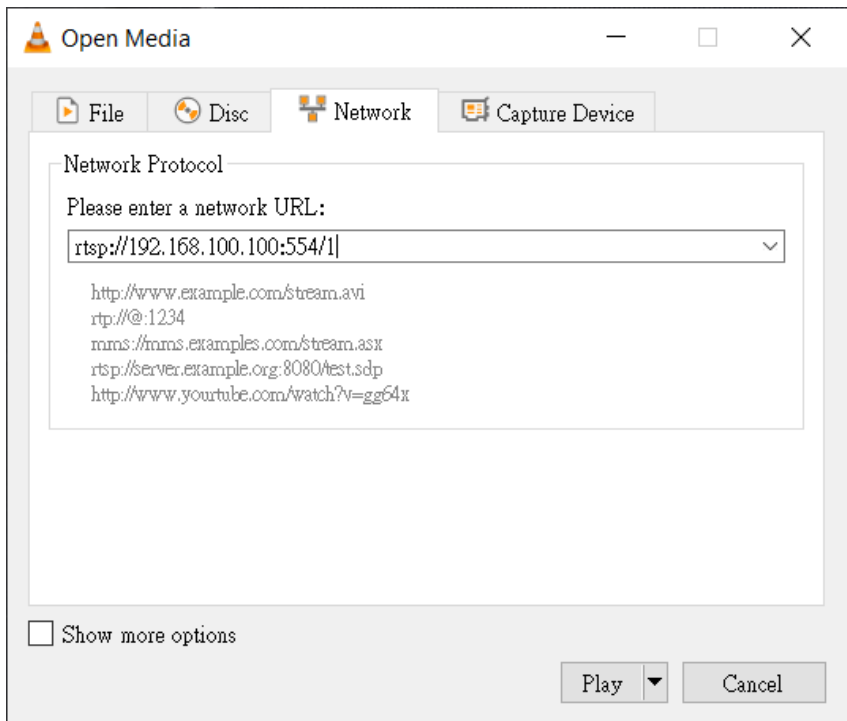

RTMP(S)

Real-Time Messaging Protocol (RTMP) is a communication protocol for streaming audio, video and data over the Internet. Use the guide in this section to learn about streaming live media and publishing streams.

After RTMP(S) is enabled, you will see an MRL textbox. In the textbox, enter an RTMP link (Server URL/Stream Name) to which your video will be published. The link is usually retrieved from a live streaming platform.

See the examples below to set up an **RTMP(S)** stream to **Facebook** and **Youtube**. Please note that Facebook Live limits each stream to 8 hours.

Facebook

1. Open Facebook Live by clicking the link below then click "Go Live Now".
<https://www.facebook.com/formedia/solutions/facebook-live>



Please note that you can also link to Facebook Live from your Facebook

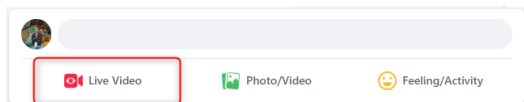

Personal Page or Facebook Fan Page by clicking “Live Video” as depicted on the right.

2. Select “Go live”.

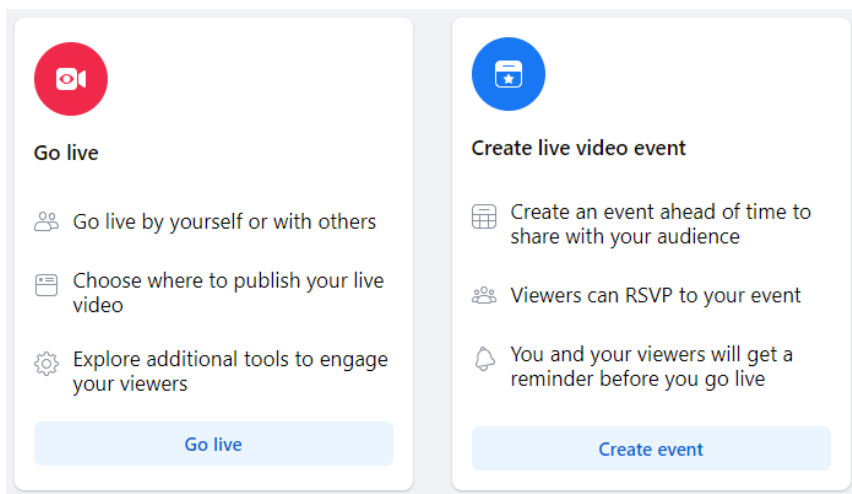

3. Select “Streaming software” where you will be able to find the server URL and the stream key. If you’d like, you can also enter the title and descriptions about this live stream.

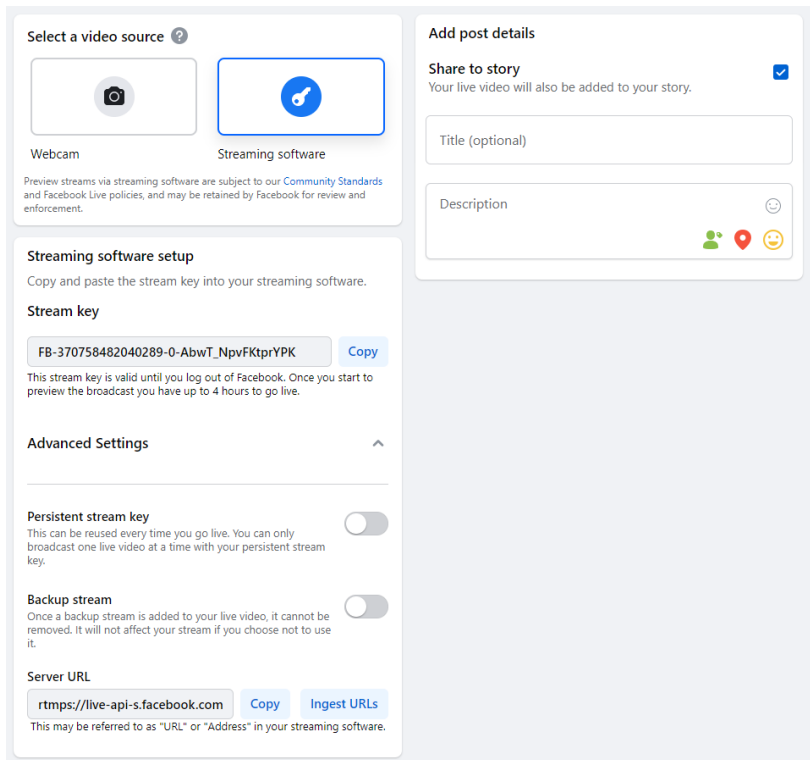

- Go back to the camera's web UI and as depicted in the diagram on the right, Enter "Server URL/Stream key" in the MRL textbox. In this example, we use the link retrieved at step 3, which is **rtmps://live-api-s.facebook.com:443/rtmp/FB-370758482040289-0-AbwT_NpvFKtprYPK**.
- Click the **Apply** button to activate the RTMP video stream. Make sure both audio and video are enabled.

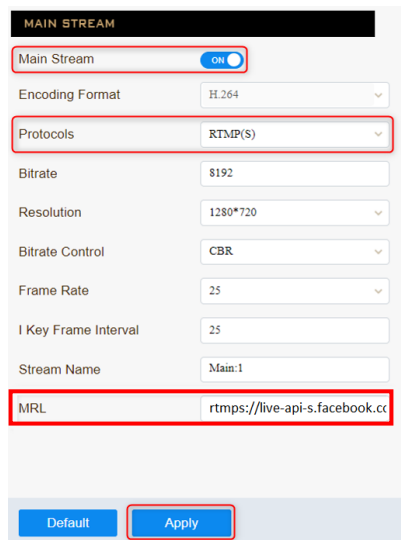

✔ Data Update Successful

The RTMP video stream is successfully activated when you see “Data Update Successful” appear at the bottom of the UI.

At the top right corner of the web UI, you should see that the main stream channel is now switched to RTMP(S) mode.

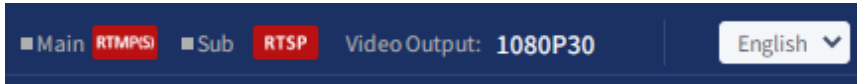

6. As shown in the diagram below, you can also preview the live camera video on Facebook Live.

Select a video source ?

Webcam Streaming software

Preview streams via streaming software are subject to our [Community Standards](#) and Facebook Live policies, and may be retained by Facebook for review and enforcement.

Streaming software setup

Copy and paste the stream key into your streaming software.

Stream key

FB-370758482040289-0-AbwT_NpvFKtprYPK Copy

This stream key is valid until you log out of Facebook. Once you start to preview the broadcast you have up to 4 hours to go live.

Advanced Settings

Add post details

Share to story

Your live video will also be added to your story.

Title (optional)

Description

Video

Expand video

Event logs

7. Before you activate the live stream on Facebook, on the left pane of Facebook Live, choose where and when you want to post your live video as well as the audience. Lastly, click the “Go live” button to start livestreaming of your camera video on Facebook.

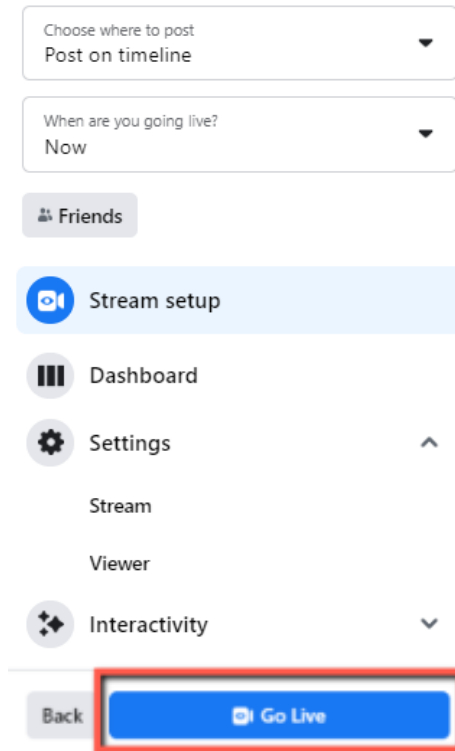

8. To end the live stream, simply click “End Live Video”.

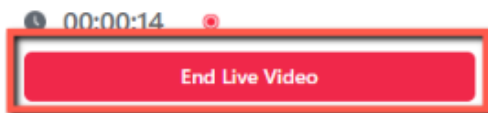

Youtube

1. Open the Youtube Live Control Room by clicking the link below:

https://www.youtube.com/live_dashboard

Alternatively, log in to your Youtube account, locate and click the camera icon at the top right corner, then select "Go live".

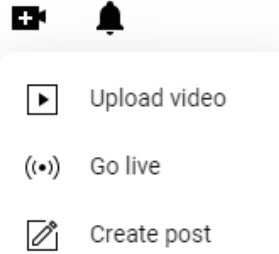

2. If this is your first time using **Youtube Live Control Room**, select "Right Now" on the pop-up prompt.

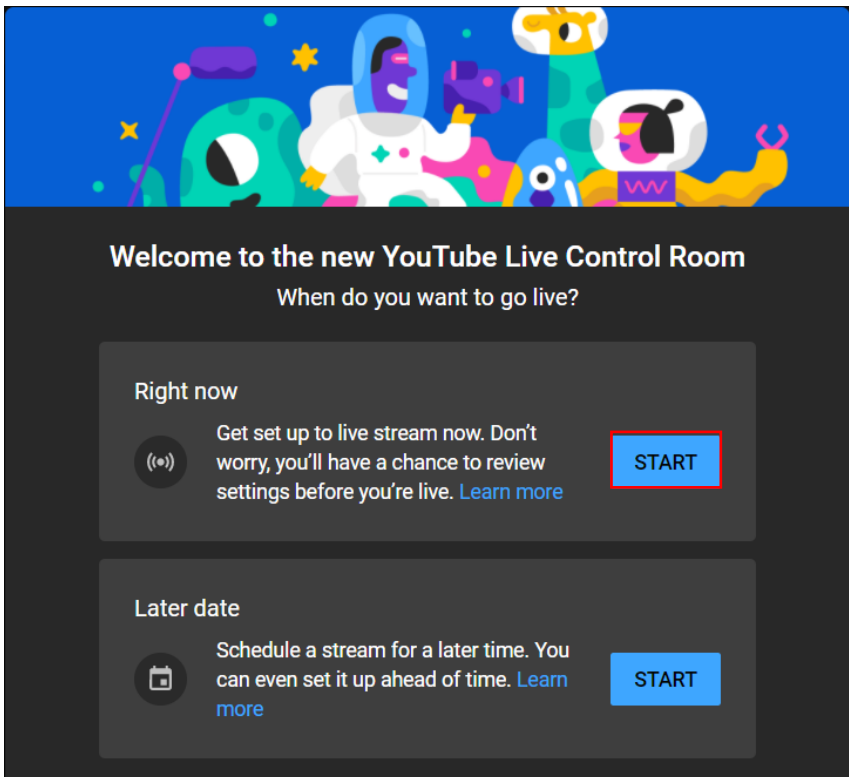

3. Select **Streaming Software**.

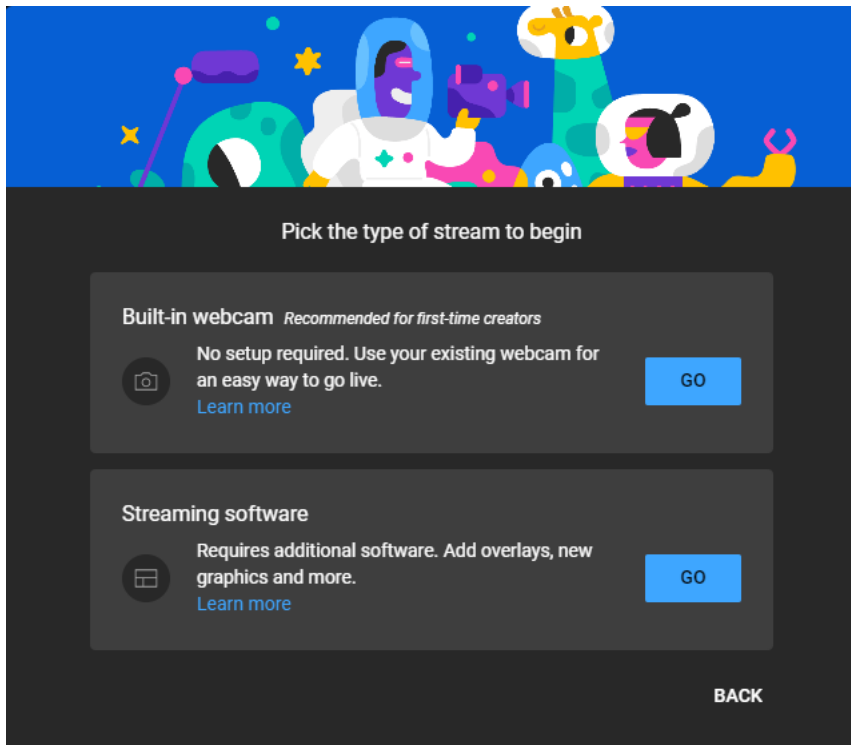

4. You will be able to find the server URL and the stream key in **Stream settings** pane of the Youtube Live Control Room. If you'd like, you can also click **Edit** to modify the stream information such as title and descriptions.

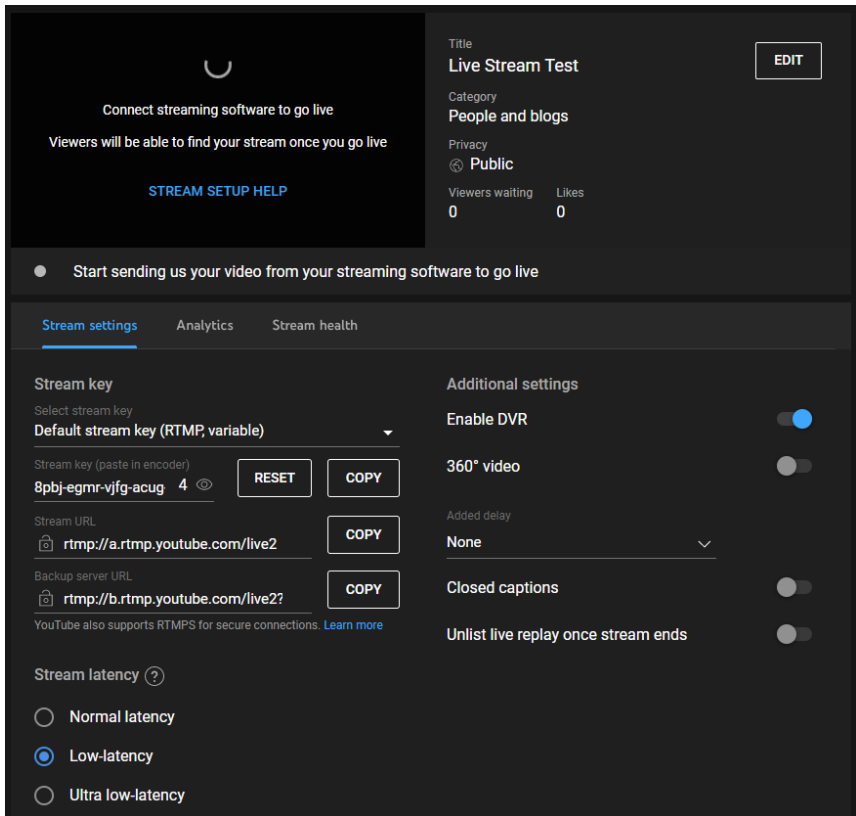

- Enter “Server URL/Stream key” which is **rtmp://a.rtmp.youtube.com/live2/8pbj-egmr-vjfg-acug-6vsc** in this example in the MRL textbox as depicted in the diagram on the right.
- Click the **Apply** button to activate the RTMP video stream. Make sure both audio and video are enabled.

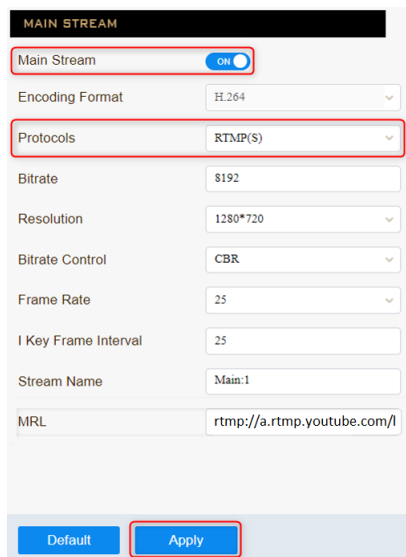

✓ Data Update Successful

The RTMP video stream is successfully activated when you see “Data Update

Successful” appear at the bottom of the UI.

At the top right corner of the web UI, you should see that the main stream channel is now switched to RTMP(S) mode.

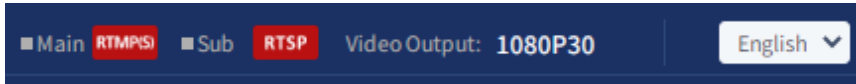

7. To end the live stream, simply click “END STREAM” which can be found at the top right corner of the Youtube Live Control Room.

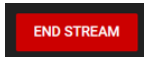

SRT

Read this section to learn how to establish a link between SRT source and destination devices.

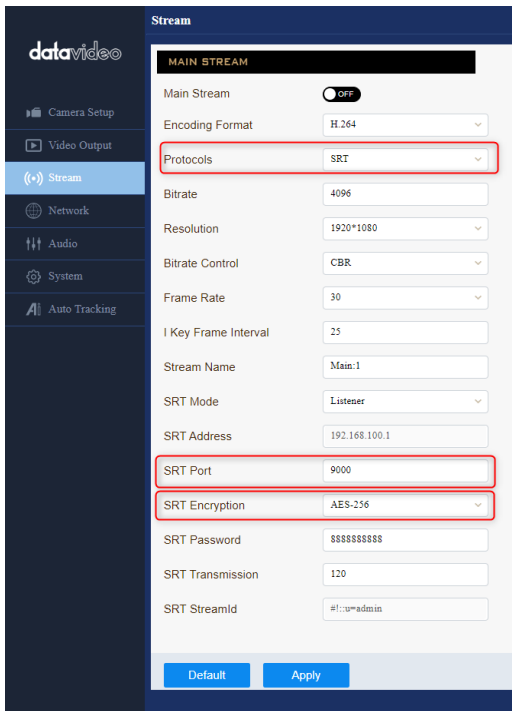

Caller and listener modes work together to establish the SRT link between source and destination devices. It is arbitrary to set one device to listener mode and the other to caller mode. Either can be the source device.

Common SRT parameters are described as follows:

Port number: Range is 1024 to 65535; default is 9000.

SRT Encryption: Options are 128/192/256 bit end-to-end AES encryptions to ensure that content is protected during streaming.

SRT Password: Enter a passphrase of 10 to 79 characters.

Please note that your stream is not encrypted by default. The encryption and the passphrase must be the same at both sender and receiver ends.

SRT Transmission: This sets the maximum buffer size for managing SRT packets; the value ranges from 20 to 8,000 ms. The default is 120 ms.

Stream ID: Enter a name for your video stream.

If Caller is selected, enter the IP address of the destination device (decoder) in the **Server** field. If your SRT stream destination is a CDN or media server, the IP address and the port number should be provided by the service provider.

If Listener is selected, the SRT address and the stream ID will be greyed out.

In the next two sections, we will show you how to establish an SRT link between the PTC-145 and a PC.

Install the vMix Software

Download and install the vMix software: <https://www.vmix.com/>

SRT Stream Setup on PTC-145 and vMix

The PTC-145/vMIX connection is bidirectional. Regardless of the caller-listener setup, either end can be the camera video source.

PTC-145 set to the Listener Mode

Open the web UI of the PTC-145 then the **Stream** page. Select **SRT** from the **Protocols** pull-down menu then set **SRT mode** to **Listener**. Use the default **SRT port** (9000). If necessary, you can set up **AES encryption** and a 10 digit **passphrase** for an SRT stream.

Lastly, click the **Apply** button to activate the SRT stream.

On the PC or laptop where the vMIX is installed, click Start Menu → vMix(x64) and you should see the interface below after the vMIX is opened.

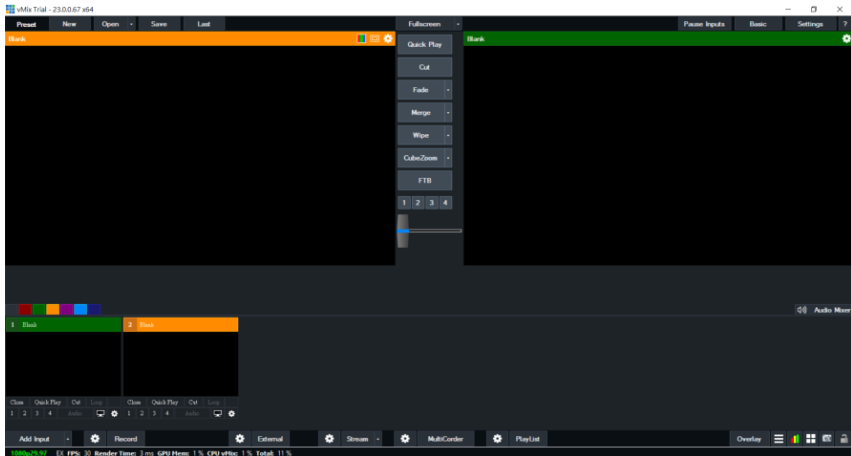

Click “Add Input” then “More”.

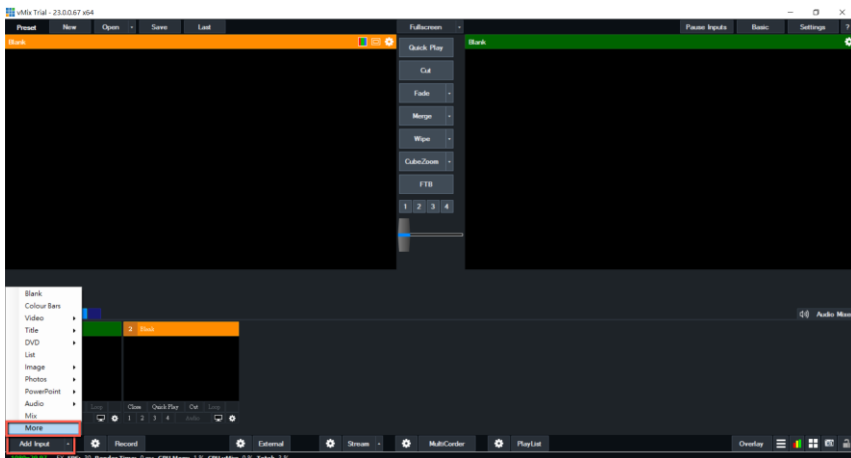

On the Input Select window, click “Stream/SRT” then select “SRT Caller” from the “Stream Type” drop-down menu. After that, enter the following into the respective fields.

- Hostname: 192.168.1.198 (The IP address of your connected device. In this case, it is the PTC-145)
- Port: 9000

- Passphrase: 1234567890 (The password set previously on the PTC-145's Web UI)
- Key length: 32

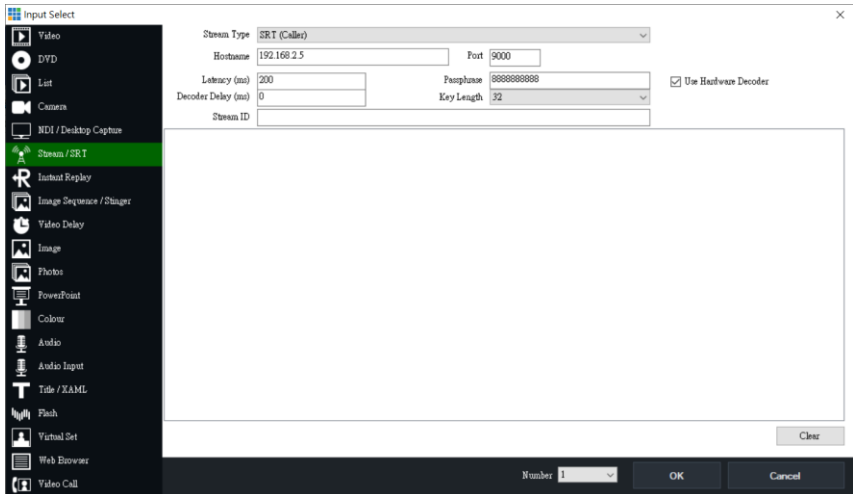

Click the “OK” button.

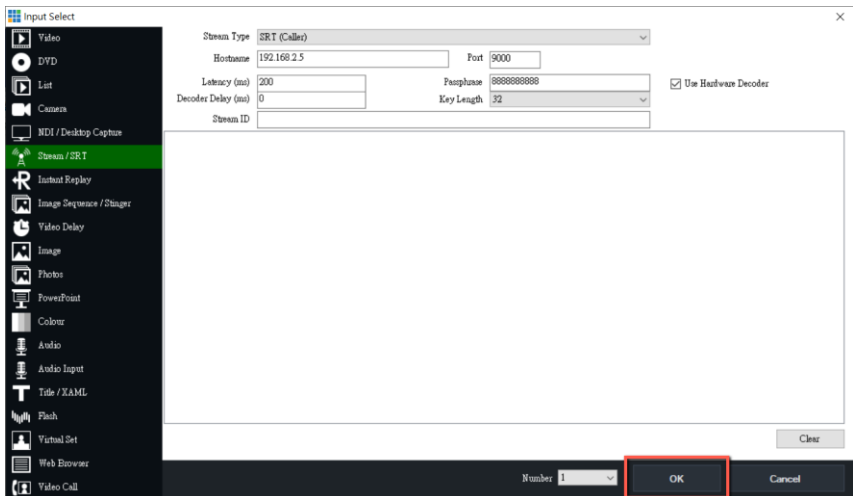

The PTC-145 camera video is now successfully streamed to the vMix via SRT.

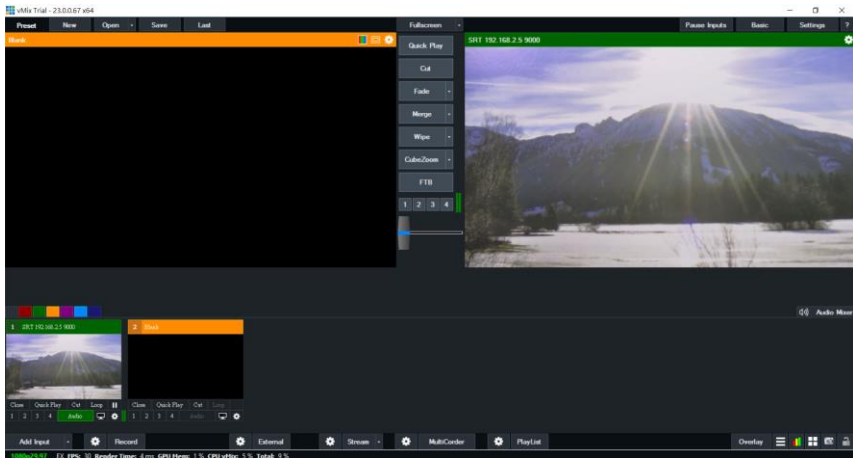

PTC-145 set to the Caller Mode

Open the web UI of the PTC-145 then the **Stream** page. Select **SRT** from the **Protocols** pull-down menu then set **SRT mode** to **Caller**. Enter the IP address of the PC/laptop on which the vMIX is installed. Use the default **SRT port** (9000). If necessary, you can set up **AES encryption** and a 10 digit **passphrase** for an SRT stream.

Lastly, click the **Apply** button to activate the SRT stream.

On the PC or laptop where the vMIX is installed, click Start Menu → vMix(x64) and you should see the interface below after the vMIX is opened.

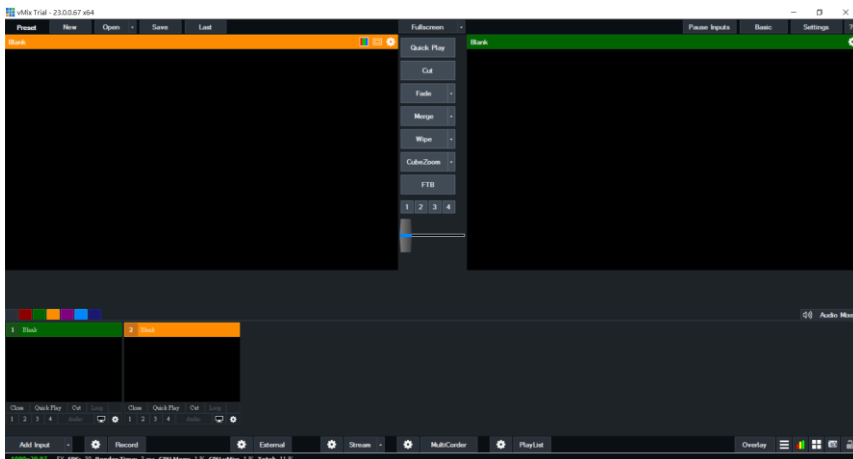

Click “Add Input” then “More”.

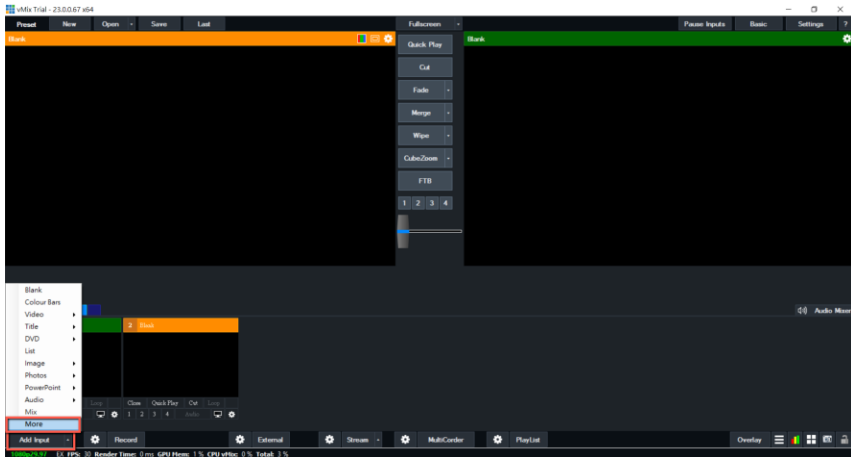

On the Input Select window, click “Stream/SRT” then select “SRT Listener” from the “Stream Type” drop-down menu. After that, enter the following into the respective fields.

- Port: 9000
- Passphrase: 1234567890 (Password for Stream Encryption)
- Key length: 32

Click the “OK” button.

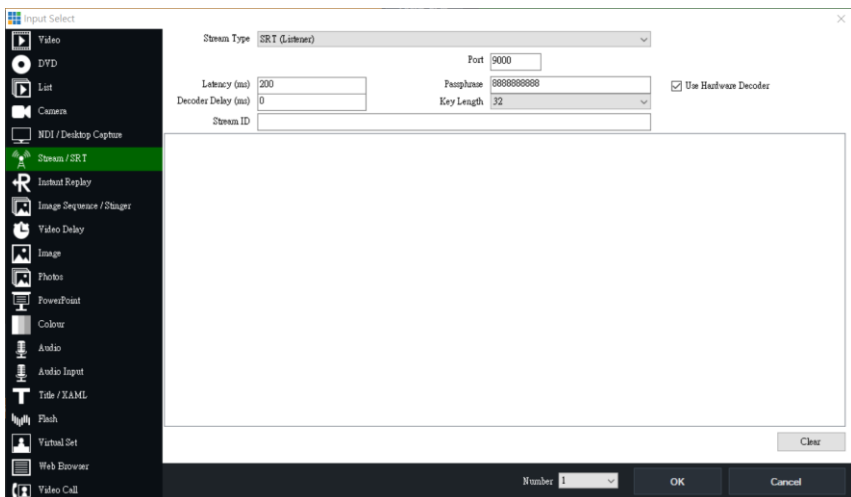

The PTC-145 camera video is now successfully streamed to the vMix via SRT.

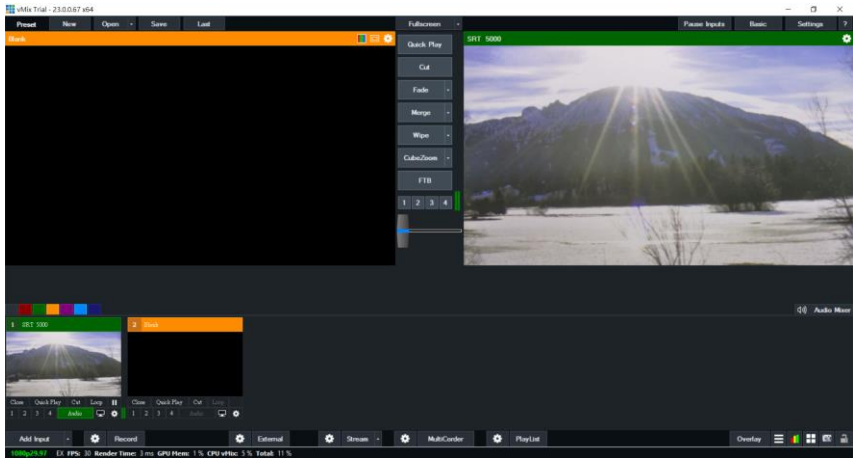

ONVIF

Enable ONVIF (Open Network Video Interface Forum) to make your PTC-145 ONVIF compliant in order to allow interoperability with devices from other manufacturers.

ONVIF Auth



Note: All ONVIF-enabled devices need to be connected to the same network.

Network

The PTC-145 uses DHCP to obtain an IP address over an Ethernet-based network by default. You can also configure the device to use a static IP address. In this section, we will show you how.

Network

DHCP OFF

IP Address

Subnet Mask

Default Gateway

Primary DNS

Secondary DNS

MAC Address

NTP Settings

Type

Time Zone

Ntp Server

Network Settings

First turn DHCP off then fill in the following fields.

IP address: Enter a static IP address.

Network Mask: Also known as the subnet mask.

Gateway: Enter a gateway IP.

You can also enter IP addresses of the primary and secondary DNS servers. They are however optional. The device's MAC address is shown below.

NTP Settings

NTP settings are configured manually. First select a time zone from the Time Zone drop-down menu then enter the domain name of your NTP server. The default NTP server is time.google.com.

Audio

You can connect an audio source to the PTC-145. Configure the LINE IN port on the Audio page.

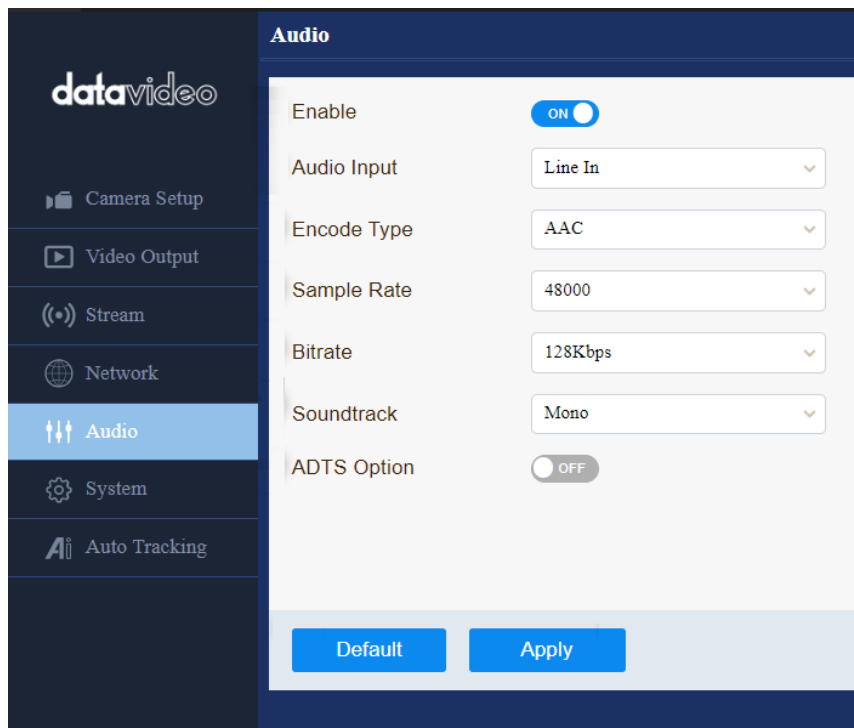

Audio Input

Select Line IN.

Encode Type

The audio encoding format is AAC by default.

Sample Rate

You can set the input audio sample rate to 48 kHz.

Bitrate

Select a bitrate (32K, 48K, 64K, 96K, 128K and 256K) for your audio input.

Soundtrack

Set the audio output to Mono or Stereo.

Please note, if Mono is selected, then for a stereo audio source, the left audio channel will be replicated onto the right audio channel. On the contrary, if the audio source is mono, only the left audio channel can be heard.

ADTS Options

Enable for streaming audio over the Internet.

System

The screenshot shows the 'System' configuration page in the datavideo interface. The sidebar on the left lists various settings: Camera Setup, Video Output, Stream, Network, Audio, System (highlighted), and Auto Tracking. The main panel is titled 'System' and includes the following fields and sections:

- Device Name:** PTC-145
- Language:** 中文(簡)
- Tally Mode:** Red/Green
- Firmware:**
 - Version: SOCv.2.1.9-ARMv2.1.3
 - File Path: [Empty field] with **Browse** and **Update** buttons.
- Account and Password:**
 - Admin Password: [Masked with dots]
- Buttons: **Factory Default** and **Apply**

Copyright ©

General

Camera Name

Enter a name for your camera.

Language

Select a preferred language for the web UI.

Tally Mode

Enable the tally mode by selecting either green or red. You can also select dual color mode (Red/Green). To disable the tally light, simply select OFF.

Red: The red tally light indicates that the camera is live (enabled for the program channel) and currently being used for the broadcast. It signals to the camera operator and talent that they are actively being recorded or broadcasted.

Green: The green tally light signifies that the camera is on standby (enabled for the preview channel). It indicates to the camera operator and talent that the camera will be the next in use for the broadcast.

Firmware

The current version of firmware installed will be shown here. To update the firmware, click the **Browse** button to search for the latest firmware file saved on the PC's hard disk. Click the **Update** button after the file is uploaded.

Account and Password

View and change the current password here.

Auto-Tracking

Configure the auto-tracking function on this page.

The screenshot displays the 'Auto Tracking' interface. At the top, a video feed shows three women at a desk. The camera control overlay includes buttons for 'Far', 'Tele', 'Fast', 'Near', 'Wide', 'Slow', 'AF', and a 'PRESET' dropdown set to '1'. Below the video feed is the 'IMAGE SETTING' section with the following options:

- Tracking: ON
- Track Mode: Presenter
- Auto Zoom: ON
- Auto Tilt: ON
- Detected Indicator: Default
- Tracking Start Position: Preset 1
- OSD Reminder: ON

On the right side of the 'IMAGE SETTING' section, there are additional controls:

- Figure Size: Full, Half Body, Close Up, Customized
- Size: A slider control with a 'Save' button.
- Figure Size Default: [Back to default](#)
- Select Subject: Left, Center, Right
- Placement: Left, Center, Right
- AT Speed: Fast, Mid, Slow

A 'Default' button is located at the bottom left of the configuration area.

Mode

In Presenter mode, the PTC-145 will start tracking as soon as a presenter is on the stage or in the camera view and stops when the presenter leaves the stage.

Auto Zoom

Enable auto zoom so that the camera zooms in/out automatically when the presenter is tracked.

Auto Tilt

Enable auto tilt so that the camera tilts automatically when the presenter is tracked.

Detected Indicator

Once enabled, the camera will detect the presenter and automatically pan, tilt and zoom to follow the targeted person.

Tracking Start Position

This sets the initial tracking position. Use the **Camera Control** panel to move the camera view to where you would like the tracking to begin, then select **Current Location** from the pull-down menu. You can also select **Preset 1** which is a pre-saved location.

OSD Reminder

When OSD reminder is enabled, you will see the following message prompt when auto-tracking is turned ON.

Auto Tracking : ON (Presenter Mode)

Figure Size

You can track **full body**, **half body** or **close-up** of the presenter.

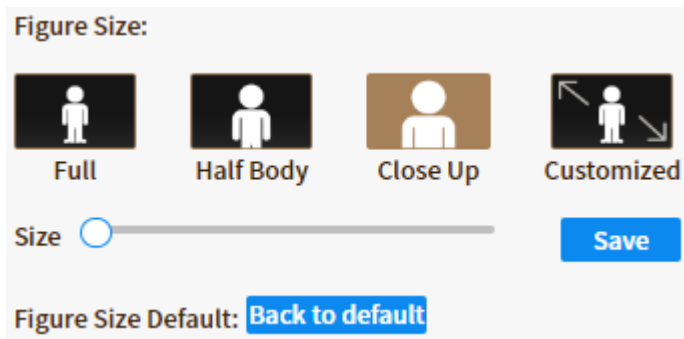

Select **Customized** if you would like to customize the tracking profile. Use the **Size** slider to adjust between 80 and 350. Use a smaller value if you would like track a closer view and use a larger value otherwise. Click the **Save** button to confirm.

To reset, simply click the **Back to Default** button.

Select Subject

When there are multiple targets, you can use the right and left arrow keys to switch between them. Click the **Select** button to confirm selection of the target.

Placement

As shown in the diagram below, you can keep the target to the left, in the center or to the right of the image while the camera tracks it.



AT Speed

You can set the auto-tracking speed to **slow**, **medium (mid)** or **fast**.

8. Remote Control

In addition to using the Ethernet port for remote control, you can also connect external controllers to the PTC-145 via the RS-422/485 interface or Wi-Fi.

RS-422/485

You can connect your PC or any keyboard controllers to the RS-422/485 remote port to control your PTC-145. Use an Ethernet cable and make your own cable using the pinout information provided in this section.



The RS-422/485 pinouts are shown below.

PTC-145 Camera (RS-422/485 Port)		
White/Orange	1	GND
Orange	2	NC
White/Green	3	RX-
Blue	4	TX-
White/Blue	5	TX+
Green	6	RX+
White/Brown	7	NC
Brown	8	NC

1/EXT

The 2-wire RS-485 pinouts are shown below.

PTC-145 Camera (RS-485 Port)		
White/Orange	1	GND
Orange	2	NC
White/Green	3	RX-/TX-
Blue	4	NC
White/Blue	5	NC
Green	6	RX+/TX+
White/Brown	7	NC
Brown	8	NC

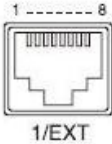

1/EXT

RS-232

You can also connect your PC or any keyboard controllers to the RS-232 remote port to control your PTC-145. Use an Ethernet cable and make your own cable using the pinout information provided in this section.



The RS-232 pinouts are shown below.

PTC-145 Camera (RS-232 Port)		
White/Orange	1	GND
Orange	2	NC
White/Green	3	NC
Blue	4	Transmit IN
White/Blue	5	NC
Green	6	Receive IN
White/Brown	7	Transmit OUT
Brown	8	Receive OUT

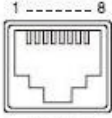

1/EXT

Wi-Fi



PTZ View Assist is an App designed by Datavideo for controlling up to 4 PTC-145 cameras using an Android or iOS device. Wirelessly connect your Android or iOS device to a wireless router and make sure the DVIP port of the camera is also connected to the same router. Depending on your network environment, you can either connect in DHCP mode or using a static IP address. See [Network Connection](#) of this manual for configuring your network.

For Android devices, please download PTZ View Assist from Google Play.

For iOS devices, please download PTZ View Assist from Apple Store.

WHITE BALANCE

AUTO ONE PUSH MANUAL R/B GAIN

FOCUS

AUTO MANUAL + -

IRIS

AUTO MANUAL + -

CAMERA CONTROL

ZOOM IN ZOOM OUT UNLOCK

FAST SLOW SPEED

PROTOCOL

RTSP SRT NDI

CAMERA

CAM A CAM B CAM C CAM D

POSITION

1 2 3 4 STORE

Model Name: PTC-140
IP: 192.168.100.100
Resolution/FPS: 1080p59.94



Connect Successfully

9. Firmware Update

Datavideo usually releases new firmware containing new features or reported bug fixes from time to time. Customers can either download the firmware as they wish or contact their local dealer or reseller for assistance.

This section outlines the firmware upgrade process which should take *approximately few minutes to complete*.

The existing settings should persist through the *firmware upgrade process, which should not be interrupted once started* as this could result in a non-responsive unit.

Ethernet Port

The DVIP port allows you to update the firmware from a remote location. You should connect the PTC-145 and your PC to a DHCP server. In the procedure outlined below, we assume you will be connecting in DHCP mode.

You can establish direct connection if you are using a static IP address.

Requirements

- PTC-145 Unit
- A PC/Laptop
- Latest firmware downloaded from <https://www.datavideo.com/product/PTC-145>
- Ethernet Cables and a router if the camera is set to DHCP

Procedure

1. With Ethernet cables, establish connection between the PTC-145 and a PC/Notebook via a router.
Note: Make sure the PTC-145's default connection mode is set to DHCP.
2. Unzip the downloaded file in which you should find the latest firmware file.
3. Open a web browser and enter the camera's IP address in the address bar.
4. On the web user interface that opens, click **System** then locate **Firmware** where the current version of firmware installed will be shown here.

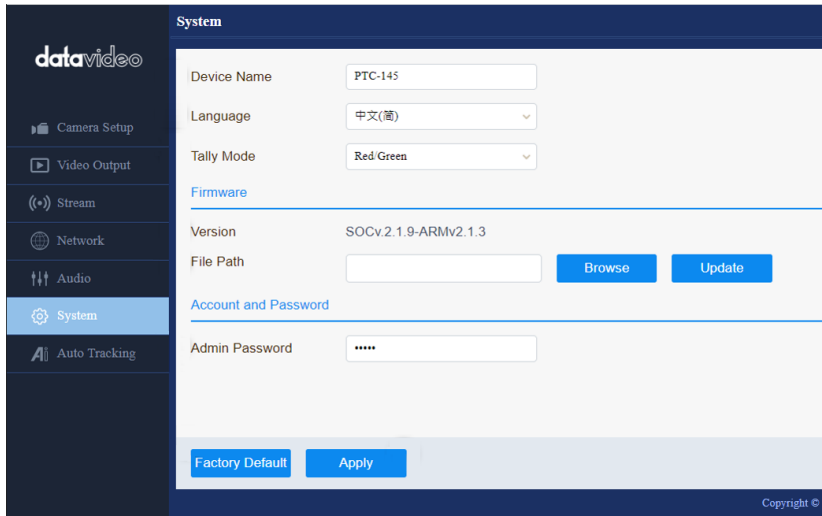

5. To update the firmware, click the **Browse** button to search for the latest firmware file saved on the PC's hard disk.
6. Click the **Update** button after the file is uploaded.

10. Frequently-Asked Questions

This section describes problems that you may encounter while using PTC-145. If you have any questions, please refer to related sections and follow all suggested solutions. If problem still exists, please contact your distributor or the service center.

No.	Problems	Solutions
1.	What are important points for product maintenance?	<ol style="list-style-type: none"> 1. If the camera will not be used for a long time, please unplug the 12V DC power plug, and remove AC power adapter from AC outlet. 2. Use soft cloth or tissue to clean the camera. 3. After washing the camera lens, dry it with a soft dry cloth. Use a neutral detergent rather than acidic or corrosive detergents to clean the lens.
2.	There is no output video.	<ol style="list-style-type: none"> 1. Check that your power is properly connected. This is indicated by the power LED. 2. Make sure the camera is switched ON with no issues. 3. Check your video cable connection.
3.	I have seen image jitter while zooming in or out.	<ol style="list-style-type: none"> 1. Make sure the camera is properly mounted. 2. Make sure that machines that could cause vibration are not in proximity of the camera.
4.	The camera's web UI cannot be opened using the IE browser.	Microsoft permanently disabled the Internet Explorer browser. Use other browsers such as Google Chrome, Safari and Microsoft Edge.
5.	The remote control is not working.	<ol style="list-style-type: none"> 1. Try setting the camera to CAM1 and try again. 2. Make sure the remote control's battery is fully charged. 3. Check your device working mode. 4. Make sure the OSD menu is closed.
6.	The serial port is not working properly.	<ol style="list-style-type: none"> 1. Make sure your baud rate and device address are correct. 2. Check your device working mode.

		3. Make sure the OSD menu is closed as the serial port is disabled if the OSD menu is active.
7.	I cannot log in to the Web UI.	1. Check your Ethernet connection. 2. Check your network settings such as IP address.

11. Dimensions

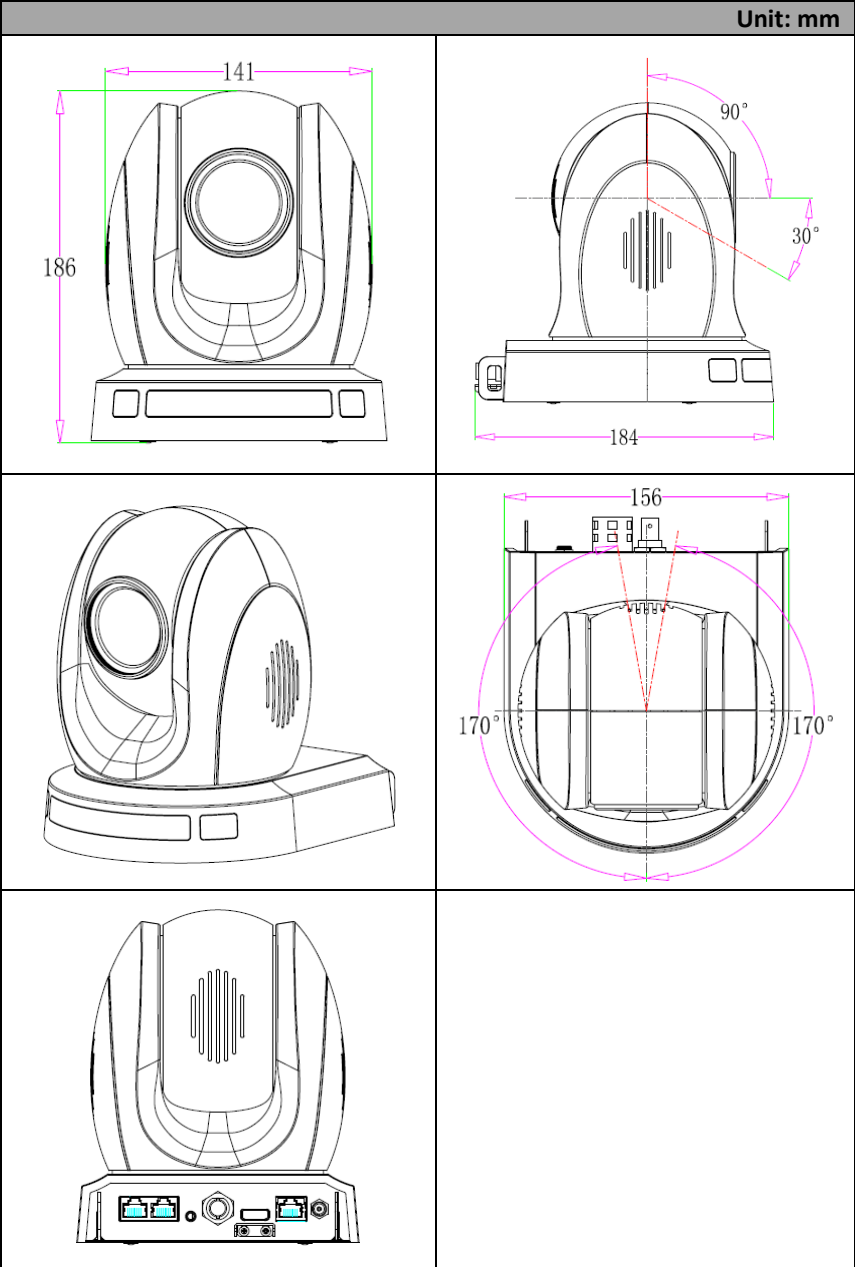

12. Specifications

Product Model	PTC-145
Product Name	HD Tracking PTZ Camera
Video format/Resolution	1080p 60/59.94/50/30/29.97/25 1080i 60/59.94/50 720p 60/59.94/50
Image Sensor	1/2.8 inch high quality HD CMOS sensor
Effective Pixels (approx.)	2.07 Mega pixels
S/N Ratio	≥50dB
Min. Illumination	0.5Lux (F1.8, AGC ON)
Electronic Shutter	1/30s – 1/10000s
Zoom Ratio	20x Optical Zoom 8x Digital Zoom
Gamma Control	N/A
Iris Control	Auto Manual
Digital Noise Reductions	3D
On-Screen Display (OSD)	English Traditional Chinese Simplified Chinese
White Balance	Auto/Indoor/Outdoor/Manual/One Push
AGC / Gain Control	Yes
HDR/WDR	N/A
Mirror / Flip Image	Yes
Focus Mode	Auto Manual
Panning / Tilting Range	Pan: 340° Tilt: +90° to -30°
Panning / Tilting Speed	Pan: 0.1~60°/sec Tilt: 0.1~30°/sec
Preset	255 Position
Focal Length	f = 5.05mm (wide) to 91.49 mm (tele) F1.8 (Wide) ~ F2.9 (Tele)
Field of View (Horizontal, Wide)	60°
Image Compensation	Backlight Compensation

Input/Output Interfaces	
Video Output	HDMI x 1 3G-SDI x 1 RJ-45 PoE x1
Audio Input	3.5mm Line in
Tally LED	Dual color (Red, Green)
Lens Filter	M52.0 x 0.75 Thread with UV Protection
Control Protocol	Pelco-D, Peldo-P VISCA, VISCA over IP DVIP, ONVIF
Remote Control Interface	IR Web GUI RS-422 /RS-232/RS-485 (RJ45)
Video Compression Format	H.264 H.265 MJPEG
Audio Compression Format	AAC G711
Audio Bitrate	96Kbps 128Kbps 256Kbps
HD IP Interface	10/100/1000M (RJ45)
Streaming Protocols	RTSP RTMP(S) ONVIF SRT (Caller & Listener) Multicast
First Stream Supported Resolution	1920x1080 1280x720 1024x576 960x540 640x480 640x360
Second Stream Supported Resolution	720x480 640x480 640x360 320x240
Video Bitrate	32Kbps ~ 50Mbps (Single Stream)
Video Bitrate Mode	VBR CBR

Encoding Frame rate	50Hz: 1-50fps 60Hz: 1-60fps
POE	IEEE 802.3af
F/W Update	Via Web UI
IR Control	Yes
Camera Control Unit	RMC-180 series RMC-300 series PTZ View Assist APP
Tripod Mount	1/4-20 UNC
Optional Accessories	WM-1 WM-10 WM-11
Color	Dark Blue White
Dimensions (LxWxH)	156 x 184 x 186 mm
Weight	1.6 Kg
Operating Temp. Range	0 – 40 °C
Storage Temp. Range	-10 – 60 °C
Power	DC 12V

Service & Support

It is our goal to make your products ownership a satisfying experience. Our supporting staff is available to assist you in setting up and operating your system. Please refer to our web site www.datavideo.com for answers to common questions, support requests or contact your local office below.

Please visit our website for latest manual update.

www.datavideo.com/product/PTC-145

datavideo
www.datavideo.com



@DatavideoUSA @DatavideoIndia2016
@DatavideoEMEA @Datavideojapan
@DatavideoTaiwan @DatavideoLatam
@DatavideoAsia @DatavideoBrasil



@Datavideo
@Datavideo_EMEA
@Datavideo_Taiwan



@DatavideoUSA
@DVTWDVCN



@DatavideoUSA
@DatavideoEurope

All the trademarks are the properties of their respective owners.