

Dell Premier Rechargeable Wireless Mouse



MS7421W

User's Guide

Regulatory model: MS7421Wc/RG-1216



Notes, Caution, and Warnings

-  **NOTE:** A NOTE indicates important information that helps you make better use of your computer.
-  **CAUTION:** A CAUTION indicates potential damage to hardware or loss of data if instructions are not followed.
-  **WARNING:** A WARNING indicates a potential for property damage, personal injury, or death.

Copyright © 2020 Dell Inc. All rights reserved. Dell, EMC, and other trademarks are trademarks of Dell Inc. or its subsidiaries. Other trademarks may be trademarks of their respective owners.

Contents

What's in the box	4
Features	5
Top view5
Bottom view6
Shortcut gestures7
Dell Peripheral Manager	8
Setting up your wireless mouse	9
Pairing your wireless mouse	11
Pairing with a USB device	11
Pairing your wireless mouse using Bluetooth	12
Pairing device three using Bluetooth	14
Charging your wireless mouse	16
Specifications	17
Troubleshooting	18
Statutory information	22

What's in the box

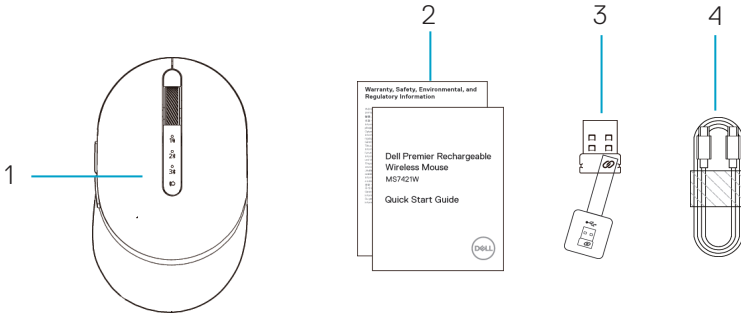

- 1 Wireless mouse
- 2 Documents

- 3 Dell Universal Dongle
- 4 USB-C cable for recharging



Features

Top view

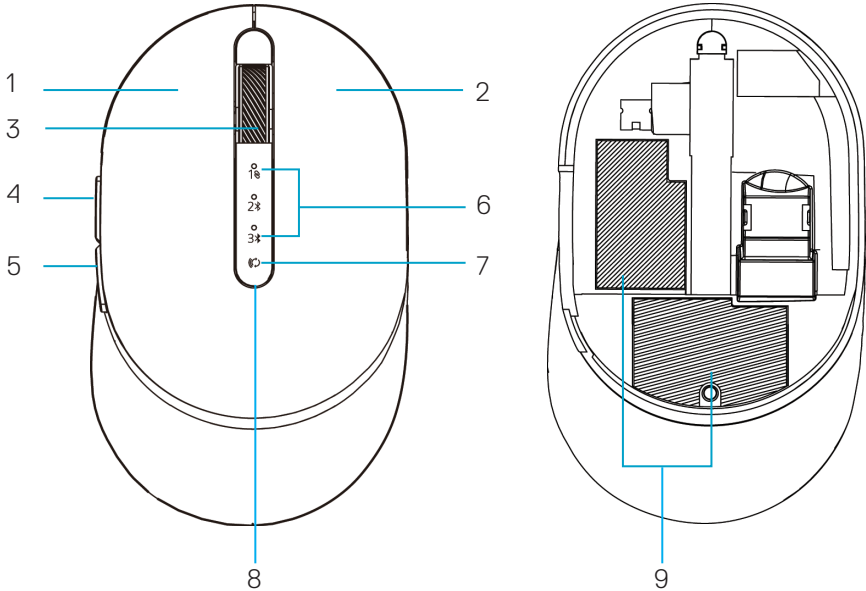

- | | | | |
|---|-----------------|---|---|
| 1 | Left button | 6 | Connection-mode lights |
| 2 | Right button | | • White LED blinking: device is not connected to computer |
| 3 | Scroll wheel | | • LED lighting solid white: device is connected to computer |
| 4 | Forward button | 7 | Connection-mode button |
| 5 | Backward button | 8 | Charging/low battery lights |
| | | | • White LED breathing: battery in charging |
| | | | • Amber LED pulsing: device battery is low, need to recharge. |
| | | 9 | PPID/Regulatory labels |



Bottom view

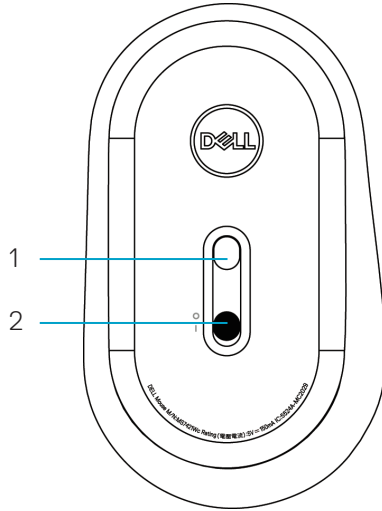

1 Optical sensor

2 Power switch



Shortcut gestures

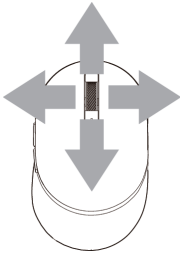

Scroll and Tilt

4-way scroll



Forward function

Press the front button on the side.

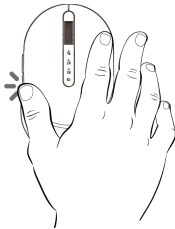

Backward function

Press the rear button on the side.



Dell Peripheral Manager

Dell Peripheral Manager software enables you to perform the following:

- Assign program shortcuts to device programmable buttons or keys through the Action tab.
- View device information such as firmware version and battery status through the Info tab.
- Upgrade the latest firmware updates on your devices.
- Pair additional devices through the Dell Universal Dongle or directly to your computer through Bluetooth.
- Change device DPI setting by selecting **Device Settings > DPI Setting** at the down-right corner of the window.
- Swap mouse button by selecting **Windows Settings > Primary Mouse Button** at the down-right corner of the window.

For more information, see *Dell Peripheral Manager User's Guide* on the product page at www.dell.com/support



Setting up your wireless mouse

1. Locate the slot on the side of the mouse cover. Using your fingertip, pry open the cover.

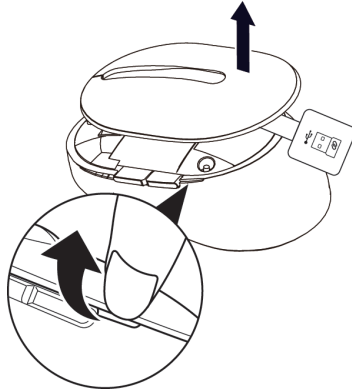

2. Remove the Dell Universal Dongle from its compartment.

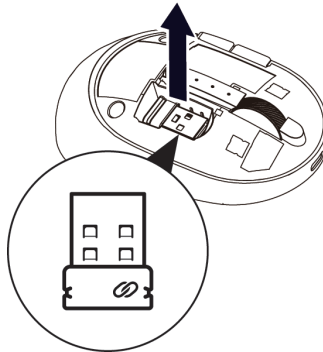

3. Replace the mouse cover.

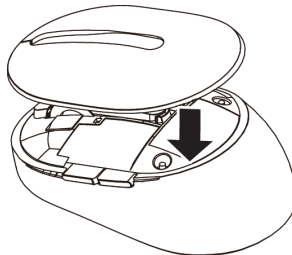

- Slide the power switch down to turn on the wireless mouse.

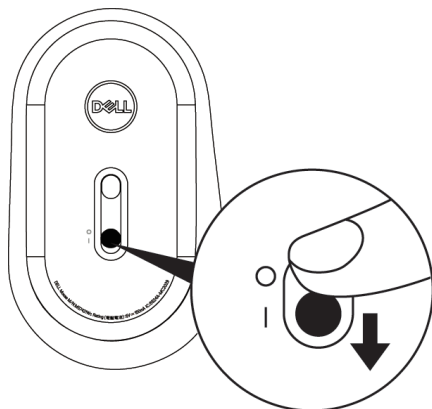

 **NOTE:** Ensure that the distance between your computer and mouse is within ten meters.



Pairing your wireless mouse

Your Dell wireless mouse can be paired via the Dell Universal Dongle or direct Bluetooth connection. You can pair and switch between a laptop, desktop, and a compatible mobile device.

Pairing with the Dell Universal Dongle

 **NOTE:** You can connect a device to your wireless mouse using the Dell Peripheral Manager.

1. Plug the Dell Universal Dongle into the USB port on your computer.

 **NOTE:** The Dell Universal Dongle is pre-paired with your wireless mouse in the factory.

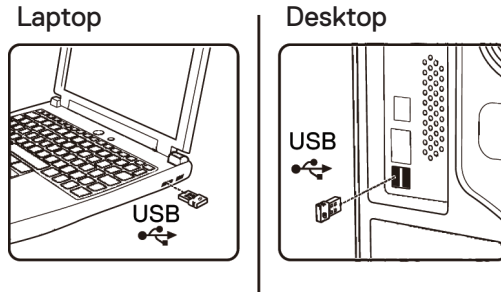

2. The connection-mode light (1) on the wireless mouse turns on to indicate the Dell Universal pairing, and then turns off.

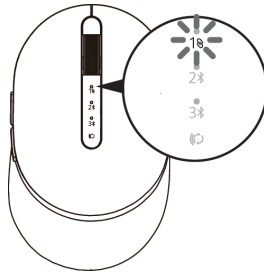

3. The wireless mouse is paired with your Dell Universal Dongle.

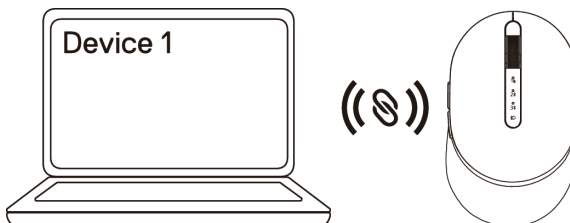

Pairing your wireless mouse using Bluetooth

You can connect up to two devices with your wireless mouse using Bluetooth.

NOTE: Before pairing your wireless mouse using Bluetooth, ensure that you unpair the inactive devices on your computer, and update the Bluetooth driver to the latest version on your computer. For more information, see [Drivers & Downloads at https://www.dell.com/support](https://www.dell.com/support)

1. Press the connection-mode button twice on your wireless mouse (within 3 seconds) until the connection-mode light (2) turns on indicating that the second Bluetooth connection is selected.

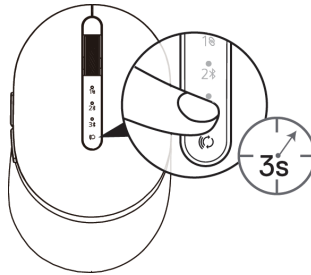

2. The connection-mode light (2) blinks for 3 minutes, indicating your wireless mouse is in the pairing mode.

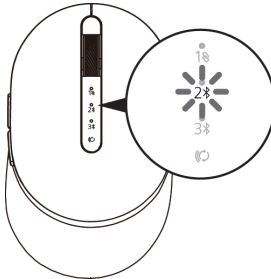

3. Pair your wireless mouse with your Bluetooth-enabled computer.

Swift Pair:

- a. In Windows Search, type **Bluetooth**.
- b. Click **Bluetooth and other devices settings**. The **Settings** window appears.
- c. Ensure that the “Show notifications to connect using Swift Pair” box is checked.

Show notifications to connect using Swift Pair

When selected, you can connect to supported Bluetooth devices quickly when they're close by and in pairing mode.



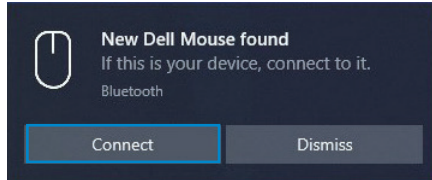

- d. Ensure that the Bluetooth is turned on.
- e. Place your wireless mouse near your computer. The **New Dell Mouse** found window appears.
- f. Click **Connect** and confirm the pairing process on both wireless mouse and your computer.

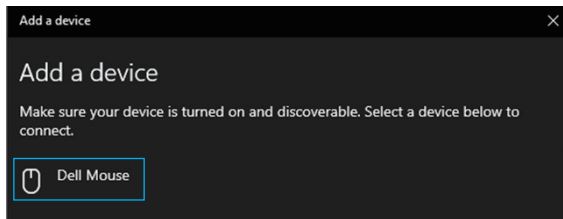

Add Device:

- a. In Windows Search, type **Bluetooth**.
- b. Click **Bluetooth and other devices settings**. The **Settings** window appears.
- c. Ensure that the Bluetooth is turned on.
- d. Click **Add Bluetooth or other device > Bluetooth**.
- e. From the list of available devices, click **Dell Mouse**.



 **NOTE:** If Mouse MS7421W is not listed, ensure that the pairing mode is enabled on the wireless mouse.

4. Confirm that both the wireless mouse and the device are paired. The second Bluetooth connection light turns solid white for 3 seconds to confirm the connection is established, and then turns off. After the wireless mouse and a device are paired, they connect automatically when Bluetooth is enabled and they are within Bluetooth range.

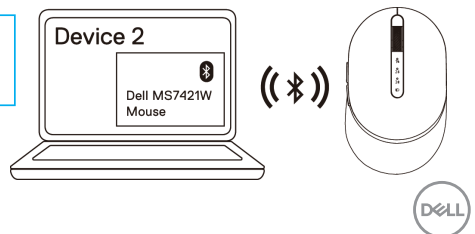
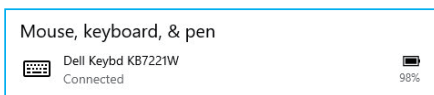

Pairing device three using Bluetooth

 **NOTE:** You can connect a third device to your wireless mouse using Bluetooth.

 **NOTE:** Before pairing your wireless mouse using Bluetooth, ensure that you unpair the inactive devices on your computer, and update the Bluetooth driver to the latest version on your computer. For more information, see [Drivers & Downloads at https://www.dell.com/support](https://www.dell.com/support)

1. Press the connection-mode button twice on your wireless mouse (within 3 seconds) until the connection-mode light (3) turns on indicating that the third Bluetooth connection is selected.

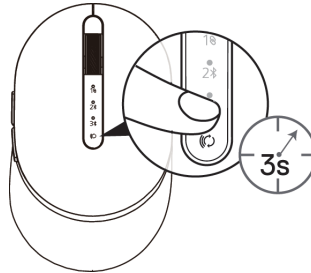

2. The third Bluetooth connection light (3) starts blinking to confirm the pairing mode is enabled.

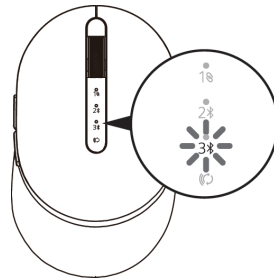

3. Pair your wireless mouse with your Bluetooth-enabled computer.

Swift Pair:

- a. In Windows Search, type **Bluetooth**.
- b. Click **Bluetooth and other devices settings**. The **Settings** window appears.
- c. Ensure that the “Show notifications to connect using Swift Pair” box is checked.
- d. Ensure that the Bluetooth is turned on.

Show notifications to connect using Swift Pair
When selected, you can connect to supported Bluetooth devices quickly when they're close by and in pairing mode.



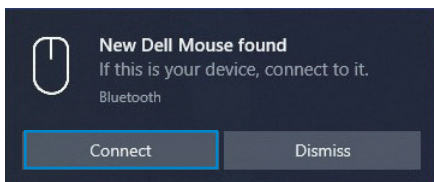

- e. Place your wireless mouse near your computer. The **New Dell Mouse** found window appears.
- f. Click **Connect** and confirm the pairing process on both wireless mouse and your computer.

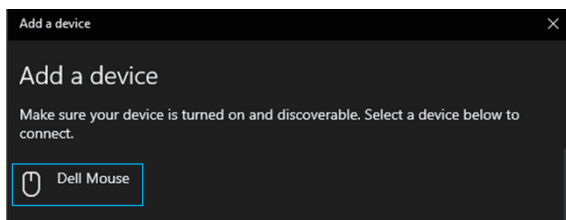

Add Device:

- a. In Windows Search, type **Bluetooth**.
- b. Click **Bluetooth and other devices settings**. The **Settings** window appears.
- c. Ensure that the Bluetooth is turned on.
- d. Click **Add Bluetooth or other device > Bluetooth**.
- e. From the list of available devices, click **Dell Mouse**.



 **NOTE:** If Mouse MS7421W is not listed, ensure that the pairing mode is enabled on the wireless mouse.

4. The third Bluetooth connection light turns solid white for 3 seconds to confirm the connection is established then dims off. After the wireless mouse and a device are paired, they connect automatically when Bluetooth is enabled and they are within Bluetooth range.

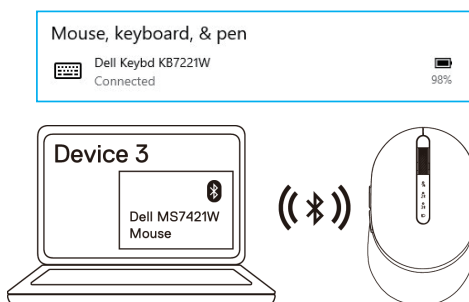

Charging your wireless mouse

1. When the amber LED of mouse blinks, you need to charge your wireless mouse.

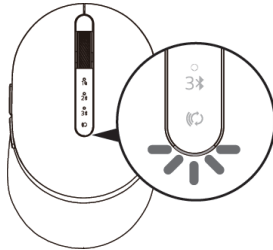

2. Connect the USB-C cable to your wireless mouse.

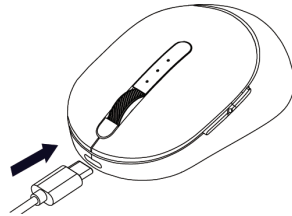

3. Connect the USB-C cable to your laptop or desktop computer

Laptop

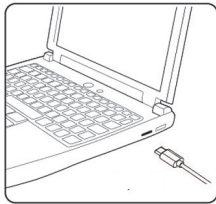

Desktop

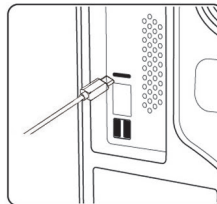

4. Battery charging

The battery LED will be breathing white to indicate charging and will turn solid white for 10sec to indicate charge completed

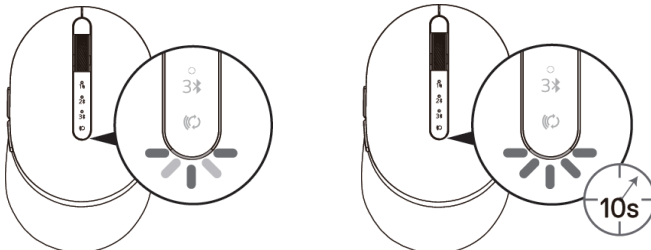

Specifications

General

Mouse model number	MS7421W
Connection type	2.4 GHz Wireless & Bluetooth dual mode technology
Supported operating systems (2.4 GHz)	<ul style="list-style-type: none">• Windows 10/8/7/XP• Server 2008/Server 2012• Linux 6.x, Ubuntu, Free DOS,• Chrome and Android• MAC OS
Supported operating systems (Bluetooth)	<ul style="list-style-type: none">• Windows 10/8• Chrome and Android• MAC OS

Electrical

From USB host (Operating)	5 V
Battery Voltage (Operating)	3.6 V to 4.2 V
Battery Life	Approximately 6 months
Battery Requirements	Li-ion polymer Battery

Physical characteristics

Weight	80.20 g +/-3 g (with dongle)
Dimensions:	
• Length	101.76 mm (4.0 in.)
• Width	61.88 mm (2.44 in.)
• Height	35.44 mm (1.40 in.)

Environmental

Temperature:	
• Operating	0°C to 40°C (32°F to 104°F)
• Storage	-40°C to 65°C (-40°F to 149°F)
Storage humidity	95% maximum relative humidity; non-condensing

2.4 GHz/BLE Wireless

Radio Transmission	Bi-directional communication (Transceiver)
Range	Up to 10 meters



Troubleshooting

Problems	Possible causes	Possible solutions
Unable to use the wireless mouse	The white LED indicator at top of the wireless mouse does not light up when the wireless mouse is turned on.	<ol style="list-style-type: none">1. Check the battery level. This mouse uses a rechargeable battery, please ensure that the battery is fully charged.2. Turn the wireless mouse off, and then turn on again. Check if the battery status light amber pulsing for 5 sec then dim off, flashing amber, indicating that the battery power is low. If the battery is fully depleted, the battery-status light will not turn on.3. Ensure that the Dell Universal Dongle is directly connected to your computer. Avoid using the port replicators, USB hubs, and so on.4. Change the USB port. Insert the Dell Universal Dongle into another USB port on your computer.



Problems	Possible causes	Possible solutions
Unable to pair the wireless mouse to the computer using Bluetooth	The Bluetooth icon on the computer does not light up when connecting the wireless mouse to the computer.	<ol style="list-style-type: none"> <li data-bbox="658 240 1037 408"> 1. Check the battery level. This wireless mouse uses a rechargeable battery, please ensure that the battery is fully charged. <li data-bbox="658 443 1037 703"> 2. Turn the wireless mouse off, and then turn it on again. Check if the battery-status light is flashing amber, indicating that the battery power is low. If the battery is fully depleted, the battery-status light will not turn on. <li data-bbox="658 730 1037 762"> 3. Restart your computer. <li data-bbox="658 790 1037 879"> 4. Check the operating system is Windows 10/Windows 8/Chrome/Android. <li data-bbox="658 906 1037 1110"> 5. Ensure that the wireless mouse is set to Bluetooth Low Energy (BLE) mode in your computer. For more information, see the documentation that came with your computer. <li data-bbox="658 1166 1037 1398"> 6. Turn off then on, and then turn on the Bluetooth. Low Energy (BLE) mode in your computer. For more information, see the documentation that came with your computer.



Problems	Possible causes	Possible solutions
Mouse pointer does not move	The wireless mouse pointer is not responding	<ol style="list-style-type: none"> 1. Check the battery level This wireless mouse uses a rechargeable battery, please ensure that the battery is fully charged.
Left/right buttons does not work	No response when the left or right mouse button is pressed	<ol style="list-style-type: none"> 2. Turn the wireless mouse off, and then turn it on. Check if the battery-status light is flashing amber ten times, indicating that the battery power is low. If the battery is fully depleted, the battery-status light will not turn on. 3. Restart your computer.
Unable to pair the wireless mouse with the computer	Wireless pairing error message is received while pairing the wireless mouse with the computer	<ol style="list-style-type: none"> 1. Check the battery level. This wireless mouse uses a rechargeable battery, please ensure that the battery is fully charged.



Problems	Possible causes	Possible solutions
Unable to pair the wireless mouse with the computer	Wireless pairing error message is received while pairing the wireless mouse with the computer	<p>2. Turn the wireless mouse off, and then turn it on again.</p> <p>Check if the battery-status light is flashing amber ten times, indicating that the battery power is low. If the battery is fully depleted, the battery-status light will not turn on.</p> <p>3. Restart your computer.</p>
Wireless connection is lost	Previously paired mouse no longer works on the computer	<p>1. Ensure that the Dell Universal Dongle is connected directly to your computer.</p> <p>Avoid using the port replicators, USB hubs, and so on.</p> <p>2. Change the USB port.</p> <p>Insert the Dell Universal Dongle into another USB port on your computer.</p>



Statutory information

Warranty

Limited warranty and return policies

Dell-branded products carry three-year limited hardware warranty. If purchased together with a Dell system, it will follow the system warranty.

For U.S. customers:

This purchase and your use of this product are subject to Dell's end user agreement, which you can find at **Dell.com/terms**. This document contains a binding arbitration clause.

For European, Middle Eastern and African customers:

Dell-branded products that are sold and used are subject to applicable national consumer legal rights, the terms of any retailer sale agreement that you have entered into (which will apply between you and the retailer) and Dell's end user contract terms.

Dell may also provide an additional hardware warranty—full details of the Dell end user contract and warranty terms can be found by going to **Dell.com**, selecting your country from the list at the bottom of the “home” page and then clicking the “terms and conditions” link for the end user terms or the “support” link for the warranty terms.

For non-U.S. customers:

Dell-branded products that are sold and used are subject to applicable national consumer legal rights, the terms of any retailer sale agreement that you have entered into (which will apply between you and the retailer) and Dell's warranty terms. Dell may also provide an additional hardware warranty—full details of Dell's warranty terms can be found by going to **Dell.com**, selecting your country from the list at the bottom of the “home” page and then clicking the “terms and conditions” link or the “support” link for the warranty terms.

