

IMPACT 700 series

On-ear wired USB headset

User Guide

Contents

Welcome	3
Package contents	4
IMPACT 700 at a glance	5
Icons at a glance	5
Headset at a glance.....	5
Inline controller at a glance	7
How to wear the headset.....	10
Adjusting and wearing the headset	10
Positioning the microphone.....	10
How to connect	11
A Connecting directly to your computer	11
B Connecting to your mobile device.....	12
Installing the EPOS Connect desktop app	13
Changing audio settings – Microsoft® Windows	13
How to use – basic functions	14
Changing the volume.....	14
Muting the headset’s microphone.....	16
Making calls using the headset	17
Making a call.....	17
Accepting / rejecting a call	18
Putting a call on hold (pause).....	20
Ending a call.....	21
Managing multiple calls.....	22
Using Microsoft® Teams – IMPACT 7xOT only.....	24
Invoking Microsoft® Teams.....	25
Raising hand in a Teams meeting.....	25
Checking Teams Notifications.....	26
Listening to media	27
Controlling via the wear detection sensor	27
Controlling via the button	28

Good to know.....	29
Activating / deactivating sensor functions.....	29
Adjusting the Sidetone.....	30
Changing the voice prompts' language.....	30
Adjusting sounds and notifications.....	31
Enabling / disabling an Audio Limiter.....	32
Maintaining & updating products.....	33
Cleaning the products.....	33
Transporting and storing the products.....	34
Replacing the ear pad(s).....	35
Updating the firmware.....	36
If a problem occurs.....	37

Trademarks

USB Type-C® and USB-C® are trademarks of USB Implementers Forum.
All other trademarks are the property of their respective owners.

Welcome

Ensure customer satisfaction on every call with a headset that delivers rich, natural sound no matter the level of background noise. Three digital microphones built on EPOS BrainAdapt™ provide industry-leading voice pickup to let your agents be heard.

Carefully crafted to provide an unprecedented level of comfort and agent well-being, with a lightweight design and soft memory foam earpads engineered for all-day wear. Help your agents stay productive and avoid fatigue.

The ergonomic call controller is conveniently placed just below the headset. Smart features that mute and unmute calls through intuitive gestures, help agents handle more calls with greater efficiency. Compatible with leading contact center platforms and UC providers, the IMPACT 700 is an easy plug-and-play solution.

Key benefits & features

Industry-leading voice pickup for natural-sounding calls

Enjoy exceptional call clarity with three beamforming mics powered by EPOS AI™ that suppress noise and transmit natural voice.

Stay Comfortable Throughout the day

Lightweight headset for next level comfort with soft, leatherette earpads crafted for all-day wear to ensure agent well-being.

Ergonomic inline controller for frictionless calls

Effortlessly answer calls, mute the mic, and change volume with an intuitive inline controller that's always where you need it.

Built for laser-sharp focus in busy work environments

Stay focused on the customer with passive noise dampening, incoming speech clarity, and ActiveGard™ acoustic shock protection.

Backed by exclusive 3-year extended warranty

Get peace of mind with a product that is engineered to withstand prolonged heavy use and truly built to last for years.



For safety instructions, consult the Safety Guide.



For specifications, consult the Fact sheet available at eposaudio.com



A list of accessories can be found on the product page at eposaudio.com

Package contents





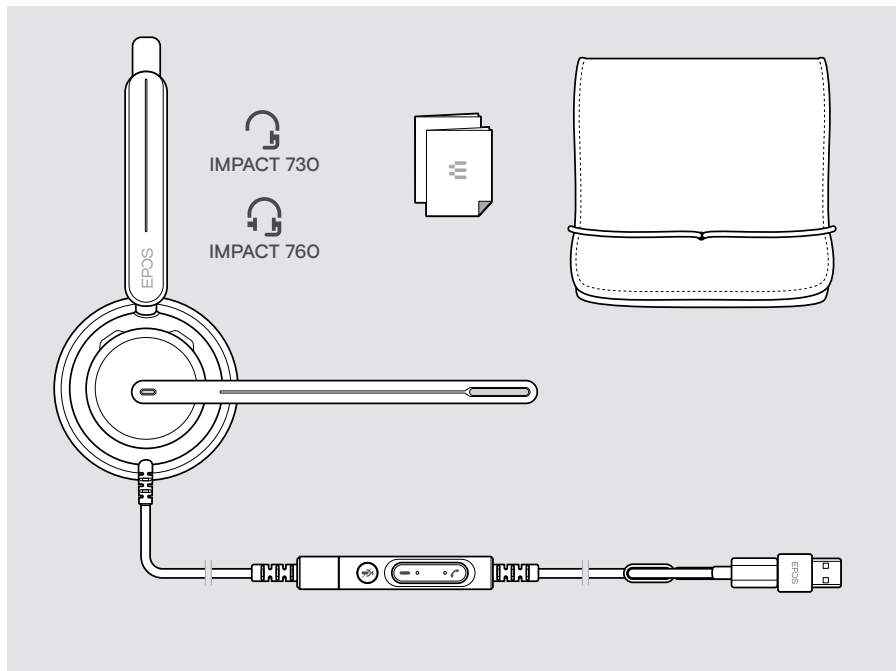

IMPACT 730 | IMPACT 760

IMPACT 730T | IMPACT 760T: Microsoft Teams version



IMPACT 700 at a glance

Icons at a glance

	<p>Tap the button</p>		<p>Notes: Good to know</p>
	<p>Double tap the button</p>		<p>LED indications</p>
	<p>Press and hold the button</p>		<p>You hear a voice prompt or tone</p>

Headset at a glance

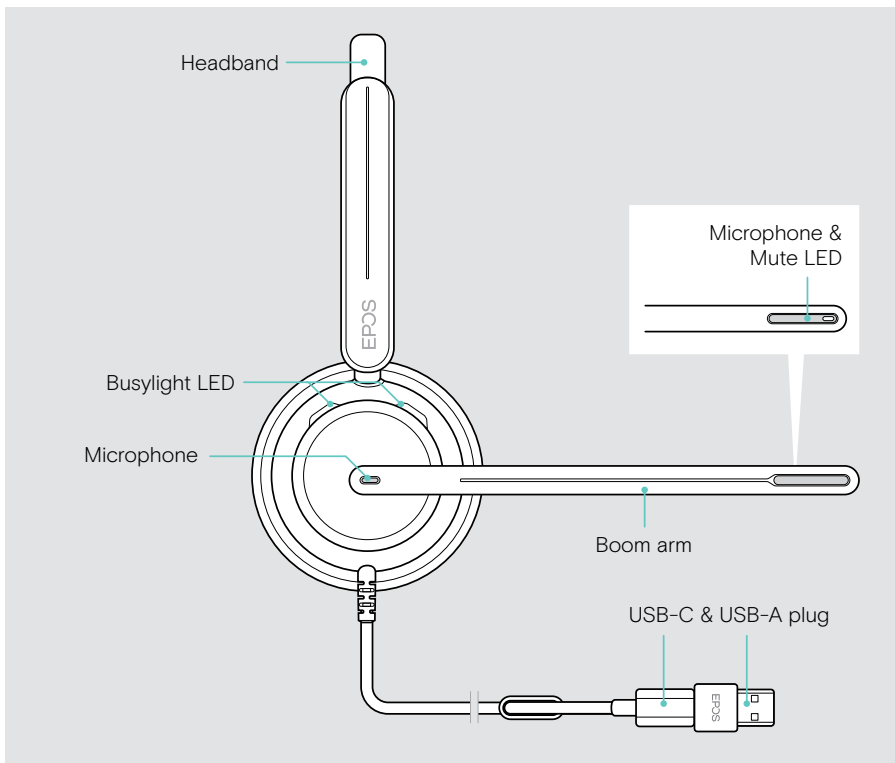

Headset LEDs at a glance

Busylight LED

Meaning

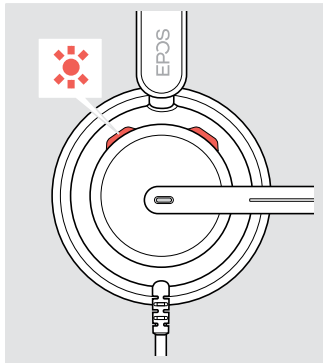

1x 

Headset switches on



Incoming call



Active call

Mute LED at boom arm

Meaning

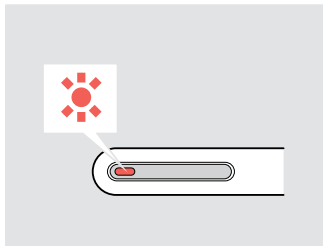

1x 

Headset switches on



Microphone muted



Talking while microphone is muted

Boom arm functions at a glance

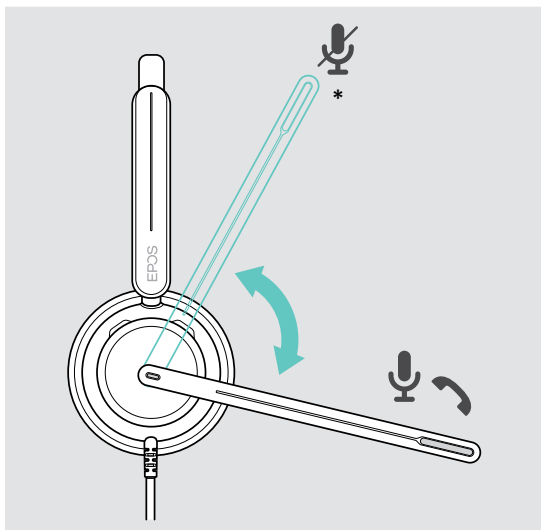

Lift boom arm:

- Mutes the microphone

Lower boom arm:

- Unmutes the microphone
- Accepts an incoming call

*This function can be activated/deactivated via EPOS Connect.

Inline controller at a glance

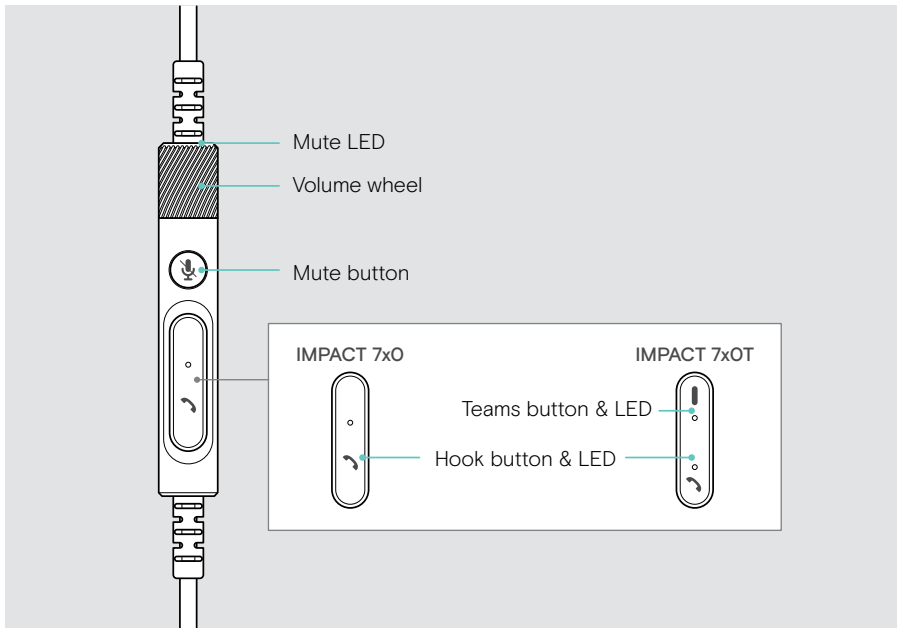

Inline controller LEDs at a glance

Hook LED

Meaning

<p>IMPACT 7xO</p> <p>IMPACT 7xOT</p>	<p>↓ ● ● ● ● ... Incoming call</p> <hr/> <p>● Active call</p> <hr/> <p>● Call on hold</p> <hr/> <p>Multiple calls: <ul style="list-style-type: none"> • Incoming call • Active call • Call on hold </p> <p>↓ ● ● ● ● ...</p>
--------------------------------------	--

Teams LED (IMPACT 7xOT)

Meaning

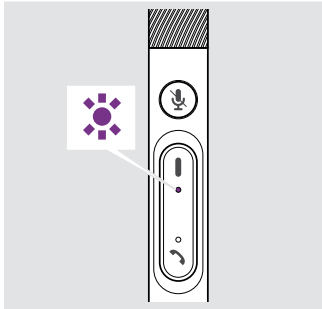

	Connected to Teams
	Teams notification
	Connecting to Teams

Mute LED

Meaning

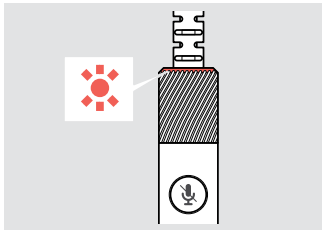

	Microphone muted
	Talking while microphone is muted

Inline controller buttons at a glance

Hook button

Press

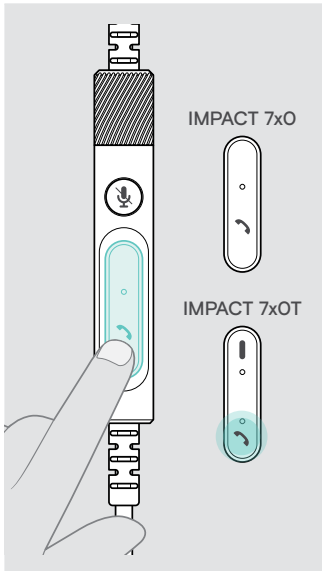

Function

Page



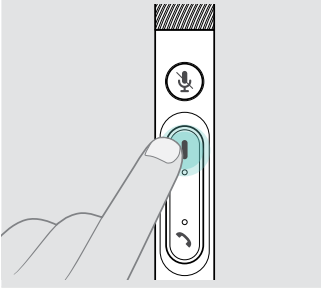

Press	Function	Page
	Accepts a call	18
	Ends a call	21
	2 calls: Answers incoming & ends active call	22
	2 calls: Ends active and keeps 2nd call on hold	23
	Puts an active call on hold (pause) / unholds call	20
	2 calls: Answers incoming & puts active call on hold	22
	2 calls: Toggles between two calls	23
	Rejects a call	20
	2 calls: Rejects incoming and keeps active call	23

**Teams button
(IMPACT 7xOT)**

	Press	Function	Page
		Invokes Microsoft Teams	24
		Raises/lowers hand in a Teams meeting upon release	25

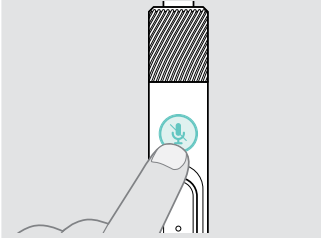
Mute button

	Press	Function	Page
		Mutes / unmutes the microphone	16
		Starts / pauses audio playback	27

Volume wheel

	Turn	Function	Page
		Increases the volume	14
		Decreases the volume	14

How to wear the headset

Adjusting and wearing the headset

For good sound quality and best possible wearing comfort:

- > Adjust the headset so that the ear pads rest comfortably on your ears.
- > Rotate the boom arm to change wearing side. Swap the stereo channels via [EPOS Connect](#).

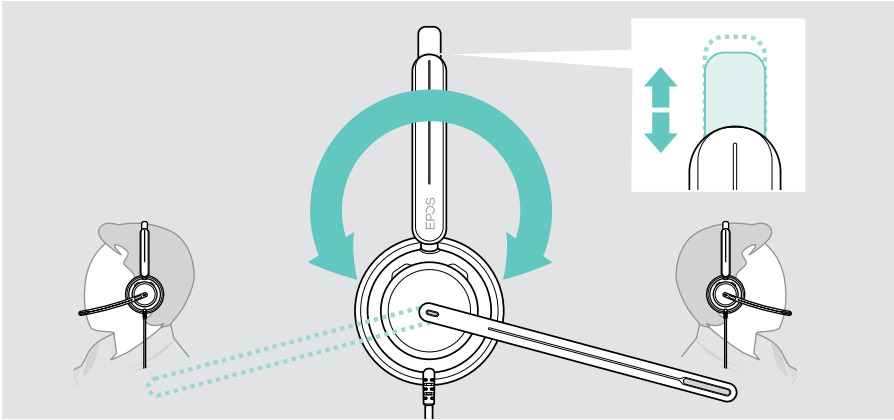

Positioning the microphone

- > Bend and rotate the boom arm so that the microphone is about 0.8" (2 cm) from the corner of your mouth for best call quality.

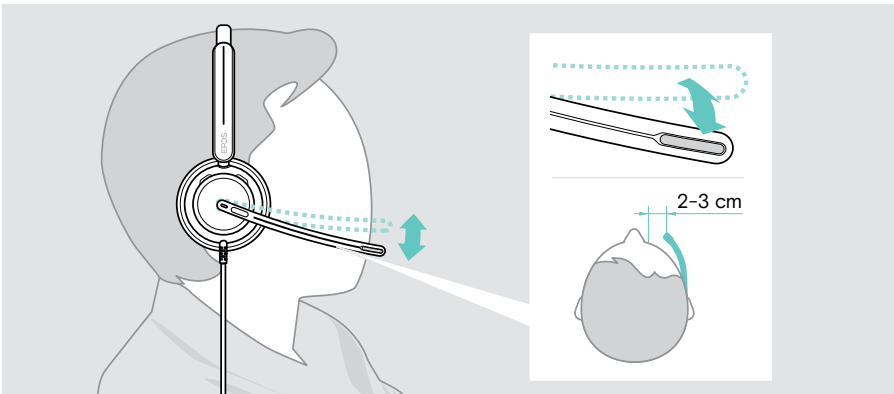

How to connect

You can connect the headset either:

- **A** directly to your computer **or**
- **B** to your mobile device

You can completely remove and reattach the USB-A adapter from the USB cable. To remove the USB-A adapter:

- > Disconnect the adapter from the USB-C plug.
- > Push the USB plug through the small opening at the end of the rubber holder.

A Connecting directly to your computer

- > Attach or detach the USB-A adapter.
- > Plug the headset into a **USB-C** **or** **USB-A** port of your computer. The Busy light LED and the mute LED at the boom arm tip light up shortly when powered.

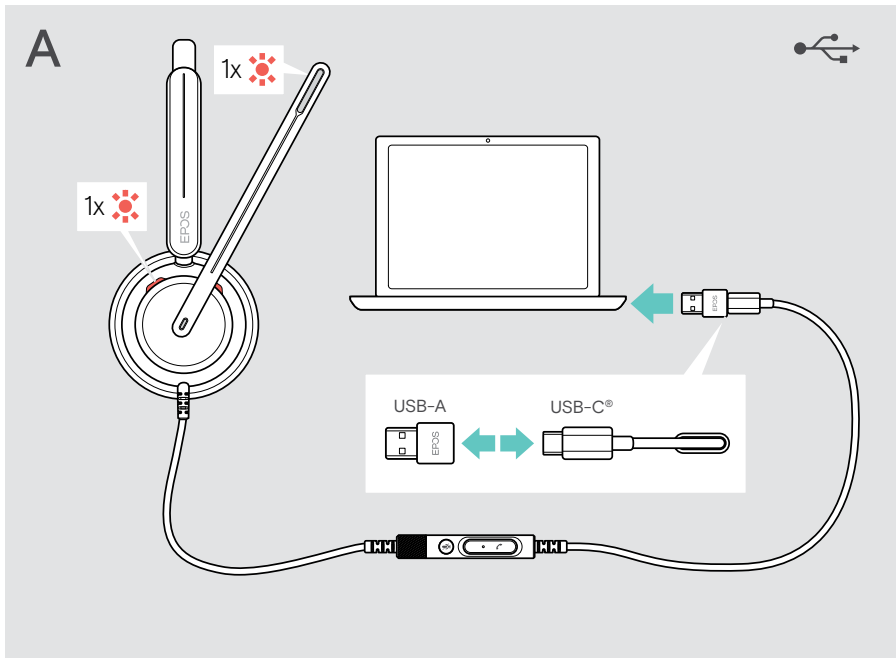

To disconnect the headset:

- > Pull the plug out of the USB port.

B Connecting to your mobile device

The following functions depend on the connected mobile device and apps and may not work for all of them.

- > Detach the USB-A adapter.
- > Plug the headset into the USB-C port of your mobile device.
The Busy light LED and the mute LED at the boom arm tip light up shortly when powered.

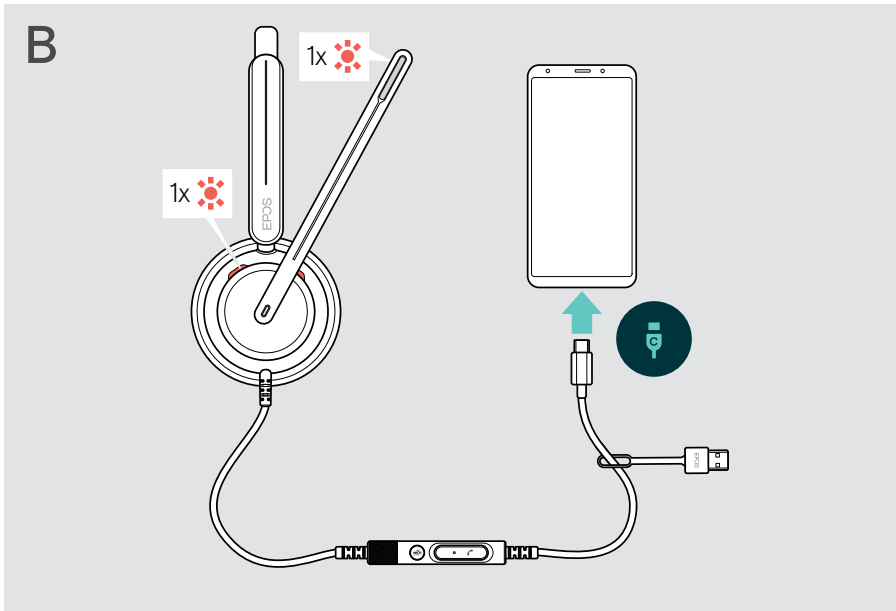

To disconnect the headset:

- > Pull the plug out of the USB port.

Installing the EPOS Connect desktop app

The free [EPOS Connect software](#) allows you to configure and update your headset and offers additional settings.

- > Download the software from eposaudio.com/connect.
- > Install the software. You need administrator rights on your computer – if necessary, contact your IT department.

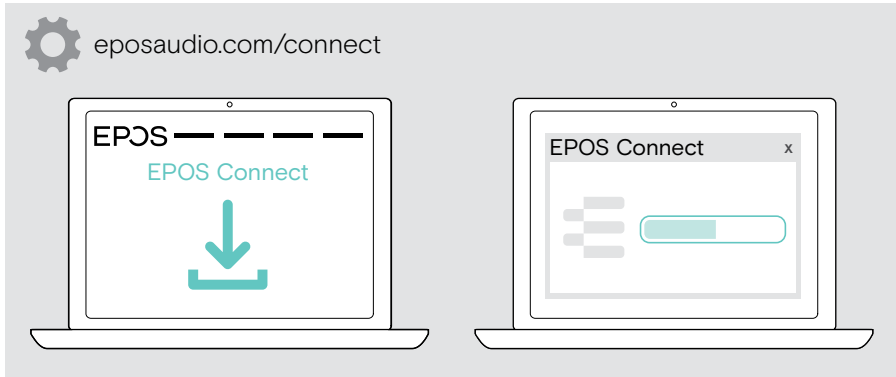

Changing audio settings – Microsoft® Windows

Windows usually changes the Audio settings automatically if you connect a new headset. If the headset is connected but you hear no sound:

- > Right-click the Audio icon.
- > Select under output IMPACT 7xO as speaker.
- > Select under input IMPACT 7xO as microphone.

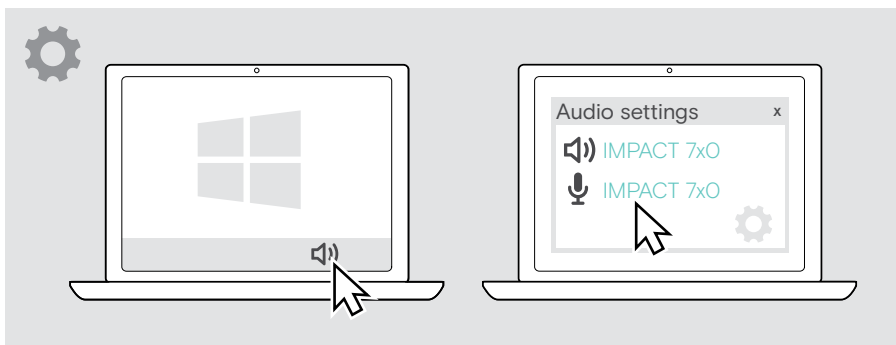

How to use – basic functions



CAUTION

Risk of hearing damage!

Listening at high volume levels for long periods can lead to permanent hearing defects.

- > Set the volume on your connected device to a low level before putting on the headset.
- > Do not continuously expose yourself to high volumes.

Changing the volume

- > Adjust the volume for calls and media streaming on your connected device. **OR**
- > Rotate the volume wheel clockwise or counter-clockwise to increase or reduce the volume.

You hear a double beep for maximum or minimum volume.

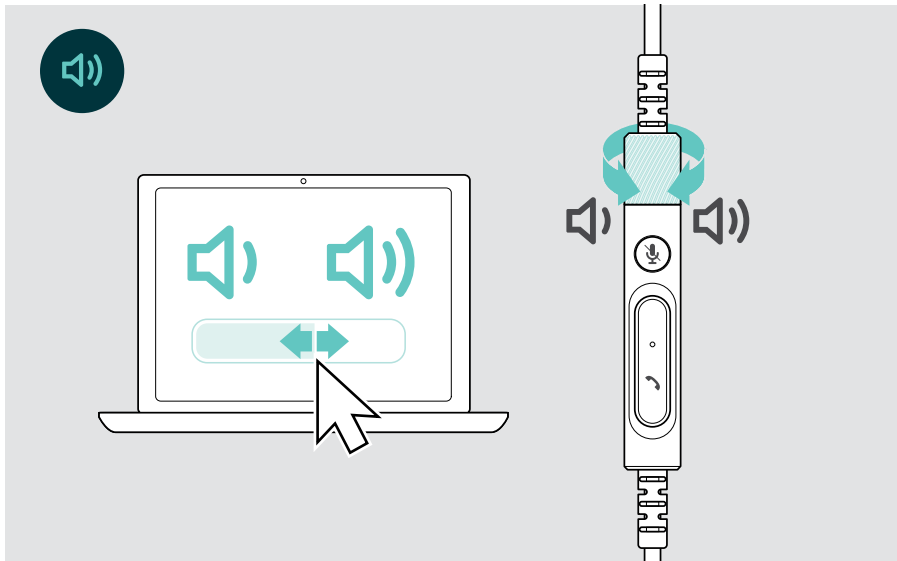

Changing the voice prompts volume

When headset is in idle mode (not during a call or media streaming):

- > Turn the volume wheel.

Adjusting the headset's microphone volume for softphones

- > Initiate a call on your connected device to someone who will help you find the correct volume setting for your microphone.
- > Change the microphone volume in your softphone application and/or in your computer's audio application.



Muting the headset's microphone

To mute or unmute the microphone:

- > **A** Move the boom arm up or down (you feel a light bump)* **OR**
 - > **B** Tap the mute button on the inline controller **OR**
 - > **C** Take the headset off or put it on* **OR**
 - > **D** Use your softphone interface.
- The Mute LED lights up red while muted.

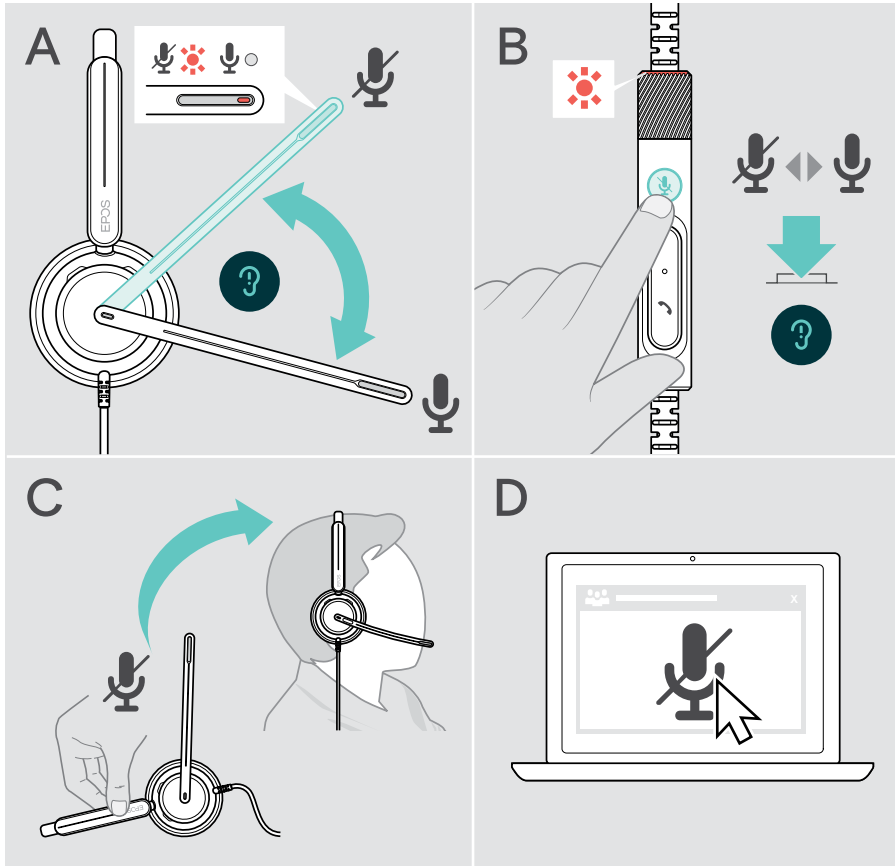

The mute LED flashes red, if you are talking while the microphone is muted*.



*This function can be activated/deactivated via EPOS Connect.

Making calls using the headset

The following functions depend on the connected device.

To make calls via the computer:

- > Install a softphone (VoIP Software) or ask your admin for support.

The Busylight LED lights up red as long as you are in a call or there is a call on hold.

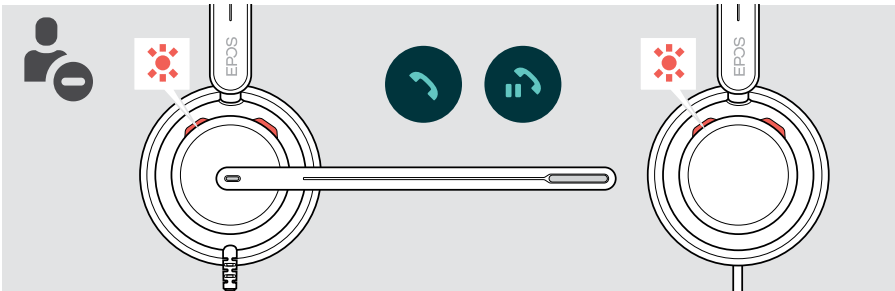

Making a call

- > Initiate the call on your connected device.



If your call is not automatically transferred to the headset:

- > Search this function in the instruction manual of your connected device.

Accepting / rejecting a call

There are several ways to accept an incoming call. You can also accept a call via your connected device.

Indications of an incoming call

When you receive a call, you hear a ring tone. The Busylight LED on the headset and the hook LED on the controller starts flashing.

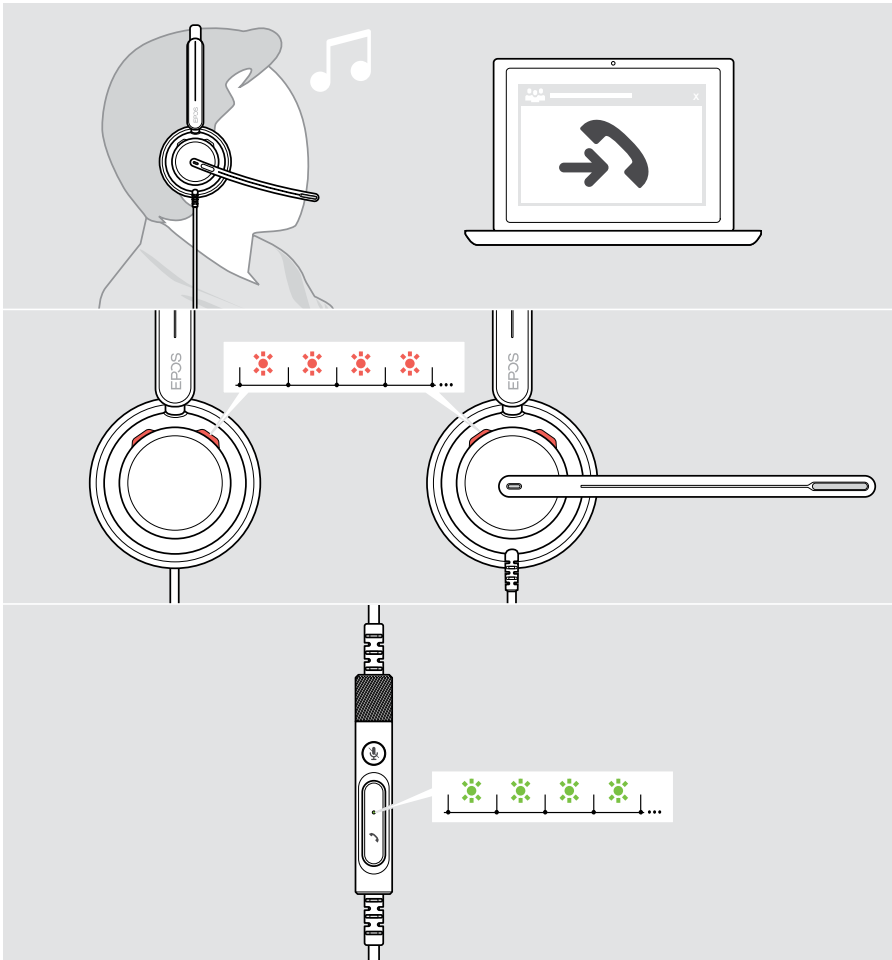

Accepting a call

You can accept a call in three different ways:

- > **A** Tap the Hook button. **OR**
- > **B** Move the boom arm down if it is lifted.* **OR**
- > **C** Put the headset on if not worn*. The headset is equipped with a wear detection sensor that registers when the headset is worn.

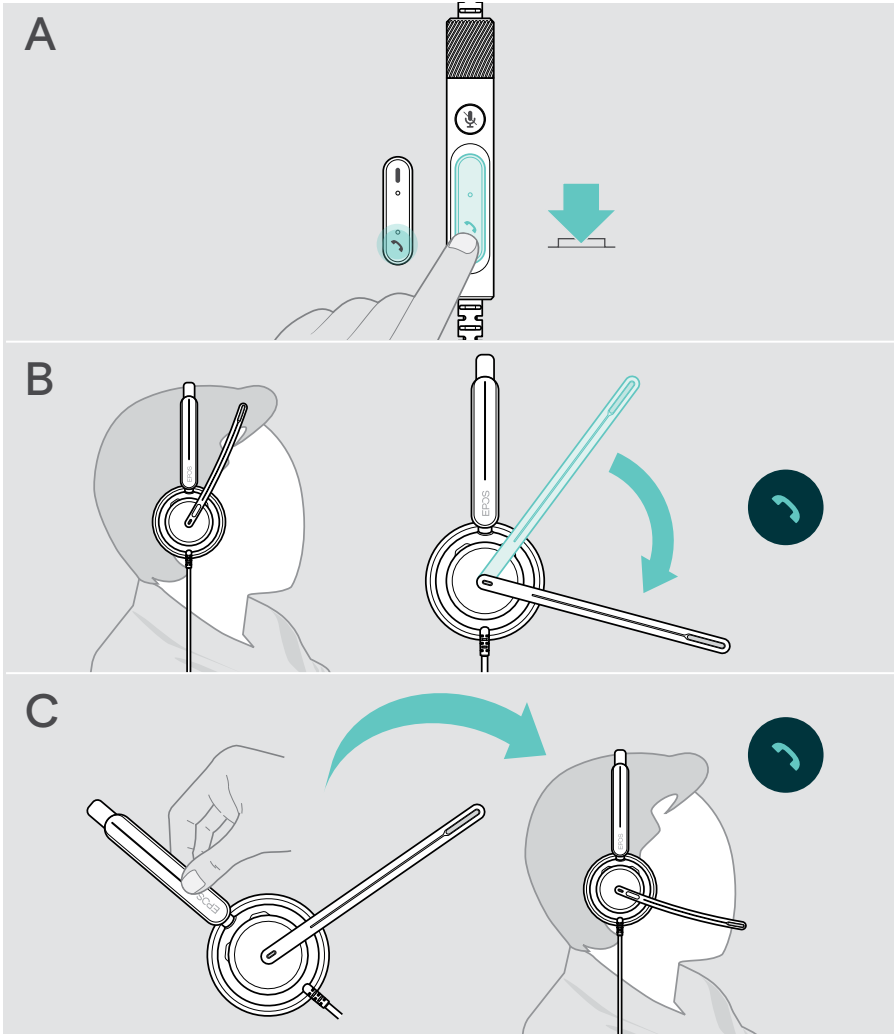

* B + C: This function can be activated/deactivated via EPOS Connect.

Rejecting a call

- > Press the Hook button for 2 seconds.

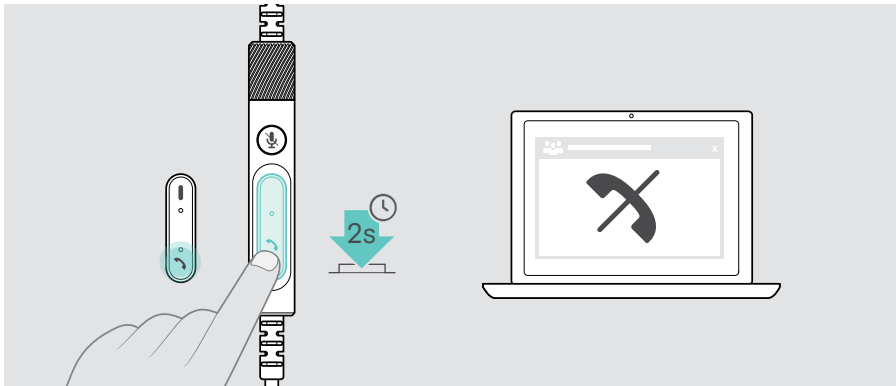

Putting a call on hold (pause)

- > Double tap the Hook button to put a call on hold or unhold the call.

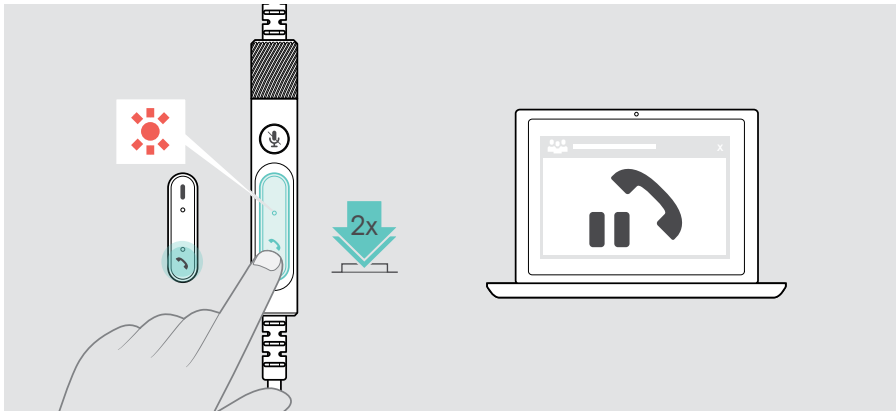

Ending a call

- > Tap the Hook button to end the call. **OR**
- > End the call via your connected device.

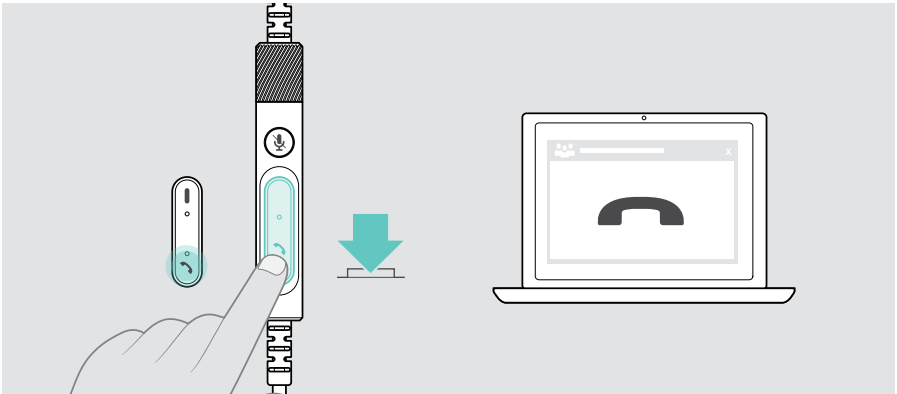

Managing multiple calls

Two calls can be managed simultaneously.

When you receive a call during an active call, a knock-on tone will be played. The controller's hook LED flashes red and green as long as a second call is handled.

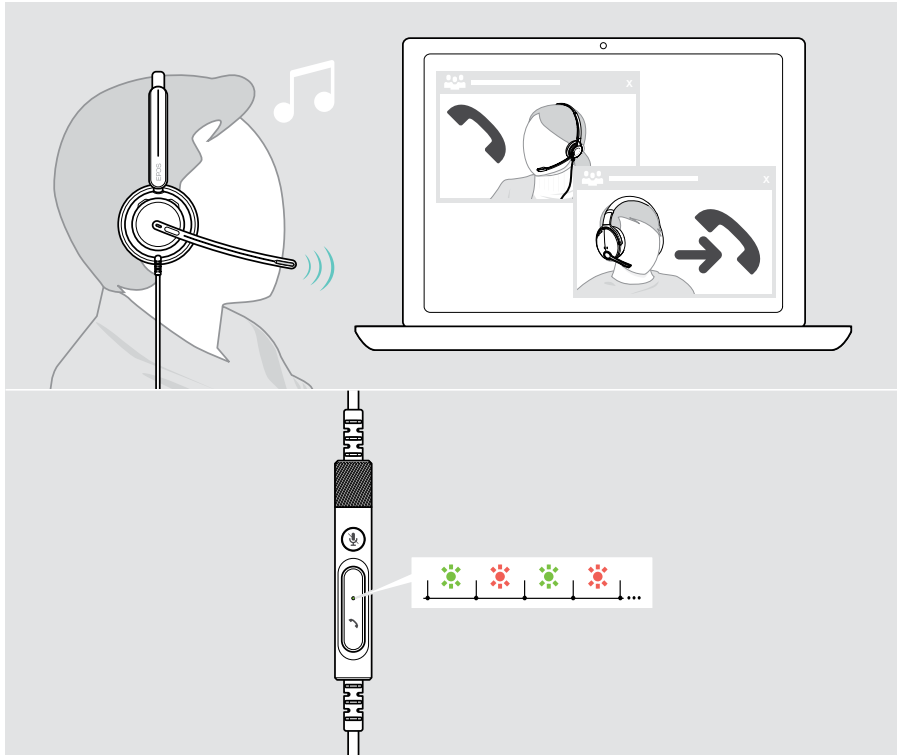

Accept / reject second call

Active call	2nd incoming call	Action	Description
			Accepts the incoming call and ends the active call
			Accepts the incoming call and puts the active call on hold
			Rejects the incoming call and continues the active call

Toggle between calls / end active call

Active call	2nd held call	Action	Description
			Toggles between the active and held call
			Ends the active call and keeps the 2nd call on hold

Using Microsoft® Teams – IMPACT 7xOT only

To use Microsoft Teams with the headset:

- > Connect the headset to your computer – see page 11.

If Microsoft Teams is already running on your computer, the controller's Teams LED lights up purple. Otherwise install and run Microsoft Teams.

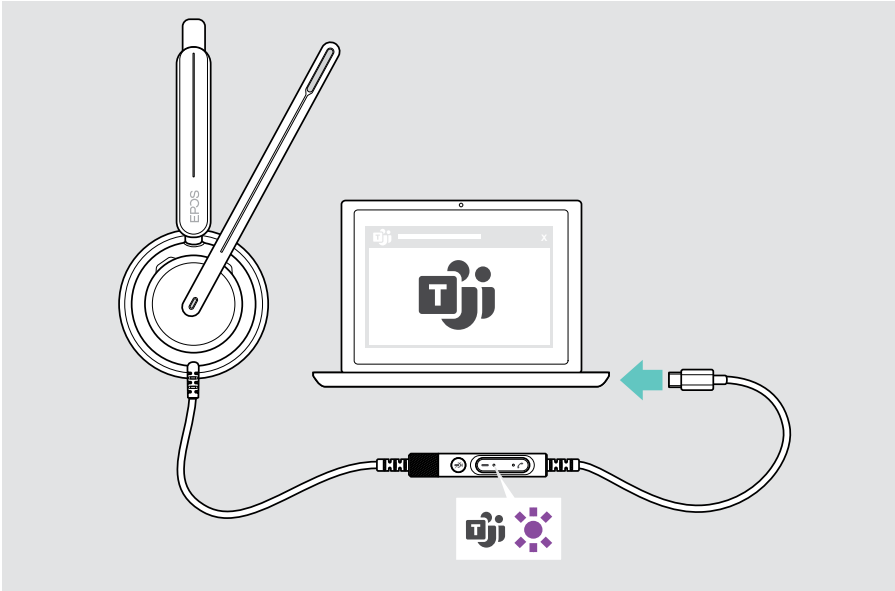

Invoking Microsoft® Teams

- > A Tap the Teams button. **OR**
- > B Open Microsoft Teams on your connected device.

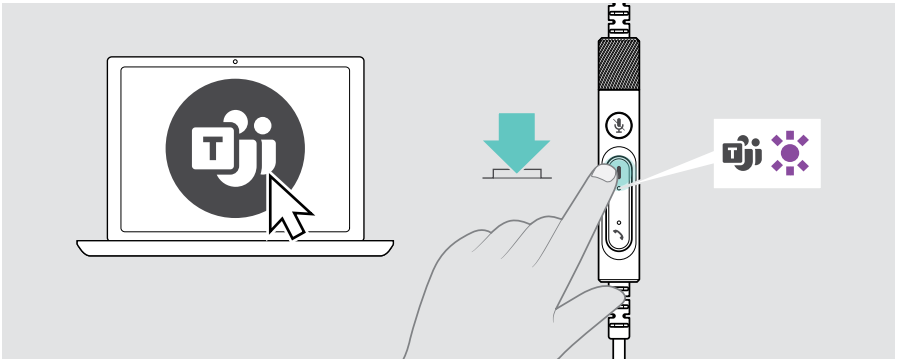

Raising hand in a Teams meeting

- > Press the Teams button for 1 second and release it to raise or lower hand.

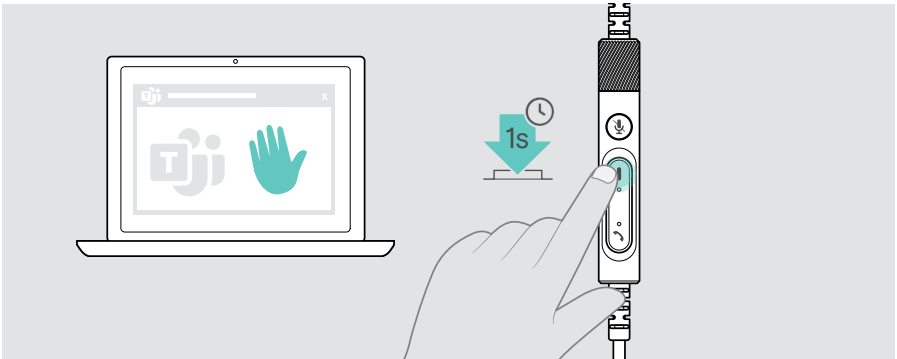

Checking Teams Notifications

The Teams LED pulses purple to indicate:

- Meeting Join Notification
- Voice Mail Notification
- Missed Call Notification

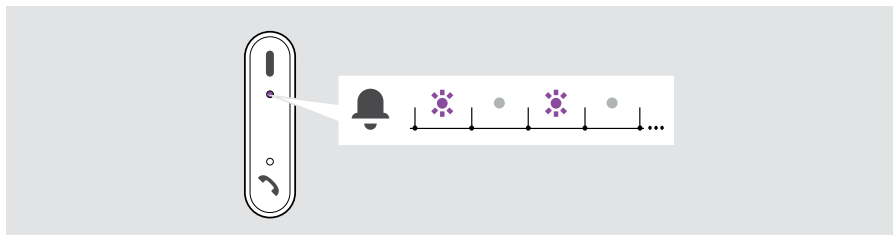

To check these Notifications on your screen:

- > Tap the Teams button.

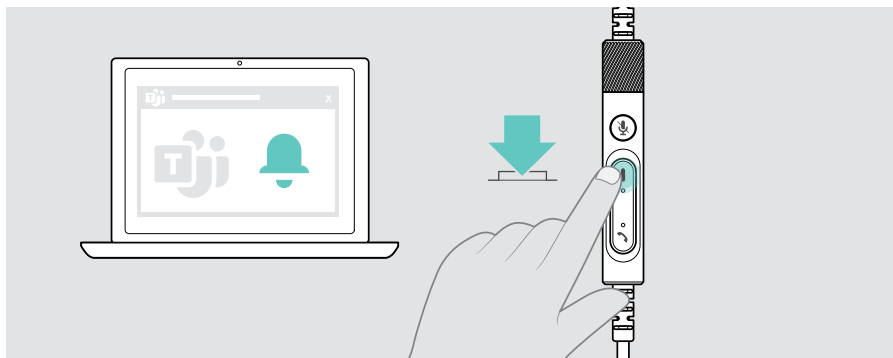

Listening to media

- > Play the media on your connected device.

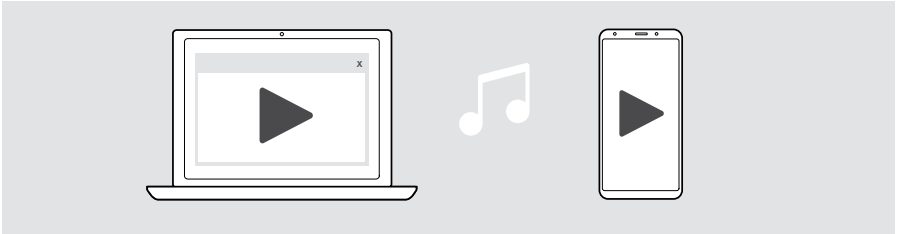

Controlling via the wear detection sensor

The headset is equipped with a wear detection sensor that registers whether it is on the head or not.

- > Take the headset off.
Media reproduction is paused.
- > Put the headset on.
Media reproduction resumes, if media was paused via the wear detection sensor.

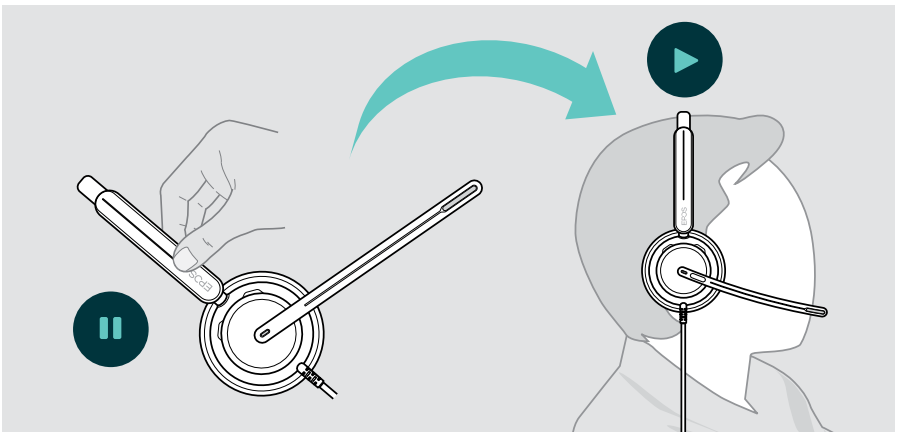

This function can be activated/deactivated via EPOS Connect.

Controlling via the button

If supported by the connected device and media application these functions are available:

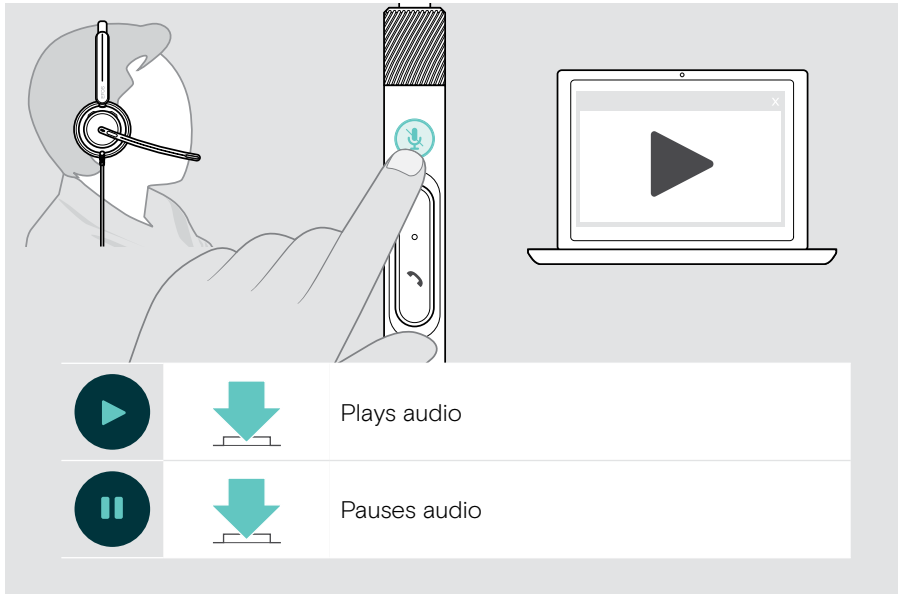

Good to know

Activating / deactivating sensor functions

The headset is equipped with a wear detection sensor that registers whether it is on the head or not. A second sensor registers the boom arm position.

Via **EPOS Connect** you can:

- > Activate or deactivate Smart features.

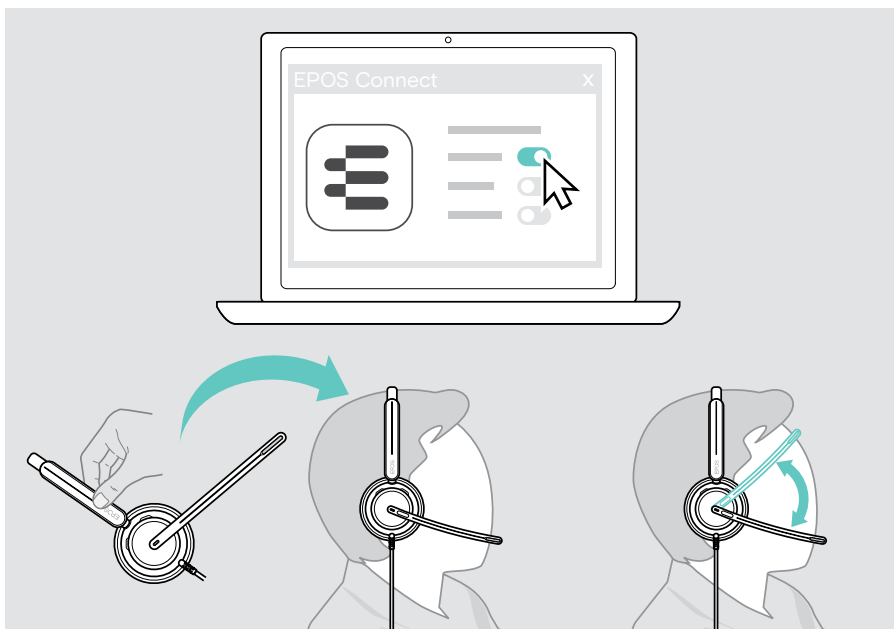

Available settings:

Answer Call	Accepts a call when you put on the headset Accepts a call if you move the boom arm down
Mute	Mutes the microphone when headset is removed during a call and unmutes when put on again Mutes the microphone if you move the boom arm up and unmutes when you move it back down
Play/pause	Pauses Media playback when you remove the headset and continues when you put it on again

Adjusting the Sidetone

Sidetone is the audible feedback of your own voice during a phone call. Sidetone helps you to lower your voice and speak at a natural and comfortable level.

- > Adjust the sidetone level in [EPOS Connect](#).

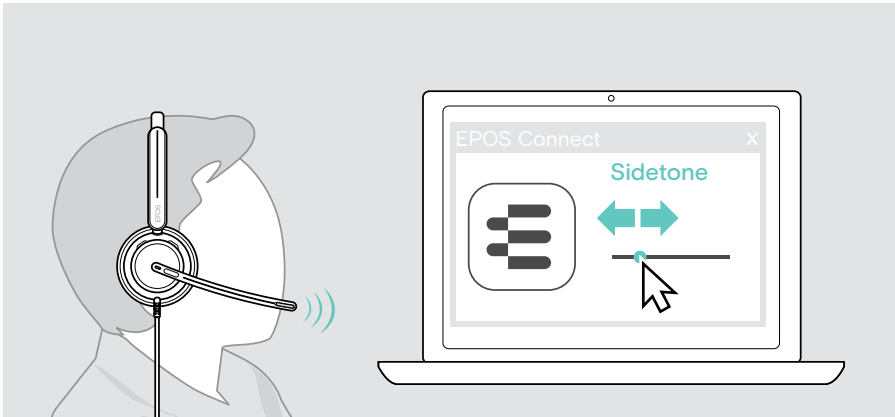

Changing the voice prompts' language

- > Choose the corresponding voice prompts' language from the list in [EPOS Connect](#) (English by default).

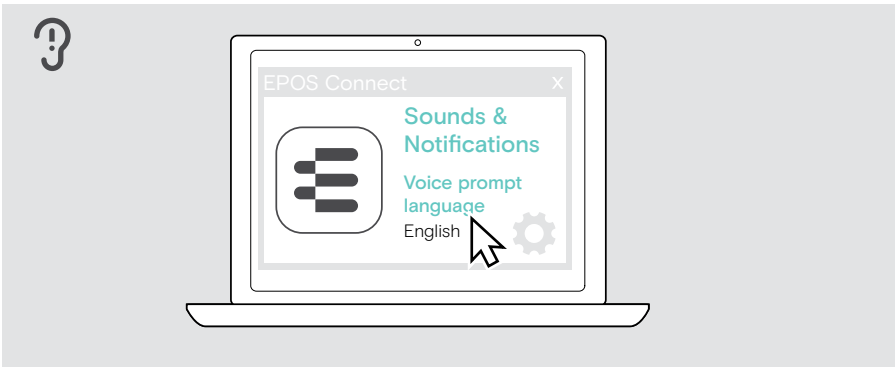

Adjusting sounds and notifications

> Change the sounds and notification in **EPOS Connect**.



Tone & voice prompts

Turns on/off prompts in the headset

Voice prompt language

Changes language of voice prompts in the headset

No voice prompts during call

Turns on/off non-essential voice prompts during a call

Talk while muted

Turns on/off the additional flashing of the boom arm LED: The LED generally lights up red while muted. If you activate this function, the LED flashes as soon as you start speaking as an additional reminder.

Enabling / disabling an Audio Limiter

> Choose an Audio Limiter in **EPOS Connect**.

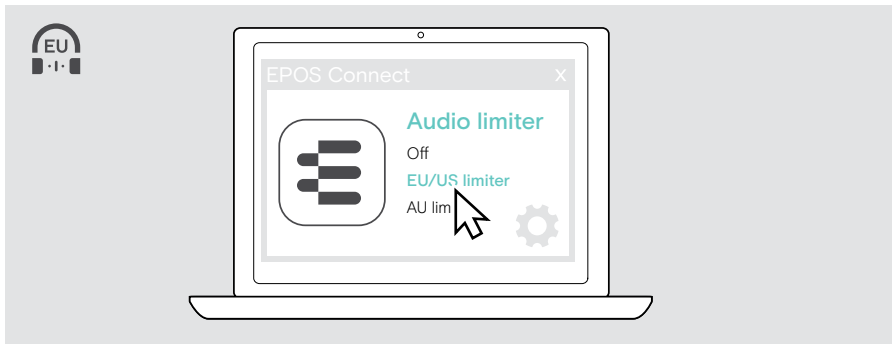

Off	Deactivates limiter (default setting)
EU/US limiter	Activates limiter: max. 90 dB; compliant with Directive 2003/10/EC
AU limiter	Activates limiter: max. 85 dB; compliant with Directive AS/ACIF G616:2006

Maintaining & updating products

Cleaning the products

WARNING

Liquids can damage the electronics of the product!

Liquids entering the housing of the device can cause a short circuit and damage the electronics.

- > Keep all liquids away from the product.
- > Do not use any cleansing agents or solvents.

- > Use a dry cloth to clean the product only.

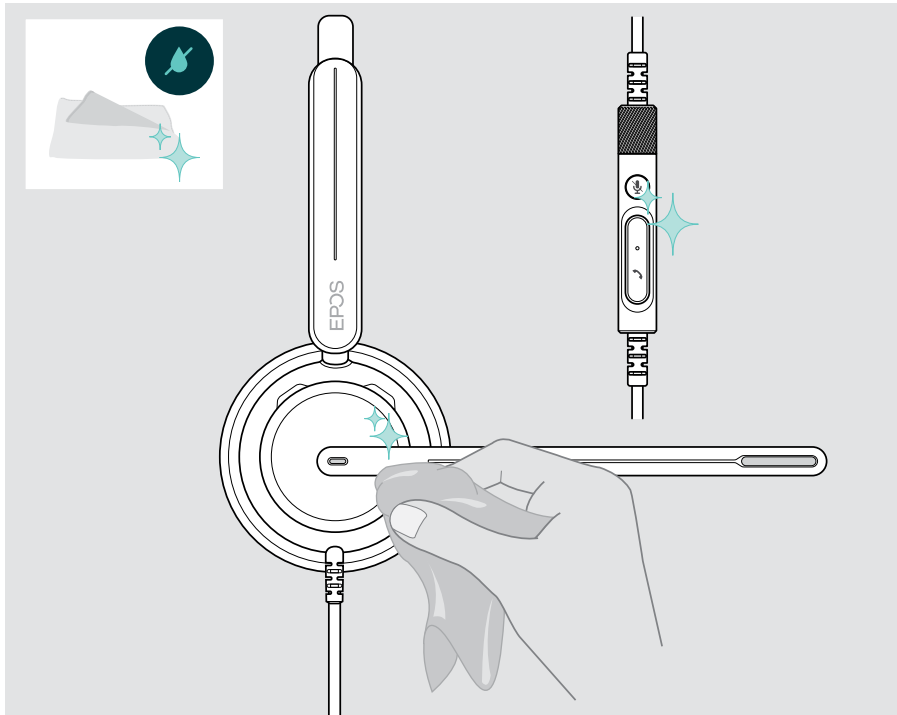

Transporting and storing the products

- > Keep the products in a clean and dry environment.

To avoid nicks or scratches on the headset:

- > Store the headset in the pouch when not in use or when carrying it around. Lift the boom arm and twist the earcups inwards.

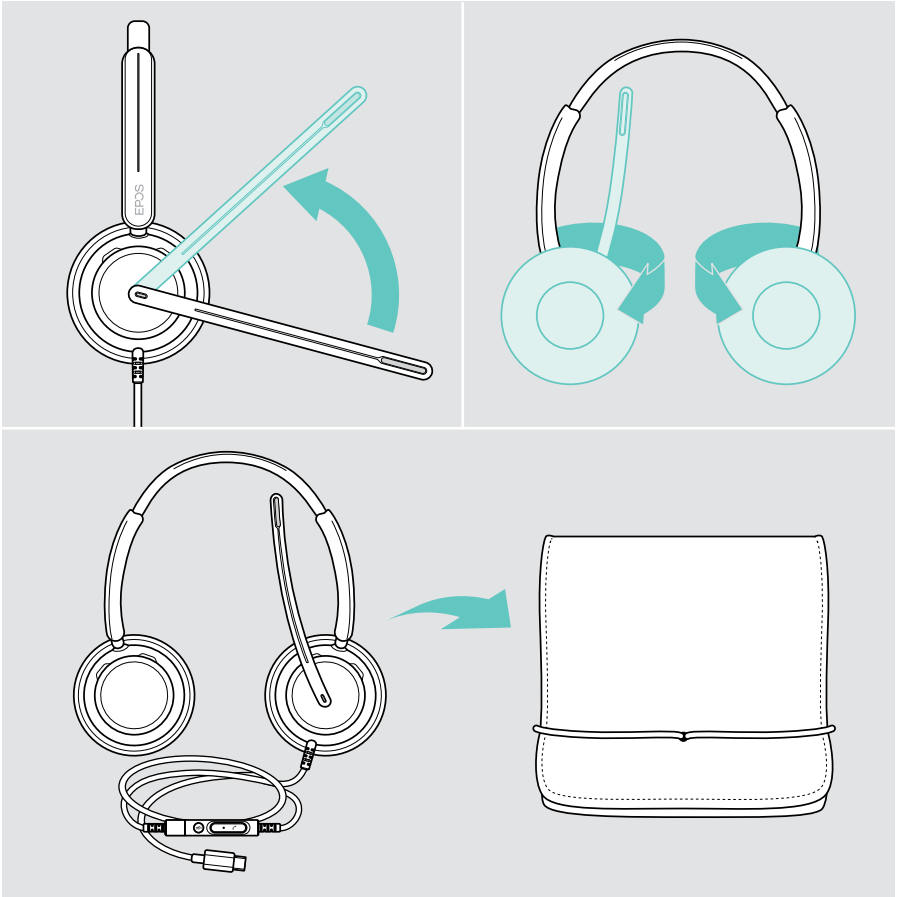

Replacing the ear pad(s)

For hygienic reasons, replace the ear pad(s). Spare ear pads are available from your EPOS partner.

- 1 Lift the boom arm and twist the earcups inwards.
- 2 Grasp the edge of the ear pad behind the ear cup and peel it up and away from the ear cup.
- 3 Slide the edge of the new ear pad into the small recess. Carefully rotate the ear pad until it is fully attached.

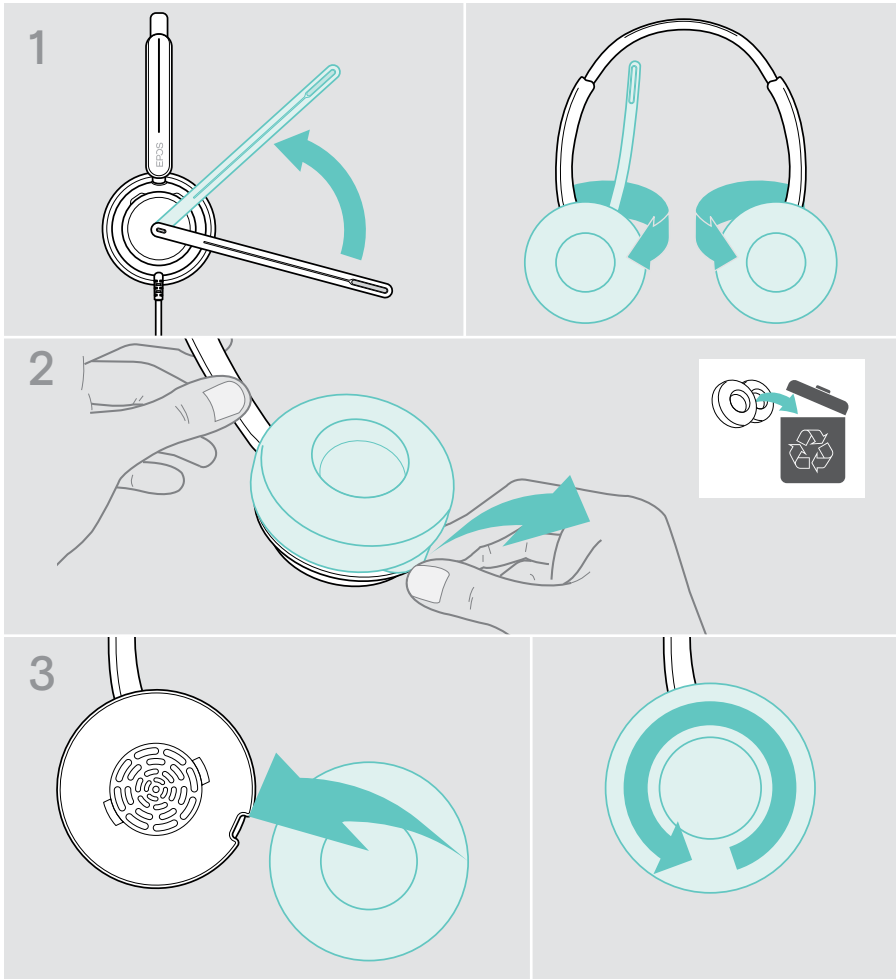

Updating the firmware

Keep your headset up-to-date with latest firmware to ensure flawless operation and maximum productivity. You can update the firmware of your headset by using the free [EPOS Connect](#) software (see page 13).

- > Connect the headset to your computer.
- > Start [EPOS Connect](#).

If there is a new firmware available, the software will guide you through the update process.

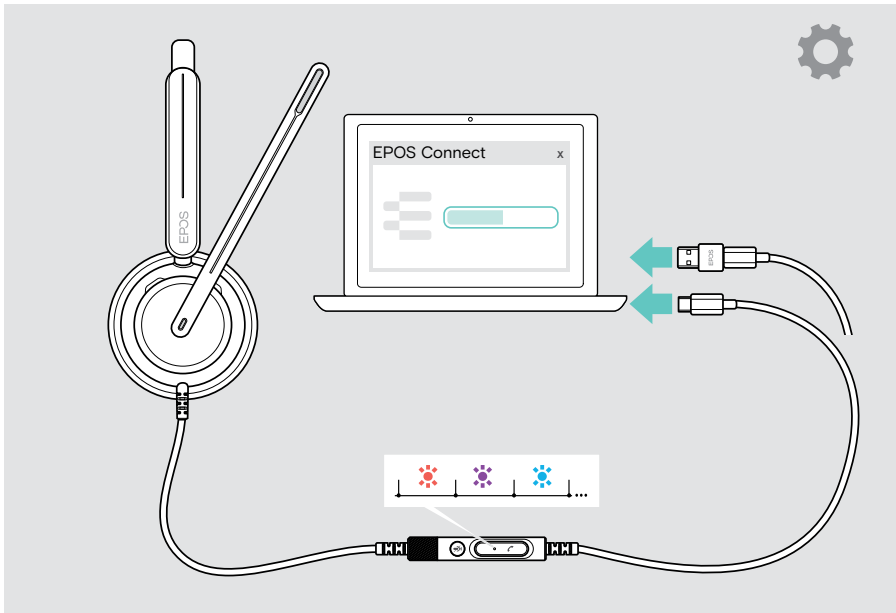

If a problem occurs...



Many functions can be activated/deactivated or adjusted in **EPOS Connect**:
 > Adjust the settings.

Problem	Possible cause	Solution	Page
No audio signal	Volume adjusted too low	> Increase the volume via the controller's volume wheel or your connected device.	14
	USB plug not fully inserted	> Insert the plug again.	11
	Other audio source selected	> Select EPOS IMPACT 7x0 in the Audio settings.	13
Inline controller does not work	USB plug not fully inserted	> Insert the plug again.	11
Microsoft Teams button does not work	Microsoft Teams not running on your computer	> Open Microsoft Teams on your computer.	-
Beeps instead of voice prompts	Voice prompts disabled	> Enable voice prompts via EPOS Connect.	31
Sound alerts during calls disturbing	Voice prompts or tones during calls enabled	> Disable voice prompts / tones during calls in EPOS Connect.	31
Voice prompts too loud or quiet	Volume for voice prompts adjusted too high or low	> Turn the volume wheel to adjust volume when in idle mode.	14
Stereo sound mirrored	Headset wearing side swapped	> Change the wearing side setting via EPOS Connect.	10
You hear your own voice too loud	Sidetone adjusted too high	> Change the sidetone setting via EPOS Connect.	30
Headset does not respond to wear detection sensor gestures	Wear detection sensor deactivated	> Activate wear detection sensor via EPOS Connect.	29
		> Unplug and plug in the headset again to re-start headset.	-
Microsoft Teams does not work	Microsoft Teams or connection to the app disturbed	> Re-start Microsoft Teams on your computer.	-
Headset does not react to any button press	Software or hardware problems	> Use EPOS Connect to reset the headset.	-

If a problem occurs that is not listed here or if the problem cannot be solved with the proposed solutions, please contact your local EPOS partner for assistance.

To find an EPOS partner in your country, search at eposaudio.com

eposaudio.com/impact700

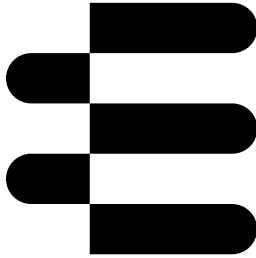

DSEA A/S

Kongebakken 9, DK-2765 Smørum, Denmark
eposaudio.com

01/24, A01