

SELECT SERIES PDU WITH RACKLINK™

MONITOR | CONTROL | ALERT | REPORT | ANALYZE

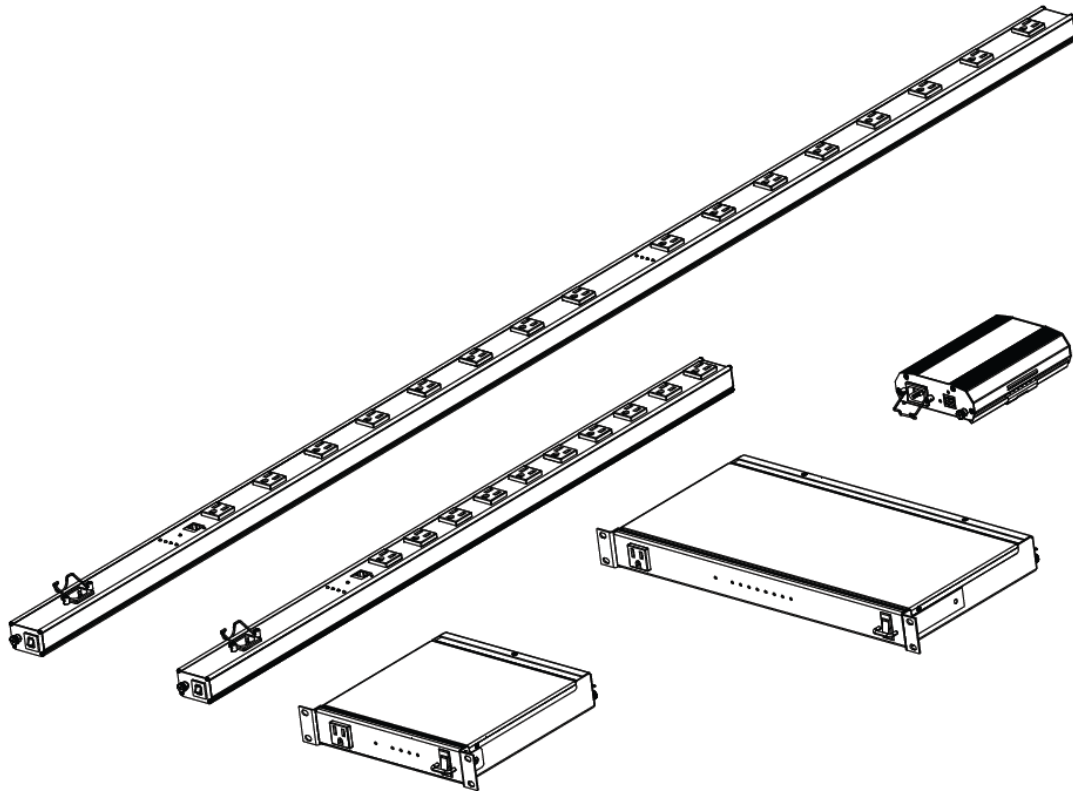

THANK YOU

Thank you for purchasing a Select Series PDU with RackLink™ product. Please read these instructions thoroughly before installing this product.



MIDDLE ATLANTIC

A brand of **legrand**

I-00768

Rev D

TABLE OF CONTENTS

IMPORTANT SAFETY INSTRUCTIONS	5
Waste Electrical and Electronic Equipment (WEEE) Directive	6
REGULATORY COMPLIANCE	7
Federal Communications Commission (FCC) Compliance Statement	7
Industry Canada (IC).....	7
INSTRUCTIONS IMPORTANTES SUR LA SÉCURITÉ	8
Directive sur les déchets d'équipements électriques et électroniques (WEEE).....	9
CONFORMITÉ RÉGLEMENTAIRE.....	10
Déclaration de conformité de la Federal Communications Commission (FCC)	10
Industrie Canada (IC).....	10
INTRODUCTION	11
Key Features.....	11
SYSTEM REQUIREMENTS	12
INSTALLING THE DEVICE DISCOVERY SOFTWARE AND ACCESSING A CONNECTED RACKLINK'S BROWSER-BASED INTERFACE.....	13
Installing the RackLink Device Discovery software on a PC:.....	13
Installing the RackLink Device Discovery software on a MAC:.....	15
Using Device Discovery.....	18
SETTING UP YOUR RACKLINK DEVICE FOR THE FIRST TIME	20
Configuring TCP/IP on Your PC	20
Configuring TCP/IP in RackLink via Browser-Based Interface	24
DOWNLOADING AND USING THE MOBILE APP	26
USING THE BROWSER-BASED INTERFACE	27
Logging in to the Browser-Based Interface.....	27
Understanding System Confirmations	29
Viewing Help Information.....	31
Viewing and Configuring Information on the Dashboard	31
Initiating a Sequence	31

Configuring Outlet Controls..... 32

Viewing Status Log Information 37

Configuring Administrator Settings 39

 Logging in to the Administrator Settings Menu 40

 Configuring Date/Time Settings 40

 Configuring Device Settings..... 42

 Configuring Email Settings..... 44

 Restoring Factory Defaults 46

 Updating Device Firmware..... 48

 Configuring Network Settings 50

 Passwords 52

UNDERSTANDING AN AUTOPING CONFIGURATION 54

 Connecting Your Equipment..... 54

 Measuring Modem/Router Start-Up Time..... 55

 Calculating Frequency, Failures, and Cycles 55

 Configuring AutoPing in Your RackLink 56

FREQUENTLY ASKED QUESTIONS..... 59

 General Questions 59

 Connectivity Questions..... 59

 Control System Questions..... 60

 Alert LED States..... 60

RACKLINK SELECT MODEL DIAGRAMS 61

 RLNK-2XX Diagrams 61

 RLNK-210-IEC-NS Front View..... 61

 RLNK-210-IEC-NS Rear View 64

 RLNK-215 Front View 61

 RLNK-215 Rear View..... 62

 RLNK-4XXR Diagrams 64

 RLNK-410R-IEC-NS Front View 65

 RLNK-410R-IEC-NS Rear View..... 66

RLNK-415R and RLNK-420R Front View 65

RLNK-415R and RLNK-420R Rear View..... 65

RLNK-9XXR Diagrams 67

RLNK-910R-IEC-NS Front View 67

RLNK-910R-IEC-NS Rear View..... 68

RLNK-915R and RLNK-920R Front View 67

RLNK-915R and RLNK-920R Rear View..... 67

RLNK-1015V Diagrams 69

RLNK-1015V Bottom View..... 69

RLNK-1015V Front View..... 69

RLNK-1615V Diagrams 70

RLNK-1615V Bottom View..... 70

RLNK-1615V Front View..... 71

WARRANTY 72

IMPORTANT SAFETY INSTRUCTIONS

- Read these instructions.
- Keep these instructions.
- Heed all warnings.
- Follow all instructions.
- Clean only with dry cloth.
- Only use attachments/accessories specified by the manufacturer.



DANGER HAZARDOUS VOLTAGE: The lightning flash with the arrowhead symbol, within an equilateral triangle is intended to alert the user to the presence of uninsulated dangerous voltage within the product's enclosure that may be of sufficient magnitude to constitute a risk of electric shock to persons.



WARNING: A warning alerts you to a situation that could result in serious personal injury or death.



CAUTION: A caution alerts you to a situation that may result in minor personal injury or damage to the product and/or property.

NOTE: A note is used to highlight procedures pertaining to the installation, operation, or maintenance of the product.



DANGER HAZARDOUS VOLTAGE: To reduce the risk of electrical shock: Always unplug this device from the electrical outlet before cleaning.



WARNING: Failure to read, understand and follow the following information can result in serious personal injury, damage to the equipment or voiding of the warranty. It is the responsibility of the Installer/User to ensure that this product is loaded according to specifications.



WARNING: Risk of Electric Shock: Connect the device to a properly grounded outlet only. Do not defeat the safety purpose of the polarized or grounding-type plug. A polarized plug has two blades with one wider than the other. A grounding type plug has two blades and a third grounding prong. The wide blade or the third prong is provided for your safety. If the provided plug does not fit into your outlet, consult an electrician for replacement of the obsolete outlet.



WARNING: The apparatus shall not be exposed to dripping or splashing and that no objects filled with liquids, such as vases, shall be placed on the apparatus.



WARNING: To reduce the risk of burns, fire, electric shock, or injury to persons:

- Unplug from outlet before putting on or taking off parts.
- Close supervision is necessary when this device is used by, or near children, invalids, or disabled persons.
- Use this device only for its intended use as described in these instructions. Do not use attachments not recommended by the manufacturer.
- Never operate the device if it has a damaged cord or plug, if it is not working properly, if it has been dropped or damaged, or dropped into water. Return the device to a service center for examination and repair.
- Protect the power cord from being walked on or pinched particularly at plugs, convenience receptacles, and the point where they exit from the apparatus.
- Keep the cord away from heated surfaces.
- Never drop or insert any object into any opening.
- Do not use outdoors.
- Do not operate where aerosol (spray) products are being used or where oxygen is being administered.
- To disconnect, turn all controls to the off position, then remove plug from outlet.



CAUTION: The socket-outlet shall be installed near the equipment and shall be easily accessible.



CAUTION: Use indoor in dry locations only.

Safety Instructions: Rack Mount

Elevated Operating Ambient: If installed in a closed or multi-unit rack assembly, the operating ambient temperature of the rack environment may be greater than room ambient. Therefore, consideration should be given to installing the equipment in an environment compatible with the maximum ambient temperature (T_{ma}) specified by the manufacturer.

Reduced Air Flow: Installation of the equipment in a rack should be such that the amount of air flow required for safe operation of the equipment is not compromised.

Mechanical Loading: Mounting of the equipment in the rack should be such that a hazardous condition is not achieved due to uneven mechanical loading.

Circuit Overloading: Consideration should be given to the connection of the equipment to the supply circuit and the effect that overloading of the circuit might have on overcurrent protection and supply wiring. Appropriate consideration of equipment nameplate ratings should be used when addressing this concern.

Reliable Earthing: Reliable earthing of rack-mounting equipment should be maintained. Particular attention should be given to supply connections other than direct connections to the branch circuit (e.g. use of power strips).

Disconnect Device (Pluggable Equipment): The socket-outlet shall be installed near the equipment and shall be easily accessible.

When using electrical products, basic precautions should always be followed, including the following:

- Read and follow all instructions before using.
- There are no user-serviceable components within this device. Removal of the cover from this device may present a shock hazard, and void the warranty.
- The mains plug is used as your disconnect device. This device shall remain readily operable.
- Unplug this apparatus during lightning storms or when unused for long periods of time.
- Do not overload the wall outlet where this device is being connected. Do not overload this device. Ensure the total load to this device does not exceed that which is listed in the specifications section of this manual.
- Ensure this device is connected to a properly grounded AC power source. Ensure the device is plugged into a source providing the required voltage as follows: 120V (for 15 or 20A units) or 100-240V (for IEC units).

Waste Electrical and Electronic Equipment (WEEE) Directive



Correct disposal of this product: This symbol indicates that this product must not be disposed of with household waste, according to the WEEE Directive (2012/19/EU) and your national law. This product should be taken to a collection center licensed for the recycling of waste electrical and electronic equipment (EEE). The mishandling of this type of waste could have a possible negative impact on the environment and human health due to potentially hazardous substances that are generally associated with EEE. At the same time, your cooperation in the correct disposal of this product will contribute to the efficient use of natural resources. For more information about where you can take your waste equipment for recycling, please contact your local city office or your household waste collection service.

REGULATORY COMPLIANCE

Federal Communications Commission (FCC) Compliance Statement



CAUTION: Any changes or modifications not expressly approved by the party responsible for compliance could void the user's authority to operate the equipment.

NOTE: This equipment has been tested and found to comply with the limits for a Class B digital device, pursuant to part 15 of the FCC Rules. These limits are designed to provide reasonable protection against harmful interference in a residential installation. This equipment generates, uses and can radiate radio frequency energy and, if not installed and used in accordance with the instructions, may cause harmful interference to radio communications. However, there is no guarantee that interference will not occur in a particular installation. If this equipment does cause harmful interference to radio or television reception, which can be determined by turning the equipment off and on, the user is encouraged to try to correct the interference by one or more of the following measures:

- Reorient or relocate the receiving antenna.
- Increase the separation between the equipment and receiver.
- Connect the equipment into an outlet on a circuit different from that to which the receiver is connected.
- Consult the dealer or an experienced radio/TV technician for help.

Industry Canada (IC)

ICES-003 Class B Notice. This Class B digital apparatus complies with Canadian ICES-003.

INSTRUCTIONS IMPORTANTES SUR LA SÉCURITÉ

- Lire ces instructions.
- Respectez tous les avertissements.
- Nettoyer uniquement avec un chiffon sec.
- Conservez ces instructions.
- Suivez toutes les instructions.
- N'utilisez que des accessoires spécifiés par le fabricant.



DANGER TENSION DANGEREUSE: Le symbole de la pointe de flèche, dans un triangle équilatéral, est destiné à alerter l'utilisateur sur la présence de tension dangereuse non isolée dans l'enceinte du produit qui peut être d'une ampleur suffisante pour constituer un risque d'électrocution.



AVERTISSEMENT: Un avertissement vous avertit d'une situation pouvant entraîner des blessures graves ou la mort.



ATTENTION: Une attention vous avertit d'une situation pouvant entraîner des blessures mineures ou des dommages au produit et/ou à la propriété.

REMARQUE: Une remarque est utilisée pour mettre en évidence les procédures relatives à l'installation, au fonctionnement ou à l'entretien du produit.



DANGER TENSION DANGEREUSE: Pour réduire le risque de choc électrique: Toujours débrancher le meuble de la prise électrique avant de le nettoyer.



AVERTISSEMENT: Ne pas lire, comprendre et suivre les informations suivantes peut entraîner des blessures graves, des dommages à l'équipement ou de la nullité de la garantie. Il incombe à l'installateur/utilisateur de s'assurer que ce produit est chargé conformément aux spécifications.



AVERTISSEMENT: Risque de choc électrique: Brancher le meuble uniquement à une prise correctement mise à la terre. Ne pas détériorer le dispositif de sécurité de la fiche polarisée ou de la fiche de terre. Une fiche polarisée possède deux broches, dont l'une plus large que l'autre. Une fiche de type terre possède deux broches et une troisième de mise à la terre. La broche large ou la troisième fiche sont fournies pour des raisons de sécurité. Si la fiche fournie n'entre pas dans votre prise de courant, veuillez faire appel à un électricien pour remplacer la prise obsolète.



AVERTISSEMENT: L'appareil ne doit pas être exposé à des éclaboussures et aucun objet rempli de liquide, comme des vases, ne doit être placé sur l'appareil.



AVERTISSEMENT: Pour réduire les risques de brûlures, d'incendie, de choc électrique ou de blessures:

- Débrancher de la prise électrique avant d'installer ou de retirer des pièces.
- Surveiller étroitement ce meuble s'il est utilisé par ou à proximité d'un enfant, d'une personne invalide ou handicapée.
- N'utiliser ce meuble que pour l'usage auquel il est destiné, tel que décrit dans la présente fiche d'instructions. Ne pas utiliser d'accessoires non recommandés par le fabricant.
- Ne jamais utiliser ce meuble si le cordon ou la prise est endommagé, s'il ne fonctionne pas correctement, s'il est tombé ou est endommagé, ou s'il est tombé dans l'eau. Renvoyer le meuble à un centre de service après-vente pour qu'il soit examiné et réparé.
- Le cordon d'alimentation doit être placé de manière à éviter qu'il soit piétiné ou pincé, notamment au niveau des prises, des réceptacles et à la sortie de l'appareil.
- Garder le cordon d'alimentation loin des surfaces chauffées.
- Ne jamais faire tomber ou introduire un objet dans une ouverture.
- Ne pas utiliser en extérieur.
- Ne pas utiliser dans des lieux où des produits aérosols sont utilisés ou à proximité d'une source d'oxygène.
- Pour débrancher, placer tous les boutons en position off, puis retirer la fiche de la prise électrique.



ATTENTION: La prise de courant doit être installée près de l'équipement et doit être facilement accessible.



ATTENTION: Pour être utilisé en intérieur dans un endroit sec seulement.

Consignes de sécurité: montage en rack

Température de fonctionnement: Si installé dans un rack fermé ou à unités multiples, la température ambiante de fonctionnement de l'environnement du rack peut être supérieure à ambiante de la pièce. Par conséquent, il faudrait envisager d'installer l'équipement dans un environnement compatible avec la température ambiante maximale (T_{ma}) spécifiée par le constructeur.

Réduction Air accréditives: Installation de l'équipement dans un rack doit être telle que la quantité de flux d'air nécessaire au bon fonctionnement de l'équipement ne soit pas compromise.

Chargement mécanique: Le montage de l'équipement dans le rack doit être telle qu'une condition dangereuse ne lié à un chargement mécanique irrégulier.

Surcharge des circuits: Il faudrait envisager à la connexion de l'équipement au circuit d'alimentation et l'effet que la surcharge du circuit pourrait avoir sur la protection contre les surintensités et le câblage d'alimentation. Examen approprié des équipements évaluations de la plaque signalétique doit être utilisée pour traiter de cette préoccupation.

Mise à la terre fiable: Fiable mise à la terre de l'équipement de montage en rack doit être maintenue. Une attention particulière devrait être accordée aux connexions d'alimentation autres que les connexions directes vers le circuit de dérivation (par exemple de l'utilisation de bandes de puissance).

Appareil Disconnect (Équipement Pluggable): La prise de courant doit être installée à proximité du matériel et doit être facilement accessible.

Lors de l'utilisation des produits électriques, des précautions de base doivent toujours être respectées, y compris les suivantes:

- Lire et suivre toutes les instructions avant l'utilisation du matériel.
- Il n'ya pas de composants réparables par l'utilisateur au sein de cet appareil. Retrait de la couverture de cet appareil peut présenter un danger d'électrocution et annuler la garantie.
- La fiche secteur est utilisée comme sectionneur de courant. Ce dispositif doit rester en état de marche.
- Débrancher cet appareil pendant les orages ou s'il n'est pas utilisé pendant de longues périodes.
- Ne surchargez pas le réceptacle de mur ou le circuit qui fournit l'énergie à ce appareil. Ne pas surcharger cette appareil. S'assurer que la charge totale à cet appareil ne dépasse pas celle qui est répertoriée dans la section des spécifications de ce manuel.
- Assurez-vous que cet appareil est connecté à une source d'alimentation CA correctement mise à la terre. Assurez-vous que l'appareil est branché sur une source fournissant la tension requise comme suit : 120V (pour les unités 15 ou 20A) ou 100-240V (pour les unités IEC).

Directive sur les déchets d'équipements électriques et électroniques (WEEE)



Élimination correcte de ce produit: Ce symbole indique que ce produit ne doit pas être éliminé avec les ordures ménagères, conformément à la directive WEEE (2012/19/EU) et à votre législation nationale. Ce produit doit être déposé dans un centre de collecte agréé pour le recyclage des déchets d'équipements électriques et électroniques (EEE). La mauvaise manipulation de ce type de déchets pourrait avoir un impact négatif possible sur l'environnement et la santé humaine en raison de substances potentiellement dangereuses généralement associées aux EEE. Dans le même temps, votre coopération dans l'élimination correcte de ce produit contribuera à une utilisation efficace des ressources naturelles. Pour plus d'informations sur les lieux de recyclage de vos équipements usagés, veuillez contacter votre mairie ou votre service de collecte des ordures ménagères.

CONFORMITÉ RÉGLEMENTAIRE

Déclaration de conformité de la Federal Communications Commission (FCC)



ATTENTION: Les changements ou modifications non expressément approuvés par le fabricant peuvent annuler le droit de l'utilisateur à utiliser l'équipement.

REMARQUE: Cet équipement a été testé et jugé conforme aux limites d' un dispositif numérique de classe B, conformément à la partie 15 des règles de la FCC. Ces limites sont conçues pour fournir une protection raisonnable contre les interférences nuisibles dans une installation résidentielle. Cet équipement génère, utilise et peut émettre de l'énergie radiofréquence et, si non installé et utilisé conformément aux instructions, peut provoquer des interférences dans les communications radio. Cependant, il n'y a aucune garantie que des interférences ne se produiront pas dans une installation particulière. Si cet équipement provoque des interférences nuisibles à la réception radio ou de télévision, ce qui peut être déterminé en allumant et éteignant l'équipement, l'utilisateur est encouragé à essayer de corriger l'interférence par une ou plusieurs des mesures suivantes:

- Réorienter ou déplacer l' antenne de réception.
- Augmenter La distance entre l'équipement et le récepteur.
- Brancher l'équipement dans une prise sur un circuit différent de celui sur lequel est branché le récepteur.
- Consulter le revendeur ou un technicien radio/TV expérimenté.

Industrie Canada (IC)

ICES-003 Avis NMB-003, Classe B. Cet appareil numérique de la classe B est conforme à la norme NMB-003 du Canada.

INTRODUCTION

Thank you for purchasing a Select Series PDU with RackLink™ product (subsequent references as RackLink or RackLink device). RackLink simplifies installation and reduces the cost of service and support by providing intelligent power designed for AV systems. With its versatility in new vertical PDU, traditional rackmount and compact form factors, RackLink allows control anywhere it's needed. All form factors are enabled with RackLink technology, creating a system for IP control of power distribution locally or anywhere in the world. This system is a simple, cost effective method for adding intelligent outlet control to applications with basic power distribution. It expands the range of applications and systems that can become IP controlled.

Ensuring system reliability and uptime, it uses intuitive setup and operation, pre-emptive problem notification and automatic problem resolution. RackLink is also designed to maximize productivity through universal control via local network, third party control systems, or third-party cloud partners.

Key Features

- Remotely reboot connected equipment.
- AutoPing feature provides the ability to reboot remote equipment and/or email status notifications.
- Integrated sequencing.
- Individual outlet control supported locally and remotely via the web or connected control system.
- Set email alerts.
- Open platform communications protocol provides seamless integration with any TCP/IP-based control systems.
- RackLink device Mobile applications are available for iOS® and Android™.

SYSTEM REQUIREMENTS

- Windows® 7 32/64-bit or later with .Net 4.0 Framework or later.
- Macintosh® OS X® 10.8 or later.
- The latest version of Google Chrome™ is recommended.
- You must configure a port on your firewall to allow passthrough traffic to your RackLink device whether you use DDNS or a static TCP/IP address. Please refer to your router's instructions regarding port configuration. If you do not have a static TCP/IP address, you must first setup a method for handling the address changes, such as using a DDNS service. Once completed, please follow the same instructions as if you had a static address, and then open a port on your router to allow passthrough traffic to your RackLink device.

For information about setting your RackLink device to use a static TCP/IP address, see "Setting Up Your RackLink Device for the First Time" on page 20.

INSTALLING THE DEVICE DISCOVERY SOFTWARE AND ACCESSING A CONNECTED RACKLINK'S BROWSER-BASED INTERFACE

Installing the RackLink Device Discovery software on a PC:

To install RackLink Device Discovery software on a PC:

1. Access www.legrandav.com.
2. Download and run the RackLink Device Discovery **setup.exe** file.

The Device Discovery Setup dialog box appears.

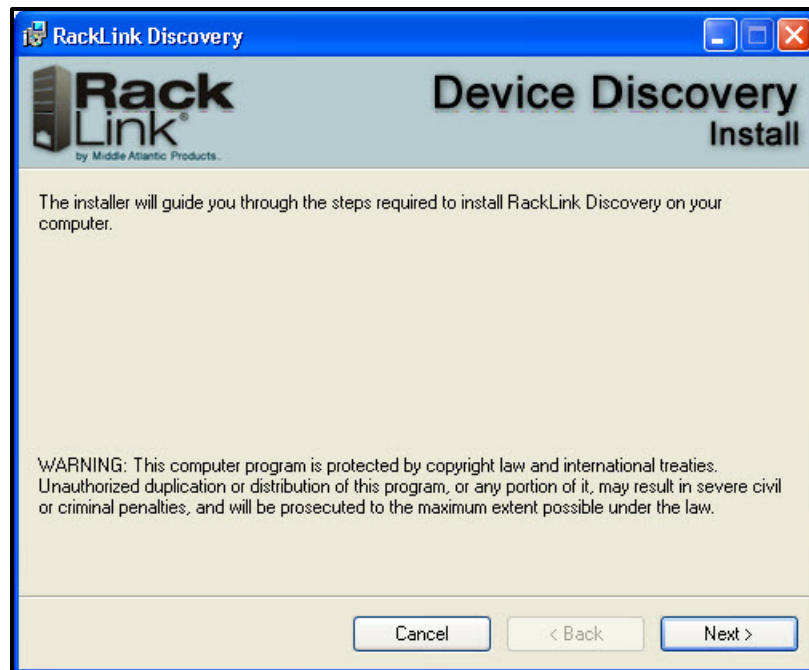

3. Click **Next**.

Additional installation options appear.

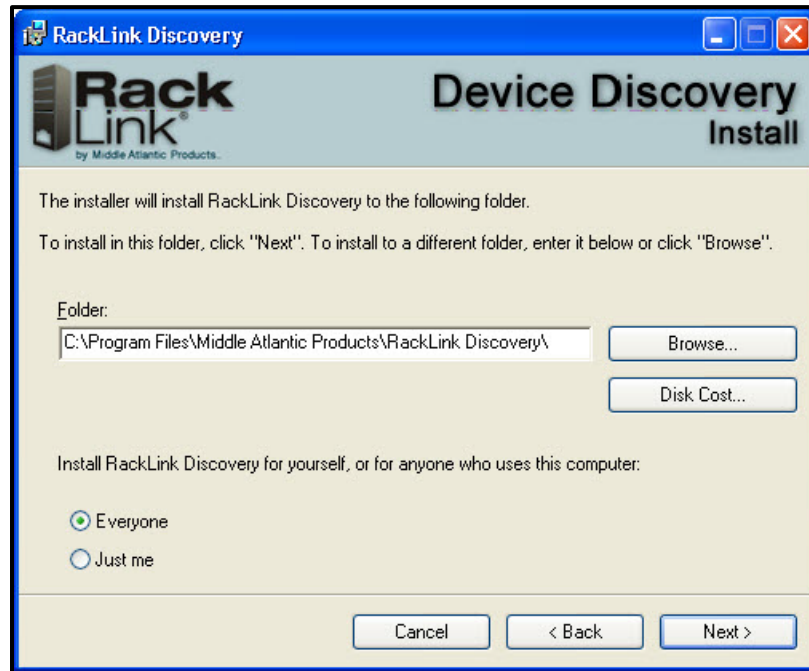

4. Click **Browse** if you wish to change the software installation folder.

If desired, select whether you want to install RackLink Discovery for everyone, or just the current user.

5. Click **Next**.

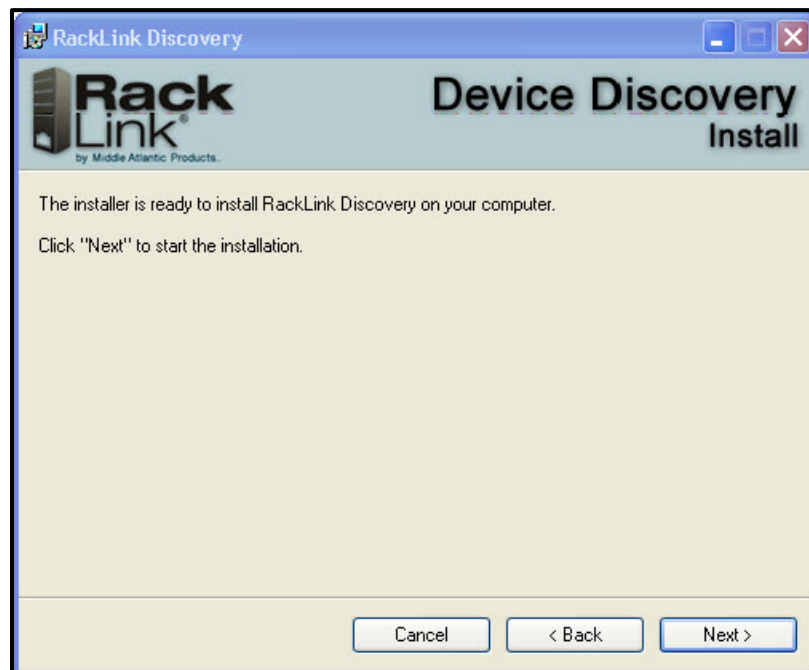

The installer indicates that it's ready to install RackLink Discovery on your computer.

6. Click **Next** to begin the installation.

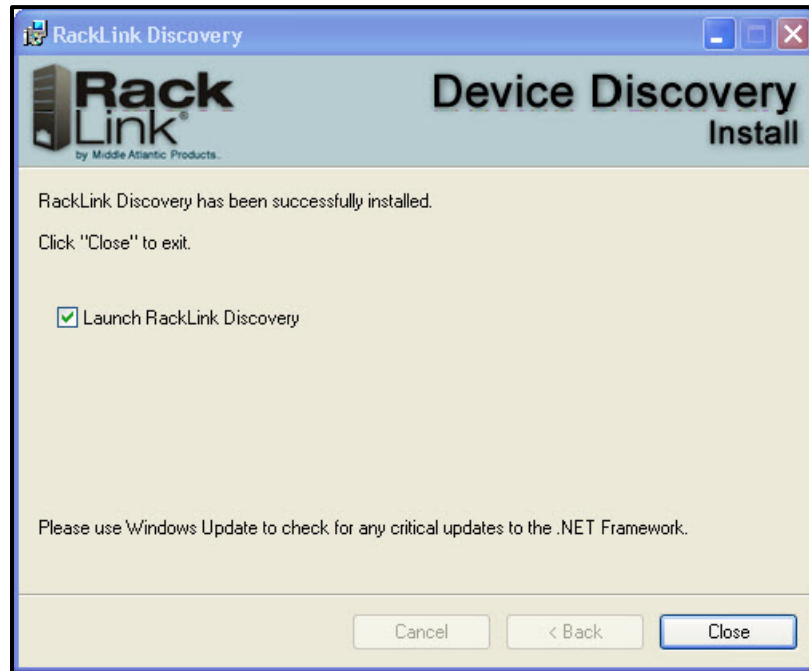

The installer indicates that RackLink Discovery has been successfully installed and provides a default check box selection to Launch RackLink Discovery after closing the installer.

7. Click **Close**.

Installing the RackLink Device Discovery software on a MAC:

To install RackLink Device Discovery software on a MAC:

1. Access www.legrandav.com.
2. Download and run the **RackLinkDiscovery.pkg** file.

The Device Discovery Setup dialog box appears.

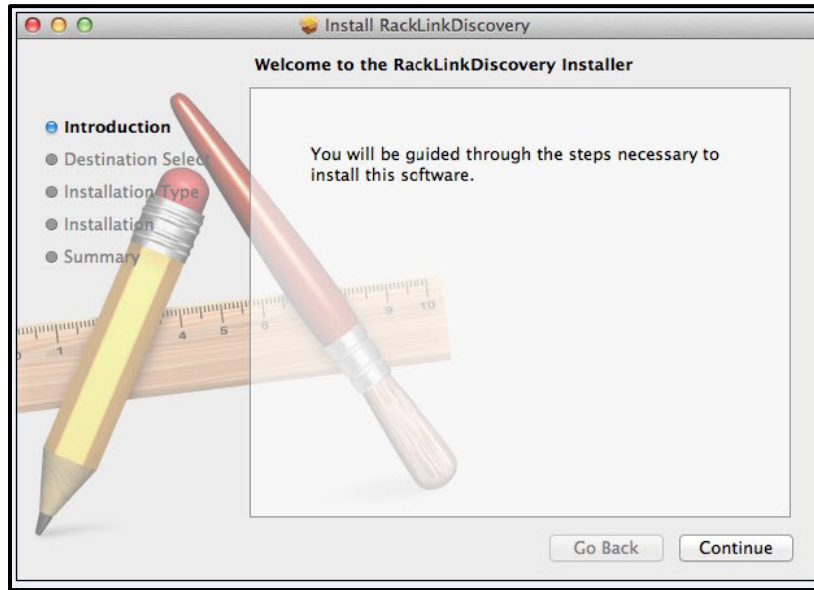

3. Click the disk and modify the location if you wish to change the software installation folder.

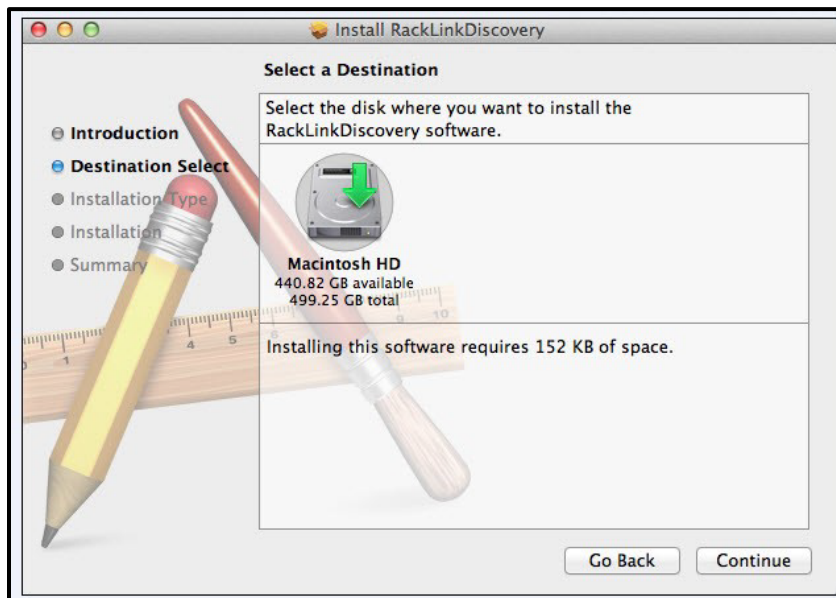

4. Click **Continue**.

The Installation Type screen appears.

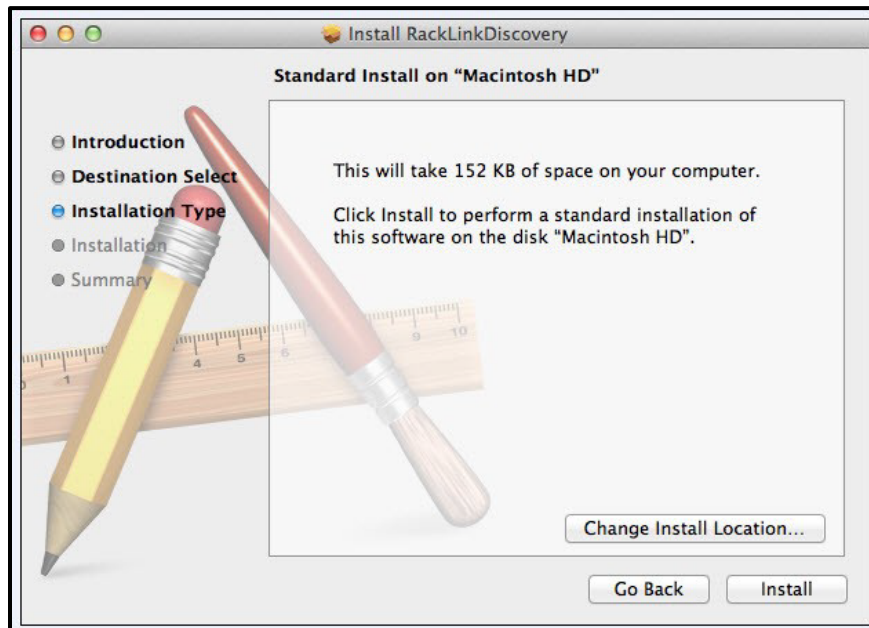

5. Click **Change Install Location** if you wish to change the software installation folder.
6. Click **Install**.
7. The installer indicates that the installation was completed successfully.

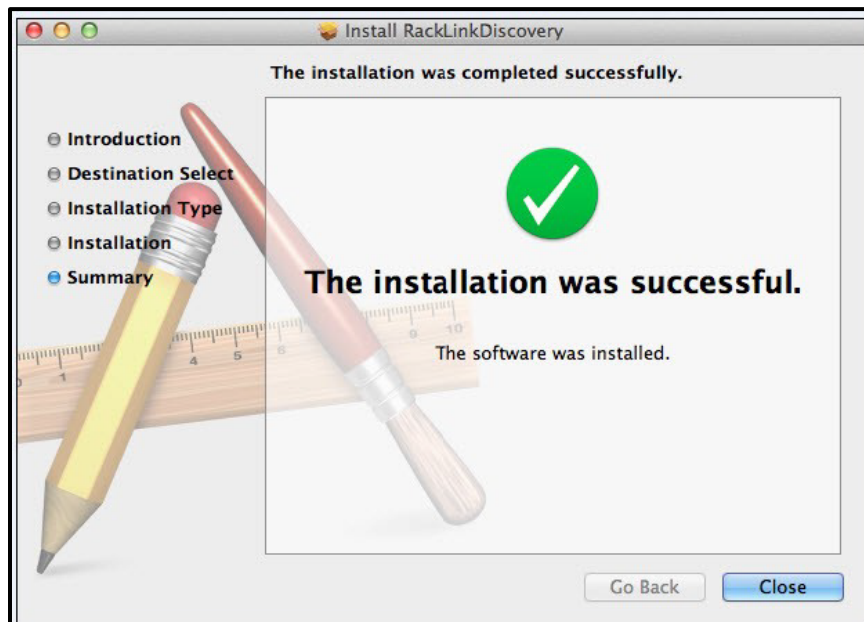

8. Click **Close**.

9. Click **Applications** in the Finder to locate the RackLink Discovery application.

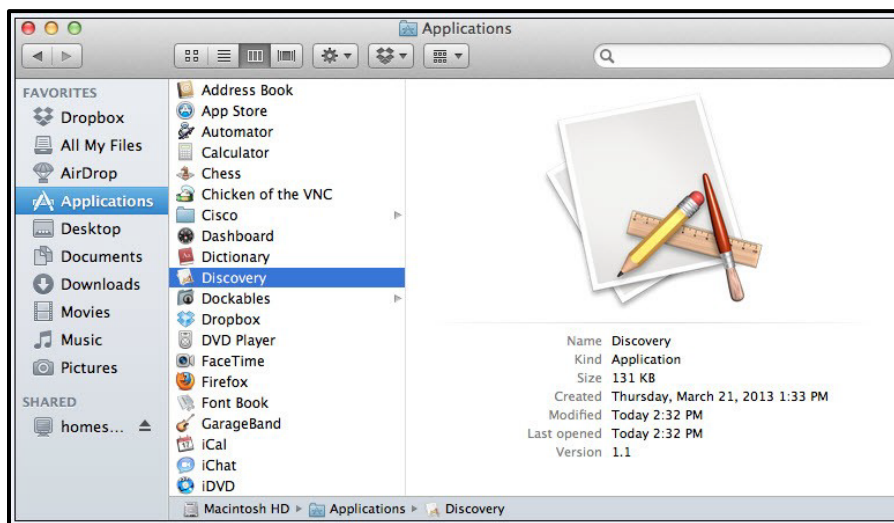

Using Device Discovery

To use device discovery:

1. After launching your RackLink Device Discovery program, the tool automatically discovers all RackLink devices on the subnet to which you are connected.

Use the Discover button to refresh the screen and discover any newly connected RackLink devices. By default, the RackLink device is set for DHCP. You can identify each device by the MAC address or IP address.

NOTE: You may need to disable your Windows firewall to discover your RackLink device.

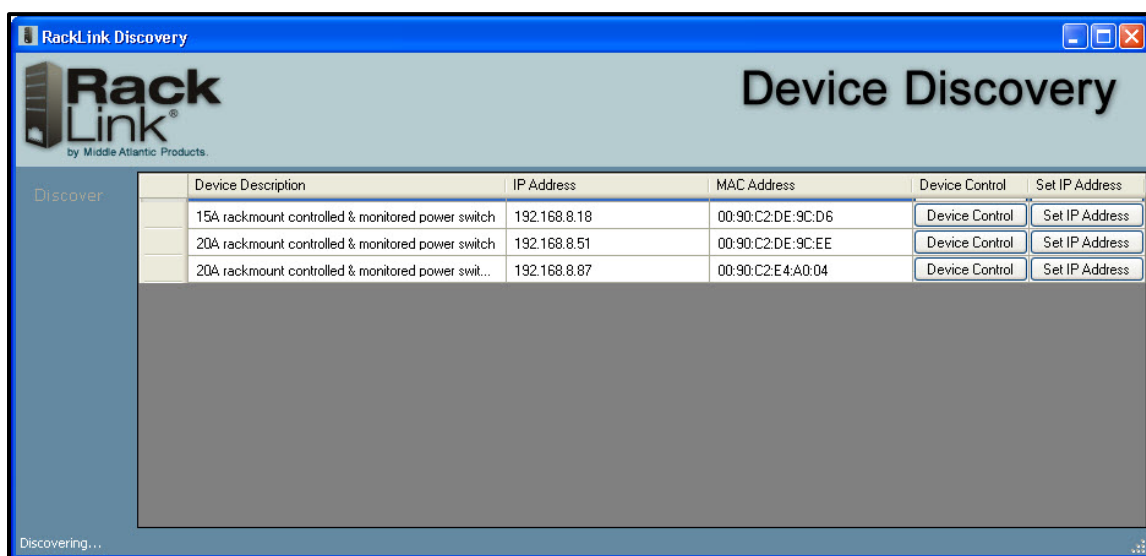

2. Click **Device Control** to access the browser-based interface for a specific device.

The system prompts you for a username and password.



NOTE:

- To log in with the administrator account, the default credentials are Username: **admin** Password: **admin**.
- To log in with the user account, the default credentials are Username: **user** Password: **user**.

After logging in for the first time, the system forces you to change the default passwords for the administrator, user, and control system accounts for security purposes. For more information, see "Logging in to the Browser-Based Interface" on page 27.

SETTING UP YOUR RACKLINK DEVICE FOR THE FIRST TIME

Out of the box, your RackLink device is configured to use DHCP. If you are using a DHCP server, your RackLink device should work automatically, and you can skip to “Using the Browser-Based Interface” on page 26. If you are not using a DHCP server, use the following procedures to configure your RackLink device using a static TCP/IP address.

The following items are required:

- A RackLink device.
- A network crossover cable (Cat5e or better, not provided).
- A standard network cable (Cat5e or better, not provided).
- A pen and paper.

NOTE: The following procedure shows steps using Windows 7. The setup steps are similar in other operating systems.

Configuring TCP/IP on Your PC

First configure TCP/IP on your PC, and then configure TCP/IP on your RackLink device via either the browser-based interface or Device Discovery. For more information, see “Configuring TCP/IP in RackLink via Browser-Based Interface” on page 24.

To configure TCP/IP on your PC:

1. Disconnect the PC from any networks.
2. Click **Start**.

3. Click **Control Panel**.

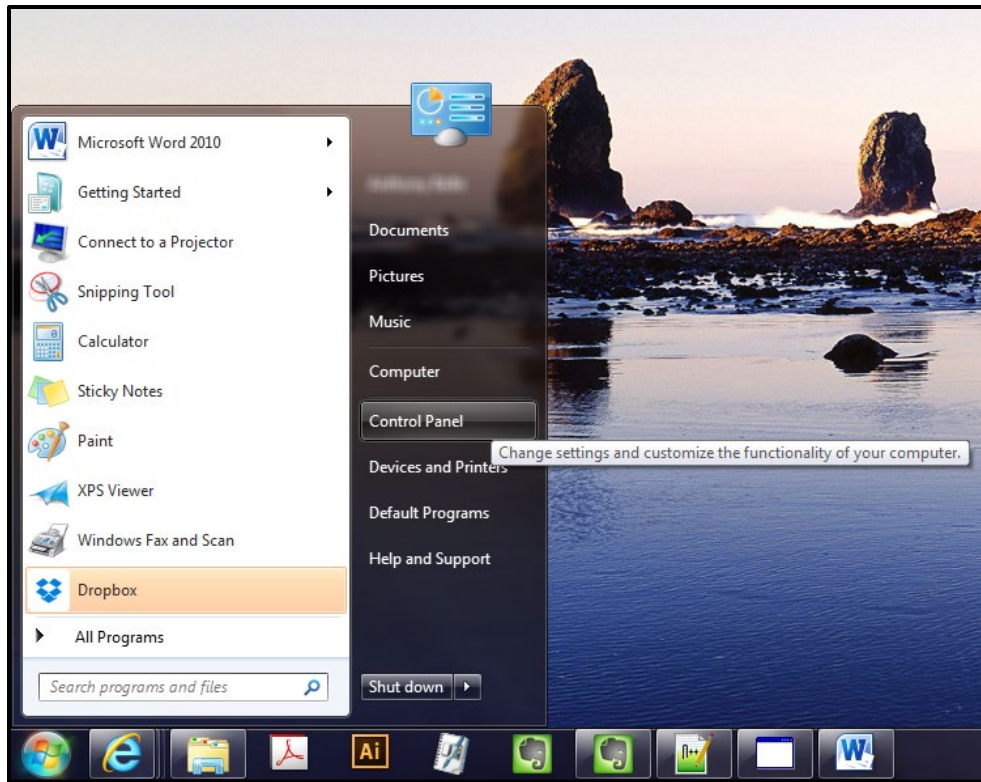

The Control Panel appears.

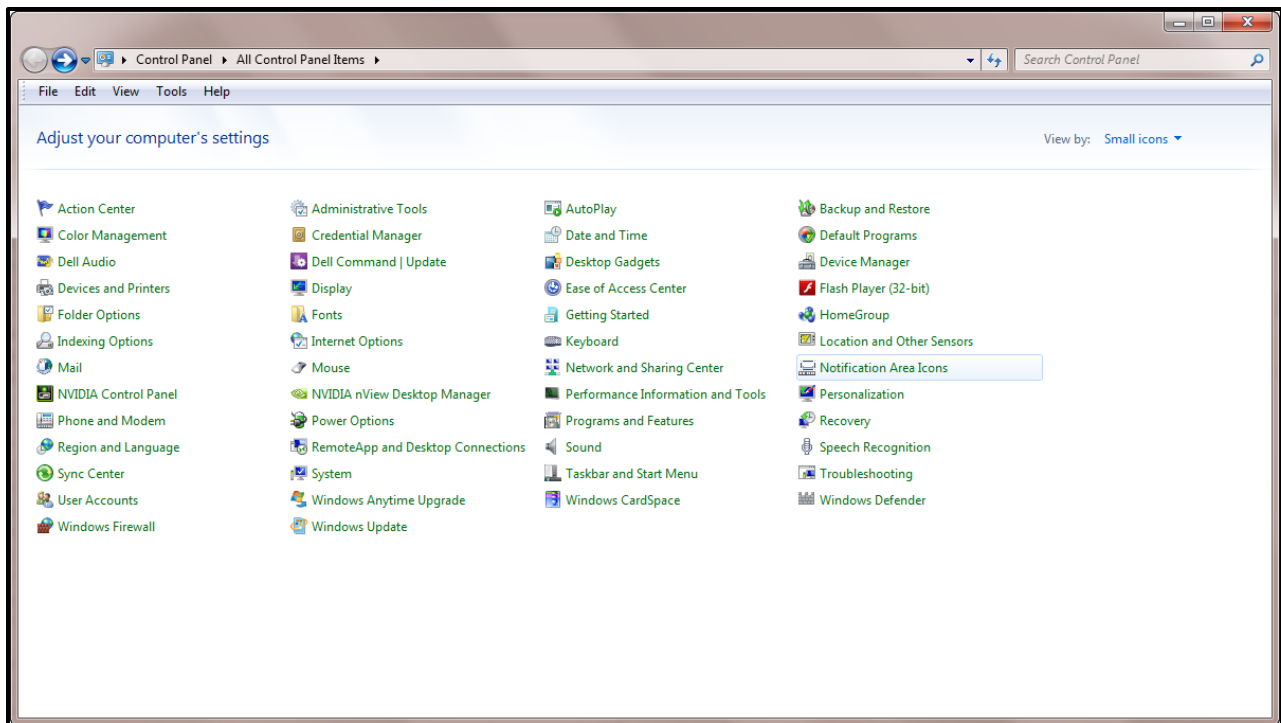

4. Double click **Network Sharing Center**.

The Network Sharing Center screen appears.

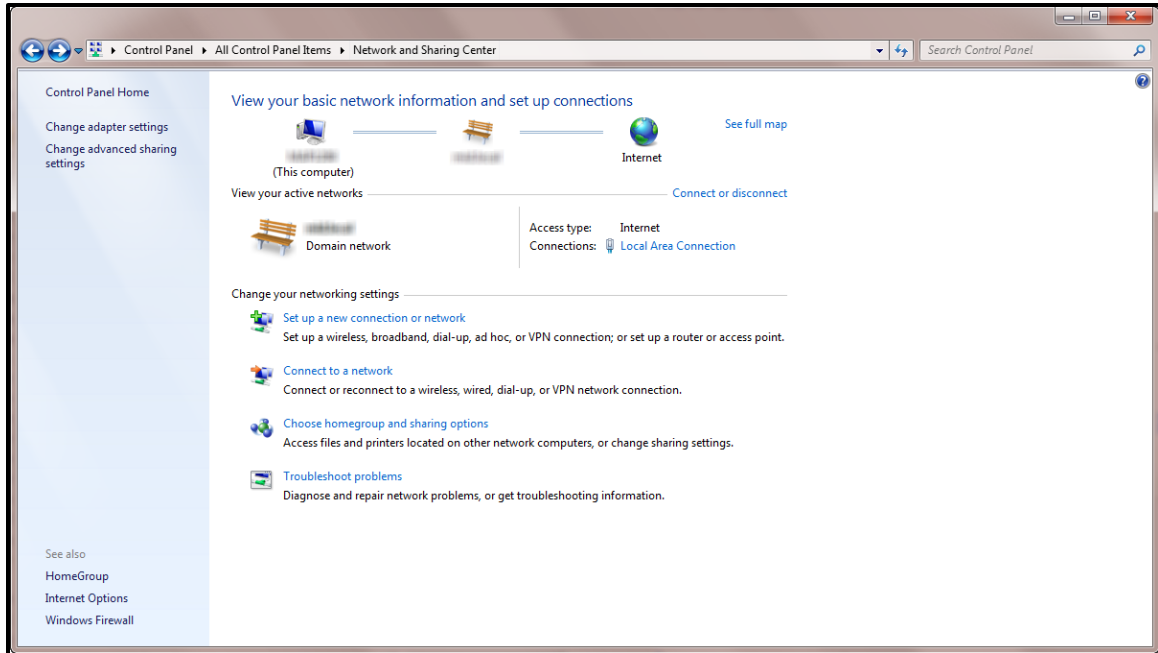

5. Click **Change adapter settings**.

The Network Settings screen appears.

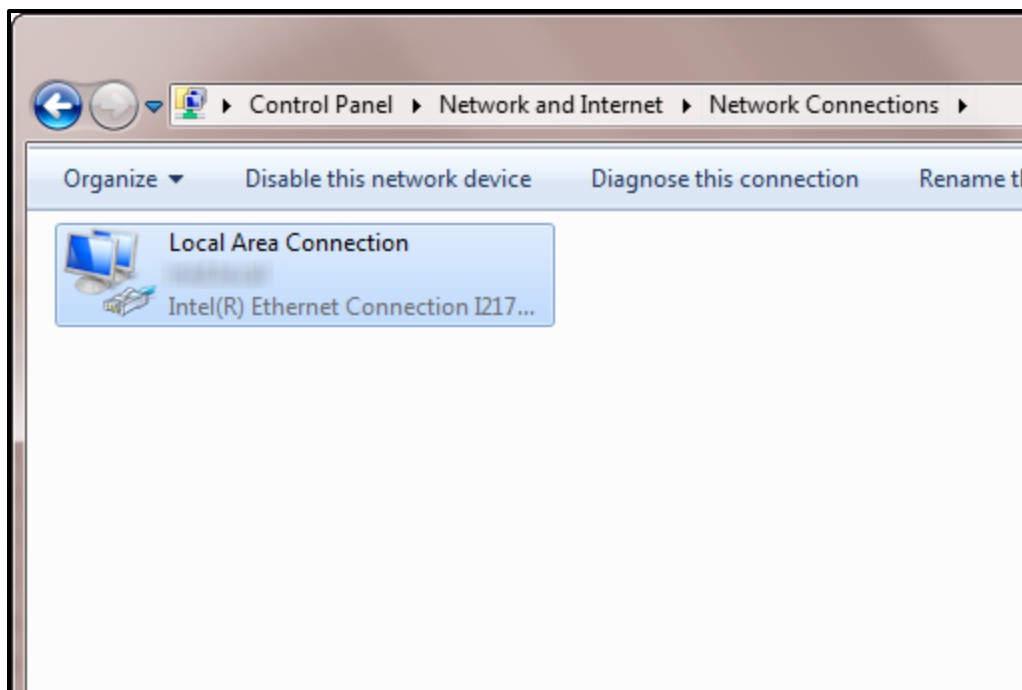

Locate the computer's wired network connection, which should be listed in the LAN or High-Speed Internet group and be named similar to "Local Area Connection."

6. Right-click the wired network connection and select **Properties**.

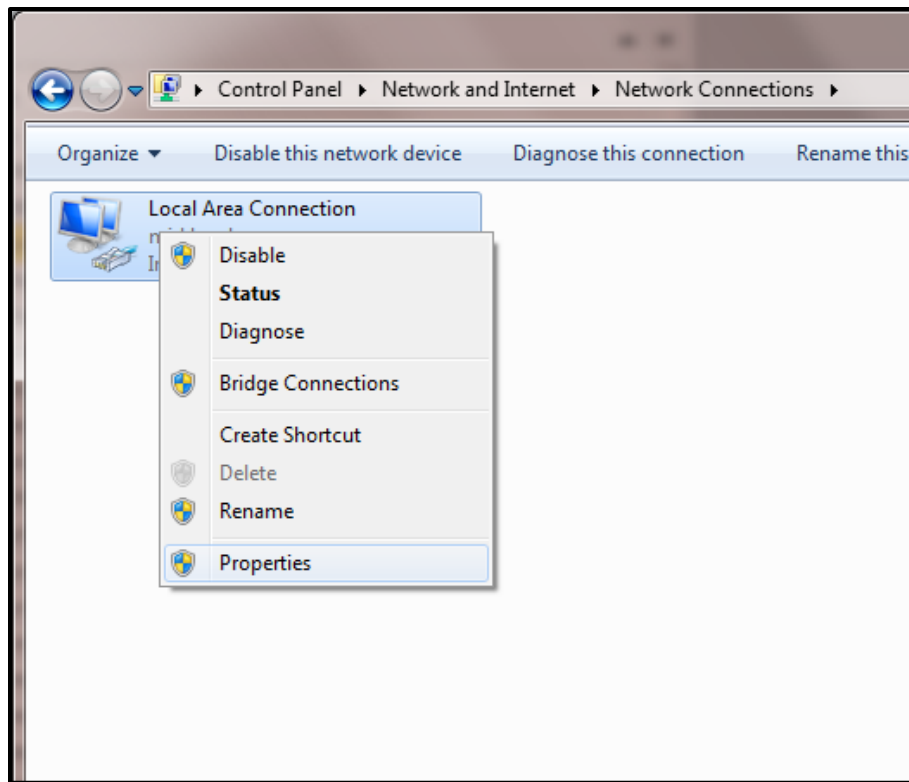

The Local Area Connection Properties window appears.

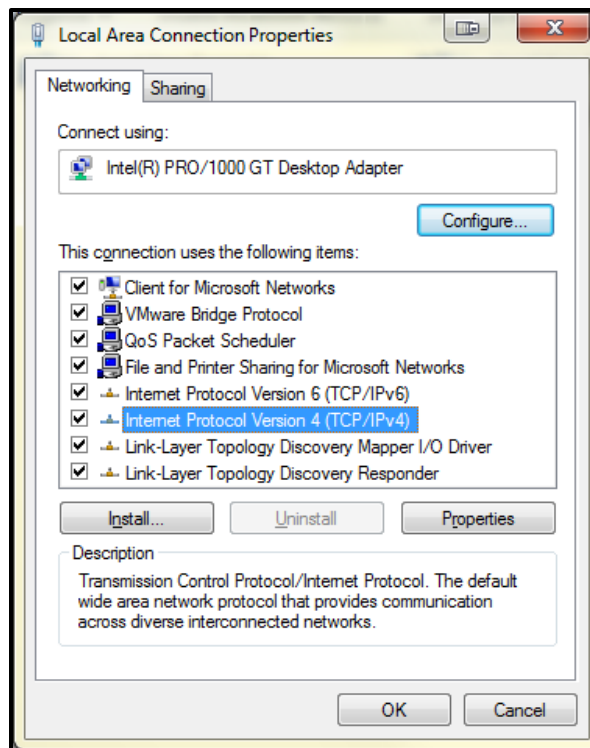

7. Click **Internet Protocol Version 4 (TCP/IPv4)** to highlight the row.

8. Click **Properties**.

The Internet Protocol (IP) Properties window appears.

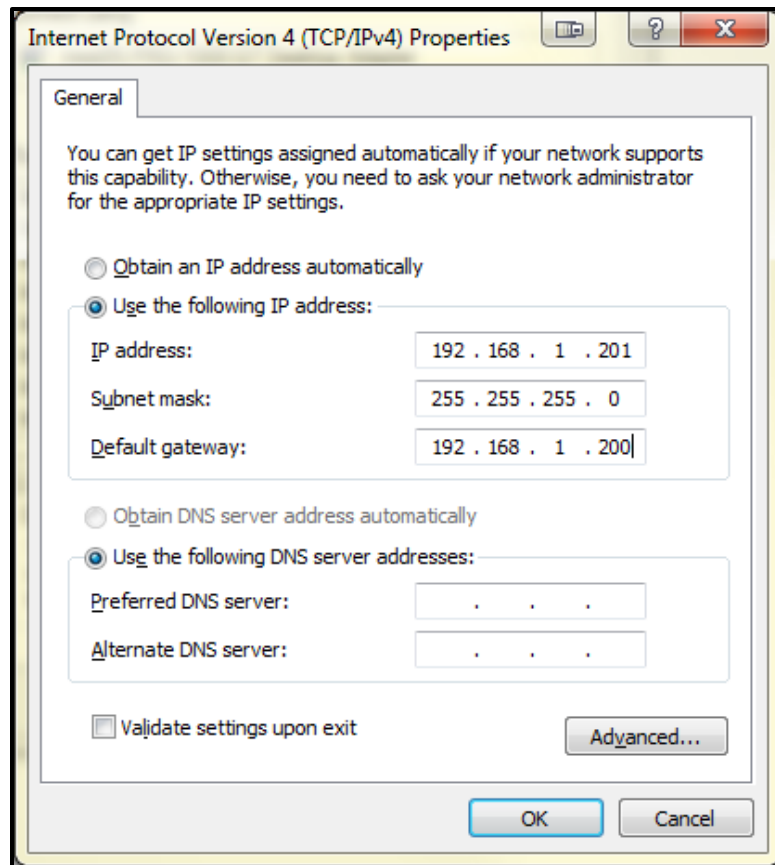

9. Write down the computer's current TCP/IP settings.

NOTE: Save these settings. You will use them to restore the computer back to the original configuration after your RackLink device is directly connected to your PC.

10. Select Use the following TCP/IP address and configure the following:

- In the IP address field, enter 192 . 168 . 1 . 201.
- In the Subnet mask field, enter 255 . 255 . 255 . 0.
- In the Default gateway field, enter 192 . 168 . 1 . 200.

11. Click **OK**.

NOTE: You may need to reboot your PC for the new settings to take effect.

Configuring TCP/IP in RackLink via Browser-Based Interface

First configure TCP/IP on your PC, and then configure TCP/IP on your RackLink device using the browser-based interface. For more information, see “Configuring TCP/IP on Your PC” on page 20.

To configure TCP/IP in RackLink via the browser-based interface:

1. With your RackLink device still powered off, plug one end of the network crossover cable into the network jack on the rear of your RackLink device.
2. Plug the other end of the network crossover cable into the PC's network jack.
3. Plug in and power on your RackLink device.

NOTE:

- After a few seconds, the computer and the RackLink unit should establish a network connection.
 - The RackLink's alert light blinks red when it is attempting to acquire a network address. The alert light stops blinking once it has a valid TCP/IP address.
4. Open a web browser on the PC (Microsoft Internet Explorer 9 or later is recommended) and navigate to <http://192.168.1.200>.
 5. Log in to the browser-based interface with the administrator account.
For more information, see "Logging in to the Administrator Settings Menu" on page 40.
 6. Click **Network**.
 7. Change the network information to your preferred values for IP Address, Subnet Mask, Gateway, and DNS Server.
 8. Click **Save**.

NOTE: After these settings have been changed, you no longer can access your RackLink device from your PC connected via crossover cable.

9. Disconnect the network crossover cable connecting your RackLink device and your PC.
10. Restore the PC to the original TCP/IP settings using the information you wrote down during "Configuring TCP/IP on your PC" on page 20.
11. Put your RackLink device in its final location.

DOWNLOADING AND USING THE MOBILE APP

The mobile application allows real-time control of any controllable outlet from your mobile phone. Download the RackLink app from the Google Play™ store or the App Store®.

USING THE BROWSER-BASED INTERFACE

The browser-based interface allows you to control your RackLink device from a PC. You can access it from the Device Discovery tool or by entering your RackLink device's IP address in a browser.

Logging in to the Browser-Based Interface

To log in to the browser-based interface:

1. Install and launch your RackLink Discovery software and connect to a RackLink device.

For more information, see “Installing the Device Discovery Software and Accessing a Connected RackLink’s Browser-Based Interface” on page 13.

The RackLink device prompts you for credentials.



The default names and passwords for the Administrator, User, and Control Systems accounts, respectively, on your RackLink device are as follows:

Administrator Account	User Account	Control System Account
Username: admin Password: admin	Username: user Password: user	Username: user Password: password

After logging in for the first time, the system forces you to change the default passwords for the administrator, user, and control system accounts for security purposes.

NOTE:

- Log in for the first time using the administrator account in order to change the passwords for all of the accounts.
- External devices access your RackLink’s serial API via the Control System account. This account is not used to access the browser-based interface.

2. Enter the credentials for the account you wish to use.
3. Click **Login**.

The Dashboard appears.

Every screen of the browser-based interface includes your connected RackLink device's name and model number, and firmware version with the facility code.

NOTE:

- The Administrator Settings menu only appears when logged in using the Admin account. For more information, see “Configuring Administrator Settings” on page 39.

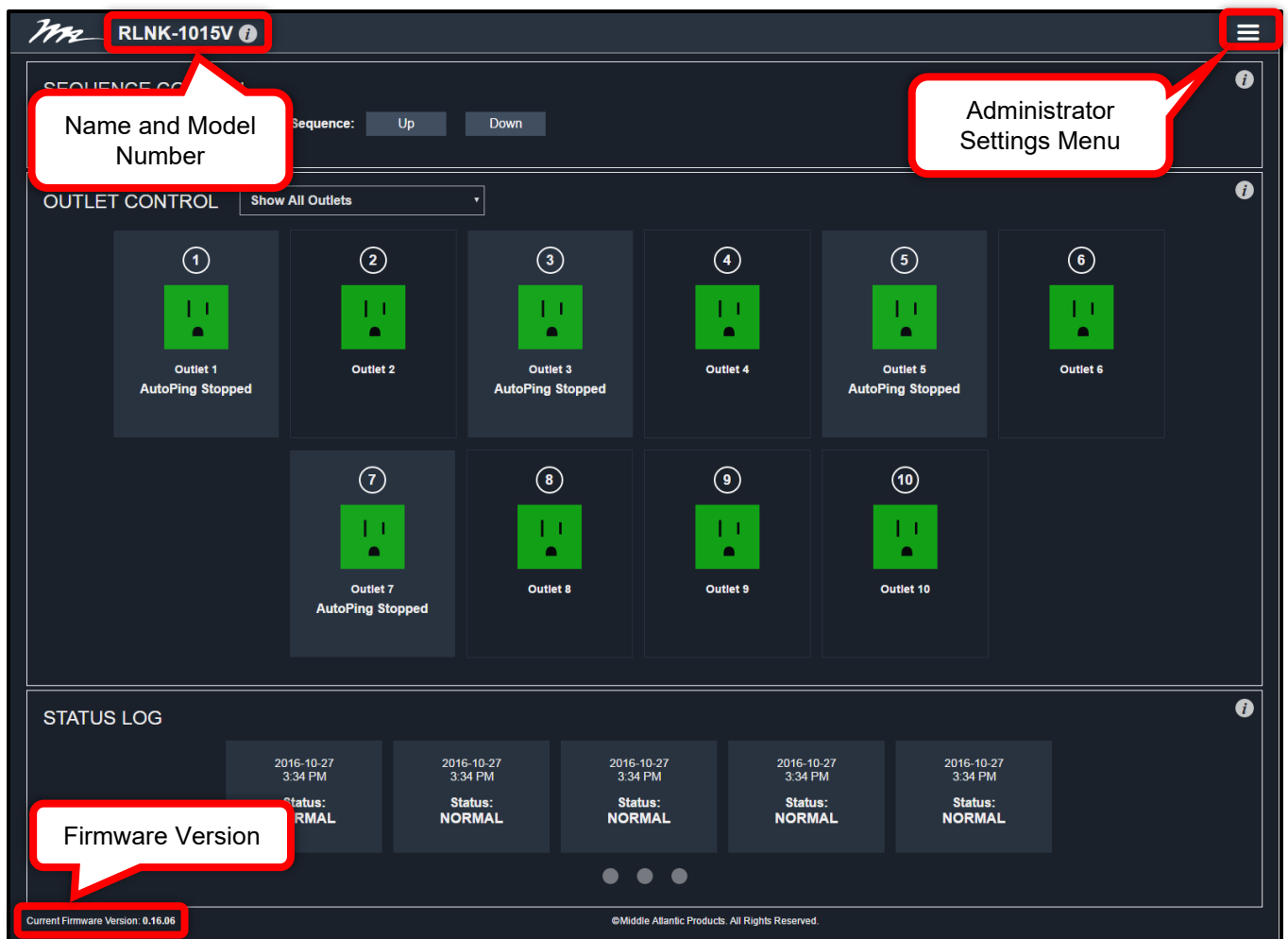

- Some screenshots have been slightly modified to improve legibility.
- The number of outlets appearing on the Dashboard is model specific. For more information, see “RackLink Select Model Diagrams” on page 59.
- The device name can be modified in the Administrator Settings. For more information, see “Configuring Administrator Settings” on page 39.

Understanding System Confirmations

You'll notice the following types of system feedback while interacting with your device via the Browser-Based Interface.

- Warnings appear as a prompt in the upper, center part of the screen.

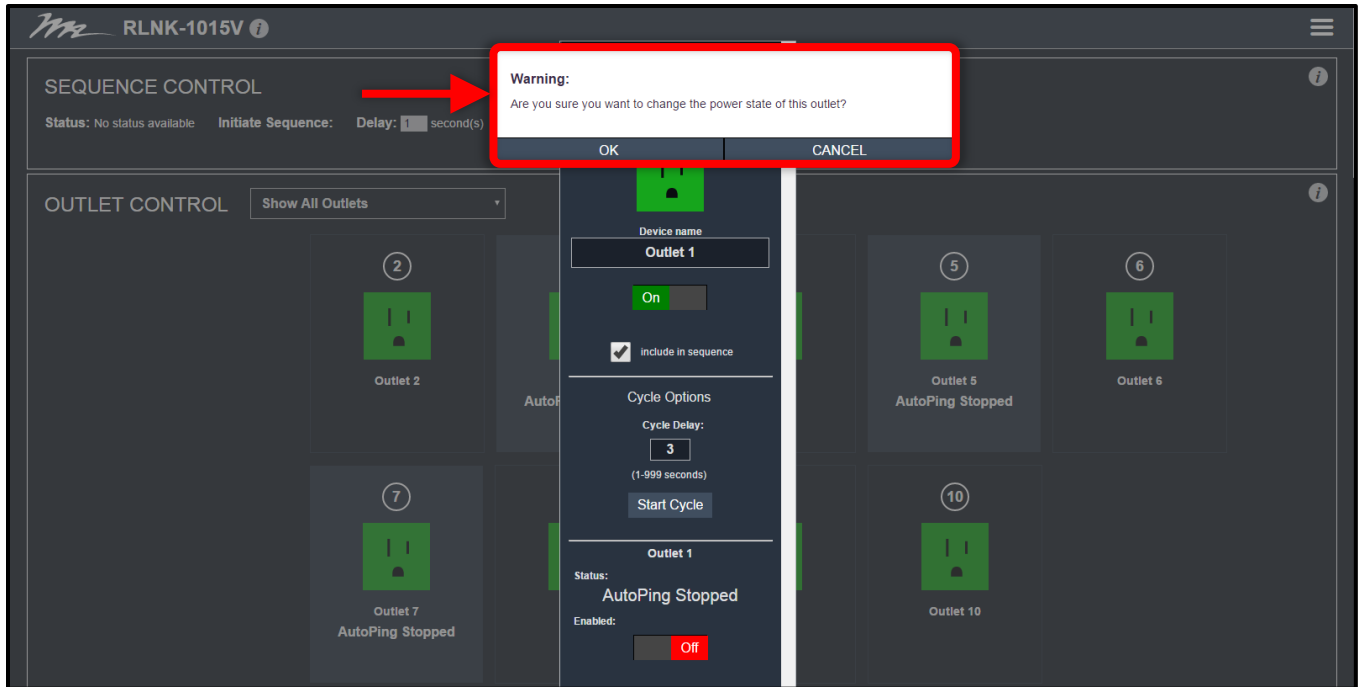

- Error notifications appear in a bar that comes down from the top of the screen.

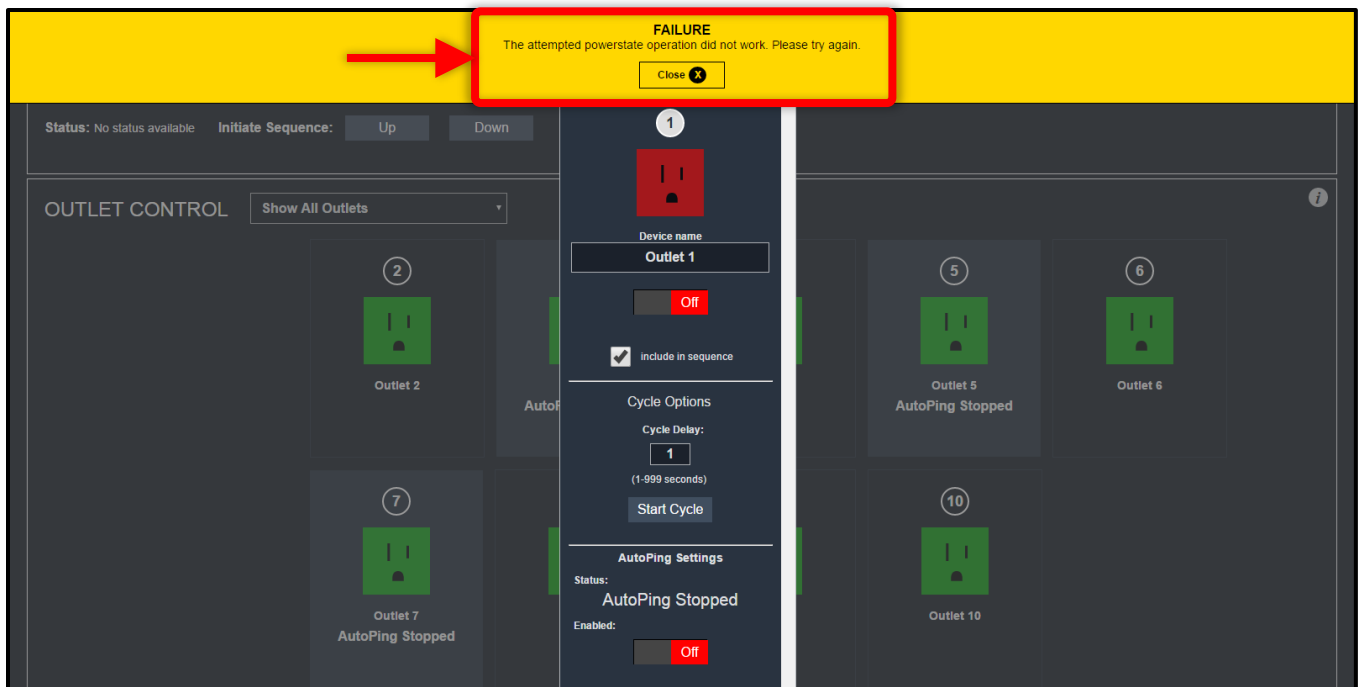

- Messages in a box on the upper-right corner of the screen indicate that an action you performed was successful.

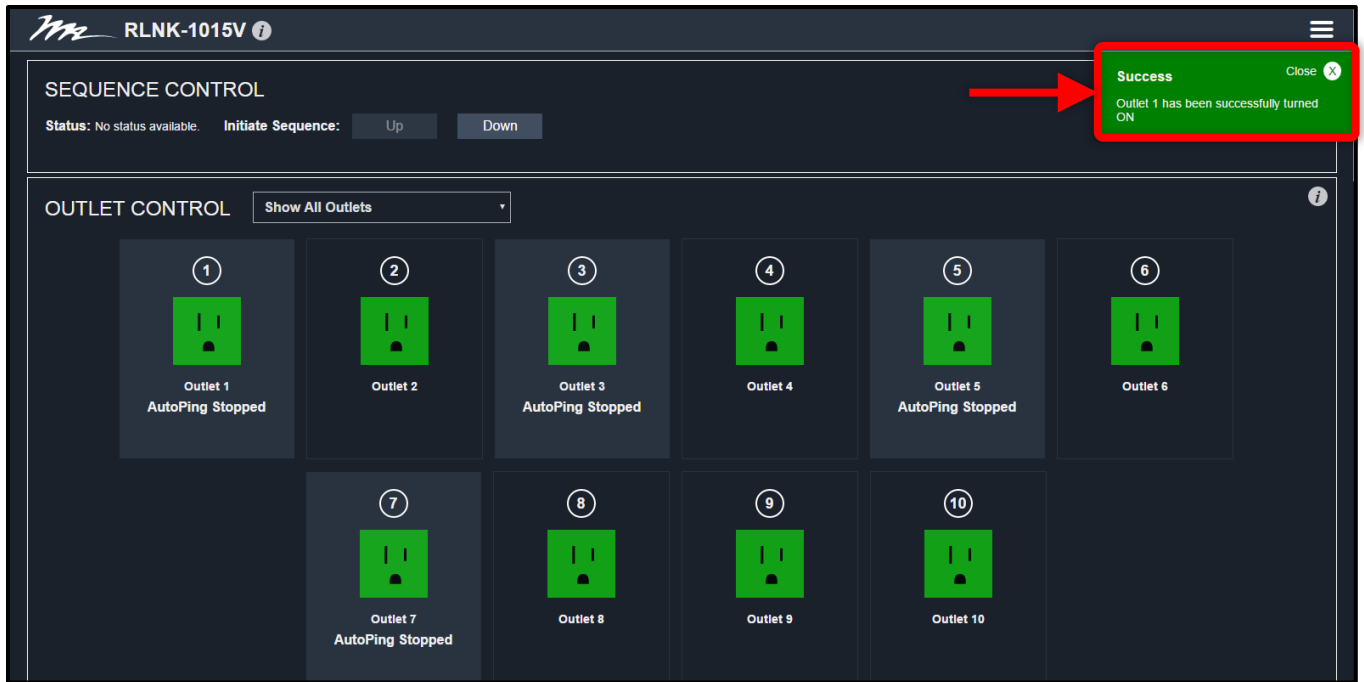

- Input validation is performed on all text input fields. The system highlights the field in red and provides a warning indicating the requirements for submitting a proper text input field value.

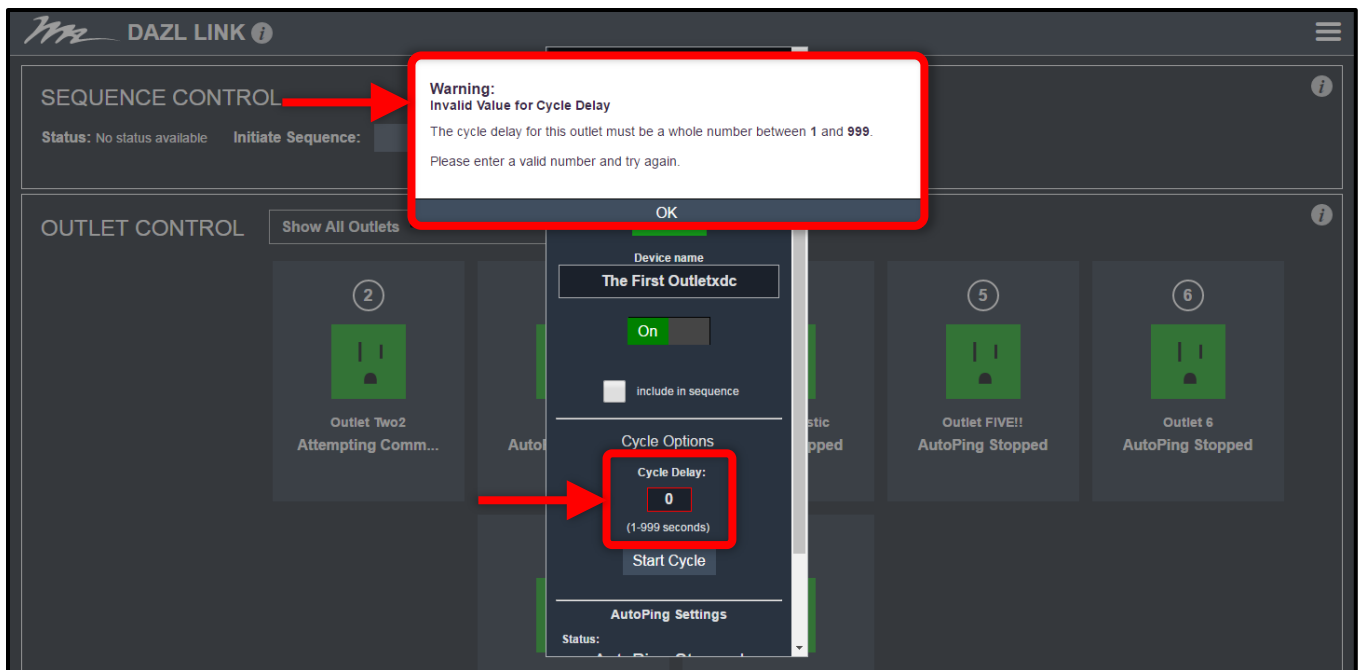

Viewing Help Information

To view help information:

1. Install and launch your RackLink Discovery software and connect to a RackLink device.
For more information, see “Installing the Device Discovery Software and Accessing a Connected RackLink’s Browser-Based Interface” on page 13.
2. Enter the credentials for the account you wish to use. For more information, see “Logging in to the Browser-Based Interface” on page 27.
3. Click an **Information** icon.

Corresponding help information appears.

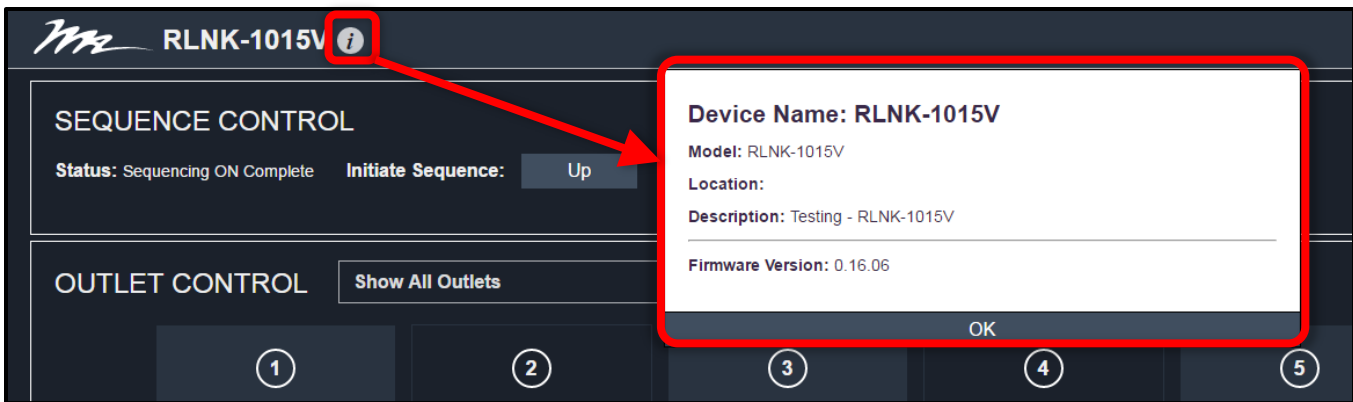

4. Click **OK**.

Viewing and Configuring Information on the Dashboard

The Dashboard is the main interface and includes Sequence Control, Outlet Control, and Status Log sections.

Initiating a Sequence

To initiate a sequence:

1. Install and launch your RackLink Discovery software and connect to a RackLink device.
For more information, see “Installing the Device Discovery Software and Accessing a Connected RackLink’s Browser-Based Interface” on page 13.
2. Enter the credentials for the account you wish to use. For more information, see “Logging in to the Browser-Based Interface” on page 27.
3. View the sequence status information as follows:

- View the Status field to see the current sequence state. With sequencing disabled, the field shows “Not Sequenced”. If sequencing has not been initiated or if any sequenced outlet has changed state, the field shows “Not Sequenced”. Otherwise, one of the following statuses appear in this field:
 - Sequencing ON in Progress
 - Sequencing ON Complete
 - Sequencing OFF in Progress
 - Sequencing OFF Complete

4. Use the Initiate Sequence buttons to start a sequence as follows:

- Click **On** or **Off** to initiate a sequence to activate or deactivate the outlets (depending on the initial state of the outlets on your RackLink unit).

After selecting On or Off, then adjust the delay.

- In the Delay field, enter a delay value (in seconds) for the amount of time you wish to elapse between each controlled outlet in the sequence. The set delay time applies to all sequenced outlets and can be set from 0 – 255 seconds.
- Click **Initiate** after setting the delay.

Configuring Outlet Controls

To configure outlet controls:

1. Install and launch your RackLink Discovery software and connect to a RackLink device.

For more information, see “Installing the Device Discovery Software and Accessing a Connected RackLink’s Browser-Based Interface” on page 13.

2. Enter the credentials for the account you wish to use. For more information, see “Logging in to the Browser-Based Interface” on page 27.

The Dashboard appears.

3. At the top of the Outlet Control section of the screen, the outlet drop-down provides the following viewing choices:

- Show All Outlets
- Show In Sequence Outlets Only
- Show AutoPing Enabled Outlets Only
- Show Controlled Outlets Only

- Click a controlled outlet under the outlet drop-down to access the following additional outlet settings:



NOTE: Outlet, Cycle Option, and AutoPing settings all appear on a single outlet dialog. They are broken into respective parts in this topic for clarity.

- The Number indicates the outlet number on your RackLink device.
- In the Device name field, modify the device name, as desired.

NOTE: Number and Device name are shown for Always On outlets. Controlled outlets have additional options as explained in the remainder of this topic.

- Use the On/Off switch to activate or deactivate the controlled outlet, as desired.

NOTE: Vertical RackLink models (RLNK-1015V and RLNK-1615V) start with a controlled outlet and then alternate with always on outlets down the unit. The dashboard shows the alternating controlled outlets. On the RLNK-1015V model, shown below, the last three outlets are always on.

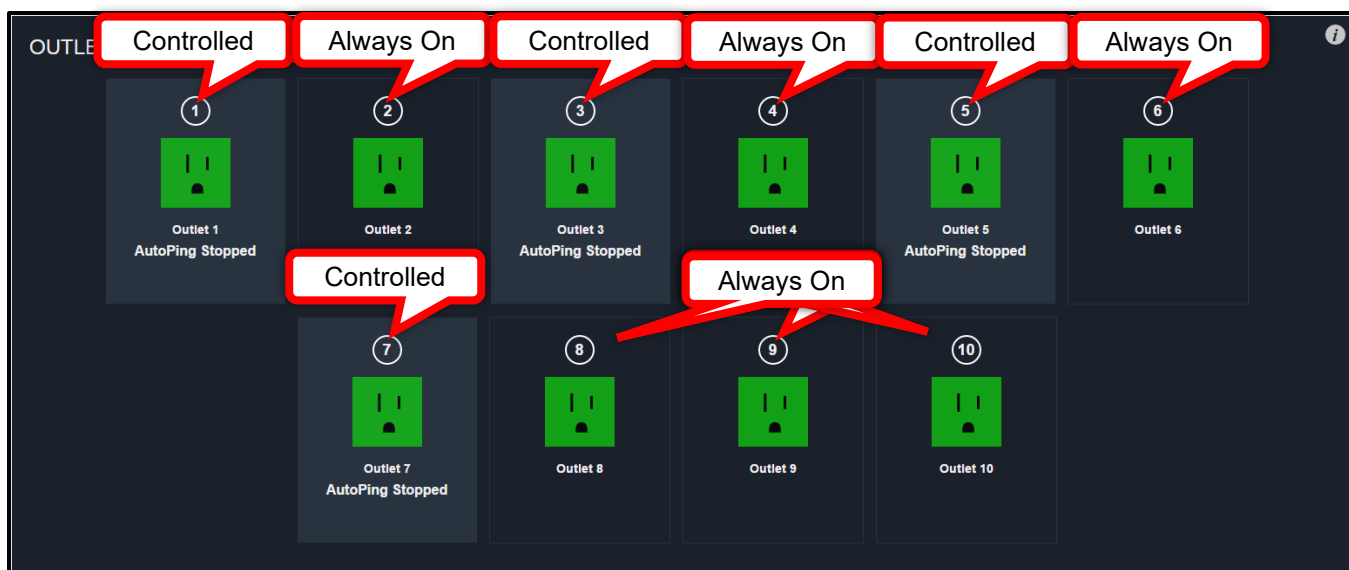

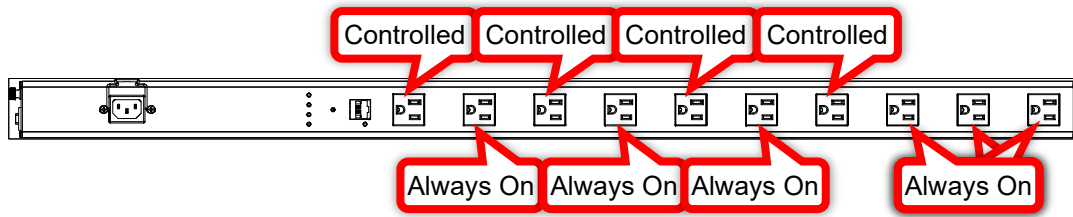

- Select the Include in Sequence check box to include or exclude the specific controlled outlet as part of the overall sequence. This option is selected by default.

5. The following cycle option settings appear in the Cycle Options section:

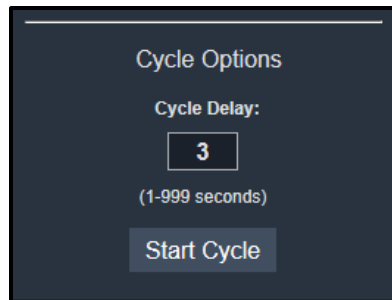

NOTE: Outlet, Cycle Options, and AutoPing settings all appear on a single outlet dialog. They are broken into respective parts in this topic for clarity.

- In the Cycle Delay field, enter a cycle delay value (1 – 999 seconds with a 3 second default), as desired.
- Click **Start Cycle** to cycle the outlet power one time only when the outlet is on.

NOTE: New commands received on a given outlet supersede the cycle command.

6. The following AutoPing settings appear in the AutoPing section:

The screenshot shows the 'Auto Ping Settings' dialog. At the top, the status is 'AutoPing Stopped'. Below that, the 'Enabled' toggle is set to 'On'. The 'IP Address to Ping' field is empty. The 'Frequency' is set to 30 seconds, with a range of 30-999 seconds. The 'Retries' are set to 3, with a range of 2-200. The 'Email Enabled' toggle is set to 'On'. The 'Recovery Action' dropdown menu is set to 'None'.

NOTE:

- Outlet, Cycle Options, and AutoPing settings all appear on a single outlet dialog. They are broken into respective parts in this topic for clarity.
- AutoPing settings may be used to configure your RackLink device to automatically Ping another IP address and create actions in the event of a failure.

TIP: For an example AutoPing configuration, see “Understanding an AutoPing Configuration” on page 53.

- In the Status display field, view the current status of communication between your Ping device and your RackLink device outlet. You can see the status from the dashboard and in the outlet details. The statuses and corresponding color indicators include the following:
 - **AutoPing Replied** (Green text appears.)
 - **AutoPing Failed** (Red text appears.)
 - **AutoPing not started** (White text appears.)
 - **Attempting communication...** (White text appears.)
 - **Starting AutoPing...** (White text appears.)
 - **Stopping AutoPing...** (White text appears.)
 - **AutoPing Stopped** (White text appears.)
 - **No status** (White text appears.)

NOTE: The Alert LED is red if any outlet has a failed AutoPing, or green if all outlets indicate AutoPing replied.

- In the Enabled field, select to turn AutoPing On or Off for the specific outlet.
- In the IP Address field, enter the IP address of the Ping device.
- In the Frequency field, enter how often (in seconds) your RackLink device initiates an AutoPing. You can configure 30 - 999 seconds and the default is 30.
- In the Retries field, enter the number of times your RackLink device will Ping the preset address if no response is received. You can configure 2 - 200 retries and the default is 3. For example, using the default settings with a Frequency of 30 seconds and three Failures, the device being Pinged would need to be offline for 90 seconds before the recovery action is executed.
- In the Email Enabled field, select to turn email notifications On or Off for the specific AutoPing from your outlet.

For more information, see “Configuring Email Settings” on page 44.

- In the Recovery Action drop-down field, set a desired outlet action while the configured Ping device does not reply. The actions cease whenever the Ping device does reply. The actions include the following:
 - Power-cycle Until Recovery
 - Power-cycle Once
 - Power Off Pending Recovery
 - Power Off
 - Power On Pending Recovery
 - Power On

NOTE: Only one action per outlet can be performed at a time.

- In the Cycle Time field, enter a cycle time delay value (in seconds) for the specific AutoPing recovery action. You can configure the delay to be between 1 - 999 (inclusive) seconds and the default is 3.

NOTE: The Cycle Time option only appears when the Power-cycle Until Recovery action is selected.

7. Click **Save**.

TIP: To restore the default settings, see “Restoring Factory Defaults” on page 46.

Viewing Status Log Information

To view status log information:

1. Install and launch your RackLink Discovery software and connect to a RackLink device.

For more information, see “Installing the Device Discovery Software and Accessing a Connected RackLink’s Browser-Based Interface” on page 13.

2. Enter the credentials for the account you wish to use. For more information, see “Logging in to the Browser-Based Interface” on page 27.

The Dashboard appears.

The Status Log section of the screen includes log entries for events taking place in your RackLink device.

NOTE: Click the circles to scroll horizontally and access any additional logs.

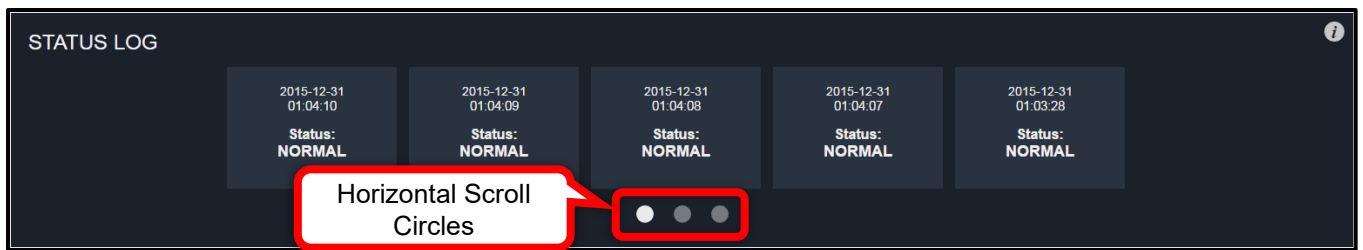

3. Logs shown on the dashboard provide the following data:

- Date, Time, and Status (of the log event).

Log entry statuses indicate the following reasons:

- Normal Event
- AutoPing Fault
- AutoPing Recovery

4. Click a log entry to view log entry details.

- The date, time and status appear on the details screen.
- The outlet that changed is listed and visually highlighted on the details screen.
- The Room Occupancy field shows the current occupancy status as set by the control system.

5. Select the log details view from the following options:

- Select the Outlet Status option to show the state of each outlet at the time of the event. The highlighted outlet is the one changed by the specific event.

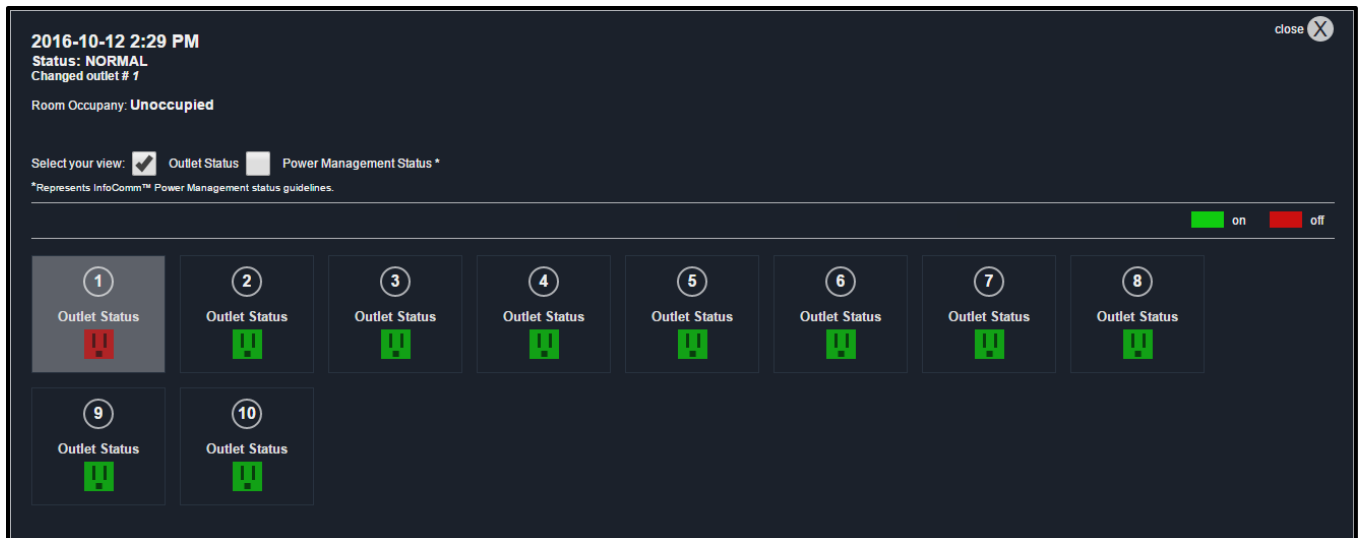

The Outlet statuses are as follows:

- On
- Off
- Select the Power Management Status option to view the InfoComm™ Power Management Statuses at the time of the event.

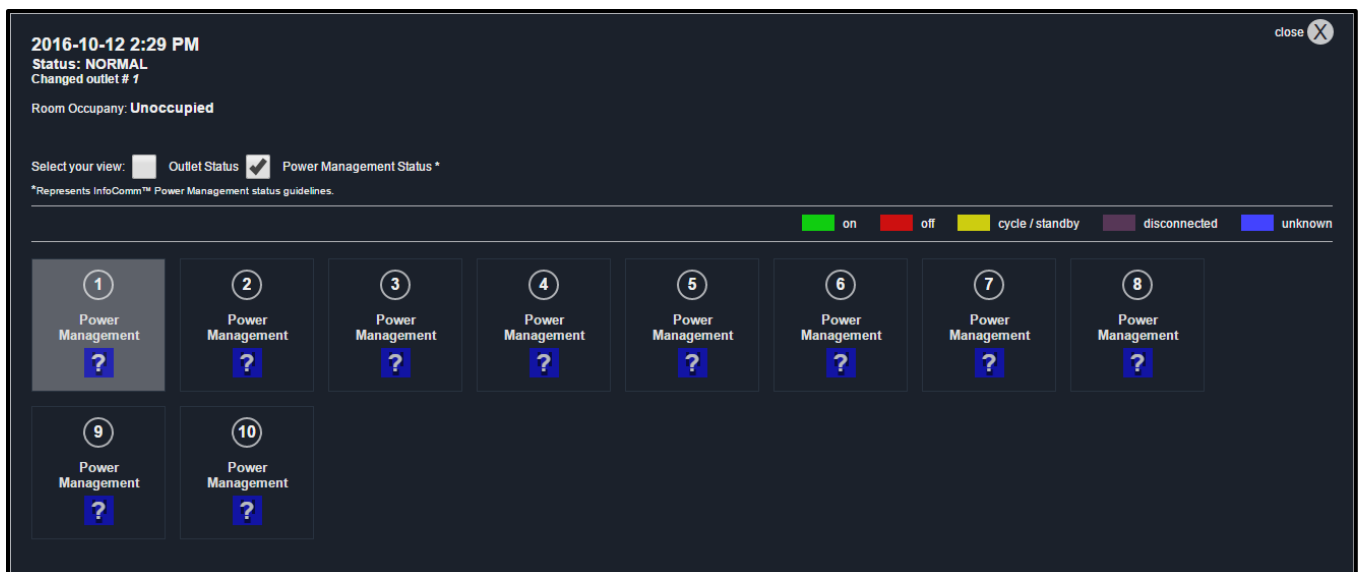

The InfoComm Power Management Statuses are as follows:

- On
- Off

- Cycle/Standby
- Disconnected
- Unknown

NOTE: For more information about the InfoComm Audiovisual Systems Energy Management Standard, refer to

<http://www.infocomm.org/cps/rde/xchg/infocomm/hs.xsl/32933.htm>.

Configuring Administrator Settings

The features on the Administrator Settings menu include Date/Time, Device Settings, Email, Factory Defaults, Firmware Update, Network, and Passwords.

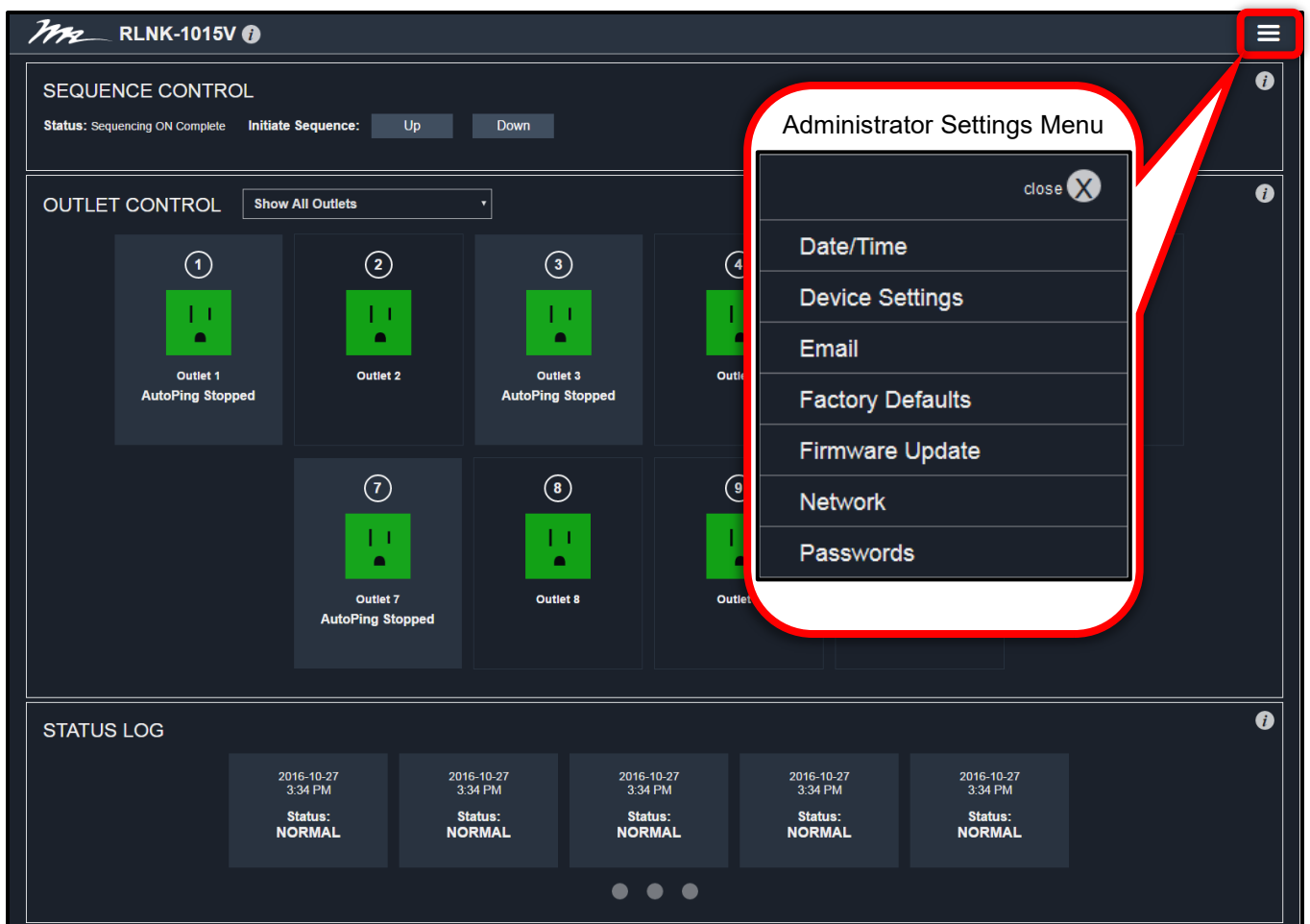

Logging in to the Administrator Settings Menu

NOTE: The Administrator Settings menu is only accessible when logged in using the Admin account. If you are logged into the User account, the Administrator Settings menu is shown in the upper-right corner of the screen, however, you are prompted to log in using the Admin account when any of the options are clicked.

To log in to the administrator settings menu:

1. Install and launch your RackLink Discovery software and connect to a RackLink device.

For more information, see “Installing the Device Discovery Software and Accessing a Connected RackLink’s Browser-Based Interface” on page 13.

2. Log in using the Admin account to access the Administrator Settings menu. For more information, see “Logging in to the Browser-Based Interface” on page 40.

The Dashboard appears.

3. You can now access the Administrator Settings menu on the upper-right side of the screen.

NOTE: When you select Administrator Setting menu items, corresponding screens fly-in from the left side of the Dashboard.

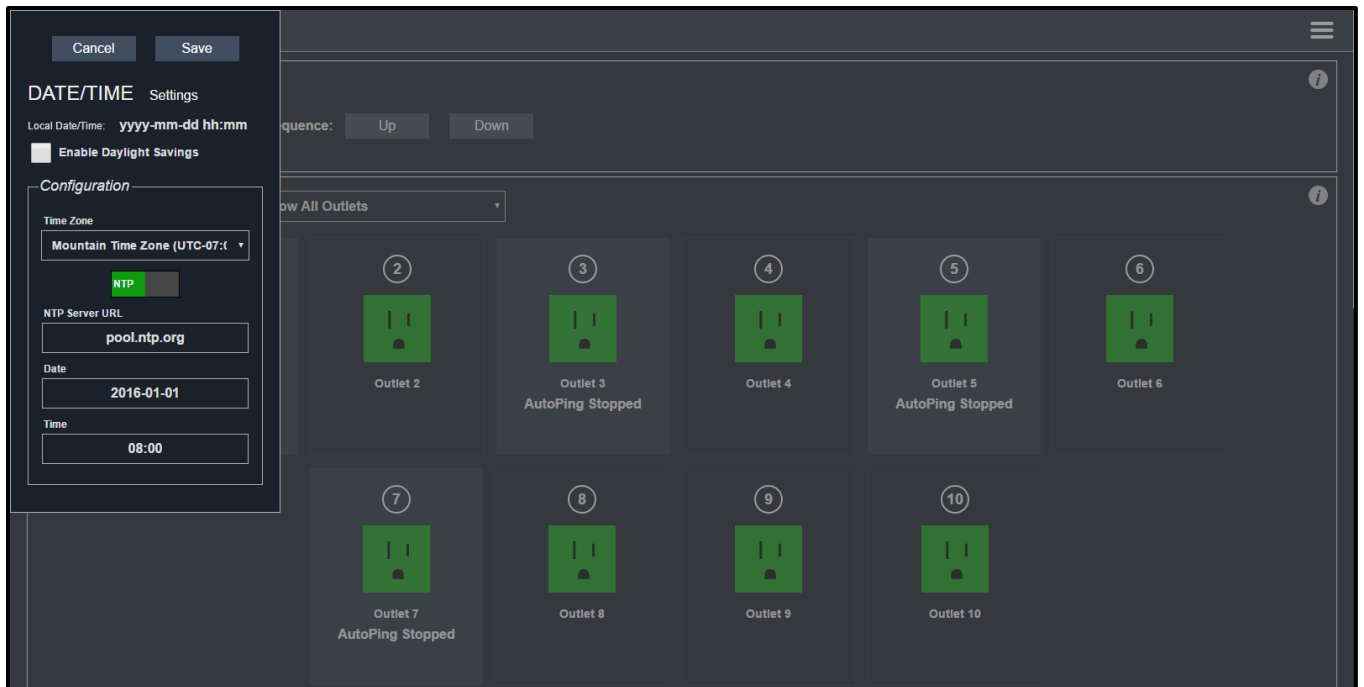

Configuring Date/Time Settings

To configure date/time settings:

1. Install and launch your RackLink Discovery software and connect to a RackLink device.

For more information, see “Installing the Device Discovery Software and Accessing a Connected RackLink’s Browser-Based Interface” on page 13.

2. Log in using the Admin account to access the Administrator Settings menu. For more information, see “Logging in to the Browser-Based Interface” on page 40.
3. Click **Date/Time** on the Administrator Settings menu.

The Date/Time Settings screen appears.

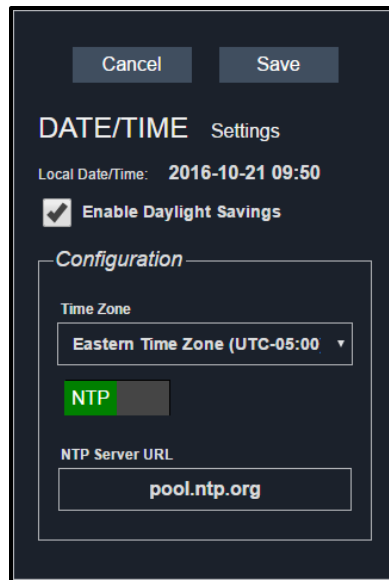

Cancel Save

DATE/TIME Settings

Local Date/Time: 2016-10-21 09:50

Enable Daylight Savings

Configuration

Time Zone

Eastern Time Zone (UTC-05:00)

NTP

NTP Server URL

pool.ntp.org

4. The Local Date/Time section of the screen displays the current date and time.
5. Select the **Enable Daylight Saving** check box to enable daylight saving time, if desired.
6. The Configuration area of the screen includes the following:
 - a. In the Time Zone drop-down, select your desired North American time zone.
 - b. Selecting NTP or Manual produces different fields as follows:
 - Select **NTP** and the NTP Server URL field remains. Specify an NTP server address of your choice. (The default is pool.ntp.org).

- Select **Manual** and the Date and Time fields appear while the NTP Server URL field is removed. Specify a date and time as desired.

DATE/TIME Settings

Local Date/Time: 2016-10-21 09:52

Enable Daylight Savings

Configuration

Time Zone
Eastern Time Zone (UTC-05:00)

Man

Date
2016-10-21

Time
09:52

7. Click **Save**.

TIP: To restore the default settings, see “Restoring Factory Defaults” on page 46.

Configuring Device Settings

To configure device settings:

1. Install and launch your RackLink Discovery software and connect to a RackLink device.
For more information, see “Installing the Device Discovery Software and Accessing a Connected RackLink’s Browser-Based Interface” on page 13.
2. Log in using the Admin account to access the Administrator Settings menu. For more information, see “Logging in to the Browser-Based Interface” on page 40.
3. Click **Device Settings** on the Administrator Settings menu.

The Device Settings screen appears.

4. Configure the Device Settings screen as follows:

- In the Device Name field, enter your desired name for your RackLink device. This value appears in the top of the browser-based interface and is shown in the RackLink Discovery Tool.
- In the Account Name/Number field you may enter a user-defined value for your own reference.
- In the Device Description field, you may provide a description for your RackLink device.
- In the Location field, specify a particular location where your RackLink device is kept.
- In the Initial Outlet State drop down, select from the following values:
 - Select **Remember prior state** to have the outlets remain in their prior state
 - Select **OFF** to have the outlets Off during power up as their default setting.
 - Select **ON** to have the outlets On during power up as their default setting.

NOTE: This setting is only applicable to outlets that are not included in sequencing or when Sequence on Power Up is Off. On is the factory default setting for an outlet.

For more information about which outlets are included or excluded from sequencing, see “Configuring Outlet Controls” on page 32.

- Turn Sequence on Power Up On or Off to determine whether or not your RackLink device will perform a sequence while powering up. The default setting is On.

For more information about which outlets are included or excluded from sequencing, see “Configuring Outlet Controls” on page 32.

5. Click **Save**.

TIP: To restore the default settings, see “Restoring Factory Defaults” on page 46.

Configuring Email Settings

NOTE: If you use Gmail and have two-step verification configured, you’ll need to create an app password to give your RackLink device permission to access the account. For more information, refer to Google at <https://support.google.com/accounts/answer/185833?hl=en>.

To configure email settings:

1. Install and launch your RackLink Discovery software and connect to a RackLink device.
For more information, see “Installing the Device Discovery Software and Accessing a Connected RackLink’s Browser-Based Interface” on page 13.
2. Log in using the Admin account to access the Administrator Settings menu. For more information, see “Logging in to the Browser-Based Interface” on page 40.
3. Click **Email** on the Administrator Settings menu.

The Email screen appears.

4. Configure the Server Settings section of the screen as follows:

- In the Server's IP/Host Name field, enter the IP or host name of your mail server.
- In the Sender's E-mail Address field, enter the email address to appear as the "from" address in emails sent by your RackLink device.
- In the Port field, enter the port you wish to use on your mail server. The default port is 25.

NOTE:

- Ensure that the server name you provide is a fully qualified domain name.
 - Verify you are using the correct port number and verify that your network is not blocking outbound traffic on the port.
 - Select the **SSL/TLS** check box if you wish to use SSL/TLS encryption on your server.
5. Select the **Authentication** check box if you wish to require Authentication on your mail server. This enables the following fields:

- In the Username field, enter the user name on your mail server.
 - In the Password field, enter the password on your mail server.
 - In the Confirm Password field, confirm the password on your mail server.
 - Select the **Show Password** check box to remove masking dots and show the password characters as you type them.
6. Click **Add A New Recipient** beneath the Recipients section of the screen to show the following fields:
- Provide Name and Email Address information for up to 5 email recipients.
 - Click **Remove** to delete any of the email recipients you entered.
 - Edit Name and Email text and click **Save** as desired.

- Status information appears under corresponding email recipients for the following events:

PASS

- **Success. Email Sent.**

FAIL

- **Failure code ###. SMTP Server could not be resolved.**
- **Failure code ###. The SMTP server connection failed or was prematurely terminated.**
- **Failure. The SMTP return code was ###.**

NOTE: Click the question mark to the right of each status to display its additional information.

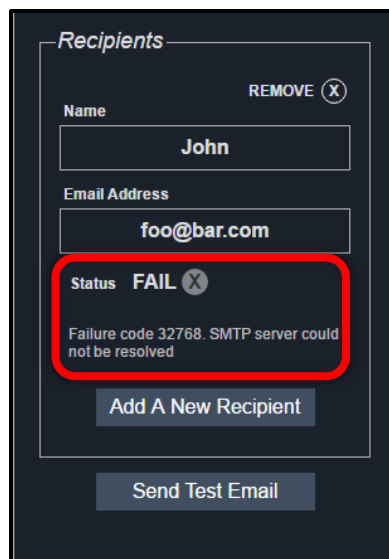

- Click **Send Test Email** to send a test email to each recipient you’ve saved in the system. This is done to ensure your email alert system is working properly.

7. Click **Save**.

TIP: To restore the default settings, see “Restoring Factory Defaults” on page 46.

Restoring Factory Defaults

NOTE: The Factory Reset button on your RackLink unit resets to DHCP and default passwords. For more information, see “RackLink Select Model Diagrams” on page 61. For more information about default password reset on first login, see “Logging in to the Browser-Based Interface” on page 27. You can restore the factory default settings for different areas of your RackLink device as follows:

- Restore Event Log
- Restore AutoPing Defaults

- Restore Date/Time Defaults
- Restore Device Setting Defaults
- Restore Email Defaults
- Restore Password Defaults
- Restore Sequencing Defaults
- Restore Network Defaults

To restore factory defaults:

1. Install and launch your RackLink Discovery software and connect to a RackLink device.
For more information, see “Installing the Device Discovery Software and Accessing a Connected RackLink’s Browser-Based Interface” on page 13.
2. Log in using the Admin account to access the Administrator Settings menu. For more information, see “Logging in to the Browser-Based Interface” on page 40.
3. Click **Factory Defaults** on the Administrator Settings menu.

The Load Default Settings screen appears.

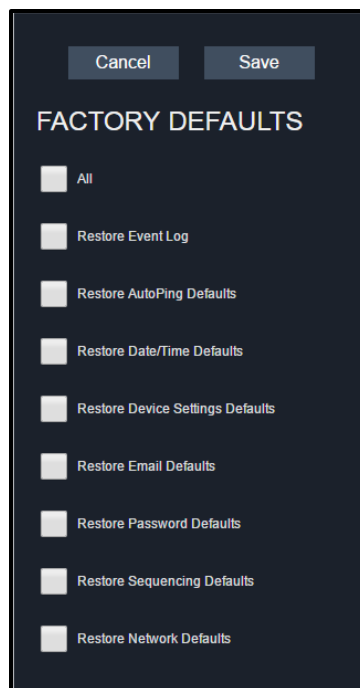

4. Select the default setting check boxes for the items you wish to restore on your RackLink device. Select the **All** check box to mark them all with a single click.
5. Click **Save**.

TIP: To restore the default settings, see “Restoring Factory Defaults” on page 46.

Updating Device Firmware

To update device firmware:

1. Install and launch your RackLink Discovery software and connect to a RackLink device.
For more information, see “Installing the Device Discovery Software and Accessing a Connected RackLink’s Browser-Based Interface” on page 13.
2. Log in using the Admin account to access the Administrator Settings menu. For more information, see “Logging in to the Browser-Based Interface” on page 40.
3. Click **Firmware** on the Administrator Settings menu.

The Firmware screen appears.

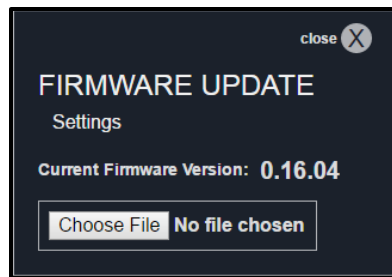

4. View the Current Firmware Version for the number of the latest firmware installation.
5. Click **Choose File** to locate a newer firmware version file you wish to upload to your RackLink device.
6. After choosing a file, the file Name, Size, and a Transfer Status bar appear, and the Upload button is enabled.

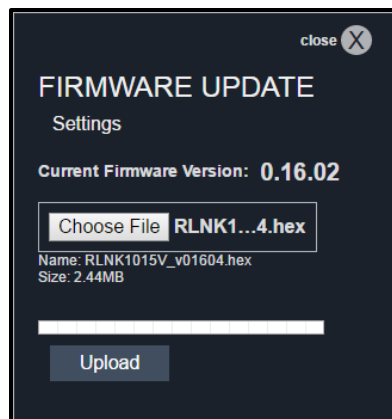

7. Click **Upload**.
8. The Transfer Status bar progresses and indicates a percentage. The status then changes to **Finalizing** until indicating **Transfer Successful**.

- After the transfer completes, the Restart button appears and the system indicates an upload reminder that the “Unit will sequence down, install the new firmware, and return to the main page.”



- Click **Restart**.

A message then appears indicating “Sequencing down the device and updating its firmware. This page will reload in: XX seconds...”



NOTE:

- The unit will sequence down, install the new firmware version, and then power back up.
- The Alert LED blinks green while the system restarts. Do not power down your unit during the system restart.

11. When the dashboard appears, confirm that the firmware version is correct.

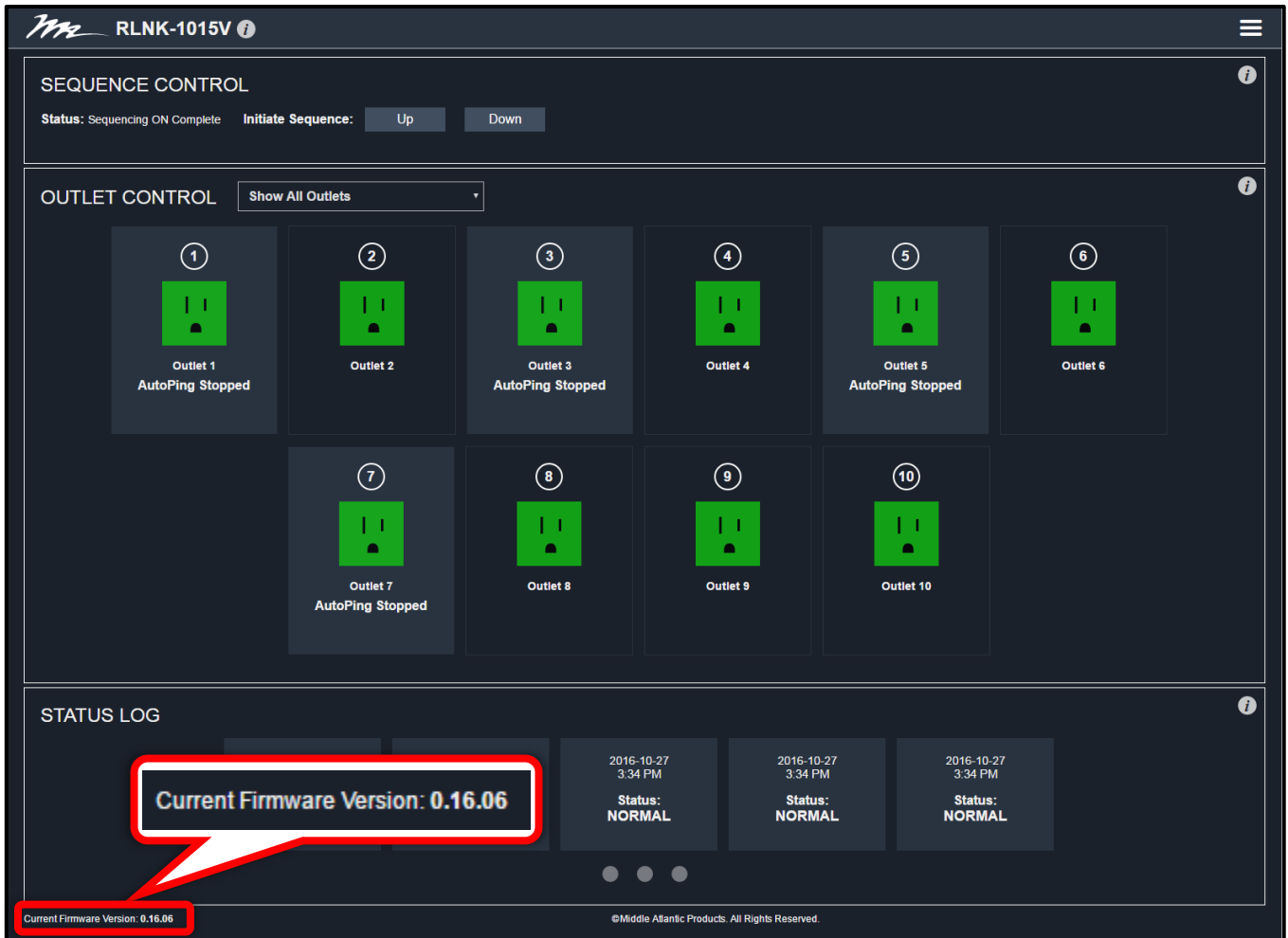

Configuring Network Settings

To configure network settings:

1. Install and launch your RackLink Discovery software and connect to a RackLink device.
For more information, see “Installing the Device Discovery Software and Accessing a Connected RackLink’s Browser-Based Interface” on page 13.
2. Log in using the Admin account to access the Administrator Settings menu. For more information, see “Logging in to the Browser-Based Interface” on page 40.
3. Click **Network** on the Administrator Settings menu.

The Network screen appears.

Cancel Save

NETWORK Settings

MAC Address: **d8:80:39:80:c7:cd**

Use DHCP

IP Address
10.90.51.205

Subnet Mask
255.255.254.0

Gateway
10.90.50.1

DNS 1
10.90.48.118

DNS 2
10.90.48.91

HTTP Port
80

4. The MAC Address displays the unique MAC Address of your specific RackLink device.
5. Use DHCP or configure your IP settings manually as follows:
 - Select the **DHCP** check box to use a DHCP server for configuring all IP address settings.
 - Clear the **DHCP** check box to configure the following IP settings manually:
 - Device IP Address
 - Subnet Mask
 - Gateway
 - DNS1 (Primary DNS)
 - DNS2 (Secondary DNS, Optional)
6. In the HTTP Port field, provide your desired port value. Port 80 is set as the default. You may not change value to a port that is already in use. Ports used by the system include 7 (ICMP/Ping), 443 (HTTPS), 54632 (Discovery), and 60000 (Control Protocol). If you choose any of these ports, the system will not change the port of the HTTP Server.
7. Click **Save**.

NOTE: The Alert LED blinks green while acquiring an IP Address. If the device does not receive a DHCP request after 30 seconds, it will default to 192.168.1.200 and the Alert LED alternates between red and green.

TIP: To restore the default settings, see “Restoring Factory Defaults” on page 46.

Passwords

When logged in to the browser-based interface using the Admin account, you can change the passwords for the User, Admin, and Control Systems accounts.

NOTE:

- For default account names, passwords, and logging in for the first time, see “Logging in to the Browser-Based Interface” on page 27.
- While passwords may be changed by the administrator, account names are fixed and cannot be changed.

To configure new passwords:

1. Install and launch your RackLink Discovery software and connect to a RackLink device.
For more information, see “Installing the Device Discovery Software and Accessing a Connected RackLink’s Browser-Based Interface” on page 13.
2. Log in using the Admin account to access the Administrator Settings menu. For more information, see “Logging in to the Browser-Based Interface” on page 40.
3. Click **Passwords** on the Administrator Settings menu.

The Passwords screen appears.

The screenshot shows a mobile interface for password settings. At the top, there are two buttons: 'Cancel' and 'Save'. Below them is the title 'PASSWORDS Settings'. The interface is divided into three sections, each with a title and a set of input fields:

- Administrator Password:** Includes a 'Password' field with the placeholder 'Enter the password...', a 'Password Confirm' field with the placeholder 'Confirm password...', and a 'Show Password' checkbox.
- User Password:** Includes a 'Password' field with the placeholder 'Enter the password...', a 'Password Confirm' field with the placeholder 'Confirm password...', and a 'Show Password' checkbox.
- Control System Password:** Includes a 'Password' field with the placeholder 'Enter the password...', a 'Password Confirm' field with the placeholder 'Confirm password...', and a 'Show Password' checkbox.

4. Enter and confirm the passwords to change the Administrator, User, and Control System accounts, as desired.
5. Select the **Show Password** check box to display the actual characters in corresponding text boxes.
6. Click **Save**.

TIP: To restore the default settings, see “Restoring Factory Defaults” on page 46.

UNDERSTANDING AN AUTOPING CONFIGURATION

This section takes you through an AutoPing configuration where your RackLink reboots a modem/router in the event that its Internet connection stops working.

NOTE:

- A proper AutoPing configuration prevents cyclic outlet rebooting. Cyclic outlet rebooting is the result of AutoPing settings not taking the modem/router's start-up time into account. This results in your RackLink continuously turning the controlled outlet on and off.
- Understand that email notifications are not received in the event that your Internet connection goes down. Instead, a recovery notification is sent when the connection is reestablished. Refer to the log entry for more information about when the actual failure occurred. For more information, see "Viewing Status Log Information" on page 37.

Connecting Your Equipment

This picture shows the following connections you should make to your equipment:



- Connect your modem/router's (black box above the RackLink) power cable into a controlled outlet on the RackLink.
- Connect your RackLink's Ethernet cable (blue) into switch port 1 on the modem/router.
- Connect your modem/router to the Internet (yellow cable).

Measuring Modem/Router Start-Up Time

When configuring AutoPing, it's important to know the start-up time of the modem/router. The start-up time is the amount of time between when the modem/router is powered-up until it starts routing traffic to the Internet.

NOTE: If your Internet connection is down from your Internet Service Provider (ISP) or your AutoPing settings don't take your modem/router's start-up time into account, the result is referred to as Cyclic Rebooting, where your RackLink continuously turns the controlled outlet on and off.

To measure your modem/router start-up time:

1. Leave your modem/router unplugged/powered off.
2. Open a command prompt and Ping an address on the internet using the `-t` option (Ping continuously) as follows:

```
ping -t www.google.com
```

You should see replies indicating "Request timed out".

3. Start a stopwatch while plugging in the modem/router's power cable.

Once you see "Reply from..." as a response, stop the stopwatch.

This is your start-up time for the modem/router.

NOTE: It may be beneficial to add a few seconds to the start-up time just to be safe. For our example, we will assume the modem/router boots up in about 2 minutes.

Calculating Frequency, Failures, and Cycles

Before configuring AutoPing in your RackLink device, it's important to understand the relationship between Frequency, Failures, and Cycles. It is good practice to keep the default values for Frequency and Failures (30 and 3, respectively) and adjust your outlet recovery cycle time (Cycle-Time) to equal your measured recovery time from "Measuring Modem/Router Start-Up Time" on page 55, plus at least 1 frequency.

In our example, we set Frequency to 30 seconds, Failures to 3, which results in your Internet connection being down for 90 seconds in order to trigger an AutoPing recovery. Finally, we set an outlet Cycle-Time of 150 seconds (a modem/router reboot of 120 seconds + a Frequency of 30 seconds).

Configuring AutoPing in Your RackLink

For more general AutoPing information, see “Configuring Outlet Controls” on page 32; otherwise, continue here with this example configuration.

To configure AutoPing in your RackLink:

1. Install and launch your RackLink Discovery software and connect to a RackLink device.

For more information, see “Installing the Device Discovery Software and Accessing a Connected RackLink’s Browser-Based Interface” on page 13.

2. Enter the credentials for the account you wish to use. For more information, see “Logging in to the Browser-Based Interface” on page 27.

The Dashboard appears.

3. Make the following configurations on a controlled outlet.

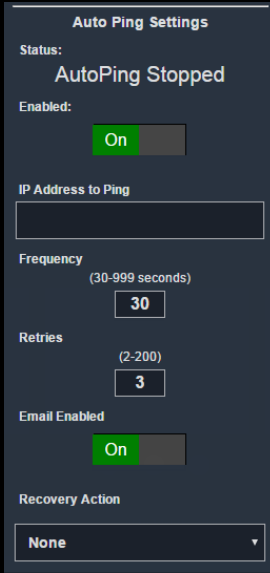

The screenshot displays the 'Auto Ping Settings' configuration page. At the top, the status is 'AutoPing Stopped'. Below this, there are several settings:

- Enabled:** A toggle switch set to 'On'.
- IP Address to Ping:** An empty text input field.
- Frequency:** A numeric input field set to '30', with a range of '(30-999 seconds)' indicated below it.
- Retries:** A numeric input field set to '3', with a range of '(2-200)' indicated below it.
- Email Enabled:** A toggle switch set to 'On'.
- Recovery Action:** A dropdown menu currently showing 'None'.

- You can configure the IP Address to Ping Google's DNS server at 8.8.8.8. However, this address could be the outside interface of your router or your next hop to the Internet. Find your next hop to the Internet by issuing the following at the command prompt:

tracert www.google.com

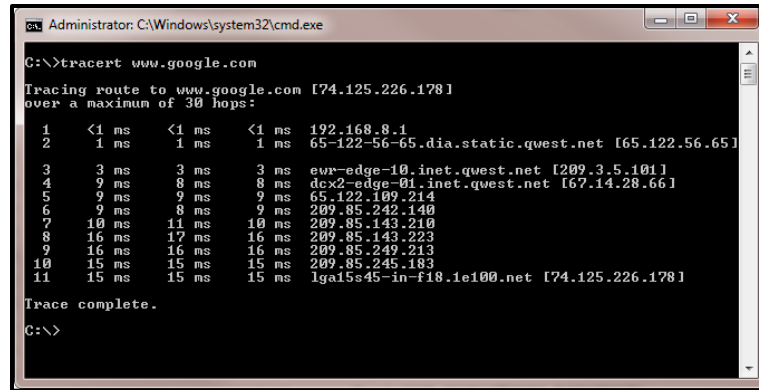

```

Administrator: C:\Windows\system32\cmd.exe
C:\>tracert www.google.com
Tracing route to www.google.com [74.125.226.178]
over a maximum of 30 hops:
  0  <1 ms  <1 ms  <1 ms  192.168.8.1
  1  1 ms    1 ms    1 ms    65.122.56.65 [65.122.56.65]
  2  3 ms    3 ms    3 ms    ewr-edge-10.inet.quest.net [209.3.5.101]
  3  9 ms    8 ms    8 ms    dcx2-edge-01.inet.quest.net [67.14.28.66]
  4  9 ms    9 ms    9 ms    65.122.109.214
  5  9 ms    8 ms    9 ms    209.85.242.140
  6  10 ms   11 ms   10 ms   209.85.143.210
  7  16 ms   17 ms   16 ms   209.85.143.223
  8  16 ms   16 ms   16 ms   209.85.249.213
  9  15 ms   15 ms   15 ms   209.85.245.183
 10  15 ms   15 ms   15 ms   lga15s45-in-f18.1e100.net [74.125.226.178]
Trace complete.
C:\>

```

The next hop is the first address that is not internal or private. In this screenshot, the next hop is 65.122.56.65.

- Configure the Frequency.

This is the time (in seconds) between each Ping. You can set it as short as 30 seconds. More frequent Pings mean that your RackLink device will respond to outages quicker. However, more frequent Pings does increase your network traffic and may have an adverse effect on your network throughput.
- Configure the Failures to 3. With a Frequency of 30 seconds and 3 Failures, the device being Pinged would need to be offline for 90 seconds before the recovery action is executed.
- Configure the Recovery to "Power-Cycle Until Recovery". This results in the outlet continuously cycling until an Internet connection is reestablished.
- Configure the Cycle-Time for your power cycle delay to 150 seconds.

NOTE: We are using 150 seconds because we assumed our start-up time to be 2 minutes and a Frequency of 30 seconds. For more information, see "Calculating Frequency, Failures, and Cycles" on page 55.

Our configuration will begin cycling the controlled outlet after 90 seconds (Frequency is 30 seconds and Failures are 3) of no response from address 65.122.56.65.

The following diagram shows each step of our example AutoPing.

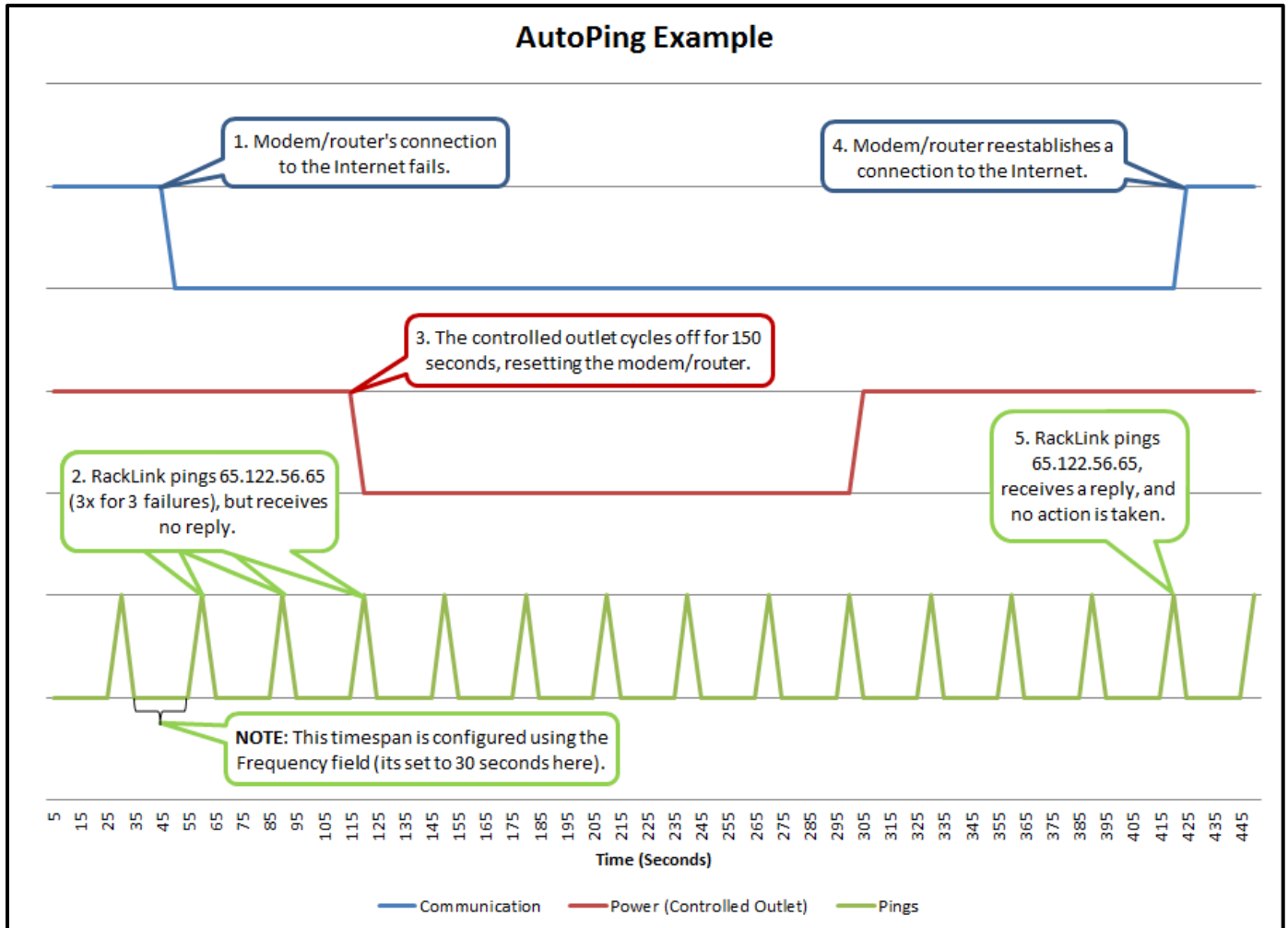

FREQUENTLY ASKED QUESTIONS

General Questions

Question: What if I forget my password?

Answer: Press the Factory Reset button on the device. This defaults the permissions to admin/admin. For more information, see “RackLink Select Model Diagrams” on page 61.

NOTE: If you have configured your RackLink to use TCP/IP, resetting the system restores it to using DHCP. For more information, see “Setting Up Your RackLink Device for the First Time” on page 20.

Question: What if my RackLink device is inoperable after I perform a firmware upgrade?

Answer: Contact Middle Atlantic Products Technical Support at (866) 977-3901 or email us at av.middleatlantic.techsupport@legrand.com.

Question: What if my RackLink device is not receiving power?

Answer: Ensure that the IEC connector on the line cord is fully inserted into the rear outlet and the line cord retention clip is securely fastened. Confirm that the circuit breaker is in the ON position. Plug another device into the exact same outlet your RackLink device was using and see if the other device functions.

Connectivity Questions

Question: I connected RackLink to my network, but I can't find it in the Device Discovery program. What's wrong?

Answers: The Device Discovery program can only find RackLink devices that are on the same subnet as the computers accessing them.

- If you are using a DHCP connection, and your RackLink device is unable to obtain an IP address from the DHCP server, set your computer's IP address to 192.168.1.xxx. Where xxx is any number between 1 and 199 or 201 to 254. Your RackLink will default its IP address to 192.168.1.200 and connect with your PC.
- If you are using a TCP/IP connection, consider the following scenario:
If your PC has an IP address of 192.168.1.50 and a subnet mask of 255.255.255.0, and your RackLink has an IP address of 192.168.2.50 and a subnet mask of 255.255.255.0, the RackLink will not be listed in the Device Discovery program. This is because the third octets of

the IP addresses (1 and 2, respectively) differ. With a subnet mask of 255.255.255.0, the first three octets of the IP addresses on the PC and RackLink would have to match.

For more information regarding IP addresses, refer to Microsoft's TechNet articles at <http://technet.microsoft.com/en-us/library/cc958829.aspx>.

Question: What could be wrong if I can't access the browser-based interface?

Answer: Check to see if you can access a standard web page, such as www.google.com. Verify that the Ethernet port's LEDs on the back of your RackLink device are solid yellow and blinking green. Review the procedures in "Setting Up Your RackLink Device for the First Time" on page 20.

Control System Questions

Question: I press the Factory Reset button and reset my RackLink to factory defaults, but I'm getting a login denied response from RackLink when I sign in using the default Control Systems account and password. Why is this happening?

Answer: Earlier versions of RackLink firmware did not reset the Control Systems account password after pressing the Default Restoration button. Reset it manually by accessing the **Passwords** screen and setting the Control Systems account password to match your Control System.

Question: Every time I send a command from my control system to my RackLink it responds with a "Bad Length" error. Why is this happening?

Answer: The length byte is in Hexadecimal format. When you add up the total command length, make sure you convert the length from decimal format to hexadecimal format.

Question: Every time I send a command from my control system to my RackLink it responds with a "Bad Checksum" error. Why is this happening?

Answer: Review the Checksum section of the Select Series PDU With RackLink Control System Communication Protocol Manual (I-00472) at www.legrandav.com. Make sure to AND the sum with 127 (0x7F) or modulus the sum with 128 (0x80).

Alert LED States

Question: What are the different statuses for the Alert LED?

Answer:

Alert LED State	What It Means
Blinking Green	Acquiring IP address (during startup).
Green	Normal operation, IP acquired, and no alarms.
Blinking Green/Red	No alarms, running on default IP (DHCP not acquired).
Blinking Red	Lost IP connection.
Red	Network is active, alarms present.

RACKLINK SELECT MODEL DIAGRAMS

RLNK-2XX Diagrams

The following front and rear views of the various RLNK-2XX models include callouts that correspond to numbered descriptions.

RLNK-215 Front View

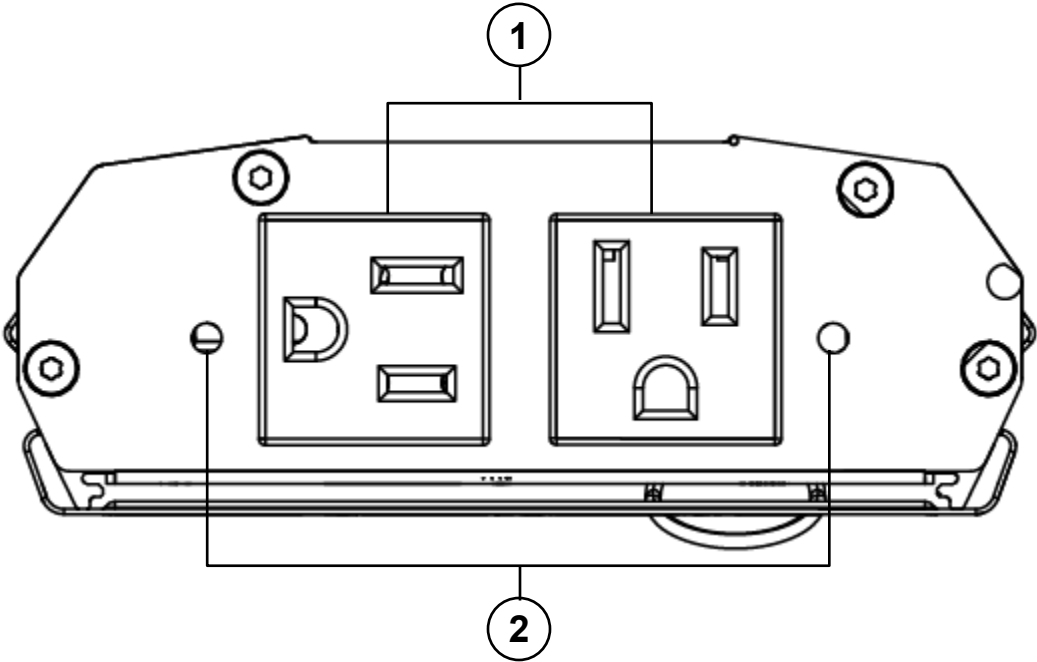

- 1. Two Controlled Outlets
- 2. Integrated Controlled Outlet ON/OFF LED: The LED illuminates green when outlet is energized.

NOTE: Each controlled outlet has an associated LED. The LED number corresponds with the numbered controlled outlet.

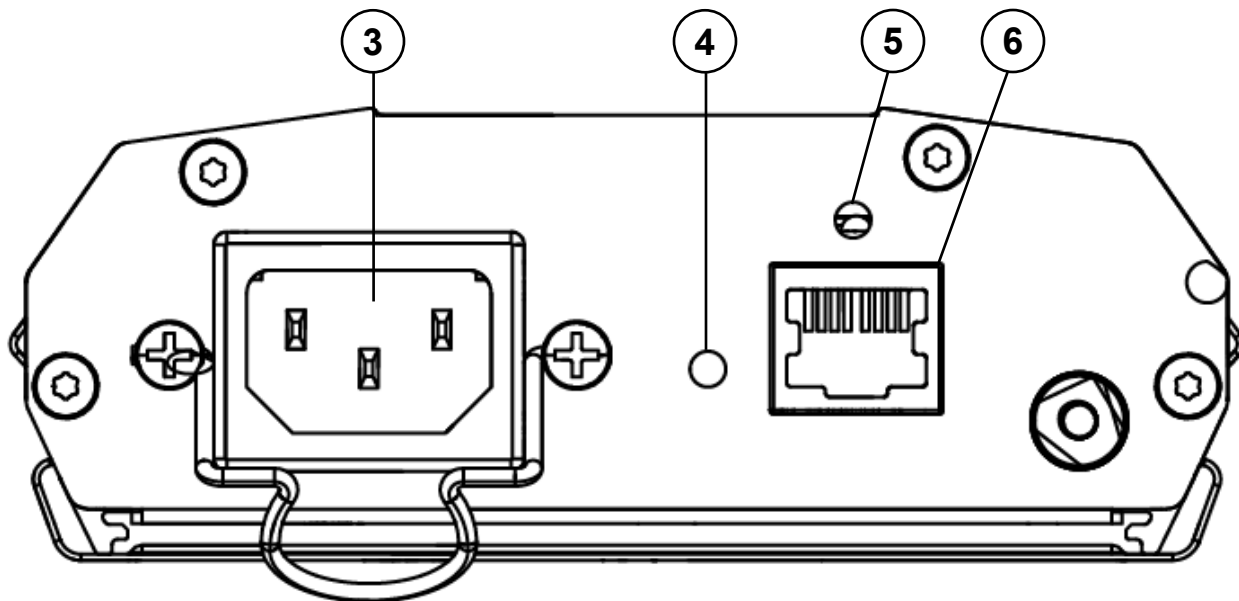
RLNK-215 Rear View

1. IEC C14 Power Input: 120V nominal, 12A (total load, all outlets), 60Hz input with cord retainer.
2. Factory Reset Button: Resets to DHCP and default passwords. For more information, see “Configuring Network Settings” on page 44 and “Passwords” on page 52.
3. Alert LED: The LED illuminates red when an alarm condition occurs (any AutoPing failure). For more information, see “Configuring SMTP Settings” on page 44.
4. Ethernet Port (10/100): Used to connect to a network, requires a Cat5e cable (or better, not provided).

RLNK-210-IEC-NS Front View

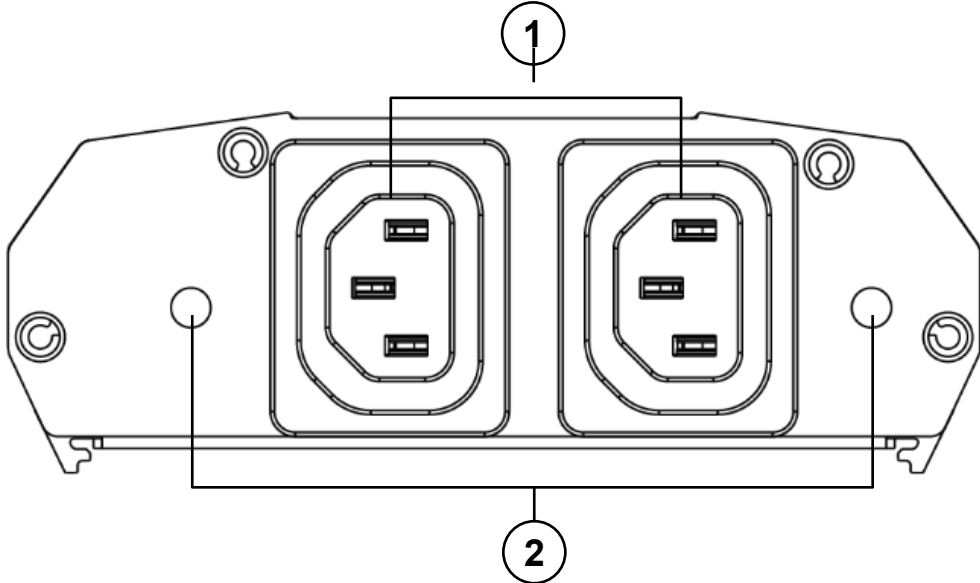

- 1. Two Controlled Outlets
- 2. Integrated Controlled Outlet ON/OFF LED: The LED illuminates green when outlet is energized.

NOTE: Each controlled outlet has an associated LED. The LED number corresponds with the numbered controlled outlet.

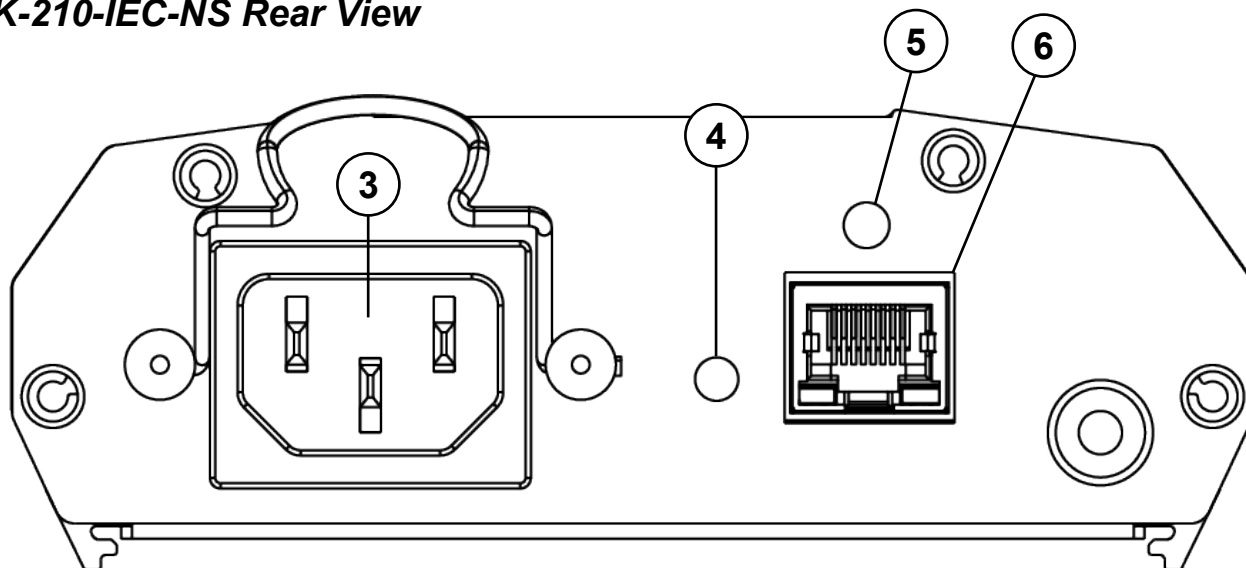
RLNK-210-IEC-NS Rear View

3. IEC C14 Power Input: 100-240V nominal, 10A (total load, all outlets), 50-60Hz input with cord retainer.
4. Factory Reset Button: Resets to DHCP and default passwords. For more information, see “Configuring Network Settings” on page 44 and “Passwords” on page 52.
5. Alert LED: The LED illuminates red when an alarm condition occurs (any AutoPing failure). For more information, see “Configuring SMTP Settings” on page 44.
6. Ethernet Port (10/100): Used to connect to a network, requires a Cat5e cable (or better, not provided).

RLNK-4XXR Diagrams

The following front and rear views of the RLNK-4XXR include callouts that correspond to numbered descriptions.

RLNK-415R and RLNK-420R Front View

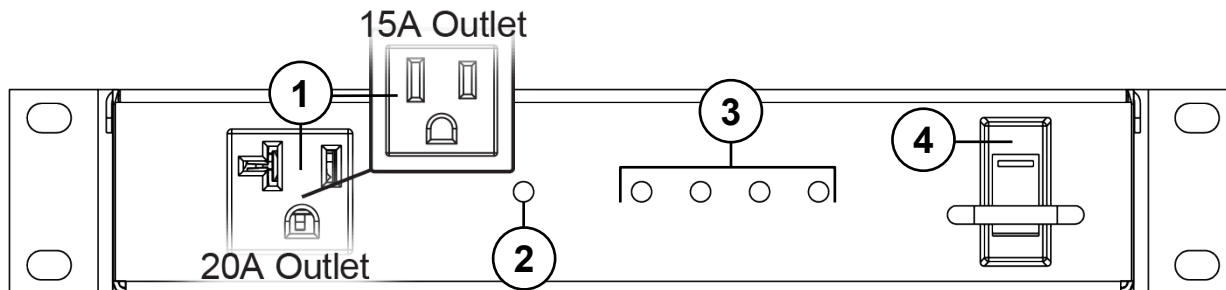

1. Controlled Outlet
 2. Alert LED: The LED illuminates red when an alarm condition occurs (any AutoPing failure). For more information, see “Configuring SMTP Settings” on page 44.
 3. Integrated Controlled Outlet ON/OFF LEDs: The LED illuminates green when outlet is energized.
- NOTE:** Each controlled outlet has an associated LED. The LED number corresponds with the numbered controlled outlet.
4. Integrated Power Switch/Circuit Breaker

RLNK-415R and RLNK-420R Rear View

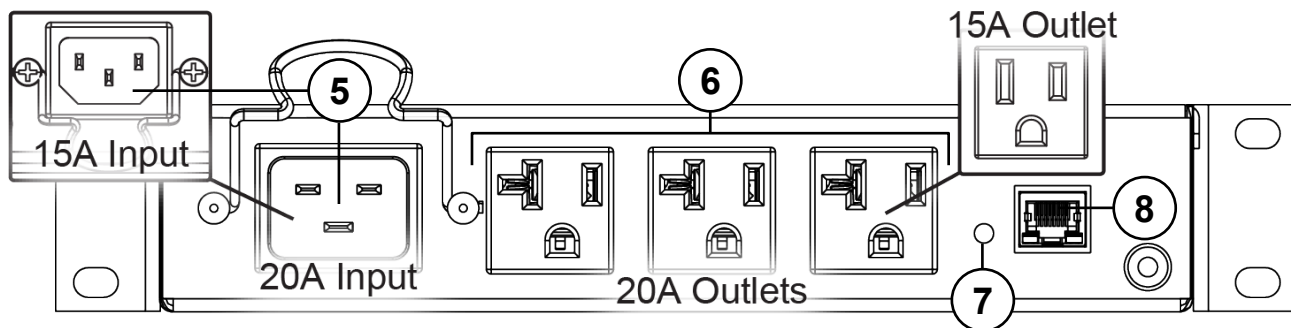

5. Power Input and Total Load
 - IEC C14 Power Input on RLNK-415R: 120V nominal, 12A (total load, all outlets), 60Hz input with cord retainer.
 - IEC C20 Power Input on RLNK-420R: 120V nominal, 16A (total load, all outlets), 60Hz input with cord retainer.
6. Three Controlled Outlets
7. Factory Reset Button: Resets to DHCP and default passwords. For more information, see “Configuring Network Settings” on page 44 and “Passwords” on page 52.

- Ethernet Port (10/100): Used to connect to a network, requires a Cat5e cable (or better, not provided).

RLNK-410R-IEC-NS Front View

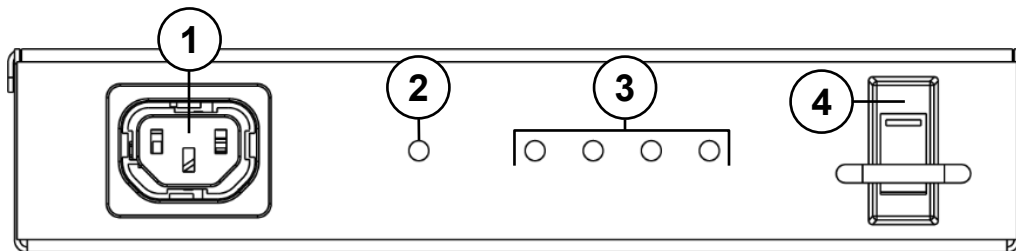

- Controlled Outlet
- Alert LED: The LED illuminates red when an alarm condition occurs (any AutoPing failure). For more information, see “Configuring SMTP Settings” on page 44.
- Integrated Controlled Outlet ON/OFF LEDs: The LED illuminates green when outlet is energized.

NOTE: Each controlled outlet has an associated LED. The LED number corresponds with the numbered controlled outlet.

- Integrated Power Switch/Circuit Breaker

RLNK-410R-IEC-NS Rear View

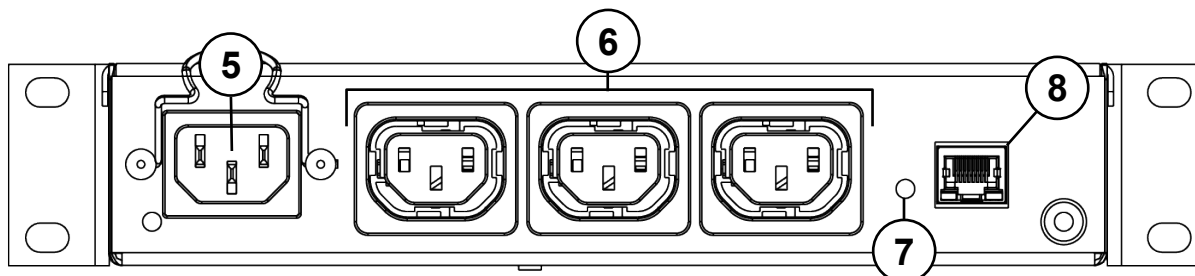

- IEC C14 Power Input: 100-240V nominal, 10A (total load, all outlets), 50-60Hz input with cord retainer.
- Three Controlled Outlets
- Factory Reset Button: Resets to DHCP and default passwords. For more information, see “Configuring Network Settings” on page 44 and “Passwords” on page 52.
- Ethernet Port (10/100): Used to connect to a network, requires a Cat5e cable (or better, not provided).

RLNK-9XXR Diagrams

The following front and rear views of the RLNK-9XXR include callouts that correspond to numbered descriptions.

RLNK-915R and RLNK-920R Front View

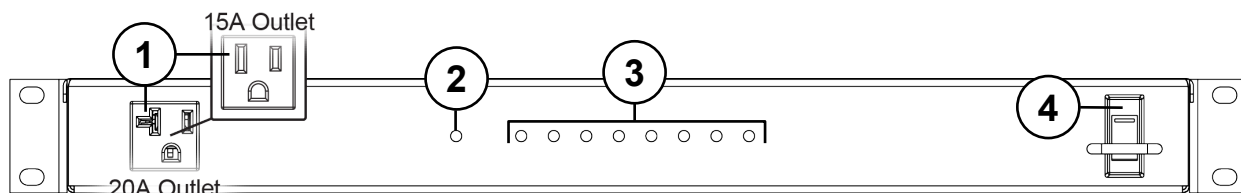

1. Switched Outlet: Controlled by the main power switch.
2. Alert LED: The LED illuminates red when an alarm condition occurs (any AutoPing failure). For more information, see “Configuring SMTP Settings” on page 44.
3. Integrated Controlled Outlet ON/OFF LEDs: The LED illuminates green when outlet is energized.

NOTE: Each controlled outlet has an associated LED. The LED number corresponds with the numbered controlled outlet.

4. Integrated Power Switch/Circuit Breaker

RLNK-915R and RLNK-920R Rear View

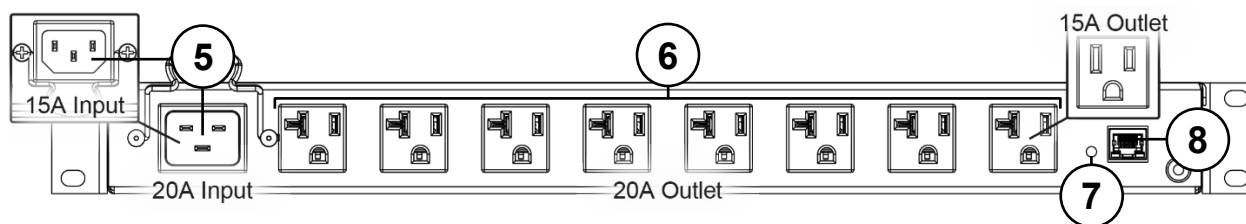

5. Power Input and Total Load
 - IEC C14 Power Input on RLNK-915R: 120V nominal, 12A (total load, all outlets), 60Hz input with cord retainer.
 - IEC C20 Power Input on RLNK-920R: 120V nominal, 16A (total load, all outlets), 60Hz input with cord retainer.
6. Eight Controlled Outlets

- 7. Factory Reset Button: Resets to DHCP and default passwords. For more information, see “Configuring Network Settings” on page 44 and “Passwords” on page 52.
- 8. Ethernet Port (10/100): Used to connect to a network, requires a Cat5e cable (or better, not provided).

RLNK-910R-IEC-NS Front View

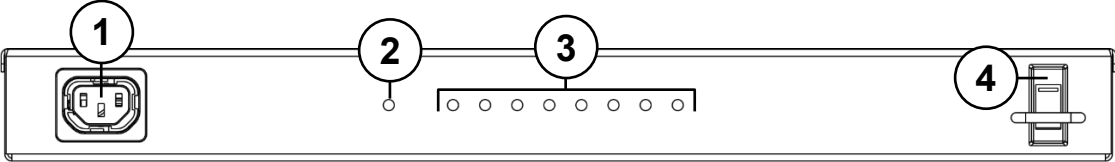

- 1. Switched Outlet: Controlled by the main power switch.
- 2. Alert LED: The LED illuminates red when an alarm condition occurs (any AutoPing failure). For more information, see “Configuring SMTP Settings” on page 44.
- 3. Integrated Controlled Outlet ON/OFF LEDs: The LED illuminates green when outlet is energized.

NOTE: Each controlled outlet has an associated LED. The LED number corresponds with the numbered controlled outlet.

- 4. Integrated Power Switch/Circuit Breaker

RLNK-910R-IEC-NS Rear View

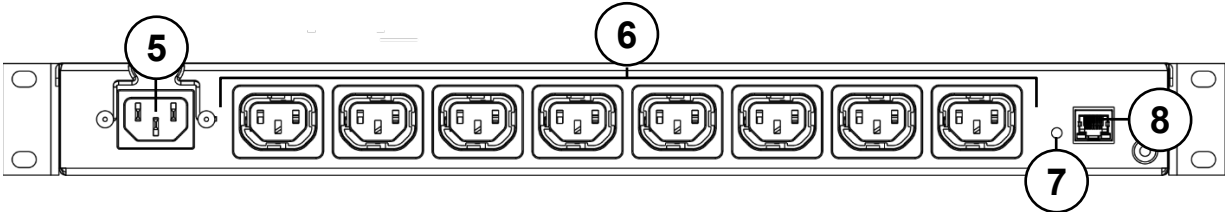

- 5. IEC C14 Power Input: 100-240V nominal, 10A (total load, all outlets), 50-60Hz input with cord retainer.
- 6. Eight Controlled Outlets
- 7. Factory Reset Button: Resets to DHCP and default passwords. For more information, see “Configuring Network Settings” on page 44 and “Passwords” on page 52.
- 8. Ethernet Port (10/100): Used to connect to a network, requires a Cat5e cable (or better, not provided).

RLNK-1015V Diagrams

The following bottom and top views of the RLNK-1015V include callouts that correspond to numbered descriptions.

RLNK-1015V Bottom View

1. Ground/Bond Stud
2. Circuit Breaker

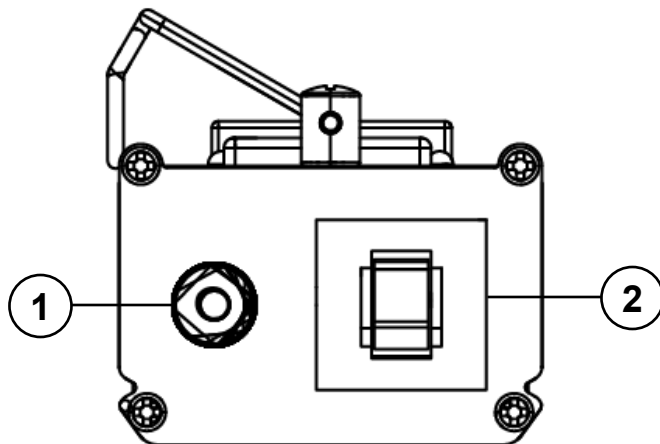

RLNK-1015V Front View

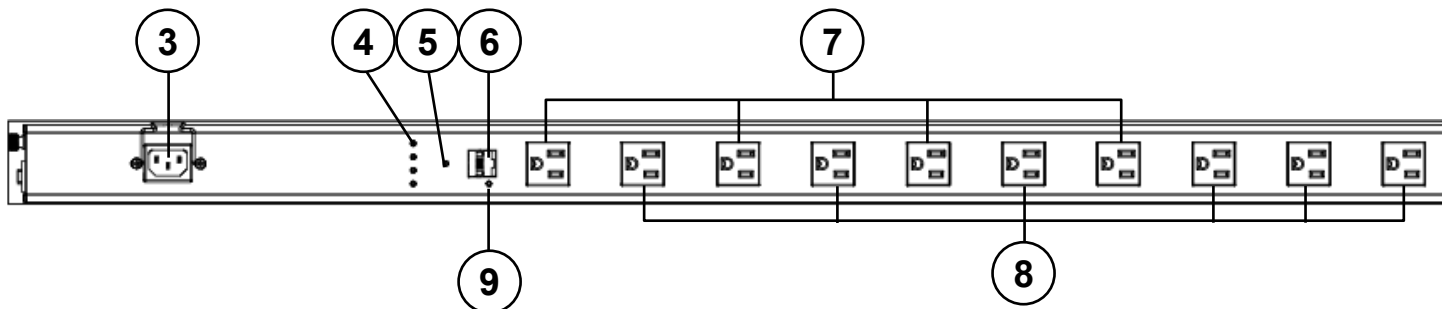

3. IEC C14 Power Input: 120V nominal, 12A (total load, all outlets), 60Hz input with cord retainer.
4. Integrated Controlled Outlet ON/OFF LEDs: The LED illuminates green when outlet is energized.

NOTE: Each controlled outlet has an associated LED. The LED number corresponds with the numbered controlled outlet.

5. Alert LED: The LED illuminates red when an alarm condition occurs (any AutoPing failure). For more information, see “Configuring SMTP Settings” on page 44.
6. Ethernet Port (10/100): Used to connect to a network, requires a Cat5e cable (or better, not provided).
7. Controlled Outlets
8. Switched Outlets: Energized by the main power switch.
9. Factory Reset Button: Resets to DHCP and default passwords. For more information, see “Configuring Network Settings” on page 44 and “Passwords” on page 52.

RLNK-1615V Diagrams

The following bottom and top views of the RLNK-1615V include callouts that correspond to numbered descriptions.

RLNK-1615V Bottom View

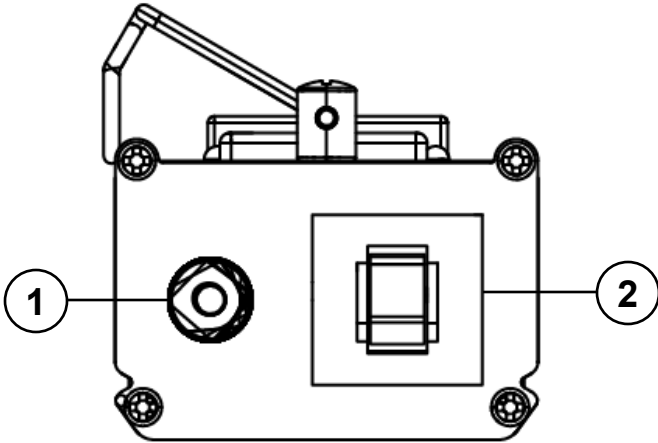

- 1. Ground/Bond Stud
- 2. Circuit Breaker

RLNK-1615V Front View

- 3. Integrated Controlled Outlet ON/OFF LEDs: The LED illuminates green when outlet is energized.
NOTE: Each controlled outlet has an associated LED. The LED number corresponds with the numbered controlled outlet.
- 4. Sixteen outlets alternate upward from controlled to switched, respectively.
- 5. IEC C14 Power Input: 120V nominal, 12A (total load, all outlets), 60Hz input with cord retainer.
- 6. Ethernet Port (10/100): Used to connect to a network, requires a Cat5e cable (or better, not provided).
- 7. Factory Reset Button: Resets to DHCP and default passwords. For more information, see “Configuring Network Settings” on page 44 and “Passwords” on page 52.
- 8. Alert LED: The LED illuminates red when an alarm condition occurs (any AutoPing failure). For more information, see “Configuring SMTP Settings” on page 44.

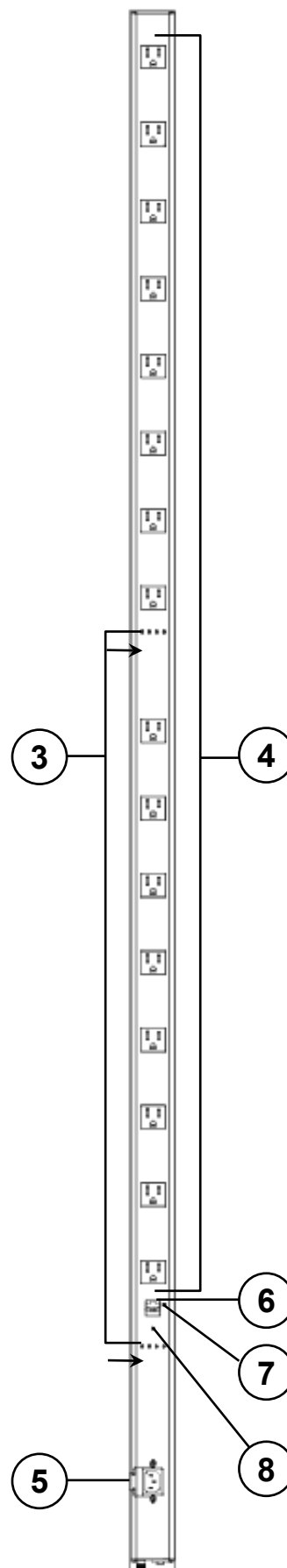

WARRANTY

For warranty information, refer to www.legrandav.com/policies/warranty_information.

Contacting Corporate Headquarters

P: (866) 977-3901 | F: (877) 894-6918 | www.legrandav.com | av.support@legrand.com

Contacting Middle Atlantic Canada

P: (888) 766-9770 | F: (888) 599-5009 | ca.middleatlantic.com | av.canada.customerservice@legrand.com

Contacting Middle Atlantic Europe, Middle East, and Africa (EMEA) Technical Support

P: +31 495-726-003 | av.emea.middleatlantic.support@legrand.com

United States (US)

Legrand | AV Headquarters
6436 City West Parkway
Eden Prairie, MN, 55344, USA

European Union (EU)

Legrand AV Netherlands
B.V. Franklinstraat 14 6003
DK, Weert, Netherlands

United Kingdom (UK)

Starline Holding Technology Ltd.
(Authorized Representative)
Unit C, Island Rd.
Reading RG2, 0RP- UK

At Legrand AV Inc. we are always listening. Your comments are welcome.

Legrand AV is an ISO 9001 and ISO 14001 Registered Company.