

USER MANUAL

Pro Lite

LCD Monitor

ENGLISH

A decorative graphic consisting of a grid of blue squares of varying shades and sizes, arranged in a pattern that resembles a staircase or a series of steps. The squares are scattered across the page, with some overlapping and some empty.

Pro Lite XUB2293HSU
Pro Lite XUB2493HSU
Pro Lite XUB2793HSU
Pro Lite XUB2793HS
Pro Lite XUB2793QSU
Pro Lite XU2293HSU
Pro Lite XU2493HSU
Pro Lite XU2793HSU
Pro Lite XU2793HS
Pro Lite XU2793QSU

Thank you very much for choosing the iiyama LCD monitor. We recommend that you take a few minutes to read this comprehensive manual carefully before installing and switching on the monitor. Please keep this manual in a safe place for your future reference.



Dear user, we congratulate you on the purchase of your iiyama LCD.

For details on warranty and locally used pixel policies that apply directly after installation of your product please check the iiyama website.

To report a fault, please contact your local support centre found at <https://iiyama.com>

Things to check before you call the iiyama information line

- | if the power cable is connected securely and turned on?
- | if the display has been turned on?
- | if the signal cable is connected securely and the correct input selected?
- | if the computer has been restarted with the display connected?
- | if the graphics card is correctly installed with the latest drivers possible?
- | if the correct native resolution has been selected via 'Display Properties'?
- | If the R/G/B signal configuration is correct?
- | if the displays On Screen Menu is shown?
- | if the correct brightness and contrast settings have been set?
- | if given display tolerances and compatibility have been considered?
- | if via the On Screen Menu you have performed a Factory Reset/Recall?

Before reporting the screen defect, please prepare the following information/evidence:

- | model number *
- | purchase receipt and serial number *
- | name and address for collection
- | telephone/fax number, for availability during the day
- | convenient collection date (date, time)
- | short description of the defect

Important Note:

If there is no fault found in the collected equipment after inspection, the transferring party shall incur charges for transport and administration.

If you have checked all of the above and there is still no picture, call our information line for assistance in your country.

* see the identification plate on the back of the case.

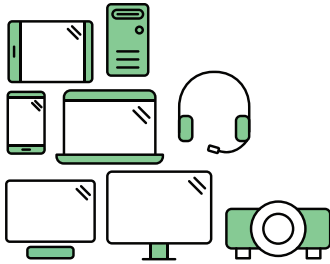

Say hello to a more sustainable product

IT products are associated with a wide range of sustainability risks throughout their life cycle. Human rights violations are common in the factories. Harmful substances are used both in products and their manufacture. Products can often have a short lifespan because of poor ergonomics, low quality and when they are not able to be repaired or upgraded.

This product is a better choice. It meets all the criteria in TCO Certified, the world's most comprehensive sustainability certification for IT products. Thank you for making a responsible product choice, that help drive progress towards a more sustainable future!

Criteria in TCO Certified have a life-cycle perspective and balance environmental and social responsibility. Conformity is verified by independent and approved verifiers that specialize in IT products, social responsibility or other sustainability issues. Verification is done both before and after the certificate is issued, covering the entire validity period. The process also includes ensuring that corrective actions are implemented in all cases of factory non-conformities. And last but not least, to make sure that the certification and independent verification is accurate, both TCO Certified and the verifiers are reviewed regularly.

Want to know more?

Read information about TCO Certified, full criteria documents, news and updates at [tcocertified.com](https://www.tcocertified.com). On the website you'll also find our Product Finder, which presents a complete, searchable listing of certified products.

CE MARKING DECLARATION OF CONFORMITY

This LCD monitor complies with the requirements of the EC/EU Directive 2014/30/EU "EMC Directive", 2014/35/EU "Low Voltage Directive", 2009/125/EC "ErP Directive" and 2011/65/EU "RoHS Directive".

The electro-magnetic susceptibility has been chosen at a level that gives correct operation in residential areas, business and light industrial premises and small-scale enterprises, inside as well as outside of the buildings. All places of operation are characterised by their connection to the public low voltage power supply system.

IYAMA CORPORATION: Wijkermeerstraat 8, 2131 HA Hoofddorp, The Netherlands

Model No. : PL2293HS / PL2493HS / PL2793HS / PL2793QS



We recommend recycling of used product. Please contact your dealer or iiyama service center. Recycle information is obtained via the Internet, using the address: <https://iiyama.com>

You can access the Web page of different countries from there.

- We reserve the right to change specifications without notice.
- All trademarks used in this user manual are the property of their respective owners.
- Eprel registration number

XUB2293HSU-B6 : 1744664 XU2293HSU-B6 : 1744603 XUB2493HSU-B6 : 1660574 XU2493HSU-B6 : 1660629
XUB2793HSU-B6 : 1703661 XU2793HSU-B6 : 1703821 XUB2793HS-B6 : 1787395 XU2793HS-B6 : 1787417
XUB2793QSU-B6 : 1690725 XU2793QSU-B6 : 1692550

TABLE OF CONTENTS

FOR YOUR SAFETY.....	1
SAFETY PRECAUTIONS.....	1
SPECIAL NOTES ON LCD MONITORS.....	3
CUSTOMER SERVICE.....	3
CLEANING.....	3
BEFORE YOU OPERATE THE MONITOR.....	4
FEATURES.....	4
CHECKING THE CONTENTS OF THE PACKAGE.....	4
USING ARM OR STAND.....	5
FITTING AND REMOVAL OF STAND : ProLite XUB2293HSU, XUB2493HSU, XUB2793HSU, XUB2793HS, XUB2793QSU.....	7
FITTING AND REMOVAL OF BASE : ProLite XU2293HSU, XU2493HSU, XU2793HSU, XU2793HS, XU2793QSU.....	9
CONTROLS AND CONNECTORS : ProLite XUB2293HSU, XUB2493HSU, XUB2793HSU, XUB2793HS, XUB2793QSU.....	10
CONTROLS AND CONNECTORS : ProLite XU2293HSU, XU2493HSU, XU2793HSU, XU2793HS, XU2793QSU.....	11
CONNECTING YOUR MONITOR : ProLite XUB2293HSU, XUB2493HSU, XUB2793HSU, XUB2793HS, XUB2793QSU.....	12
CONNECTING YOUR MONITOR : ProLite XU2293HSU, XU2493HSU, XU2793HSU, XU2793HS, XU2793QSU.....	13
DISCONNECTING YOUR MONITOR.....	14
COMPUTER SETTING.....	14
ADJUSTING THE HEIGHT AND THE VIEWING ANGLE : ProLite XUB2293HSU, XUB2493HSU, XUB2793HSU, XUB2793HS, XUB2793QSU.....	14
ADJUSTING THE VIEWING ANGLE : ProLite XU2293HSU, XU2493HSU, XU2793HSU, XU2793HS, XU2793QSU.....	15
OPERATING THE MONITOR.....	16
ADJUSTMENT MENU CONTENTS.....	17
STANDBY FEATURE.....	26
TROUBLE SHOOTING.....	27
RECYCLING INFORMATION.....	28

APPENDIX	29
SPECIFICATIONS : ProLite XUB2293HSU-B6.....	29
SPECIFICATIONS : ProLite XU2293HSU-B6	30
SPECIFICATIONS : ProLite XUB2493HSU-B6.....	31
SPECIFICATIONS : ProLite XU2493HSU-B6	32
SPECIFICATIONS : ProLite XUB2793HSU-B6	33
SPECIFICATIONS : ProLite XU2793HSU-B6	34
SPECIFICATIONS : ProLite XUB2793HS-B6	35
SPECIFICATIONS : ProLite XU2793HS-B6	36
SPECIFICATIONS : ProLite XUB2793QSU-B6	37
SPECIFICATIONS : ProLite XU2793QSU-B6	38
DIMENSIONS : ProLite XUB2293HSU	39
DIMENSIONS : ProLite XU2293HSU.....	39
DIMENSIONS : ProLite XUB2493HSU	40
DIMENSIONS : ProLite XU2493HSU.....	40
DIMENSIONS : ProLite XUB2793HSU / ProLite XUB2793HS	41
DIMENSIONS : ProLite XU2793HSU / ProLite XU2793HS	41
DIMENSIONS : ProLite XUB2793QSU	42
DIMENSIONS : ProLite XU2793QSU	42
COMPLIANT TIMING.....	43

FOR YOUR SAFETY

SAFETY PRECAUTIONS

WARNING

STOP OPERATING THE MONITOR WHEN YOU SENSE TROUBLE

If you notice any abnormal phenomena such as smoke, strange sounds or fumes, unplug the monitor and contact your dealer or iiyama service center immediately. Further use may be dangerous and can cause fire or electric shock.

NEVER REMOVE THE CABINET

High voltage circuits are inside the monitor. Removing the cabinet may expose you to the danger of fire or electric shock.

DO NOT PUT ANY OBJECT INTO THE MONITOR

Do not put any solid objects or liquids such as water into the monitor. In case of an accident, unplug your monitor immediately and contact your dealer or iiyama service center. Using the monitor with any object inside may cause fire, electric shock or damage.

INSTALL THE MONITOR ON A FLAT, STABLE SURFACE

The monitor may cause an injury if it falls or is dropped.

DO NOT USE THE MONITOR NEAR WATER

Do not use where water may be splashed or spilt onto the monitor as it may cause fire or electric shock.

OPERATE UNDER THE SPECIFIED POWER SUPPLY

Be sure to operate the monitor only with the specified power supply. Use of an incorrect voltage will cause malfunction and may cause fire or electric shock.

PROTECT THE CABLES

Do not pull or bend the power cable and signal cable. Do not place the monitor or any other heavy objects on the cables. If damaged, the cables may cause fire or electric shock.

ADVERSE WEATHER CONDITIONS

It is advisable not to operate the monitor during a heavy thunder storm as the continual breaks in power may cause malfunction. It is also advised not to touch the plug in these circumstances as it may cause electric shock.

CAUTION

INSTALLATION LOCATION

Do not install the monitor where sudden temperature changes may occur, or in humid, dusty or smoky areas as it may cause fire, electric shock or damage. You should also avoid areas where the sun shines directly on the monitor.

DO NOT PLACE THE MONITOR IN A HAZARDOUS POSITION

The monitor may topple and cause injury if not suitably located. Please also ensure that you do not place any heavy objects on the monitor, and that all cables are routed such that children may not pull the cables and possibly cause injury.

MAINTAIN GOOD VENTILATION

Ventilation slots are provided to keep the monitor from overheating. Covering the slots may cause fire. To allow adequate air circulation, place the monitor at least 10cm (or 4 inches) from any walls.

When removing the tilt stand, the ventilation slots on the back side of the monitor can be blocked. This may overheat the monitor and may cause fire or damage. Make sure to allow enough ventilation when removing the tilt stand. Operating the monitor on its back, side, upside down or on a carpet or any other soft material may also cause damage.

DISCONNECT THE CABLES WHEN YOU MOVE THE MONITOR

When you move the monitor, turn off the power switch, unplug the monitor and be sure the signal cable is disconnected. If you do not disconnect them, it may cause fire or electric shock.

UNPLUG THE MONITOR

If the monitor is not in use for a long period of time it is recommended that it is left unplugged to avoid accidents.

HOLD THE PLUG WHEN DISCONNECTING

To disconnect the power cable or signal cable, always pull it by the plug. Never pull on the cable itself as this may cause fire or electric shock.

DO NOT TOUCH THE PLUG WITH WET HANDS

Pulling or inserting the plug with wet hands may cause electric shock.

WHEN YOU INSTALL THE MONITOR ON YOUR COMPUTER

Be sure the computer is strong enough to hold the weight of the monitor, otherwise, you may damage your computer.

CAREFUL! PROTECT YOUR HANDS AND FINGERS

- Be careful not to hurt your fingers or hands when you change the height or the angle.
- Injury can occur if care is not taken to avoid finger contact with the displays base when adjusting the height. (Just for height adjustable model.)

REMARK FOR 24/7 USAGE

This product is not specifically designed for 24/7 usage in all environments.

REMARK SPECIFIC TO DESKTOP USE

This product is designed for desktop use, not for digital signage (electronic signboard) applications such as ceiling hanging or wall mounting.

OTHERS

ERGONOMIC RECOMMENDATIONS

To eliminate eye fatigue, do not operate the monitor against a bright background or in a dark room. For optimal viewing comfort, the monitor should be just below eye level and 40-60 cm (16-24 inches) away from your eyes. When using the monitor over a prolonged time, a ten minute break every hour is recommended as looking at the screen continuously can cause eye strain.

SPECIAL NOTES ON LCD MONITORS

The following symptoms are normal with LCD monitors and do not indicate a problem.

NOTE

- When you first turn on the LCD monitor, the picture may not fit in the display area because of the type of computer that is used. In this case, adjust the picture position to the correct position.
- You may find slightly uneven brightness on the screen depending on the desktop pattern you use.
- Due to the nature of the LCD screen, an afterimage of the previous screen may remain after switching the image, when the same image is displayed for hours. In this case, the screen can be recovered slowly by changing the image or turning off the Power Switch for some hours.

CUSTOMER SERVICE

NOTE

- If you have to return your unit for service and the original packaging has been discarded, please contact your dealer or iiyama service center for advice or replacement packaging.

CLEANING

WARNING

- If you drop any materials or liquids such as water into the monitor when cleaning, unplug the power cable immediately and contact your dealer or iiyama service center.

CAUTION

- For safety reasons, turn off the power switch and unplug the monitor before you clean it.

NOTE

- To protect the LCD panel, do not scratch or rub the screen with a hard object.
- Never use any of the following strong solvents. These will damage the cabinet and the LCD screen.

Thinner	Spray-type cleaner
Benzine	Wax
Abrasive cleaner	Acid or Alkaline solvent

- Touching the cabinet with any product made from rubber or plastic for a long time may cause degeneration or loss of paint on the cabinet.

CABINET

Stains can be removed with a cloth lightly moistened with a mild detergent solvent. Then wipe the cabinet with a soft dry cloth.

LCD SCREEN

Periodic cleaning with a soft dry cloth is recommended.

Don't use tissue paper etc. because these will damage the LCD screen.

BEFORE YOU OPERATE THE MONITOR

FEATURES

- ◆ Supports Resolutions up to 1920 × 1080 :
ProLite XUB2293HSU / ProLite XU2293HSU / ProLite XUB2493HSU /
ProLite XU2493HSU / ProLite XUB2793HSU / ProLite XU2793HSU /
ProLite XUB2793HS / ProLite XU2793HS
- ◆ Supports Resolutions up to 2560 × 1440 :
ProLite XUB2793QSU / ProLite XU2793QSU
- ◆ High Contrast 1000:1 (Typical), Adv. Contrast Function Available / Brightness
250cd/m² (Typical) : ProLite XUB2293HSU / ProLite XU2293HSU /
ProLite XUB2493HSU / ProLite XU2493HSU / ProLite XUB2793HSU /
ProLite XU2793HSU / ProLite XUB2793HS / ProLite XU2793HS
- ◆ High Contrast 1300:1 (Typical), Adv. Contrast Function Available
Brightness 250cd/m² (Typical) : ProLite XUB2793QSU / ProLite XU2793QSU
- ◆ Moving Picture Response Time 1ms
- ◆ Supports Adaptive Sync technology
- ◆ Flicker - Free
- ◆ Blue Light Reducer
- ◆ Digital Character Smoothing
- ◆ 2 × 2W Stereo Speakers
- ◆ Standby Feature
- ◆ VESA Mounting Standard (100mm×100mm) Compliant
- ◆ Keyhole for Security Lock

CHECKING THE CONTENTS OF THE PACKAGE

The following accessories are included in your package. Check to see if they are enclosed with the monitor. If anything is missing or damaged, please contact your local iiyama dealer or regional iiyama office.

- | | | |
|------------------------------|---|-----------------------------------|
| ■ Power Cable* ¹ | ■ HDMI Cable | ■ DisplayPort Cable* ² |
| ■ USB Cable* ³ | ■ VESA Plate* ⁴ | ■ Screwdriver* ⁴ |
| ■ Stand-Neck | ■ Stand-Base with a screw* ⁴ | ■ Stand-Base* ⁵ |
| ■ Cable Holder* ⁵ | ■ Safety Guide | ■ Quick Start Guide |

CAUTION

- *¹ All guarantees and warranties are void for any problems or damage caused by a power cable not supplied by iiyama.
An approved power cable greater or equal to H05VVVF, 3G, 0.75mm² must be used.
- *² Accessory for ProLite XUB2793QSU, XU2793QSU
- *³ Accessory for ProLite XUB2293HSU, XU2293HSU, XUB2493HSU, XU2493HSU, XUB2793HSU, XU2793HSU, XUB2793QSU, XU2793QSU
- *⁴ Accessory for ProLite XUB2293HSU, XUB2493HSU, XUB2793HSU, XUB2793HS, XUB2793QSU
- *⁵ Accessory for ProLite XU2293HSU, XU2493HSU, XU2793HSU, XU2793HS, XU2793QSU

USING ARM OR STAND**CAUTION**

- This product is designed for desktop use, not for digital signage (electronic signboard) applications such as ceiling hanging or wall mounting.
- Before installation, make sure the display arm or desk arm stand is strong enough to hold the necessary weight of the monitor and the mount.
- Panel angle adjustment range : 23° upward and 5° downward
- This product cannot be used with the monitor screen facing downward/upward.

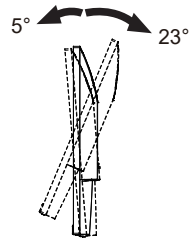
**< DISPLAY ARM OR DESK ARM STAND >****CAUTION**

When you use with the display arm or desk arm stand, in consideration of thickness of the mounting stage, tighten the M4 Screws (4pcs) which "L" length is 10mm to fasten the monitor. Using the screw longer than this may cause electric shock or damage because it may contact with the electrical parts inside the monitor.

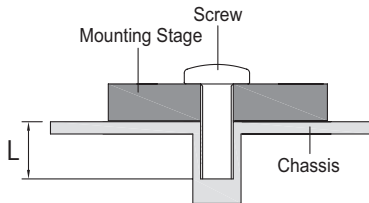

[ROTATING THE MONITOR]

• ProLite XUB2293HSU, XUB2493HSU, XUB2793HSU, XUB2793HS, XUB2793QSU

The monitor is designed to be compatible with both landscape and portrait modes.
Video card for portrait display will be required for rotating the image on the screen.

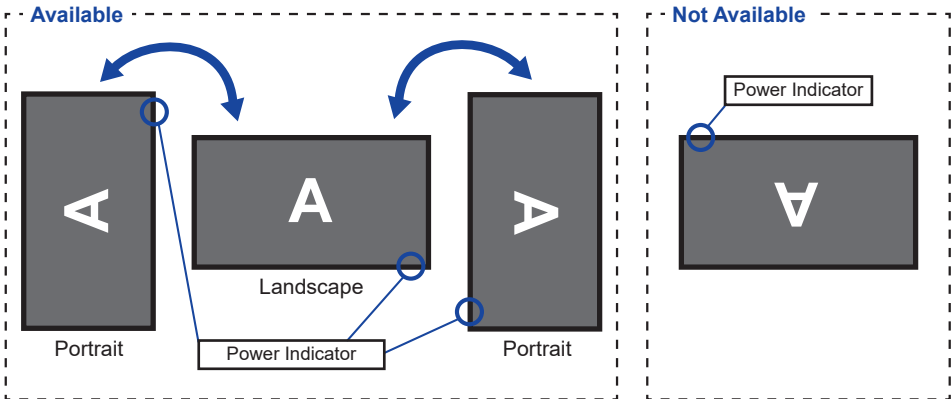

With Stand:

- NOTE**
- Adjust the monitor's height before panel rotation.
 - Attempting to rotate the panel forcibly without adjusting the stand height may cause damage to the panel or the stand.

• ProLite XU2293HSU, XU2493HSU, XU2793HSU, XU2793HS, XU2793QSU

The monitor is designed to be compatible only with the landscape mode.

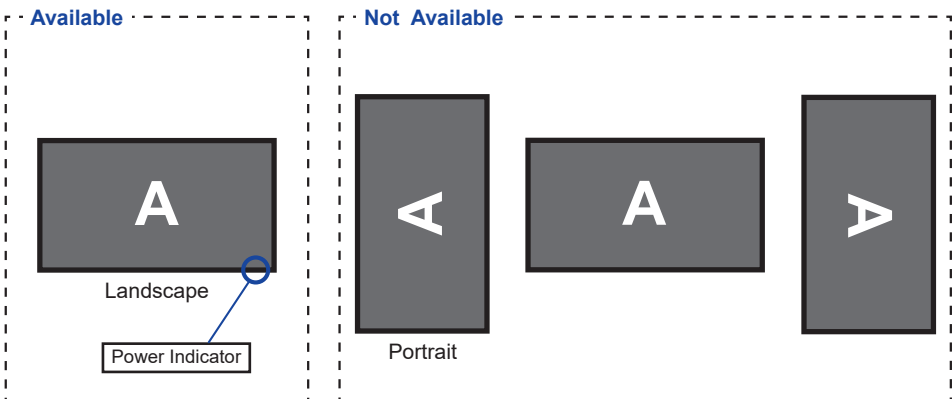

FITTING AND REMOVAL OF STAND : ProLite XUB2293HSU, XUB2493HSU, XUB2793HSU, XUB2793HS, XUB2793QSU

CAUTION

- Put the monitor on a stable surface. The monitor may cause injury or damage if it falls or is dropped.
- Do not give a strong impact to the monitor. It may cause damage.
- Unplug the monitor before removal or installation to avoid an electric shock or a damage.

<Installation>

- ① Attach the Stand-Neck to the VESA Plate and then tighten the 'thumb screw' with the provided screwdriver to secure them.

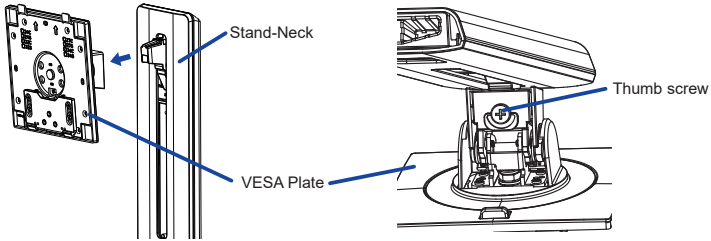

- ② Install the Stand-Base to the Stand-Neck and then tighten the 'thumb screw' with the provided screwdriver to secure them.

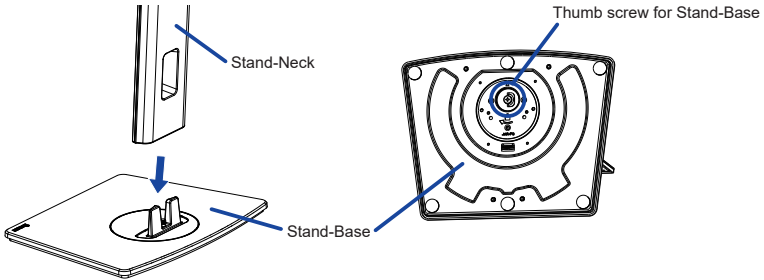

- ③ Put a piece of soft cloth on the table beforehand to prevent the monitor from being scratched. Lay the monitor flat on a table with front face down.
- ④ Hold the monitor and install the assembled stand to the monitor until it clicks to secure.

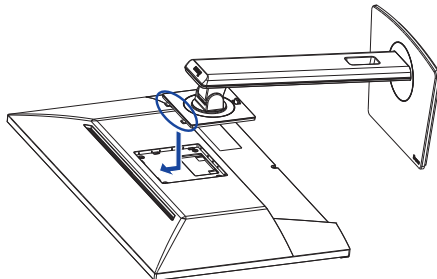

<Removal>

- ① Put a piece of soft cloth on the table beforehand to prevent the monitor from being scratched. Lay the monitor flat on a table with front face down.
- ② Press the release button to remove the stand.

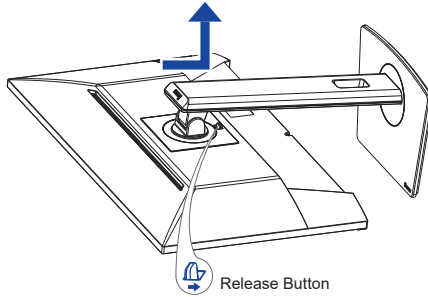

- ③ Loosen the 'thumb screw' with the provided screwdriver to remove the Stand-Neck from the VESA Plate.
- ④ Loosen the 'thumb screw' with the provided screwdriver to remove the Stand-Base from the Stand-Neck.

FITTING AND REMOVAL OF BASE : ProLite XU2293HSU, XU2493HSU, XU2793HSU, XU2793HS, XU2793QSU

CAUTION

- Put the monitor on a stable surface. The monitor may cause injury or damage if it falls or is dropped.
- Do not give a strong impact to the monitor. It may cause damage.
- Unplug the monitor before removal or installation to avoid an electric shock or a damage.

<Installation>

- ① Put a piece of soft cloth on the table beforehand to prevent the monitor from being scratched. Lay the monitor flat on a table with front face down.
- ② Hold the monitor and install the Stand-Neck to the monitor until it clicks to secure.
- ③ Install the Stand-Base to the Stand-Neck.
- ④ Place the Cable Holder.

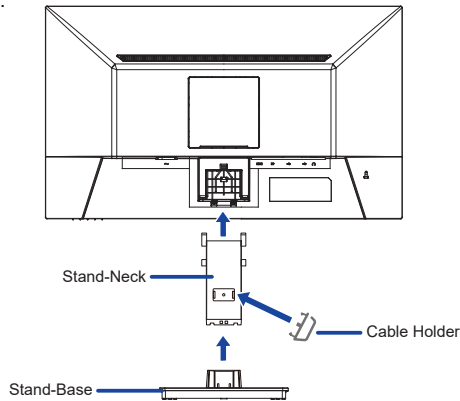

<Removal>

- ① Put a piece of soft cloth on the table beforehand to prevent the monitor from being scratched. Lay the monitor flat on a table with front face down.
- ② Keep pressing the Hooks inward to pull out the Stand-Base.
- ③ Press the release button and remove the Stand-Neck from the monitor.
- ④ Remove the Cable Holder.

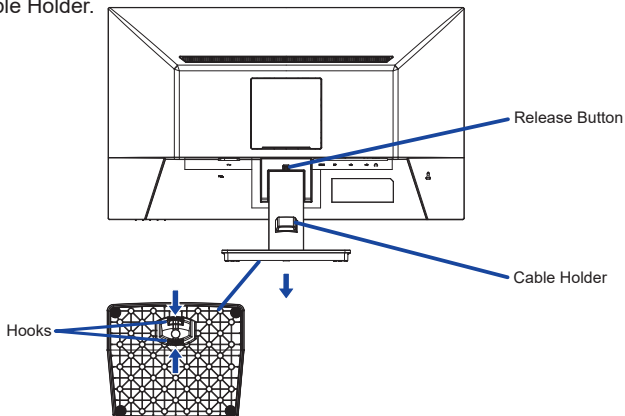

CONTROLS AND CONNECTORS : ProLite XUB2293HSU, XUB2493HSU, XUB2793HSU, XUB2793HS, XUB2793QSU

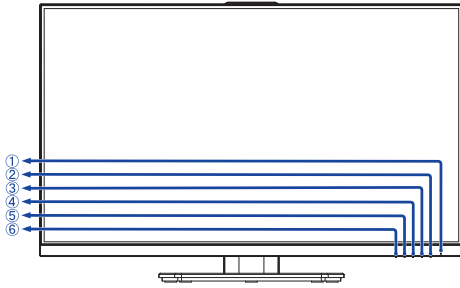

<Front>

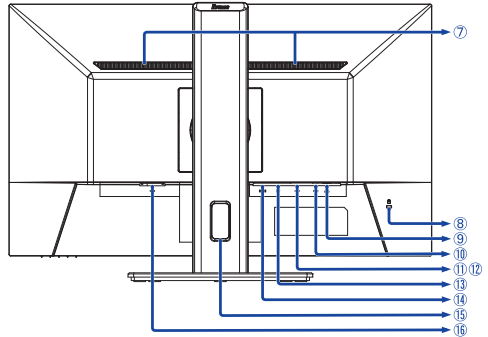

<Back>

① Power Indicator

NOTE Blue: Normal operation
Orange: Standby mode

② Power button (⏻)

③ Menu Button (MENU)

④ Up / Right / Volume Button (▶ / 🔊) *1

⑤ Down / Left / i-Style Color Button (◀ / 🎨) *1

⑥ Input Select / Exit Button (INPUT/EXIT) *1

⑦ Speakers

⑧ Keyhole for Security Lock

NOTE You can fasten a security lock and cable to prevent the monitor from being removed without your permission.

⑨ Headphone Connector (🎧)

⑩ USB Upstream Connector (🔌) *2

⑪ USB Downstream Connector (🔌) *3

⑫ USB Downstream Connector (🔌) *3

⑬ DisplayPort Connector (DP)

⑭ HDMI Connector (HDMI)

⑮ Cable Hole

⑯ AC Connector (⚡ : Alternating current)

*1 You can skip the Menu items and directly display an option setting screen or an adjustment scale.

*2 Available for ProLite XUB2293HSU, XUB2493HSU, XUB2793HSU, XUB2793QSU only.

*3 ProLite XUB2293HSU, ProLite XUB2493HSU, ProLite XUB2793HSU : USB2.0 (5V, 500mA)
ProLite XUB2793QSU : USB3.2 Gen1 (5Gbps, 5V, 900mA)

CONTROLS AND CONNECTORS : ProLite XU2293HSU, XU2493HSU, XU2793HSU, XU2793HS, XU2793QSU

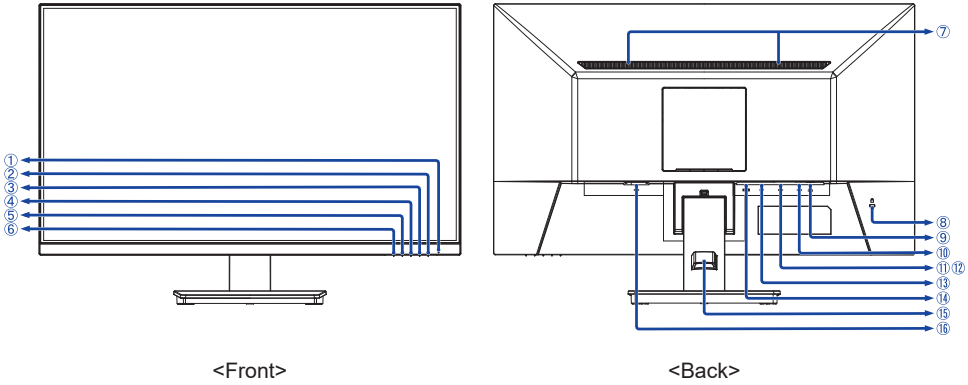

- ① Power Indicator

NOTE Blue: Normal operation
Orange: Standby mode

- ② Power button (⏻)
- ③ Menu Button (MENU)
- ④ Up / Right / Volume Button (▶ / 🔊) *1
- ⑤ Down / Left / i-Style Color Button (◀ / 🎨) *1
- ⑥ Input Select / Exit Button (INPUT/EXIT) *1
- ⑦ Speakers
- ⑧ Keyhole for Security Lock

NOTE You can fasten a security lock and cable to prevent the monitor from being removed without your permission.

- ⑨ Headphone Connector (🎧)
- ⑩ USB Upstream Connector (🔌) *2
- ⑪ USB Downstream Connector (🔌) *3
- ⑫ USB Downstream Connector (🔌) *3
- ⑬ DisplayPort Connector (DP)
- ⑭ HDMI Connector (HDMI)
- ⑮ Cable Holder
- ⑯ AC Connector (⚡ : Alternating current)

*1 You can skip the Menu items and directly display an option setting screen or an adjustment scale.

*2 Available for ProLite XU2293HSU, XU2493HSU, XU2793HSU, XU2793QSU only.

*3 ProLite XU2293HSU, ProLite XU2493HSU, ProLite XU2793HSU : USB2.0 (5V, 500mA)
ProLite XU2793QSU : USB3.2 Gen1 (5Gbps, 5V, 900mA)

CONNECTING YOUR MONITOR : ProLite XUB2293HSU, XUB2493HSU, XUB2793HSU, XUB2793HS, XUB2793QSU

- ① Ensure that both the computer and the monitor are switched off.
- ② Connect the computer to the monitor with the signal cable.
- ③ Connect the computer to the monitor with the USB Cable.
- ④ Connect the Power Cable to the monitor first and then to the power source.
- ⑤ Turn on your monitor and computer.

NOTE

- Make sure that the building installation has a circuit breaker of 120/240V, 20A (maximum).
- The signal cables used for connecting the computer and monitor may vary with the type of computer used. An incorrect connection may cause serious damage to both the monitor and the computer. The cable supplied with the monitor is for a standard connector. If a special cable is required please contact your local iiyama dealer or regional iiyama office.
- Make sure you tighten the finger screws at each end of the signal cable.
- The Class I pluggable equipment Type A must be connected to protective earth.
- The socket-outlet shall be installed near the equipment and shall be easily accessible.
- Excessive sound pressure from ear-/headphones can cause hearing damage/hearing loss.

[Example of Connection]

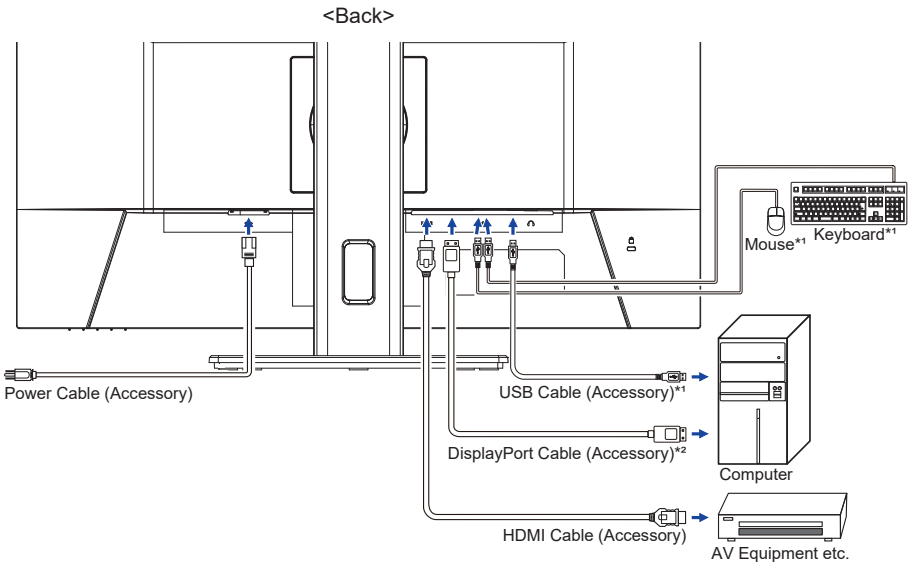

*1 Available for ProLite XUB2293HSU, XUB2493HSU, XUB2793HSU, XUB2793QSU only.

*2 Available for ProLite XUB2793QSU only.

[Collect Cables]

Put the cables through the cable hole to bundle them.

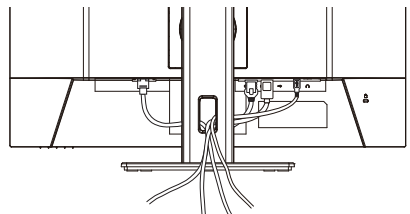

CONNECTING YOUR MONITOR : ProLite XU2293HSU, XU2493HSU, XU2793HSU, XU2793HS, XU2793QSU

- ① Ensure that both the computer and the monitor are switched off.
- ② Connect the computer to the monitor with the signal cable.
- ③ Connect the computer to the monitor with the USB Cable.
- ④ Connect the Power Cable to the monitor first and then to the power source.
- ⑤ Turn on your monitor and computer.

NOTE

- Make sure that the building installation has a circuit breaker of 120/240V, 20A (maximum).
- The signal cables used for connecting the computer and monitor may vary with the type of computer used. An incorrect connection may cause serious damage to both the monitor and the computer. The cable supplied with the monitor is for a standard connector. If a special cable is required please contact your local iiyama dealer or regional iiyama office.
- Make sure you tighten the finger screws at each end of the signal cable.
- The Class I pluggable equipment Type A must be connected to protective earth.
- The socket-outlet shall be installed near the equipment and shall be easily accessible.
- Excessive sound pressure from ear-/headphones can cause hearing damage/hearing loss.

[Example of Connection]

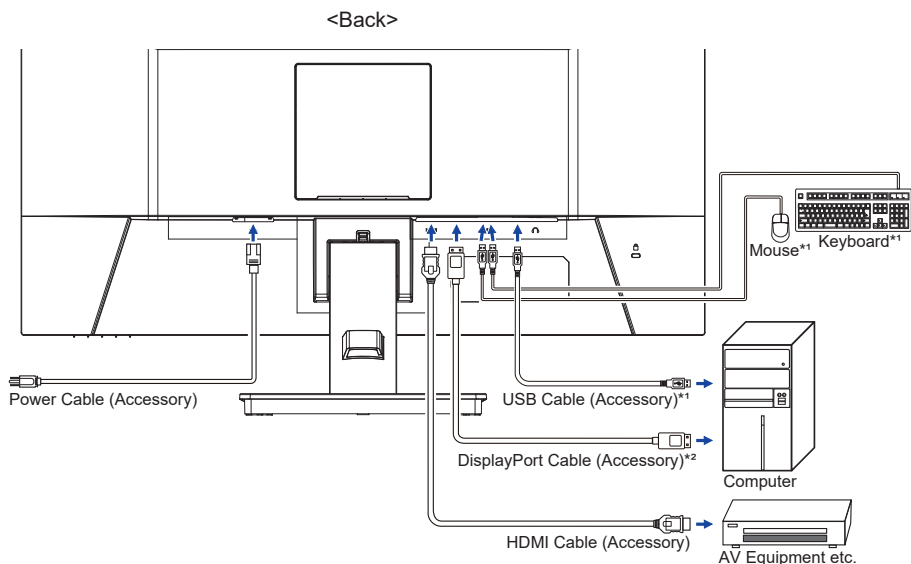

*1 Available for ProLite XU2293HSU, XU2493HSU, XU2793HSU, XU2793QSU only.

*2 Available for ProLite XU2793QSU only.

[Collect Cables]

Put the cables through the cable holder to bundle them.

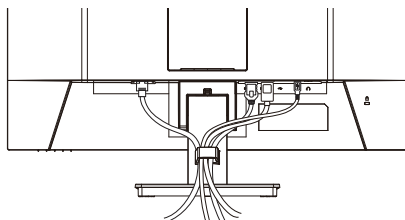

DISCONNECTING YOUR MONITOR

- ① Ensure that both the computer and the monitor are switched off.
- ② Disconnect the power source first and then the Power Cable from the monitor.
- ③ Disconnect the audio cable from the computer and the monitor.
- ④ Disconnect the signal cable from the computer and the monitor.

COMPUTER SETTING

- Signal Timing
Change to the desired signal timing listed on page 38: COMPLIANT TIMING.

ADJUSTING THE HEIGHT AND THE VIEWING ANGLE : ProLite XUB2293HSU, XUB2493HSU, XUB2793HSU, XUB2793HS, XUB2793QSU

- For optimal viewing it is recommended to position yourself directly opposite to the full face of the monitor, then adjust the monitor's height and angle to your own preference.
- Hold the panel so that the monitor does not topple when you change the monitor's height or angle.
- You are able to adjust the monitor's height up to 150mm, angle up to 45° right and left, 23° upward and 5° downward.

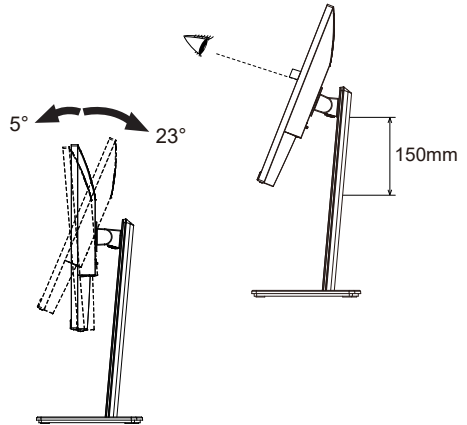

NOTE

- Do not touch the LCD screen when you change the height or the angle. It may cause damage or break the LCD screen.
- Careful attention is required not to pinch your fingers or hands into the moving part of the stand when you change the angle.
- Injury can occur if care is not taken to avoid finger contact with the displays base when adjusting the height.

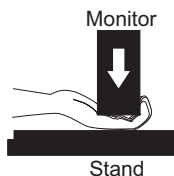
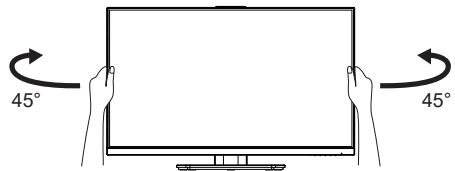

ADJUSTING THE VIEWING ANGLE : ProLite XU2293HSU, XU2493HSU, XU2793HSU, XU2793HS, XU2793QSU

- For optimal viewing it is recommended to look at the full face of the monitor.
- Hold the stand so that the monitor does not topple when you change the monitor's angle.
- You are able to adjust the monitor's angle up to 22° upward, 4° downward.
- In order to ensure a healthy and relaxed body position when using the monitor at visual display workstations, it is recommended that the adjusted tilt angle should not exceed 10°. Adjust the monitor's angle to your own preference.

NOTE

- Do not touch the LCD screen when you change the angle. It may cause damage or break the LCD screen.
- Careful attention is required not to catch your fingers or hands when you change the angle.

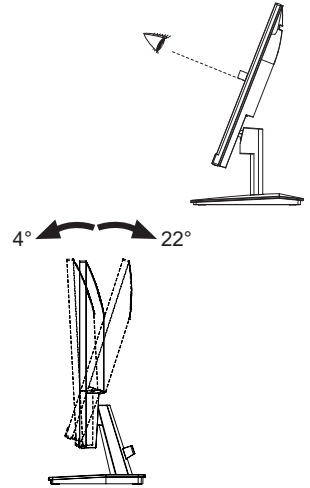

OPERATING THE MONITOR

To create the best picture, your iiyama LCD monitor has been preset at the factory with the COMPLIANT TIMING shown on page 38. You are also able to adjust the picture by following the button operation shown below.

- 1 Press the **MENU** Button to start the On Screen Display (OSD) feature. There are additional Menu items which can be switched by using the ◀ / ▶ Buttons.



- 2 Select the Menu item which contains the adjustment icon relating to the adjustment you want to make. Press the **MENU** Button. Then, use the ◀ / ▶ Buttons to highlight the desired adjustment icon.
- 3 Press the **MENU** Button again. Use the ◀ / ▶ Buttons to make the appropriate adjustment or setting.
- 4 Press the **EXIT** Button to leave the menu, and the settings you just made would be automatically saved.

For example, to correct for OSD vertical position, select Menu item of “OSD” and press the **MENU** Button. Then, select “OSD Vertical Position” by using the ◀ / ▶ Buttons and press the **MENU** Button. Use the ◀ / ▶ Buttons to change the OSD vertical position settings. The OSD vertical position should be changing accordingly while you are doing this.

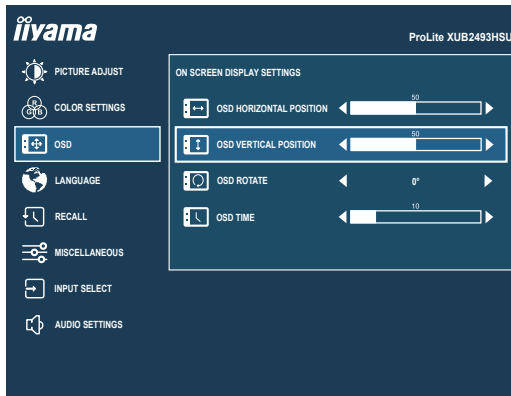

Press the **MENU** Button and finally the **EXIT** Button to close the On Screen Display feature. All changes are saved in the memory.

- NOTE**
- When button operations are aborted during adjustment, On Screen Display disappears when the time set for the “OSD Time” has passed. Also, the **EXIT** Button can be used to return previous menu and turn off the On Screen Display.
 - Any changes are automatically saved in the memory when the On Screen Display disappears. Turning off the power should be avoided while using the Menu.

ADJUSTMENT MENU CONTENTS

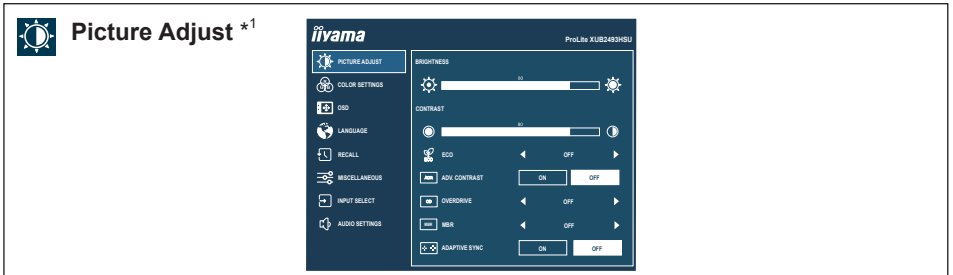

Adjustment Item	Problem / Option	Button to Press
Brightness *2	Too dark Too bright	
Contrast	Too dull Too intense	
Eco Direct	Off	Normal
	Mode 1	Brightness of back-light is reduced.
	Mode 2	Brightness of back-light is reduced more than Mode 1.
	Mode 3	Brightness of back-light is reduced more than Mode 2.
Adv. Contrast	On	Increased Contrast Ratio
	Off	Typical Contrast Ratio
Overdrive	Off / 1 / 2 / 3 Improves the gray level response time of the LCD panel. A higher level results in a faster response time.	
MBR *3	Off / 1 / 2 / 3 / 4 / 5 / 6 / 7 Reduces motion blur on the LCD panel.	
Adaptive Sync	On	Activates the Adaptive Sync function.
	Off	The Adaptive Sync function is turned off.

*1 Adjustments and settings may not be possible due to other items that are enabled. See page 18 “Function Correlation Matrix” for more details.

*2 Adjust the “Brightness” when you are using the monitor in a dark room and feel the screen is too bright.

*3 Disabled when “Adaptive Sync” is activated. Available when the refresh rate is 75Hz or higher. 100Hz is recommended.

Direct

You can skip the Menu items and directly display an option setting screen by using the following button operations.

- Eco : Press the Button for 3 seconds with no Menu displayed.

■ Function Correlation Matrix

Active item Selected item	Picture Adjust			Color Settings	
	Eco	Adv.Contrast	MBR	i-Style Color	Blue Light Reducer
				Standard Game Cinema Scenery Text	
Brightness	–	–	–	–	✓
Contrast	✓	–	✓	–	✓
Eco	–	✓	–	–	✓
Adv. Contrast	✓	–	–	–	✓
Overdrive	✓	✓	–	–	✓
MBR	–	–	–	–	–
Adaptive Sync	✓	✓	✓	✓	✓

✓ : Available

– : Not available



Color Settings

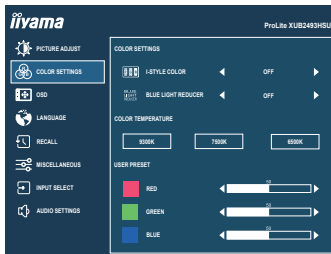

Adjustment Item	Problem / Option		Button to Press	
i-Style Color * ¹	Off	Returns to a state set by color adjustment except i-Style Color.		
	Standard	Standard	For general windows environment and monitor default setting	
		Game	For PC game environment	
		Cinema	For movie and video environment	
		Scenery	For displaying outdoor scenery images	
		Text	For text editing and viewing in a word processing environment	
Blue Light Reducer * ²	Off	Typical		
	Mode 1	Blue light is reduced.		
	Mode 2	Blue light is reduced more than Mode 1.		
	Mode 3	Blue light is reduced more than Mode 2.		
Color Temperature * ^{1,2}	9300K	Cool color		
	7500K	Normal color		
	6500K	Warm color		
User Preset * ^{1,2}	Red	Too weak	▶	
	Green			
	Blue	Too strong	◀	

Direct

















*¹ Disabled when "Blue Light Reducer" is activated.

*² Disabled when "i-Style Color" is activated.

Direct

You can skip the Menu items and directly display an option setting screen by using the following button operations.

- i-Style Color : Press the **i** Button with no Menu displayed.

Adjustment Item	Problem / Option	Button to Press
OSD Horizontal Position	OSD is too left OSD is too right	   
OSD Vertical Position	OSD is too low OSD is too high	   
OSD Rotate *	Rotates the OSD. 0° (Normal) / +90° (Rotate right) / -90° (Rotate left)	   
OSD Time	You can set the OSD display duration time between 5 and 30 seconds.	   

* For **ProLite XUB2293HSU, XUB2493HSU, XUB2793HSU, XUB2793HS, XUB2793QSU**

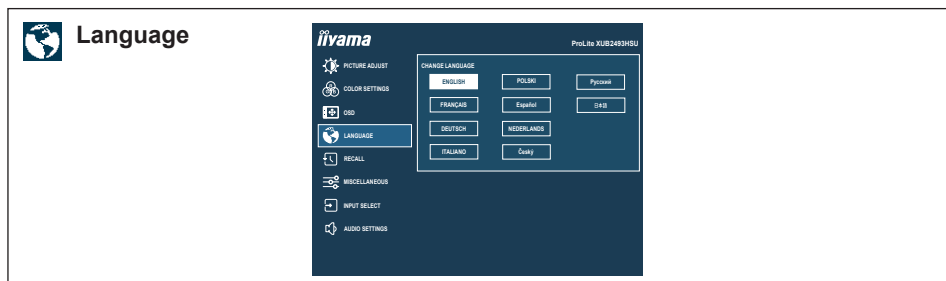

Adjustment Item	Option			
Language	English	English	Español	Spanish
	Français	French	Nederlands	Dutch
	Deutsch	German	Český	Czech
	Italiano	Italian	Русский	Russian
	Polski	Polish	日本語	Japanese

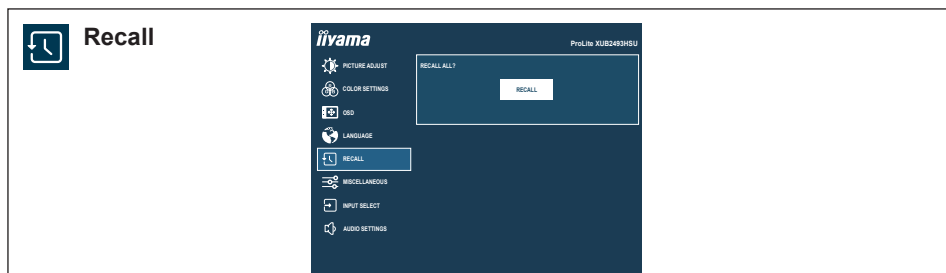



Adjustment Item	Option
Recall	Factory-preset data is restored.

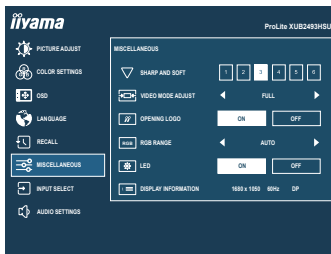

Miscellaneous



Adjustment Item	Problem / Option		Button to Press
Sharp and Soft	1 2 3 4 5 6 You can change the picture quality from 1 to 6 (sharp to soft). Press the ► Button to change the picture quality in numerical order. Press the ◀ Button to change the picture quality in reverse numerical order.		 
Video Mode Adjust	Full	Full screen display	
	Aspect *	Expansion display of Aspect	
Opening Logo	On	iiyama Logo is displayed when the monitor is turned on.	
	Off	iiyama Logo is not displayed when the monitor is turned on.	
RGB Range	Auto	Automatically selects color scale signal.	
	Full	For full-range color scale signal	
	Limited	For limited color scale signal	
LED	On	The Power Indicator is turned On.	
	Off	The Power Indicator is turned Off.	
<p>NOTE Turn Off the Power Indicator when you are bothered by the light.</p>			
Display Information	Displays information regarding the current input signal coming from the graphics card in your computer.		
	<p>NOTE See your graphics card user guide for more information about changing the resolution and refresh.</p>		

* Option is unavailable with 16:9 resolution.

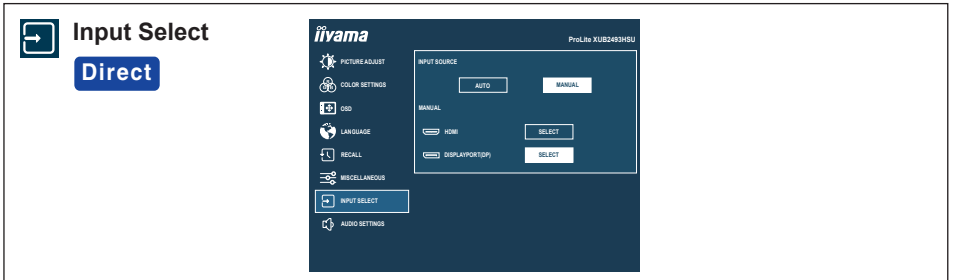

Adjustment Item	Option		
Input Source	Auto	Searches for an available input source and selects automatically.	
	Manual	HDMI	Selects the Digital (HDMI) input.
		DisplayPort(DP)	Selects the Digital (DisplayPort) input.

NOTE “Auto” function enables automatic selection of the input sources available. The input source from the computer in standby mode can not be selected. If you manually select one of the input sources, the other source is not automatically selected.



Direct

You can skip the Menu items and directly display an option setting screen by using the following button operations.

- Input Select : Press the INPUT Button with no Menu displayed.

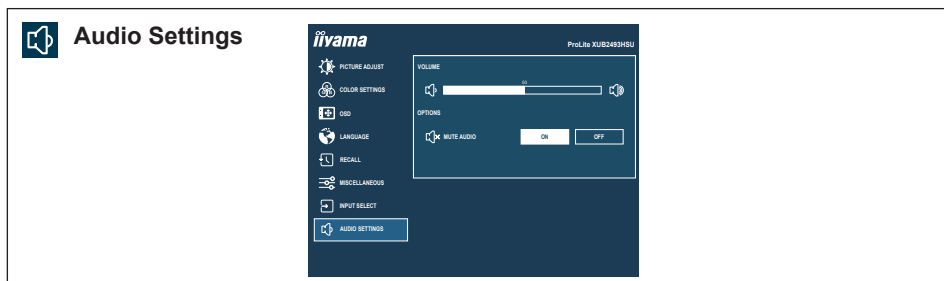





Adjustment Item	Problem / Option	Button to Press
Volume Direct	Too soft Too loud	 
Mute Audio Direct	On	Turns off the sound temporarily.
	Off	Returns the sound volume to the previous level.

Direct

You can skip the Menu items and directly display an option setting screen by using the following button operations.

- Volume : Press the  Button with no Menu displayed.
- Mute Audio : Press the  Button for 3 seconds with no Menu displayed.

● Lock Mode

<OSD Menu>

1. The OSD lock will be activated by pressing the MENU Button for 10 seconds. If you try to access the OSD by pressing any of the buttons, message “OSD LOCKED” will appear on the screen.
2. The OSD lock will be deactivated by pressing the MENU Button again for 10 seconds.

<Power Button>

1. The Power Button lock will be activated by pressing the EXIT Button for 10 seconds. Locking the Power Button means that won't be able to turn off the Monitor while the Power Button is locked. If you press the Power Button, message “POWER BUTTON LOCKED” will appear on the screen.
2. The Power Button lock will be deactivated by pressing the EXIT Button again for 10 seconds.

STANDBY FEATURE

This product features the standby function. When activated, it automatically reduces unnecessary power consumption of the monitor when your computer is not in use.

There is a standby step the monitor takes as described below. The standby function, including any timer settings is configured by the operating system. Check your operating system manual for information on how this can be configured.

■ Standby Mode

When the video signal from the computer is off, the monitor enters into Standby Mode which reduces the power consumption to less than 0.5W*. The screen becomes dark, and the power indicator turns to orange. From Standby Mode, the image reappears in several seconds when either the keyboard or the mouse are touched again.

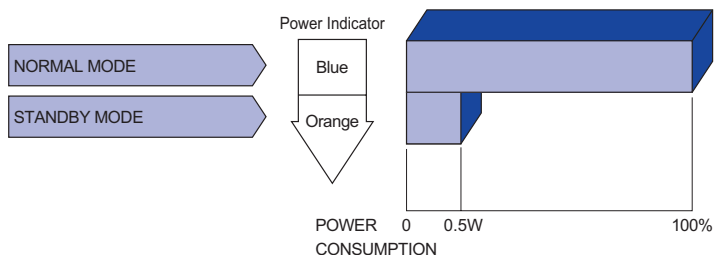

* When the USB devices are not connected.

TROUBLE SHOOTING

If the monitor fails to operate correctly, please follow the steps below for a possible solution.

1. Perform the adjustments described in OPERATING THE MONITOR, depending on the problem you have. If the monitor does not get a picture, skip to 2.
2. Consult the following items if you cannot find an appropriate adjustment item in OPERATING THE MONITOR or if the problem persists.
3. If you are experiencing a problem which is not described below or you cannot correct the problem, discontinue using the monitor and contact your dealer or iiyama service center for further assistance.

Problem	Check
① The picture does not appear. (Power indicator does not light up.) (Power indicator is blue.) (Power indicator is orange.)	<input type="checkbox"/> The Power Cable is firmly seated in the socket. <input type="checkbox"/> The Power Switch is turned ON. <input type="checkbox"/> The AC socket is live. Please check with another piece of equipment. <input type="checkbox"/> If the blank screen saver is in active mode, touch the keyboard or the mouse. <input type="checkbox"/> Increase the Contrast and/or Brightness. <input type="checkbox"/> The computer is ON. <input type="checkbox"/> The Signal Cable is properly connected. <input type="checkbox"/> The signal timing of the computer is within the specification of the monitor. <input type="checkbox"/> If the monitor is in Standby Mode, touch the keyboard or the mouse. <input type="checkbox"/> The computer is ON. <input type="checkbox"/> The Signal Cable is properly connected. <input type="checkbox"/> The signal timing of the computer is within the specification of the monitor.
② The screen is not synchronized.	<input type="checkbox"/> The Signal Cable is properly connected. <input type="checkbox"/> The signal timing of the computer is within the specification of the monitor.
③ The screen position is not in the center.	<input type="checkbox"/> The signal timing of the computer is within the specification of the monitor.
④ The screen is too bright or too dark.	<input type="checkbox"/> The video output level of the computer is within the specification of the monitor.
⑤ The screen is shaking.	<input type="checkbox"/> The power voltage is within the specification of the monitor. <input type="checkbox"/> The signal timing of the computer is within the specification of the monitor.

Problem

Check

- | | |
|---------------------------------------|--|
| ⑥ No sound. | <input type="checkbox"/> The audio equipment (computer etc.) is ON. |
| | <input type="checkbox"/> The Audio Cable is properly connected. |
| | <input type="checkbox"/> The Volume is turned up. |
| | <input type="checkbox"/> The Mute is OFF. |
| | <input type="checkbox"/> The audio output level of the audio equipment is within the specification of the monitor. |
| ⑦ The sound is too loud or too quiet. | <input type="checkbox"/> The audio output level of the audio equipment is within the specification of the monitor. |
| ⑧ A strange noise is heard. | <input type="checkbox"/> The Audio Cable is properly connected. |

RECYCLING INFORMATION

For better environment protection please don't dispose your monitor.
Please visit our web site: <https://iiyama.com> for monitor recycling.

APPENDIX

Design and specifications are subject to change without prior notice.

SPECIFICATIONS : ProLite XUB2293HSU-B6

Size Category	22"	
LCD Panel	Panel technology	IPS Panel Technology
	Size	Diagonal: 21.45" (54.5cm)
	Pixel pitch	0.249mm H × 0.241mm V
	Brightness	250cd/m ² (Typical), 160cd/m ² (Default / Energy Saving)
	Contrast ratio	1000 : 1 (Typical), Adv. Contrast Function Available
	Viewable angle	Right / Left : 89 degrees each, Up / Down : 89 degrees each (Typical)
	MPRT	1ms
Display Colors	Approx. 16.7M	
Sync Frequency	HDMI(Adaptive Sync: Off): Horizontal: 30.0-110.0kHz, Vertical: 55-100Hz HDMI(Adaptive Sync: On): Horizontal: 30.0-110.0kHz, Vertical: 48-100Hz DisplayPort(Adaptive Sync: Off): Horizontal: 30.0-110.0kHz, Vertical: 55-100Hz DisplayPort(Adaptive Sync: On): Horizontal: 30.0-110.0kHz, Vertical: 48-100Hz	
Native Resolution	1920 × 1080, 2.1 MegaPixels	
Support max. resolution	HDMI(Adaptive Sync: Off): 1920 × 1080, 100Hz HDMI(Adaptive Sync: On): 1920 × 1080, 100Hz DisplayPort(Adaptive Sync: Off): 1920 × 1080, 100Hz DisplayPort(Adaptive Sync: On): 1920 × 1080, 100Hz	
Input Connector	HDMI, DisplayPort	
Input Video Signal	HDMI, DisplayPort	
USB Standard	USB2.0 (DC5V, 500mA)	
Number of USB Ports	1 Upstream : Series B	
Connector shape	2 Downstream : Series A	
Headphone Connector	ø 3.5mm mini jack (Stereo)	
Speakers	2W × 2 (Stereo speakers)	
Maximum Screen Size	478.66mm W × 260.28mm H / 18.84" W × 10.25" H	
Power Source	100-240VAC, 50/60Hz, 1.5A	
Power Consumption *	17W typical Standby mode: 0.5W maximum, Off mode: 0.3W maximum	
Dimensions / Net Weight	492.0 × 328.5 - 478.5 × 209.5mm / 19.4 × 12.9 - 18.8 × 8.2" (W×H×D) 3.9kg / 8.60lbs	
Height Adjustment Range	150mm	
Angle	Tilt: Upward: 23 degrees, Downward: 5 degrees Swivel: Left / Right: 45 degrees each Rotation: Clockwise / Counterclockwise: 90 degrees each	
Environmental Considerations	Operating: Temperature 5 to 35°C / 41 to 95°F Humidity 10 to 80% (No condensation) Storage: Temperature -20 to 60°C / -4 to 140°F Humidity 10 to 90% (No condensation)	
EPEAT Bronze	Registration varies by country, go to www.epeat.net for details	
Approvals	TCO Certified, CE, UKCA, TÜV-Bauart, VCCI, PSE, EAC	

SPECIFICATIONS : ProLite XU2293HSU-B6

Size Category		22"
LCD Panel	Panel technology	IPS Panel Technology
	Size	Diagonal: 21.45" (54.5cm)
	Pixel pitch	0.249mm H × 0.241mm V
	Brightness	250cd/m ² (Typical), 160cd/m ² (Default / Energy Saving)
	Contrast ratio	1000 : 1 (Typical), Adv. Contrast Function Available
	Viewable angle	Right / Left : 89 degrees each, Up / Down : 89 degrees each (Typical)
	MPRT	1ms
Display Colors		Approx. 16.7M
Sync Frequency		HDMI(Adaptive Sync: Off): Horizontal: 30.0-110.0kHz, Vertical: 55-100Hz HDMI(Adaptive Sync: On): Horizontal: 30.0-110.0kHz, Vertical: 48-100Hz DisplayPort(Adaptive Sync: Off): Horizontal: 30.0-110.0kHz, Vertical: 55-100Hz DisplayPort(Adaptive Sync: On): Horizontal: 30.0-110.0kHz, Vertical: 48-100Hz
Native Resolution		1920 × 1080, 2.1 MegaPixels
Support max. resolution		HDMI(Adaptive Sync: Off): 1920 × 1080, 100Hz HDMI(Adaptive Sync: On): 1920 × 1080, 100Hz DisplayPort(Adaptive Sync: Off): 1920 × 1080, 100Hz DisplayPort(Adaptive Sync: On): 1920 × 1080, 100Hz
Input Connector		HDMI, DisplayPort
Input Video Signal		HDMI, DisplayPort
USB Standard		USB2.0 (DC5V, 500mA)
Number of USB Ports		1 Upstream : Series B
Connector shape		2 Downstream : Series A
Headphone Connector		ø 3.5mm mini jack (Stereo)
Speakers		2W × 2 (Stereo speakers)
Maximum Screen Size		478.66mm W × 260.28mm H / 18.84" W × 10.25" H
Power Source		100-240VAC, 50/60Hz, 1.5A
Power Consumption *		17W typical Standby mode: 0.5W maximum, Off mode: 0.3W maximum
Dimensions / Net Weight		492.0 × 359.0 × 178.0mm / 19.4 × 14.1 × 7.0" (W×H×D) 2.6kg / 5.73lbs
Tilt Angle		Upward: 22 degrees Downward: 4 degrees
Environmental Considerations		Operating: Temperature 5 to 35°C / 41 to 95°F Humidity 10 to 80% (No condensation) Storage: Temperature -20 to 60°C / -4 to 140°F Humidity 10 to 90% (No condensation)
EPEAT Bronze		Registration varies by country, go to www.epeat.net for details
Approvals		TCO Certified, CE, UKCA, TÜV-Bauart, VCCI, PSE, EAC

NOTE * When the USB devices are not connected.

SPECIFICATIONS : ProLite XUB2493HSU-B6

Size Category	24"	
LCD Panel	Panel technology	IPS Panel Technology
	Size	Diagonal: 23.8" (60.5cm)
	Pixel pitch	0.275mm H × 0.275mm V
	Brightness	250cd/m ² (Typical), 160cd/m ² (Default / Energy Saving)
	Contrast ratio	1000 : 1 (Typical), Adv. Contrast Function Available
	Viewable angle	Right / Left : 89 degrees each, Up / Down : 89 degrees each (Typical)
	MPRT	1ms
Display Colors	Approx. 16.7M	
Sync Frequency	HDMI(Adaptive Sync: Off): Horizontal: 30.0-110.0kHz, Vertical: 55-100Hz HDMI(Adaptive Sync: On): Horizontal: 30.0-110.0kHz, Vertical: 48-100Hz DisplayPort(Adaptive Sync: Off): Horizontal: 30.0-110.0kHz, Vertical: 55-100Hz DisplayPort(Adaptive Sync: On): Horizontal: 30.0-110.0kHz, Vertical: 48-100Hz	
Native Resolution	1920 × 1080, 2.1 MegaPixels	
Support max. resolution	HDMI(Adaptive Sync: Off): 1920 × 1080, 100Hz HDMI(Adaptive Sync: On): 1920 × 1080, 100Hz DisplayPort(Adaptive Sync: Off): 1920 × 1080, 100Hz DisplayPort(Adaptive Sync: On): 1920 × 1080, 100Hz	
Input Connector	HDMI, DisplayPort	
Input Video Signal	HDMI, DisplayPort	
USB Standard	USB2.0 (DC5V, 500mA)	
Number of USB Ports	1 Upstream : Series B	
Connector shape	2 Downstream : Series A	
Headphone Connector	ø 3.5mm mini jack (Stereo)	
Speakers	2W × 2 (Stereo speakers)	
Maximum Screen Size	527.04mm W × 296.46mm H / 20.75" W × 11.67" H	
Power Source	100-240VAC, 50/60Hz, 1.5A	
Power Consumption *	18W typical Standby mode: 0.5W maximum, Off mode: 0.3W maximum	
Dimensions / Net Weight	538.5 × 350.0 - 500.0 × 209.5mm / 21.2 × 13.8 - 19.7 × 8.2" (W×H×D) 4.6kg / 10.14lbs	
Height Adjustment Range	150mm	
Angle	Tilt: Upward: 23 degrees, Downward: 5 degrees Swivel: Left / Right: 45 degrees each Rotation: Clockwise / Counterclockwise: 90 degrees each	
Environmental Considerations	Operating: Temperature 5 to 35°C / 41 to 95°F Humidity 10 to 80% (No condensation) Storage: Temperature -20 to 60°C / -4 to 140°F Humidity 10 to 90% (No condensation)	
EPEAT Bronze	Registration varies by country, go to www.epeat.net for details	
Approvals	TCO Certified, CE, UKCA, TÜV-Bauart, VCCI, PSE, EAC	

NOTE * When the USB devices are not connected.

SPECIFICATIONS : ProLite XU2493HSU-B6

Size Category		24"
LCD Panel	Panel technology	IPS Panel Technology
	Size	Diagonal: 23.8" (60.5cm)
	Pixel pitch	0.275mm H × 0.275mm V
	Brightness	250cd/m ² (Typical), 160cd/m ² (Default / Energy Saving)
	Contrast ratio	1000 : 1 (Typical), Adv. Contrast Function Available
	Viewable angle	Right / Left : 89 degrees each, Up / Down : 89 degrees each (Typical)
	MPRT	1ms
Display Colors		Approx. 16.7M
Sync Frequency		HDMI(Adaptive Sync: Off): Horizontal: 30.0-110.0kHz, Vertical: 55-100Hz HDMI(Adaptive Sync: On): Horizontal: 30.0-110.0kHz, Vertical: 48-100Hz DisplayPort(Adaptive Sync: Off): Horizontal: 30.0-110.0kHz, Vertical: 55-100Hz DisplayPort(Adaptive Sync: On): Horizontal: 30.0-110.0kHz, Vertical: 48-100Hz
Native Resolution		1920 × 1080, 2.1 MegaPixels
Support max. resolution		HDMI(Adaptive Sync: Off): 1920 × 1080, 100Hz HDMI(Adaptive Sync: On): 1920 × 1080, 100Hz DisplayPort(Adaptive Sync: Off): 1920 × 1080, 100Hz DisplayPort(Adaptive Sync: On): 1920 × 1080, 100Hz
Input Connector		HDMI, DisplayPort
Input Video Signal		HDMI, DisplayPort
USB Standard		USB2.0 (DC5V, 500mA)
Number of USB Ports		1 Upstream : Series B
Connector shape		2 Downstream : Series A
Headphone Connector		ø 3.5mm mini jack (Stereo)
Speakers		2W × 2 (Stereo speakers)
Maximum Screen Size		527.04mm W × 296.46mm H / 20.75" W × 11.67" H
Power Source		100-240VAC, 50/60Hz, 1.5A
Power Consumption *		18W typical Standby mode: 0.5W maximum, Off mode: 0.3W maximum
Dimensions / Net Weight		538.5 × 393.0 × 178.5mm / 21.2 × 15.5 × 7.0" (W×H×D) 3.0kg / 6.61lbs
Tilt Angle		Upward: 22 degrees Downward: 4 degrees
Environmental Considerations		Operating: Temperature 5 to 35°C / 41 to 95°F Humidity 10 to 80% (No condensation) Storage: Temperature -20 to 60°C / -4 to 140°F Humidity 10 to 90% (No condensation)
EPEAT Bronze		Registration varies by country, go to www.epeat.net for details
Approvals		TCO Certified, CE, UKCA, TÜV-Bauart, VCCI, PSE, EAC

NOTE * When the USB devices are not connected.

SPECIFICATIONS : ProLite XUB2793HSU-B6

Size Category	27"	
LCD Panel	Panel technology	IPS Panel Technology
	Size	Diagonal: 27" (68.6cm)
	Pixel pitch	0.3114mm H × 0.3114mm V
	Brightness	250cd/m ² (Typical), 170cd/m ² (Default / Energy Saving)
	Contrast ratio	1000 : 1 (Typical), Adv. Contrast Function Available
	Viewable angle	Right / Left : 89 degrees each, Up / Down : 89 degrees each (Typical)
	MPRT	1ms
Display Colors	Approx. 16.7M	
Sync Frequency	HDMI(Adaptive Sync: Off): Horizontal: 30.0-110.0kHz, Vertical: 55-100Hz HDMI(Adaptive Sync: On): Horizontal: 30.0-110.0kHz, Vertical: 48-100Hz DisplayPort(Adaptive Sync: Off): Horizontal: 30.0-110.0kHz, Vertical: 55-100Hz DisplayPort(Adaptive Sync: On): Horizontal: 110.0kHz, Vertical: 48-100Hz	
Native Resolution	1920 × 1080, 2.1 MegaPixels	
Support max. resolution	HDMI(Adaptive Sync: Off): 1920 × 1080, 100Hz HDMI(Adaptive Sync: On): 1920 × 1080, 100Hz DisplayPort(Adaptive Sync: Off): 1920 × 1080, 100Hz DisplayPort(Adaptive Sync: On): 1920 × 1080, 100Hz	
Input Connector	HDMI, DisplayPort	
Input Video Signal	HDMI, DisplayPort	
USB Standard	USB2.0 (DC5V, 500mA)	
Number of USB Ports	1 Upstream : Series B	
Connector shape	2 Downstream : Series A	
Headphone Connector	ø 3.5mm mini jack (Stereo)	
Speakers	2W × 2 (Stereo speakers)	
Maximum Screen Size	597.888mm W × 336.312mm H / 23.54" W × 13.24" H	
Power Source	100-240VAC, 50/60Hz, 1.5A	
Power Consumption *	22W typical Standby mode: 0.5W maximum, Off mode: 0.3W maximum	
Dimensions / Net Weight	611.5 × 400.5 - 550.5 × 209.5mm / 24.1 × 15.8 - 21.7 × 8.2" (W×H×D) 5.4kg / 11.91lbs	
Height Adjustment Range	150mm	
Angle	Tilt: Upward: 23 degrees, Downward: 5 degrees Swivel: Left / Right: 45 degrees each Rotation: Clockwise / Counterclockwise: 90 degrees each	
Environmental Considerations	Operating: Temperature 5 to 35°C / 41 to 95°F Humidity 10 to 80% (No condensation) Storage: Temperature -20 to 60°C / -4 to 140°F Humidity 10 to 90% (No condensation)	
EPEAT Bronze	Registration varies by country, go to www.epeat.net for details	
Approvals	TCO Certified, CE, UKCA, TÜV-Bauart, VCCI, PSE, EAC	

NOTE * When the USB devices are not connected.

SPECIFICATIONS : ProLite XU2793HSU-B6

Size Category		27"
LCD Panel	Panel technology	IPS Panel Technology
	Size	Diagonal: 27" (68.6cm)
	Pixel pitch	0.3114mm H × 0.3114mm V
	Brightness	250cd/m ² (Typical), 170cd/m ² (Default / Energy Saving)
	Contrast ratio	1000 : 1 (Typical), Adv. Contrast Function Available
	Viewable angle	Right / Left : 89 degrees each, Up / Down : 89 degrees each (Typical)
	MPRT	1ms
Display Colors		Approx. 16.7M
Sync Frequency		HDMI(Adaptive Sync: Off): Horizontal: 30.0-110.0kHz, Vertical: 55-100Hz HDMI(Adaptive Sync: On): Horizontal: 30.0-110.0kHz, Vertical: 48-100Hz DisplayPort(Adaptive Sync: Off): Horizontal: 30.0-110.0kHz, Vertical: 55-100Hz DisplayPort(Adaptive Sync: On): Horizontal: 110.0kHz, Vertical: 48-100Hz
Native Resolution		1920 × 1080, 2.1 MegaPixels
Support max. resolution		HDMI(Adaptive Sync: Off): 1920 × 1080, 100Hz HDMI(Adaptive Sync: On): 1920 × 1080, 100Hz DisplayPort(Adaptive Sync: Off): 1920 × 1080, 100Hz DisplayPort(Adaptive Sync: On): 1920 × 1080, 100Hz
Input Connector		HDMI, DisplayPort
Input Video Signal		HDMI, DisplayPort
USB Standard		USB2.0 (DC5V, 500mA)
Number of USB Ports		1 Upstream : Series B
Connector shape		2 Downstream : Series A
Headphone Connector		ø 3.5mm mini jack (Stereo)
Speakers		2W × 2 (Stereo speakers)
Maximum Screen Size		597.888mm W × 336.312mm H / 23.54" W × 13.24" H
Power Source		100-240VAC, 50/60Hz, 1.5A
Power Consumption *		22W typical Standby mode: 0.5W maximum, Off mode: 0.3W maximum
Dimensions / Net Weight		611.5 × 435.0 × 189.0mm / 24.1 × 17.1 × 7.4" (W×H×D) 3.8kg / 8.38lbs
Tilt Angle		Upward: 22 degrees Downward: 4 degrees
Environmental Considerations		Operating: Temperature 5 to 35°C / 41 to 95°F Humidity 10 to 80% (No condensation) Storage: Temperature -20 to 60°C / -4 to 140°F Humidity 10 to 90% (No condensation)
EPEAT Bronze		Registration varies by country, go to www.epeat.net for details
Approvals		TCO Certified, CE, UKCA, TÜV-Bauart, VCCI, PSE, EAC

NOTE * When the USB devices are not connected.

SPECIFICATIONS : ProLite XUB2793HS-B6

Size Category	27"	
LCD Panel	Panel technology	IPS Panel Technology
	Size	Diagonal: 27" (68.6cm)
	Pixel pitch	0.3114mm H × 0.3114mm V
	Brightness	250cd/m ² (Typical), 170cd/m ² (Default / Energy Saving)
	Contrast ratio	1000 : 1 (Typical), Adv. Contrast Function Available
	Viewable angle	Right / Left : 89 degrees each, Up / Down : 89 degrees each (Typical)
	MPRT	1ms
Display Colors	Approx. 16.7M	
Sync Frequency	Horizontal: 30.0-110.0kHz, Vertical: 55-100Hz	
Native Resolution	1920 × 1080, 2.1 MegaPixels	
Support max. resolution	HDMI: 1920 × 1080, 100Hz DisplayPort(Adaptive Sync: Off): 1920 × 1080, 100Hz DisplayPort(Adaptive Sync: On): 1920 × 1080, 100Hz	
Input Connector	HDMI, DisplayPort	
Input Video Signal	HDMI, DisplayPort	
Headphone Connector	ø 3.5mm mini jack (Stereo)	
Speakers	2W × 2 (Stereo speakers)	
Maximum Screen Size	597.888mm W × 336.312mm H / 23.54" W × 13.24" H	
Power Source	100-240VAC, 50/60Hz, 1.5A	
Power Consumption *	22W typical Standby mode: 0.5W maximum, Off mode: 0.3W maximum	
Dimensions / Net Weight	611.5 × 400.5 - 550.5 × 209.5mm / 24.1 × 15.8 - 21.7 × 8.2" (W×H×D) 5.4kg / 11.9lbs	
Height Adjustment Range	150mm	
Angle	Tilt: Upward: 23 degrees, Downward: 5 degrees Swivel: Left / Right: 45 degrees each Rotation: Clockwise / Counterclockwise: 90 degrees each	
Environmental Considerations	Operating: Temperature 5 to 35°C / 41 to 95°F Humidity 10 to 80% (No condensation) Storage: Temperature -20 to 60°C / -4 to 140°F Humidity 10 to 90% (No condensation)	
EPEAT Bronze	Registration varies by country, go to www.epeat.net for details	
Approvals	TCO Certified, CE, UKCA, TÜV-Bauart, VCCI, PSE, EAC	

SPECIFICATIONS : ProLite XU2793HS-B6

Size Category		27"
LCD Panel	Panel technology	IPS Panel Technology
	Size	Diagonal: 27" (68.6cm)
	Pixel pitch	0.3114mm H × 0.3114mm V
	Brightness	250cd/m ² (Typical), 170cd/m ² (Default / Energy Saving)
	Contrast ratio	1000 : 1 (Typical), Adv. Contrast Function Available
	Viewable angle	Right / Left : 89 degrees each, Up / Down : 89 degrees each (Typical)
	MPRT	1ms
Display Colors		Approx. 16.7M
Sync Frequency		Horizontal: 30.0-110.0kHz, Vertical: 55-100Hz
Native Resolution		1920 × 1080, 2.1 MegaPixels
Support max. resolution		HDMI: 1920 × 1080, 100Hz DisplayPort(Adaptive Sync: Off): 1920 × 1080, 100Hz DisplayPort(Adaptive Sync: On): 1920 × 1080, 100Hz
Input Connector		HDMI, DisplayPort
Input Video Signal		HDMI, DisplayPort
Headphone Connector		ø 3.5mm mini jack (Stereo)
Speakers		2W × 2 (Stereo speakers)
Maximum Screen Size		597.888mm W × 336.312mm H / 23.54" W × 13.24" H
Power Source		100-240VAC, 50/60Hz, 1.5A
Power Consumption *		22W typical Standby mode: 0.5W maximum, Off mode: 0.3W maximum
Dimensions / Net Weight		611.5 × 435.0 × 189.0mm / 24.1 × 17.1 × 7.4" (W×H×D) 3.8kg / 8.38lbs
Tilt Angle		Upward: 22 degrees Downward: 4 degrees
Environmental Considerations		Operating: Temperature 5 to 35°C / 41 to 95°F Humidity 10 to 80% (No condensation) Storage: Temperature -20 to 60°C / -4 to 140°F Humidity 10 to 90% (No condensation)
EPEAT Bronze		Registration varies by country, go to www.epeat.net for details
Approvals		TCO Certified, CE, UKCA, TÜV-Bauart, VCCI, PSE, EAC

SPECIFICATIONS : ProLite XUB2793QSU-B6

Size Category		27"
LCD Panel	Panel technology	IPS Panel Technology
	Size	Diagonal: 27" (68.5cm)
	Pixel pitch	0.233mm H × 0.233mm V
	Brightness	250cd/m ² (Typical), 165cd/m ² (Default / Energy Saving)
	Contrast ratio	1300 : 1 (Typical), Adv. Contrast Function Available
	Viewable angle	Right / Left : 89 degrees each, Up / Down : 89 degrees each (Typical)
	MPRT	1ms
Display Colors		Approx. 16.7M
Sync Frequency		HDMI(Adaptive Sync: Off): Horizontal: 30.0-151.0kHz, Vertical: 55-100Hz HDMI(Adaptive Sync: On): Horizontal: 30.0-151.0kHz, Vertical: 48-100Hz DisplayPort(Adaptive Sync: Off): Horizontal: 30.0-151.0kHz, Vertical: 55-100Hz DisplayPort(Adaptive Sync: On): Horizontal: 151.0kHz, Vertical: 48-100Hz
Native Resolution		2560 × 1440, 3.7 MegaPixels
Support max. resolution		HDMI(Adaptive Sync: Off): 2560 × 1440, 100Hz HDMI(Adaptive Sync: On): 2560 × 1440, 100Hz DisplayPort(Adaptive Sync: Off): 2560 × 1440, 100Hz DisplayPort(Adaptive Sync: On): 2560 × 1440, 100Hz
Input Connector		HDMI, DisplayPort
Input Video Signal		HDMI, DisplayPort
USB Standard		USB3.2 Gen1 (5Gbps, DC5V, 900mA)
Number of USB Ports		1 Upstream : Series B
Connector shape		2 Downstream : Series A
Headphone Connector		ø 3.5mm mini jack (Stereo)
Speakers		2W × 2 (Stereo speakers)
Maximum Screen Size		596.7mm W × 335.7mm H / 23.49" W × 12.22" H
Power Source		100-240VAC, 50/60Hz, 1.5A
Power Consumption *		22W typical Standby mode: 0.5W maximum, Off mode: 0.3W maximum
Dimensions / Net Weight		613.5 × 400.5 - 550.5 × 209.5mm / 24.1 × 15.8 - 21.7 × 8.2" (W×H×D) 5.7kg / 12.57lbs
Height Adjustment Range		150mm
Angle		Tilt: Upward: 23 degrees, Downward: 5 degrees Swivel: Left / Right: 45 degrees each Rotation: Clockwise / Counterclockwise: 90 degrees each
Environmental Considerations		Operating: Temperature 5 to 35°C / 41 to 95°F Humidity 10 to 80% (No condensation) Storage: Temperature -20 to 60°C / -4 to 140°F Humidity 10 to 90% (No condensation)
EPEAT Bronze		Registration varies by country, go to www.epeat.net for details
Approvals		TCO Certified, CE, UKCA, TÜV-Bauart, VCCI, PSE, EAC

NOTE * When the USB devices are not connected.

SPECIFICATIONS : ProLite XU2793QSU-B6

Size Category		27"
LCD Panel	Panel technology	IPS Panel Technology
	Size	Diagonal: 27" (68.5cm)
	Pixel pitch	0.233mm H × 0.233mm V
	Brightness	250cd/m ² (Typical), 165cd/m ² (Default / Energy Saving)
	Contrast ratio	1300 : 1 (Typical), Adv. Contrast Function Available
	Viewable angle	Right / Left : 89 degrees each, Up / Down : 89 degrees each (Typical)
	MPRT	1ms
Display Colors		Approx. 16.7M
Sync Frequency		HDMI(Adaptive Sync: Off): Horizontal: 30.0-151.0kHz, Vertical: 55-100Hz HDMI(Adaptive Sync: On): Horizontal: 30.0-151.0kHz, Vertical: 48-100Hz DisplayPort(Adaptive Sync: Off): Horizontal: 30.0-151.0kHz, Vertical: 55-100Hz DisplayPort(Adaptive Sync: On): Horizontal: 151.0kHz, Vertical: 48-100Hz
Native Resolution		2560 × 1440, 3.7 MegaPixels
Support max. resolution		HDMI(Adaptive Sync: Off): 2560 × 1440, 100Hz HDMI(Adaptive Sync: On): 2560 × 1440, 100Hz DisplayPort(Adaptive Sync: Off): 2560 × 1440, 100Hz DisplayPort(Adaptive Sync: On): 2560 × 1440, 100Hz
Input Connector		HDMI, DisplayPort
Input Video Signal		HDMI, DisplayPort
USB Standard		USB3.2 Gen1 (5Gbps, DC5V, 900mA)
Number of USB Ports		1 Upstream : Series B
Connector shape		2 Downstream : Series A
Headphone Connector		ø 3.5mm mini jack (Stereo)
Speakers		2W × 2 (Stereo speakers)
Maximum Screen Size		596.7mm W × 335.7mm H / 23.49" W × 12.22" H
Power Source		100-240VAC, 50/60Hz, 1.5A
Power Consumption *		22W typical Standby mode: 0.5W maximum, Off mode: 0.3W maximum
Dimensions / Net Weight		613.5 × 435.0 × 189.0mm / 24.1 × 17.1 × 7.4" (W×H×D) 4.2kg / 9.26lbs
Tilt Angle		Upward: 22 degrees Downward: 4 degrees
Environmental Considerations		Operating: Temperature 5 to 35°C / 41 to 95°F Humidity 10 to 80% (No condensation) Storage: Temperature -20 to 60°C / -4 to 140°F Humidity 10 to 90% (No condensation)
EPEAT Bronze		Registration varies by country, go to www.epeat.net for details
Approvals		TCO Certified, CE, UKCA, TÜV-Bauart, VCCI, PSE, EAC

NOTE * When the USB devices are not connected.

DIMENSIONS : ProLite XUB2293HSU

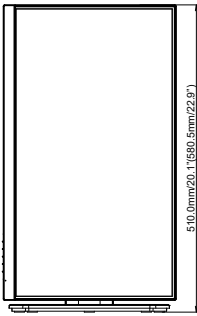
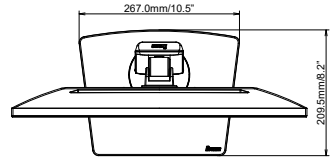
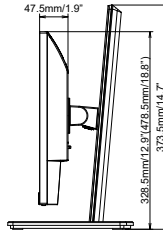
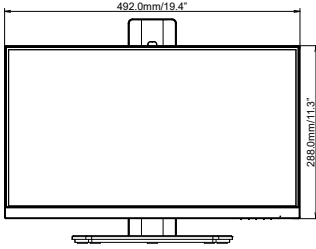

() : Maximum adjustment range

DIMENSIONS : ProLite XU2293HSU

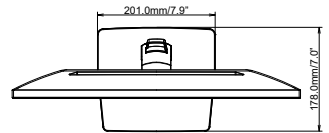
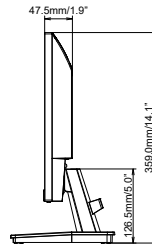
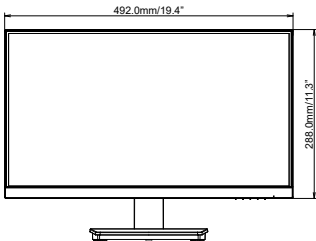

DIMENSIONS : ProLite XUB2493HSU

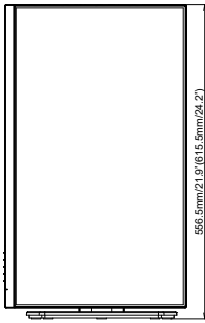
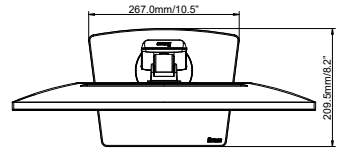
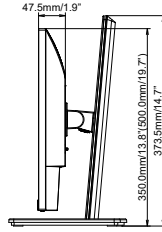
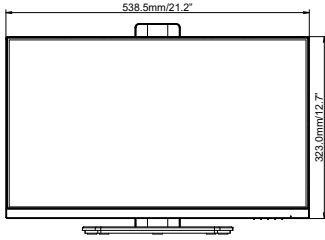

() : Maximum adjustment range

DIMENSIONS : ProLite XU2493HSU

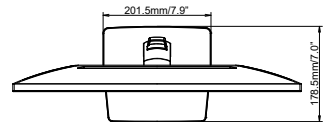
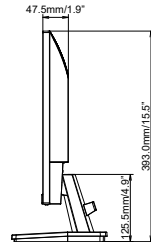
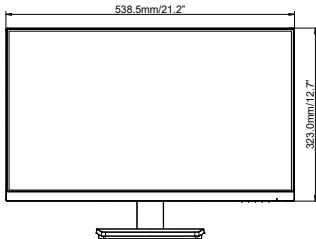

DIMENSIONS : ProLite XUB2793HSU / ProLite XUB2793HS

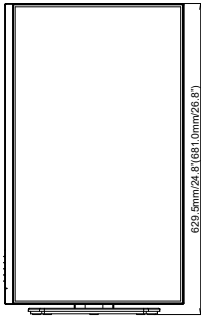
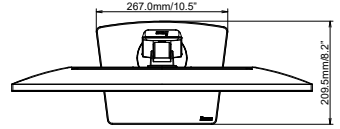
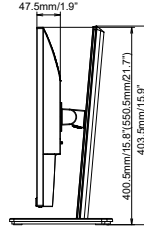
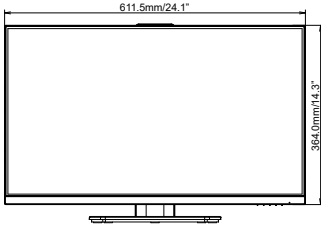

() : Maximum adjustment range

DIMENSIONS : ProLite XU2793HSU / ProLite XU2793HS

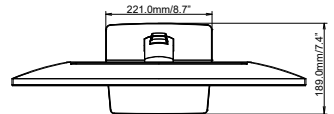
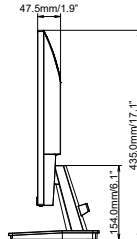
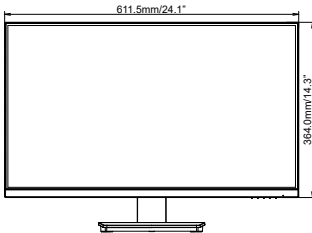

DIMENSIONS : ProLite XUB2793QU

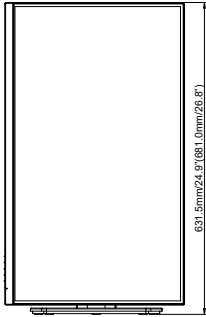
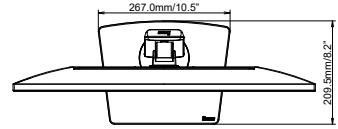
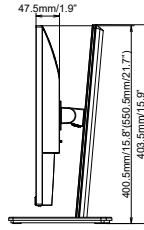
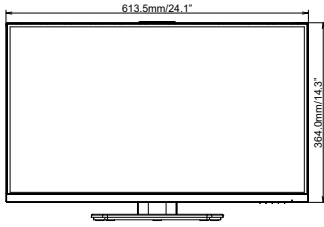

(): Maximum adjustment range

DIMENSIONS : ProLite XU2793QU

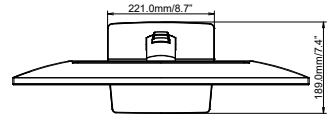
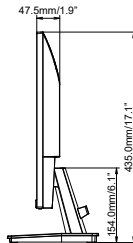
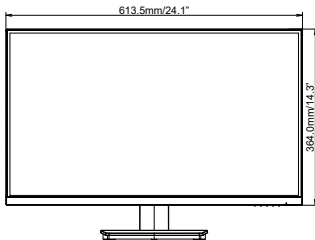

COMPLIANT TIMING

Video Mode	Horizontal Frequency	Vertical Frequency	Dot Clock
800 × 600	37.879kHz	60.317Hz	40.000MHz
	46.875kHz	75.000Hz	49.500MHz
1024 × 768	48.363kHz	60.004Hz	65.000MHz
	60.023kHz	75.029Hz	78.750MHz
1280 × 1024	79.980kHz	75.020Hz	135.000MHz
1680 × 1050	65.290kHz	60.000Hz	146.250MHz
1920 × 1080	67.500kHz	60.000Hz	148.500MHz
	83.890kHz	74.970Hz	174.500MHz
	95.430kHz	84.910Hz	198.500MHz
	110.000kHz	100.000Hz	228.800MHz
2560 × 1440	89.520kHz	59.961Hz	312.250MHz
	111.788kHz	74.925Hz	298.470MHz
	150.849kHz	99.900Hz	398.242MHz
	150.918kHz	99.900Hz	410.500MHz

NOTE *1 Only available for ProLite XUB2293HSU, XU2293HSU, XUB2493HSU, XU2493HSU, XUB2793HSU, XU2793HSU, XUB2793HS, XU2793HS.

*2 Only available for ProLite XUB2793QSU, XU2793QSU.