

Installation Guide

Omada Stackable L3 Managed Switch

About this Installation Guide

This Installation Guide describes the hardware characteristics, installation methods and the points that should be attended to during the installation. This Installation Guide is structured as follows:

Chapter 1 Introduction

This chapter describes the external components of the switch.

Chapter 2 Installation

This chapter illustrates how to install the switch.

Chapter 3 Connection

This chapter illustrates how to do the physical connection of the switch.

Chapter 4 Configuration

This chapter illustrates how to configure the switch.

Appendix A Troubleshooting

Appendix B Hardware Specifications

Audience



This Installation Guide is for:

Network Engineer

Network Administrator

Conventions

- Some models featured in this guide may be unavailable in your country or region. For local sales information, visit <https://www.tp-link.com>.
- The figures in Chapter 2, Chapter 3, and Chapter 4 are for demonstration purposes only. Your switch may differ in appearance from that depicted.
- PoE budget calculations are based on laboratory testing. Actual PoE power budget is not guaranteed and will vary as a result of client limitations and environmental factors.
- This guide uses the specific formats to highlight special messages. The following table lists the notice icons that are used throughout this guide.

	Remind to be careful. A caution indicates a potential which may result in device damage.
	Remind to take notice. The note contains the helpful information for a better use of the product.

Related Document

The User Guide and CLI Reference Guide of the product are provided on Download Center. To obtain the latest product information, visit the official website: <https://www.tp-link.com>.

Contents

Chapter 1	Introduction	01
1.1	Product Overview	01
1.2	Appearance	01
Chapter 2	Installation	09
2.1	Package Contents	09
2.2	Safety Precautions	09
2.3	Installation Tools	11
2.4	Product Installation	12
Chapter 3	Connection	19
3.1	Ethernet Port	19
3.2	SFP+/SFP28 Slot	19
3.3	Console Port	19
3.4	Verify Installation	20
3.5	Power On	21
3.6	Initialization	21
3.7	Stack Topology	21
Chapter 4	Configuration	24
4.1	Configuration Overview	24
4.2	Standalone Mode	24
4.3	Controller Mode	25
Appendix A	Troubleshooting	28
Appendix B	Specifications	29

Chapter 1 Introduction

1.1 Product Overview

Designed for workgroups and departments, TP-Link Omada Stackable L3 Managed Switch provides wire-speed performance and abundant L2 and L3 management features. It provides a variety of service features and multiple powerful functions with high security.

The EIA-standardized framework and smart configuration capacity can provide flexible solutions for a variable scale of networks. Static Routing, RIP, OSPF, and ECMP come with abundant Layer 3 routing protocols that support a scalable network. Physically stacking for built-in redundancy and performance. Redundant power supplies and fans make it an ideal choice for reliable networking architecture. VRRP allows a group of switches to dynamically back up each other. ERPS supports rapid protection and recovery in a ring topology. ACL, 802.1x and Dynamic ARP Inspection provide robust security strategies. QoS and IGMP snooping/filtering optimize voice and video application. Link aggregation (LACP) increases aggregated bandwidth, optimizing the transport of business critical data. SNMP, RMON, WEB and CLI Log-in bring abundant management policies. TP-Link Omada Stackable L3 Managed Switch integrates multiple functions with excellent performance, and is friendly to manage, which can fully meet the need of the users demanding higher networking performance.

SG6428XHP/SG6654XHP is also a Power Sourcing Equipment (PSE*). The RJ45 ports that support Power over Ethernet (PoE*) function can automatically detect and supply power to those powered devices (PDs*) complying with IEEE 802.3af and IEEE 802.3at.

*PSE: a device (switch or hub for instance) that provides power through an Ethernet cable.

*PoE: This technology describes a system to transmit electrical power, along with data, to remote devices over standard twisted-pair cable in an Ethernet.

*PD: a device powered by a PSE and thus consumes energy. Examples include powering network cameras, wireless LAN access points, IP telephones, network hubs, embedded computers etc.

1.2 Appearance

- **Front Panel** (The figures are for demonstration only. They may differ from your actual products.)

The front panel of SG6428X is shown as the following figure.

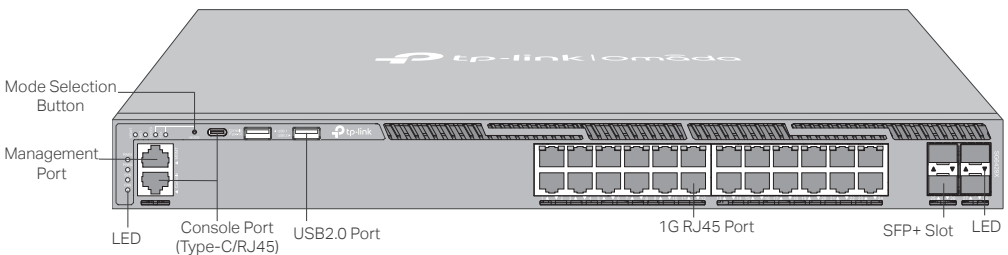

The front panel of SG6428XHP is shown as the following figure.

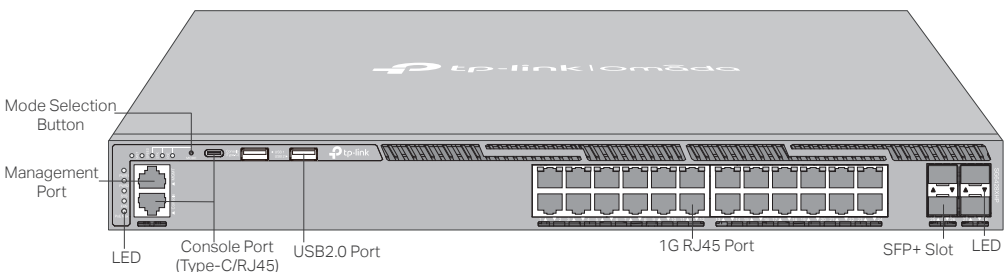

Omada Stackable L3 Managed Switch

The front panel of SG6654X is shown as the following figure.

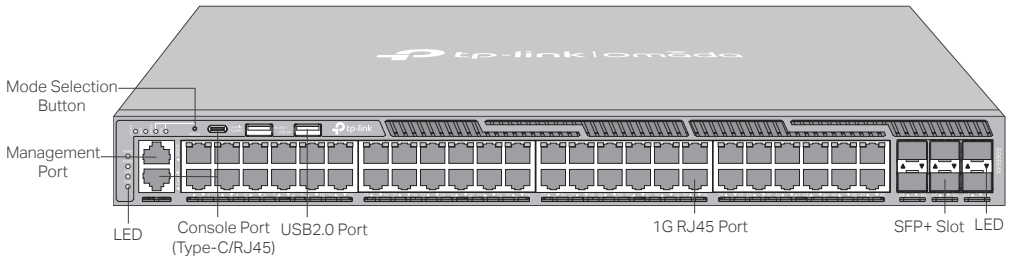

The front panel of SG6654XHP is shown as the following figure.

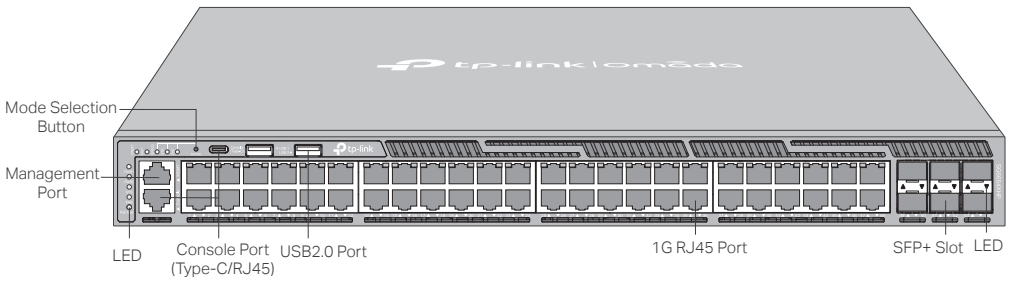

The front panel of SX6632YF is shown as the following figure.

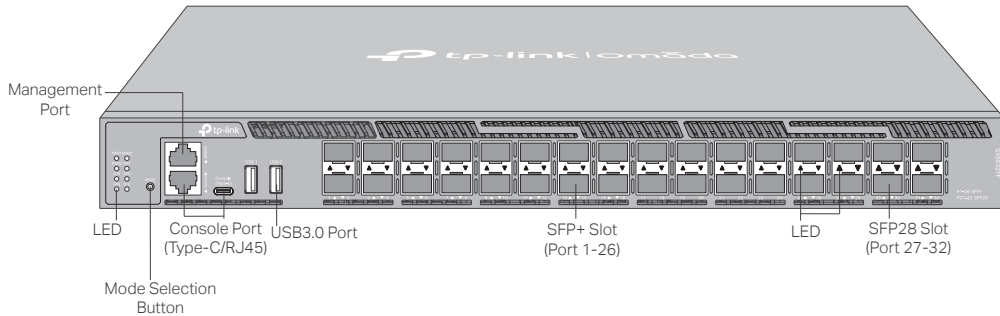

LEDs

For SG6428X and SG6654X

PWR1*	PWR2	Indication
Green On	Off	The switch is powered by PWR1. PWR2 is disconnected or it works improperly.
Green On	Yellow On**	The switch is powered by PWR1. PWR1 and PWR2 are connected.*
Off	Green On	The switch is powered by PWR2. PWR1 is disconnected or it works improperly.
Off	Off	The switch is powered off or both PWR1 and PWR2 work improperly.

LED	Indication
SYS	Flashing: The switch works properly. On or Off: The switch works improperly.
FAN	Green On: All the fans work properly. Yellow On: Not all the fans work properly.
MGMT	On: A device is linked to the port. Flashing: Transmitting or receiving data. Off: No device is linked to the port.
MST	On: The device functions as the master switch in the stack topology or it works individually. Off: The device functions as the member switch in the stack topology.
Port 1-24 of SG6428X/ Port 1-48 of SG6654X (When the SPEED LED is on)	Green On: Running at 1000 Mbps, but no activity. Green Flashing: Running at 1000 Mbps and transmitting or receiving data. Yellow On: Running at 10Mbps/100 Mbps, but no activity. Yellow Flashing: Running at 10Mbps/100 Mbps and transmitting or receiving data. Off: No device is linked to the corresponding port.
Port 1-24 of SG6428X/ Port 1-48 of SG6654X (When the STK LED is on)	On: The port number indicates the unit ID in the stack topology.
Port 25-28 of SG6428X/ Port 49-54 of SG6654X***	Green On: Running at 10 Gbps, but no activity. Green Flashing: Running at 10 Gbps and transmitting or receiving data. Yellow On: Running at 1 Gbps, but no activity. Yellow Flashing: Running at 1 Gbps and transmitting or receiving data. Off: No device is linked to the corresponding port.

*PWR1 is the primary power supply and it takes priority over PWR2.

**When both PWR1 and PWR2 work properly and the switch is power by PWR1, it takes 10-20 seconds for the LED PWR2 (yellow) to go out after PWR2 is unplugged.

***All 10 Gbps SFP+ slots can be used as uplink ports or stack ports.

For SG6428XHP and SG6654XHP

LED	Indication
PWR1* PWR2	<p>Green On: The power supply works properly.</p> <p>Green Flashing: The power supply module is not compatible with the switch.</p> <p>Yellow On: The power supply works properly but the switch is powered by the other power supply.**</p> <p>Yellow Flashing: The power supply module is plugged in properly but there's is no AC power input; abnormal power supply.</p> <p>Off: No power supply module is inserted.</p>
SYS	<p>Flashing: The switch works properly.</p> <p>On or Off: The switch works improperly.</p>
FAN	<p>Green On: All the fans work properly.</p> <p>Yellow On: Not all the fans work properly.</p>
PoE MAX	<p>On: The remaining PoE power is ≤ 7 W.</p> <p>Flashing: The remaining PoE power keeps ≤ 7 W after this LED is on for 2 minutes.</p> <p>Off: The remaining PoE power is > 7 W.</p>
MGMT	<p>On: A device is linked to the port.</p> <p>Flashing: Transmitting or receiving data.</p> <p>Off: No device is linked to the port.</p>
MST	<p>On: The device functions as the master switch in the stack topology or it works individually.</p> <p>Off: The device functions as the member switch in the stack topology.</p>
Port 1-24 of SG6428XHP/ Port 1-48 of SG6654XHP (When the SPEED LED is on)	<p>Green On: Running at 1000 Mbps, but no activity.</p> <p>Green Flashing: Running at 1000 Mbps and transmitting or receiving data.</p> <p>Yellow On: Running at 10Mbps/100 Mbps, but no activity.</p> <p>Yellow Flashing: Running at 10Mbps/100 Mbps and transmitting or receiving data.</p> <p>Off: No device is linked to the corresponding port.</p>
Port 1-24 of SG6428XHP/ Port 1-48 of SG6654XHP (When the STK LED is on)	<p>On: The port number indicates the unit ID in the stack topology.</p>
Port 1-24 of SG6428XHP/ Port 1-48 of SG6654XHP (When the PoE LED is on)	<p>Green On: The port is supplying power normally.</p> <p>Green Flashing: The supply power exceeds the corresponding port's maximum power.</p> <p>Yellow On: Overload or short circuit is detected.</p> <p>Yellow Flashing: Power-on self-test failed.</p> <p>Off: Not providing PoE power on the port</p>
Port 25-28 of SG6428XHP/ Port 49-54 of SG6654XHP***	<p>Green On: Running at 10 Gbps, but no activity.</p> <p>Green Flashing: Running at 10 Gbps and transmitting or receiving data.</p> <p>Yellow On: Running at 1 Gbps, but no activity.</p> <p>Yellow Flashing: Running at 1 Gbps and transmitting or receiving data.</p> <p>Off: No device is linked to the corresponding port.</p>

*By default, SG6428XHP is shipped with a PSM500-AC power supply module, and SG6654XHP is shipped with a PSM900-AC power supply module. One more power supply module needs to be purchased separately.

**Both PWR 1 and PWR2 can work simultaneously, or you can specify the primary power supply and the backup power supply according to your needs. Generally the primary power supply takes priority over the backup power supply.

***All 10 Gbps SFP+ slots can be used as uplink ports or stack ports.

For SX6632YF

LED	Indication
PWR1* PWR2	<p>Green On: The power supply works properly.</p> <p>Green Flashing: The power supply module is not compatible with the switch.</p> <p>Yellow On: The power supply works properly but the switch is powered by the other power supply.**</p> <p>Yellow Flashing: The power supply module is plugged in properly but there's is no AC power input; abnormal power supply.</p> <p>Off: No power supply module is inserted.</p>
SYS	<p>Flashing: The switch works properly.</p> <p>On or Off: The switch works improperly.</p>
FAN	<p>Green: All the fans work properly.</p> <p>Yellow: Not all the fans work properly.</p>
MGMT	<p>On: A device is linked to the port.</p> <p>Flashing: Transmitting or receiving data.</p> <p>Off: No device is linked to the port.</p>
MST	<p>On: The device functions as the master switch in the stack topology or it works individually.</p> <p>Off: The device functions as the member switch in the stack topology.</p>
Port 1-26 (When the SPD LED is on)	<p>Green On: Running at 10 Gbps, but no activity.</p> <p>Green Flashing: Running at 10 Gbps and transmitting or receiving data.</p> <p>Yellow On: Running at 1 Gbps, but no activity.</p> <p>Yellow Flashing: Running at 1 Gbps and transmitting or receiving data.</p> <p>Off: No device is linked to the corresponding port.</p>
Port 27-32*** (When the SPD LED is on)	<p>Green On: Running at 25 Gbps, but no activity.</p> <p>Green Flashing: Running at 25 Gbps and transmitting or receiving data.</p> <p>Yellow On: Running at 10 Gbps/1 Gbps, but no activity.</p> <p>Yellow Flashing: Running at 10 Gbps/1 Gbps and transmitting or receiving data.</p> <p>Off: No device is linked to the corresponding port.</p>
Port 1-32 (When the STK LED is on)	<p>On: The port number indicates the unit ID in the stack topology.</p>

*By default, SX6632YF is shipped with a PSM550-AC power supply module installed respectively. One more power supply module needs to be purchased separately.

**PWR1 is the primary power supply and it takes priority over PWR2.

***All 25 Gbps SFP28 slots can be used as uplink ports or stack ports.

Management Port

Designed to connect the device for management through web, CLI or SNMP.

Console Port

Designed to connect with a computer for monitoring and configuring the switch. When the switch has an RJ45 console port and a Type-C console port, console input is active on only one console port at a time. By default, the Type-C connector takes priority over the RJ45 connector, or you can change the priority through the web.

USB Port

Designed to install the USB flash disk for data storage.

10/100/1000 Mbps RJ45 Port

Designed to connect to the device with a bandwidth of 10Mbps, 100 Mbps or 1000 Mbps. For PoE switches, the port can also provide power for PDs.

SFP+ Slot

Designed to install the 10 Gbps/1 Gbps optical module.

SFP28 Slot

Designed to install the 25 Gbps/10 Gbps/1 Gbps optical module.

Port Feature

Model	10/100/1000 Mbps RJ45 Port	SFP+ Slot	SFP28 Slot	Management Port	Console Port	USB Port
SG6428X	24	4	/	1	2	2
SG6428XHP	24	4	/	1	2	2
SG6654X	48	6	/	1	2	2
SG6654XHP	48	6	/	1	2	2
SX6632YF	/	26	6	1	2	2

▪ **Rear Panel**

The rear panel of SG6428X/SG6654X is shown as the following figure. The figure is for demonstration purposes only. Your switch may differ in appearance from the depicted.

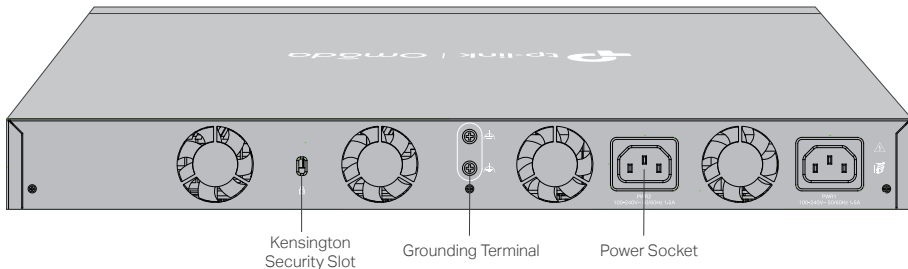

Note:

PWR1 is the primary power supply and it takes priority over PWR2.

The rear panel of SG6428XHP/SG6654XHP is shown as the following figure. The figure is for demonstration purposes only. Your switch may differ in appearance from the depicted.

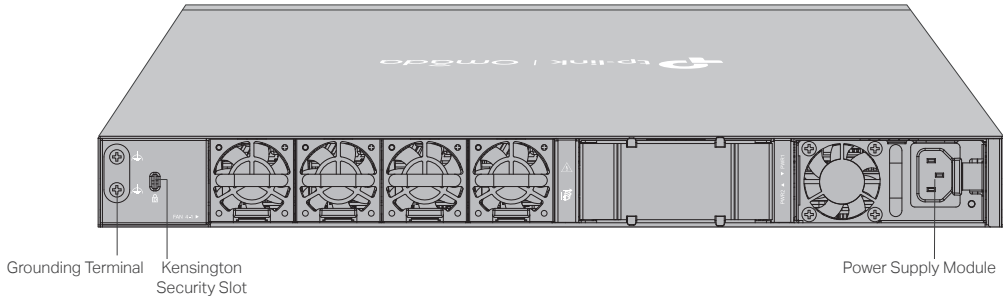

Note:

By default, SG6428XHP is shipped with a PSM500-AC power supply module, and SG6654XHP is shipped with a PSM900-AC power supply module. One more power supply module needs to be purchased separately. Both PWR 1 and PWR2 can work simultaneously, or you can specify the primary power supply and the backup power supply according to your needs. Normally the primary power supply takes priority over the backup power supply.

The rear panel of SX6632YF is shown as the following figure. The figure is for demonstration purposes only. Your switch may differ in appearance from the depicted.

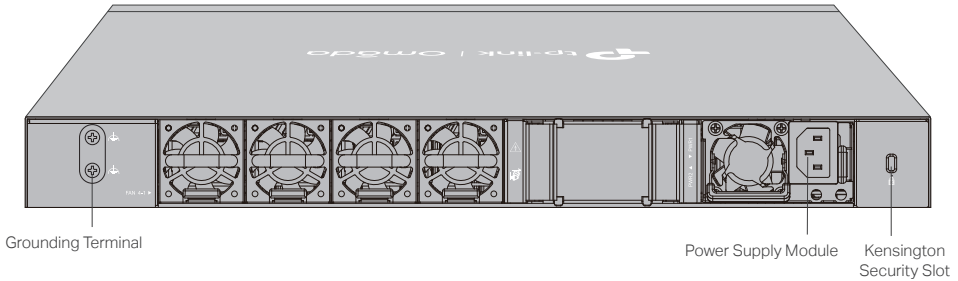

Note:

By default, SX6632YF is shipped with a PSM550-AC power supply module installed. One more power supply module needs to be purchased separately. When the switch has two power supply modules installed, PWR1 is the primary power supply and it takes priority over PWR2.

Kensington Security Slot

Secure the lock (not provided) into the security slot to prevent the device from being stolen.

Grounding Terminal

The switch already comes with lightning protection mechanism. You can also ground the switch through the PE (Protecting Earth) cable of AC cord or with Ground Cable. For detailed lightning protection measures, go to <https://www.tp-link.com/support>, search the model number of your switch and go to the product Support web page, refer to the **Lightning Protection Guide** from the Related Documents: https://www.tp-link.com/us/configuration-guides/lightning_protection_guide/.

Power Socket

Connect the female connector of the power cord here, and the male connector to the AC power outlet. Make sure that the voltage of the power supply meets the requirement of the input voltage (100–240 V~ 50/60 Hz).

Power Supply Module

The pluggable power supply module PSM500-AC/PSM900-AC/PSM550-AC is an AC-input power supply module. It can convert the input voltage to 53.5 V (12 V for PSM550-AC) with the maximum output power of 500 W/900 W/550 W respectively.



Caution:

PSM900-AC needs up to 12A AC input when the input voltage is 100-120V (included) and 10A AC input when the input voltage is 120 (not included)-240V, so please use the appropriate power cord according to the power supply voltage.

Chapter 2 Installation

2.1 Package Contents

Make sure that the package contains the following items. Please contact your distributor, if any of the listed items is damaged or missing. The figures are for demonstration only. The actual items may differ in appearance and quantity from the depicted.

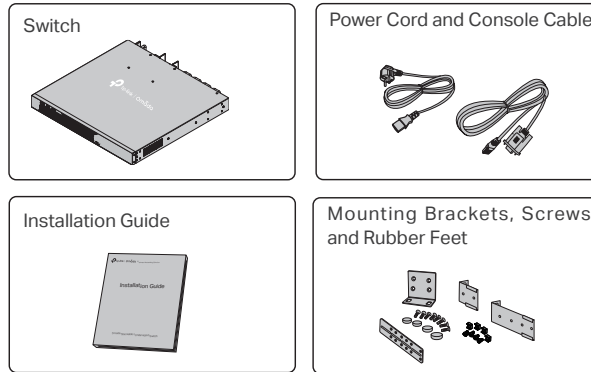

2.2 Safety Precautions

To avoid any device damage and bodily injury caused by improper use, you should observe the following rules.

■ Safety Precautions

- Keep the power off during the installation.
- Wear an ESD-preventive wrist strap, and make sure that the wrist strap has a good skin contact and is well grounded.
- Use only the power cord provided with the switch.
- Make sure that the supply voltage matches the specifications indicated on the rear panel of the switch.
- Ensure that the switch is installed in a well-ventilated environment and its ventilation hole is not blocked.
- Do not open or remove the cover of the switch.
- Before cleaning the device, cut off the power supply. Do not clean it by the waterish cloth, and never use any other liquid cleaning method.
- Place the device with its bottom surface facing downwards.
- Only trained and qualified personnel should be allowed to install, replace, or service this device.

■ Site Requirements

Temperature/Humidity



Omada Stackable L3 Managed Switch

Keep the equipment room at an appropriate level of temperature and humidity. Too much or too little humidity may lead to bad insulation, leakage of electricity, mechanical property changes, and corrosion. High temperatures may accelerate aging of the insulation materials, significantly shortening the service life of the device. To find out the best temperature and humidity conditions for the device, check the Appendix B Specifications.

Clearness

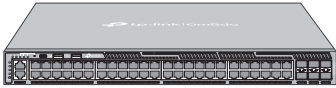

The dust accumulated on the switch can be absorbed by static electricity and result in poor contact of metal contact points. Some measures have been taken for the device to prevent static electricity, but too strong static electricity can cause deadly damage to the electronic elements on the internal circuit board. To avoid the effect of static electricity on the operation of the switch, attach much importance to the following items:

- Dust the device regularly, and keep the indoor air clean.
- Keep the device well grounded and ensure that the static electricity has been transferred.

Electromagnetic Interference

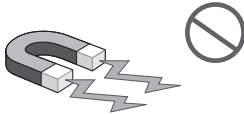

Electronic elements including capacitance and inductance on the device can be affected by external interferences, such as conducted emission by capacitance coupling, inductance coupling, and impedance coupling. To decrease the interferences, make sure to take the following measures:

- Use the power supply that can effectively filter interference from the power grid.
- Keep the device far from high-frequency and strong-current devices such as radio transmitting station.
- Use electromagnetic shielding when necessary.

Lightning Protection



Extremely high voltage currents can be produced instantly when lightning occurs and the air in the electric discharge path can be instantly heated up to 20,000 °C. As this instant current is strong enough to damage electronic devices, more effective lightning protection measures should be taken.

- Ensure that the rack and the device are well earthed.
- Make sure the power socket has a good contact with the ground.
- Keep a reasonable cabling system and avoid induced lightning.
- Use the signal SPD (Surge Protective Device) when wiring outdoor.



Note:

For detailed lightning protection measures, go to <https://www.tp-link.com/support>, search the model number of your switch and go to the product Support web page, refer to the **Lightning Protection Guide** from the Related Documents:
https://www.tp-link.com/us/configuration-guides/lightning_protection_guide/.

Installation Site

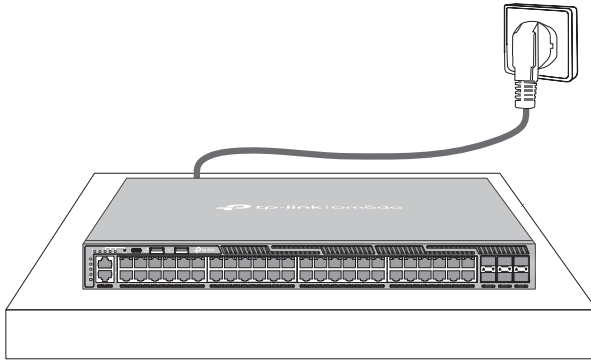

When installing the device on a rack or a flat workbench, attach much importance to the following items:

- Install the device with its bottom surface facing down only.
- This equipment is not suitable for use in locations where children are likely to be present.
- The rack or workbench is flat, stable, and sturdy enough to support the weight of 9.5 kg at least.
- The rack or workbench has a good ventilation system. The equipment room is well ventilated.
- The rack is well grounded. Keep the device less than 1.5 meters away from the power socket.

2.3 Installation Tools

- Phillips screwdriver
- ESD-preventive wrist wrap
- Cables



Note:

These tools are not included with our product. If needed, you can purchase them separately.

2.4 Product Installation

The switch is designed with front-to-back heat dissipation feature. When it works, the air circulates as shown below. For better heat dissipation, please install the device in a well-ventilated environment and leave 5 to 10 cm gaps around the device.

Figure 2-1 Air Circulation

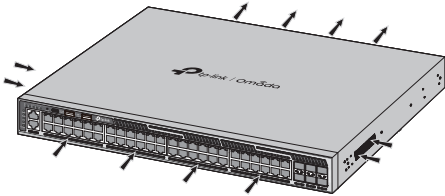

Desktop Installation

To install the device on the desktop, follow the steps:

1. Set the device on a flat surface which is strong enough to support the entire weight of the device with all fittings.
2. Remove the adhesive backing papers from the rubber feet.
3. Turnover the device and attach the supplied rubber feet to the recessed areas on the bottom at each corner of the device.

Figure 2-2 Desktop Installation

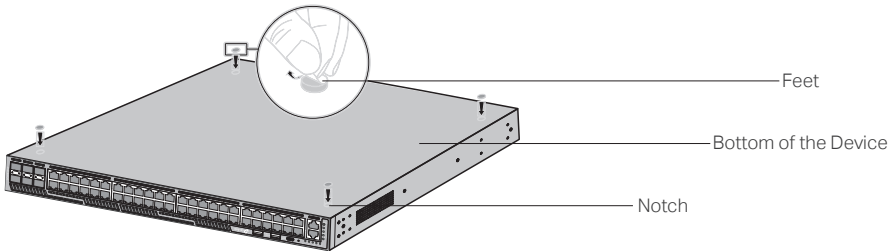

Rack Installation

The package includes 4 pairs of different rack-mounting brackets, their pictures are depicted below and may differ from the actual products.

Figure 2-3 Mounting Brackets

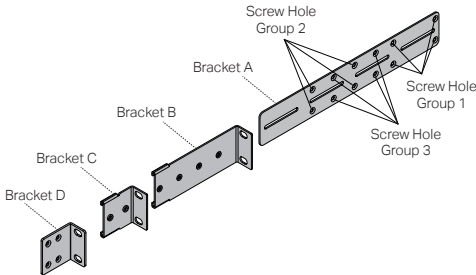

Before installing the device in an EIA standard-sized, 19-inch rack, please check the efficiency of the grounding system and the stability of the rack, then wear an ESD-preventive wrist strap, and make sure that it has good skin contact and is well grounded. Bracket B & C have two adjustable ears, please measure the distance between the front-post rack and the rear-post rack, and determine a suitable mounting method from below:

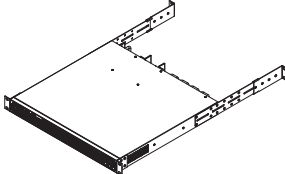
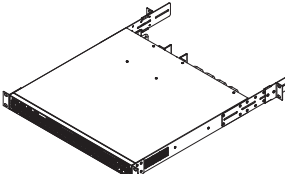
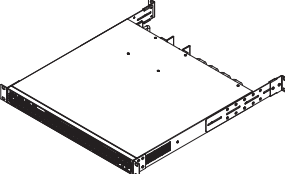
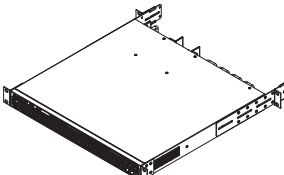
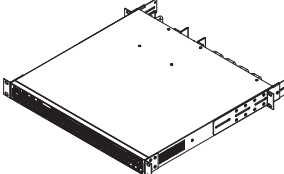
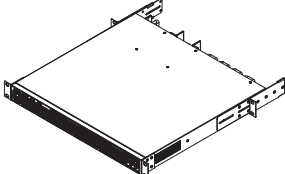
Method	Demonstration	Rack Distance (For device with a depth of 380mm)	Rack Distance (For device with a depth of 420mm)	Rack Distance (For device with a depth of 460mm)
Front: Bracket D Rear: Bracket A (Screw Hole Group 1) + Bracket B (Ear towards back)		498-640mm	538-680mm	578-720mm
Front: Bracket D Rear: Bracket A (Screw Hole Group 1) + Bracket C (Ear towards back)		477-498mm	517-538mm	557-578mm
Front: Bracket D Rear: Bracket A (Screw Hole Group 2) + Bracket C (Ear towards back)		429-477mm	469-517mm	509-557mm
Front: Bracket D Rear: Bracket A (Screw Hole Group 2) + Bracket C (Ear towards front)		410-429mm	450-469mm	490-509mm
Front: Bracket D Rear: Bracket A (Screw Hole Group 3) + Bracket C (Ear towards back)		357-410mm	397-450mm	437-490mm
Front: Bracket D Rear: Bracket A (Screw Hole Group 2) + Bracket B (Ear towards back)		282-410mm	322-450mm	362-490mm

Omada Stackable L3 Managed Switch

To install the device, follow the instructions described below:

1. Attach the M6 nuts to the racks.

Figure 2-4 Securing M6 Nuts

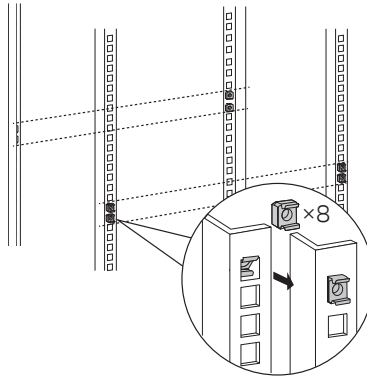

2. Attach the mounting brackets (B or C) to the rear-post racks and secure them with the provided M6 screws, as illustrated in the following figure.

Figure 2-5 Installing Brackets on Racks

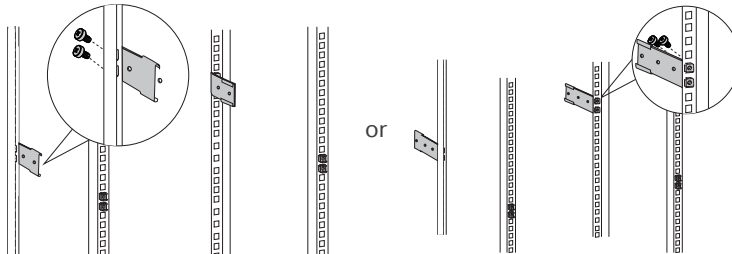

3. Attach the brackets A & D to the switch with the provided M3 screws.

Figure 2-6 Installing Brackets on Switch

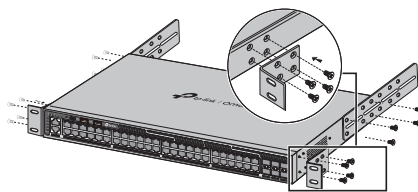

4. After the brackets are attached to the device, hold the switch with attached brackets up until it aligns with the brackets on the racks, and gently push the switch backwards until it is in place, then secure the device on the racks with M6 screws and fix brackets B/C to brackets A with M4 screws on both sides.

Figure 2-7 Installing Switch on Racks

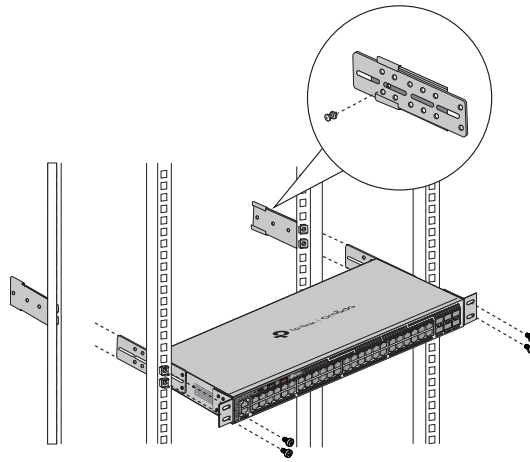
**Caution:**

- Leave 5 to 10 cm gaps around the devices for air circulation.
- Avoid placing heavy things on the device.
- Mount devices in the order demonstrated above and ensure a certain clearance between devices for the purpose of heat dissipation.

■ Power Supply Module Installation

SG6428XHP/SG6654XHP/SX6632YF shipped with a PSM500-AC/PSM900-AC/PSM550-AC power supply module installed. They look like below, and the images may differ from your actual product.

Figure 2-8 Appearance of the Power Supply Module

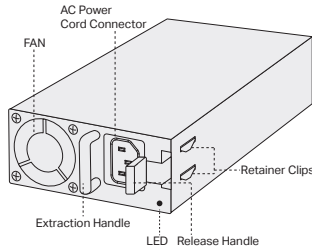

If you need to add one more power supply module, please follow the steps:

1. Wear an ESD-preventive wrist strap, and make sure that it has good skin contact and is well grounded.
2. Press the extraction handle of the module with one hand, and hold the bottom of the module using your other hand. Gently push the module in along the slot guide rail.
3. Release the extraction handle to fix the power supply module in place.

Figure 2-9 Installing the Power Supply Module

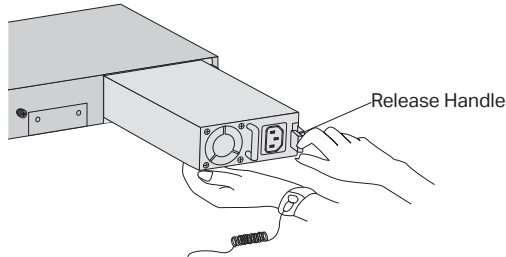

Caution:

- Do not plug the power cord until the power supply module installation is completed.
- When installing a power supply module, make sure it is set correctly in the operation of installation.
- Do not use too much force in the installation. If resistance is encountered or positions of the power supply module appear larger during installation, you must first remove the module and then reinstall the module.
- If the Retainer Clips cannot spring up naturally and the power module is blocked, it may be due to the power supply module is not installed properly. Please check carefully.

If you need to remove the power supply module, please follow the steps:

1. Wear an ESD-preventive wrist strap, and make sure that it has good skin contact and is well grounded.
2. Remove the power cord from the external power supply system and the power module.

- Press the extraction handle of the module with one hand, and pull the extraction handle using your other hand, until the module completely comes out of the chassis.



Caution:

- Unplug the power cord first, then remove the power supply module.
- Please check the total PoE power output before removing one module when dual modules are used. If the total PoE power output exceeds the PoE Budget of the remaining module, reduce the output first. For more information, see PoE Budget in Appendix B.
- When removing a power supply module, make sure that the power supply module is set correctly in the operation of installation.
- In order to better protect the power supply module during removal, it is recommended that you package it in an antistatic bag.

■ **Fan Module Installation**

SG6428XHP/SG6654XHP/SX6632YF is shipped with 4 hot-swappable fan modules installed. They look like below, and the images may differ from your actual product.

Figure 2-10 Appearance of the Fan Module

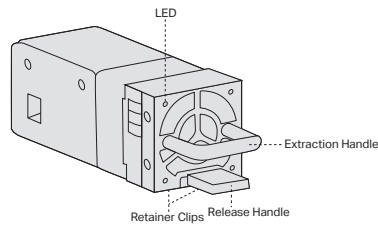

For normal operation of the switch, please make sure at least 3 fan modules are working normally at a time. If one fan module is damaged, please replace it as follows:

- Wear an ESD-preventive wrist strap, and make sure that it has good skin contact and is well grounded.
- Press the extraction handle of the module with one hand, and pull the extraction handle until the module completely comes out of the chassis.

Figure 2-11 Removing A Damaged Fan Module

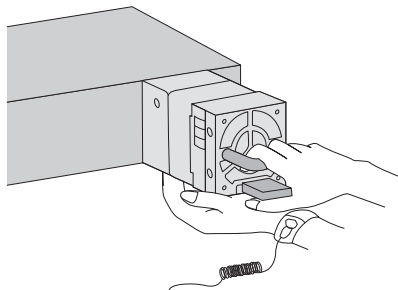

- Press the extraction handle of a new fan module with one hand, and hold the bottom of the module using your other hand. Gently push the module in along the slot guide rail.
- Release the extraction handle to fix the power supply module in place.



Caution:

- Sharp edges on the fan module may cause injury, so please operate with caution.
 - Make sure the damaged fan module is in place before you are going to replace it. DO NOT unplug the damaged fan module until the replacement operation.
 - Do not use too much force in the replacement. If resistance is encountered or positions of the fan module appear larger during installation, you must first remove the module and then reinstall the module.
 - If the Retainer Clips cannot spring up naturally and the power module is blocked, it may be due to the fan module is not installed properly. Please check carefully.
-

Chapter 3 Connection

3.1 Ethernet Port

Connect an Ethernet port of the switch to the computer by RJ45 cable as the following figure shows.

Figure 3-1 Connecting the RJ45 Port

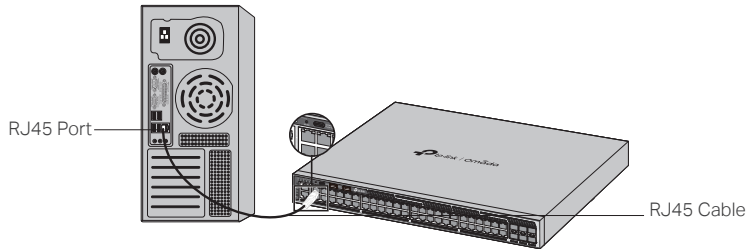

3.2 SFP+/SFP28 Slot

The following figure demonstrates the connection of SFP+/SFP28 slot to an optical module.

Figure 3-2 Inserting the SFP/SFP+ Module

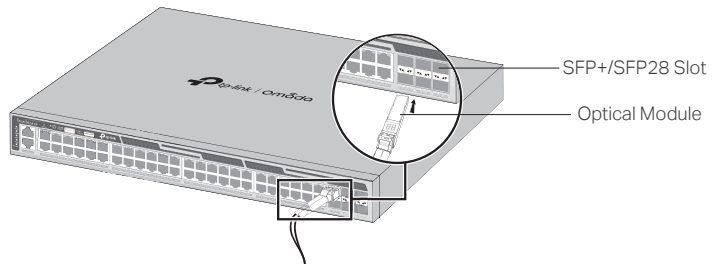

3.3 Console Port

CLI (Command Line Interface) enables you to manage the switch, thus you can load the CLI after connecting the PCs or Terminals to the console port on the switch via a cable (an RJ45 console cable is provided, while Type-C cable is not provided).

Connect the RJ45 console port of the device with your computer by the console cable as the following figure shows.

Figure 3-3 Connecting the Console (RJ45) Port

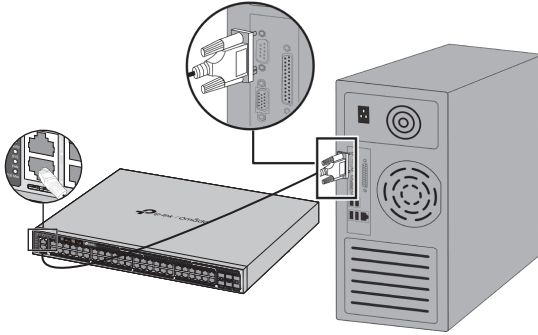

Connect the Type-C console port of the device with your computer by the Type-C cable (not provided) as the following figure shows.

Figure 3-4 Connecting the Console (USB) Port

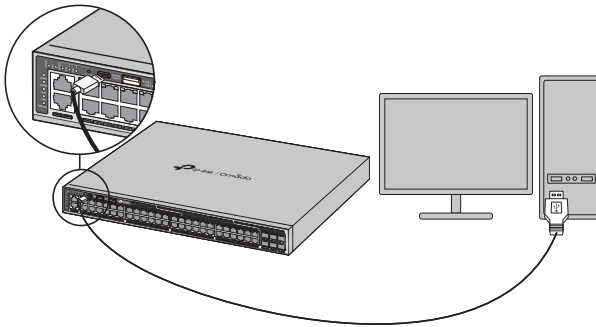

Note:

- RJ45 console port and Type-C console port cannot be used concurrently. Type-C Console port takes priority over the RJ45 console port.
- The Type-C console port is hot-pluggable while the RJ45 console port is not. Keep the device power off when plugging the console cable into the RJ45 console port.
- Do not connect the console port with other ports by RJ45 cable.

3.4 Verify Installation

After completing the installation, verify the following items:

- There should be 5 to 10 cm of clearance around the device for ventilation and make sure the air flow is adequate.
- The voltage of the power supply meets the requirement of the input voltage of the device.
- The power socket, device and rack are well grounded.
- The device is correctly connected to other network devices.

3.5 Power On

Plug the female connector of the provided power cord into the power socket of the device and plug the positive connector into a power outlet as the following figure shows. Make sure that the voltage of the power supply meets the requirement of the input voltage (100-240 V~ 50/60 Hz).

Figure 3-5 Connecting to Power Supply

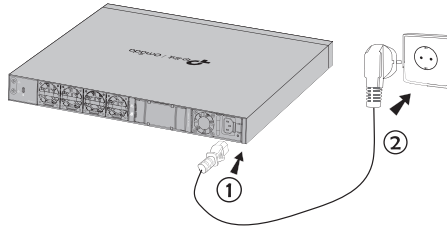

Note:

1. The figure is to illustrate the application and principle. The provided plug, socket and/or module in your region may differ from the figures above.
2. Generally PWR1 takes priority over PWR2.

3.6 Initialization

After the device is powered on, it begins the Power-On Self-Test. A series of tests run automatically to ensure the device functions properly. During this time, its LED indicators will respond in the following order:

1. The PWR LED indicator lights on all the time. The SYS LED and the LED indicators of all the ports keep off.
2. After about one minute, the SYS LED and LED indicators of all the ports will flash momentarily and then turn off.
3. Several seconds later, the SYS LED indicator will flash, which represents a successful initialization.

3.7 Stack Topology

With stackable design, the switches can be stacked into one stack topology for higher reliability, larger bandwidth, and simpler networking. To build the stack topology, you need to prepare 2-4 switches and enough SFP+/SFP28 modules/cables. For more details, see the table below:

Switch	Compatible Model(s)	Quantity
SG6428X	SG6428X, SG6654X	2-4
SG6654X	SG6428X, SG6654X	2-4
SG6428XHP	SG6428XHP, SG6654XHP	2-4
SG6654XHP	SG6428XHP, SG6654XHP	2-4
SX6632YF	SX6632YF	2-4

There are three stack topology structures for different scenarios, please build the proper topology according to your needs:

1. **Chain Topology:** Chain topology is relatively simple and does not require cable connection between the first and last unit. It is suitable for long-distance stacking, but its reliability is relatively low.

Figure 3-6 Chain Topology

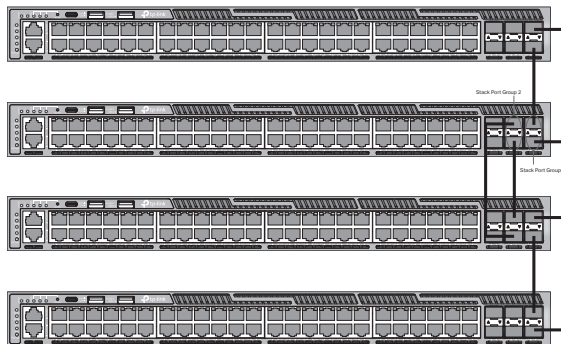

2. **Ring Topology:** Ring topology has higher reliability compared with the chain topology. When one of the chains in the ring topology is disconnected, the ring topology becomes a chain topology, but the entire stack system can still work normally. The ring topology requires cable connection between the first and last unit, so it's not suitable for long-distance stacking.

Figure 3-7 Ring Topology

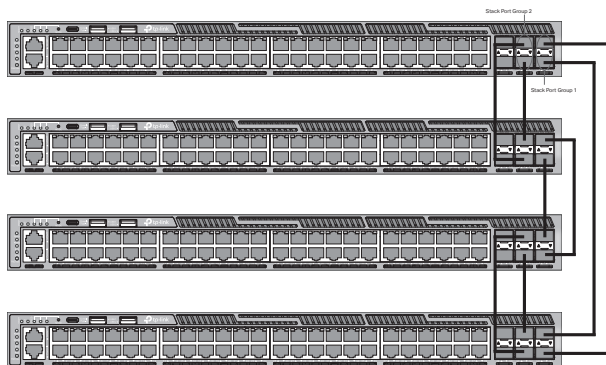

3. **Star Topology:** Star topology connects the switches to a central master switch, therefore, it can significantly increase the data forwarding rate between member switches while providing unified management.

Figure 3-8 Star Topology

**Note:**

- Stack port is not allowed to connect to non-stack port, as it may affect the operation of the device.
- Stack ports with the same group ID are not allowed to connect to stack ports with different group IDs.
- A stack port group is a logical port dedicated to stacking and needs to be bound to a stack port. A stack port group can be bound to one or more stack ports to improve bandwidth and reliability.

Chapter 4 Configuration

4.1 Configuration Overview

The switch supports two configuration options:

- Standalone Mode: Configure and manage the switch singly.
- Controller Mode: Configure and manage the network devices centrally. It is recommended in the large-scale network, which consists of mass devices such as access points, switches, and gateways.



Note:

When the switch is changed from Standalone Mode to Controller Mode, configurations of the switch will be lost. For details, refer to the related documents on the download center of our official website: <https://www.tp-link.com/support/download/>.

4.2 Standalone Mode

In Standalone Mode, use a computer to configure and manage the switch using GUI (Graphical User Interface) or CLI (command-line interface).

Figure 4-1 Topology for Standalone Mode

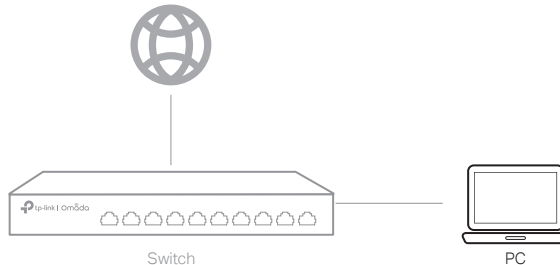

Using the GUI

1. To access the management page of the switch, make sure the switch and computer are in the same subnet. Open a browser and type the switch's IP address in the address field, then press the Enter key.
 - If the switch obtains IP address from the DHCP server (typically a router), find the switch's IP address on the DHCP server.
 - If not, use the default IP address 192.168.0.1 to launch the switch's management page.
2. Enter **admin** for both the username and password in the lower case letters to log in. The first time you log in, change the password to better protect your network and devices.
3. After a successful login, the main page will appear. You can click the menus on the top side and left side to configure the corresponding functions.

For the detailed configurations, refer to the User Guide and CLI Guide. The guides can be found on the download center of our official website: <https://www.tp-link.com/support/download/>.

Using the CLI

- Set up a Telnet or SSH connection to access the switch via CLI.

- Use the console port to access the switch. When using the console port, start the terminal emulation program (such as the Hyper Terminal) on the PC and configure the terminal emulation program as follows:

Baud Rate	Data Bits	Parity	Stop Bits	Flow Control
38400 bps	8	None	1	None

For the detailed configurations, refer to the **User Guide** and **CLI Guide**. The guides can be found on the download center of our official website: <https://www.tp-link.com/download-center.html>



Note:

For certain devices, you may need to change the password the first time you log in, which will better protect your network and devices.

4.3 Controller Mode

Controller Mode applies to the large scale network with mass devices. All devices can be centrally configured and monitored via Omada Hardware Controller or Omada Software Controller.



Note:

Before the following configurations, make sure the switch can access the internet. When using Omada Software/Hardware Controller, make sure the switch and the controller are in the same subnet. Typically, the switch obtains IP address from the DHCP server. You can check the switch's IP address on the DHCP server.

▪ Via Omada Hardware Controller

Omada Hardware Controller is a good alternative if you have no spare PC to keep running Omada Software Controller in the network. It needs to be purchased additionally. Follow the steps below to configure the Omada Hardware Controller.

Figure 4-2 Manage the network via Omada Hardware Controller

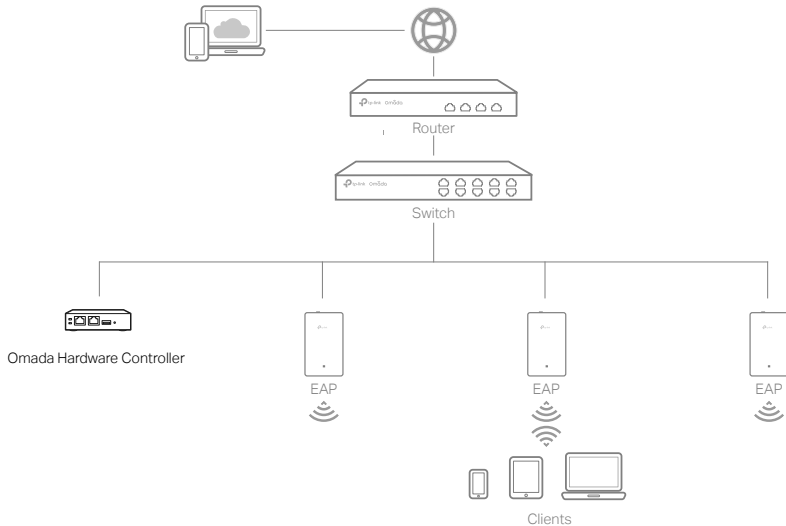



Note:

- Before you start, be sure to power up and connect your devices according to the topology figure.
 - A DHCP server (typically a router with DHCP function enabled) is required to assign IP addresses to the EAPs and clients in your local network.
 - Omada Controller must have network access to your Omada devices (the router, switch, or EAPs) in order to find, adopt, and manage them.
-

1. Find the IP address of the router. Open the command line on your PC and enter ipconfig. In the result list, find the Default Gateway, which is also the IP address of the router.
2. Launch a web browser and enter the IP address of the router. Log into the router's web page, and both the username and password are admin by default. Then go to **Network > LAN > DHCP Client List** to find the IP address of your controller according to its MAC address.
3. Enter the IP address of the your controller in the address bar to open its web page.
4. On the Omada Controller's web page, follow the wizard to complete the quick setup.
5. After the quick setup, the login page appears. Enter the username and password you have created and click **Log in**. Then you can further configure the controller.
6. If you want to manage the devices reomotely, follow the next steps:
 - a. Make sure that Cloud Access is enabled on your controller. By default, Cloud Access is enabled. Make sure that the Cloud LED is flashing slowly.
 - b. Launch a web browser and enter **<https://omada.tp-linkcloud.com>** in the address bar. Enter your TP-Link ID and password to log in. Click **+ Add Controller** and choose **Hardware Controller** to add your controller. Then you can further configure the controller.

For more details, refer to the Installation Guide of Omada Hardware Controller.

▪ **Via Omada Software Controller**

On a PC with Windows OS or Linux OS, download the Omada Software Controller from **<https://www.tp-link.com/support/download/omada-software-controller/>**. Then run the file and follow the wizard to install the Omada Software Controller. Follow the steps below to configure the Controller.

Figure 4-3 Manage the network via Omada Software Controller

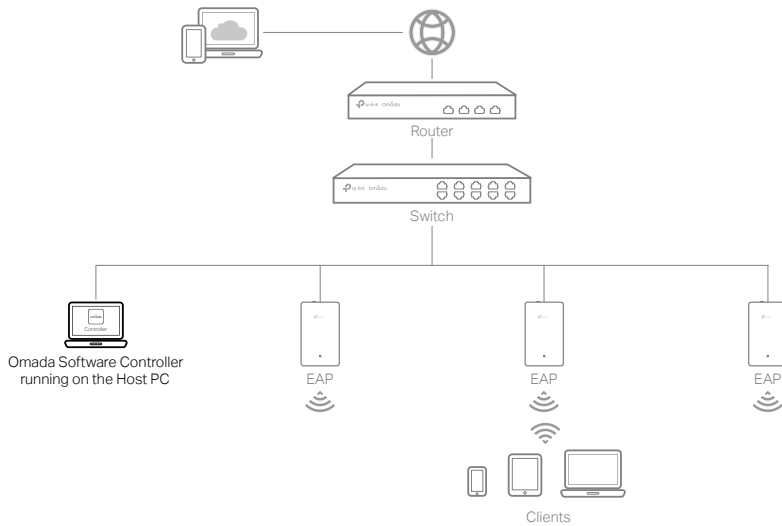

1. Launch the Omada Software Controller on your PC. After the initiation process, the controller automatically opens its web page. If not, click **Launch a Browser to Manage the Network**.
2. On the Omada Controller's web page, follow the wizard to complete the quick setup.
3. After the quick setup, the login page appears. Enter the username and password you have created and click **Log in**. Then you can further configure the controller.
4. If you want to manage the devices remotely, follow the next steps:
 - a. Make sure that Cloud Access is enabled on your controller and your controller has been bound with your TP-Link ID. On the Omada Controller's web page, go to **Settings > Cloud Access** to enable **Cloud Access** and bind your TP-Link ID. If you have set it up in the quick setup, skip this step.
 - b. Launch a web browser and enter **<https://omada.tplinkcloud.com>** in the address bar. Enter your TP-Link ID and password to log in. A list of controllers that have been bound with your TP-Link ID will appear. Then you can click **Launch** to further configure the controller.



Note:

- To manage your devices, Omada Software Controller needs to keep running on your computer.

*** Omada App**

With the Omada app, you can also manage your controller at a local site or a remote site via your mobile device.

For the detailed configurations, refer to the **User Guide** of the controller. The guide can be found on the download center of our official website: **<https://www.tp-link.com/support/download/>**.

Appendix A Troubleshooting

Q1. What could I do if I forgot the username and password of the switch?

1. Connect the console port of the PC to the console port of the switch and open a terminal emulation program.
2. Power off and restart the switch. Perform the action indicated by the terminal emulation program to reach the bootUtil menu. The action differs from product to product. Possible actions are listed below:
 - Press any key to stop autoboot.
 - Press CTRL-B to reach the bootUtil menu.
3. The bootUtil menu will be shown. Enter the number 6 to select the "Password recovery" option and enter Y to delete all the users and passwords. The default login username and password are both **admin**. The other configurations in the switch will not be changed.
4. For models without the password recover feature, select the "Reset" option to restore all the configurations to factory defaults. The default login username and password are both **admin**.

Q2. Why does the PWR LED work abnormally?

The PWR/Power LED should be lit up when the power system works normally. If the PWR/Power LED worked abnormally, take the following steps:

1. Make sure that the power cable is connected properly, and the power contact is normal.
2. Make sure the voltage of the power supply meets the requirement of the input voltage of the switch.

Q3. What should I do if I cannot access the web management page?

Try the following:

1. Check every port LED on the switch and make sure the Ethernet cable is connected properly.
2. Try another port on the switch and make sure the Ethernet cable is suitable and works normally.
3. Power off the switch and, after a while, power it on again.
4. Make sure the IP address of your PC is set within the subnet of the switch.
5. If you still cannot access the configuration page, reset the switch to its factory defaults. Then the IP address of your PC should be set as 192.168.0.x ("x" is any number from 2 to 254) and subnet mask as 255.255.255.0.

Q4. Why is the terminal emulation program not displaying correctly?

Try the following:

1. Make sure the power supply is normal and the console cable is properly connected.
2. Check if the console cable is the right type.
3. Ensure the parameters of the terminal emulation program are correct: configure Bits per second as 38400, Data bits as 8, Parity as None, Stop bits as 1, and Flow control as None.

Appendix B Specifications

Specifications for Switches with RJ45 Ports and SFP+ Slots

Item	Content
Standards	IEEE 802.3, IEEE 802.3i, IEEE 802.3u, IEEE 802.3ab, IEEE 802.3z, IEEE 802.3ae, IEEE 802.3x IEEE 802.3af/at (For SG6428XHP, SG6654XHP)
Transmission Medium	10BASE-T: 2-pair UTP/STP of Cat. 3,4,5 (maximum 100 m) 100BASE-TX: 2-pair UTP/STP of Cat. 5 or above (maximum 100 m) 1000BASE-T: 4-pair UTP/STP of Cat. 5e or above (maximum 100 m) 1000BASE-SX/LX/LX10/BX10: MMF, SMF 10GBASE-SR/LR: MMF, SMF 10GSFP+CU SFP+ Direct Attach Cable (SM5220-1M, SM5220-3M)
PoE Budget	For SG6428XHP: 402W (with 1*PSM500-AC, by default) 720W (with 1*PSM900-AC) 720W (with 2*PSM500-AC) 720W (with 2*PSM900-AC) 720W (with 1*PSM500-AC and 1*PSM900-AC) For SG6654XHP: 384W (with 1*PSM500-AC) 764W (with 1*PSM900-AC, by default) 812W (with 2*PSM500-AC) 1440W (with 2*PSM900-AC) 1176W (with 1*PSM500-AC and 1*PSM900-AC)
LED	SG6428X: PWR1, PWR2, SYS, FAN, MGMT, MST, SPEED, STK, Port 1-24, Port 25-28 SG6428XHP: PWR1, PWR2, SYS, FAN, PoE Max, MGMT, MST, SPEED, STK, PoE, Port 1-24, Port 25-28 SG6654X: PWR1, PWR2, SYS, FAN, MGMT, MST, SPEED, STK, Port 1-48, Port 49-54 SG6654XHP: PWR1, PWR2, SYS, FAN, PoE Max, MGMT, MST, SPEED, STK, PoE, Port 1-48, Port 49-54
Operating Altitude	For SG6428X/SG6654X: Sea level to 3000 m For SG6428XHP/SG6654XHP: Sea level to 2000 m ^Δ
Operating Temperature	For SG6428X/SG6654X: 0 °C to 45 °C/32 °F to 113 °F For SG6428XHP/SG6654XHP: 0 °C to 40 °C/32 °F to 104 °F ^Δ
Storage Temperature	-40 °C to 70 °C (-40 °F to 158 °F)

Operating Humidity	10% to 90% RH Non-condensing
--------------------	------------------------------

Storage Humidity	5% to 90% RH Non-condensing
------------------	-----------------------------

^Δ The supported altitude is sea level to 3000 m. It should be noted that when the altitude is above 2000 m, for every 220 meters of altitude increase, the maximum operating temperature will drop by 1°C (1.8°F).

Specifications for Switches with Full SFP+ and SFP28 Slots (SX6632YF)

Item	Content
Standards	IEEE 802.3, IEEE 802.3z, IEEE 802.3ae, IEEE 802.3x, IEEE 802.3by, IEEE 802.3cc
Transmission Medium	1000BASE-SX/LX/LX10/BX10: MMF, SMF 10GBASE-SR/LR: MMF, SMF 10GSFP+CU SFP+ Direct Attach Cable (SM5220-1M, SM5220-3M) 25GBASE-SR/LR: MMF, SMF SFP28 Direct Attach Cable
LED	PWR1, PWR2, SYS, FAN, MGMT, MST, SPD, STK, SFP+, SFP28
Operating Altitude	Sea level to 2000 m ^Δ
Operating Temperature	0 °C to 45 °C/32 °F to 113 °F ^Δ
Storage Temperature	-40 °C to 70 °C (-40 °F to 158 °F)
Operating Humidity	10% to 90% RH Non-condensing
Storage Humidity	5% to 90% RH Non-condensing

^Δ The supported altitude is sea level to 5000 m. It should be noted that when the altitude is above 2000 m, for every 220 meters of altitude increase, the maximum operating temperature will drop by 1°C (1.8°F).

Specifications for Power Supply Modules

	PSM500-AC (For SG6428XHP & SG6654XHP)	PSM900-AC (For SG6428XHP & SG6654XHP)	PSM550-AC (For SX6632YF)
Power Input	100 V–240 V~ 50/60 Hz 8A	100-120V (included)~ 50/60Hz 12A (for locations using low voltage, see specifications for specific countries/ regions) 120 (not included)- 240V~ 50/60Hz 10A (for other locations)	100 V–240 V~ 50/60 Hz 7A
Output Voltage	Primary: 53.5 VDC Standby: 12 VDC	Primary: 53.5 VDC Standby: 12 VDC	Primary: 12 VDC Standby: 12 VDC
Output Current	9.35 A (Maximum)	16.5 A (Maximum)	45 A (Maximum)
Output Power	500 W (Maximum)	900 W (Maximum)	550 W (Maximum)
Operating Altitude	For PSM500-AC/PSM900-AC: Sea level to 3000 m For PSM550-AC: Sea level to 5000 m		

CE Mark Warning



This is a class A product. In a domestic environment, this product may cause radio interference, in which case the user may be required to take adequate measures.

EU Declaration of Conformity

TP-Link hereby declares that the device is in compliance with the essential requirements and other relevant provisions of directives 2014/30/EU, 2014/35/EU, 2011/65/EU and (EU)2015/863.

The original EU Declaration of Conformity may be found at <https://www.tp-link.com/en/support/ce/>



UK Declaration of Conformity

TP-Link hereby declares that the device is in compliance with the essential requirements and other relevant provisions of the Electromagnetic Compatibility Regulations 2016 and Electrical Equipment (Safety) Regulations 2016.

The original UK Declaration of Conformity may be found at <https://www.tp-link.com/support/ukca/>



Продукт сертифіковано згідно с правилами системи УкрСЕПРО на відповідність вимогам нормативних документів та вимогам, що передбачені чинними законодавчими актами України.

CAUTION:



Double pole, neutral fusing.
Disconnect mains before servicing.

Safety Information

- Keep the device away from water, fire, humidity or hot environments.
- Do not attempt to disassemble, repair, or modify the device. If you need service, please contact us.
- Place the device with its bottom surface downward.
- The plug on the power supply cord is used as the disconnect device, the socket-outlet shall be easily accessible.
- Plug the product into the wall outlets with earthing connection through the power supply cord

or plug.

- The socket-outlet shall be installed near the equipment and shall be easily accessible.

This equipment is not suitable for use in locations
where children are likely to be present.

Please read and follow the above safety information when operating the device. We cannot guarantee that no accidents or damage will occur due to improper use of the device. Please use this product with care and operate at your own risk.



To ask questions, find answers, and communicate with TP-Link users or engineers, please visit <https://community.tp-link.com> to join TP-Link Community.



For technical support, the user guide and other information, please visit <https://www.tp-link.com/support>, or simply scan the QR code.

