

Dell UltraSharp 24 Monitor - U2424H

Dell UltraSharp 24 Monitor - U2424H, without stand

Dell UltraSharp 24 USB-C[®] Hub Monitor - U2424HE

User's Guide

Model: U2424H/U2424H WOST/U2424HE
Regulatory model: U2424Hb/U2424Ht/U2424HEb



 **NOTE: A NOTE indicates important information that helps you make better use of your computer.**

 **CAUTION: A CAUTION indicates potential damage to hardware or loss of data if instructions are not followed.**

 **WARNING: A WARNING indicates a potential for property damage, personal injury, or death.**

Copyright © 2023 Dell Inc. or its subsidiaries. All rights reserved. Dell, EMC, and other trademarks are trademarks of Dell Inc. or its subsidiaries. Other trademarks may be trademarks of their respective owners.

2023 - 09

Rev. A00

Contents

Safety instructions	7
About your monitor	8
Package contents	8
Product features	10
Identifying parts and controls	12
Front view	12
Top view	13
Back view	14
Rear and bottom view	15
Monitor specifications	20
Resolution specifications	22
Supported video modes	22
Preset display modes	23
Multi-Stream Transport (MST) modes	24
Electrical specifications	24
Physical characteristics	26
Environmental characteristics	28
Pin assignments	29
Universal Serial Bus (USB) interface	31
SuperSpeed USB 10 Gbps (USB 3.2 Gen2)	31
USB Type-C	31
USB 3.2 downstream connector	32
USB Type-C connector	32
USB ports	33
RJ45 connector (applicable for U2424HE only)	34
Driver installation	35
RJ45 connector LED status	36



Video Bandwidth	37
USB Speed Bandwidth	37
Plug and play capability	38
LCD monitor quality and pixel policy	38
Ergonomics	38
Handling and moving your display	40
Maintenance guidelines	41
Cleaning your monitor	41
Setting up the monitor	43
Attaching the stand	43
Organizing your cables	46
Using the tilt, swivel, and vertical extension	47
Tilt, swivel	47
Vertical extension	48
Rotating the monitor	48
Rotate clockwise	49
Rotate counterclockwise	49
Adjusting the rotation display settings of your system ..	50
Connecting your monitor	51
Connecting the DisplayPort (DisplayPort to DisplayPort) cable ..	51
Connecting the USB Type-C cable (applicable for U2424HE only)	52
Connecting the monitor for DP Multi-Stream Transport (MST) function	52
Connecting the Monitor for USB Type-C Multi-Stream Transport (MST) Function (applicable for U2424HE only)	53
Connecting the monitor for RJ45 cable (optional) (applicable for U2424HE only)	53
Connecting the USB A-C cable	54
Dell Power Button Sync (DPBS) (applicable for U2424HE only)	56
Connecting the monitor for DPBS for the first time	59
Using DPBS function	60



Connecting the monitor for USB-C Multi-Stream Transport (MST) function	62
Connecting the monitor for USB-C	63
Securing your monitor using Kensington lock (optional)	65
Removing the monitor stand	65
VESA wall mounting (optional)	66
Operating the monitor	67
Turn on the monitor	67
Using the joystick control	67
Joystick functions	68
Using the Main Menu	68
Accessing the Menu Launcher	68
Menu Launcher details	69
Using the navigation keys	70
Using the On-Screen Display (OSD) menu	70
Accessing the menu system	70
OSD messages	88
Initial setup	88
OSD warning messages	90
Setting the KVM switch (applicable for U2424HE only)	95
Setting the Auto KVM (applicable for U2424HE only)	97
Setting the maximum resolution	98
Setting the maximum refresh rate	99
Multi-Monitor Sync (MMS)	100
Setting Multi-Monitor Sync (MMS)	101
Troubleshooting	103
Self-test	103
Using the joystick to lock/unlock buttons	104
Locking the power and joystick buttons	104



Always On USB-C Charging (applicable for U2424HE only) 105

Updating monitor firmware 105

Common problems 106

Product specific problems 109

Universal Serial Bus (USB) specific problems 111

Regulatory information 113

 FCC notices (U.S. only) and other regulatory information 113

 EU product database for energy label and product information sheet 113

Contacting Dell 114



Safety instructions

Use the following safety guidelines to protect your monitor from potential damage and to ensure your personal safety. Unless otherwise noted, each procedure included in this document assumes that you have read the safety information that shipped with your monitor.

 **NOTE: Before using the monitor, read the safety instruction that is shipped with your monitor and printed on the product. Keep the documentation at a secure location for future reference.**

 **WARNING: Use of controls, adjustments, or procedures other than those specified in this documentation may result in exposure to shock, electrical hazards, and/or mechanical hazards.**

 **WARNING: The possible long-term effect of listening to audio at high volume through the headphones (on monitor that support it) may cause damage to your hearing ability.**

- Place the monitor on a solid surface and handle it carefully. The screen is fragile and can be damaged if dropped or hit with a sharp object.
- Ensure that your monitor is electrically rated to operate with the AC power available in your location.
- Keep the monitor in room temperature. Excessive cold or hot conditions can have an adverse effect on the liquid crystals of the display.
- Connect the power cable from the monitor to a wall outlet that is near and accessible. See [Connecting your monitor](#).
- Do not place and use the monitor on a wet surface or near water.
- Do not subject the monitor to severe vibration or high impact conditions. For example, do not place the monitor inside a car trunk.
- Unplug the monitor when it is going to be left unused for an extended period.
- To avoid electric shock, do not attempt to remove any cover or touch the inside of the monitor.
- Read these instructions carefully. Keep this document for future reference. Follow all warnings and instructions marked on the product.
- Certain monitors can be wall mounted using the VESA mount that is sold separately. Ensure to use the correct VESA specifications as mentioned in the wall mounting section of the *User's Guide*.

For information on safety instructions, see the *Safety, Environmental, and Regulatory Information (SERI)* document that is shipped with your monitor.







About your monitor



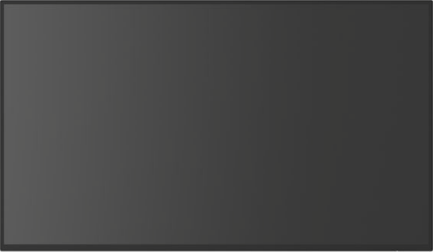

Package contents

The following table provides the list of components that are shipped with your monitor. If any component is missing, contact Dell. For more information, see [Contacting Dell](#).

 **NOTE: Some items may be optional and may not ship with your monitor. Some features may not be available in certain countries.**

	Display
	Stand riser
	Stand base
	Power cable (varies by country)



	<p>USB Type-C Gen2 cable (applicable for U2424HE only) Cable length: 1.00 M</p>
	<p>DisplayPort 1.4 cable (DP to DP) Cable length: 1.80 M</p>
	<p>USB-A to USB-C Gen2 cable Cable length: 1.00 M</p>
	<ul style="list-style-type: none"> • Quick Setup Guide • Safety, Environmental, and Regulatory Information • Factory Calibration Report



Product features

The **Dell U2424H/U2424H WOST/U2424HE** monitor has an active matrix, Thin-Film Transistor (TFT), Liquid Crystal Display (LCD) and LED backlight. The monitor features include:

- 60.47 cm (23.80 in.) viewable area (measured diagonally). 1920 x 1080 (16:9) resolution, plus full-screen support for lower resolutions.
- Wide viewing angle to allow viewing from a sitting or standing position.
- Color gamut of sRGB 100% and BT.709 100% with an average Delta E < 2; also supports DCI-P3 85%.
- Digital connectivity with DisplayPort, HDMI, and USB Type-C (with DP Alternate Mode; applicable for U2424HE only).
- Single USB Type-C to supply power (PD 90 W) to a compatible notebook while receiving video and data signal (applicable for U2424HE only).
- Tilt, swivel, height, and rotate adjustment capabilities.
- Ultra-thin bezel minimizes the bezel gap in multi-monitor usage, enabling easier setup with an elegant viewing experience.
- Removable stand and Video Electronics Standards Association (VESA™) 100 mm mounting holes for flexible mounting solutions.
- Auto Brightness sensor detects the surrounding light and adjusts monitor brightness and color temperature accordingly; multiple Dell monitors equipped with Auto Brightness sensor could synchronize their brightness and color temperature level through MST connection.
- U2424H/U2424H WOST is equipped with:
 - One USB Type-C upstream port (data only, USB 3.2 Gen2, 10 Gbps)
 - Two SuperSpeed USB 10 Gbps (USB 3.2 Gen2) Type-A downstream ports
 - One SuperSpeed USB 10 Gbps (USB 3.2 Gen2) Type-A downstream with BC1.2 charging port
 - One SuperSpeed USB 10 Gbps (USB 3.2 Gen2) Type-C downstream port
- U2424HE is equipped with:
 - One USB Type-C upstream port (video and data; DisplayPort 1.4 with Alternate mode, PD up to 90 W)
 - One USB Type-C upstream port (data only, USB 3.2 Gen2, 10 Gbps)
 - Three SuperSpeed USB 10 Gbps (USB 3.2 Gen2) Type-A downstream ports
 - One SuperSpeed USB 10 Gbps (USB 3.2 Gen2) Type-A downstream with BC1.2 charging port
 - One SuperSpeed USB 10 Gbps (USB 3.2 Gen2) Type-C downstream port



- USB Type-C and RJ45 ports enable a single-cable, network-connected experience (applicable for U2424HE only).
- Plug-and-play capability if supported by your computer.
- On-Screen Display (OSD) adjustments for ease of set-up and screen optimization.
- Power and OSD buttons lock.
- Security-lock slot.
- Stand lock.
- ≤ 0.5 W in Standby Mode.
- The monitor supports DRR (Dynamic refresh rate) function. DRR works with all Windows 11 tasks, allowing you to automatically increase the refresh rate (for smoother experience) while using the PC or NB to writing or scrolling, and lower the refresh rate when you don't need it, which saves more power.
- This monitor uses a low blue light panel. When the monitor is reset to factory settings or default setting, it is in compliance with TÜV Rheinland's hardware low blue light certification.*

Blue light ratio:

The ratio of light in the range from 415nm-455nm compared to 400nm-500nm shall be less than 50%.

Category	Blue light ratio
1	$\leq 20\%$
2	$20\% < R \leq 35\%$
3	$35\% < R \leq 50\%$

- Decreases the level of hazard blue light emitted from the screen to make viewing more comfortable for your eyes without distortion of color accuracy.
 - The monitor adopts Flicker-Free technology, which clears the eye visible flicker, brings comfort viewing experience and preventing users suffer from eye strain and fatigue.
- * This monitor is in compliance with TÜV Rheinland hardware low blue light certification under Category 2.

⚠ WARNING: The possible long-term effects of blue light emission from the monitor may cause damage to the eyes, which includes but is not limited to eye fatigue and digital eye strain. ComfortView Plus feature is designed to reduce the amount of blue light emitted from the monitor



to optimize eye comfort. The monitor uses low blue light panel and is in compliance with TÜV Rheinland at factory reset/default setting mode (Brightness: 75%, Contrast: 75%, CCT: Standard)

Identifying parts and controls

Front view



Front view with monitor stand

No.	Description	Use
1	Power LED indicator	Solid white light indicates that the monitor is turned on and functioning normally. Blinking white light indicates that the monitor is in Standby Mode.



Top view

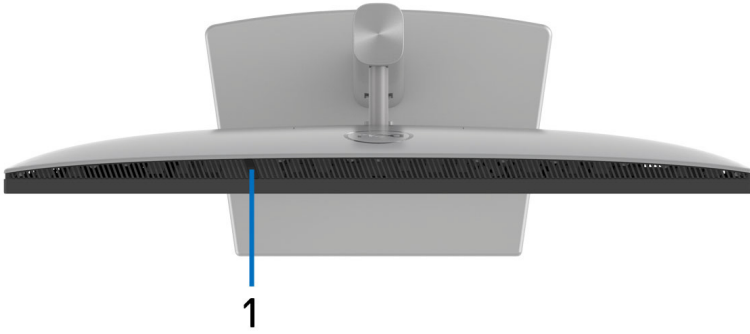

No.	Description	Use
1	Auto Brightness sensor	Adjusts the brightness and the color temperature of the display according to the surrounding light. For more information, see Auto Brightness and Auto Color Temp. NOTE: If the brightness level becomes abnormally low, see Troubleshooting .



Back view



Back view with monitor stand

No.	Description	Use
1	VESA mounting holes (100 mm x 100 mm - behind the attached VESA Cover)	Wall mount monitor using VESA-compatible wall mount kit (100 mm x 100 mm).
2	Regulatory label	Lists the regulatory approvals.
3	Stand release button	Releases stand from the monitor.
4	Barcode, serial number, and Service Tag label	See this label if you need to contact Dell for technical support. The Service Tag is a unique alphanumeric identifier that enables Dell service technicians to identify the hardware components in your monitor and access warranty information.
5	Power button	To turn the monitor on or off.
6	Joystick	Use to control the OSD menu. For more Information, see Operating the monitor .
7	Cable-management slot	Use to organize cables by routing them through the slot.



Rear and bottom view
U2424H/U2424H WOST

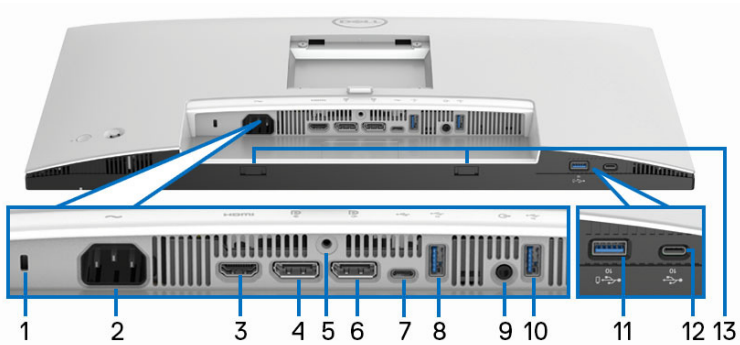

Rear and bottom view without monitor stand

No.	Description	Use
1	Security-lock slot (based on Kensington Security Slot)	Secure your monitor using a security lock (purchased separately) to prevent unauthorized movement of your monitor.
2	Power connector	Connect the power cable (shipped with your monitor).
3	HDMI port	Connect your computer with the HDMI cable.
4	DisplayPort	Connect your computer with the DisplayPort cable (shipped with your monitor).
5	Stand lock	To lock the stand to the monitor using a M3 x 6 mm screw (the screw is not included).
6	DisplayPort (out) 	DisplayPort output for MST (multi-stream transport) capable monitor. To enable MST, see Connecting the monitor for DP Multi-Stream Transport (MST) function . NOTE: Remove the rubber plug when using DisplayPort out connector.



7	SuperSpeed USB 10 Gbps (USB 3.2 Gen2) Type-C upstream port (data only)	<p>Connect the USB A-C cable (shipped with your monitor) from the monitor to the computer. This port supports USB data transfer at 10 Gbps (USB 3.2 Gen2). Once this cable is connected, you can use the USB connectors on the monitor.</p> <p>NOTE: USB Type-C is not supported on versions of Windows prior to Windows 10 and Windows 11.</p>
8	SuperSpeed USB 10 Gbps (USB 3.2 Gen2) Type-A downstream ports	<p>Connect your USB device.**</p> <p>NOTE: To use these ports, you must connect the USB A-C cable (shipped with your monitor) to the USB Type-C upstream port (data only) on the monitor and to your computer.</p>
9	Audio line-out port	Connect external speakers.*
10	SuperSpeed USB 10 Gbps (USB 3.2 Gen2) Type-A downstream ports	<p>Connect your USB device.**</p> <p>NOTE: To use these ports, you must connect the USB A-C cable (shipped with your monitor) to the USB Type-C upstream port (data only) on the monitor and to your computer.</p>
11	SuperSpeed USB 10 Gbps (USB 3.2 Gen2) Type-A downstream with BC1.2 charging port	<p>Connect your USB device** or charge your device.</p> <p>NOTE: To use this port, you must connect the USB A-C cable (shipped with your monitor) to the USB Type-C upstream port (data only) on the monitor and to your computer.</p>
12	SuperSpeed USB 10 Gbps (USB 3.2 Gen2) Type-C downstream port (10 Gbps, 15 W)	<p>Connect your USB device.**</p> <p>NOTE: To use this port, you must connect the USB A-C cable (shipped with your monitor) to the USB Type-C upstream port (data only) on the monitor and to your computer.</p>



13	Soundbar slots	Attach your external Soundbar (sold separately) to the monitor by aligning the magnetic tabs on the soundbar with the slots on the monitor.
-----------	----------------	---

*Headphone usage is not supported for the audio line out connector.

**To avoid signal interference, when a wireless USB device has been connected to a USB downstream port, it is not recommended to connect any other USB devices to the adjacent port(s).

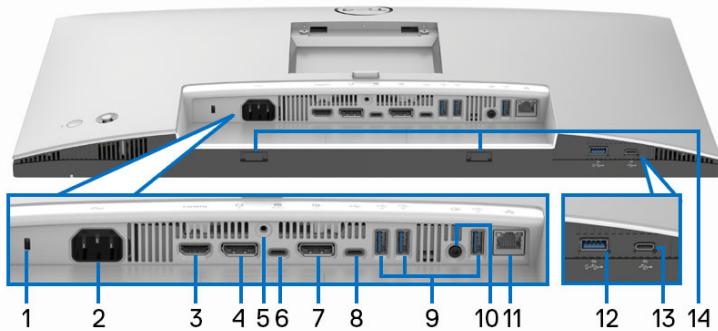

U2424HE



Rear and bottom view without monitor stand

No.	Description	Use
1	Security-lock slot (based on Kensington Security Slot)	Secure your monitor using a security lock (purchased separately) to prevent unauthorized movement of your monitor.
2	Power connector	Connect the power cable (shipped with your monitor).
3	HDMI port	Connect your computer with the HDMI cable.
4	DisplayPort	Connect your computer with the DisplayPort cable (shipped with your monitor).
5	Stand lock	To lock the stand to the monitor using a M3 x 6 mm screw (the screw is not included).



<p>6</p>	<p>SuperSpeed USB 10 Gbps (USB 3.2 Gen2) Type-C upstream port (video and data)</p>	<p>Connect the USB Type-C cable (shipped with your monitor) from the monitor to the computer or notebook. This port supports USB Power Delivery, Data, and DisplayPort video signal.</p> <p>The SuperSpeed USB 10 Gbps (USB 3.2 Gen2) Type-C port offers the fastest transfer rate and the alternate mode with DP 1.4 supports a maximum resolution of 1920 x 1080 at 120 Hz, PD 20 V/4.5 A, 15 V/3 A, 9 V/3 A, 5 V/3 A.</p> <p>NOTE: USB Type-C is not supported on versions of Windows prior to Windows 10 and Windows 11.</p>
<p>7</p>	<p>DisplayPort (out)</p> 	<p>DisplayPort output for MST (multi-stream transport) capable monitor. To enable MST, see Connecting the monitor for DP Multi-Stream Transport (MST) function.</p> <p>NOTE: Remove the rubber plug when using DisplayPort out connector.</p>
<p>8</p>	<p>SuperSpeed USB 10 Gbps (USB 3.2 Gen2) Type-C upstream port (data only)</p> 	<p>Connect the USB A-C cable (shipped with your monitor) from the monitor to the computer. This port supports USB data transfer at 10 Gbps (USB 3.2 Gen2). Once this cable is connected, you can use the USB connectors on the monitor.</p> <p>NOTE: USB Type-C is not supported on versions of Windows prior to Windows 10 and Windows 11.</p> <p>NOTE: Remove the rubber plug when using USB Type-C upstream port (data only) connector.</p>



<p>9</p>	<p>SuperSpeed USB 10 Gbps (USB 3.2 Gen2) Type-A downstream ports (3)</p>	<p>Connect your USB device.**</p> <p>NOTE: To use these ports, you must connect the USB Type-C cable (shipped with your monitor) to the USB Type-C upstream port (video and data) (#6) or connect the USB A-C cable (shipped with your monitor) to the USB Type-C upstream port (data only) (#8) on the monitor and to your computer.</p>
<p>10</p>	<p>Audio line-out port</p>	<p>Connect external speakers.*</p>
<p>11</p>	<p>RJ45 port</p>	<p>Support Ethernet connection 10/100/1000/2500 Mbps. Connect this port to Ethernet with RJ45 cable. You can use either the USB Type-C cable or the USB A-C cable that are shipped with your monitor to make USB connection and complete the setup.</p>
<p>12</p>	<p>SuperSpeed USB 10 Gbps (USB 3.2 Gen2) Type-A downstream port with Type-A downstream with BC1.2 charging port</p>	<p>Connect your USB device** or charge your device.</p> <p>NOTE: To use these ports, you must connect the USB Type-C cable (shipped with your monitor) to the USB Type-C upstream port (video and data) (#6) or connect the USB A-C cable (shipped with your monitor) to the USB Type-C upstream port (data only) (#8) on the monitor and to your computer.</p>
<p>13</p>	<p>SuperSpeed USB 10 Gbps (USB 3.2 Gen2) Type-C downstream port (10 Gbps, 15 W)</p>	<p>Connect your USB device.**</p> <p>NOTE: To use these ports, you must connect the USB Type-C cable (shipped with your monitor) to the USB Type-C upstream port (video and data) (#6) or connect the USB A-C cable (shipped with your monitor) to the USB Type-C upstream port (data only) (#8) on the monitor and to your computer.</p>
<p>14</p>	<p>Soundbar slots</p>	<p>Attach your external Soundbar (sold separately) to the monitor by aligning the magnetic tabs on the soundbar with the slots on the monitor.</p>

*Headphone usage is not supported for the audio line out connector.



**To avoid signal interference, when a wireless USB device has been connected to a USB downstream port, it is not recommended to connect any other USB devices to the adjacent port(s).

Monitor specifications

Model	U2424H/U2424H WOST/U2424HE
Screen type	Active matrix - TFT LCD
Panel technology	In-Plane Switching Technology
Aspect ratio	16:9
Viewable Image	
Diagonal	604.70 mm (23.80 in.)
Width (active area)	527.04 mm (20.75 in.)
Height (active area)	296.46 mm (11.67 in.)
Total area	156246.28 mm ² (242.18 in. ²)
Pixel pitch	0.2745 mm x 0.2745 mm
Pixel per inch (PPI)	92.53
Viewing angle	
Vertical	178° (typical)
Horizontal	178° (typical)
Luminance output	250 cd/m ² (typical)
Contrast ratio	1000 to 1 (typical)
Faceplate coating	Anti-Glare with 3H hardness
Backlight	LED Edgelight System
Response time	8 ms (Normal OD) 5 ms (Fast OD)
Color depth	16.7 million colors
Color gamut	<ul style="list-style-type: none"> • sRGB 100% • BT.709 100% • DCI-P3 85%
Calibration accuracy	sRGB and BT.709: Delta E < 2 (average)



Connectivity	<ul style="list-style-type: none"> • 1 x DisplayPort version 1.4 (DRR for Microsoft Windows) (HDCP 1.4)* (supports up to FHD 1920 x 1080 120 Hz) • 1 x HDMI port version 1.4 (HDCP 1.4) (supports up to FHD 1920 x 1080 120 Hz TMDS as per specified in HDMI 1.4) • 1 x DisplayPort (Out) with MST (HDCP 1.4) • 1 x USB Type-C upstream port (video and data) (Alternate mode with DisplayPort 1.4, Power Delivery PD up to 90 W) (applicable for U2424HE only)** • 1 x USB Type-C upstream port (data only, 10 Gbps USB 3.2 Gen2) • 2 x SuperSpeed USB 10 Gbps (USB 3.2 Gen2) Type-A downstream ports (applicable for U2424H/ U2424H WOST only) • 3 x SuperSpeed USB 10 Gbps (USB 3.2 Gen2) Type-A downstream ports (applicable for U2424HE only) • 1 x audio line-out port • 1 x RJ45 port (applicable for U2424HE only) <p>Quick Access:</p> <ul style="list-style-type: none"> • 1 x USB Type-C downstream port with charging capability at 15 W (maximum) • 1 x SuperSpeed USB 10 Gbps (USB 3.2 Gen2) Type-A downstream port with BC1.2 charging capability at 2 A (maximum)
Border width (edge of monitor to active area)	
Top	5.80 mm
Left/Right	5.80 mm
Bottom	8.95 mm



Adjustability	
Height adjustable stand	150 mm
Tilt	-5° to 21°
Swivel	-45° to 45°
Pivot	-90° to 90°
Dell Display Manager compatibility	Easy Arrange and other key features
Security	Security-lock slot (cable lock sold separately)

*DisplayPort 1.4/MST/DP audio is supported.

**HBR3/DisplayPort 1.4/MST/DP audio is supported.

Resolution specifications

Model	U2424H/U2424H WOST/U2424HE
Horizontal scan range	31 kHz to 135 kHz (automatic)
Vertical scan range	48 Hz to 120 Hz (automatic)
Default preset resolution	1920 x 1080 at 60 Hz
Maximum preset resolution	1920 x 1080 at 120 Hz

Supported video modes

Model	U2424H/U2424H WOST
Video display capabilities (HDMI and DisplayPort)	480p, 576p, 720p, 1080i*, 1080p

Model	U2424HE
Video display capabilities (HDMI, DisplayPort, and USB-C alternate mode)	480p, 576p, 720p, 1080i*, 1080p

*For HDMI input only.



Preset display modes

Display Mode	Horizontal Frequency (kHz)	Vertical Frequency (Hz)	Pixel Clock (MHz)	Sync Polarity (Horizontal /Vertical)
VESA, 640 x 480	31.5	59.9	25.2	-/-
VESA, 640 x 480	37.5	75.0	31.5	-/-
720 x 400	31.5	70.1	28.3	-/+
720 x 480	31.5	59.9	27.0	-/-
VESA, 800 x 600	37.9	60.3	40.0	+/+
VESA, 800 x 600	46.9	75.0	49.5	+/+
VESA, 1024 x 768	48.4	60.0	65.0	-/-
VESA, 1024 x 768	60.0	75.0	78.8	+/+
VESA, 1152 x 864	67.5	75.0	108.0	+/+
1280 x 720	44.8	59.9	74.5	-/+
1280 x 720	56.5	74.8	95.8	-/+
VESA, 1280 x 720	45.0	60.0	74.3	+/+
VESA, 1280 x 1024	64.0	60.0	108.0	+/+
VESA, 1280 x 1024	80.0	75.0	135.0	+/+
VESA, 1600 x 900	60.0	60.0	108.0	+/+
VESA, 1920 x 1080	67.5	60.0	148.5	+/+
1920 x 1080	135.0	120.0	297.0	+/+

 **NOTE: The + or - sign in Sync polarity denotes that the video sync signal is triggered by either the positive edge or the negative edge, respectively.**



Multi-Stream Transport (MST) modes

Using USB Type-C (applicable for U2424HE only):

MST Source Monitor	Maximum Number of External Monitor that can be Supported
	1920 x 1080 at 120 Hz
1920 x 1080 at 120 Hz	2 (with USB-C DP Alt mode)

Using DisplayPort:

MST Source Monitor	Maximum Number of External Monitor that can be Supported
	1920 x 1080 at 120 Hz
1920 x 1080 at 120 Hz	2

Electrical specifications

Model	U2424H/U2424H WOST	U2424HE
Video input signals	<ul style="list-style-type: none">• HDMI 1.4*/DisplayPort 1.4**, 600 mV for each differential line, 100 ohm input impedance per differential pair• USB Type-C (with Alternate mode) signal input support (applicable for U2424HE only)***	
AC input voltage/frequency/current	100 VAC to 240 VAC / 50 Hz or 60 Hz \pm 3 Hz / 1.5 A (typical)	100 VAC to 240 VAC / 50 Hz or 60 Hz \pm 3 Hz / 2.2 A (typical)
Inrush current	<ul style="list-style-type: none">• 120 V: 30 A (Max.) at 0°C (cold start)• 240 V: 60 A (Max.) at 0°C (cold start)	<ul style="list-style-type: none">• 120 V: 40 A (Max.) at 0°C (cold start)• 240 V: 80 A (Max.) at 0°C (cold start)



Power consumption	<ul style="list-style-type: none"> · 0.3 W (Off mode)¹ · 0.5 W (Standby mode)¹ · 13.7 W (On mode)¹ · 72.0 W (Max.)² · 11.3 W (P_{on})³ · 36.6 kWh (TEC)³ 	<ul style="list-style-type: none"> · 0.3 W (Off mode)¹ · 0.5 W (Standby mode)¹ · 14.5 W (On mode)¹ · 1.5 W (Networked standby mode)¹ · 210.0 W (Max.)² · 13.6 W (P_{on})³ · 46.2 kWh (TEC)³
-------------------	--	---

*Not supporting the HDMI 1.4 optional specification, including HDMI Ethernet Channel (HEC), Audio Return Channel (ARC), standard for 3D format and resolutions, and standard for 4K digital cinema resolution.

**DisplayPort 1.4/MST/DP audio is supported.

***HBR3/DisplayPort 1.4/MST/DP audio is supported.

¹ As defined in EU 2019/2021 and EU 2019/2013.

² Max brightness and contrast setting with maximum power loading on all USB ports.

³ P_{on}: Power consumption of On mode as defined in Energy Star 8.0 version.

TEC: Total energy consumption in kWh as defined in Energy Star 8.0 version.

This document is informational only and reflects laboratory performance. Your product may perform differently, depending on the software, components and peripherals you ordered and shall have no obligation to update such information.

Accordingly, the customer should not rely upon this information in making decisions about electrical tolerances or otherwise. No warranty as to accuracy or completeness is expressed or implied.



NOTE: This monitor is ENERGY STAR certified.

This product qualifies for ENERGY STAR in the factory default settings which can be restored by “Factory Reset” function in the OSD menu. Changing the factory default settings or enabling other features may increase power consumption that could exceed the ENERGY STAR specified limit.



Physical characteristics

Model	U2424H/U2424H WOST/U2424HE
Signal cable type	<ul style="list-style-type: none">• Digital: DisplayPort, 20 pins• Universal Series Bus: Type-C, 24 pins (applicable for U2424HE only)• Universal Serial Bus: USB A-C
NOTE: Dell monitors are designed to work optimally with the video cables that are shipped with your monitor. As Dell does not have control over the different cable suppliers in the market, the type of material, connector and process used to manufacture these cables, Dell does not guarantee video performance on cables that are not shipped with your Dell monitor.	
Dimensions (with stand)	
Height (extended)	496.53 mm (19.55 in.)
Height (compressed)	364.00 mm (14.33 in.)
Width	538.64 mm (21.21 in.)
Depth	181.75 mm (7.16 in.)
Dimensions (without stand)	
Height	311.21 mm (12.25 in.)
Width	538.64 mm (21.21 in.)
Depth	49.10 mm (1.93 in.)
Stand dimensions	
Height (extended)	410.80 mm (16.17 in.)
Height (compressed)	364.00 mm (14.33 in.)
Width	249.80 mm (9.83 in.)
Depth	181.75 mm (7.16 in.)
Base	249.80 mm x 177.00 mm (9.83 in. x 6.97 in.)



Monitor weight			
Model	U2424H	U2424H WOST	U2424HE
Weight with packaging	7.92 kg (17.46 lb)	6.35 kg (14.00 lb)	8.45 kg (18.62 lb)
Weight with stand assembly and cables	5.38 kg (11.86 lb)	NA	5.91 kg (13.03 lb)
Weight without stand assembly and with cables	NA	3.80 kg (8.38 lb)	NA
Weight without stand assembly (For wall mount or VESA mount considerations - no cables)	3.52 kg (7.76 lb)	3.52 kg (7.76 lb)	3.98 kg (8.77 lb)
Weight of stand assembly	1.57 kg (3.46 lb)	NA	1.57 kg (3.46 lb)



Environmental characteristics

Model	U2424H/U2424H WOST	U2424HE
Compliant standards		
<ul style="list-style-type: none"> ENERGY STAR certified monitor EPEAT registered where applicable. EPEAT registration varies by country. See www.epeat.net for registration status by country. RoHS-compliant TCO Certified & TCO Certified Edge BFR/PVC free monitor (excluding external cables) Arsenic-free glass and Mercury-free for the panel only 		
Temperature		
Operating	0°C to 40°C (32°F to 104°F)	
Non-operating	<ul style="list-style-type: none"> Storage: -20°C to 60°C (-4°F to 140°F) Shipping: -20°C to 60°C (-4°F to 140°F) 	
Humidity		
Operating	10% to 80% (non-condensing)	
Non-operating	<ul style="list-style-type: none"> Storage: 5% to 90% (non-condensing) Shipping: 5% to 90% (non-condensing) 	
Altitude		
Operating	5000 m (16404 ft) (maximum)	
Non-operating	12192 m (40000 ft) (maximum)	
Thermal dissipation	<ul style="list-style-type: none"> 245.7 BTU/Hour (Maximum) 46.7 BTU/Hour (On mode) 	<ul style="list-style-type: none"> 716.5 BTU/Hour (Maximum) 49.5 BTU/Hour (On mode)



Pin assignments

DisplayPort connector

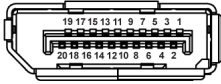

Pin Number	20-pin side of the connected signal cable
1	ML3 (n)
2	GND
3	ML3 (p)
4	ML2 (n)
5	GND
6	ML2 (p)
7	ML1 (n)
8	GND
9	ML1 (p)
10	ML0 (n)
11	GND
12	ML0 (p)
13	GND
14	GND
15	AUX (p)
16	GND
17	AUX (n)
18	Hot Plug Detect
19	Re-PWR
20	+3.3 V DP_PWR



HDMI connector

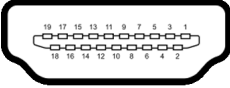

Pin Number	19-pin side of the connected signal cable
1	TMDS DATA 2+
2	TMDS DATA 2 SHIELD
3	TMDS DATA 2-
4	TMDS DATA 1+
5	TMDS DATA 1 SHIELD
6	TMDS DATA 1-
7	TMDS DATA 0+
8	TMDS DATA 0 SHIELD
9	TMDS DATA 0-
10	TMDS CLOCK+
11	TMDS CLOCK SHIELD
12	TMDS CLOCK-
13	CEC
14	Reserved (N.C. on device)
15	DDC CLOCK (SCL)
16	DDC DATA (SDA)
17	DDC/CEC Ground
18	+5 V POWER
19	HOT PLUG DETECT



Universal Serial Bus (USB) interface

This section gives you information about the USB ports that are available on the monitor.

 **NOTE: This monitor is SuperSpeed USB 10 Gbps (USB 3.2 Gen2) compatible.**

SuperSpeed USB 10 Gbps (USB 3.2 Gen2)

Transfer speed	Data rate	Maximum power supported*
Super speed	10 Gbps	4.5 W
High speed	480 Mbps	4.5 W
Full speed	12 Mbps	4.5 W

*Up to 2 A on USB downstream port (with  battery icon) with BC1.2 compliance devices or normal USB devices.

USB Type-C

USB Type-C (applicable for U2424HE only)	Description
Video	DisplayPort 1.4*
Data	SuperSpeed USB 10 Gbps (USB 3.2 Gen2)
Power Delivery (PD)	Up to 90 W

*HBR3/DisplayPort 1.4/MST/DP audio is supported.



USB 3.2 downstream connector

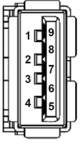

Pin number	Signal name	Pin number	Signal name
1	VBUS	6	StdA_SSRX+
2	D-	7	GND_DRAIN
3	D+	8	StdA_SSTX-
4	GND	9	StdA_SSTX+
5	StdA_SSRX-	Shell	Shield

USB Type-C connector

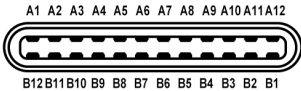

Pin number	Signal name	Pin number	Signal name
A1	GND	B1	GND
A2	TX1+	B2	TX2+
A3	TX1-	B3	TX2-
A4	VBUS	B4	VBUS
A5	CC1	B5	CC2
A6	D+	B6	D+
A7	D-	B7	D-
A8	SBU1	B8	SBU2
A9	VBUS	B9	VBUS
A10	RX2-	B10	RX1-
A11	RX2+	B11	RX1+
A12	GND	B12	GND



USB ports

- One SuperSpeed USB 10 Gbps (USB 3.2 Gen2) Type-C upstream port (video and data) (applicable for U2424HE only) - bottom
 - One SuperSpeed USB 10 Gbps (USB 3.2 Gen2) Type-C upstream port (data only) - bottom
 - One SuperSpeed USB 10 Gbps (USB 3.2 Gen2) Type-C downstream port - Quick Access
 - Three SuperSpeed USB 10 Gbps (USB 3.2 Gen2) Type-A downstream ports (applicable for U2424H/U2424H WOST only) - two at bottom; one at Quick Access
 - Four SuperSpeed USB 10 Gbps (USB 3.2 Gen2) Type-A downstream ports (applicable for U2424HE only) - three at bottom; one at Quick Access
- Power Charging Port - the port with  battery icon; supports up to 2 A fast-charging capability if the device is BC1.2 compatible.

 **NOTE: SuperSpeed USB 10 Gbps (USB 3.2 Gen2) functionality requires a SuperSpeed USB 10 Gbps (USB 3.2 Gen2)-capable computer.**

 **NOTE: The USB ports on the monitor work only when the monitor is turned on or in Standby Mode. If you turn off the monitor and then turn it on, the attached peripherals may take a few seconds to resume normal functionality.**



RJ45 connector (applicable for U2424HE only)

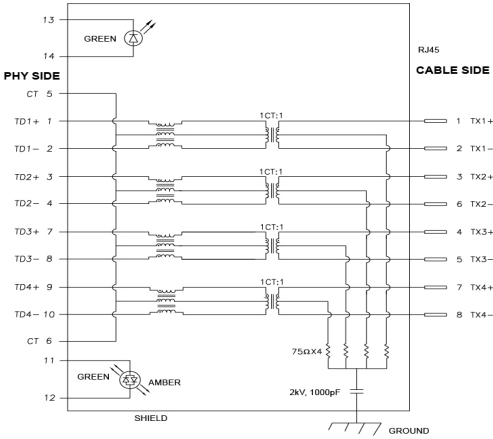

Pin	Signal	
P1	MDI0+	
P2	MDI0-	
P3	MDI1+	
P4	MDI1-	
P5	CT	
P6	CT	
P7	MDI2+	
P8	MDI2-	
P9	MDI3+	
P10	MDI3-	
Pin number	Amber	Green
P11	-	+
P12	+	-
P13	N/A	+
P14	N/A	-



Driver installation

Install the Realtek USB GBE Ethernet Controller Driver available for your system. This is available for download at www.dell.com/support. Enter your monitor model number in the **Search** bar to identify the product, and then find the software under **Drivers & Downloads** section.

Network (RJ45) data rate through USB-C max speed is 2500 Mbps.

Wake-on-LAN behavior

Computer power save state	Computer behavior after receiving Wake-on-LAN (WOL) command
Modern Standby (S0ix)	Computer and monitor remain in Standby but network communication enabled.
Standby/Sleep (S3)	Both Computer and monitor turned on.
Hibernate (S4)	Both Computer and monitor turned on.
OFF/Shutdown (S5)	Both Computer and monitor turned on.

 **NOTE: The computer BIOS must be configured to enable WOL function.**

 **NOTE: This LAN port is 1000Base-T IEEE 802.3az compliant, supporting Mac Address (Printed on model label) Pass-thru (MAPT), Wake-on-LAN (WOL) from standby mode (S3 only) and UEFI* PXE Boot function [UEFI PXE Boot is not supported on Dell Desktop PC's (except for OptiPlex 7090/3090 Ultra Desktop)], these 3 features depend on BIOS settings and version of the OS. Functionality may vary with non-Dell PC's.**

*UEFI stands for Unified Extensible Firmware Interface.

 **NOTE: WOL S4 and WOL S5 only capable with Dell Systems that support DPBS and is with USB-C connection only.**

 **NOTE: Any issue related to WOL, user should debug the computer without monitor. After the problem is solved, then connect to the Monitor.**



RJ45 connector LED status

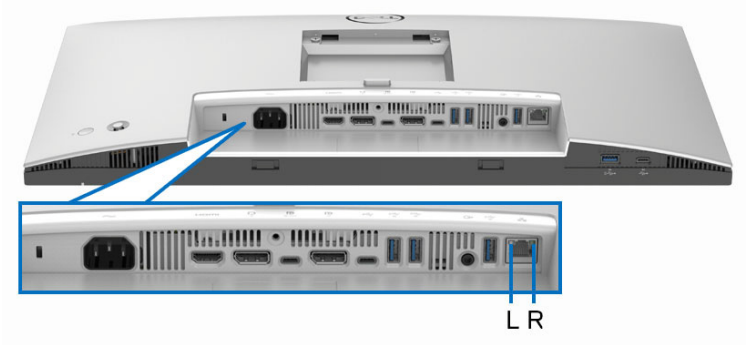

LED	Color	Description
Left LED	Green	Link / Activity indicator: <ul style="list-style-type: none">• Blinking - Activity on the port.• Green On - Link is being established.• Off - Link is not established.
Right LED	Amber or Green	Speed indicator: <ul style="list-style-type: none">• Amber On - 2500/1000 Mbps• Green On - 100 Mbps• Off - 10 Mbps

 **NOTE: RJ45 cable is non in-box standard accessory.**



Video Bandwidth

Host	Video Cable	USB-C Prioritization	Color Depth	Resolution
USB-C (Alt Mode DP1.2)	USB-C Gen2 cable	High data speed	8-bits	1920 x 1080 @ 120 Hz
		High resolution	8-bits	1920 x 1080 @ 120 Hz
USB-C (Alt Mode DP1.4)	USB-C Gen2 cable	High data speed	8-bits	1920 x 1080 @ 120 Hz
		High resolution	8-bits	1920 x 1080 @ 120 Hz
HDMI 1.4	HDMI cable	N/A	8-bits	1920 x 1080 @ 120 Hz
DP 1.2	DP cable	N/A	8-bits	1920 x 1080 @ 120 Hz
DP 1.4	DP cable	N/A	8-bits	1920 x 1080 @ 120 Hz

USB Speed Bandwidth

Host	USB Upstream Cable	USB-C Prioritization	USB Device connected to USB-A or C Downstream
USB-C (Alt Mode DP1.2)	USB-C Gen2 cable	High data speed	Supported, USB 2.0/3.2 Gen2
		High resolution	Supported, USB 2.0
USB-C (Alt Mode DP1.4)	USB-C Gen2 cable	High data speed	Supported, USB 2.0/3.2 Gen2
		High resolution	Supported, USB 2.0
USB-A 2.0	USB A - C cable	N/A	Supported, USB 2.0
USB-A 3.2 Gen1	USB A - C cable	N/A	Supported, USB 2.0/3.2 Gen1
USB-C 3.2 Gen1 (Data only)	USB-C Gen2 cable	N/A	Supported, USB 2.0/3.2 Gen1
USB-C 3.2 Gen2 (Data only)	USB-C Gen2 cable	N/A	Supported, USB 2.0/3.2 Gen2



Plug and play capability

You can connect the monitor to any Plug and Play-compatible system. The monitor automatically provides the computer with its Extended Display Identification Data (EDID) using Display Data Channel (DDC) protocols so that the computer can configure itself and optimize the monitor settings. Most monitor installations are automatic; you can select different settings as required. For more information about changing the monitor settings, see [Operating the monitor](#).

LCD monitor quality and pixel policy

During the LCD Monitor manufacturing process, it is not uncommon for one or more pixels to become fixed in an unchanging state which are hard to see and do not affect the display quality or usability. For more information on Dell Monitor Quality and Pixel Policy, see www.dell.com/pixelguidelines.

Ergonomics

 **CAUTION: Improper or prolonged usage of keyboard may result in injury.**

 **CAUTION: Viewing the monitor screen for extended periods of time may result in eye strain.**

For comfort and efficiency, observe the following guidelines when setting up and using your computer workstation:

- Position your computer so that the monitor and keyboard are directly in front of you as you work. Special shelves are commercially available to help you correctly position your keyboard.
- To reduce the risk of eye strain and neck, arm, back, or shoulder pain from using the monitor for long periods of time, we recommend you to:
 1. Set the distance of the screen between 20 to 28 in. (50 - 70 cm) from your eyes.
 2. Blink frequently to moisten your eyes or wet your eyes with water after prolonged usage of the monitor
 3. Take regular and frequent breaks for 20 minutes every two hours.
 4. Look away from your monitor and gaze at a distant object that is 20 feet away for at least 20 seconds during the breaks.
 5. Perform stretches to relieve tension in the neck, arm, back, and shoulders during the breaks.
- Ensure that the monitor screen is at eye level or slightly lower when you are sitting in front of the monitor.



- Adjust the tilt of the monitor, its contrast, and brightness settings.
- Adjust the ambient lighting around you (such as overhead lights, desk lamps, and the curtains or blinds on nearby windows) to minimize reflections and glare on the monitor screen.
- Use a chair that provides good lower-back support.
- Keep your forearms horizontal with your wrists in a neutral, comfortable position while using the keyboard or mouse.
- Always leave space to rest your hands while using the keyboard or mouse.
- Let your upper arms rest naturally on both sides.
- Ensure that your feet are resting flat on the floor.
- When sitting, make sure that the weight of your legs is on your feet and not on the front portion of your seat. Adjust your chair's height or use a footrest if necessary, to maintain a proper posture.
- Vary your work activities. Try to organize your work so that you do not have to sit and work for extended periods of time. Try to stand or get up and walk around at regular intervals.
- Keep the area under your desk clear of obstructions and cables or power cords that may interfere with comfortable seating or present a potential trip hazard.

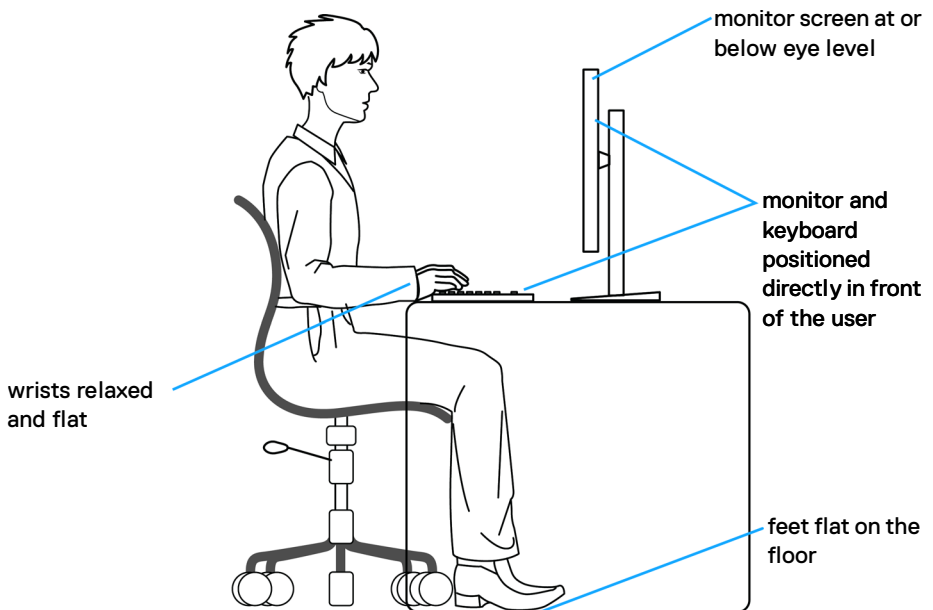

Handling and moving your display

To ensure that the monitor is handled safely when lifting or moving it, follow these guidelines:

- Before moving or lifting the monitor, turn off your computer and the monitor.
- Disconnect all cables from the monitor.
- Place the monitor in the original box with the original packing materials.
- Hold the bottom edge and the side of the monitor firmly without applying excessive pressure when lifting or moving the monitor.

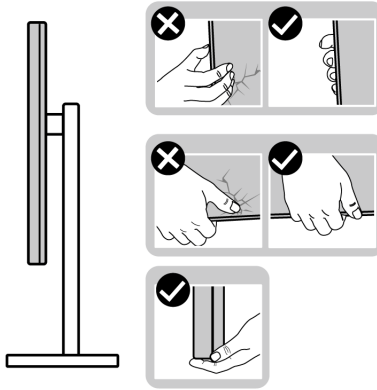

- When lifting or moving the monitor, ensure the screen is facing away from you and do not press on the display area to avoid any scratches or damage.

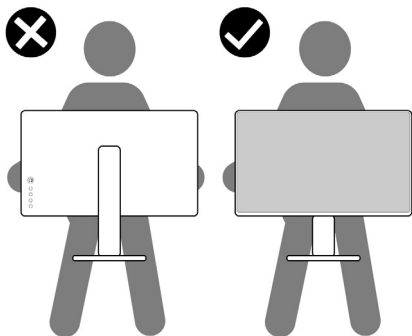

- When transporting the monitor, avoid any sudden shock or vibration to it.



- When lifting or moving the monitor, do not turn the monitor upside down while holding the stand base or stand riser. This may result in accidental damage to the monitor or cause personal injury.

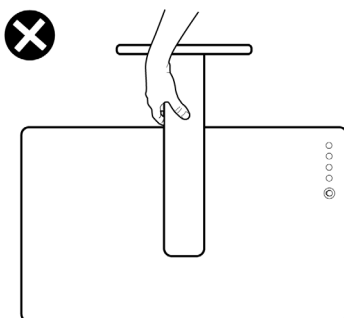

Maintenance guidelines

Cleaning your monitor

- △ **CAUTION:** Read and follow the [Safety instructions](#) before cleaning the monitor.
- △ **WARNING:** Before cleaning the monitor, unplug the monitor power cable from the electrical outlet.

For best practices, follow the instructions in the list below when unpacking, cleaning, or handling your monitor:

- Use a clean cloth that is slightly dampened with water to clean the stand assembly, the screen, and the chassis of your Dell monitor. If available, use a screen-cleaning tissue or solution suitable for cleaning Dell monitors.
- After cleaning the surface of the table, ensure that it is thoroughly dry and free from any moisture or cleaning agent before placing your Dell monitor on it.
- △ **CAUTION:** Do not use detergents or other chemicals such as benzene, thinner, ammonia, abrasive cleaners, alcohol, or compressed air.
- △ **CAUTION:** Using chemicals for cleaning may cause changes in the appearance of the monitor, such as color fading, milky film on the monitor, deformation, uneven dark shade, and peeling of screen area.





WARNING: Do not spray the cleaning solution or even water directly on the surface of the monitor. Doing so will allow liquids to accumulate at the bottom of the display panel and corrode the electronics resulting in permanent damage. Instead, apply the cleaning solution or water to a soft cloth and then clean the monitor.





NOTE: Monitor damage due to improper cleaning methods and the use of benzene, thinner, ammonia, abrasive cleaners, alcohol, compressed air, detergent of any kind will lead to a Customer Induced Damage (CID). CID is not covered under the standard Dell warranty.

- If you notice white residual powder when you unpack your monitor, wipe it off with a cloth.
- Handle your monitor with care as a darker-colored monitor may get scratched and show white scuff marks more than a lighter-colored monitor.
- To help maintain the best image quality on your monitor, use a dynamically changing screen saver and turn off your monitor when not in use.



Setting up the monitor

Attaching the stand

-  **NOTE:** The stand assembly is not pre-installed when the monitor is shipped from the factory.
-  **NOTE:** The following instructions are applicable only for the stand that was shipped with your monitor. If you are attaching a stand that you purchased from any other source, follow the setup instructions that were included with the stand.

To attach the monitor stand, refer to the instructions on the flaps of carton to remove the stand from the cushion that secures it, and then follow the steps below:

1. Remove the stand riser and stand base from the packaging cushion.

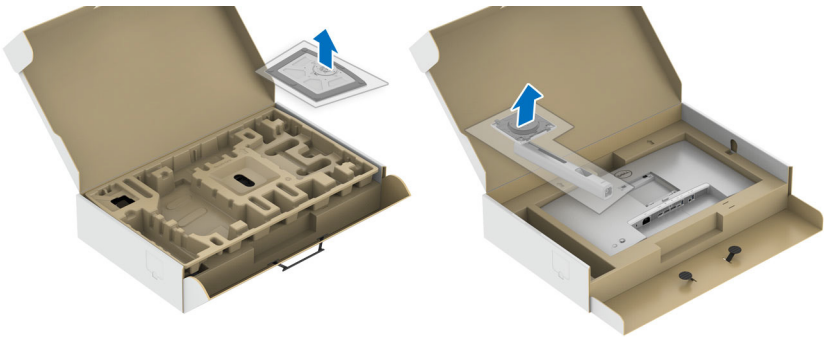

2. Insert the stand base blocks fully into the stand slot.
3. Lift the screw handle and turn the screw clockwise.
4. After fully tightening the screw, fold the screw handle flat within the recess.



5. Lift the cover, as shown, to access the VESA area for stand assembly.

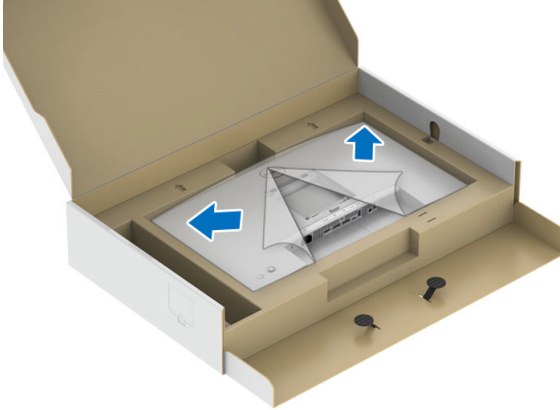

6. Attach the stand assembly to the monitor.

- a. Fit the two tabs on the upper part of the stand to the groove on the back of the monitor.
- b. Press the stand down till it snaps into place.



7. Place the monitor upright.



NOTE: Lift the monitor carefully to prevent it from slipping or falling.

8. Remove the cover from the monitor.

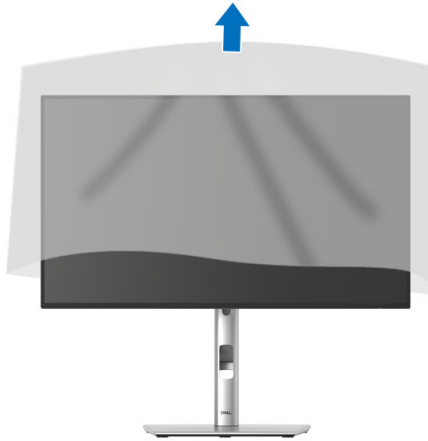

Organizing your cables



After attaching all necessary cables to your monitor and computer (See [Connecting your monitor](#) for cable attachment), organize all cables as shown above.

If your cable is not able to reach your PC, you may connect directly to the PC without routing through the slot on the monitor stand.



Using the tilt, swivel, and vertical extension

NOTE: The following instructions are applicable only for attaching the stand that was shipped with your monitor. If you are attaching a stand that you purchased from any other source, follow the set up instructions that were included with the stand.

Tilt, swivel

With the stand attached to the monitor, you can tilt and swivel the monitor for the most comfortable viewing angle.

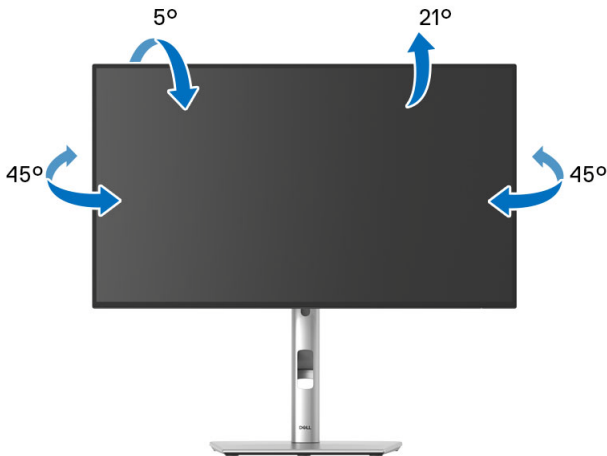

NOTE: The stand is not installed at the factory when shipped.



Vertical extension

 **NOTE:** The stand extends vertically up to 150 mm. The figure below illustrates how to extend the stand vertically.

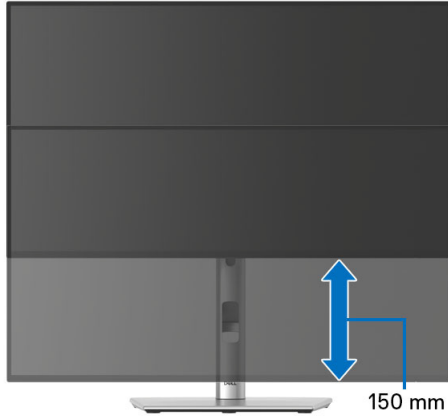

Rotating the monitor

Before you rotate the monitor, your monitor should be fully vertically extended ([Vertical extension](#)) and fully tilted up to avoid hitting the bottom edge of the monitor.

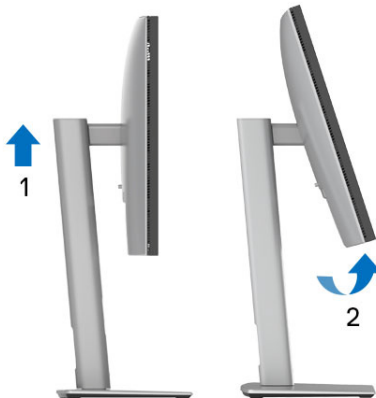

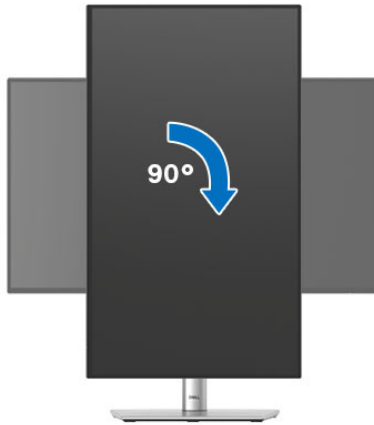

Rotate clockwise

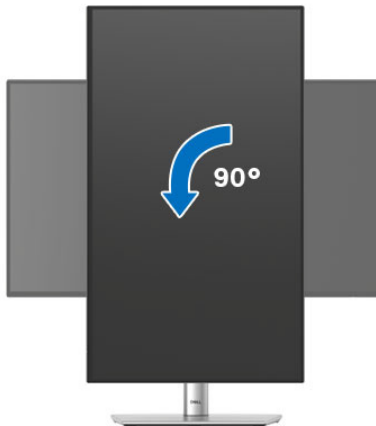

Rotate counterclockwise



-  **NOTE:** To use the Display Rotation function (Landscape versus Portrait view) with your Dell computer, you require an updated graphics driver that is not included with this monitor. To download the graphics driver, go to www.dell.com/support and see the Download section for Video Drivers for latest driver updates.
-  **NOTE:** When in the Portrait View Mode, you may experience performance degradation in graphic-intensive applications (3D Gaming and etc.).



Adjusting the rotation display settings of your system

After you have rotated your monitor, you need to complete the procedure below to adjust the Rotation Display Settings of your system.

 **NOTE: If you are using the monitor with a non-Dell computer, you need to go the graphics driver website or your computer manufacturer website for information on rotating the 'contents' on your display.**

To adjust the Rotation Display Settings:

1. Right-click on the desktop and click **Properties**.
2. Select the **Settings** tab and click **Advanced**.
3. If you have an ATI graphics card, select the **Rotation** tab and set the preferred rotation.
4. If you have an NVIDIA graphics card, click the **NVIDIA** tab, in the left-hand column select **NVRotate**, and then select the preferred rotation.
5. If you have an Intel graphics card, select the **Intel** graphics tab, click **Graphic Properties**, select the **Rotation** tab, and then set the preferred rotation.

 **NOTE: If you do not see the rotation option or it is not working correctly, go to www.dell.com/support and download the latest driver for your graphics card.**

 **NOTE: You can also refer to the [Rotation](#) function on your OSD to rotate your display.**



Connecting your monitor

⚠ WARNING: Before you begin any of the procedures in this section, follow the [Safety instructions](#).

✍ NOTE: Dell monitors are designed to work optimally with the Dell-supplied cables inside the box. Dell does not guarantee the video quality and performance if non-Dell cables are used.

✍ NOTE: Route the cables through the cable-management slot before connecting them.

✍ NOTE: Do not connect all cables to the computer at the same time.

✍ NOTE: The images are for the purpose of illustration only. The appearance of the computer may vary.

To connect your monitor to the computer:

1. Turn off your computer and disconnect the power cable.
2. Connect the DisplayPort or USB Type-C cable from your monitor to the computer.

Connecting the DisplayPort (DisplayPort to DisplayPort) cable

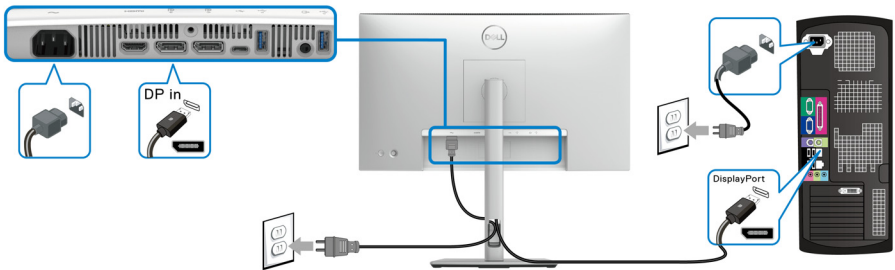

Connecting the USB Type-C cable (applicable for U2424HE only)

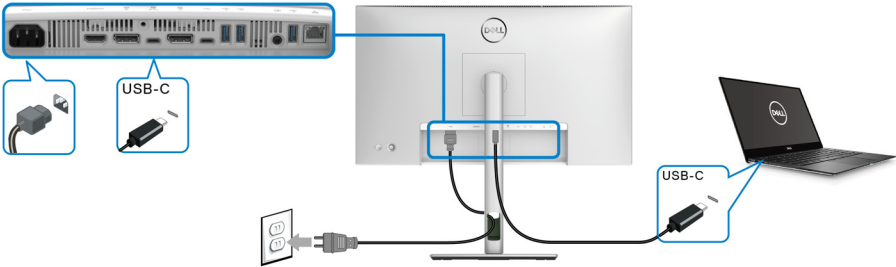

NOTE: Use the USB Type-C cable shipped with monitor only.

- This port supports DisplayPort Alternate Mode (DP1.4 standard only).
- The USB Type-C power delivery compliant port (PD Version 3.0) delivers up to 90 W of power.
- If your notebook requires more than 90 W to operate and the battery is drained, it may not be powered up or charged with the USB PD port of this monitor.

Connecting the monitor for DP Multi-Stream Transport (MST) function

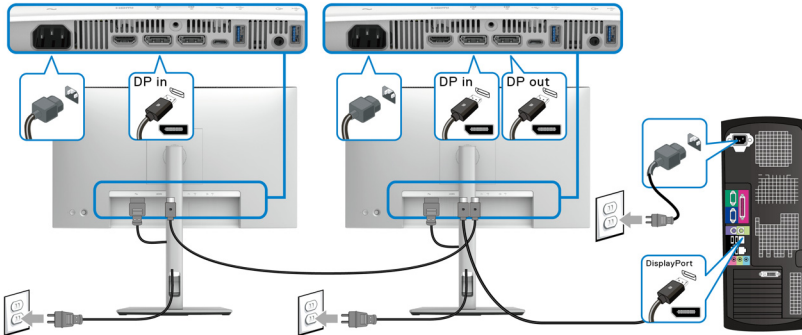

NOTE: This monitor supports the DP MST feature. To make use of this feature, your computer Graphics Card must be certified to at least support DP1.2 with MST option.

NOTE: Remove the rubber plug when using DP out connector.



Connecting the Monitor for USB Type-C Multi-Stream Transport (MST) Function (applicable for U2424HE only)

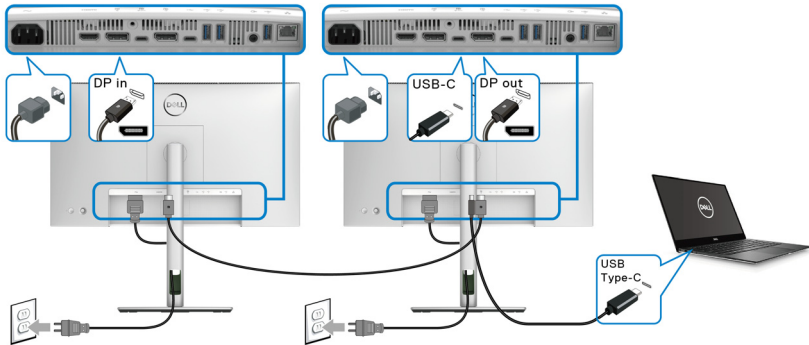

- NOTE:** The maximum number of supported monitors through MST is subjected to the bandwidth of the USB-C source.
- NOTE:** Remove the rubber plug when using USB Type-C upstream connector.
- NOTE:** Remove the rubber plug when using DP out connector.

Connecting the monitor for RJ45 cable (optional) (applicable for U2424HE only)

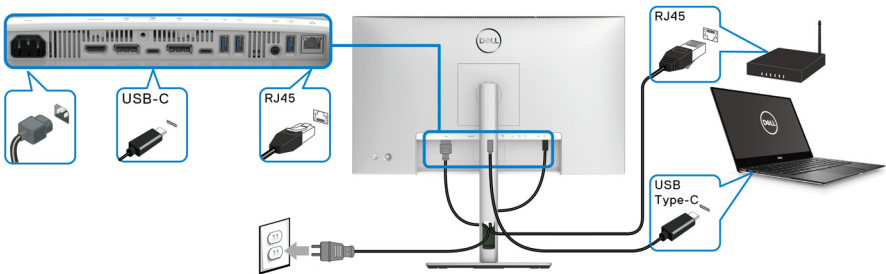

- NOTE:** RJ45 cable is non in-box standard accessory.



Dell Power Button Sync (DPBS) (applicable for U2424HE only)

Your monitor is designed with Dell Power Button Sync (DPBS) feature to allow you to control PC system power state from the monitor power button. This feature is only supported with Dell platform which has built-in DPBS function, and is only supported over USB-C interface.

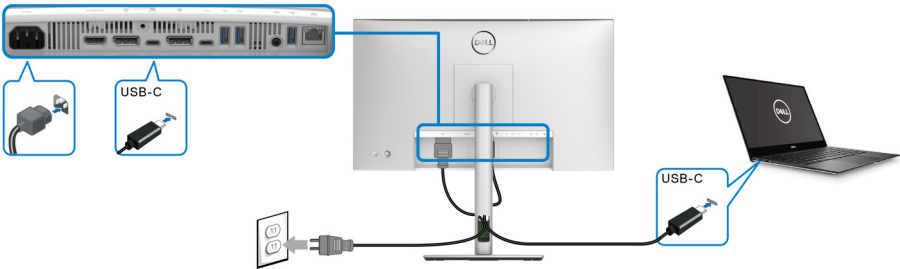

To make sure the DPBS function works for the first time, perform the following steps on the DPBS supported platform in the **Control Panel** first.

NOTE: DPBS only supports the USB Type-C upstream port with  icon.

1. Go to **Control Panel**.

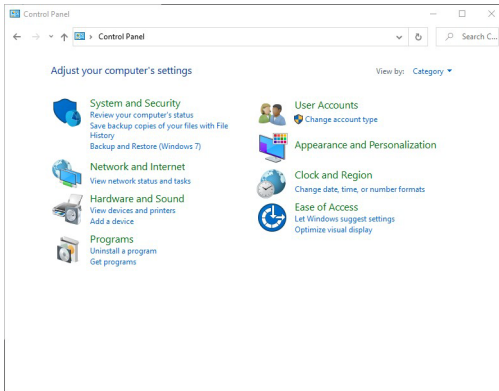

2. Select **Hardware and Sound**, followed by **Power Options**.

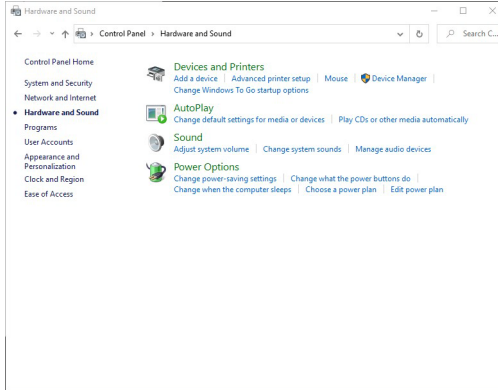

3. Go to **System Settings**.

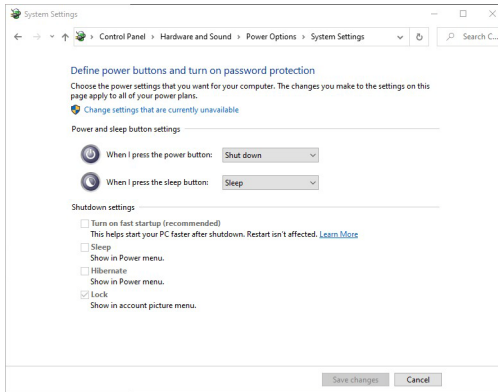

4. In the **When I press the power button** drop-down menu, you can select the preferred options.

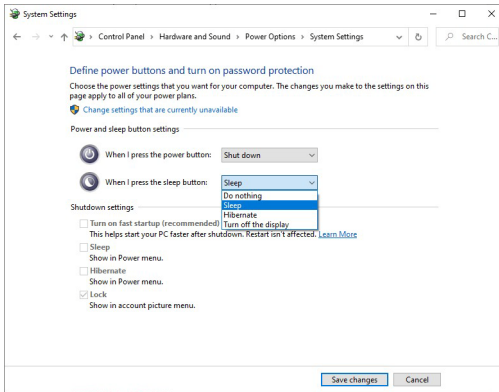
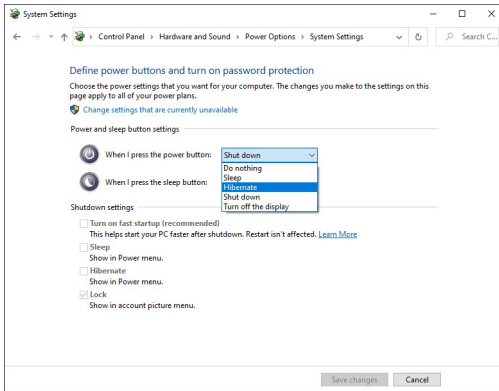

NOTE: Do not select “Do nothing”, otherwise monitor power button will not be able to sync with PC system power state.



Connecting the monitor for DPBS for the first time

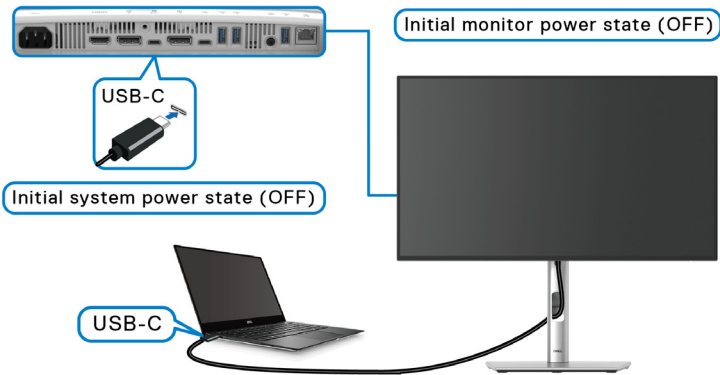

For the first time setting up the DPBS function:

1. Make sure both the PC and the monitor are OFF.
2. Press the monitor power button to turn ON the monitor.
3. Connect the USB Type-C cable from the PC to the monitor.
4. Both the monitor and PC will turn ON normally. If not, press either the monitor power button or PC power button to boot up the system.

 **NOTE: Ensure that Dell Power Button Sync is set to On. See [Dell Power Button Sync \(applicable for U2424HE only\)](#).**



Using DPBS function

When you connect the USB Type-C cable, the Monitor/PC state is as follows:

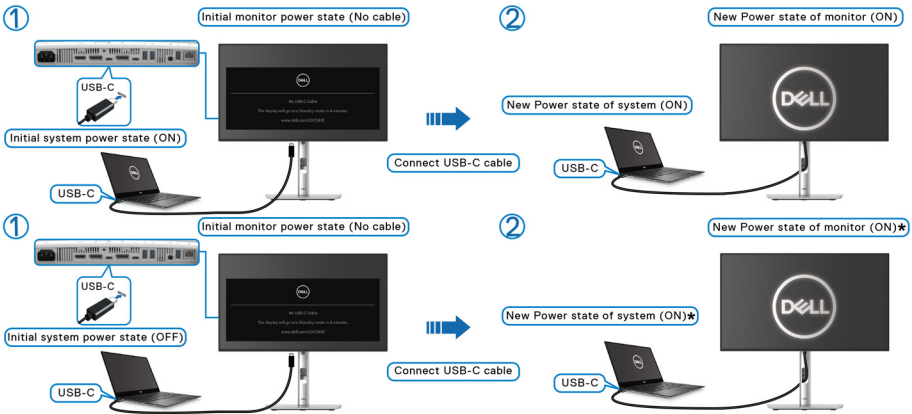

***Not all Dell PC systems support to wake up the platform through the monitor.**

***Upon USB Type-C cable connection, mouse movement or keyboard press might be required to wake the system/monitor up from sleep or hibernate.**

When you press the monitor power button or PC power button, the Monitor/PC state is as follows:

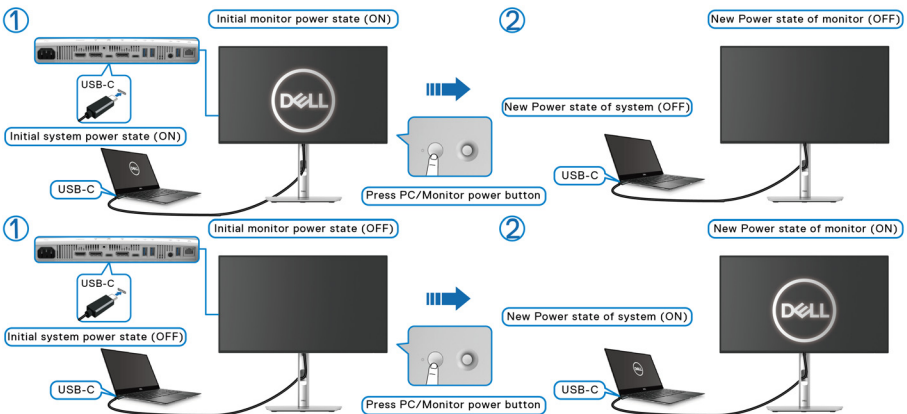

NOTE: You can enable or disable the power button sync function using the OSD. See [Dell Power Button Sync \(applicable for U2424HE only\)](#).

- When the monitor and the PC power state are both ON, **press and hold the monitor power button for 4 seconds**, the screen prompt will ask if you would like to shut down the PC.

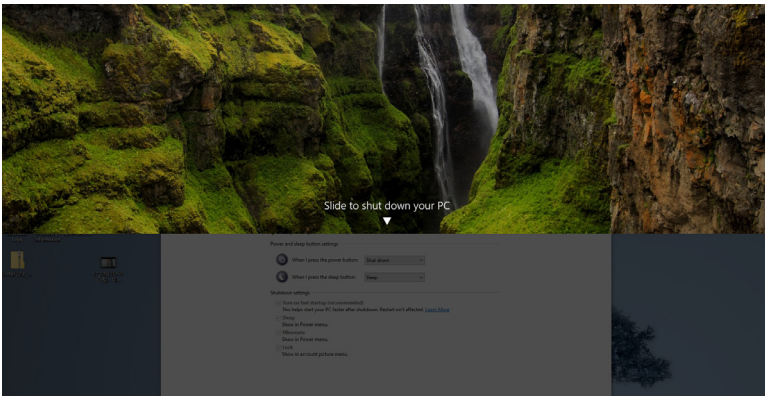
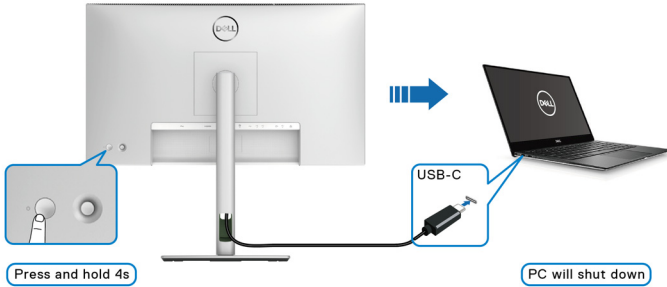

- When the monitor and the PC power state are both ON, **press and hold the monitor power button for 10 seconds**, the PC will shut down.

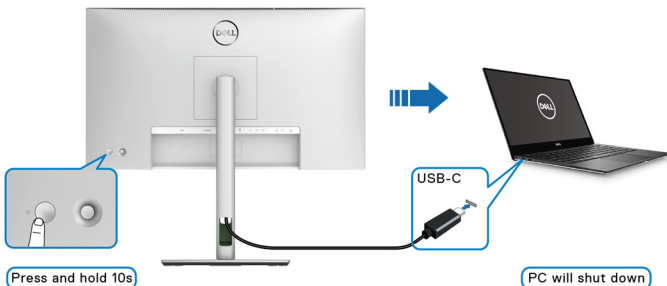

Connecting the monitor for USB-C Multi-Stream Transport (MST) function

A PC is connected to two monitors in an initially OFF power state, and the PC system power state is in sync with Monitor 1 power button. When you press Monitor 1 or PC power button, both Monitor 1 and PC are turned ON. Meanwhile, Monitor 2 remains OFF. You need to manually press the power button on Monitor 2 to turn it ON.

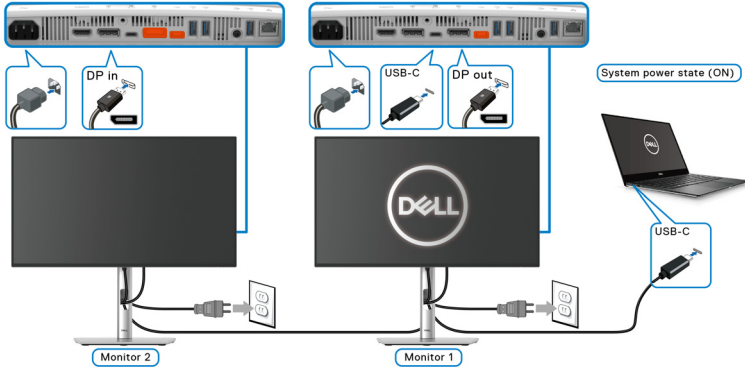

Similarly, a PC is connected to two monitors in an initially ON power state, and the PC system power state is in sync with Monitor 1 power button. When you press Monitor 1 or PC power button, both Monitor 1 and PC are turned OFF. Meanwhile, Monitor 2 remains in Standby mode. You need to manually press the power button on Monitor 2 to turn it OFF.

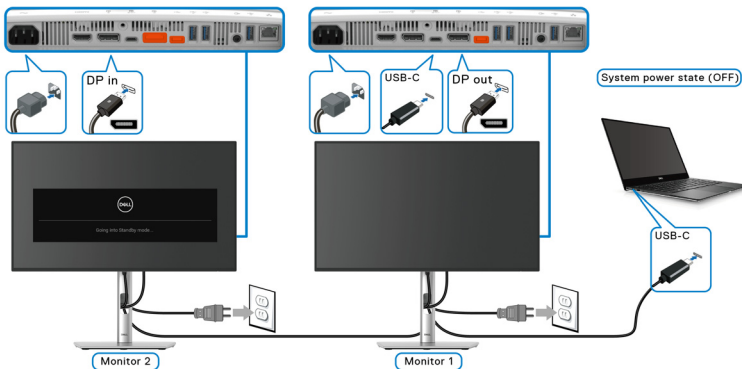

Connecting the monitor for USB-C

If the Dell PC* has two USB Type-C ports, the power state of each connected monitor will sync with the PC.

For example, when the PC and two monitors are in an initial ON power state, pressing the power button on Monitor 1 or Monitor 2 will turn OFF the PC, Monitor 1, and Monitor 2.

*Ensure to check the Dell PC for DPBS supportability.

NOTE: DPBS only supports the USB Type-C upstream port with  icon.

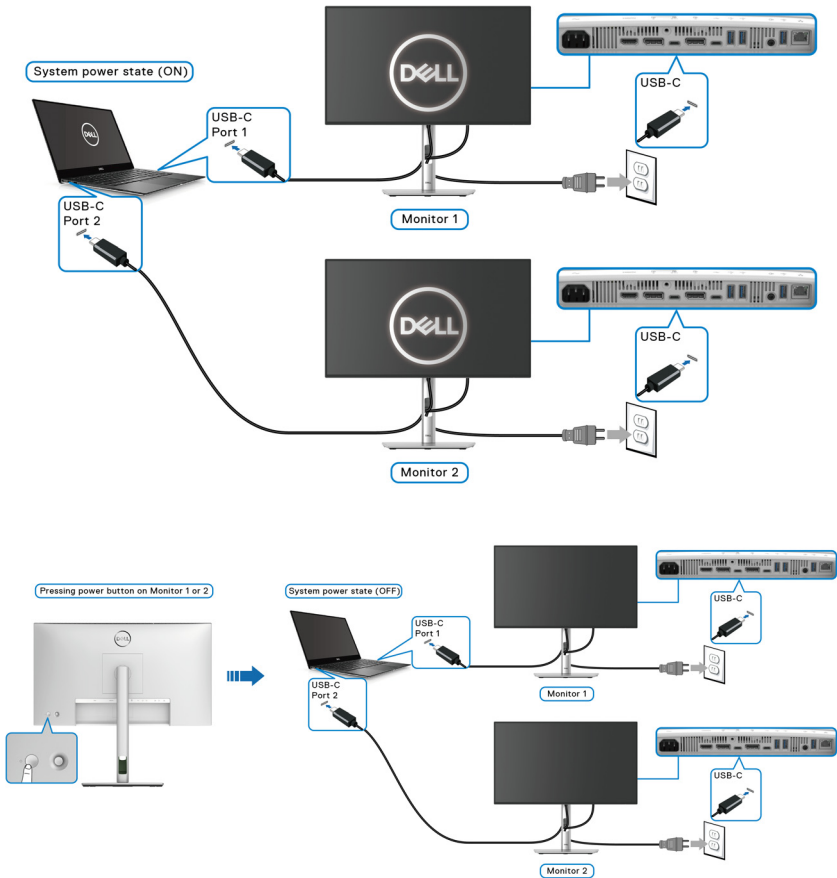

Ensure that **Dell Power Button Sync** is set to ON (see [Dell Power Button Sync \(applicable for U2424HE only\)](#)). When the PC and two monitors are in an initial OFF power state, pressing the power button on Monitor 1 or Monitor 2 will turn ON the PC, Monitor 1, and Monitor 2.

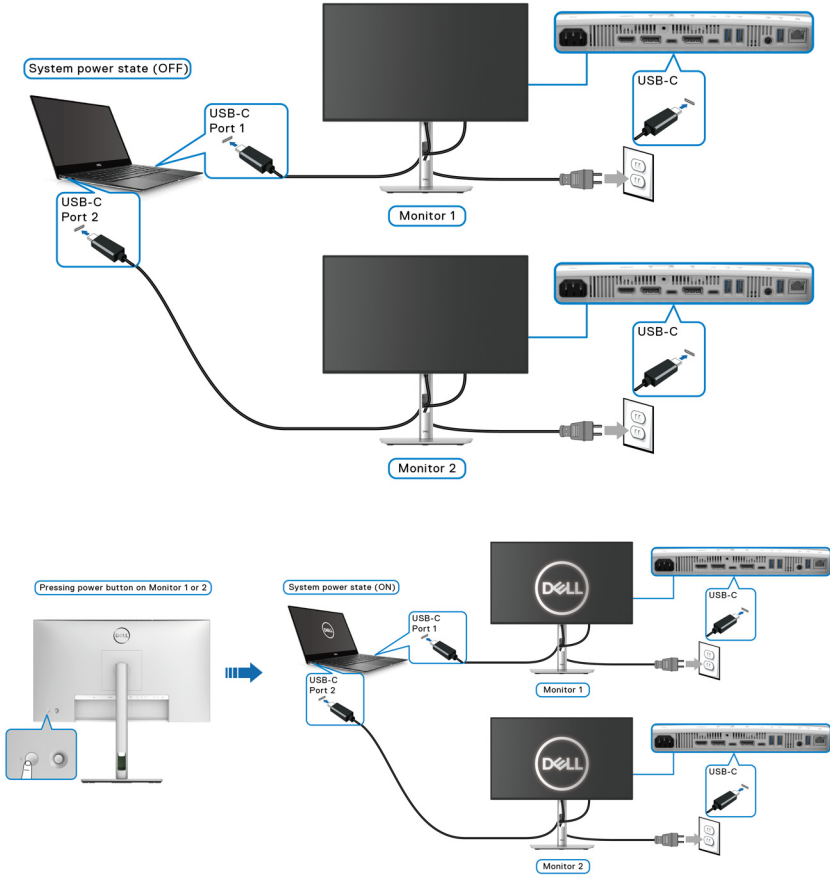

Securing your monitor using Kensington lock (optional)

The security-lock slot is located at the bottom of the monitor (see [Security-lock slot](#)). Secure your monitor to a table using the Kensington security lock.

For more information on using the Kensington lock (sold separately), see the documentation that is shipped with the lock.

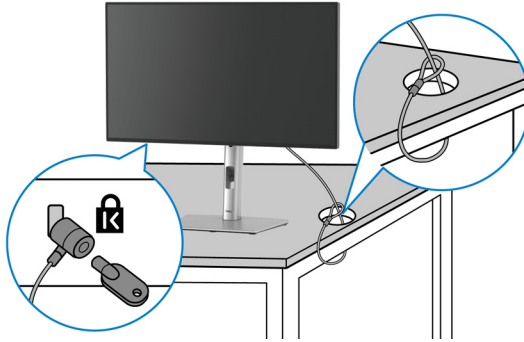

NOTE: The image is for the purpose of illustration only. The appearance of the lock may vary.

Removing the monitor stand

NOTE: To prevent scratches on the LCD screen when removing the stand, ensure that the monitor is placed on a soft surface and handle it carefully.

NOTE: The following steps are specifically for attaching the stand that is shipped with your monitor. If you are removing a stand that you purchased from any other source, follow the setup instructions that are included with the stand.

To remove the stand:

1. Place the monitor on a soft cloth or cushion.
2. Press and hold the stand release button at the back of the display.



3. Lift the stand assembly up and away from the monitor.

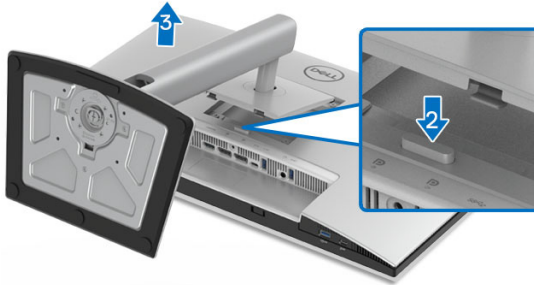

VESA wall mounting (optional)

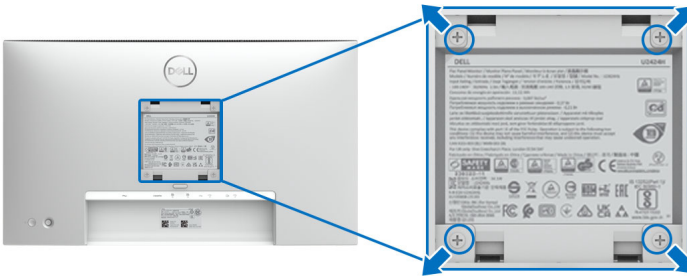

NOTE: Use M4 x 10 mm screws to connect the monitor to the wall-mounting kit.

Refer to the instructions that come with the VESA-compatible wall mounting kit.

1. Place the monitor panel on a soft cloth or cushion on a stable flat table.
2. Remove the stand. (See [Removing the monitor stand](#))
3. Use a Phillips crosshead screwdriver to remove the four screws securing the plastic cover.
4. Attach the mounting bracket from the wall mounting kit to the monitor.
5. Mount the monitor on the wall. For more information, see the documentation that shipped with the wall mounting kit.

NOTE: For use only with UL or CSA or GS-listed wall mount bracket with minimum weight or load bearing capacity of 14.08 kg (for U2424H/ U2424H WOST), or 15.92 kg (for U2424HE).



Operating the monitor

Turn on the monitor

Press the power button to turn on the monitor.

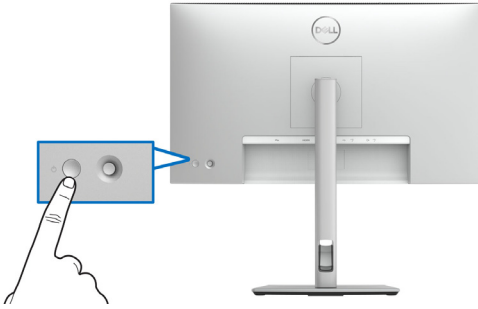

Using the joystick control

Use the joystick control on the rear of the monitor to make On-Screen Display (OSD) adjustments.

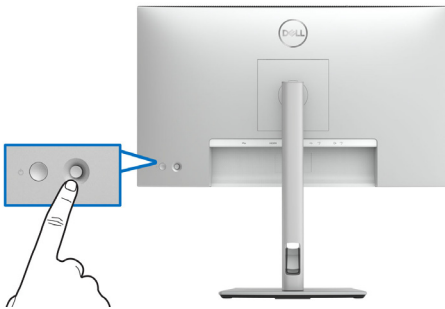

1. Press the joystick button to launch the Menu Launcher.
2. Move the joystick up/down/left/right to toggle between options.
3. Press the joystick button again to confirm the selection.

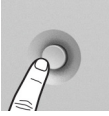
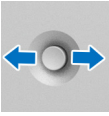
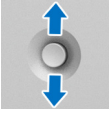

Joystick functions

Function	Description
	<ul style="list-style-type: none">• When the OSD menu is on, press the button to confirm the selection or save the settings.• When the OSD menu is off, press the button to launch the OSD main menu. See Accessing the menu system.
	<ul style="list-style-type: none">• For 2-way (right and left) directional navigation.• Move right to enter the submenu.• Move left to exit from the submenu.
	<ul style="list-style-type: none">• For 2-way (up and down) directional navigation.• Toggles between the menu items.• Increases (up) or decreases (down) the parameters of selected menu item.

Using the Main Menu

Accessing the Menu Launcher

When you press the joystick button, the OSD status bar appears to let you know the current settings of some OSD functions.

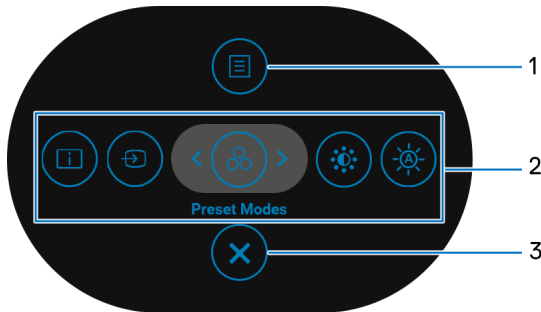







Menu Launcher



The following table describes the Menu Launcher functions:

Menu Launcher details

Label	Icon	Description
1		To launch the On-Screen Display (OSD) main menu. See Accessing the menu system .
	Menu	
2	    	<p>When you move the joystick to the left or right to toggle between the shortcut functions, the selected item will be highlighted and shifted to the center position. Press the joystick to enter its submenu.</p> <ul style="list-style-type: none">• Display Info: Displays the monitor's current status.• Input Source: To choose an input source from the list of video signals that may be connected to your monitor.• Preset Modes: To choose a preferred color mode from the list of preset modes.• Brightness/Contrast: To access the adjustment sliders of brightness and contrast.• Auto Brightness: To enable or disable the auto brightness function. <p>NOTE: You can set your preferred shortcut keys. See Personalize for details.</p>
	Shortcut functions	
3		To exit the Menu Launcher.
	Exit	

NOTE: After you change the settings, press the joystick to save the changes before you proceed to another function or exit.



Using the navigation keys

When the OSD main menu is active, move the joystick to configure the settings, following the navigation keys displayed below the OSD.

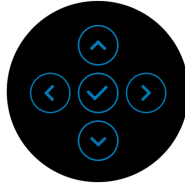

After you change the settings, press the joystick to save the changes before proceeding to another menu or exit the OSD menu.

 **NOTE: To exit the current menu item and return to the previous menu, move the joystick to the left until you exit.**

Using the On-Screen Display (OSD) menu

Accessing the menu system

 **NOTE: After you change the settings, press the joystick to save the changes before proceeding to another menu or exit the OSD menu.**

Icon	Menu and Submenus	Description
	Brightness/Contrast	Adjusts the Brightness, Contrast, Auto Brightness, Auto Brightness Range Level, Auto Color Temp. , and Primary Monitor for Sync functions.

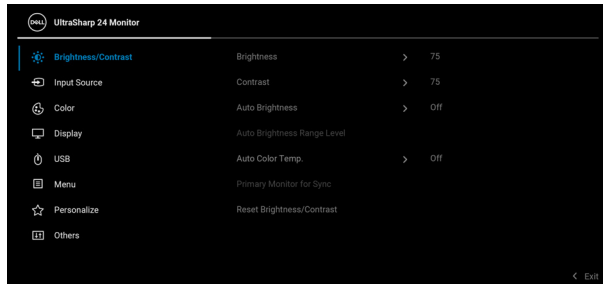

**Primary
Monitor for
Sync**

When either **Auto Brightness** or **Auto Color Temp.** is turned on and multiple Dell monitors that support this function are connected through **MST**, the monitors will adjust their brightness or RGB settings according to the ambient light condition detected by the primary monitor.

NOTE: The selected monitor in Dell Display Manager (DDM) is the primary monitor. To change the primary monitor, select the preferred monitor in DDM. Refer to the DDM user guide for details.

NOTE: When **Auto Brightness** and **Auto Color Temp.** are both disabled, this function is not available.

NOTE: If the primary or secondary monitor breaks off from the MST, it also breaks off from the monitor sync.

**Reset
Brightness/
Contrast**

Press the joystick to reset all settings under the **Brightness/Contrast** menu to the factory preset values.





Input Source

Selects between the different video signals that may be connected to your monitor.

For U2424H/U2424H WOST:



For U2424HE:



USB-C 90W (applicable for U2424HE only)	Select the USB-C 90W input when you are using the USB Type-C connector. Press the joystick to confirm the selection.
DP	Select the DP input when you are using the DisplayPort (DP) connector. Press the joystick to confirm the selection.
HDMI	Select the HDMI input when you are using the HDMI connector. Press the joystick to confirm the selection.
Auto Select	Allows you to scan for available input sources. The default is on.
Auto Select for USB-C (applicable for U2424HE only)	<p>Allows you to set Auto Select for USB-C to:</p> <ul style="list-style-type: none"> • Prompt for Multiple Inputs: Always displays the “Switch to USB-C Video Input” message for you to choose whether to switch or not. • Yes: Always switches to USB-C video input (without asking) when the USB Type-C cable is connected. • No: Never automatically switches to USB-C video input when the USB Type-C cable is connected. <p>NOTE: Auto Select for USB-C is available only when Auto Select is on.</p>
Rename Inputs	<p>Allows you to select the input name for the selected input source. The options are PC, PC 1, PC 2, Laptop, Laptop 1, and Laptop 2.</p> <p>NOTE: Input names in warning messages and Display Info will not be changed.</p>
Reset Input Source	Press the joystick to reset all settings under the Input Source menu to the factory preset values.





Color

Adjusts the color setting mode.



Preset Modes

Allows you to choose from a list of preset color modes.

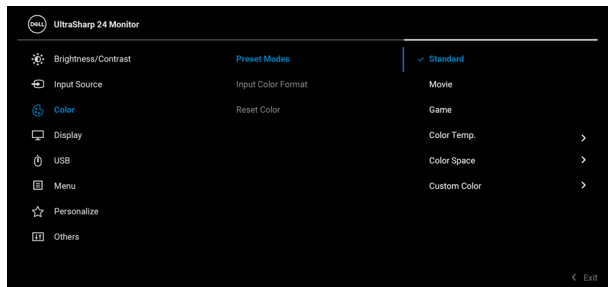

- **Standard:** Loads the monitor's default color settings. This is the default preset mode.
- **Movie:** Loads color settings ideal for movies.
- **Game:** Loads color settings ideal for most gaming applications.
- **Color Temp.:** Allows you to select the color temperature: 5000K, 5700K, 6500K, 7500K, 9300K, and 10000K. Press the joystick to confirm the selection.



Preset Modes

- **Color Space:** Allows you to select the color space **sRGB** or **BT.709**.
- **Custom Color:** Allows you to manually adjust the color settings.

Toggle the joystick **up** or **down** to adjust the RGB color values and create your own preset color mode.

Input Color Format

Allows you to set the video input mode to:

- **RGB:** Select this option if your monitor is connected to a computer (or media player) using the USB Type-C (applicable for U2424HE only), DisplayPort, or HDMI cable.
- **YCbCr:** Select this option if your media player supports only YCbCr output.

Press the joystick to confirm the selection.



Hue

Shifts the color of the video image to green or purple. This is used to adjust the desired flesh tone color. Toggle the joystick **up** or **down** to adjust the hue from '0' to '100'.

NOTE: Hue adjustment is available only when you select **Movie** or **Game** preset mode.



Saturation

Adjusts the color saturation of the video image. Toggle the joystick **up** or **down** to adjust the saturation from '0' to '100'.

NOTE: Saturation adjustment is available only when you select **Movie** or **Game** preset mode.

Reset Color

Press the joystick to reset all settings under the **Color** menu to the factory preset values.

Display

Use the **Display** menu to adjust images.

For U2424H/U2424H WOST:



For U2424HE:

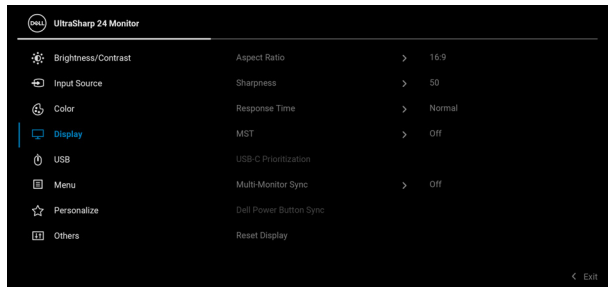

Aspect Ratio

Adjusts the image ratio to **16:9**, **Auto Resize**, **4:3**, or **1:1**.



Sharpness This feature can make the image look sharper or softer.
Toggle the joystick **up** or **down** to adjust the sharpness from '0' to '100'.

Response Time Allows you to set the **Response Time** to **Normal** or **Fast**.

MST DP Multi Stream Transport, select **On** to enable MST (DP Out), select **Off** to disable the MST function. See [Connecting the monitor for DP Multi-Stream Transport \(MST\) function](#) and [Connecting the Monitor for USB Type-C Multi-Stream Transport \(MST\) Function \(applicable for U2424HE only\)](#) for details.

NOTE: When DP or USB Type-C cable (applicable for U2424HE only) and DP downstream cable are connected, the OSD sets **MST** to **On** automatically. This action will only be done once after **Factory Reset** or **Display Reset**.



USB-C Prioritization (applicable for U2424HE only)

Allows you to specify the priority to transfer the data with high resolution (**High Resolution**) or high speed (**High Data Speed**) when using the USB Type-C port/DisplayPort. If the current platform is DP 1.4 (HBR3), use **High Data Speed** to access full video performance with high data speed. If the current platform is DP 1.2 (HBR2) or below, select **High Resolution** for accessing full video performance with data and network speed drop.

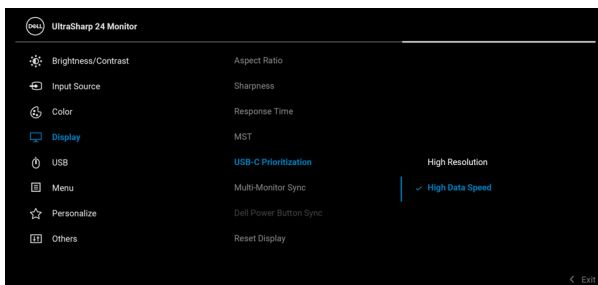

Multi-Monitor Sync

Allows multiple monitors that are Daisy Chained through DP to synchronize following OSD settings in the background: **Brightness, Contrast, Auto Brightness, Auto Color Temp., Preset Modes, Color Temp., Custom Color, Hue, Saturation, Response Time, and Sharpness.** See [Multi-Monitor Sync \(MMS\)](#) for details.

Dell Power Button Sync (applicable for U2424HE only)

Turns the Dell Power Button Sync feature on or off. When **Off** is selected, power button sync function will be disabled.

NOTE: When **Off** is selected, the Wake-on-Connect function will remain active. When USB-C connection is detected, the computer will be turned on.

Reset Display

Press the joystick to reset all settings under the **Display** menu to the factory preset values.





USB (applicable for U2424HE only)

Allows you to assign the USB upstream port for the input signals (DP, HDMI), thus the monitor's USB downstream port can be used by the current input signals when you connect a computer to either one of the upstream ports.

When you use only one upstream port, the connected upstream port is active.

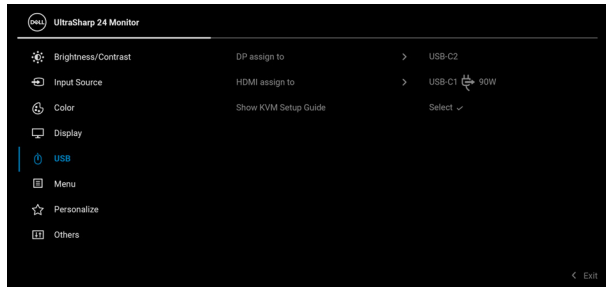

NOTE: To prevent data damage or loss, before changing USB upstream ports, make sure that no USB storage devices are in use by the computer connected to the monitor's USB downstream port.

Show KVM Setup Guide (applicable for U2424HE only)

Select this option and follow steps if you want to connect multiple computers to the monitor and use one setup of keyboard and mouse.





Menu

Select this option to adjust the settings of the OSD, such as, the languages of the OSD, the amount of time the menu remains on screen, and so on.

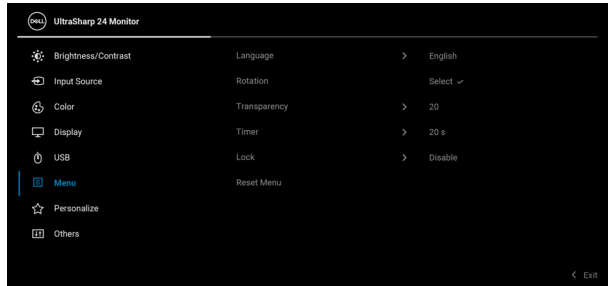

Language

Sets the OSD display to one of the eight languages (English, Spanish, French, German, Brazilian Portuguese, Russian, Simplified Chinese, or Japanese).

Rotation

Press the joystick to rotate the OSD and the screen by 0/90/180/270 degrees.

You can adjust the menu according to your display rotation.

Transparency

Select this option to change the menu transparency by toggling the joystick **up** or **down** (Range: 0 - 100).

Timer

Sets the length of time the OSD will remain active after the last time you pressed a button.

Toggle the joystick **up** or **down** to adjust the slider in 1 second increments, from 5 to 60 seconds.



Lock

With the control buttons on the monitor locked, you can prevent people from accessing the controls. It also prevents accidental activation in multiple monitors side-by-side setup.

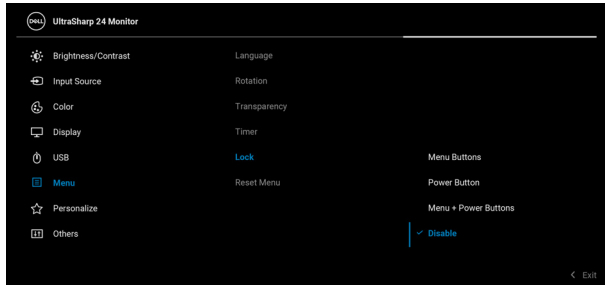

- **Menu Buttons:** All joystick functions are locked and not accessible by the user.
- **Power Button:** Only the **Power Button** is locked and not accessible by the user.
- **Menu + Power Buttons:** Both the joystick and the **Power Button** are locked and not accessible by the user.

The default setting is **Disable**.

Alternative Lock Method [for Menu/function buttons]: You can also press and hold the joystick to the **up** or **down** or **left** or **right** for 4 seconds to set the lock options.

NOTE: To unlock the button(s), press and hold the joystick to the **up** or **down** or **left** or **right** for 4 seconds.

Reset Menu

Press the joystick to reset all settings under the **Menu** menu to the factory preset values.





Personalize

For U2424H/U2424H WOST:

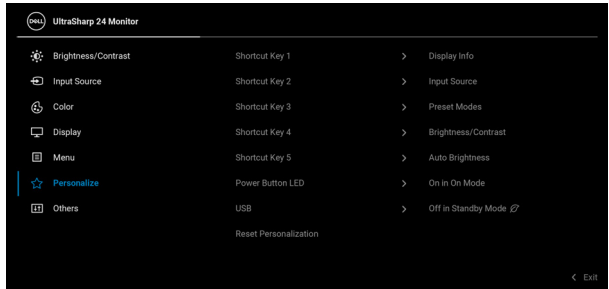

For U2424HE:

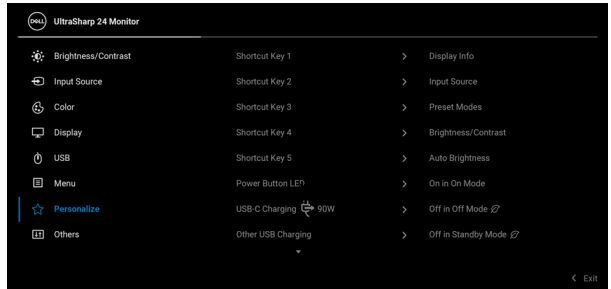

Shortcut Key 1

Shortcut Key 2

Shortcut Key 3

Shortcut Key 4

Shortcut Key 5

Power Button LED

Allows you to choose a feature from **Preset Modes**, **Brightness/Contrast**, **Auto Brightness**, **Auto Color Temp.**, **Input Source**, **Aspect Ratio**, **Rotation**, or **Display Info** and set it as a shortcut key.

Allows you to set the power LED indicator on or off to save energy.



<p>USB (applicable for U2424H/ U2424H WOST only)</p>	<p>Allows you to enable or disable USB-A and USB Type-C Downstream Ports charging function during monitor standby mode.</p>
<p>USB-C Charging 90W (applicable for U2424HE only)</p>	<p>Allows you to enable or disable the Always On USB-C Charging function during monitor Off mode.</p> <p>When this function is enabled, you will be able to charge your notebook or mobile devices through the USB Type-C cable even when the monitor is powered off.</p>
<p>Other USB Charging (applicable for U2424HE only)</p>	<p>Allows you to enable or disable USB-A and USB Type-C Downstream Ports charging function during monitor standby mode.</p> <p>When this function is enabled, you will be able to charge your mobile devices through the USB-A cable even when the monitor is powered off.</p> <p>NOTE: This option is only available when the USB Type-C (Upstream Port) cable is unplugged. If the USB Type-C cable is connected, Other USB Charging follows the USB host power status and the option is not accessible.</p>
<p>Reset Personalization</p>	<p>Press the joystick to reset all settings under the Personalize menu to the factory preset values.</p>





Others

Select this option to adjust the OSD settings, such as **DDC/CI**, **LCD Conditioning**, and so on.

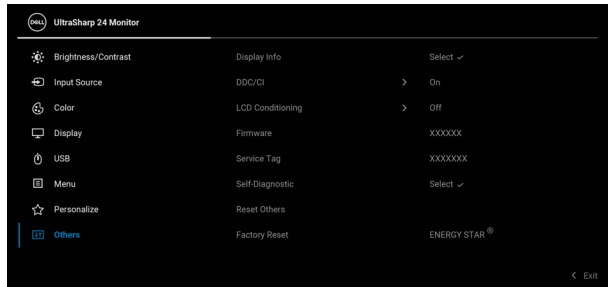

Display Info

Press the joystick to display current monitor settings.

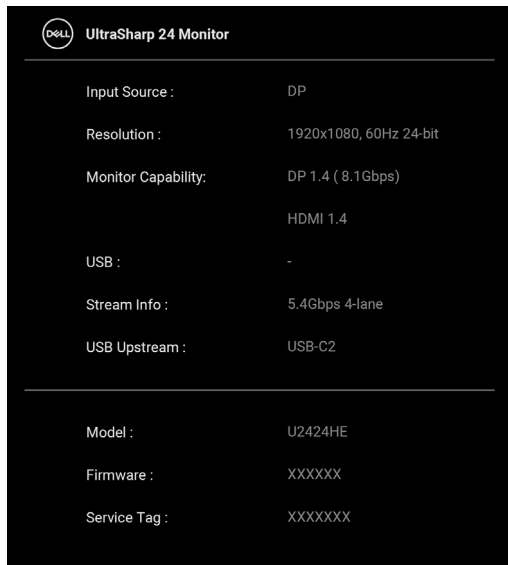

DDC/CI

DDC/CI (Display Data Channel/Command Interface) allows your monitor parameters (brightness, color balance, and etc.) to be adjustable using the software on your computer. You can disable this feature by selecting **Off**. Enable this feature for best user experience and optimum performance of your monitor.

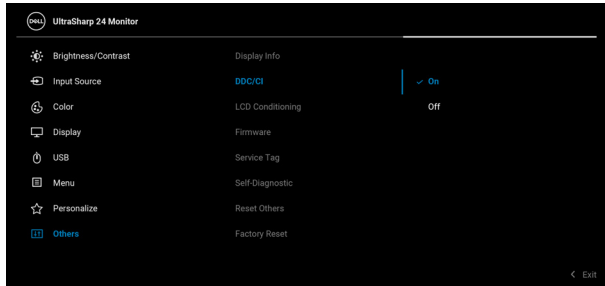

LCD Conditioning

Helps reduce minor cases of image retention. Depending on the degree of image retention, the program may take some time to run. You can enable this feature by selecting **On**.

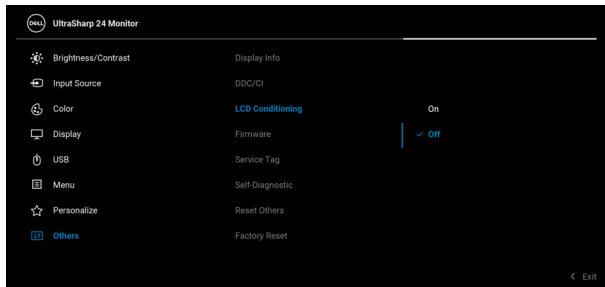

Firmware	Displays the firmware version of your monitor.
Service Tag	Displays the service tag of your monitor. This string is required when you look for phone support, check your warranty status, update drivers on Dell website, etc.
Self-Diagnostic	<p>Press the joystick to initiate the self-diagnostic process.</p> <ol style="list-style-type: none"> 1. When initiated, a gray screen appears. 2. Carefully inspect the screen for abnormalities. 3. Press the joystick. The color of the screen changes to red. 4. Inspect the display for any abnormalities. 5. Repeat steps 3 and 4 to inspect the display in green, blue, black, white and text screens. <p>The test is complete when the text screen appears. To exit, press the joystick again.</p>
Reset Others	Press the joystick to reset all settings under the Others menu to the factory preset values.
Factory Reset	Restore all preset values to the factory default settings. These are also the settings for ENERGY STAR® tests.

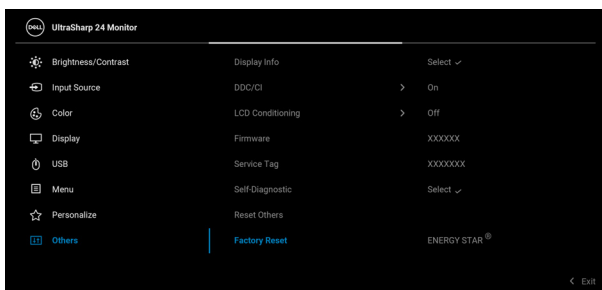

OSD messages

Initial setup

When **Factory Reset** is selected, the following message appears:

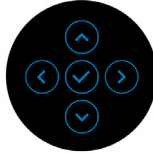

When **Yes** is selected, the following message appears.

For U2424H/U2424H WOST:

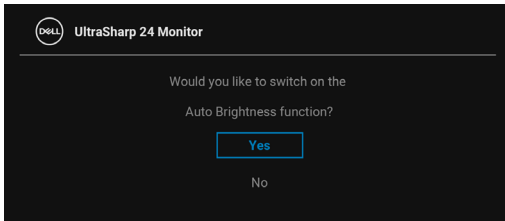
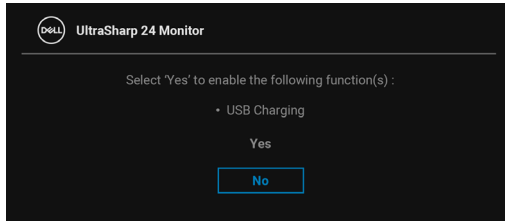

For U2424HE:

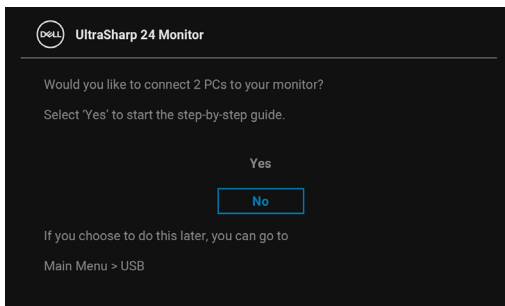
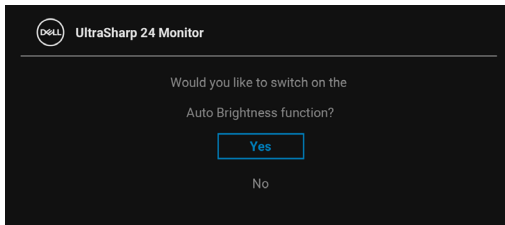
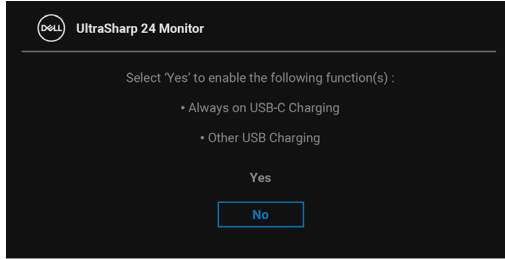

OSD warning messages

When the monitor does not support a particular resolution mode, you will see the following message:

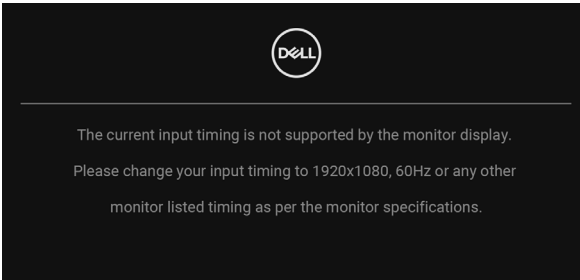

This means that the monitor cannot synchronize with the signal that it is receiving from the computer. See [Monitor specifications](#) for the Horizontal and Vertical frequency ranges addressable by this monitor. Recommended mode is 1920 x 1080. You will see the following message before the **DDC/CI** function is disabled:

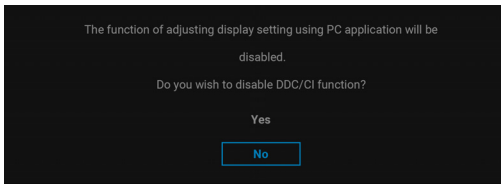

When you adjust the **Brightness** level for the first time, the following message appears:

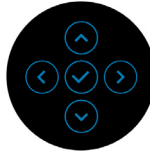
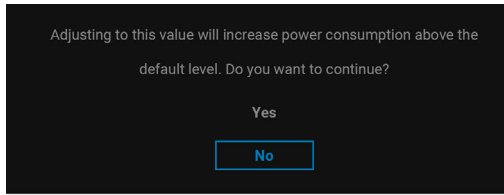

 **NOTE: If Yes is selected, the message will not appear next time you intend to change the Brightness setting.**

When **Auto Brightness** is enabled, if you adjust the brightness level, the following message appears:

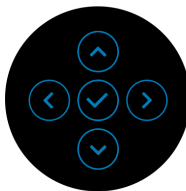
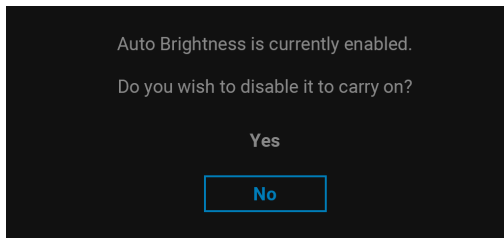

 **NOTE: If Yes is selected, Auto Brightness will be disabled.**



When you change the default setting of power saving features for the first time, such as **USB-C Charging & 90W (applicable for U2424HE only)**, **Other USB Charging (applicable for U2424HE only)**, or **USB (applicable for U2424H/U2424H WOST only)**, the following message appears:

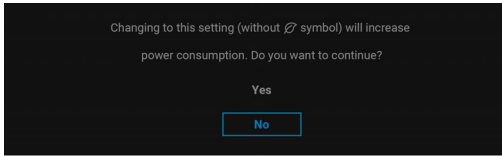

NOTE: If you select Yes for any one of the features mentioned above, the message will not appear next time you intend to change the settings of these features. When you perform a factory reset, the message will appear again.

You will see the following message before the **Lock** function is activated:

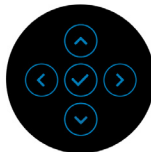
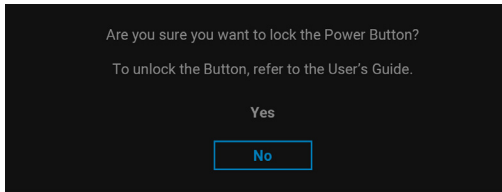

NOTE: The message may be slightly different according to the selected settings.



When the monitor goes into Standby mode, the following message appears:

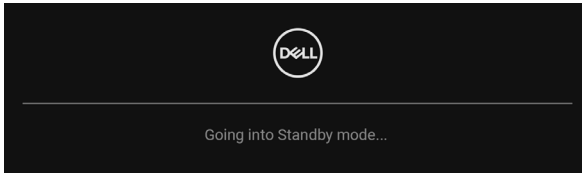

Activate the computer and wake up the monitor to gain access to the [OSD](#).

The OSD functions only in the normal operation mode. If you press any button other than the **Power Button** during the Standby mode, the following message will appear depending on the selected input:

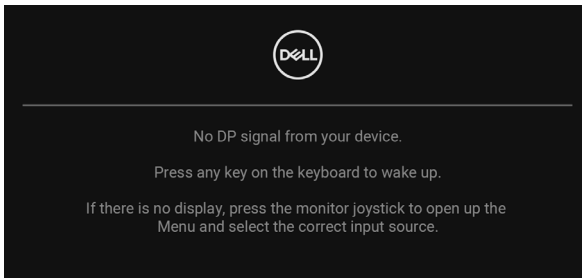

 **NOTE: The message may be slightly different according to the connected input signal.**

Activate the computer and the monitor to gain access to the [OSD](#).

If either USB Type-C (applicable for U2424HE only), DisplayPort, or HDMI input is selected and the corresponding cable is not connected, a floating dialog box as shown below appears.

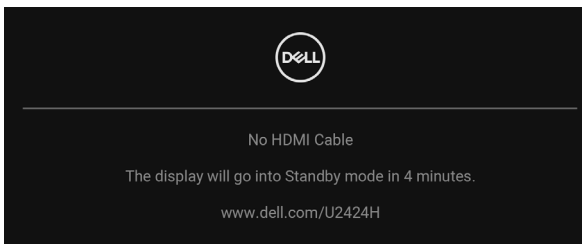

 **NOTE: The message may be slightly different according to the connected input signal.**



For U2424HE, when the monitor is under DP/HDMI input and a USB Type-C cable is connected to a notebook that supports DP Alternate Mode, if **Auto Select for USB-C (applicable for U2424HE only)** is enabled, the following message appears:

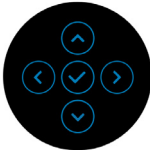
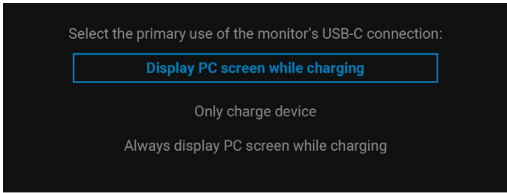

See [Troubleshooting](#) for more information.



Setting the KVM switch (applicable for U2424HE only)

The built-in KVM switch allows you to control up to 2 computers from a single set of keyboard and mouse connected to the monitor.

- a. When connecting **HDMI + USB-C2** to computer 1 and **DP + USB-C1** to computer 2:

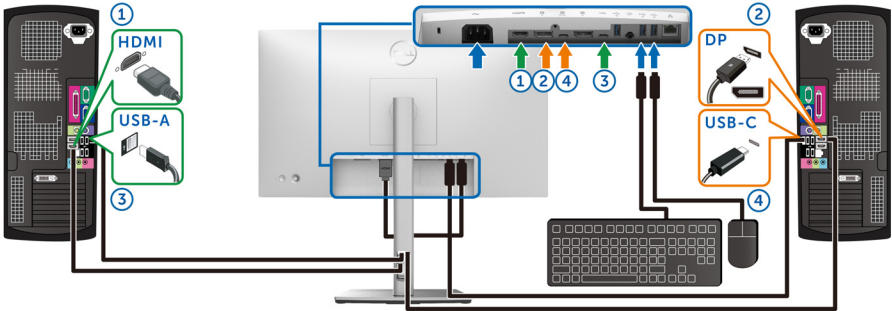

NOTE: The USB-C connection currently supports only data transfer.

Ensure that **USB** for **HDMI** is assigned to **USB-C2** and **DP** is assigned to **USB-C1**.

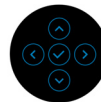

- b. When connecting **HDMI + USB-C2** to computer 1 and **USB-C 90W** to computer 2:

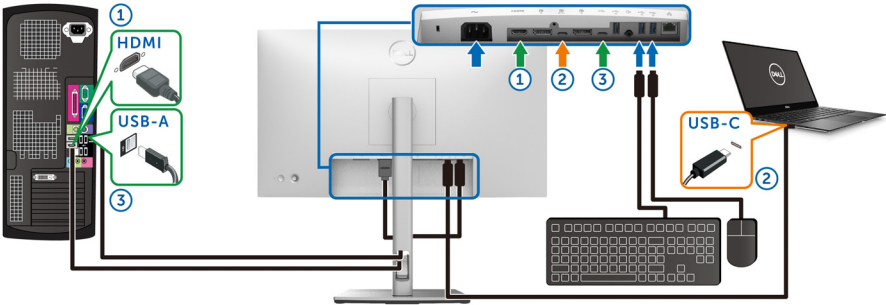

NOTE: The USB-C connection currently supports video and data transfer.

Ensure that **USB** for **HDMI** is assigned to **USB-C2**.

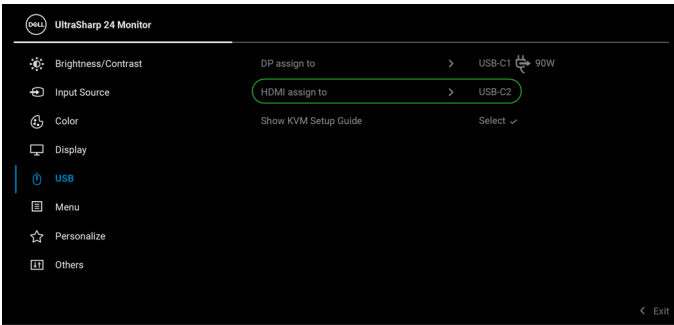

NOTE: As the USB Type-C upstream port ^{DP} supports the DisplayPort Alternate Mode, there is no need to set USB for USB-C 90W.

NOTE: When connecting to different video input sources not shown above, follow the same method to make correct settings for USB to pair the ports.



Setting the Auto KVM (applicable for U2424HE only)

You can follow below instructions to set up Auto KVM for your monitor:

1. Ensure that **Auto Select** is **On** and **Auto Select for USB-C** is **Yes**.

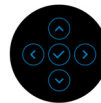
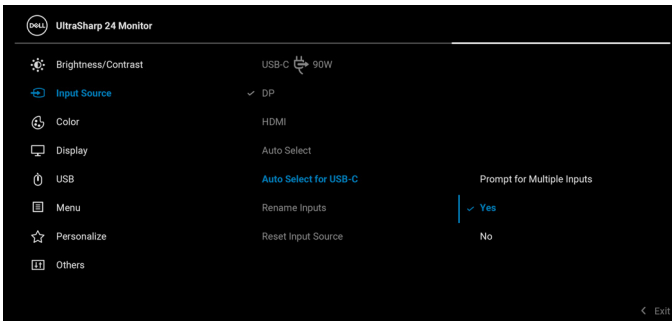
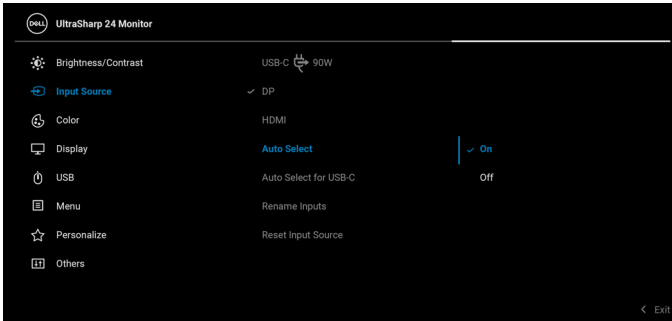

2. Ensure that the USB ports and the video inputs are paired accordingly.



NOTE: For USB-C  90W connection, there is no further setting required.

Setting the maximum resolution

NOTE: The steps may vary slightly depending on the version of Windows you have.

To set the maximum resolution for the monitor:

In Windows 8.1:

1. For Windows 8.1, select the Desktop tile to switch to classic desktop.
2. Right-click on the desktop and click **Screen resolution**.
3. If you have more than one monitor connected, ensure that you select **U2424H/U2424H WOST/U2424HE**.
4. Click the **Screen Resolution** dropdown list and select **1920 x 1080**.
5. Click **OK**.

In Windows 10 and Windows 11:

1. Right-click on the desktop and click **Display settings**.
2. If you have more than one monitor connected, ensure to select **U2424H/U2424H WOST/U2424HE**.
3. Click the **Display Resolution** dropdown list and select **1920 x 1080**.
4. Click **Keep changes**.



If you do not see 1920 x 1080 as an option, you must update your graphics driver to the latest version. Depending on your computer, complete one of the following procedures:

If you have a Dell desktop or laptop:

- Go to <https://www.dell.com/support>, enter your service tag, and download the latest driver for your graphics card.

If you are using a non-Dell computer (laptop or desktop):

- Go to the support site for your computer and download the latest graphic drivers.
- Go to your graphics card website and download the latest graphic drivers.

Setting the maximum refresh rate

 **NOTE: The steps may vary slightly depending on the version of Windows you have.**

To set the maximum refresh rate for the monitor:

In Windows 8.1:

1. For Windows 8.1, select the Desktop tile to switch to classic desktop.
2. Right-click on the desktop and click **Screen resolution**.
3. If you have more than one monitor connected, ensure to select **U2424H/U2424H WOST/U2424HE**.
4. Click **Advanced settings**.
5. Click the **Monitor** tab.
6. Click the dropdown list of **Screen refresh rate** and select **120 Hertz**.
7. Click **OK**.

In Windows 10:

1. Right-click on the desktop and click **Display settings**.
2. Click **Advanced display settings**.
3. If you have more than one monitor connected, ensure to select **U2424H/U2424H WOST/U2424HE**.
4. Click the dropdown list of **Refresh rate** and select **120 Hz**.
5. Click **Keep changes**.



In Windows 11:

1. Right-click on the desktop and click **Display settings**.
2. Click **Advanced display**.
3. If you have more than one monitor connected, ensure to select **U2424H/U2424H WOST/U2424HE**.
4. Click the dropdown list of **Choose a refresh rate** and select **120 Hz**.
5. Click **Keep changes**.

Multi-Monitor Sync (MMS)

Multi-Monitor Sync allows multiple monitors that are daisy chained through DisplayPort to synchronize a predefined group of OSD settings in the background. An OSD option, **Multi-Monitor Sync**, in the Display Menu allows user to enable/disable syncing.

 **NOTE: MMS is not available when using HDMI input.**



When Monitor 1 MST is set to **On** for the first time (For example, during connection of Monitor 2), MMS will be set to **On**.

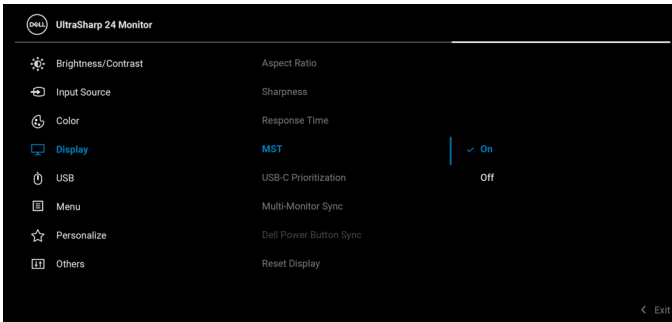

NOTE: The following OSD settings will be synchronized: Brightness, Contrast, Preset Modes, Color Temp., Custom Color (RGB Gain), Hue (Movie, Game mode), Saturation (Movie, Game mode), Response Time, and Sharpness.

Setting Multi-Monitor Sync (MMS)

During initial power on or connection of a new monitor, user setting synchronization only starts if MMS is **On**. All monitors should synchronize settings from Monitor 1.

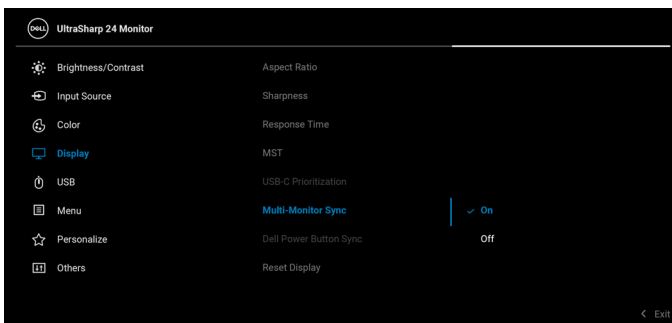

After the first synchronization, subsequent syncing is driven by changes to the predefined group of OSD settings from any node in the chain. Any node may initiate the changes downstream and upstream.

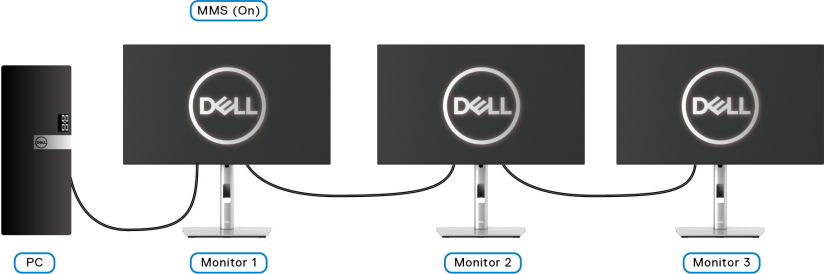

Troubleshooting

⚠ WARNING: Before you begin any of the procedures in this section, follow the [Safety instructions](#).

Self-test

Your monitor provides a self-test feature that allows you to check whether your monitor is functioning properly. If your monitor and computer are properly connected but the monitor screen remains dark, run the monitor self-test by performing the following steps:

1. Turn off both your computer and the monitor.
2. Unplug the video cable from the back of the computer.
3. Turn on the monitor.

The floating dialog box should appear on-screen (against a black background), if the monitor cannot sense a video signal and is working correctly. While in self-test mode, the power LED remains white. Also, depending upon the selected input, one of the dialogs shown below will continuously scroll through the screen.

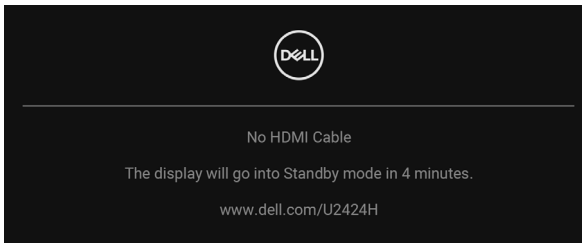

✎ NOTE: The message may be slightly different according to the connected input signal.

4. This box also appears during normal system operation, if the video cable becomes disconnected or damaged.
5. Turn off your monitor and reconnect the video cable; then turn on both your computer and the monitor.

If your monitor screen remains blank after you use the previous procedure, check your video controller and computer, because your monitor is functioning properly.



Using the joystick to lock/unlock buttons

Locking the power and joystick buttons

You can lock the joystick and Power buttons to prevent access to the OSD menu and/or power off the monitor.

To lock the buttons:

1. Toggle and hold the joystick to the **up** or **down** or **left** or **right** for about 4 seconds until a pop menu appears.

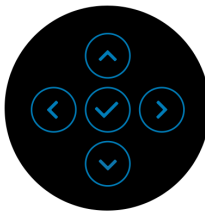
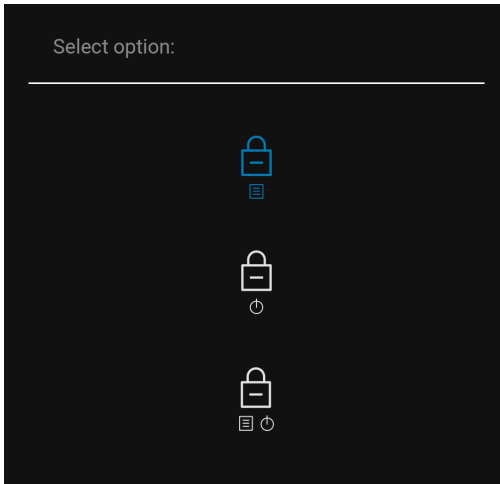

2. Select one of the following options:
 - **Menu Buttons:** All joystick functions are locked and not accessible by the user.
 - **Power Buttons:** Only the **Power Button** is locked and not accessible by the user.
 - **Menu + Power Buttons:** Both the joystick and the **Power Button** are locked and not accessible by the user.



To unlock the button(s), press and hold the joystick to the **up** or **down** or **left** or **right** for 4 seconds. Select the **Unlock** icon to unlock the button(s).

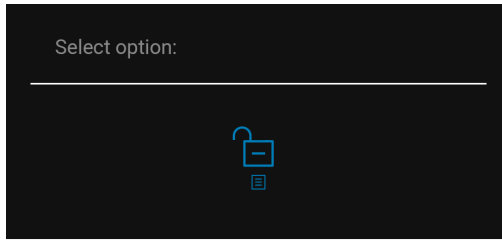

Always On USB-C Charging (applicable for U2424HE only)

The monitor allows you to charge your notebook or mobile devices through the USB Type-C cable even when the monitor is powered off. See [USB-C Charging 90W \(applicable for U2424HE only\)](#) for more information.

Updating monitor firmware

You may verify your current firmware revision in [Firmware](#). If this is not available, go to the Dell download support site for the latest application installer (**Monitor Firmware Update Utility.exe**) and refer to the Firmware Update Instruction User's Guide: www.dell.com/U2424H or www.dell.com/U2424HE.



Common problems

The following table contains general information about common monitor problems you might encounter and the possible solutions:

Common Symptoms	What You Experience	Possible Solutions
No Video/Power LED off	No picture	<ul style="list-style-type: none">• Ensure that the video cable connecting the monitor and the computer is properly connected and secure.• Verify that the power outlet is functioning properly using any other electrical equipment.• Ensure that the Power Button is pressed fully.• Ensure that the correct input source is selected in the Input Source menu.
No Video/Power LED on	No picture or no brightness	<ul style="list-style-type: none">• Increase brightness & contrast controls by using the OSD.• Perform monitor self-test feature check.• Check for bent or broken pins in the video cable connector.• Run the built-in diagnostics.• Ensure that the correct input source is selected in the Input Source menu.
Poor Focus	Picture is fuzzy, blurry, or ghosting	<ul style="list-style-type: none">• Eliminate video extension cables.• Reset the monitor to factory settings.• Change the video resolution to the correct aspect ratio.
Shaky/Jittery Video	Wavy picture or fine movement	<ul style="list-style-type: none">• Reset the monitor to factory settings.• Check environmental factors.• Relocate the monitor and test in another room.



Missing Pixels	LCD screen has spots	<ul style="list-style-type: none"> • Cycle power on-off. • Pixel that is permanently off is a natural defect that can occur in LCD technology. • For more information on Dell Monitor Quality and Pixel Policy, see Dell Support site at: http://www.dell.com/pixelguidelines.
Stuck-on Pixels	LCD screen has bright spots	<ul style="list-style-type: none"> • Cycle power on-off. • Pixel that is permanently off is a natural defect that can occur in LCD technology. • For more information on Dell Monitor Quality and Pixel Policy, see Dell Support site at: http://www.dell.com/pixelguidelines.
Brightness Problems	Picture too dim or too bright	<ul style="list-style-type: none"> • Reset the monitor to factory settings. • Adjust brightness & contrast controls by using the OSD.
Geometric Distortion	Screen not centered correctly	<ul style="list-style-type: none"> • Reset the monitor to factory settings.
Horizontal/Vertical Lines	Screen has one or more lines	<ul style="list-style-type: none"> • Reset the monitor to factory settings. • Perform monitor self-test feature check and determine if these lines are also in self-test mode. • Check for bent or broken pins in the video cable connector. • Run the built-in diagnostics.



Synchronization Problems	Screen is scrambled or appears torn	<ul style="list-style-type: none"> Reset the monitor to factory settings. Perform monitor self-test feature check to determine if the scrambled screen appears in self-test mode. Check for bent or broken pins in the video cable connector. Restart the computer in the safe mode.
Safety Related Issues	Visible signs of smoke or sparks	<ul style="list-style-type: none"> Do not perform any troubleshooting steps. Contact Dell immediately.
Intermittent Problems	Monitor malfunctions on & off	<ul style="list-style-type: none"> Ensure that the video cable connecting the monitor to the computer is connected properly and is secure. Reset the monitor to factory settings. Perform monitor self-test feature check to determine if the intermittent problem occurs in self-test mode.
Missing Color	Picture missing color	<ul style="list-style-type: none"> Perform monitor self-test feature check. Ensure that the video cable connecting the monitor to the computer is connected properly and is secure. Check for bent or broken pins in the video cable connector.
Wrong Color	Picture color not good	<ul style="list-style-type: none"> Try different Preset Modes in Color settings OSD. Adjust the R/G/B value in Custom Color in Color settings OSD. Change the Input Color Format to RGB or YCbCr/YPbPr in the Color settings OSD. Run the built-in diagnostics.



Image retention from a static image left on the monitor for a long period of time	Faint shadow from the static image displayed appears on the screen	<ul style="list-style-type: none"> Set the screen to turn off after a few minutes of screen idle time. These can be adjusted in Windows Power Options or Mac Energy Saver setting. Alternatively, use a dynamically changing screensaver.
---	--	---

Product specific problems

Common Symptoms	What You Experience	Possible Solutions
Screen image is too small	Image is centered on screen, but does not fill entire viewing area	<ul style="list-style-type: none"> Check the Aspect Ratio setting in the Display menu OSD. Reset the monitor to factory settings.
Cannot adjust the monitor with the buttons on the front panel	OSD does not appear on the screen	<ul style="list-style-type: none"> Turn off the monitor, unplug the power cord, plug it back, and then turn on the monitor. Check whether the OSD menu is locked. If yes, move and hold the joystick up/down/left/right for 4 seconds to unlock (for more information, see Lock).
No Input Signal when user controls are pressed	No picture, the LED light is white	<ul style="list-style-type: none"> Check the signal source. Ensure the computer is not in the standby mode by moving the mouse or pressing any key on the keyboard. Check whether the signal cable is plugged in properly. Re-plug the signal cable if necessary. Reset the computer or video player.
The picture does not fill the entire screen	The picture cannot fill the height or width of the screen	<ul style="list-style-type: none"> Due to different video formats (aspect ratio) of DVDs, the monitor may display in full screen. Run the built-in diagnostics.



No video at HDMI/DisplayPort port	When connected to certain dongle/docking device at the port, there is no video when unplugging/plugging the Thunderbolt cable from the notebook	<ul style="list-style-type: none"> Unplug the HDMI/DisplayPort cable from dongle/docking device, then plug the docking Thunderbolt cable to the notebook. Plug the HDMI/DisplayPort cable 7 seconds later.
No video at USB Type-C port (applicable for U2424HE only)	When connected to certain dongle/docking device at the port, there is no video when unplugging/plugging the Thunderbolt cable from the notebook	<ul style="list-style-type: none"> Unplug the USB Type-C cable from dongle/docking device, then plug the docking Thunderbolt cable to the notebook. Plug the USB Type-C cable 7 seconds later.
No network connection (applicable for U2424HE only)	Network dropped or intermittent	<ul style="list-style-type: none"> Check to ensure USB-C Prioritization is set to High Data Speed. Do not turn off the display during network connection.
Monitor screen becomes dim	When Auto Brightness is enabled, the brightness level of the monitor becomes abnormally low, resulting in dimmed screen.	<ul style="list-style-type: none"> Check whether an object is obstructing the sensor area. Ensure a webcam is not mounted over the sensor area. Wipe clean any dust that may be covering the sensor area. Ensure the display is not pivoted and placed to another monitor side-by-side.



Universal Serial Bus (USB) specific problems

Common Symptoms	What You Experience	Possible Solutions
USB interface is not working	USB peripherals are not working	<ul style="list-style-type: none">• Check that your monitor is turned on.• Reconnect the upstream cable to your computer.• Reconnect the USB peripherals (downstream connector).• Switch off and then turn on the monitor again.• Reboot the computer.• Certain USB devices such as external portable HDD require higher electric current; connect the device directly to the computer system.
USB Type-C port does not supply power (applicable for U2424HE only)	USB peripherals can not be charged	<ul style="list-style-type: none">• Check that the connected device is compliant with the USB-C specification. The USB Type-C port supports USB 3.2 Gen2 and an output of 90 W.• Check that you use the USB Type-C cable shipped with your monitor.
SuperSpeed USB 10 Gbps (USB 3.2 Gen2) interface is slow	SuperSpeed USB 10 Gbps (USB 3.2 Gen2) peripherals working slowly or not working at all	<ul style="list-style-type: none">• Check that your computer is SuperSpeed USB 10 Gbps (USB 3.2 Gen2)-capable.• Some computers have USB 3.2, USB 2.0 and USB 1.1 ports. Ensure that the correct USB port is used.• Reconnect the upstream cable to your computer.• Reconnect the USB peripherals (downstream connector).• Reboot the computer.



Wireless USB peripherals stop working when a USB 3.2 device is plugged in

Wireless USB peripherals responding slowly or only working as the distance between itself and its receiver decreases

- Increase the distance between the USB 3.2 peripherals and the wireless USB receiver.
 - Position your wireless USB receiver as close as possible to the wireless USB peripherals.
 - Use a USB-extender cable to position the wireless USB receiver as far away as possible from the USB 3.2 port.
-



Regulatory information

FCC notices (U.S. only) and other regulatory information

For FCC notices and other regulatory information, see the regulatory compliance website located at www.dell.com/regulatory_compliance.

EU product database for energy label and product information sheet

U2424H: <https://eprel.ec.europa.eu/qr/1585527>



U2424H WOST: <https://eprel.ec.europa.eu/qr/1585550>

U2424HE: <https://eprel.ec.europa.eu/qr/1585563>



Contacting Dell

To contact Dell for sales, technical support, or customer service issues, see www.dell.com/contactdell.

-  **NOTE: Availability varies by country and product, and some services may not be available in your country.**
-  **NOTE: If you do not have an active Internet connection, you can find contact information on your purchase invoice, packing slip, bill, or Dell product catalog.**

