

Product Manual

# BeeStation



# Table of Contents

<b>Chapter 1: Before You Start</b>	2
1.1 Package Contents	2
1.2 BeeStation at a Glance	3
1.3 LED Indicators	3
1.4 Hardware Specifications	4
1.5 Safety Instructions	5
<b>Chapter 2: Initial System Setup</b>	7
2.1 Start Up Your BeeStation	7
<b>Chapter 3: Access Your BeeStation</b>	10
3.1 Access from Web Browser	10
3.2 Access from Mobile Devices	10
3.3 Access from Desktop	12
<b>Chapter 4: Add and Organize Files</b>	14
4.1 Upload and Organize Files	14
4.2 Sync with Cloud Services	14
4.3 Back Up Files from USB Drives	16
4.4 Sync or Back Up Files from Your Computer to BeeStation	19
<b>Chapter 5: Back Up and Browse Photos</b>	23
5.1 Upload Photos	23
5.2 Back Up Photos from Your Mobile Devices	23
5.3 Back Up Photos from Your Computer	26
5.4 Create and Share Albums	28
5.5 Cast Photos on TV	28
<b>Chapter 6: System Settings</b>	30
6.1 Invite Users	30
6.2 Back Up Your BeeStation	32
6.3 Software Update	34
6.4 Set Up Local Access	34
<b>Chapter 7: Unlink BeeStation</b>	37
7.1 Unlink via BeeStation Web Portal	37
7.2 Unlink via BeeStation System Settings	38
<b>Chapter 8: Troubleshooting</b>	41

# Chapter 1: Before You Start

Thank you for purchasing this Synology product! Before setting up your new BeeStation, please check the package contents to verify that you have received the items below. Also, make sure to read the safety instructions carefully to avoid harming yourself or damaging your BeeStation.

## Notes:

- All images below are for illustrative purposes only, and may differ from the actual product.

## 1.1 Package Contents

Contact your reseller if your package is missing any of the contents below:

Main unit x 1

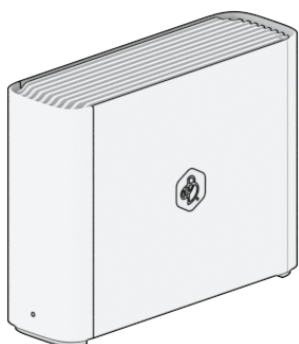

AC power adapter x 1

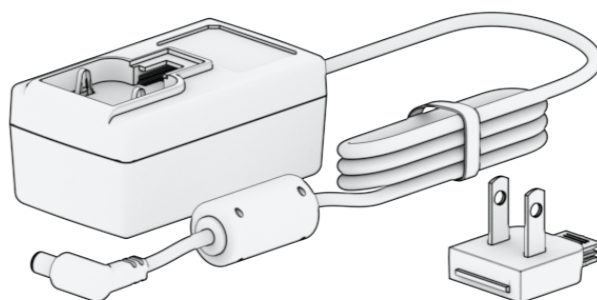

RJ-45 LAN cable x 1

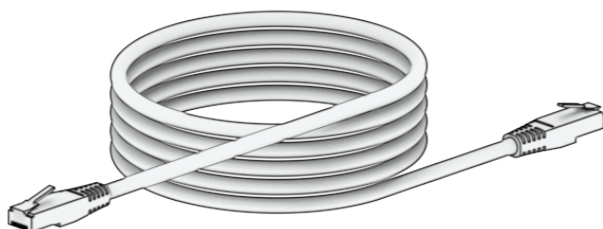

Quick Start Guide x 1



## 1.2 BeeStation at a Glance

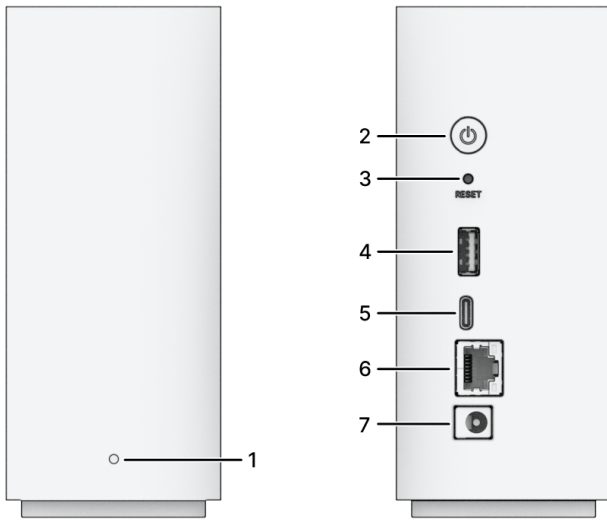

No.	Name	Description
1	Status Indicator	Displays the status of BeeStation. See <a href="#">LED indicators</a> for details.
2	Power Button	<ol style="list-style-type: none"> <li>1. Press to power on your BeeStation.</li> <li>2. To power off your BeeStation, press and hold until you hear a beep sound and the Power LED starts blinking.</li> </ol>
3	RESET Button	<ol style="list-style-type: none"> <li>1. Press and hold until you hear a beep sound to reset the system settings to default.</li> <li>2. Press and hold until you hear a beep sound, then press and hold again until you hear three beep sounds to reinstall BeeStation.</li> </ol>
4	USB-A 3.2 Gen 1 Port	Connect external drives or other USB drives to the BeeStation here.
5	USB-C 3.2 Gen 1 Port	Connect external drives or other USB drives to the BeeStation here.
6	1 GbE RJ-45 Port	Connect the network cable here.
7	Power Port	Connect the power cord here.

## 1.3 LED Indicators

LED Indicator	Color	Status	Description
Status indicator	White	Static	Drive ready

		Blinking	Booting up/Shutting down
		Breathing	HDD hibernation
	Orange	Static	BeeStation uninstalled/Resetting
		Blinking	Drive error
		Breathing	Installing BeeStation /Updating BeeStation
Off	Off	Powered off	

## 1.4 Hardware Specifications

Item	BeeStation
CPU	Realtek RTD1619B
Capacity <sup>1</sup>	4 TB
RAM	DDR4 1 GB
External Port	USB-A 3.2 Gen 1 x 1 USB-C 3.2 Gen 1 x 1
LAN Port	1GbE (RJ-45) x 1
Size (H x W x D) (mm)	148 x 63 x 196
Weight (g)	820
Agency Certification	<ul style="list-style-type: none"> <li>• FCC • CE • UKCA • BSMI • RCM • EAC • KC • VCCI</li> </ul>
System requirements	<ul style="list-style-type: none"> <li>• Windows 10 (Build 17063 or above) and Windows 11 <ul style="list-style-type: none"> <li>• macOS 12.3 or above <ul style="list-style-type: none"> <li>• iOS 15 or above</li> </ul> </li> <li>• Android 8 or above</li> </ul> </li> </ul>
Operating Environment Requirements	<ul style="list-style-type: none"> <li>• Temperature: 32°F to 95°F (0°C to 35°C)</li> <li>• Relative Humidity: 8% to 80% RH</li> </ul>
Storage Environment Requirements	<ul style="list-style-type: none"> <li>• Temperature: -5°F to 140°F (20°C to 60°C)</li> <li>• Relative Humidity: 5% to 95% RH</li> </ul>

### Notes:

1. Our storage capacities follow industry standards where 1 GB equals 1 billion bytes and 1 TB equals 1 trillion bytes. The actual usable capacity is around 3.45 TB.
2. Model specifications are subject to change without notice. Refer to Synology website for the latest information.

## 1.5 Safety Instructions



- Keep away from direct sunlight and chemicals. Ensure a stable environment with no abrupt changes in temperature or humidity.



- Place the unit right side up at all times.



- Keep the unit away from liquids.



- Before cleaning, unplug the power cord(s) and use a damp cloth to wipe the surface. Do not use chemical aerosol cleaners.



- To prevent the unit from falling over, do not place it on carts or any unstable surfaces.



- When setting up this product, use only Synology-provided or designated cables, power cords, PSUs, and power adapters that adhere to local regulations and safety requirements. Ensure the power cord(s) are plugged into the correct power supply voltage and that the AC voltage provided is correct and stable. Failure to do so may result in malfunctions or fires.
- Do not use Synology-provided accessories on non-Synology products.



- Warning, electric shock hazard. To remove all electrical current from the device, ensure that all power cords are disconnected from the power source.



- There is a risk of explosion if the battery is replaced with an incorrect type. Dispose of used batteries appropriately.
- 

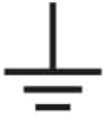

- Power cord(s) must be plugged into a socket-outlet with earthing connection.
- 



- Keep your body parts away from a moving fan.
- 



- This product must be installed by qualified personnel in a restricted access location (e.g., dedicated equipment rooms, service closets, etc.).
-

# Chapter 2: Initial System Setup

## 2.1 Start Up Your BeeStation

1. Scan the QR code on the Quick Start Guide or enter the URL ([portal.bee.synology.com/setup](https://portal.bee.synology.com/setup)) into a web browser. Follow the instructions to finish the initial setup.

### Start Using BeeStation

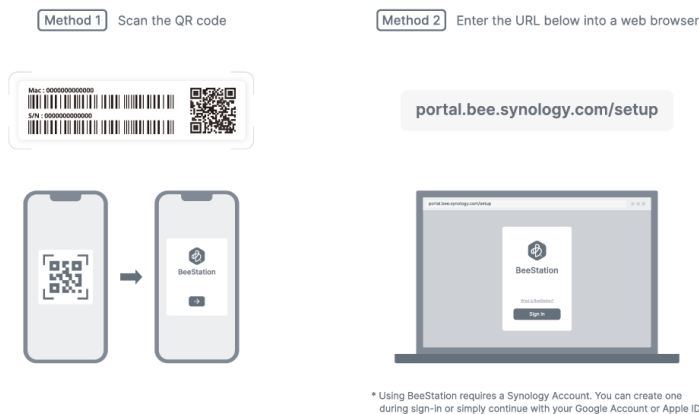

2. Use an Ethernet cable to connect the BeeStation to your switch, router, or hub.
3. Snap the provided plug adapter to the AC power adapter. Note that the plug adapter included with your BeeStation may differ based on your region.
4. Connect one end of the AC power adapter to the power port of your BeeStation, and the other end to the power outlet.

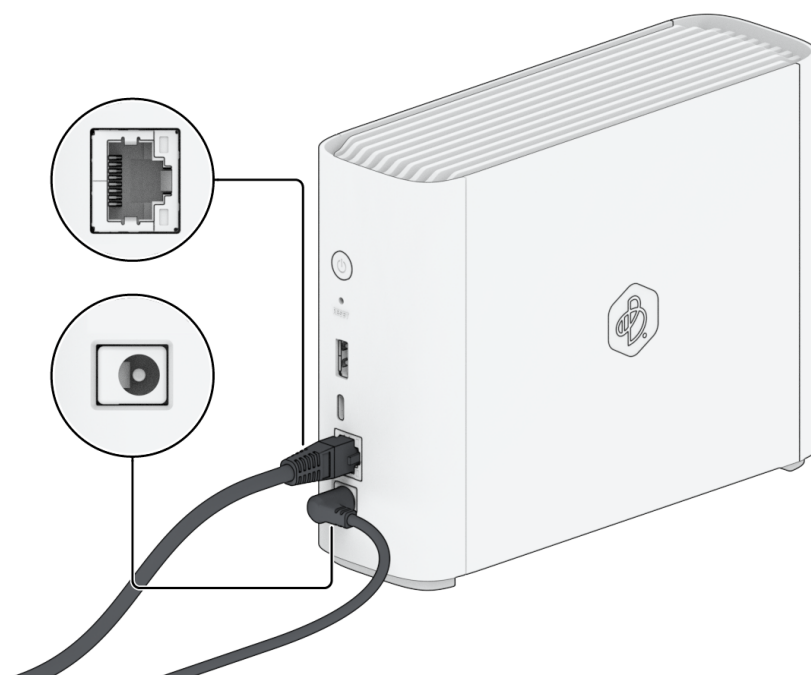



5. Press the power button to turn on the BeeStation.

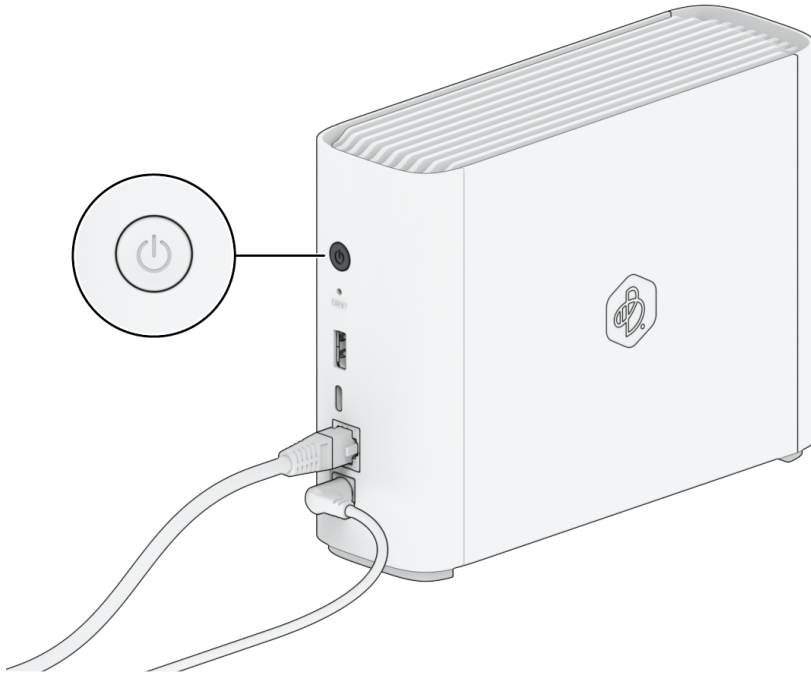

6. Wait until the front indicator turns static orange.

7. Enter the serial number. Skip this step if you started the setup by scanning the QR code on the Quick Start Guide.

8. Press the power button for 4 seconds and release it when you hear a beep sound.<sup>1</sup>

9. Name your BeeStation. Your BeeStation is now ready to go.

**Notes:**

1. BeeStation may perform an update automatically at this time. Please ensure a stable power supply and network connection during the update. The BeeStation may automatically restart, which is normal behavior.

# Chapter 3: Access Your BeeStation

## 3.1 Access from Web Browser

1. Go to [portal.bee.synology.com](http://portal.bee.synology.com).
2. Sign in with your Synology Account.
3. Hover over your BeeStation and select either of the following:
  - To store and access files on BeeStation, click **Open BeeFiles**.
  - To back up and view photos on BeeStation, click **Open BeePhotos**.

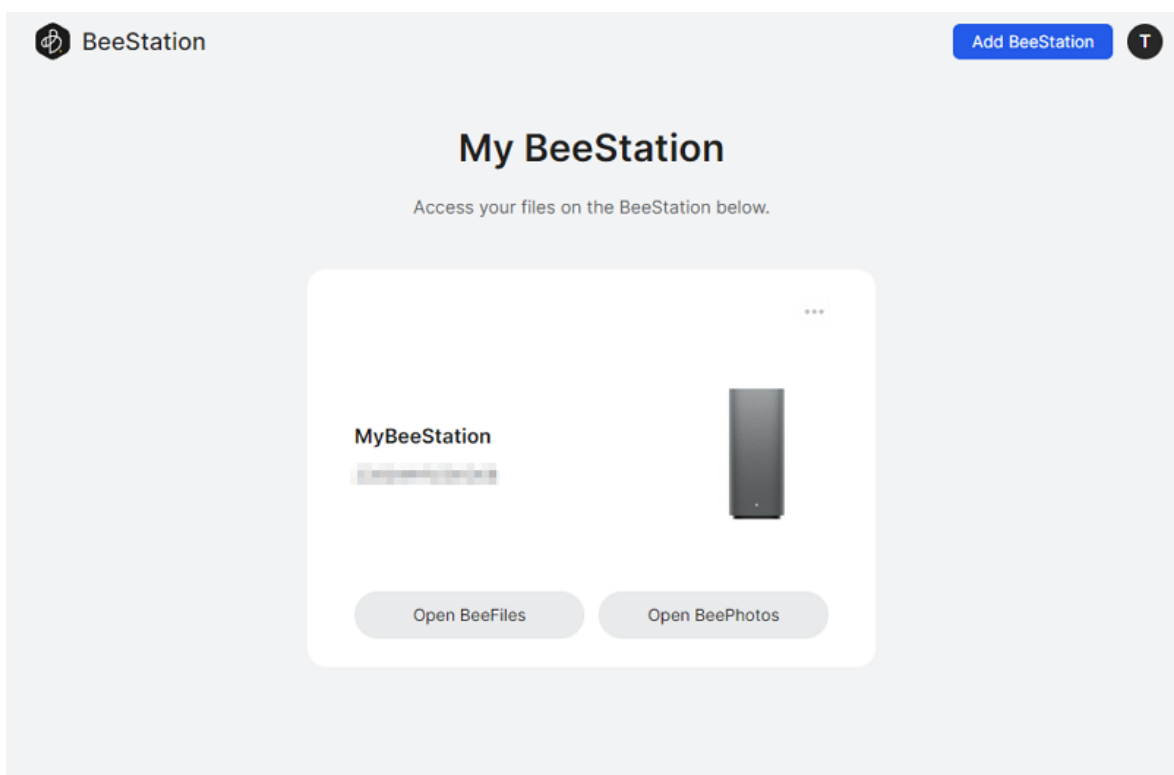

## 3.2 Access from Mobile Devices

1. Scan the QR code to download the BeeStation mobile apps:

a. BeeFiles



b. BeePhotos



2. Open the app and sign in with your Synology Account.
3. Select your BeeStation.

### 3.3 Access from Desktop

1. Download and install BeeStation for desktop from the [Download Center](#).
2. Open BeeStation for desktop and sign in with your Synology Account.

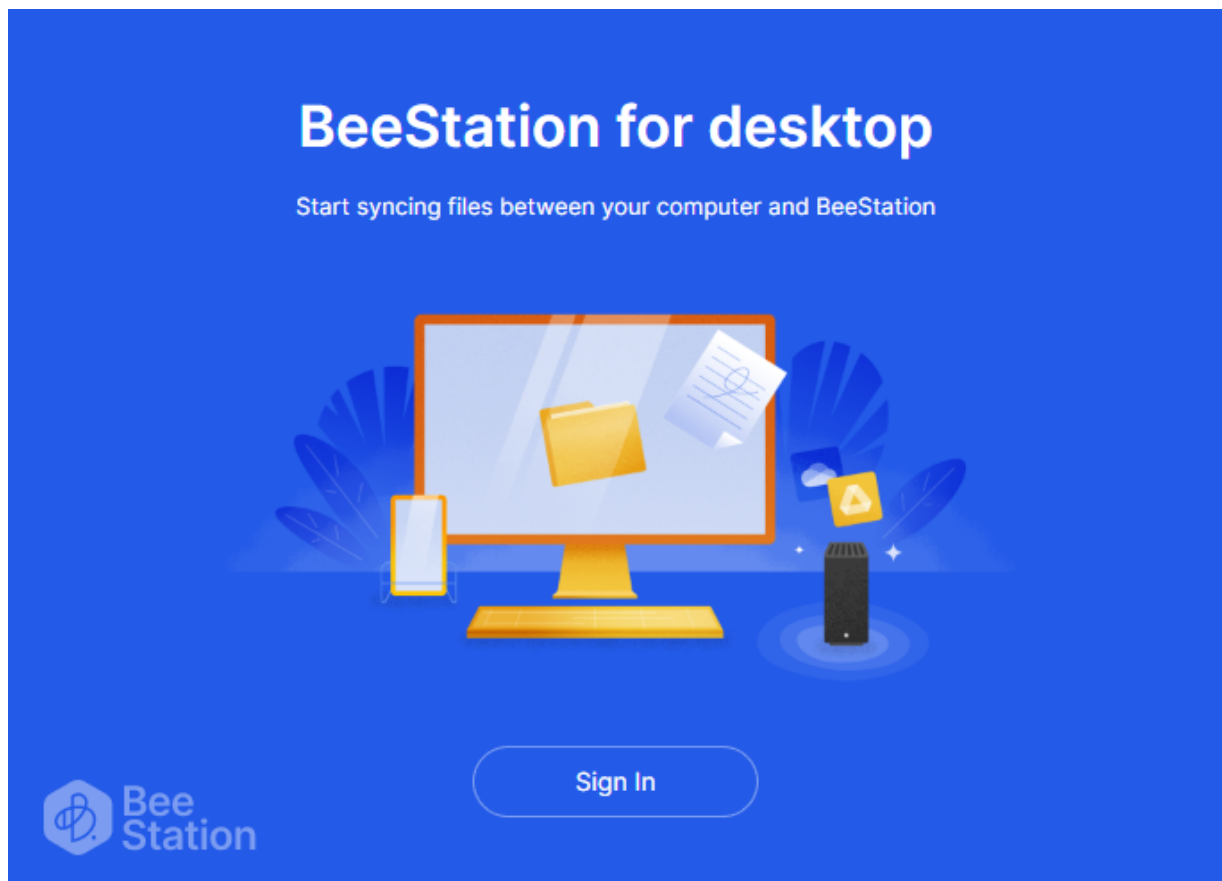

3. Follow the instructions and click **OK**.

## Access and open BeeStation directly from your computer

Browse, open, edit, and save any files on BeeStation directly from your computer. Only files that are opened or have been made available offline will consume space on your computer.

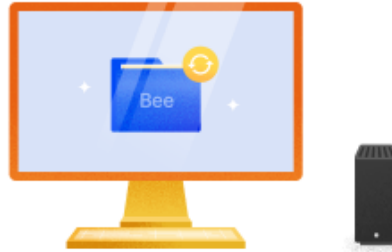

This folder will be accessible from the following location:

C:\Users\ [user] \BeeStation

Change

Skip

OK

4. The folder containing all the files in **My Files** will open in File Explorer or Finder.

# Chapter 4: Add and Organize Files

## 4.1 Upload and Organize Files

1. Open BeeFiles.
2. Go to **My Files**, click **Add** to create a new folder or upload files/folders. You can also upload files/folders by dragging and dropping them.
3. To manage a file/folder, right-click on it and select an action.

## 4.2 Sync with Cloud Services

1. Open BeeFiles.
2. Go to **Cloud services**, select the cloud service you want to sync with.

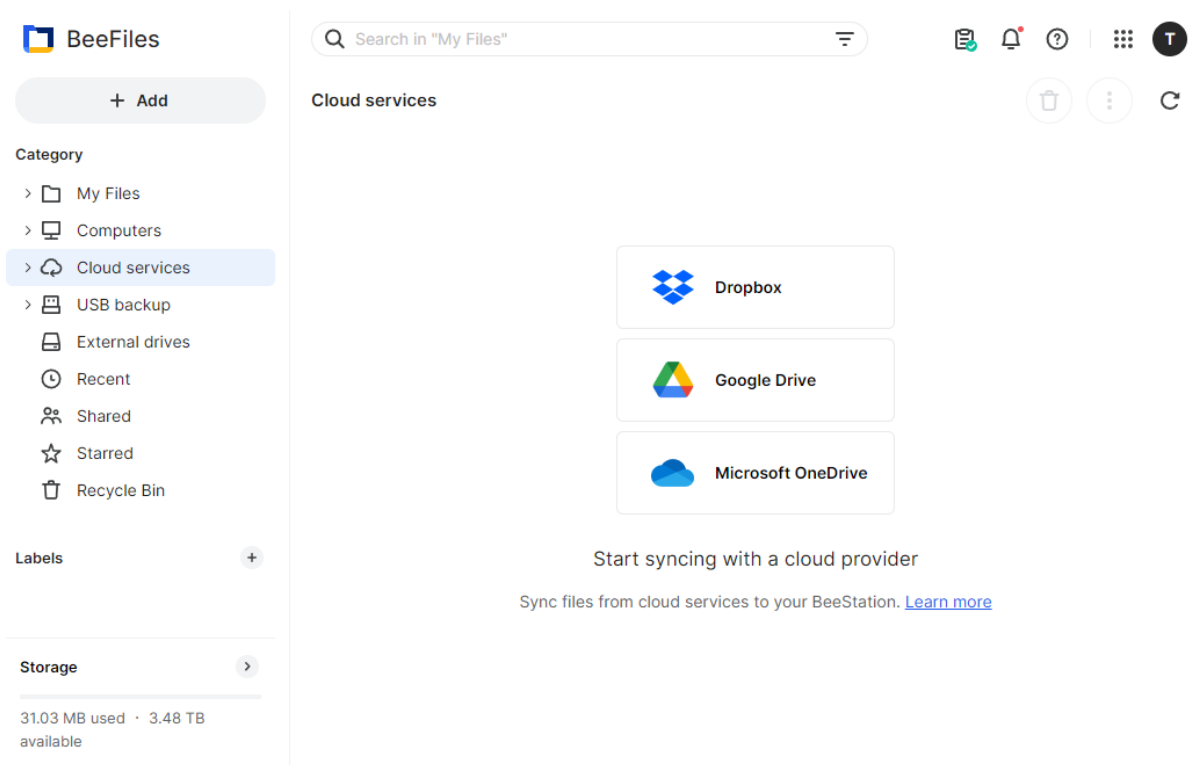

3. Sign in to your cloud service account.
4. Select the sync direction:
  - **Two-way**: Ensures that changes on both sides are synced.
  - **One-way - from Dropbox/Google Drive/Microsoft OneDrive to BeeStation**: Retains a copy of the files from the cloud service.

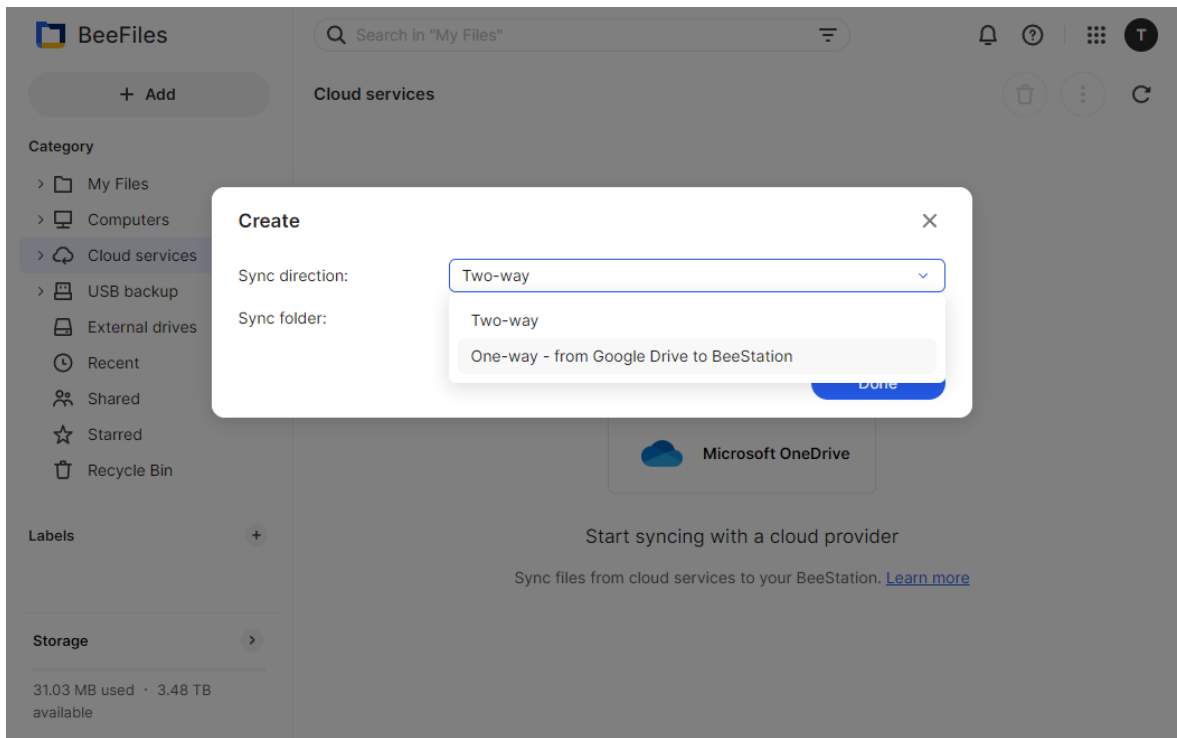

5. Select the folder you want to sync. By default, all the folders will be selected.

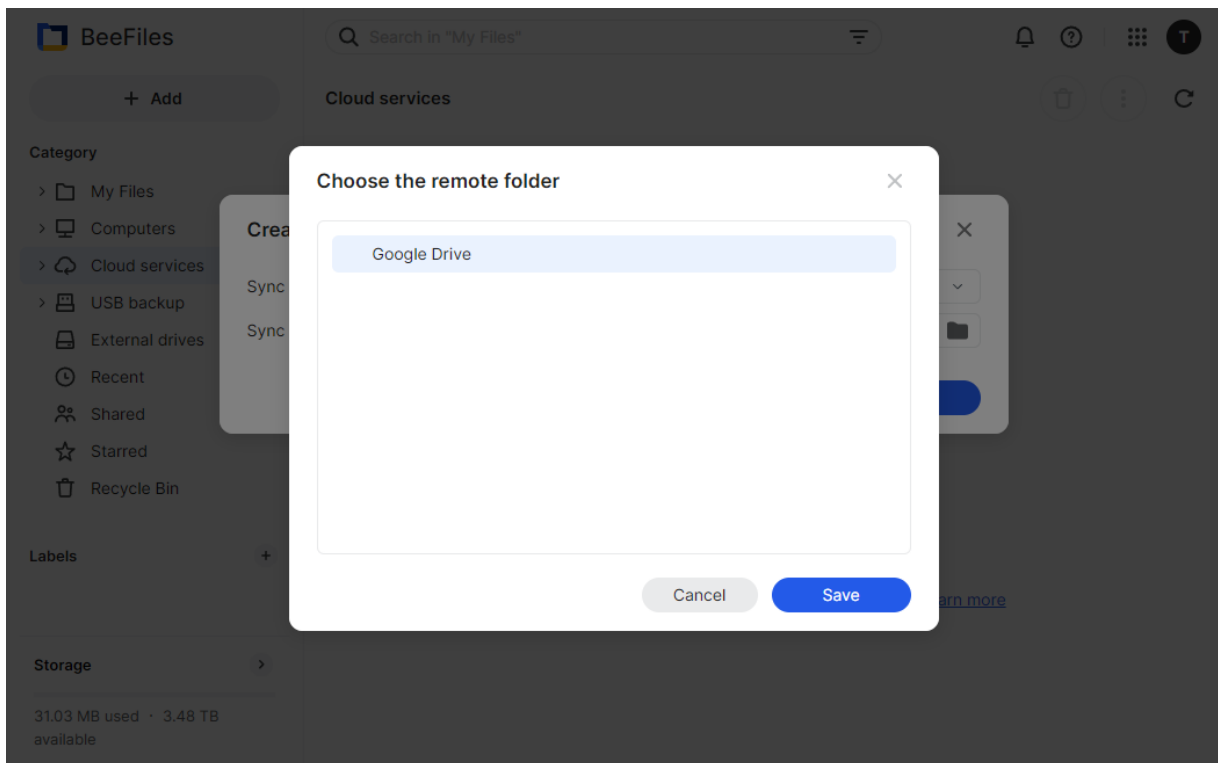

6. Click **Done** and the sync folder will be created.

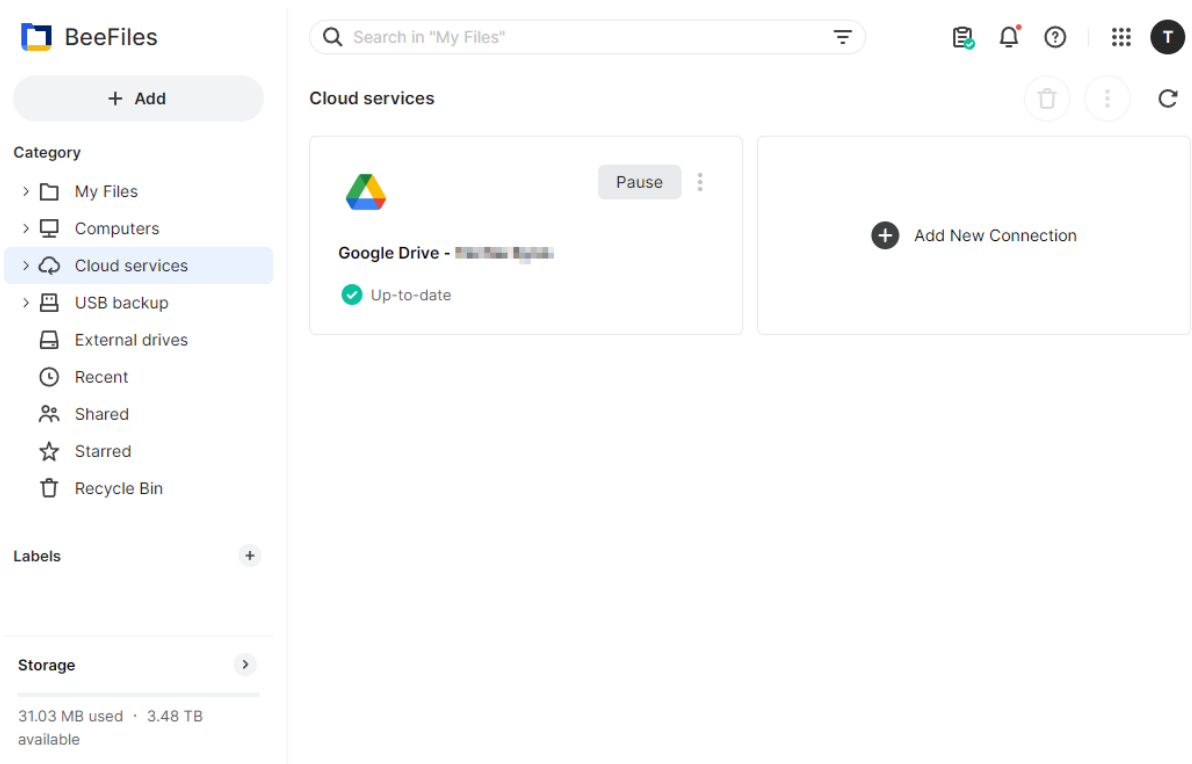

## 4.3 Back Up Files from USB Drives

1. Insert a USB drive into the USB slot on your BeeStation.
2. Go to **USB backup**, and click **Back Up Now**.



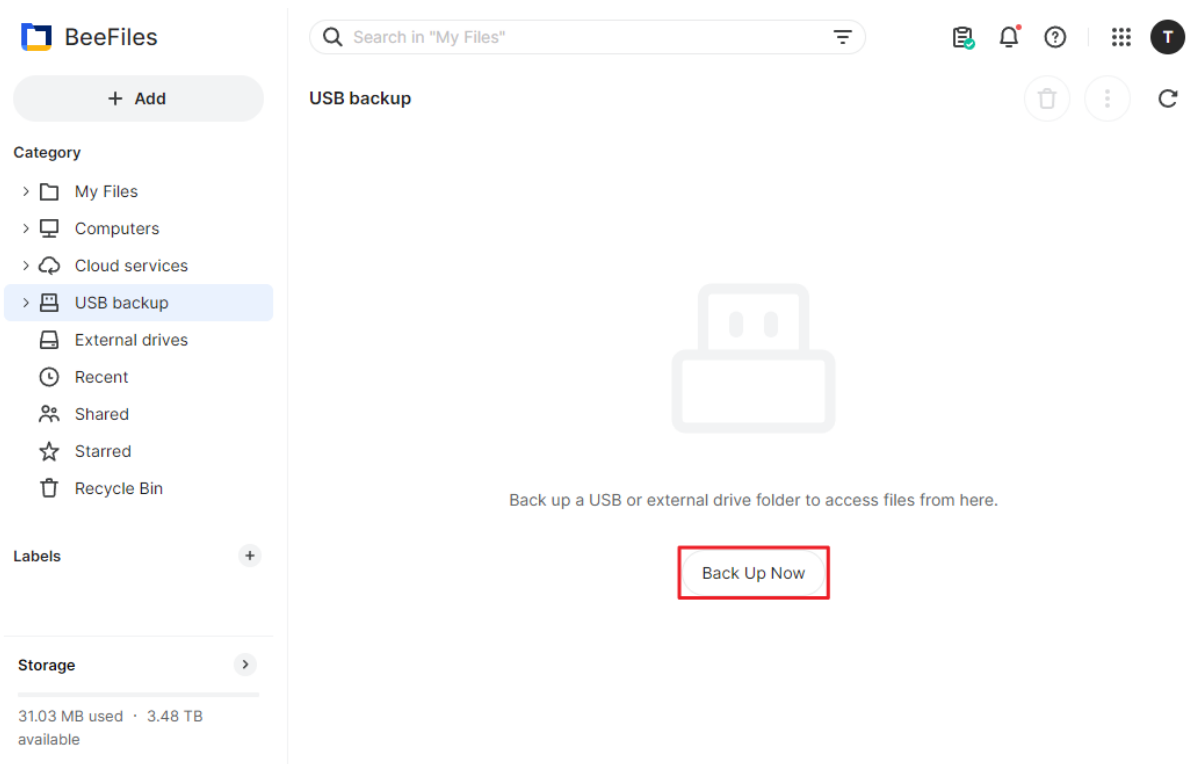

3. Select the USB drive and the folder you want to back up. By default, all the folders will be selected.

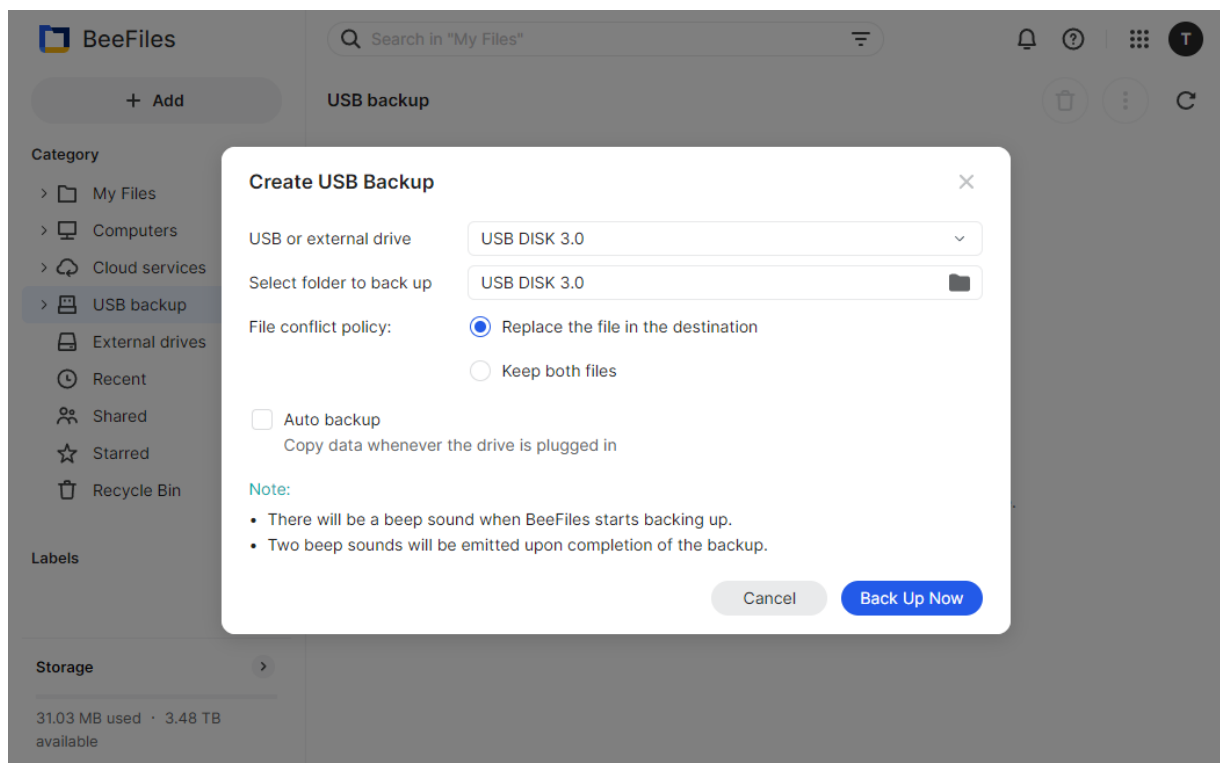

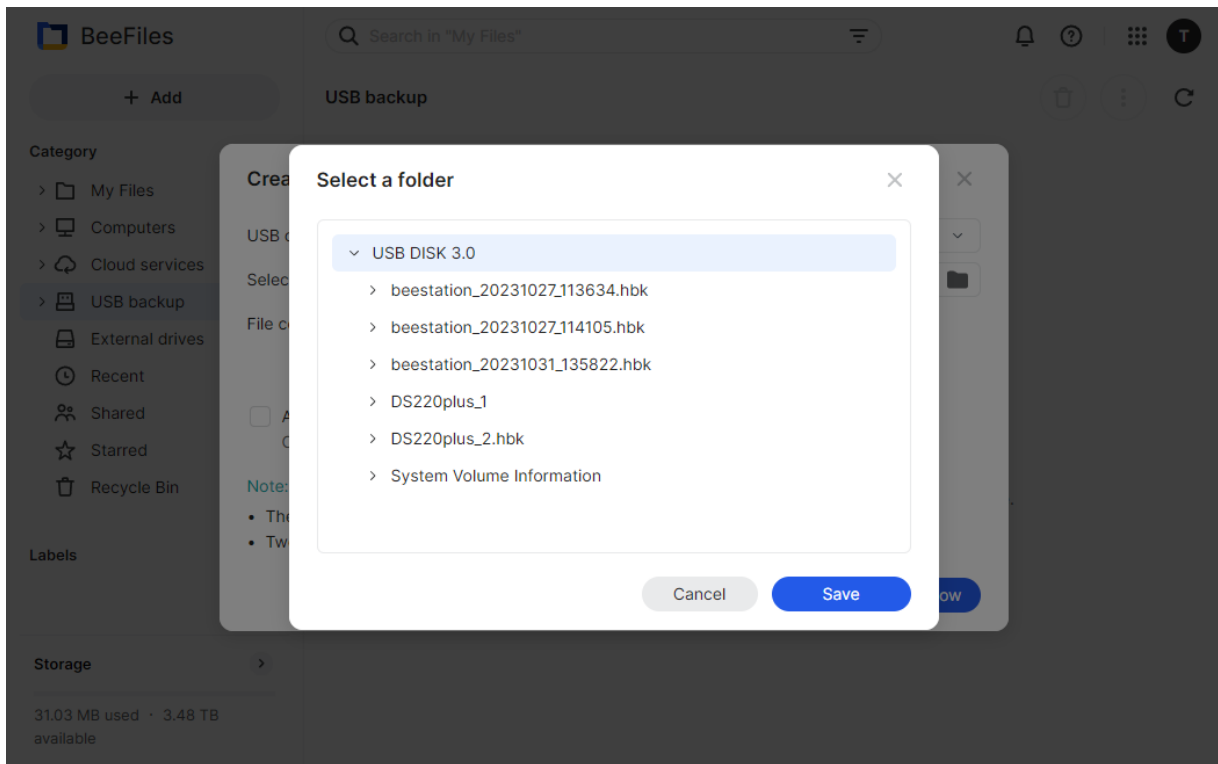

4. Choose how to handle file conflicts:

- **Replace the file in the destination:** Overwrites the existing file with the new one.
- **Keep both files:** Retains the original file and renames the new one with a suffix.

5. To automatically back up modified files whenever the USB drive is inserted, select **Auto backup**.

6. Click **Back Up Now** and the backup folder will be created.

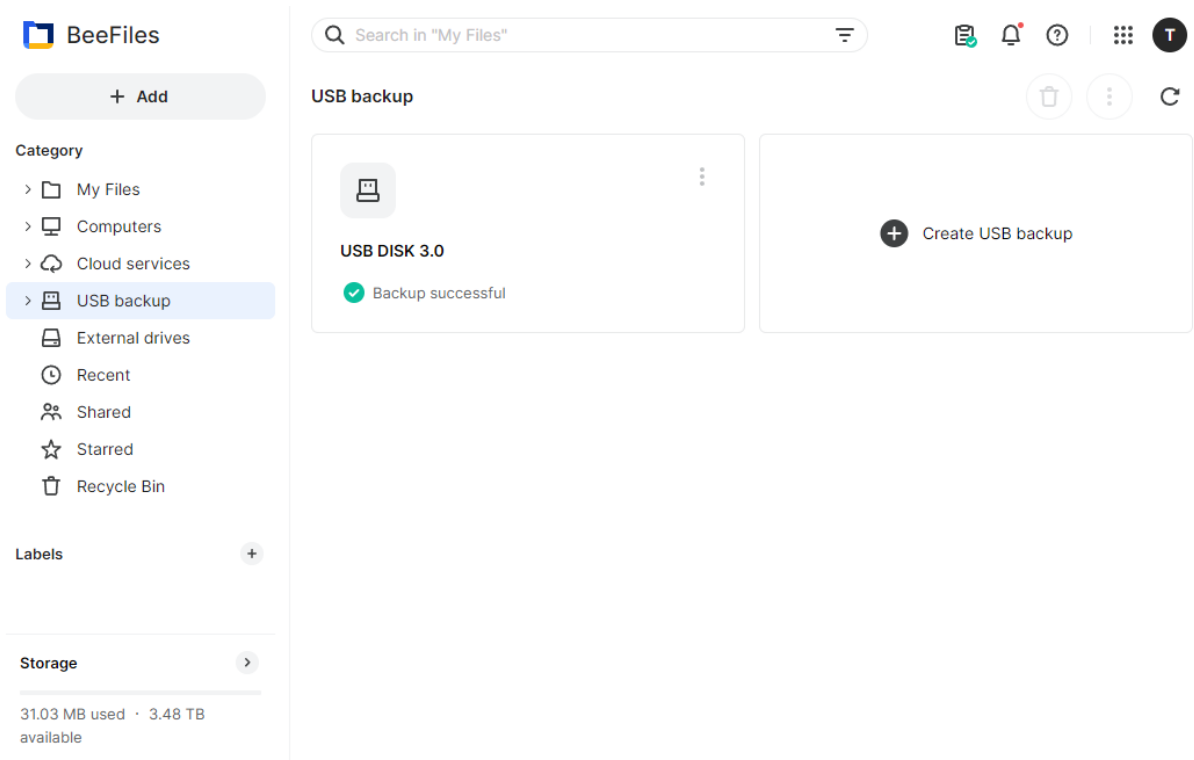

## 4.4 Sync or Back Up Files from Your Computer to BeeStation

1. Open BeeStation for desktop, click the **Settings** icon. Then, click **Settings** to open the main window.

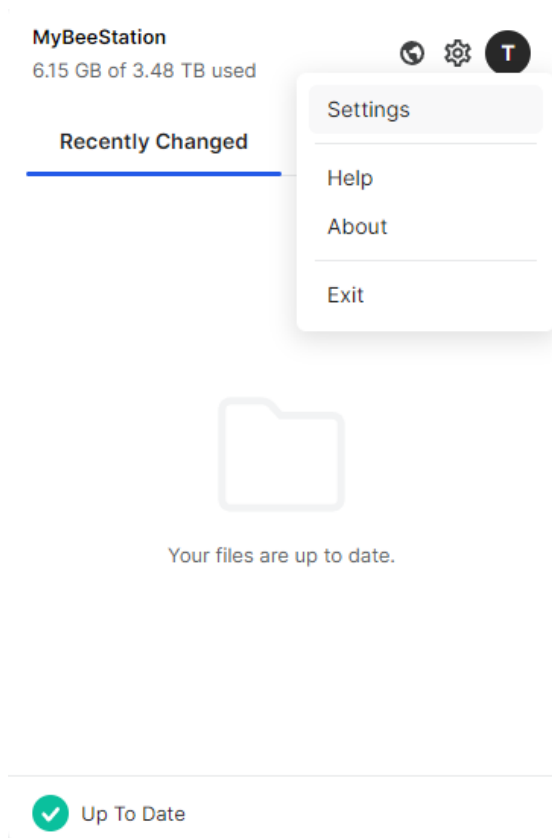

2. In the **My Computer** tab, click **Select Folder**.

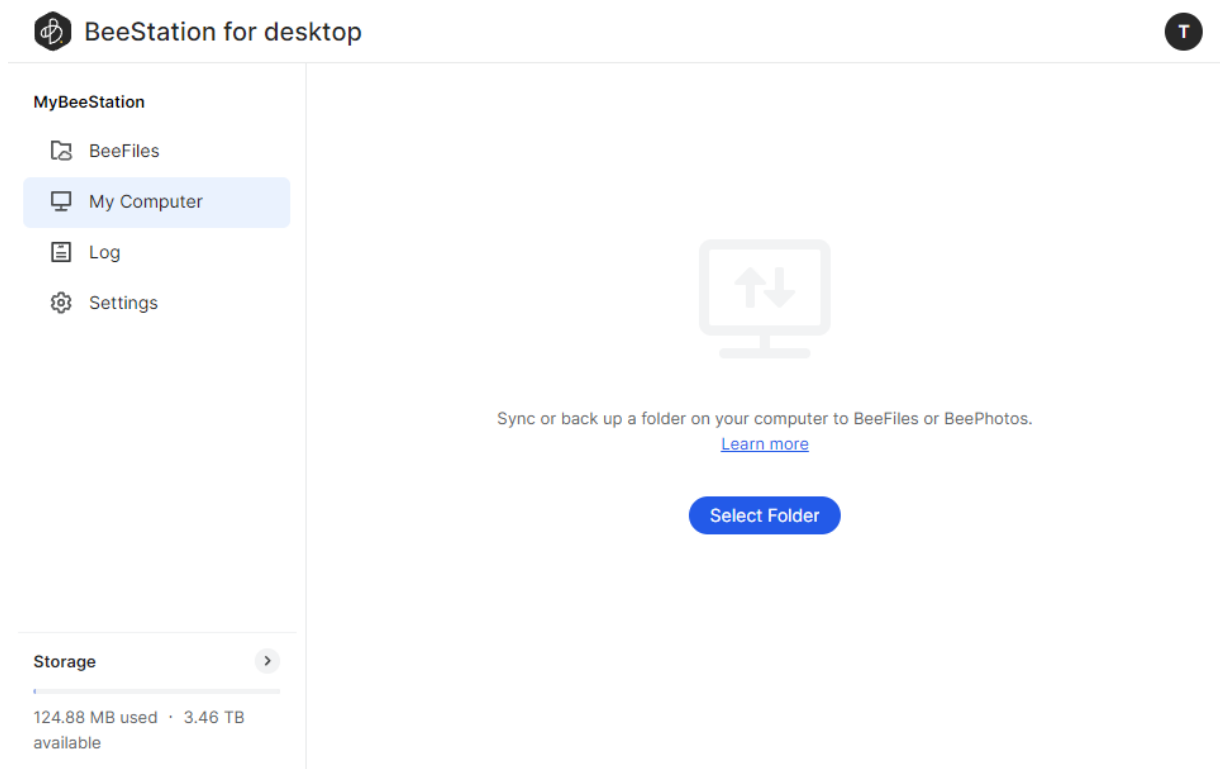

3. Select **BeeFiles**.

4. Select two-way sync or backup to BeeFiles.

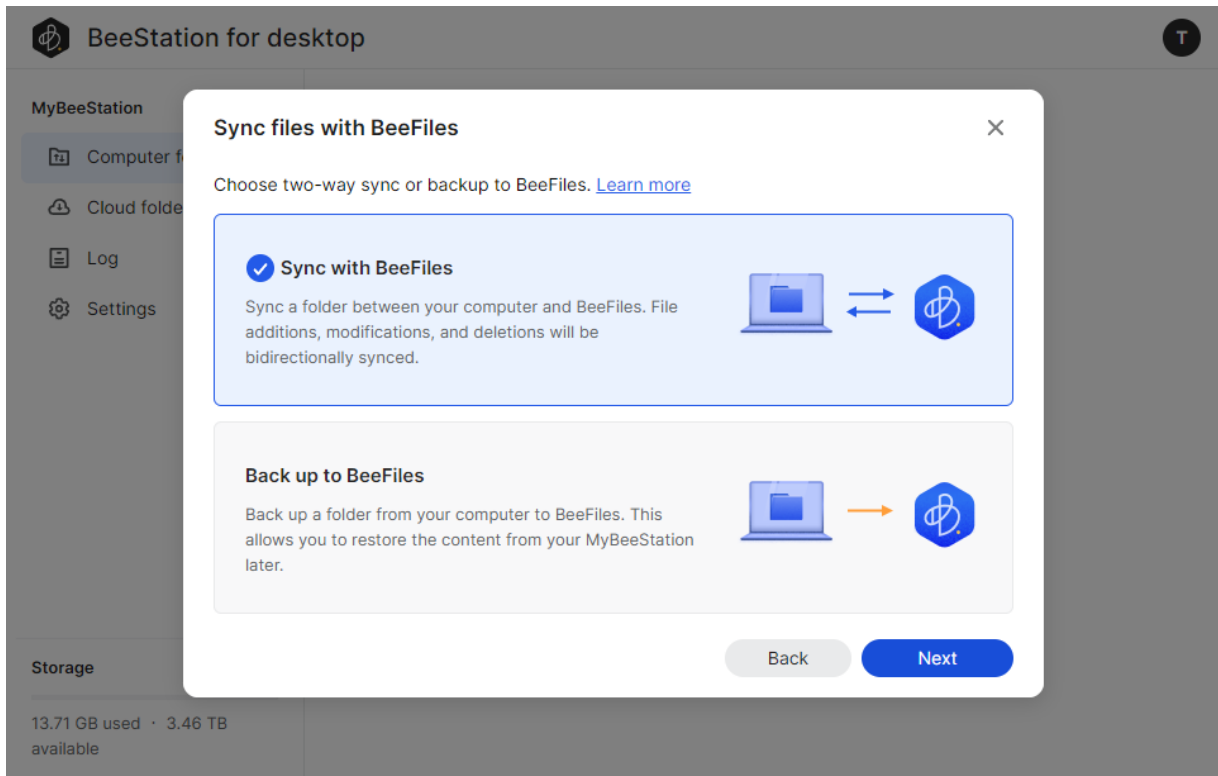

5. Select the folder on your computer that you want to sync or back up.

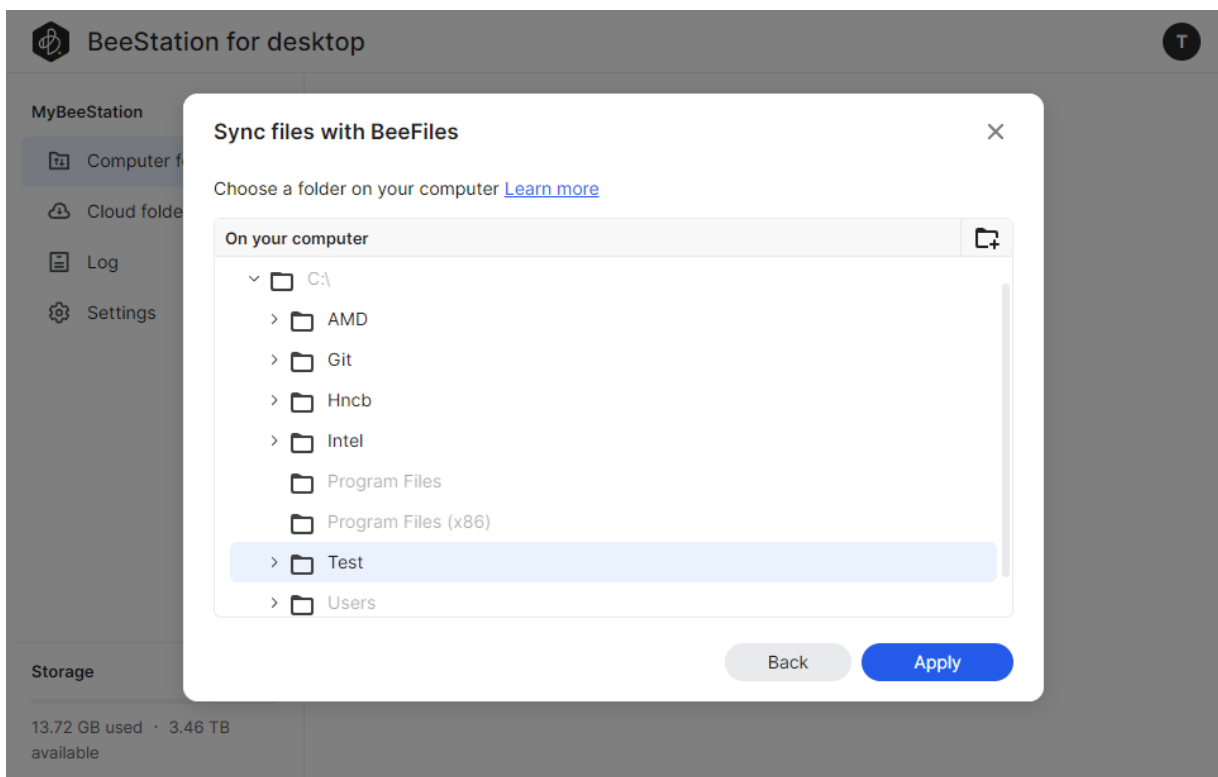

6. Click **Apply** to start syncing or backing up. You can check the results by going to **BeeFiles** web portal > **Computers**, double-click the folder named after your computer.

+ Add

Category

- > My Files
- > Computers
  - > 10610-DT-007
  - > 10702-DT-006
- > Cloud services
- > USB backup
- External drives
- Recent
- Shared
- Starred
- Recycle Bin

Labels



Storage



13.71 GB used · 3.46 TB available

Search in "My Files"



Computers > 10610-DT-007



Title ^	Sync Direction	Last Modified	Labels
☆ Test	↕ Two way sync	11/06/2023 10:55	

# Chapter 5: Back Up and Browse Photos

## 5.1 Upload Photos

1. You can upload photos to BeeStation using the following methods:
  - On BeePhotos web, drag and drop the photos into the browser or click **Upload Photos**.
  - On the BeePhotos mobile app, go to **Photos**, tap the **...** icon and select **Upload**.
2. The photos will display in the timeline based on when they were taken.

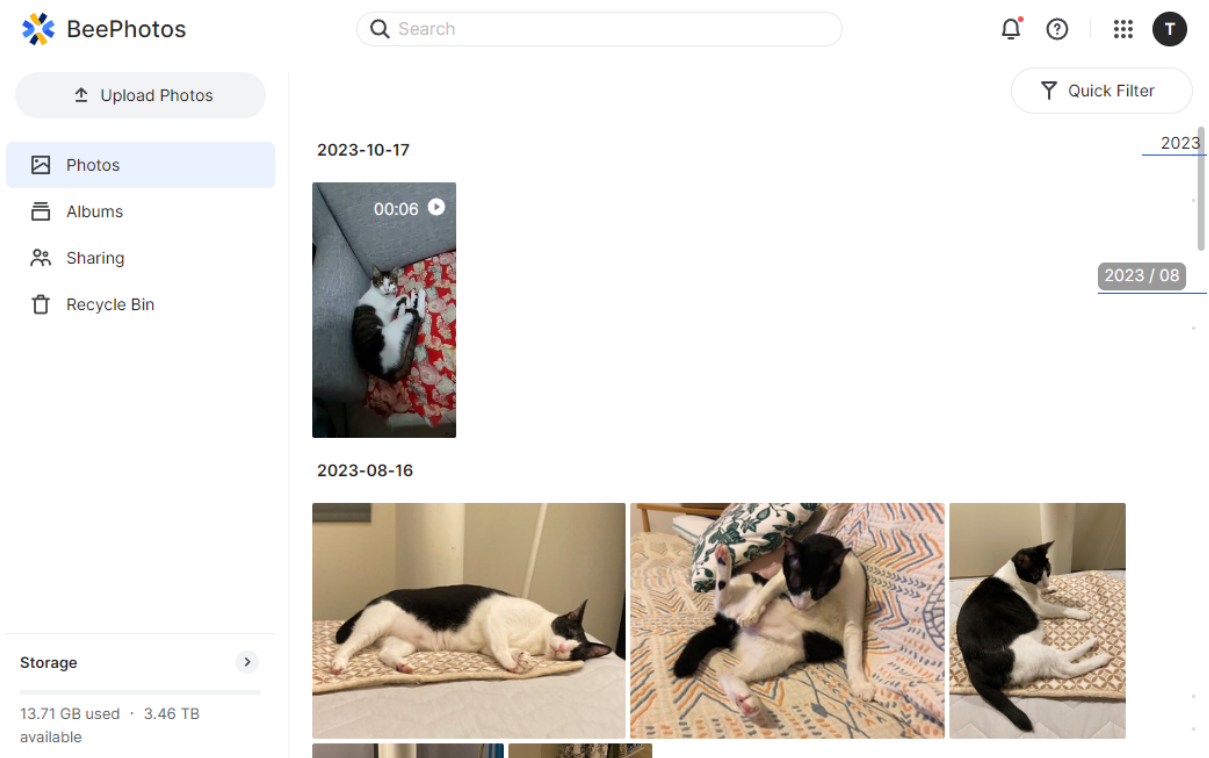

## 5.2 Back Up Photos from Your Mobile Devices

1. Open **BeePhotos** on your mobile device.
2. In the **More** tab, tap the cloud icon.

## More

 >  
My\_BeeStation



 **Photo Backup Not Enabled**  
Tap to set up photo backup

 Upload Queue

 Settings

 Storage Usage

194.69 GB used | 2.84 TB available

  
Photos

  
Albums

  
Sharing

  
More

3. Tap Enable Photo Backup.



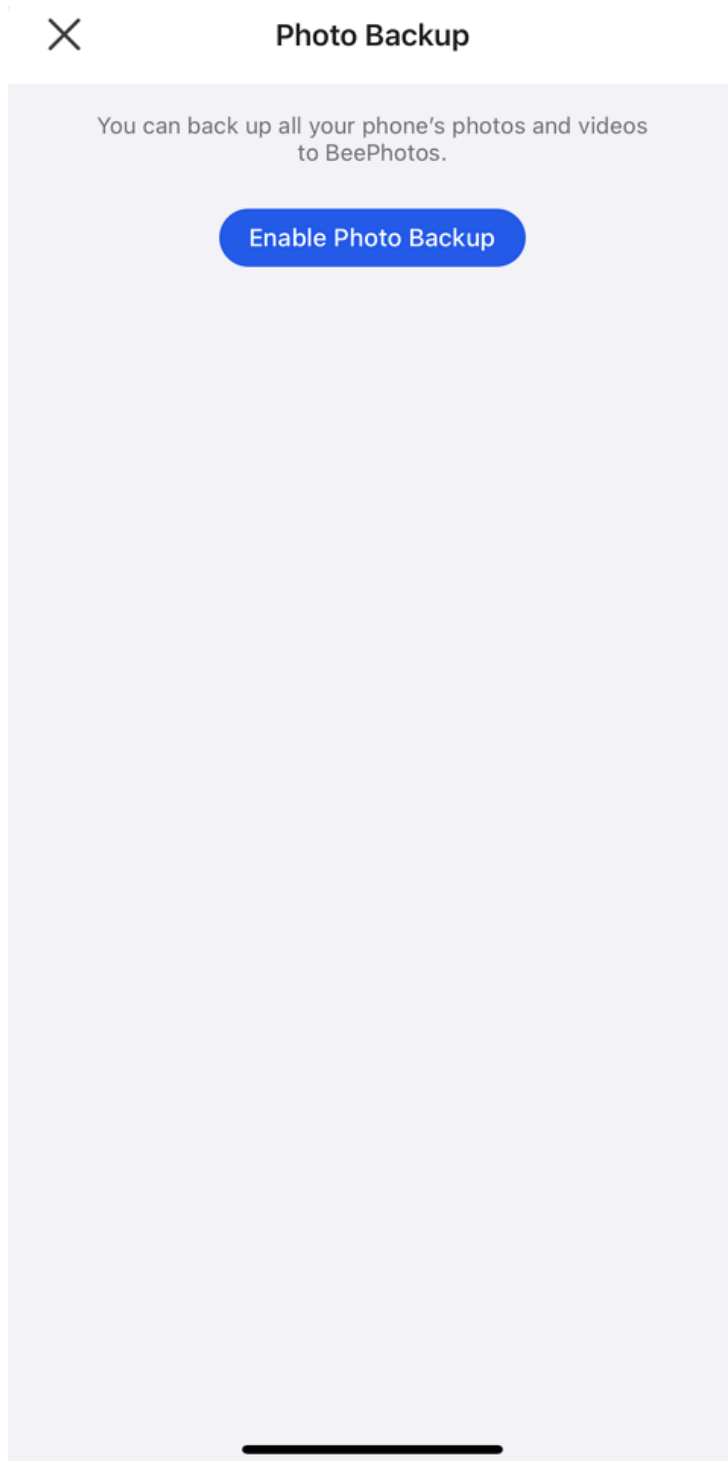

4. If you want to upload only new photos taken from this point forward, select **Back up new photos only**. Alternatively, choose **Back up all photos** to backup all the photos on your phone. Tap **Enable** to start the backup.



## 5.3 Back Up Photos from Your Computer

1. Open BeeStation for desktop, click the **Settings** icon. Then, click **Settings** to open the main window.

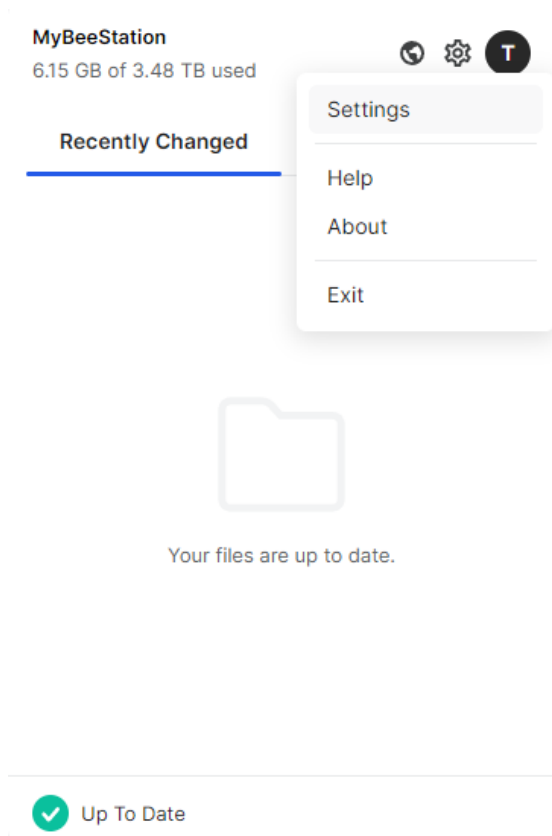

2. In the **My Computer** tab, click **Select Folder**.

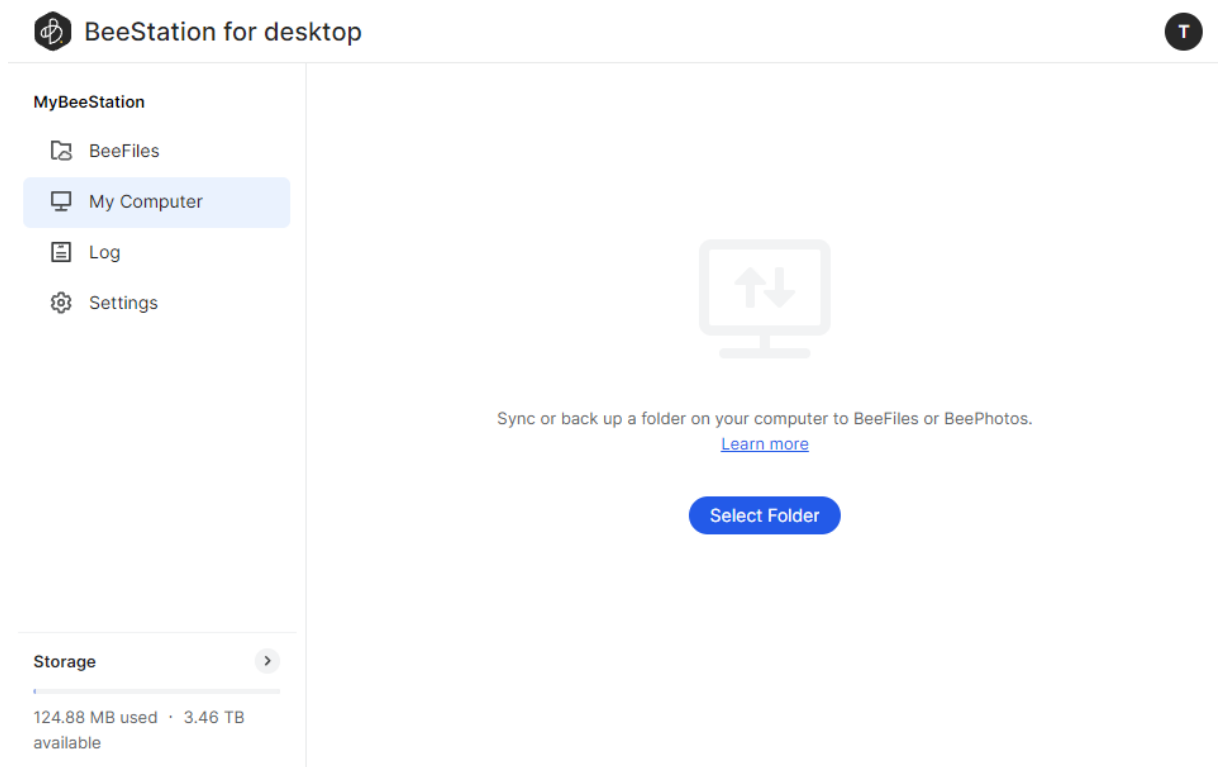

3. Select **BeePhotos**.

4. Select the folder on your computer that you want to back up.

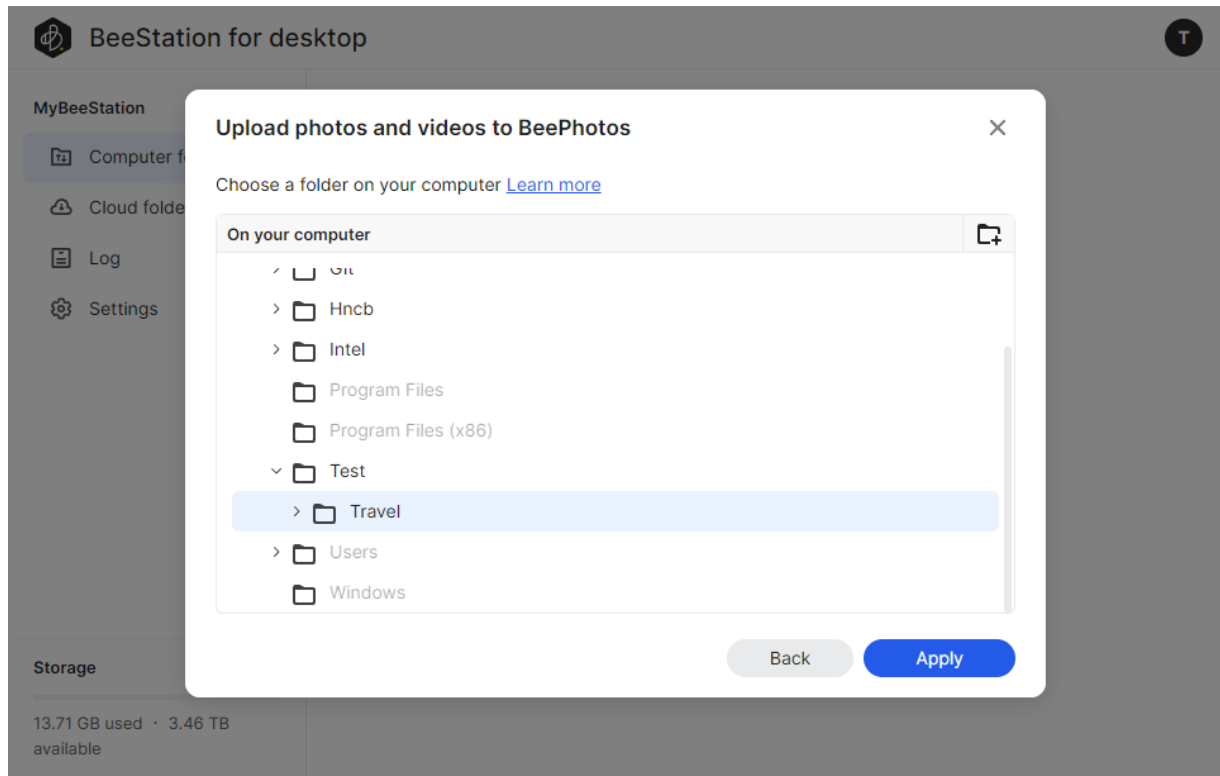

5. Click **Apply** to start the backup. You can check the results by going to BeePhotos app or web.

## 5.4 Create and Share Albums

With BeePhotos, you can create albums to arrange photos your way and share them with others.

1. Go to **Albums**.
2. Click **Create Album**. To select specific photos to add to the album, choose **Select photos to create album**. If you prefer the photos to be automatically added based on your specified criteria, select **Set conditions to create album**. The latter option is only supported on BeePhotos web.
3. Follow the instructions to create the album.
4. Hover over the album, click the **⋮** icon > **Share** to generate a share link and share it with others.

## 5.5 Cast Photos on TV

The BeePhotos mobile app supports casting photos via AirPlay or Chromecast. Follow the steps below as needed:

- For AirPlay: Ensure your AirPlay device is connected to the same Wi-Fi network as your mobile device. Then, open **Control Center**, tap **Screen Mirroring**, and select your AirPlay device.

- For Chromecast: Ensure your Chromecast device is set up and connected to the same Wi-Fi network as your mobile device. Open a photo, tap the  cast icon, and select your Chromecast device.

# Chapter 6: System Settings

In **System Settings**, you can invite users, back up your BeeStation, check software status, and enable local access.

1. Go to [portal.bee.synology.com](https://portal.bee.synology.com).
2. Sign in with your Synology Account.
3. Click the ⋮ icon > **System Settings**.

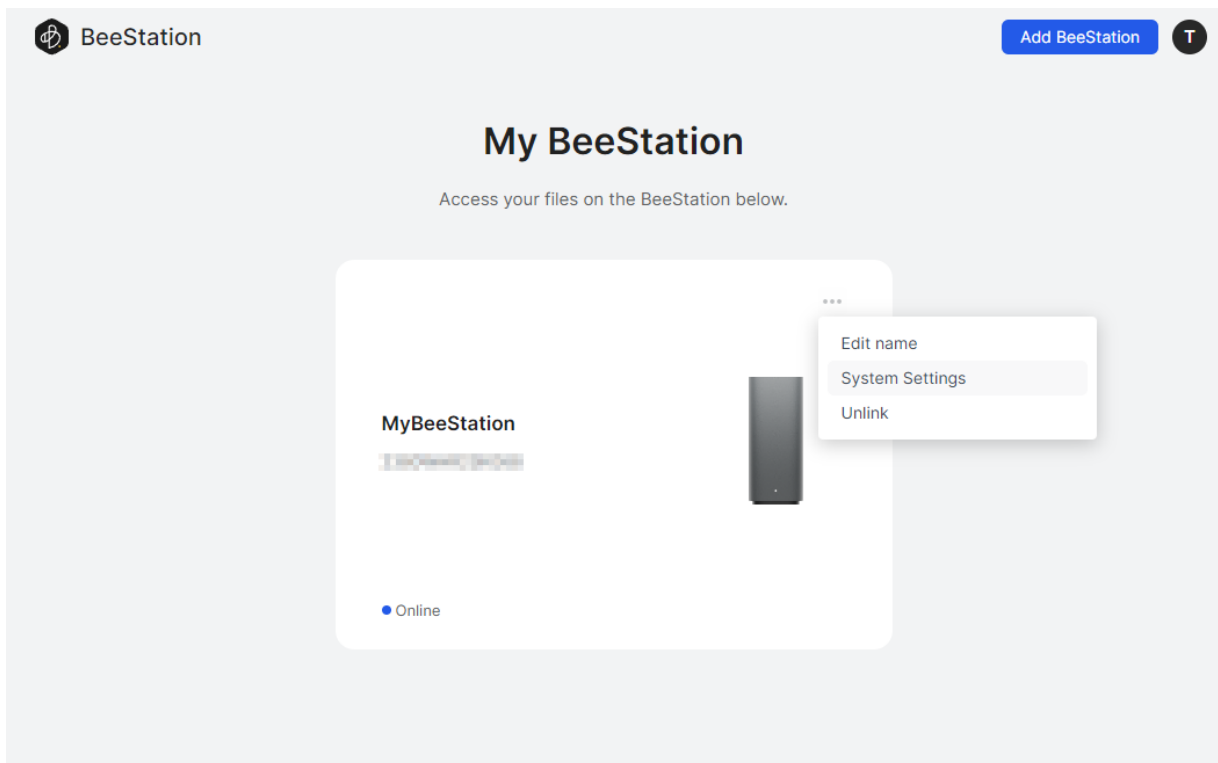

## 6.1 Invite Users

You can invite up to 8 individuals to use your BeeStation storage space. Their files will be kept separate from each other.

1. Go to **Users**, and click **Invite user**.

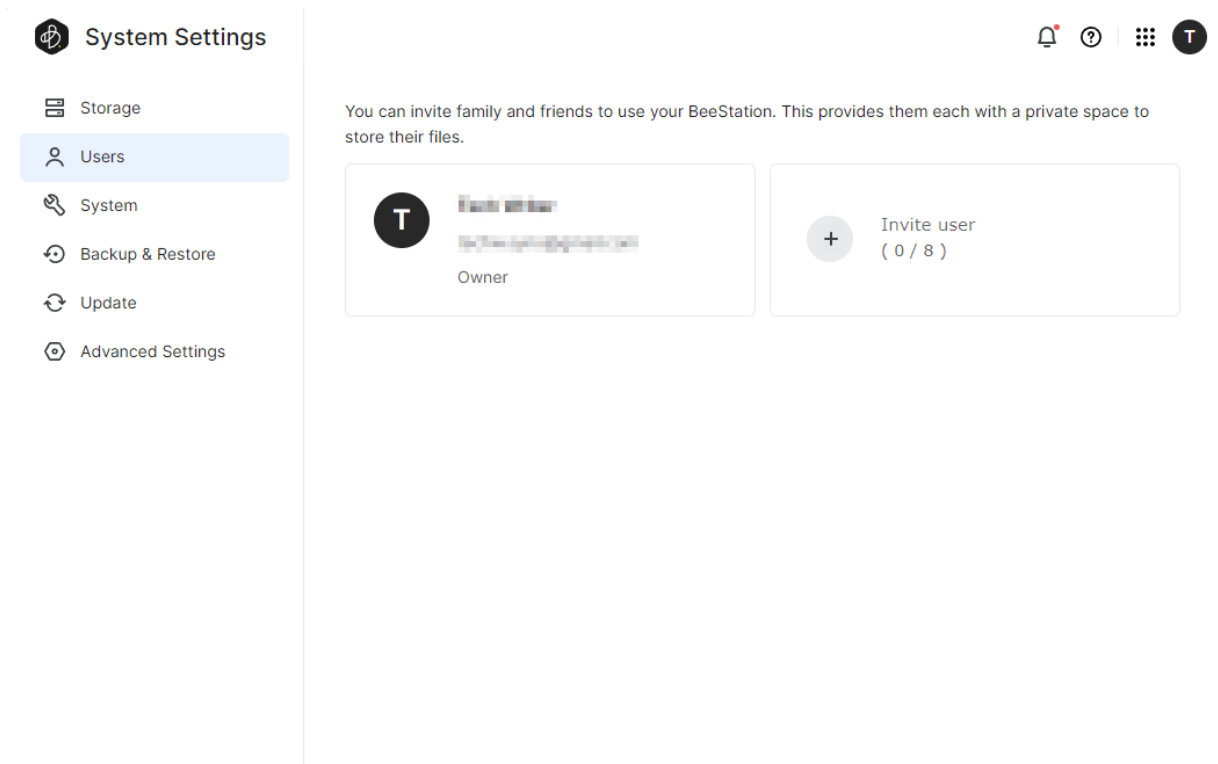

2. Copy the invite link and forward it to the person you're inviting.

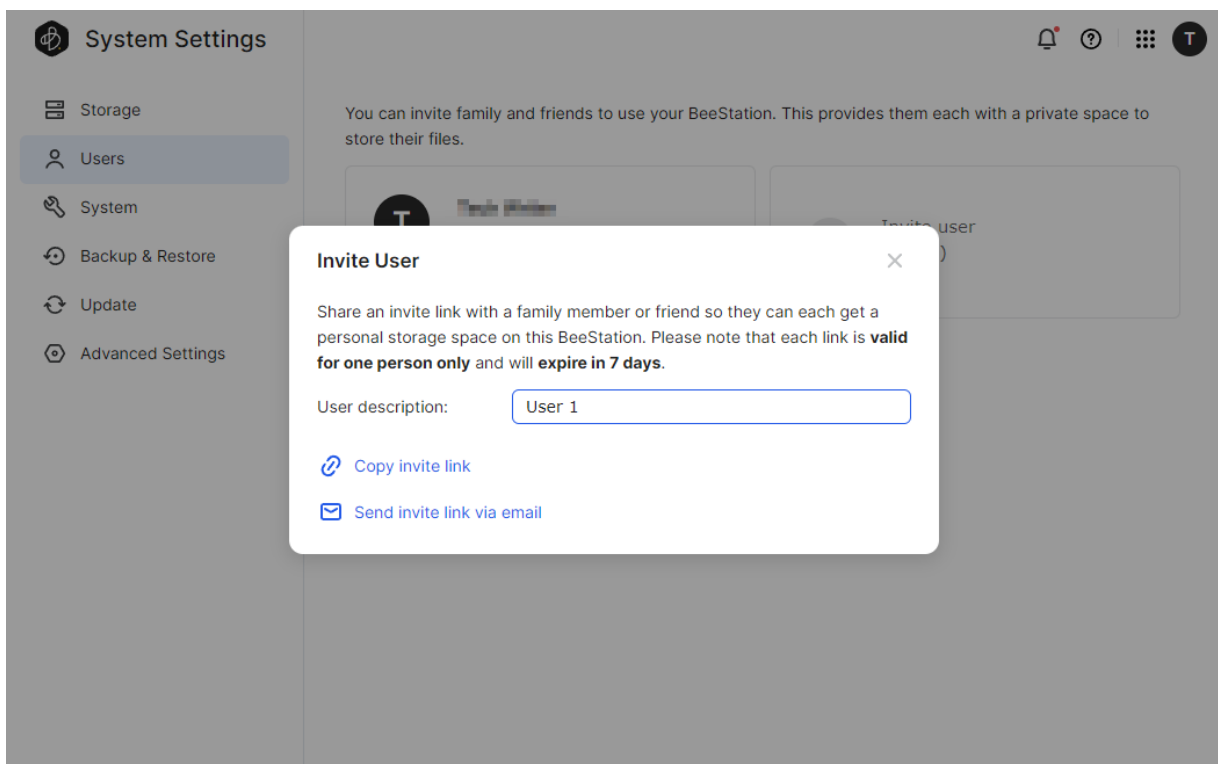

3. Once invitees click the link, they can sign in to your BeeStation with their Synology Account. They will be added to the user list.

## 6.2 Back Up Your BeeStation

1. Go to **Backup & Restore**, and click **Back Up Now**.

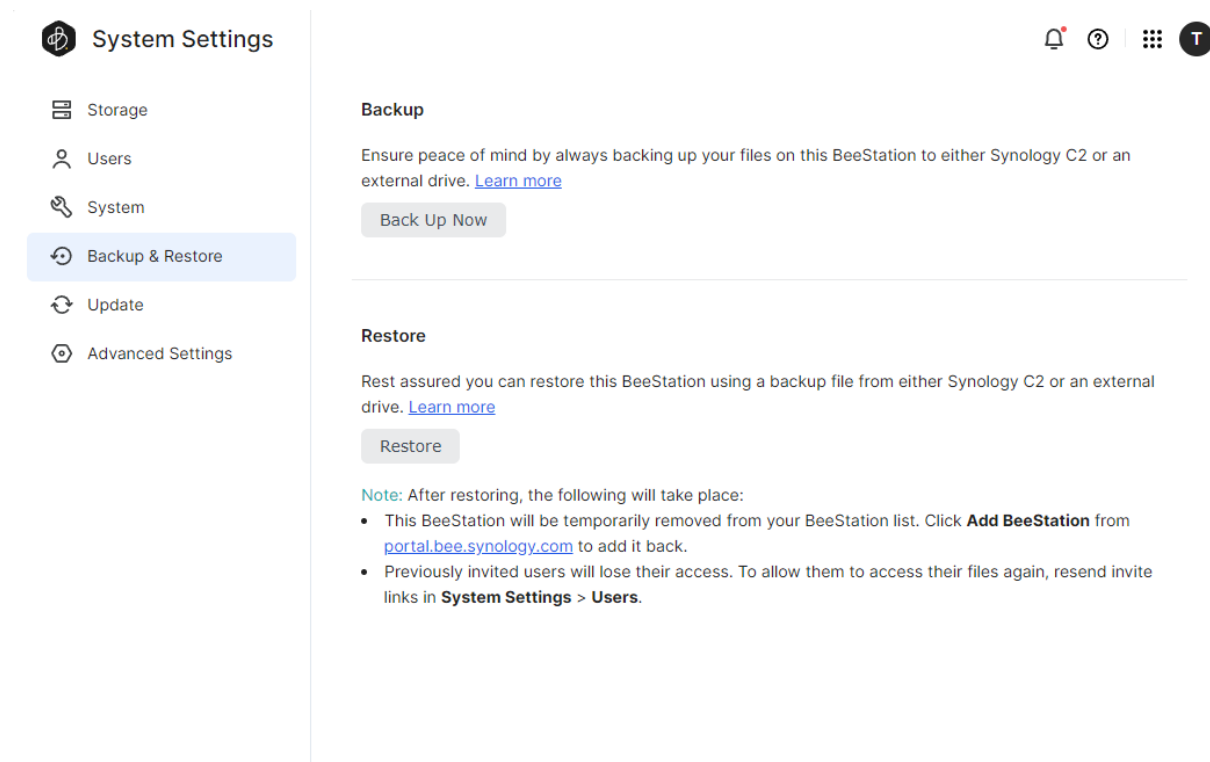

The screenshot shows the 'System Settings' interface. On the left is a sidebar with menu items: Storage, Users, System, Backup & Restore (highlighted), Update, and Advanced Settings. The main content area is titled 'Backup' and contains the following text: 'Ensure peace of mind by always backing up your files on this BeeStation to either Synology C2 or an external drive. [Learn more](#)'. Below this is a 'Back Up Now' button. A horizontal line separates this from the 'Restore' section, which contains the text: 'Rest assured you can restore this BeeStation using a backup file from either Synology C2 or an external drive. [Learn more](#)'. Below this is a 'Restore' button. A 'Note' follows: 'After restoring, the following will take place:' followed by two bullet points: 'This BeeStation will be temporarily removed from your BeeStation list. Click **Add BeeStation** from [portal.bee.synology.com](http://portal.bee.synology.com) to add it back.' and 'Previously invited users will lose their access. To allow them to access their files again, resend invite links in **System Settings > Users**.'

2. Select either **Synology C2 Storage** or **External drive** as the backup location. Note that a subscription is required for Synology C2 Storage.
3. You can schedule backups on a **Daily** or **Weekly** basis, and specify the start time.



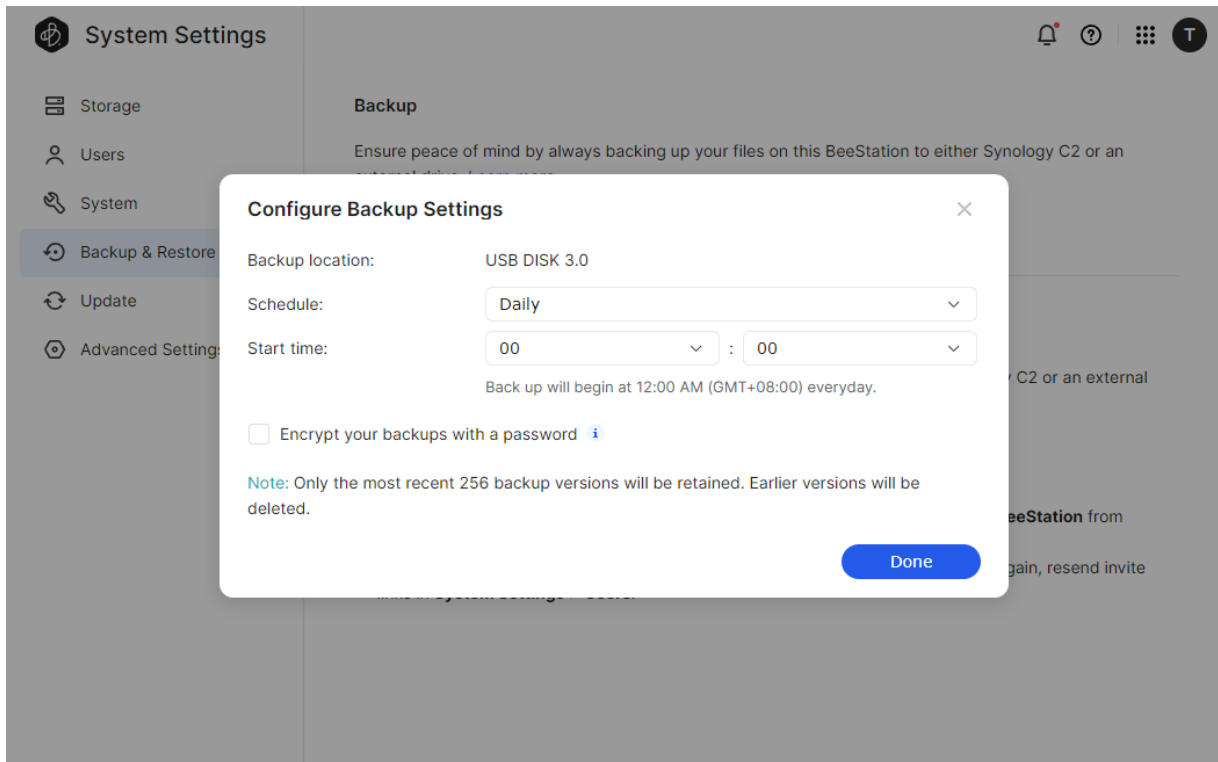

4. If you want to secure your backups, select **Encrypt your backups with a password** and enter the password. Make sure to remember the password and store the recovery key generated.

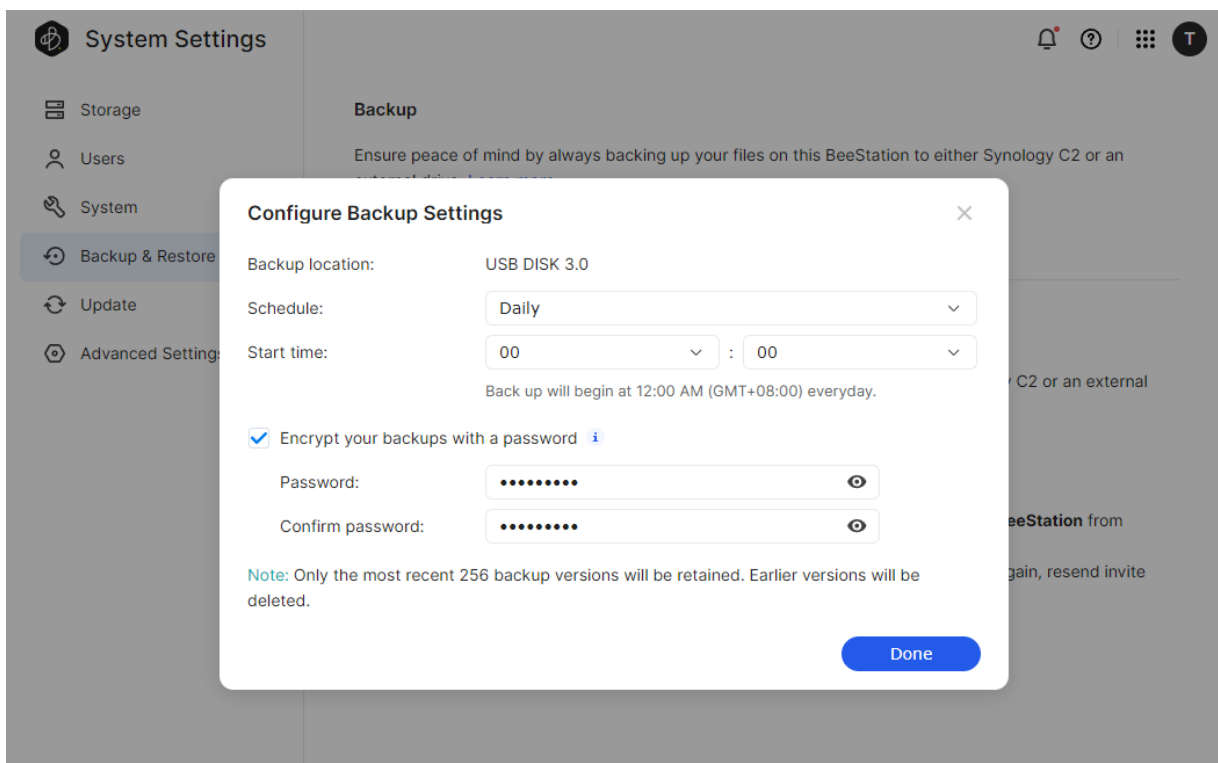

5. Click **Done**, and select **Back Up Now** to start backing up your BeeStation. You can restore the files and settings from the **Restore** section whenever needed.

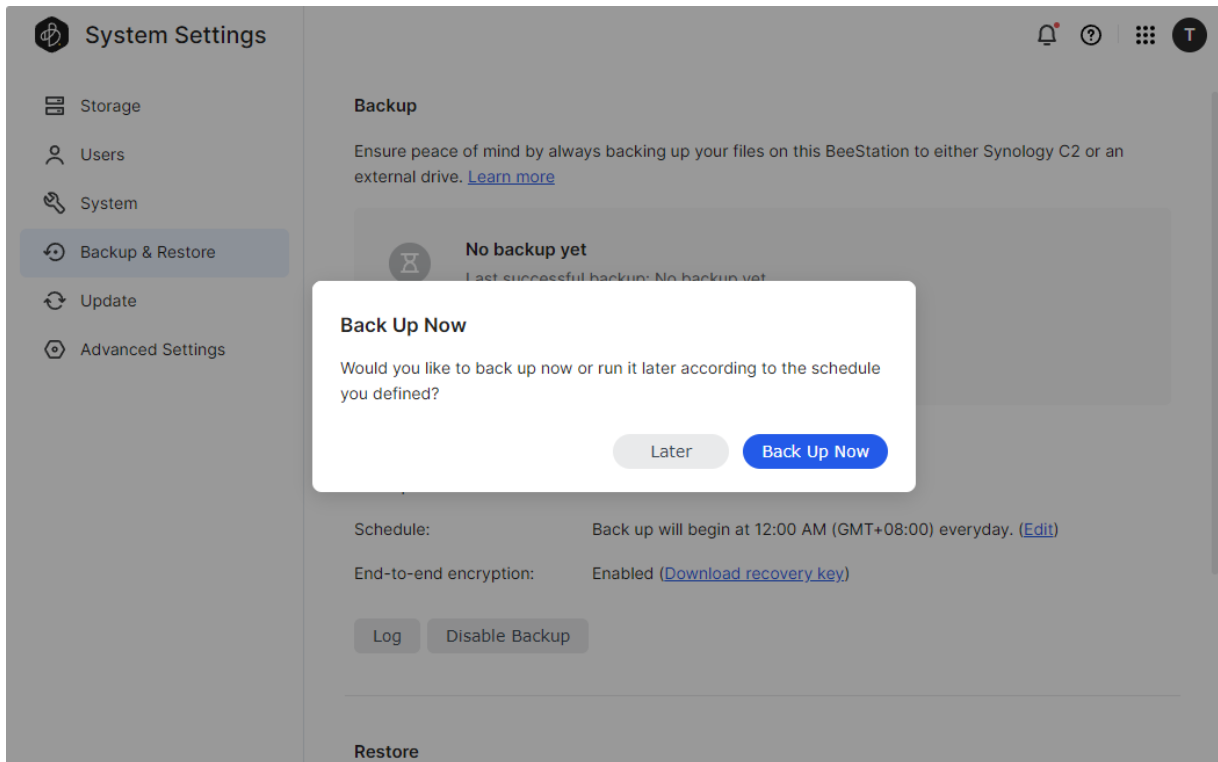

## 6.3 Software Update

In **Update**, you can view your BeeStation's software status and version. Enabling **Keep my BeeStation up to date** will automatically download new updates whenever they are available.

## 6.4 Set Up Local Access

After setting up local access, you can access BeeStation within your local network in various ways.

1. Go to **Advanced Settings > Local Access**.

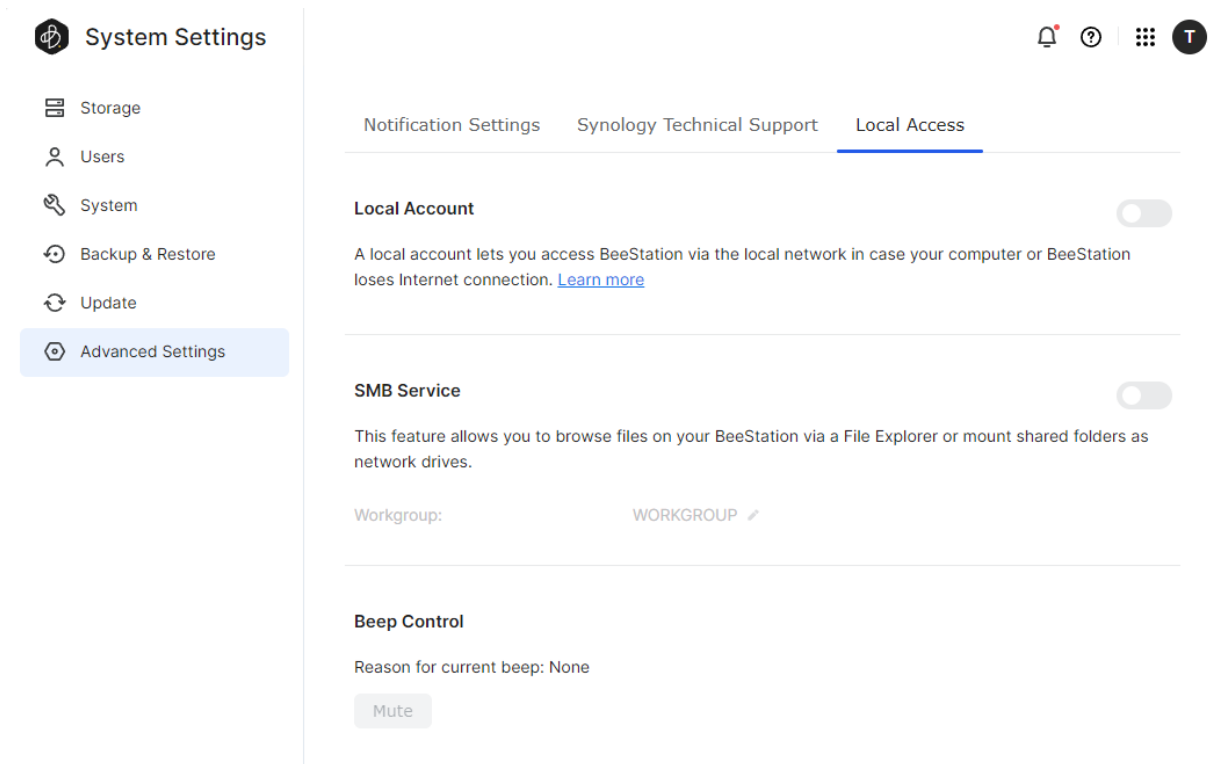

## 2. Enable **Local Account** and **SMB Service**.

- a. Toggle on **Local Account** and create a local account.

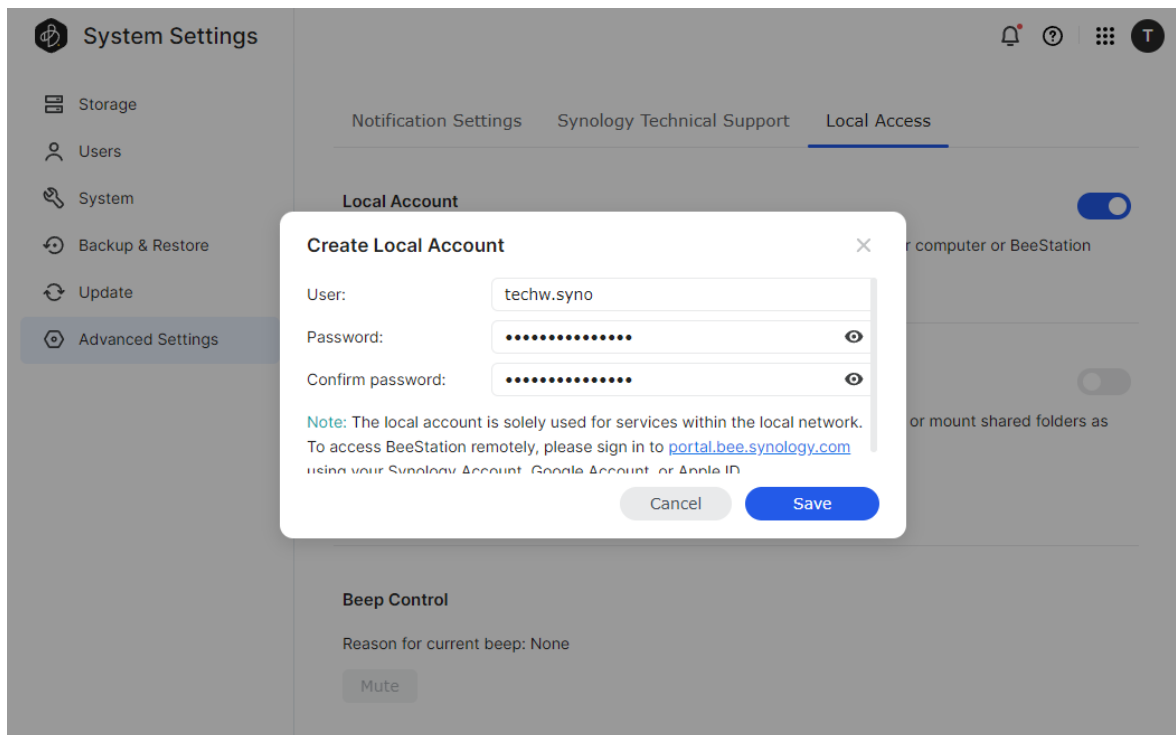

- b. Toggle on **SMB Service**.

## 3. You can now access your BeeStation using the local account.

## System Settings

- Storage
- Users
- System
- Backup & Restore
- Update
- Advanced Settings



- Notification Settings
- Synology Technical Support
- Local Access

### Local Account

A local account lets you access BeeStation via the local network in case your computer or BeeStation loses Internet connection. [Learn more](#)

Account:

Password: Last changed: 11/06/2023

[Change Password](#)

Enter the following IP address in the browser to access your BeeStation in your local network.

IP address: <https://192.168.1.1>

### SMB Service

This feature allows you to browse files on your BeeStation via a File Explorer or mount shared folders as network drives.

Enter the following address to access shared folders using a computer in your local network:

# Chapter 7: Unlink BeeStation

## 7.1 Unlink via BeeStation Web Portal

1. Go to [portal.bee.synology.com](https://portal.bee.synology.com).
2. Sign in with your Synology Account.
3. Click the **...** icon and select **Unlink**. Enter the code displayed to unlink the BeeStation from your Synology Account.

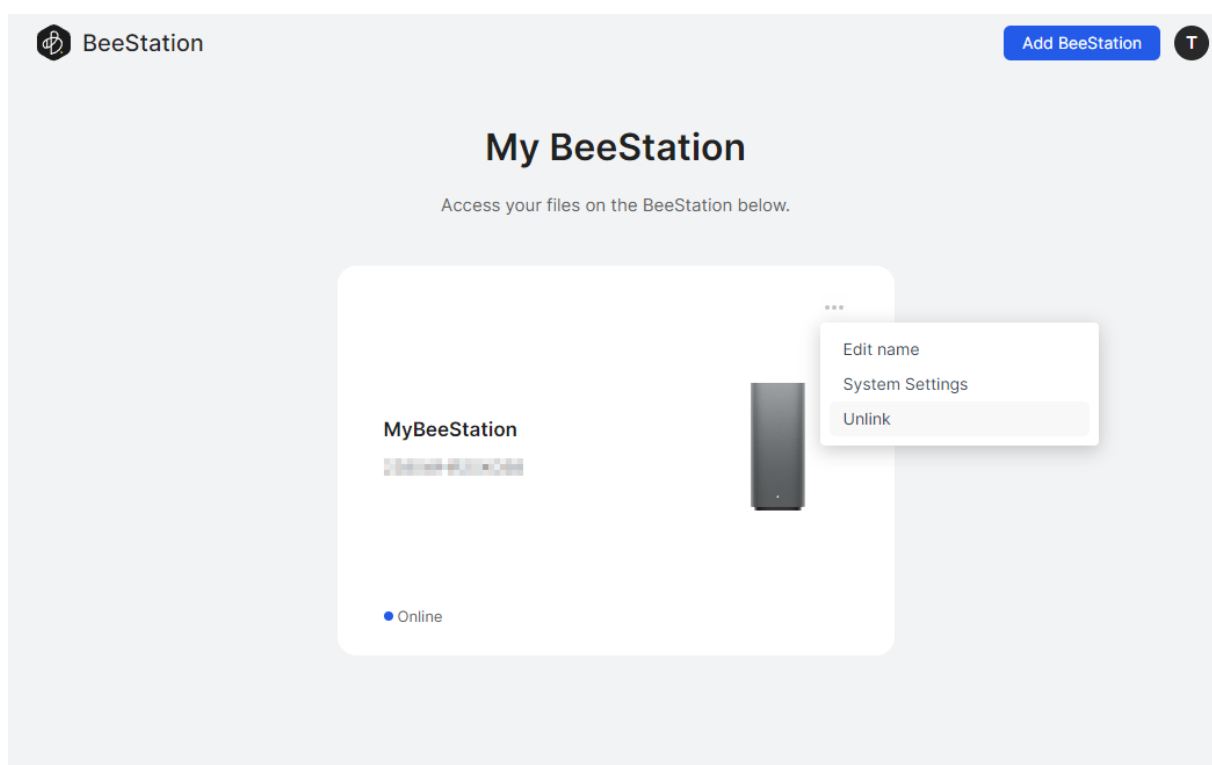

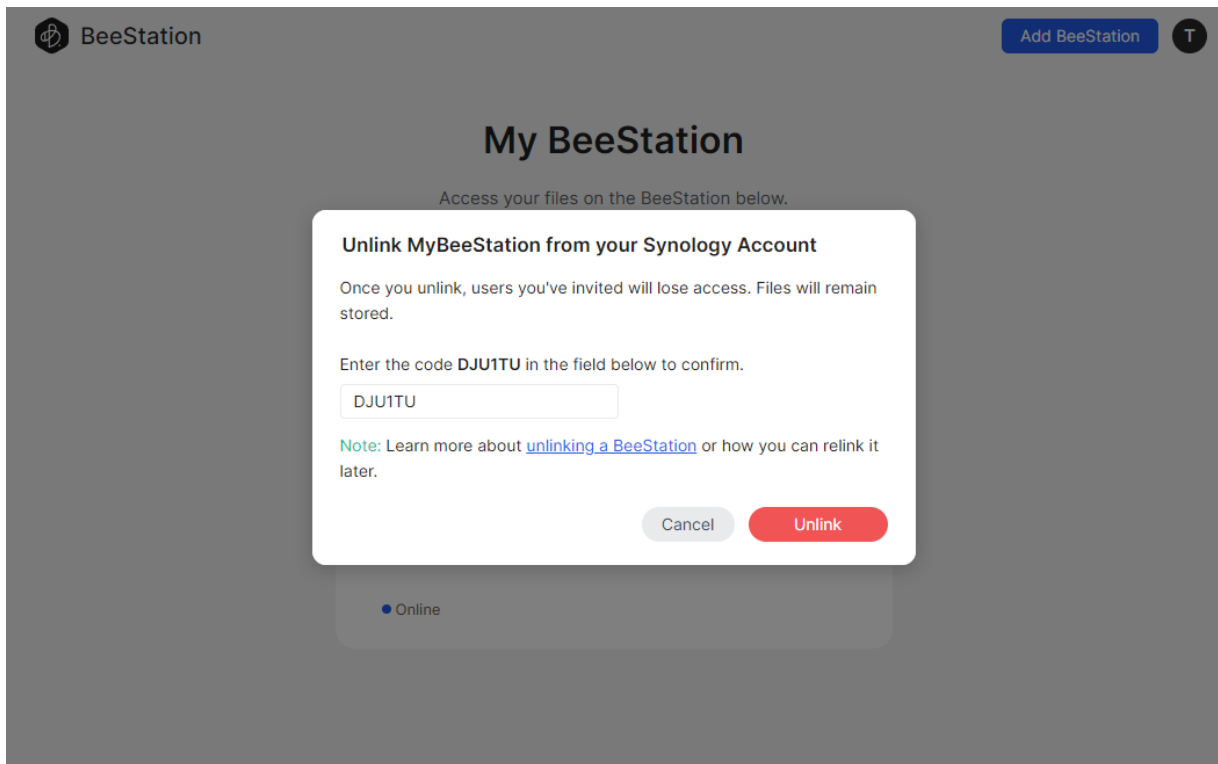

## 7.2 Unlink via BeeStation System Settings

1. Go to [portal.bee.synology.com](https://portal.bee.synology.com).
2. Sign in with your Synology Account.
3. Click the ... icon and select **System Settings**.

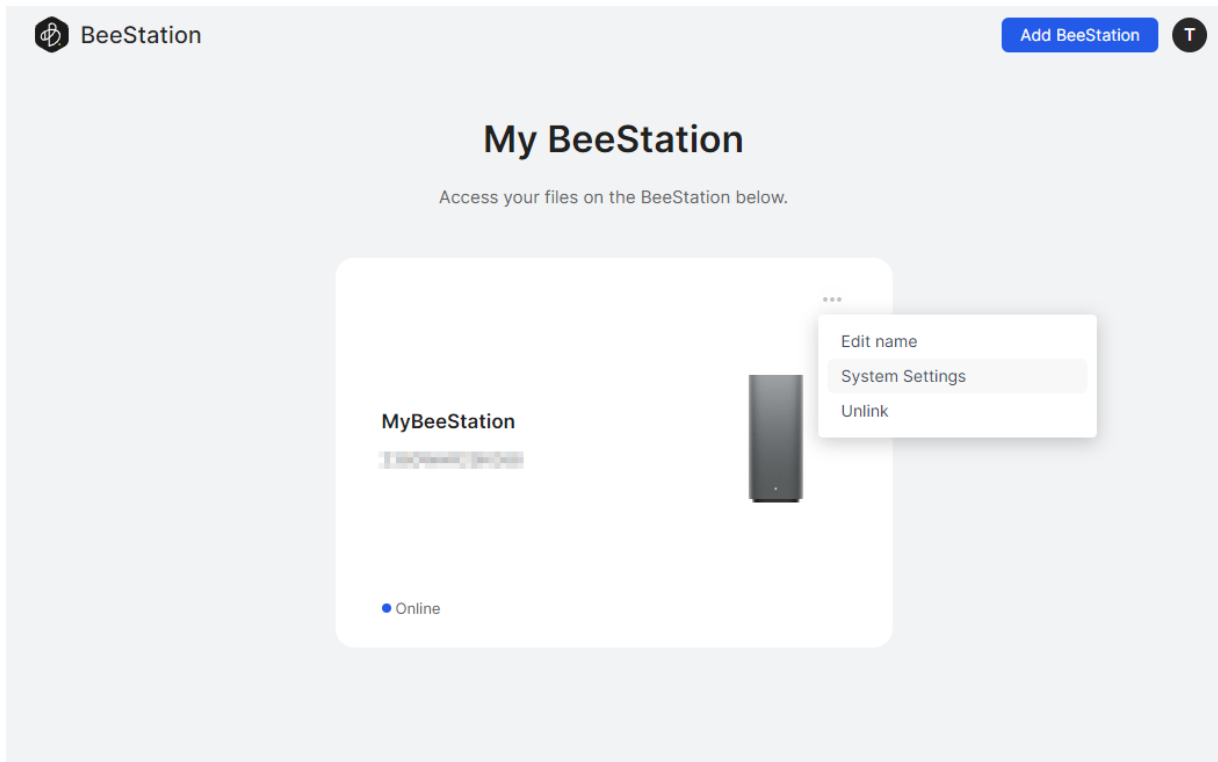

4. Go to **System**, click **Unlink this BeeStation** and enter the code displayed to unlink the BeeStation from your Synology Account.

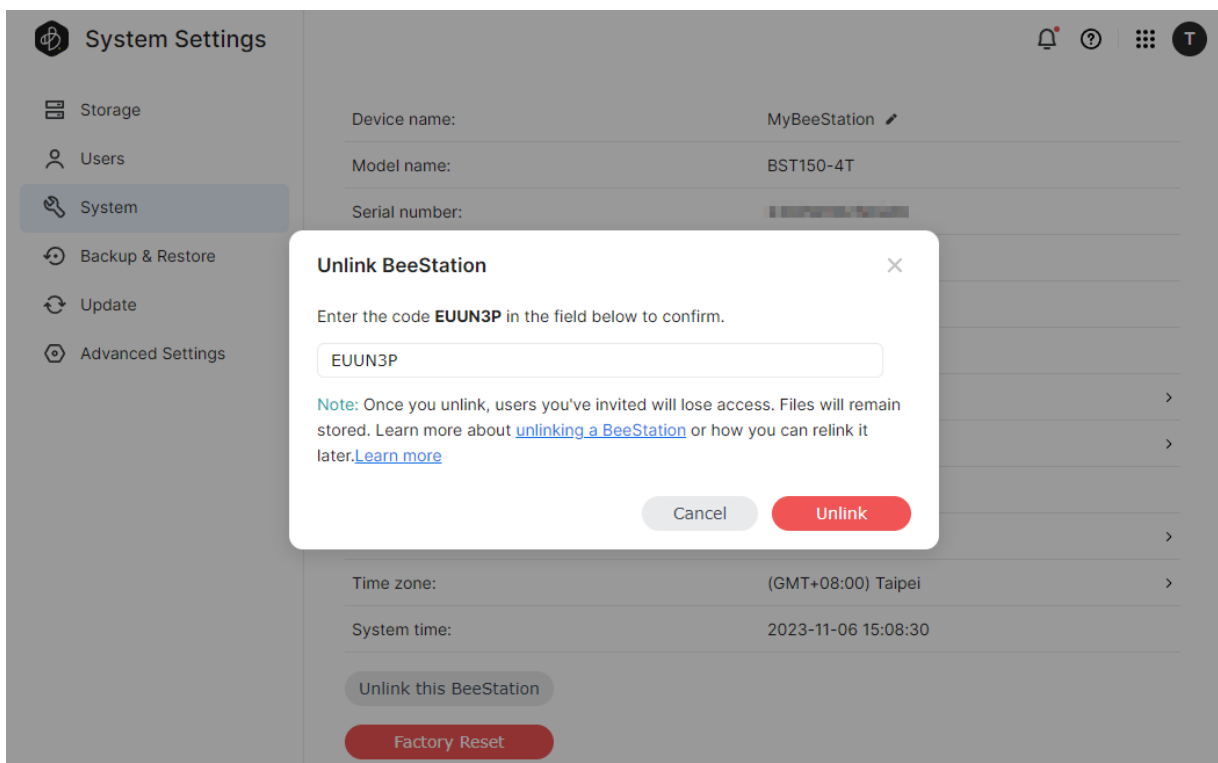

**Notes:**

1. Unlinking BeeStation will not remove all the data stored in it. For complete data deletion, click **Factory Reset**.



# Chapter 8: Troubleshooting

Refer to the following FAQ for troubleshooting common issues when using BeeStation:

- Starting up
  - [I can't add BeeStation to my Synology Account. What can I do?](#)
- Hardware
  - [What do the different BeeStation statuses indicate through LED lights?](#)
  - [What can I do if BeeStation encounters storage related issues?](#)
- Access
  - [Frequently asked questions about Synology Account access issues](#)
  - [How to access BeeStation within the local network](#)

# SYNOLOGY, INC.

## END USER LICENSE AGREEMENT

IMPORTANT—READ CAREFULLY: THIS END USER LICENSE AGREEMENT ("EULA") IS A LEGAL AGREEMENT BETWEEN YOU (EITHER AN INDIVIDUAL OR A LEGAL ENTITY) AND SYNOLOGY, INC. ("SYNOLOGY") FOR THE SYNOLOGY SOFTWARE INSTALLED ONTO THE SYNOLOGY PRODUCT PURCHASED BY YOU (THE "PRODUCT"), OR LEGALLY DOWNLOADED FROM [WWW.SYNOLOGY.COM](http://WWW.SYNOLOGY.COM), OR ANY OTHER CHANNEL PROVIDED BY SYNOLOGY ("SOFTWARE").

YOU AGREE TO BE BOUND BY THE TERMS OF THIS EULA BY USING THE PRODUCTS CONTAINING THE SOFTWARE, INSTALLING THE SOFTWARE ONTO THE PRODUCTS OR DEVICE CONNECTED TO THE PRODUCTS. IF YOU DO NOT AGREE TO THE TERMS OF THIS EULA, DO NOT USE THE PRODUCTS CONTAINING THE SOFTWARE OR DOWNLOAD THE SOFTWARE FROM [WWW.SYNOLOGY.COM](http://WWW.SYNOLOGY.COM), OR ANY OTHER CHANNEL PROVIDED BY SYNOLOGY. INSTEAD, YOU MAY RETURN THE PRODUCT TO THE RESELLER WHERE YOU PURCHASED IT FOR A REFUND IN ACCORDANCE WITH THE RESELLER'S APPLICABLE RETURN POLICY.

Section 1. Limited Software License. Subject to the terms and conditions of this EULA, Synology grants you a limited, non-exclusive, non-transferable, personal license to install, run and use one copy of the Software loaded on the Product or on your device connected to the Product solely relating to your authorized use of the Product.

Section 2. Documentation. You may make and use a reasonable number of copies of any documentation provided with the Software; provided that such copies will only be used for internal business purposes and are not to be republished or redistributed (either in hard copy or electronic form) to any third party.

Section 3. Backup. You may make a reasonable number of copies of the Software for backup and archival purposes only.

Section 4. Updates. Any software provided to you by Synology or made available on the Synology website at [www.synology.com](http://www.synology.com) ("Website") or any other channel provided by Synology that updates or supplements the original Software is governed by this EULA unless separate license terms are provided with such updates or supplements, in which case, such separate terms will govern.

Section 5. License Limitations. The license set forth in Sections 1, 2 and 3 applies only to the extent that you have ordered and paid for the Product and states the entirety of your rights with respect to the Software. Synology reserves all rights not expressly granted to you in this EULA. Without limiting the foregoing, you shall not authorize or permit any third party to: (a) use the Software for any purpose other than that in connection with the Product; (b) license, distribute, lease, rent, lend, transfer, assign or otherwise dispose of the Software; (c) reverse engineer, decompile, disassemble or attempt to discover the source code of or any trade secrets related to the Software, except and only to the extent that such conduct is expressly permitted by applicable law notwithstanding this limitation; (d) adapt, modify, alter, translate or create any derivative works of the Software; (e) remove, alter or obscure any copyright notice or other proprietary rights notice on the Software or Product; or (f) circumvent or attempt to circumvent any methods employed by Synology to control access to the components, features or functions of the Product or Software. Subject to the limitations specified in this Section 5, you are not prohibited from providing any services hosted by Synology NAS server to any third party for commercial purpose.

Section 6. Open Source. The Software may contain components licensed to Synology under the GNU General Public License ("GPL Components"), currently available at <http://www.gnu.org/licenses/gpl.html>. The terms of the GPL will control solely with respect to the GPL Components to the extent that this EULA conflicts with the requirements of the GPL with respect to your use of the GPL Components, and, in such event, you agree to be bound by the GPL with respect to your use of such components.

Section 7. Audit. Synology will have the right to audit your compliance with the terms of this EULA. You agree to grant Synology a right to access to your facilities, equipment, books, records and documents and to otherwise reasonably cooperate with Synology in order to facilitate any such audit by Synology or its agent authorized by Synology.

Section 8. Ownership. The Software is a valuable property of Synology and its licensors, protected by copyright and other intellectual property laws and treaties. Synology or its licensors own all rights, titles and interests in and to the Software, including but not limited to copyright and any other intellectual property rights.

Section 9. Limited Warranty. Synology provides a limited warrant that the Software will substantially conform to Synology's published specifications for the Software, if any, or otherwise set forth on the Website, for a period required by your local law. Synology will use commercially reasonable efforts to, in Synology's sole discretion, either correct any such nonconformity in the Software or replace any Software that fails to comply with the foregoing warranty, provided that you give Synology written notice of such noncompliance within the warranty period. The foregoing warranty does not apply to any noncompliance resulting from any: (w) use, reproduction, distribution or disclosure not in accordance with this EULA; (x) any customization, modification or other alteration of the Software by anyone other than Synology; (y) combination of the Software with any product, services or other items provided by anyone other than Synology; or (z) your failure to comply with this EULA.

Section 10. Support. During the period specified in the Section 9, Synology will make available to you the support services.

Following the expiration of the applicable period, support for Software may be available from Synology upon written request.

Section 11. Disclaimer of Warranties. EXCEPT AS EXPRESSLY SET FORTH ABOVE, THE SOFTWARE IS PROVIDED "AS IS" AND WITH ALL FAULTS. SYNOLOGY AND ITS SUPPLIERS HEREBY DISCLAIM ALL OTHER WARRANTIES, EXPRESS, IMPLIED OR STATUTORY, ARISING BY LAW OR OTHERWISE, INCLUDING BUT NOT LIMITED TO ANY IMPLIED WARRANTIES OF MERCHANTABILITY, FITNESS FOR A PARTICULAR PURPOSE OR USE, TITLE AND NONINFRINGEMENT, WITH REGARD TO THE SOFTWARE. WITHOUT LIMITING THE FOREGOING, SYNOLOGY DOES NOT WARRANT THAT THE SOFTWARE WILL BE FREE OF BUGS, ERRORS, VIRUSES OR OTHER DEFECTS.

Section 12. Disclaimer of Certain Damages. IN NO EVENT WILL SYNOLOGY OR ITS LICENSORS BE LIABLE FOR ANY INCIDENTAL, INDIRECT, SPECIAL, PUNITIVE, CONSEQUENTIAL OR SIMILAR DAMAGES OR LIABILITIES WHATSOEVER (INCLUDING, BUT NOT LIMITED TO LOSS OF DATA, INFORMATION, REVENUE, PROFIT OR BUSINESS) ARISING OUT OF OR RELATING TO THE USE OF OR INABILITY TO USE THE SOFTWARE OR OTHERWISE UNDER OR IN CONNECTION WITH THIS EULA OR THE SOFTWARE, WHETHER BASED ON CONTRACT, TORT (INCLUDING NEGLIGENCE), STRICT LIABILITY OR OTHER THEORY EVEN IF SYNOLOGY HAS BEEN ADVISED OF THE POSSIBILITY OF SUCH DAMAGES.

Section 13. Limitation of Liability. SYNOLOGY'S AND ITS SUPPLIERS' LIABILITY ARISING OUT OF OR RELATING TO THE USE OF OR INABILITY TO USE THE SOFTWARE OR OTHERWISE UNDER OR IN CONNECTION WITH THIS EULA OR THE SOFTWARE IS LIMITED TO THE AMOUNT ACTUALLY PAID BY YOU FOR THE PRODUCT REGARDLESS OF THE AMOUNT OF DAMAGES YOU MAY INCUR AND WHETHER BASED ON CONTRACT, TORT (INCLUDING NEGLIGENCE), STRICT LIABILITY OR OTHER THEORY. The foregoing disclaimer of warranties, disclaimer of certain damages and limitation of liability will apply to the maximum extent permitted by applicable law. The laws of some states/jurisdictions do not allow the exclusion of implied warranties or the exclusion or limitation of certain damages. To the extent that those laws apply to this EULA, the exclusions and limitations set forth above may not apply to you.

Section 14. Export Restrictions. You acknowledge that the Software is subject to U.S. export restrictions. You agree to comply with all applicable laws and regulations that apply to the Software, including without limitation the U.S. Export Administration Regulations.

Section 15. Termination. Without prejudice to any other rights, Synology may terminate this EULA if you do not abide by the terms and conditions contained herein. In such event, you must cease use of the Software and destroy all copies of the Software and all of its component parts.

Section 16. Assignment. You may not transfer or assign your rights under this EULA to any third party, except for that pre-installed in the Products. Any such transfer or assignment in violation of the foregoing restriction will be void.

Section 17. Applicable Law. Unless expressly prohibited by local law, this EULA is governed by and construed in accordance with the laws of the country, in accordance with which Synology Inc. was organized without regard to any conflict of law principles to the contrary.

Section 18. Dispute Resolution. Any dispute, controversy or claim arising out of or relating to this EULA will be resolved exclusively and finally by arbitration conducted by three neutral arbitrators in accordance with the procedures of the Arbitration Law and related enforcement rules of the country in which Synology Inc. was organized. In such cases, the arbitration will be limited solely to the dispute between you and Synology. The arbitration, or any portion of it, will not be consolidated with any other arbitration and will not be conducted on a class-wide or class action basis. The arbitration shall take place in Taipei and the arbitration proceedings shall be conducted in English or, if both parties so agree, in Mandarin Chinese. The arbitration award shall be final and binding on the parties and may be enforced in any court having jurisdiction. You understand that, in the absence of this provision, you would have had a right to litigate any such dispute, controversy or claim in a court, including the right to litigate claims on a class-wide or class-action basis, and you expressly and knowingly waive those rights and agree to resolve any disputes through binding arbitration in accordance with the provisions of this Section 18. Nothing in this Section shall be deemed to prohibit or restrict Synology from seeking injunctive relief or seeking such other rights and remedies as it may have at law or equity for any actual or threatened breach of any provision of this EULA relating to Synology's intellectual property rights.

Section 19. Attorneys' Fees. In any arbitration, mediation, or other legal action or proceeding to enforce rights or remedies under this EULA, the prevailing party will be entitled to recover, in addition to any other relief to which it may be entitled, costs and reasonable attorneys' fees.

Section 20. Severability. If any provision of this EULA is held by a court of competent jurisdiction to be invalid, illegal, or unenforceable, the remainder of this EULA will remain in full force and effect.

Section 21. Entire Agreement. This EULA sets forth the entire agreement of Synology and you with respect to the Software and the subject matter hereof and supersedes all prior and contemporaneous understandings and agreements whether written or oral. No amendment, modification or waiver of any of the provisions of this EULA will be valid unless set forth in a written instrument signed by the party to be bound thereby.

## SYNOLOGY, INC. LIMITED PRODUCT WARRANTY

THIS LIMITED WARRANTY ("WARRANTY") APPLIES TO THE PRODUCTS (AS DEFINED BELOW) OF SYNOLOGY, INC. AND ITS AFFILIATES, INCLUDING SYNOLOGY AMERICA CORP, (COLLECTIVELY, "SYNOLOGY"). YOU ACCEPT AND AGREE TO BE BOUND BY THE TERMS OF THIS WARRANTY BY OPENING THE PACKAGE CONTAINING AND/OR USING THE PRODUCT. PLEASE BE ADVISED THAT THIS LIMITED WARRANTY DOES NOT APPLY TO THE SOFTWARE CONTAINED IN THE PRODUCTS WHICH SHALL BE SUBJECT TO ITS END USER LICENSE AGREEMENT, AND THAT SYNOLOGY RESERVES THE RIGHT TO MAKE ADJUSTMENTS AND/OR MODIFICATION TO THIS PRODUCT WARRANTY FROM TIME TO TIME WITHOUT PROVIDING PRIOR NOTICE TO YOU. IF YOU DO NOT AGREE TO THE TERMS OF THIS WARRANTY, DO NOT USE THE PRODUCT. INSTEAD, YOU MAY RETURN THE PRODUCT TO THE RESELLER WHERE YOU PURCHASED IT FOR A REFUND IN ACCORDANCE WITH THE RESELLER'S APPLICABLE RETURN POLICY.

PLEASE NOTE THAT SYNOLOGY'S WARRANTY SUPPORTS ARE NOT AVAILABLE IN EVERY COUNTRY, AND THAT SYNOLOGY MAY REFUSE TO PROVIDE THIS LIMITED WARRANTY SUPPORTS TO YOU IF YOU REQUEST SUCH SUPPORTS NOT AT THE COUNTRY AT WHICH THE PRODUCT WAS ORIGINALLY PURCHASED. THE COUNTRY AT WHICH THE PRODUCT WAS ORIGINALLY PURCHASED SHALL BE DETERMINED BASED ON THE SYNOLOGY'S INTERNAL RECORDS.

Local Consumer Protection Laws. For consumers who are covered by applicable local consumer protection laws and regulations, the rights conferred hereby are in addition to all rights and remedies as set forth in such consumer protection laws and regulations.

### Section 1. Products

(a) "Products" refer to New Products or Refurbished Products.

(b) "New Product" means the Synology-branded hardware product and Synology-branded accessories contained in the original packaging Customer bought from an authorized Synology distributor or reseller. You may see our "New Product" at [Product Support Status](#).

(c) "Refurbished Product" means all Synology products which have been refurbished by Synology's affiliate or an authorized Synology distributor or reseller, not including those sold as "as is" or with "no warranty" by anyone.

(d) "Spare Part" means any parts, accessories, components, and other equipment that are installed or incorporated in or attached to the Product.

(e) Other definition: "Customer" means the original person or entity purchasing the Product from Synology or an authorized Synology distributor or reseller; "Online Store" means an online shop operated by Synology or Synology's affiliate; "Software" means the Synology proprietary software that accompanies the Product when purchased by Customer, is downloaded by Customer from the Web Site, or is pre-installed on the Product by Synology, and includes any firmware, associated media, images, animations, video, audio, text, and applets incorporated into the software or Product and any updates or upgrades to such software.

### Section 2. Warranty Period

(a) "Warranty Period": The warranty period commences on the purchase date is shown on the purchase receipt or invoice to be presented by Customer and ending at the day after the end of the Warranty Period for each New Product. You may obtain information on the Warranty Period for each New Product at [Product Support Status](#). For Spare Part, Warranty Period under normal use is one year (five years for system drives) from the date the Product was purchased. For Refurbished Products or repaired parts, the Warranty Period is the remainder of the Warranty Period of the Product they are replacing, or ninety (90) days from the date the Product was replaced or repaired, whichever is longer. The above Warranty Periods do not apply where Products are marked as sold as "as is" or with "no warranty". In the event that a valid receipt of purchase of our Product or Product invoice is not presented, or is apparently erroneous or falsified, the Warranty Period for the presented Product shall commence from the manufacturing date in accordance with Synology's internal records.

(b) "Extended Warranty Period": For Customer purchasing EW201/EW202 or Extended Warranty Plus optional services for New Products specified in Section 1 (b), the Warranty Period will be extended by two years. For EW201/EW202, you may see the applicable Product models and available regions at [EW201/EW202 Extended Warranty](#). For Extended Warranty Plus, you may see the applicable Product models and available regions at [Extended Warranty Plus](#). Customer can only choose either of the optional services.

(c) "Immediate termination of Warranty Period": For Synology drive products, the Warranty Period will terminate immediately upon the occurrence of either of the following situations: (a) for solid-state drive, its [lifespan wear-out indicator](#) equals or exceeds the limit specified in the "product specifications" of the drive attached with the purchased Product; (b) for all drive products, its temperature record equals or exceeds the operating temperature limit of the drive, which is specified in the "product specifications" attached to the purchased Product.

### Section 3. Limited Warranty and Remedies

**3.1 Limited Warranty.** Subject to Section 3.2, Synology warrants to the Customer that each Product (a) will be free of material defects in workmanship and (b) under normal use will perform substantially in accordance with Synology's published specifications for the Product during the Warranty Period. Such limited warranty does not apply to the Software contained in the product or purchased by Customer which shall be subject to the accompanying end user license agreement provided with the Product. Synology provides no warranty for Refurbished Product sold as "as is" or with "no warranty".

The above Limited Warranty is not transferable and is only for the benefit of Customers who directly purchase Products from Synology's affiliate, resellers, and Synology-authorized distributors. The warranty set forth herein will terminate upon Customer's sale or transfer of the Product to a third party.

**3.2 Exclusions.** The foregoing warranties and warranty obligations do not apply to any Product that (a) has been installed or used in a manner not specified or described in the Product, specifications, or its related documents, or in any way misused, abused, or damaged; (b) has been damaged caused by accident, fire, liquid contact, earthquake, other external factor or product use in improper environment; (c) has been disassembled without authorization from Synology; or (d) with cosmetic damage caused by normal wear and tear or otherwise due to the normal aging of the Product, including but not limited to scratches, dents and broken plastic on ports unless failure has occurred due to a defect in materials or workmanship; (e) serial number has been removed or defaced from Product, resulting in not able to identify; (f) has been damaged or out of order because Customer fails to implement any correction, modification, enhancement, improvement or other update made available to Customer by Synology, or because Customer implements, installs or uses any correction, modification, enhancement, improvement or other update made available by any third party; (g) has been damaged, out-of-order, or incompatible due to installation or use with items not provided by Synology other than the hardware, software or other accessory for which the Product is designed.

Please note that each of the above situations shall be subject to the inspection and verification of the Product's appearance and functions by Synology. Synology may refuse to provide any warranty services, including but not limited to product repair, technical support, and product replacement as described in Section 3.3 to any Product under any of the above situations.

**3.3 Warranty Support and Exclusive Remedy.** If Customer gives notice of noncompliance with any of the warranties set forth in Section 3.1 within the applicable Warranty Period in the manner set forth below, then, upon verification of the noncompliance by Synology, Synology will, at Synology's option: (a) use commercially reasonable efforts to repair the Product, (b) provide technical support, or (c) replace the noncomplying Product or part thereof upon return of the complete Product in accordance with Section 3.4. The foregoing sets forth Synology's entire liability and Customer's sole and exclusive remedy for any breach of warranty under Section 3.1 or any other defect or deficiency in the Product. Customer will reasonably assist Synology to diagnose and validate any nonconformity with the Product. Please note that the warranty support does not apply to rescue of the data stored in Synology Product or its backup. Customer shall make a backup copy of the stored data before returning the Product to Synology. Synology may remove all information or data in the Product while it performs the warranty services and shall not be responsible for or liable to any data loss therein. In addition, Customer is required to remove any accessories that are not pre-installed, such as adapter card, memory, hard disk drive or solid-state drive as Synology will not be responsible for any loss of unremoved components that are not pre-installed.

**3.4 Return.** For warranty claims, the Customer must return the complete Product to Synology in accordance with this Section 3.4. Any returned Product which (a) has been disassembled (except under the direction of Synology); or from which (b) the serial number has been removed or defaced, causing inability to identify, or which (c) was damaged on the way of return because of improper packaging (including but not limited to scratches and deformation), will be refused and returned to Customer at Customer's expense. Any Product must be returned in the same condition as it was received from Synology to the address designated by Synology, freight pre-paid, in packaging sufficient to protect the contents thereof. International shipping may be required depending on the Customer's location, and Customer shall be responsible for customs duties, clearance, and all other charges related to the replacement service. Customer is responsible for insurance and risk of loss and/or damage with respect to returned items until they are properly received by Synology.

**3.4.1 General Replacement Service.** Any Product returned by Customer under Section 3.3 must be made in accordance with Synology's then-current replacement procedures with the purchase receipt or invoice. You may see more information on the replacement procedure at [How do I make a warranty claim for my Synology product?](#)

**3.4.2 Extended Warranty Plus Service.** (Only applicable to the Customer purchasing Extended Warranty Plus)

(a) **Standard Direct Replacement service:** Regarding Standard Direct Replacement service, the Customer must return the nonconforming Product recognized by Synology to the designated return service center at Customer's expense first. The replacement will not be shipped until the nonconforming Product is received at Synology's designated return service center.

(b) **Advanced Direct Replacement service:** Regarding Advanced Direct Replacement service, Synology will ship the replacement Product to the address specified by the Customer before the Customer returns the nonconforming Product. Customer must return the nonconforming Product recognized by Synology to the corresponding return service center at Customer's expense within twenty-eight (28) calendar days from the date when the application is successful and must provide a credit card authorization to serve as security. The credit card authorization will be

canceled after Synology has received the nonconforming Product returned by the Customer. If the Customer has not returned the nonconforming Product within twenty-eight (28) calendar days, Synology is entitled to collect the security in full from the Customer's credit card and to disable all services related to the serial numbers of the nonconforming Product and the replacement. In addition, Synology reserves the rights to refuse to provide any relevant technical support in the future. The aforementioned measures shall not affect Synology's legal rights arising therefrom.

3.5 Replacement of New Product or Refurbished Product by Synology. If Synology elects to replace any Product under this Warranty set forth in Section 3.1, then Synology will ship a replacement Product at Synology's expense via the shipping method selected by Synology after receipt of the nonconforming Product returned in accordance with Section 3.4 and validation by Synology that the Product does not conform to the warranty. Before the shipment of the Refurbished Product to the Customers, they have been verified to strictly comply with Synology's quality standard. Please note that part of the Refurbished Products would be with certain stain, scratches, or other minor wear and tear. In some countries, Synology may at its own discretion apply the Synology Replacement Service to certain Products, through which Synology will ship a replacement Product to Customer before its receipt of the nonconforming Product returned by Customer ("Synology Replacement Service").

3.6 Disclaimer of Warranties. THE WARRANTIES, OBLIGATIONS, AND LIABILITIES OF SYNOLOGY AND THE REMEDIES OF CUSTOMER SET FORTH IN THIS WARRANTY ARE EXCLUSIVE AND IN SUBSTITUTION FOR, AND CUSTOMER HEREBY WAIVES, RELEASES AND DISCLAIMS, ALL OTHER WARRANTIES, OBLIGATIONS AND LIABILITIES OF SYNOLOGY AND ALL OTHER RIGHTS, CLAIMS AND REMEDIES OF CUSTOMER AGAINST SYNOLOGY, EXPRESS OR IMPLIED, ARISING BY LAW OR OTHERWISE, WITH RESPECT TO THE PRODUCT, ACCOMPANYING DOCUMENTATION OR SOFTWARE AND ANY OTHER GOODS OR SERVICES DELIVERED UNDER THIS WARRANTY, INCLUDING, BUT NOT LIMITED TO ANY: (A) IMPLIED WARRANTY OF MERCHANTABILITY OR FITNESS FOR A PARTICULAR PURPOSE OR USE; (B) IMPLIED WARRANTY ARISING FROM COURSE OF PERFORMANCE, COURSE OF DEALING, OR USAGE OF TRADE; (C) CLAIM OF INFRINGEMENT OR MISAPPROPRIATION; OR (D) CLAIM IN TORT (WHETHER BASED ON NEGLIGENCE, STRICT LIABILITY, PRODUCT LIABILITY OR OTHER THEORY). SYNOLOGY MAKES NO GUARANTEE AND SPECIFICALLY DISCLAIMS ANY WARRANTY THAT THE DATA OR INFORMATION STORED ON ANY SYNOLOGY PRODUCT WILL BE SECURE AND WITHOUT RISK OF DATA LOSS. SYNOLOGY RECOMMENDS THAT CUSTOMER TAKES APPROPRIATE MEASURES TO BACK UP THE DATA STORED ON THE PRODUCT. SOME STATES/JURISDICTIONS DO NOT ALLOW LIMITATIONS ON IMPLIED WARRANTIES, SO THE ABOVE LIMITATION MAY NOT APPLY TO CUSTOMER.

3.7 Extended Warranty Plus Limitations. (a) The Customer must complete the purchase of the Extended Warranty Plus Service within ninety (90) days following the original purchase date of the new Product. (b) As Synology provides the Extended Warranty Plus Service only in certain areas, the Customer must select the area to activate the Service during the purchase process. If the Customer requests Extended Warranty Plus Service from an area other than the selected area, Synology, at its sole discretion, may not provide Extended Warranty Plus Service; (c) Exceptions to coverage: The Extended Warranty Plus Service does not apply to overseas departments, overseas territories, overseas autonomous regions, and islands other than the main island of the countries and regions.

#### Section 4. Limitations of Liability

4.1 Force Majeure. Synology will not be liable for, or be considered to be in breach of or default under this Warranty on account of, any delay or failure to perform as required by this Warranty as a result of any cause or condition beyond its reasonable control (including, without limitation, any act or failure to act by Customer).

4.2 Disclaimer of Certain Damages. IN NO EVENT WILL SYNOLOGY OR ITS SUPPLIERS BE LIABLE FOR THE COST OF COVER OR FOR ANY INCIDENTAL, INDIRECT, SPECIAL, PUNITIVE, CONSEQUENTIAL OR SIMILAR DAMAGES OR LIABILITIES WHATSOEVER (INCLUDING, BUT NOT LIMITED TO LOSS OF DATA, INFORMATION, REVENUE, PROFIT OR BUSINESS) ARISING OUT OF OR RELATING TO THE USE OR INABILITY TO USE THE PRODUCT, ANY ACCOMPANYING DOCUMENTATION OR SOFTWARE AND ANY OTHER GOODS OR SERVICES PROVIDED UNDER THIS WARRANTY, WHETHER BASED ON CONTRACT, TORT (INCLUDING NEGLIGENCE), STRICT LIABILITY OR OTHER THEORY EVEN IF SYNOLOGY HAS BEEN ADVISED OF THE POSSIBILITY OF SUCH DAMAGES.

4.3 Limitation of Liability. SYNOLOGY'S AND ITS SUPPLIERS' LIABILITY ARISING OUT OF OR RELATING TO THE USE OR INABILITY TO USE THE PRODUCT, ANY ACCOMPANYING DOCUMENTATION OR SOFTWARE AND ANY OTHER GOODS OR SERVICES PROVIDED UNDER THIS WARRANTY IS LIMITED TO THE AMOUNT ACTUALLY PAID BY CUSTOMER FOR THE PRODUCT REGARDLESS OF THE AMOUNT OF DAMAGES CUSTOMER MAY INCUR AND WHETHER BASED ON CONTRACT, TORT (INCLUDING NEGLIGENCE), STRICT LIABILITY OR OTHER THEORY. The foregoing disclaimer of certain damages and limitation of liability will apply to the maximum extent permitted by applicable law. The laws of some states/jurisdictions do not allow exclusion or limitation of certain damages. To the extent that those laws apply to the Product, the exclusions and limitations set forth above may not apply to Customer.

#### Section 5. Miscellaneous

5.1 Proprietary Rights. The Product and any accompanying Software and documentation provided with the Product include

proprietary and intellectual property rights of Synology and its third party suppliers and licensors. Synology retains and reserves all right, title, and interest in the intellectual property rights of the Product, and no title to or ownership of any intellectual property rights in or to the Product, any accompanying Software or documentation and any other goods provided under this Warranty is transferred to Customer under this Warranty. Customer will (a) comply with the terms and conditions of the Synology end user license agreement accompanying any Software furnished by Synology or an authorized Synology distributor or reseller; and (b) not attempt to reverse engineer any Product or component thereof or accompanying Software or otherwise misappropriate, circumvent or violate any of Synology's intellectual property rights.

5.2 Assignment. Customer will not assign any of its rights under this Warranty directly, by operation of law or otherwise, without the prior written consent of Synology.

5.3 No Additional Terms. Except as expressly permitted by this Warranty, neither party will be bound by, and each party specifically objects to, any term, condition or other provision that conflicts with the provisions of this Warranty that is made by the other party in any purchase order, receipt, acceptance, confirmation, correspondence or otherwise, unless each party specifically agrees to such provision in writing. Further, if this Warranty conflicts with any terms or conditions of any other agreement entered into by the parties with respect to the Product, this Warranty will prevail unless the other agreement specifically references the sections of this Warranty that it supersedes.

5.4 Applicable Law. Unless explicitly prohibited by local law, this Warranty is governed by the laws of the State of Washington, U.S.A. for the Customers residing within the United States; and by the laws of the Republic of China (Taiwan) for Customers not residing within the United States, without regard to any conflict of law principles to the contrary. The 1980 U.N. Convention on Contracts for the International Sale of Goods or any successor thereto does not apply.

5.5 Dispute Resolution. Any dispute, controversy or claim arising out of or relating to this Warranty, the Product or services provided by Synology with respect to the Product or the relationship between Customers residing within the United States and Synology will be resolved exclusively and finally by arbitration under the current commercial rules of the American Arbitration Association, except as otherwise provided below. The arbitration will be conducted before a single arbitrator, and will be limited solely to the dispute between Customer and Synology. The arbitration, or any portion of it, will not be consolidated with any other arbitration and will not be conducted on a class-wide or class action basis. The arbitration shall be held in King County, Washington, U.S.A. by submission of documents, by telephone, online or in person as determined by the arbitrator at the request of the parties. The prevailing party in any arbitration or legal action occurring within the United States or otherwise shall receive all costs and reasonable attorneys' fees, including any arbitration fee paid by the prevailing party. Any decision rendered in such arbitration proceedings will be final and binding on the parties, and judgment may be entered thereon in any court of competent jurisdiction. Customer understands that, in the absence of this provision, Customer would have had a right to litigate any such dispute, controversy or claim in a court, including the right to litigate claims on a class-wide or class-action basis, and Customer expressly and knowingly waives those rights and agrees to resolve any disputes through binding arbitration in accordance with the provisions of this Section 5.5. For Customers not residing within the United States, any dispute, controversy or claim described in this section shall be finally resolved by arbitration conducted by three neutral arbitrators in accordance with the procedures of the R.O.C. Arbitration Law and related enforcement rules. The arbitration shall take place in Taipei, Taiwan, R.O.C., and the arbitration proceedings shall be conducted in English or, if both parties so agree, in Mandarin Chinese. The arbitration award shall be final and binding on the parties and may be enforced in any court having jurisdiction. Nothing in this Section shall be deemed to prohibit or restrict Synology from seeking injunctive relief or seeking such other rights and remedies as it may have at law or equity for any actual or threatened breach of any provision of this Warranty relating to Synology's intellectual property rights.

5.6 Attorneys' Fees. In any arbitration, mediation, or other legal action or proceeding to enforce rights or remedies under this Warranty, the prevailing party will be entitled to recover, in addition to any other relief to which it may be entitled, costs and reasonable attorneys' fees.

5.7 Export Restrictions. You acknowledge that the Product may be subject to U.S. export restrictions. You will comply with all applicable laws and regulations that apply to the Product, including without limitation the U.S. Export Administration Regulations.

5.8 Severability. If any provision of this Warranty is held by a court of competent jurisdiction to be invalid, illegal, or unenforceable, the remainder of this Warranty will remain in full force and effect.

5.9 Entire Agreement. This Warranty constitutes the entire agreement, and supersedes any and all prior agreements, between Synology and Customer related to the subject matter hereof. No amendment, modification or waiver of any of the provisions of this Warranty will be valid unless set forth in a written instrument signed by the party to be bound thereby.

5.10 Extended Warranty Plus Service Payment and Termination. (a) Upon verifying the purchase order by Synology, the Customer shall immediately pay all charges and tax. Synology reserves the right to refuse to provide the Extended Warranty Plus Service to Customer who are ineligible or who are under statutory age. (b) The Customer who has not used the Extended Warranty Plus Service within thirty (30) days after the purchase of the Product can submit a request to terminate through a technical support ticket within thirty (30) days from the purchase.

## **FCC Declaration of Conformity**

This device complies with Part 15 of the FCC Rules. Operation is subject to the following two conditions: (1) this device may not cause harmful interference, and (2) this device must accept any interference received, including interference that may cause undesired operation.



この装置は、クラス B 機器です。この装置は、住宅環境で使用することを目的としていますが、この装置がラジオやテレビジョン受信機に近接して使用されると、受信障害を引き起こすことがあります。

取扱説明書に従って正しい取り扱いをして下さい。

VCCI — B

## **Declaration Letter of REACH & RoHS Compliance**

### **About REACH**

In June 2007, the European Union Regulation (EC) 1907/2006 concerning the Registration, Evaluation, Authorization and Restriction of Chemicals (REACH) was first released. Under this Regulation, manufacturers are required to gather information on the properties of their chemical substances, which will allow their safe handling, and to register the information to European Chemicals Agency (ECHA). The aim is to improve the protection of human health and the environment through the better and earlier identification of the intrinsic properties of chemical substances.

### **About RoHS**

RoHS Directive (EU Directive 2002/95/EC ) was issued in 2002, restricted the use of the six chemicals lead, cadmium, mercury, and hexavalent chromium, as well as flame retardants polybrominated biphenyls (PBBs) and polybrominated diphenyl ethers (PBDEs). Under this directive, manufacturers are required to replace these chemicals in their products with less hazardous alternatives.

Then RoHS 2.0 (Directive 2011/65/EU) has replaced Directive 2002/95/EC since January 3, 2013. In 2015, EU commission publishes Directive (EU) 2015/863 to amend Annex II to EU RoHS 2 (Directive 2011/65/EU) to add 4 phthalates (DEHP, BBP, DBP and DIBP) onto the list of restricted substances from 22 July 2019.

### **REACH and RoHS Compliance**

Synology meets all requirements of the REACH Regulation and is compliant to all implemented RoHS type regulations worldwide. To the best of Synology's knowledge, all Synology products in production (including finished



products, spare parts, and packaging materials) are in compliance with the requirements of the Regulation and/or Directives. Synology continues to monitor, influence, and develop our processes to comply with any proposed changes to the Regulation and/or Directives.