



DW2650Z
DH2660Z
DH2661Z
DW2350Z-ST
DH2360Z-ST
DH2361Z-ST

User Manual

Notice

To ensure safe use of this product, please read the user manual for details before you operate your projector.

Risk Group 2

1. According to the classification of photobiological safety of light sources and light source systems, this product is Risk Group 2, IEC 62471-5:2015.
2. Possibly hazardous optical radiation emitted from this product.
3. Do not stare at operating light source. May be harmful to the eyes.
4. As with any bright source, do not stare into the direct beam.

Laser Caution

This product belongs to CLASS 1 consumer laser product and complies with IEC 60825-1:2014, EN 60825-1:2014/A11:2021 and EN 50689:2021.

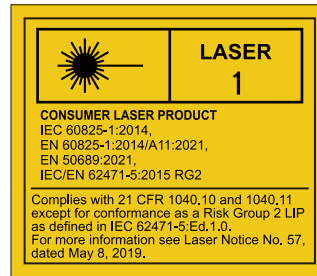

Above laser caution is located on the bottom of this apparatus.

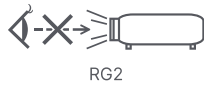

The projector's light source unit uses a laser.

Caution – Use of control or adjustments or performance of procedures other than those specified herein may result in hazardous radiation exposure.

- Notice is given to supervise children and to never allow them to stare into the projector beam at any distance from the projector.
- Notice is given to use caution when using the remote control for starting the projector while in front of the projection lens.
- Notice is given to the user to avoid the use of optional aids such as binoculars or telescopes inside the beam.

Warning Labels

Safety Hazard and Warning information Labels are placed at the following locations:

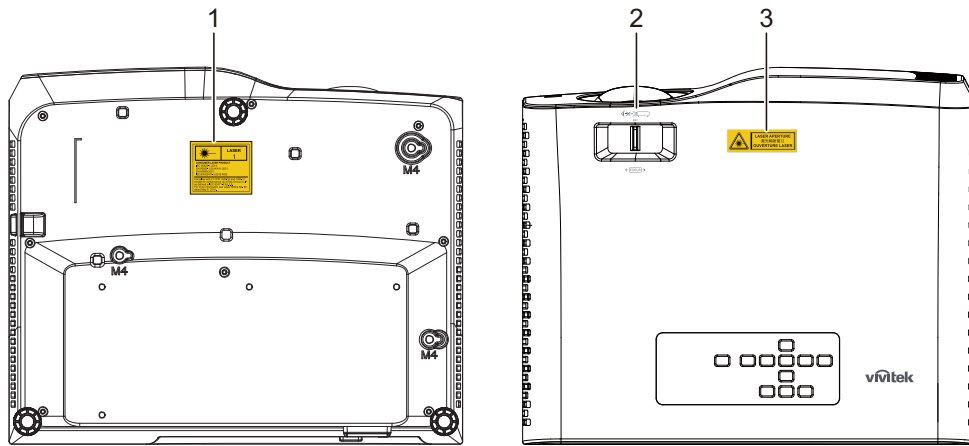

1. Laser Warning Label

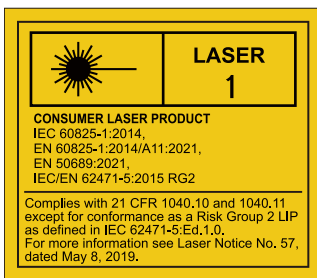

2. RG2 Logo

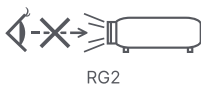

3. APERTURE Label



FCC notice

This equipment has been tested and found to comply with the limits for a Class B digital device, pursuant to part 15 of the FCC Rules. These limits are designed to provide reasonable protection against harmful interference in residential installation. This equipment generates, uses and can radiate radio frequency energy and if not installed and used in accordance with the instructions, may cause harmful interference to radio communications. However, there is no guarantee that interference will not occur in a particular installation. If this equipment does cause harmful interference to radio or television reception, detectable by turning the equipment in question off and on, the user is encouraged to try to correct the interference by one or more of the following measures:

- Reorient or relocate the receiving antenna
- Increase the distance between the equipment and the receiver
- Connect the equipment to an outlet on a different circuit than that which the receiver is connected to
- Or consult the dealer or an experienced radio/TV technician for help.

This device complies with Part 15 of the FCC Rules. Operation is subject to following two conditions:

1. This device may not cause harmful interference, and
2. This device must accept any interference that may cause undesired operation.

Safety instructions

Read all of these instructions before you operate your projector and save for future reference.

1. Read instructions
All the safety and operating instructions should be read before the appliance is operated.
2. Notes and warnings
All notes and warnings in the operating instructions should be adhered to.
3. Cleaning
Unplug the projector from the wall socket before cleaning. Use a damp cloth for cleaning the projector housing. Do not use liquid or aerosol cleaners.
4. Accessories
Do not place this product on an unstable cart, stand, or table. The product may fall, causing serious damage to the product.
Keep the plastic packing materials (from the projector, accessories and optional parts) out of the reach of children as these bags may result in death by suffocation. Be particularly careful around the small children.
5. Ventilation
The projector is equipped with ventilation holes (intake) and ventilation holes (exhaust).
Do not block or place anything near these slots, or internal heat build-up may occur, causing picture degradation or damage to the projector.
6. Power sources
Check that the operating voltage of your unit is identical with the voltage of your local power supply.
7. Servicing
Do not attempt to service this projector yourself. Refer all servicing to qualified service personnel.
8. Replacement parts
When replacement parts are required, be sure that the replacement parts are specified by the manufacture. Unauthorized substitutions may result in fire, electric shock or other hazards.
9. Moisture Condensation
Never operate this projector immediately after moving it from a cold location to a warm one. When the projector is exposed to such a change in temperature, moisture may condense on the lens and the crucial internal parts. To prevent the unit from possible damage, do not use the projector for at least 2 hours when there is an extreme or sudden change in temperature.

Notes on the AC power cord

AC Power Cord must meet the requirement of countries where you use this projector. Please confirm your AC plug type with the graphics below and ensure that the proper AC Power Cord is used. If the supplied AC Power Cord does not match your AC outlet, please contact your sales dealer. This projector is equipped with a grounding type AC line plug. Please ensure that your outlet fits the plug. Do not defeat the safety purpose of this grounding type plug. We highly recommend using a video source device also equipped with a grounding type AC line plug to prevent signal interference due to voltage fluctuations.

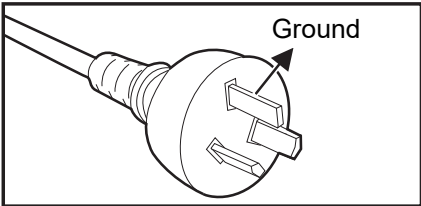

For Australia and Mainland China

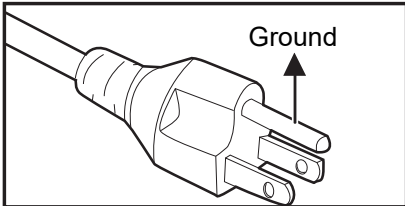

For the U.S.A. and Canada

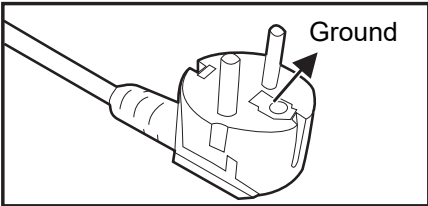

For Continental Europe

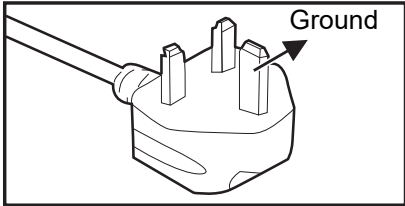

For the U.K.

Table of contents

- Introduction 7**
- Projector features 7
- Package contents 8
- Product overview 9
- Installation 12**
- Connecting to the projector 12
- Powering on/off the projector 14
- Adjusting the projector height 15
- Adjusting the projector focus 16
- Adjusting projection image size 17
- User Controls 20**
- Control panel & remote control 20
- Securing the projector 26
- Locking control keys 27
- Using the projector in standby mode 28
- Adjusting the sound 28
- On-screen display menus 29
- Menu tree 30
- Using network features (Only for DH2661Z and DH2361Z-ST) 42
- Maintenance 45**
- Cleaning the projector housing 45
- Specifications 46**
- Dimensions 48
- Ceiling mount installation 49
- Appendices 50**
- LED indicator messages 50
- Compatibility modes 51
- Troubleshooting 56
- RS-232 command and configuration 57
- Service information 64

Introduction

Projector features

The projector integrates high-performance optical engine projection and a user - friendly design to deliver high reliability and ease of use.

The projector offers the following features:

- Laser-phosphor light source free from replacement
- Short throw (ST) projection lens delivers large images from a short projection distance
- HDMI x 2 inputs
- 2D keystone for easy horizontal and vertical keystone correction
- Corner Adj. allows you to adjust four corners of the projected image
- Power saving function decreasing the power consumption of the light by up to 30% when no input signal can be detected for a set period of time.
- Presentation timer for better control of time during presentations
- Blu-Ray 3D function supported
- Selectable quick power off function
- Color Management allowing color adjustments to your liking
- Screen Color correction allowing projection on surfaces of several predefined colors
- Quick auto search speeding up the signal detecting process

Note

- *The information in this manual is subject to change without notices.*
- *The reproduction, transfer or copy of all or any part of this document is not permitted without express written consent.*

Package contents

When you unpack the projector, make sure you have all these components:

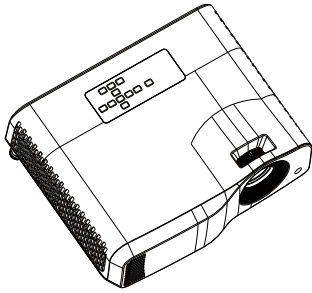

Projector

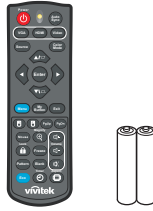

Remote control (IR) & batteries (AAA *2 PCS)

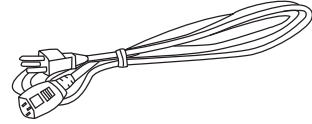

AC power cord

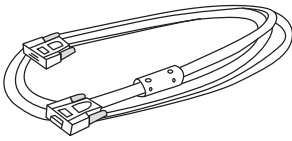

VGA cable (D-SUB to D-SUB)

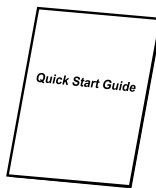

Quick start guide

Note

- **Contact your dealer immediately if any items are missing, appear damaged, or if the unit does not work.**
- **For maximum protection of the product, please save the original shipping carton and packing materials and repack your product as it was originally packed at the factory if you need to ship it.**

Product overview

Projector outlook

Front and top

Standard projector

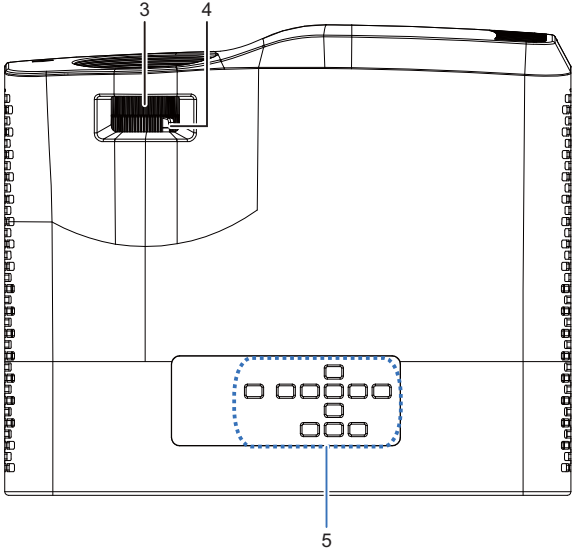
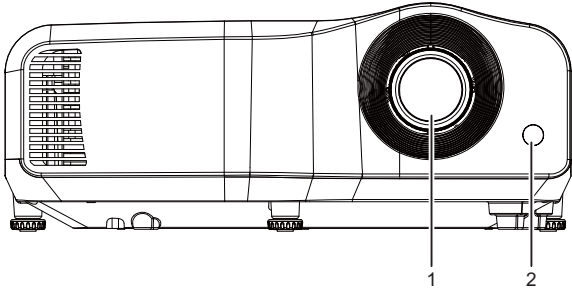

Short-Throw projector

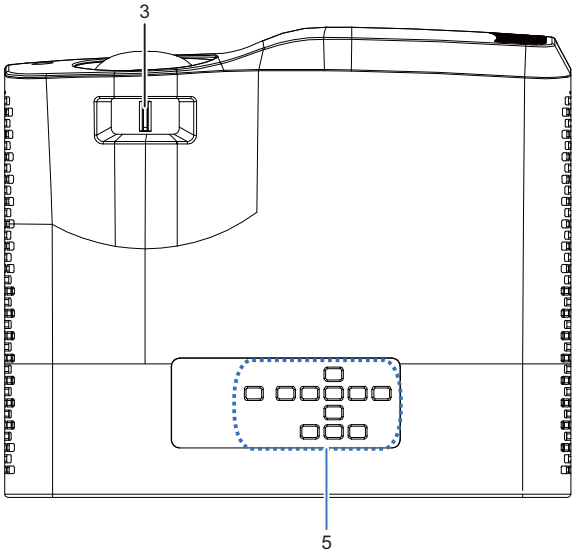
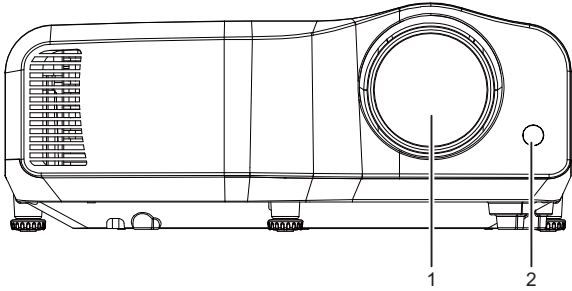

- 1. Lens
- 3. Focus switch
- 5. Control panel

- 2. IR remote control sensor
- 4. Zoom ring

Bottom and side

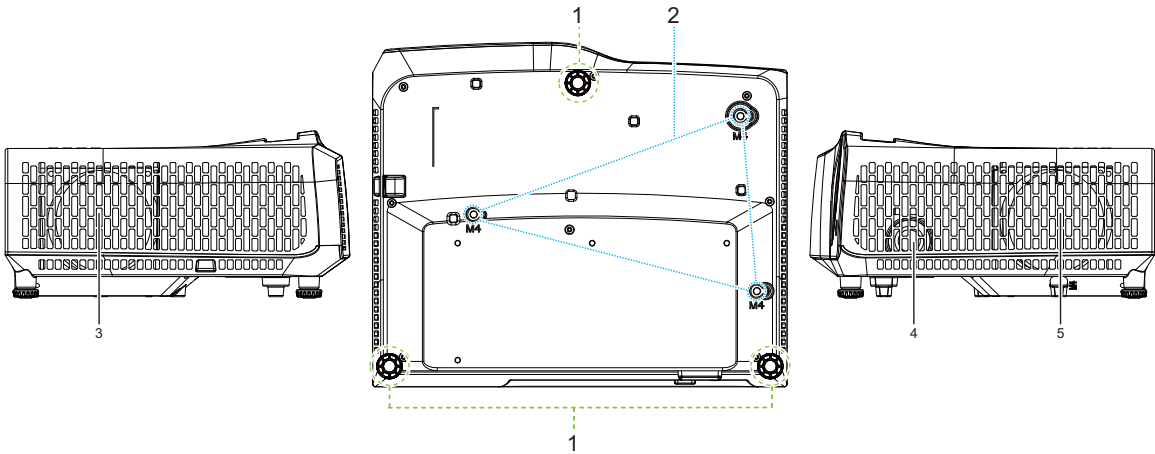

- 1. Adjustment feet
- 2. Ceiling mount holes
- 3. Ventilation holes (airflow out)
- 4. Speaker
- 5. Ventilation holes (airflow in)

Rear

DW2660Z/DW2350Z-ST/DH2660Z/DH2360Z-ST (w/o RJ45)

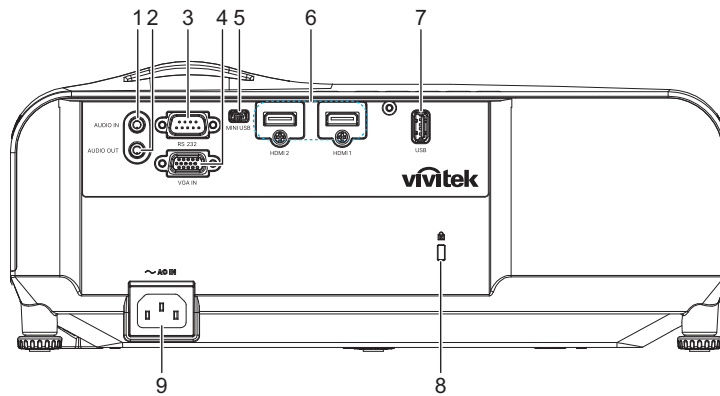

DH2661Z/DH2361Z-ST (with RJ45)

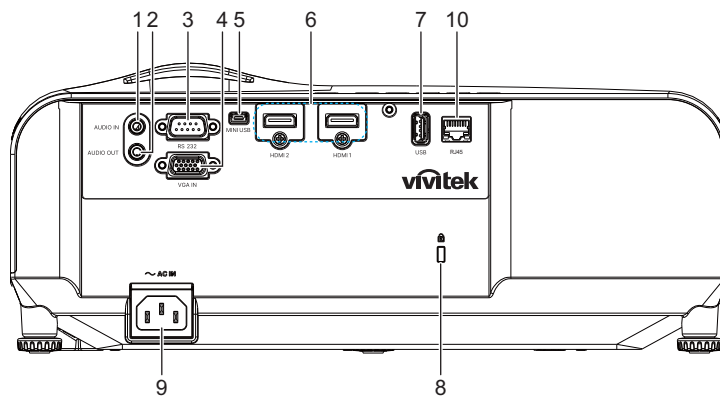

- | | |
|---------------------------------|---|
| 1. Audio input jack | 2. Audio output jack |
| 3. RS232 control port | 4. RGB (PC)/Component video (YPbPr) signal input jack |
| 5. Mini-USB jack for service | 6. HDMI 1/HDMI 2 input jack |
| 7. 5V output for power charging | 8. Kensington anti-theft lock slot |
| | 10. RJ45 LAN input jack (100Mbps) |

 AC power cord inlet

Note

- ***This projector can be used with a ceiling mount for support. The ceiling mount is not included in the package.***
- ***Contact your dealer for information to mount the projector on a ceiling.***

Installation

Connecting to the projector

Connecting a Computer/Notebook

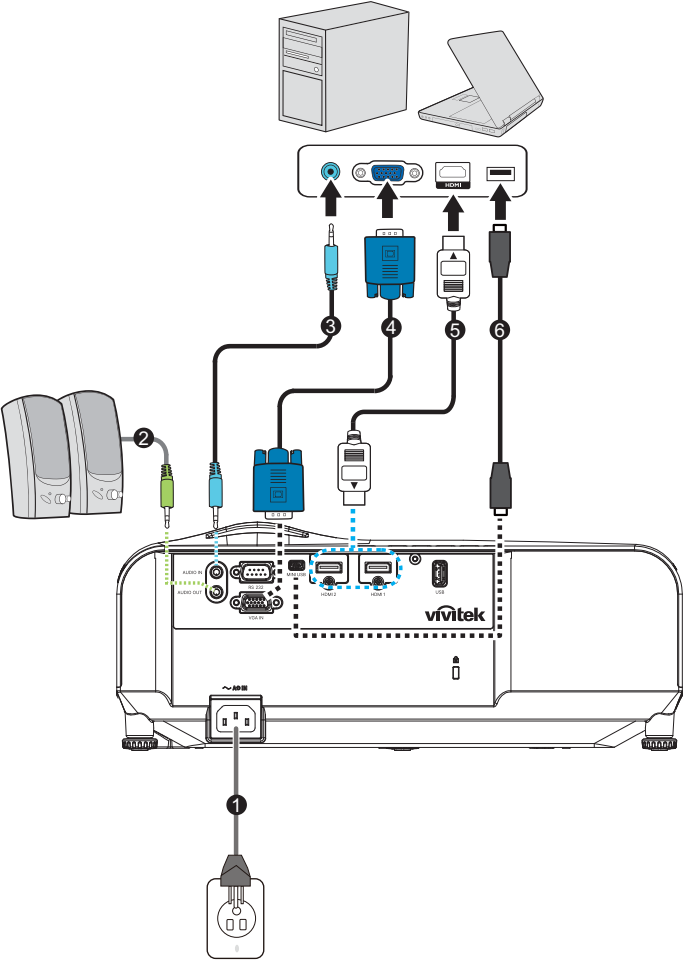

- 1. Power cord
- 2. Audio Out cable
- 3. Audio In cable
- 4. VGA cable (D-Sub to D-Sub)
- 5. HDMI cable
- 6. Mini-USB cable

Connecting a Video source

DVD player, Blu-ray player, Set-top box, HDTV receiver

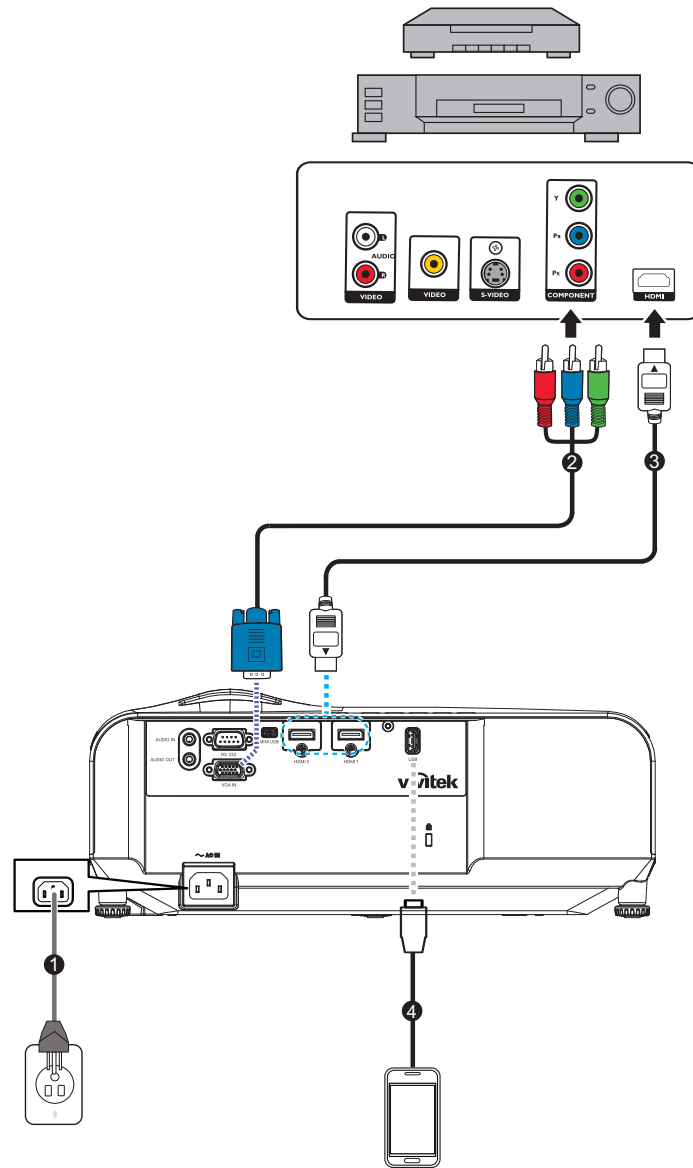

1. Power cord
3. HDMI cable

2. 3 RCA to mini D-sub 15 pin cable
4. USB cable for charging device

Powering on/off the projector

Powering on the projector:



1. Complete the AC power cord and peripheral signal cable(s) connections.
2. Press  to turn on the projector.
The projector takes a minute or so to warm up.
 - If the projector is still hot from previous activity, it will run the cooling fan for approximately 60 seconds before energizing the light.
3. Turn on your source (computer, notebook, DVD, etc.).
 - If you are connecting multiple sources to the projector simultaneously, press **Source** to select your desired signal or press your desired signal key on the remote control.
 - If the projector doesn't detect a valid signal, the message 'No Signal' will continue to be displayed.
 - Be sure the **Auto Source** function in the **Source** menu is **On** if you want the projector to automatically search for the signals.



Warning

- *Never look into the lens when the light is on. This can damage your eyes.*
- *This focal point concentrates high temperature. Do not place any object near it to avoid possible fire hazard.*

Powering off the projector:

1. Press  to turn off the projector light. You will see a message "Power off? Press Power again" appear on the screen.
2. Press  again to confirm.
 - The Power LED begins flashing and the projector will enter standby mode.
 - If you want to turn the projector back on, you must wait until the projector has completed the cooling cycle and has entered standby mode. Once in standby mode, simply press  to restart the projector.
3. Disconnect the AC power cord from the electrical outlet and the projector.
4. Do not turn on the projector right after power off.

Adjusting the projector height

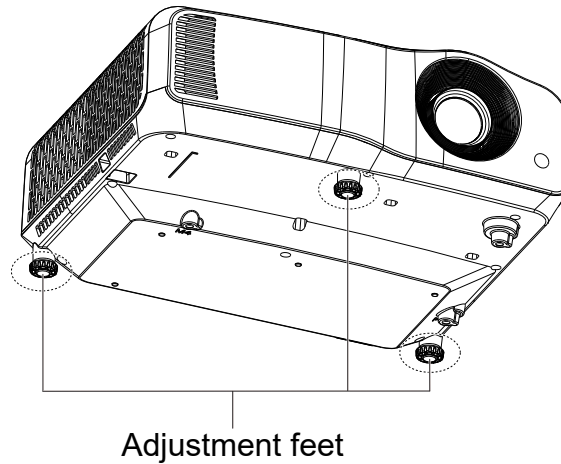

The projector is equipped with 3 adjustment feet to adjust the image height. To raise or lower the image, turn the adjustment feet to fine-tune the height.

 **Note**

- *To avoid damaging the projector, make sure that the adjustment feet are fully retracted before placing the projector in its carrying case.*

Adjusting the projector focus

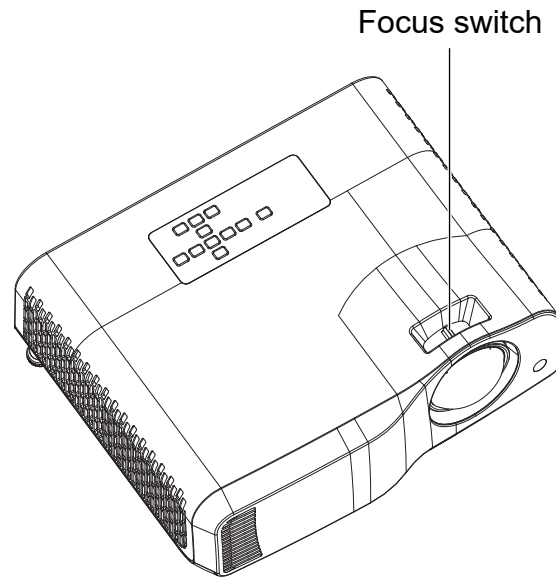

Short-Throw projector

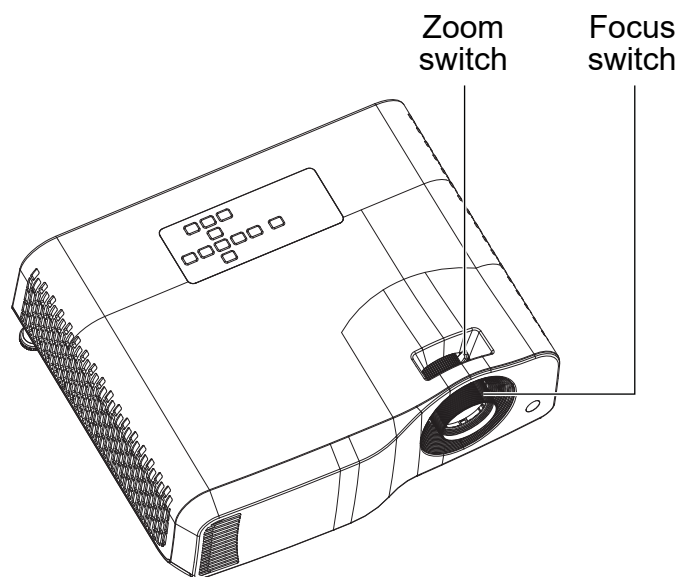

Standard projector

To focus the image, slide the focus switch until the image is clear.

- Standard throw series (WXGA): The projector will focus at distance from 1.31 to 10.21m (From a projecting surface to the rear of the unit).
- Short throw series (WXGA): The projector will focus at distance from 0.53 to 1.59m (From a projecting surface to the rear of the unit).
- Standard throw series (1080P): The projector will focus at distances from 1.28 to 10.1m (From a projecting surface to the rear of the unit).
- Short throw series (1080P): The projector will focus at distance from 0.52 to 1.61m (From a projecting surface to the rear of the unit).

Adjusting projection image size

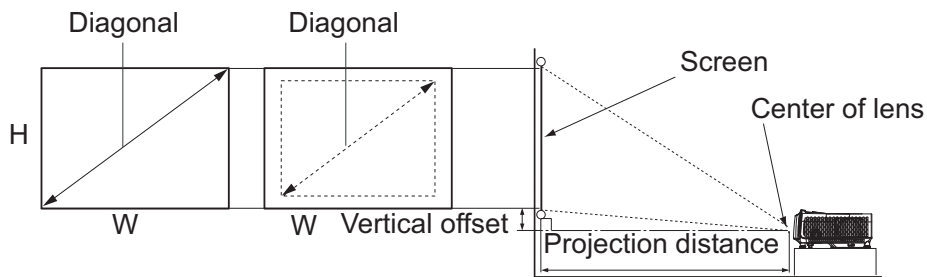

D: Projection image size

H: Distance from a floor to the bottom of a projection image

WXGA (Standard Throw)

Screen						Distance from the lens front to screen				Height Projected		Throw Ratio	
Diagonal Size		Width		Height		Shortest (Wide)		Longest (Tele)		Image (Hd)		In case the throw distance is measured from the lens front to screen	
inch	cm	inch	cm	inch	cm	inch	m	inch	m	inch	cm	Wide	Tele
40	102	34	86	21	54	52	1.3	62	1.6	0.8	2.0	1.520	1.837
50	127	42	108	26	67	65	1.7	78	2.0	1.0	2.5	1.534	1.851
60	152	51	129	32	81	79	2.0	95	2.4	1.2	3.0	1.544	1.860
70	178	59	151	37	94	92	2.3	111	2.8	1.4	3.6	1.550	1.867
80	203	68	172	42	108	106	2.7	127	3.2	1.6	4.1	1.555	1.872
90	229	76	194	48	121	119	3.0	143	3.6	1.8	4.6	1.559	1.875
100	254	85	215	53	135	132	3.4	159	4.0	2.0	5.1	1.562	1.878
120	305	102	258	64	162	159	4.0	192	4.9	2.4	6.1	1.567	1.883
150	381	127	323	79	202	200	5.1	240	6.1	3.0	7.6	1.571	1.888
200	508	170	431	106	269	267	6.8	321	8.2	4.0	10.2	1.576	1.892
250	635	212	538	132	337	335	8.5	402	10.2	5.0	12.7	1.579	1.895
300	762	254	646	159	404	402	10.2	483	12.3	6.0	15.2	1.581	1.897

WXGA (Short Throw)

Screen						Distance from screen		Wide Throw Ratio
Diagonal Size		Width		Height		Wide		
inch	cm	inch	cm	inch	cm	inch	m	
50	127	42.4	108	26.5	67	21	0.53	0.491
55	140	46.6	118	29.1	74	23	0.58	0.491
56	142	47.5	121	29.7	75	23	0.59	0.491
60	152	50.9	129	31.8	81	25	0.63	0.491
65	165	55.1	140	34.4	88	27	0.69	0.491
70	178	59.4	151	37.1	94	29	0.74	0.491
75	191	63.6	162	39.7	101	31	0.79	0.491
80	203	67.8	172	42.4	108	33	0.85	0.491
85	216	72.1	183	45.0	114	35	0.90	0.491
86	218	72.9	185	45.6	116	36	0.91	0.491
90	229	76.3	194	47.7	121	37	0.95	0.491
95	241	80.6	205	50.3	128	40	1.01	0.491
100	254	84.8	215	53.0	135	42	1.06	0.491
105	267	89.0	226	55.6	141	44	1.11	0.491
110	279	93.3	237	58.3	148	46	1.16	0.491
120	305	101.8	258	63.6	162	50	1.27	0.492
130	330	110.2	280	68.9	175	54	1.38	0.492
140	356	118.7	302	74.2	188	58	1.48	0.492
150	381	127.2	323	79.5	202	63	1.59	0.492

1080p (Standard Throw)

Screen						Distance from screen				Height Projected		Throw Ratio	
Diagonal Size		Width		Height		Wide		Tele		Image (Hd)			
inch	cm	inch	cm	inch	cm	inch	m	inch	m	inch	cm	Wide	Tele
40	102	34.9	89	19.6	50	50	1.28	60	1.53	1.4	3.5	1.447	1.731
60	152	52.3	133	29.4	75	77	1.96	92	2.33	2.1	5.2	1.475	1.753
80	203	69.7	177	39.2	100	104	2.64	123	3.12	2.7	7.0	1.489	1.764
100	254	87.2	221	49.0	125	131	3.32	154	3.92	3.4	8.7	1.498	1.771
120	305	104.6	266	58.8	149	157	3.99	186	4.72	4.1	10.5	1.504	1.775
150	381	130.7	332	73.5	187	197	5.01	233	5.91	5.1	13.1	1.509	1.780
200	508	174.3	443	98.1	249	264	6.71	311	7.90	6.9	17.4	1.515	1.784
220	559	191.7	487	107.9	274	291	7.39	342	8.70	7.6	19.2	1.516	1.785
250	635	217.9	553	122.6	311	331	8.40	389	9.89	8.6	21.8	1.518	1.787
300	762	261.5	664	147.1	374	398	10.10	468	11.88	10.3	26.2	1.521	1.789

1080p (Short Throw)

Screen						Distance from screen		Wide Throw Ratio
Diagonal Size		Width		Height		Wide		
inch	cm	inch	cm	inch	cm	inch	m	
50	127	43.6	111	24.5	62	20	0.52	0.468
55	140	47.9	122	27.0	68	23	0.57	0.471
56	142	48.8	124	27.5	70	23	0.58	0.471
60	152	52.3	133	29.4	75	25	0.63	0.472
65	165	56.7	144	31.9	81	27	0.68	0.474
70	178	61.0	155	34.3	87	29	0.74	0.475
75	191	65.4	166	36.8	93	31	0.79	0.477
80	203	69.7	177	39.2	100	33	0.85	0.478
85	216	74.1	188	41.7	106	35	0.90	0.479
86	218	75.0	190	42.2	107	36	0.91	0.479
90	229	78.4	199	44.1	112	38	0.96	0.480
95	241	82.8	210	46.6	118	40	1.01	0.480
100	254	87.2	221	49.0	125	42	1.06	0.481
105	267	91.5	232	51.5	131	44	1.12	0.482
110	279	95.9	244	53.9	137	46	1.17	0.482
120	305	104.6	266	58.8	149	51	1.28	0.483
130	330	113.3	288	63.7	162	55	1.39	0.484
140	356	122.0	310	68.6	174	59	1.50	0.485
150	381	130.7	332	73.5	187	63	1.61	0.485

- These tables are for user's reference only.

User Controls

Control panel & remote control

Control panel

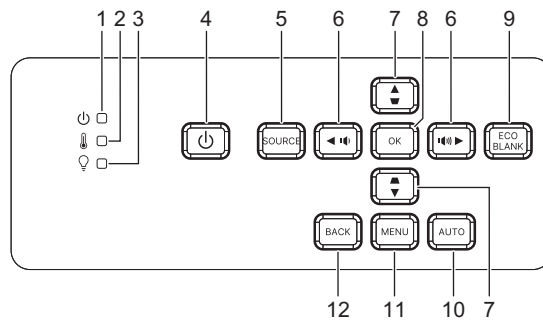

- 1. Power LED indicator**
Refer to “LED Indicator Messages”.
- 2. Temperature LED indicator**
Refer to “LED Indicator Messages”.
- 3. Light LED indicator**
Refer to “LED Indicator Messages”.
- 4. Power**
Turn the projector on or off.
- 5. Source**
Display the source selection bar.
- 6. Volume buttons**
Adjusts the volume level.
Directional select buttons
Selects the desired menu items and makes adjustments.
- 7. Keystone buttons**
Manually corrects distorted images resulting from an angled projection.
Directional select buttons
Selects the desired menu items and makes adjustments.
- 8. Enter**
Enacts the selected On-Screen Display (OSD) menu item.
- 9. Eco**
Switch the light mode between Normal and ECO.
Blank
Hide the screen picture.
- 10. Auto**
Automatically determines the best picture timings for the displayed image.

11. Menu

Display or exit the on-screen display menus.

12. Back

Goes back to previous OSD menu, exits and saves menu settings.

Remote control

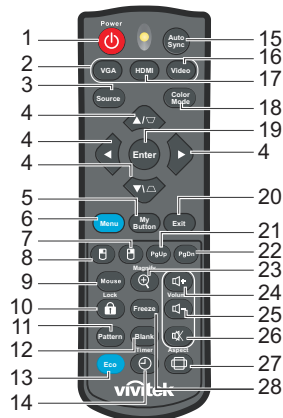

1. **Power**
Turn the projector on or off.
2. **VGA**
Display Computer signal.
3. **Source**
Display the source selection bar.
4. **△/▽** Keystone buttons
Manually corrects distorted images resulting from an angled projection.
▲/▼/◀/▶ Four directional select buttons
Selects the desired menu items and makes adjustments.
5. **My Button**
No function.
6. **Menu**
Display on-screen display menus.
7. **☞ (Right mouse)**
No function.
8. **☞ (Left mouse)**
No function.
9. **Mouse**
Switch between the normal and mouse modes.
10. **🔒 (Lock/ID Set)**
No function.
11. **Pattern**
Display embedded test pattern.
12. **Blank**
Hide the screen picture.
13. **Eco Mode**
Switch the light mode between Normal and ECO.

- 14. ⌚ (Timer)**
No function.
- 15. Auto Sync**
Automatically determines the best picture timings for the displayed image.
- 16. Video**
No function.
- 17. HDMI**
Switch HDMI signal between HDMI1 and HDMI2.
- 18. Color Mode**
Select the picture setup mode.
- 19. Enter**
Enacts the selected On-Screen Display (OSD) menu item.
- 20. Exit**
Goes back to previous OSD menu, exits and saves menu settings.
- 21. PgUp (Page Up)**
Perform page up function when mouse mode is activated.
- 22. PgDn (Page Down)**
Perform page down function when mouse mode is activated.
- 23. ⊕ (Magnify)**
Displays the zoom bar that magnifies or reduces the projected picture size.
- 24. 🔊+ (Volume Up)**
Increase the volume level.
- 25. 🔊- (Volume Down)**
Decrease the volume level.
- 26. 🔇 (Mute)**
Toggles the projector audio between on and off.
- 27. 📐 (Aspect)**
Select the display aspect ratio.
- 28. Freeze**
Freeze the projected image.

Installing the batteries

1. Open the battery cover in the direction shown.

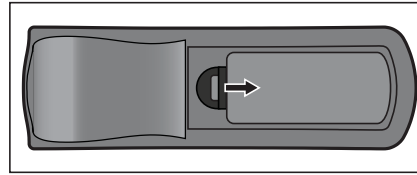

2. Install batteries as indicated by the diagram inside the compartment.

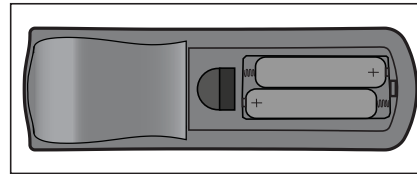

3. Close the battery cover into position.

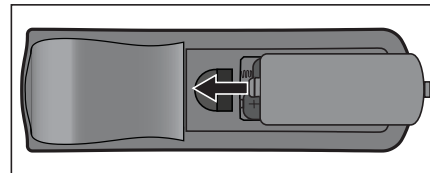

Caution

- *Risk of explosion if battery is replaced by an incorrect type.*
- *Dispose of used batteries according to the instructions.*
- *Make sure the plus and minus terminals are correctly aligned when loading a battery.*

Note

- *Keep the battery out of the reach of children.*
- *Remove batteries from remote control when not using for extended periods.*
- *Do not recharge the battery or expose the battery to fire or water.*
- *Do not dispose the used battery along with household waste. Dispose used batteries according to local regulations.*
- *Danger of explosion may happen if batteries are incorrectly replaced. Replace only with the same type recommended by the manufacturer.*
- *Battery should not be in or near to fire or water, keep batteries in a dark, cool and dry place.*
- *If suspect battery leakage, wipe out the leakage and then replace a new battery. If the leakage adheres to your body or clothes, rinse well with water immediately.*

Remote control operation

Point the remote control at the infrared remote sensor and press a button.

- Operating the projector from the front.

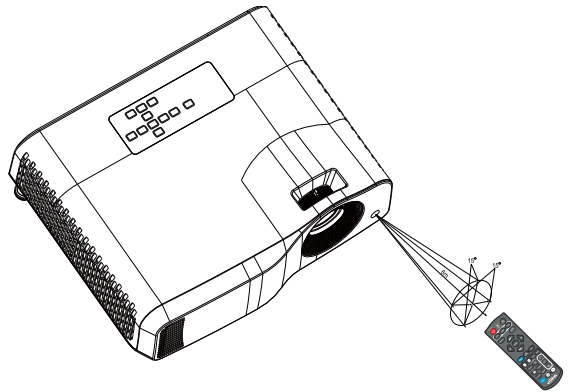

Note

- *The remote control may not operate when there is sunlight or other strong light such as a fluorescent light shining on the remote sensor.*
- *Operate the remote control from a position where the remote sensor is visible.*
- *Do not drop the remote control or jolt it.*
- *Keep the remote control out of locations with excessively high temperature or humidity.*
- *Do not get water on the remote control or place wet objects on it.*
- *Do not disassemble the remote control.*

Securing the projector

Setting a password

1. Open the OSD menu and go to the **Settings 2 > Advanced > Security Settings** menu. Press **Enter**. The **Security Settings** page displays.
2. Highlight **Change Password** and press **Enter**.
3. According to the password you desire to set, press the arrow keys to enter six digits for the password.
4. Confirm the new password by re-entering the new password.
5. Go back to **Settings 2 > Advanced > Security Settings > Power Lock** menu, and press **Enter**. You will be asked to input password. Once the password is set, the OSD menu returns to the **Power Lock**. Select **On** by pressing **◀/▶**.
6. To leave the OSD menu, press **Menu/Exit**.

Entering the password recall procedure

If the password function is activated, you will be asked to enter the six-digit password every time you turn on the projector.

1. If you enter an incorrect password 5 times in succession, the projector will display a coded number on the screen when you press the auto key 3~5 seconds.
2. Write down the number and turn off your projector.
3. Seek help from the local service center to decode the number. You may be required to provide proof of purchase documentation to verify that you are an authorized user of the projector.

Changing the password

1. Open the OSD menu and go to the **Settings 2 > Advanced > Security Settings > Change Password** menu and press **Enter**.
2. Enter the old password.
 - If the password is correct, another message **"INPUT NEW PASSWORD"** displays.
 - If the password is incorrect, the password error message displays, and the message **"INPUT CURRENT PASSWORD"** displays for your retry. You can press **Menu/Exit** to cancel the change or try another password.
3. Enter a new password.
4. Confirm the new password by re-entering the new password.
5. You have successfully assigned a new password to the projector. Remember to enter the new password next time the projector is started.
6. To leave the OSD menu, press **Menu/Exit**.

Disabling the password function

To disable password protection, go back to **Settings 2 > Advanced > Security Settings > Power Lock** menu, and press **Enter**. You will be asked to input password. Once the password is set, the OSD menu returns to the **Power Lock**. Select **Off** by pressing **◀/▶**. To leave the OSD menu, press **Menu/Exit**.

Locking control keys

With the control keys on the projector locked, you can prevent your projector settings from being changed accidentally (by children, for example). When the **Panel Key Lock** is **On**, no control keys on the projector will operate except **Power**.

1. Press  Lock on the remote control for 3 seconds. Press Lock on the remote control, a confirmation message "**Are you sure to lock panel keys?**" is displayed. Select **Yes** to confirm.



To release panel key lock:

1. Press  Lock on the remote control directly. **The Panel keys are unlock.**

Important

- **If you press  Power to turn off the projector without disabling panel key lock, the projector will still be in locked status the next time it is turned on.**
- **Keys on the remote control are still functional when panel key lock is enabled.**

Using the projector in standby mode

Some of the projector functions are available in standby mode (plugged in but not turned on). To use these functions, be sure you have turned on the corresponding menus under **Source > Standby Setting**, and the cable connections are correctly made. For the connection methods, see the "[Installation](#)" on page 12 chapter.

Active Audio out

Selecting **On** outputs an audio signal when the **AUDIO IN** socket is correctly connected to a proper device.

LAN Control

Selecting **On** allows the projector to provide the network function when it is in standby mode. See "[Using network features \(Only for DH2661Z and DH2361Z-ST\)](#)" on page 42 for details.



Adjusting the sound

The sound adjustments made as below will have an effect on the projector speaker. Be sure you have made a correct connection to the projector audio input/output jacks. See "[Installation](#)" on page 12 for more details.

Muting the sound

1. Open the OSD menu and go to the **Settings 2 > Audio Setting > Mute** menu.
 2. Press ◀ / ▶ to select **On**.
- *If available, you can press  on the remote control to toggle the projector audio between on and off.*

Adjusting the sound level

1. Open the OSD menu and go to the **Settings 2 > Audio Setting > Audio Volume** menu.
 2. Press ◀ / ▶ to select a desired sound level.
- *If available, you can press + or - on the remote control to adjust the projector's sound level.*

Turning off the Power On/Off Ring Tone

1. Open the OSD menu and go to the **Settings 2 > Audio Setting > Power On/Off Ring Tone** menu.
 2. Press ◀ / ▶ to select **Off**.
- *The only way to change Power On/Off Ring Tone is setting On or Off here. Setting the sound mute or changing the sound level will not affect the Power On/Off Ring Tone.*

On-screen display menus

The projector has multilingual on-screen display menus that allow you to make image adjustments and change a variety of settings.

How to operate

1. Press **Menu** to open the OSD menu.
2. When OSD is displayed, use ◀/▶ to select any feature in the main menu.
3. After selecting the desired main menu item, press ▼ to enter sub-menu for feature setting.
4. Use ▲/▼ to select the desired item and adjust the settings with ◀/▶.
5. Press **Menu**, the screen will return to the main menu or go back to the upper level of the menu.
6. Press **Menu** or **Exit** to leave and save the settings.

Menu tree

Main Menu	Sub Menu	Settings		
Display	Screen Color	Off / Blackboard / Greenboard / Whiteboard		
	Aspect Ratio	Auto / 4:3 / 16:9 / Panorama / Anamorphic / 2.35:1 / 16:10 / 16:6		
	Keystone	H: -30 - 30 V: -30 - 30		
	Corner Adj.	Top-Right / Top-Left / Bottom-Left / Bottom-Right		
	Auto Keystone	Off/On		
	Position	X: -5 - 5 Y: -5 - 5		
	Phase	0 - 31		
	H.Size	-15 - 15		
	Digital Zoom			
Image	Color Mode	Bright / Presentation / Movie / 3D / HDR 10		
	Brightness	0 - 100		
	Contrast	-50 - 50		
	Color Temperature		Warm / Normal / Cold	
			R Gain	
			G Gain	
			B Gain	
			R Offset	
			G Offset	
	HDMI Setting	Format	Auto / RGB / YUV	
		HDR	Auto / Off / HDR 10	
		HDMI Range	Auto / Enhanced / Normal	
	Advanced	Sharpness	0 - 31	
		Gamma	1 / 2 / 3 / 4 / 5	
		Brilliant Color	Off / 1 / 2 / 3 / 4 / 5 / 6 / 7 / 8 / 9 / 10	
		Noise Reduction	0 - 31	
		Color Manager	Primary color	R / G / B / C / M / Y / W
			Hue	-99 - 99
			Saturation	0 - 199
	Gain		5 - 195	
Reset Color Settings	Reset / Cancel			

Source	Auto Source		Off / On	
	3D Settings	3D Format	Auto	
			Off	
			Top-Bottom	
			Frame Sequential	
			Frame Packing	
			Side By Side	
		3D Sync Invert	Off / On	
	Standby Setting	Active Audio out	Off / On	
		LAN Control	Off / On	
	Auto Power On	Computer	Off / On	
		Direct Power On	Off / On	
	Power Saving	Auto Power Off	Disable / 10 / 20 / 30 min	
		Sleep Timer	Disable / 30 Min / 1 hr / 2 hr / 3 hr / 4 hr / 8 hr / 12 hr	
		Energy Saving	Off / On	
	Network	DHCP	Off / On	
		IP Address	0.0.0.0	
		Subnet Mask	0.0.0.0	
		Default Gateway	0.0.0.0	
		DNS Server	0.0.0.0	
Apply		Enter		
Settings 1	Language	English / Deutsch / Français / Español / Italiano / Русский / 한국어 / ไทย / Português / 简体中文 / 繁體中文 / 日本語 / Nederlands / Svenska / Türkçe / Čeština / Suomi / Polski / Indonesia / العربية / हिन्दी		
	Projection		Front Table / Rear Table / Rear Ceiling / Front Ceiling	
	Menu Settings	Menu Display Time	5 sec / 10 sec / 15 sec / 20 sec / 25 sec / 30 sec	
		Menu Position	Center / Top-Left / Top-Right / Bottom-Left / Bottom-Right	
	Blank Timer		Disable / 5 Min / 10 Min / 15 Min / 20 Min / 25 Min / 30 Min	
	Splash Screen		Standard / Black / Blue / Green	
	Advanced	Pattern	Off / On	
		Message	On / Off	

Settings 2	High Altitude Mode		Off / On
	Audio Setting	Mute	Off / On
		Audio Volume	0 - 20
		Power On/Off Ring Tone	On / Off
	Light Setting	Light Mode	Normal / ECO
		Reset Light Hours	Reset / Cancel
	Advanced	Security Settings	Change Password
			Power Lock
		Panel Key Lock	Off / On
	Reset Setting		Reset / Cancel
Information	Current System Status		Source
			Color Mode
			Resolution
			Color System
			Light Hours
			IP Address
			MAC Address
			Serial Number
			Firmware Version

Display

Screen Color

The Screen Color feature can help correct the projected picture's colors to prevent possible color difference between the source and projected pictures.

There are several precalibrated colors to choose from: Whiteboard, Greenboard, and Blackboard.

Aspect Ratio

Select how the picture fits on the screen:

- Auto:
Scales an image proportionally to fit the projector's native resolution in its horizontal or vertical width. You want to make most use of the screen without altering the source image's aspect ratio.
- 4:3:
Scales an image so that it is displayed in the center of the screen with a 4:3 aspect ratio, as it displays them without aspect alteration.
- 16:9:
Scales an image so that it is displayed in the center of the screen with a 16:9 aspect ratio, as it displays them without aspect alteration.
- Panorama
Scales a 4:3 image vertically and horizontally in a non-linear manner so that it fills the screen.
- Anamorphic:
Scales a 2.35:1 aspect image so that it fills the screen.
- 2.35: 1
Scales an image so that it is displayed in the center of the screen with a 2.35:1 aspect ratio without aspect alteration.
- 16:10:
Scales an image so that it is displayed in the center of the screen with a 16:10 aspect ratio, as it displays them without aspect alteration.
- 16:6:
Scales an image so that it is displayed in the center of the screen with a 16:6 aspect ratio, as it displays them without aspect alteration.

Keystone

Manually correct distorted images resulting from an angled projection.

Press **Keystone** \triangle/∇ on the projector or remote control to display the Keystone correction page.

Press \triangle to correct keystone at the top of the image.

Press ∇ to correct keystone at the bottom of the image.

Corner Adj.

Manually adjust four corners of the image by setting the horizontal and vertical values.

1. Press ▲/▼/◀/▶ to select one of the four corners and press **Enter**.
2. Press ▲/▼ to adjust vertical values.
3. Press ◀/▶ to adjust horizontal values.

Auto Keystone

Automatically corrects distorted images resulting from an angled projection.

Position

Displays the position adjustment page. This function is only available when a PC type input signal is selected.

Phase

Adjusts the clock phase to reduce image distortion. This function is only available when a PC type input signal is selected.

H.Size

Adjusts the horizontal width of the image. This function is only available when a PC type input signal is selected.

Digital Zoom

Using the remote control

1. Press ⊕ on the remote control to display the Zoom bar.
2. Press ▲/▶ to magnify the picture to a desired size.
3. Press ▲ repeatedly to magnify the picture to a desired size.
4. To navigate the picture, press **Enter** to switch to the panning mode and press the directional arrows (▲, ▼, ◀, ▶) to navigate the picture.
5. To reduce size of the picture, press **Enter** to switch back to the zoom in/out functionality, and press **Auto Sync** to restore the picture to its original size. You can also press ▼ repeatedly until it is restored to the original size.

Using the OSD menu

1. Press **Menu** and then select **Display** menu.
2. Press ▼ to select **Digital Zoom** and press **Enter**. The Zoom bar displays.
3. Repeat steps 3-5 in the section of Using the remote control above.

Image

Color Mode

There are many factory presets optimized for various types of images.

- Bright: Maximizes the brightness of the projected image. This mode is suitable for environments where extra-high brightness is required.
- Presentation: Is designed for presentations under daylight environment to match PC and notebook coloring.
- Movie: Switches between high brightness performance and accurate color performance.
- 3D: Optimized settings for watching three-dimensional/steroscopic image.
- HDR 10: Optimized settings for watching HDR (High Dynamic Range) image.

Brightness

Brighten or darken the image.

Contrast

Sets the difference between light and dark areas.

Color Temperature

Sets a color temperature from Warm, Normal, and Cool.

- Warm: Makes images appear reddish white.
- Normal: Maintains normal colorings for white.
- Cold: With the highest color temperature, Cool makes the image appear the most bluish white than other settings.
- R Gain/G Gain/B Gain: Adjusts the contrast levels of Red, Green, and Blue.
- R Offset/G Offset/B Offset: Adjusts the brightness levels of Red, Green, and Blue.

HDMI Setting

Format

Selects appropriate HDMI timing.

Note

- *This function is only available when the HDMI-input port is in use.*

HDR

- Auto: Automatically activates the HDR function.
- Off: Disables the HDR function.
- On: Enables the HDR function.

HDMI Range

- Auto: Automatically selects the range for HDMI output signal.
- Enhanced : The range for HDMI output signal is from 0 - 255.
- Normal: The range for HDMI output signal is from 16 - 235.

Advanced

Sharpness

Adjusts the image to make it look sharper or softer.

Gamma

Effect the represent of dark scenery. With greater gamma value, dark scenery will look brighter.

Brilliant Color

This adjustable item utilizes a new color-processing algorithm and system level enhancements to enable higher brightness while providing true, more vibrant colors in picture. The range is from “1” to “10”. If you prefer a stronger enhanced image, adjust toward the maximum setting. For a smoother, more natural image, adjust toward the minimum setting.

Noise Reduction

This function reduces electrical image noise caused by different media players. The higher the setting, the less the noise.

Color Manager

The Color Manager provides seven sets (R/G/B/C/M/Y/W) of colors to be adjusted. When you select each color, you can independently adjust its hue, saturation and gain according to your preference.

Reset Color Settings

Reset the Color Mode settings of the current input source to default values.

Source

Auto Source

Automatically scan through all the input source if the function in the OSD menu is On. The function will stop the signal auto scan process and fix the signal source you preferred if you turn Off the Auto Source.

3D Settings

This projector features a 3D function which enables you to enjoy the 3D movies, videos, and sporting events in a more realistic way by presenting the depth of the images. You need to wear a pair of 3D glasses to view the 3D images.

3D Format

If the projector cannot recognize the 3D format, press ▲/▼ to choose a 3D Format.

3D Sync Invert

When you discover the inversion of the image depth, enable this function to correct the problem.

Standby Setting

Active Audio out

Set whether the audio out function works when the projector is in standby (powered off but connected to AC power). When selecting **On**, **AUDIO IN** will be output. **AUDIO OUT** port is also active (Only support audio of signal before shutdown). When selecting **Off**, power consumption is under 0.5W. When selecting **Off**, both **AUDIO IN** and **AUDIO OUT** are **Off**.

LAN Control

Set whether the network function works when the projector is in standby (powered off but connected to AC power).

Note

- *Less than 0.5W power consumption when LAN Control is turned Off.*

Auto Power On

Computer

Selecting **On** the projector will turn on automatically when Computer signal is detected.

Direct Power On

Selecting **On** the projector will turn on automatically after the power cord has been connected and power has been applied.

Power Saving

Auto Power Off

The projector lowers the projector power if no input source is detected after 5 minutes to prevent unnecessary waste of light life. You can further decide if you would like the projector to turn off automatically after a set period of time.

When **Disable** is selected, the projector power will be reduced to 30% after no signal is detected for 5 minutes.

If you select **10 Min**, **20 Min** or **30 Min**, the projector power will be reduced to 30% after no signal is detected for 5 minutes. And when **10 Min**, **20 Min** or **30 Min** is up, the projector will turn off automatically.

Sleep Timer

This function allows the projector to turn off automatically after a set period of time to prevent unnecessary waste of light life.

Energy Saving

Selecting **On** activates this function.

Network

Allow you to configure the wired LAN settings. Refer to page [42](#).

- DHCP:
 - When selecting “DHCP on”, “IP Address”, “Subnet Mask”, “Default Gateway” and “DNS Server” will be gray out.
 - When selecting “Static IP”, “IP Address”, “Subnet Mask”, “Default Gateway” and “DNS Server” will be available.
- IP Address: Numerical address to identify networked computers.
 - The IP Address is the number that identifies this projector on the network. You cannot have two devices with the same IP Address on the same network.
 - The IP Address “0.0.0.0” is prohibited.
- Subnet Mask: A numeric value to define the number of bits used for a network address of a divided network (or subnet) in an IP Address.
 - The Subnet Mask “0.0.0.0” is prohibited.
- Default Gateway: A server (or router) to communicate across networks (subnets) that are divided by Subnet Mask.
- DNS Server: Setup DNS server address when DHCP is disable.
- Apply: Save and execute the wired LAN settings.

Settings 1

Language

Select the language used by the on-screen menu.

Projection

Adjust the picture to match the orientation of the projector: upright or upside-down, in front of or behind the screen. Invert or reverse the image accordingly.

Menu Settings

Menu Display Time

Duration of OSD menu display countly starts (at idle state by second).

Menu Position

Choose the menu location on the display screen.

Blank Timer

Sets the image blank time when the Blank Timer feature is activated, once elapsed the image will return to the screen.

Splash Screen

Allows you to select which logo screen will display during projector start-up.

Advanced

Pattern

Display embedded test pattern.

Message

Enable or disable the message box at the right bottom of the screen.

Settings 2

High Altitude Mode

Use this function to allow the fans operate at full speed continuously to achieve proper high altitude cooling of the projector. If the projector is installed a filter cover, make sure that High Altitude Mode is set to On.

Audio Setting

See ["Adjusting the sound" on page 28](#) for details.

Mute

Cuts off the sound temporarily.

Audio Volume

Adjusts the projector's volume level.

Power On/Off Ring Tone

Setting the sound mute or changing the sound level will not affect the Power On/Off Ring Tone. The only way to change Power On/Off Ring Tone is setting On or Off here.

Light Setting

Light Mode

Sets the Light Mode.

- Normal: 100% light power
- ECO: 80% light power

Reset Light Hours

Reset the Light Hour to 0 hours.

Advanced

Security Settings

- Change Password: Allows you to set or change the password.
- Power Lock: If you enable this function, you will have to enter the password next time you turn on the projector.

See ["Securing the projector" on page 26](#) for details.

Panel Key Lock

Disables or enables all panel key functions except Power on the projector. See ["Locking control keys" on page 27](#) for details.

Reset Setting

Restore settings to factory default. The following settings will still remain: Keystone, Language, Projection, High Altitude Mode, Security Settings.

Information

Source

Shows the current signal source.

Color Mode

Shows the selected mode in the Color Mode menu.

Resolution

Shows the native resolution of the input signal.

Color System

Shows input system format: RGB or YUV.

Light Hours

Displays the number of hours the light has been used.

IP Address

Display the IP address.

MAC Address

Display the MAC address.

Serial Number

Display the device serial number.

Firmware Version

Shows firmware version.

Using network features (Only for DH2661Z and DH2361Z-ST)

You can manage and control the projector from one or more remote computers when they are properly connected to the same local area network.

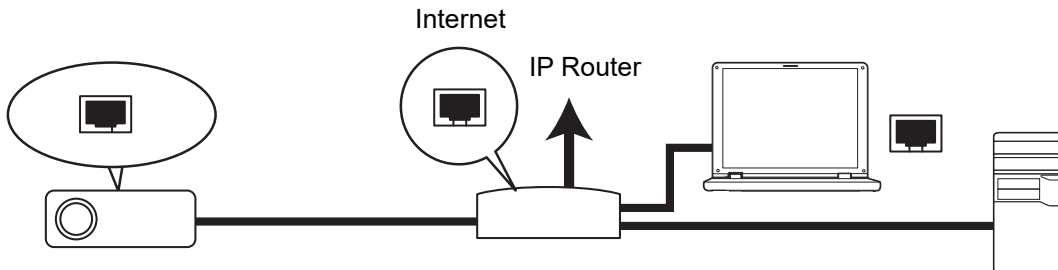

If you are in a DHCP on environment:

1. Take a RJ45 cable and connect one end to the RJ45 LAN input jack of the projector and the other end to the RJ45 port on your Ethernet or router. (100Mbps)
2. Press **Menu** and then go to **Source > Network** menu.
3. Make sure the **DHCP** is **DHCP on**.
4. Press **▼** to highlight **Apply** and press **Enter**.
5. Please wait for around 15 - 20 seconds, and then re-enter the Wired LAN page. The **IP Address**, **Subnet Mask**, **Default Gateway** and **DNS Server** settings will be displayed. Note down the IP address displayed in the **IP Address** row.

Important

- *If the IP Address still does not appear, contact your network administrator.*
- *If the RJ45 cables are not properly connected, the IP Address, Subnet Mask, Default Gateway and DNS Server settings will display 0.0.0.0. Make sure the cables are properly connected and perform the procedures above again.*
- *If you wish to connect to the projector in its standby mode, be sure you have selected RJ45 and obtained the IP Address, Subnet Mask, Default Gateway and DNS Server information when the projector is on.*

If you are in a Static IP environment:

1. Repeat steps 1-2 above.
2. Make sure the **DHCP** is **Static IP**.
3. Contact your ITS administrator for information on the **IP Address**, **Subnet Mask**, **Default Gateway**, and **DNS Server** settings.
4. Press **▼** to select the item you want to modify and press **Enter**.
5. Press **◀/▶** to move the cursor and then enter the value.
6. To save the settings, press **Enter**. If you do not want to save the settings, press **Exit**.
7. Press **▼** to highlight **Apply** and press **Enter**.

Important

- **If the RJ45 cables are not properly connected, the IP Address, Subnet Mask, Default Gateway and DNS Server settings will display 0.0.0.0. Make sure the cables are properly connected and perform the procedures above again.**
- **If you wish to connect to the projector in its standby mode, be sure you have selected RJ45 and obtained the IP Address, Subnet Mask, Default Gateway and DNS Server information when the projector is on.**

Using network control (Only for DH2661Z and DH2361Z-ST)

Once you have the correct IP address for the projector and the projector is on or in standby mode, you can use any computer that is on the same local area network to control the projector.

- **If you are using Microsoft Internet Explorer, make sure it is version 7.0 or higher.**
- **The screen shots in this manual are for reference only, and may differ from the actual design.**

Enter the address of the projector in the address bar of your browser and press **Enter**.

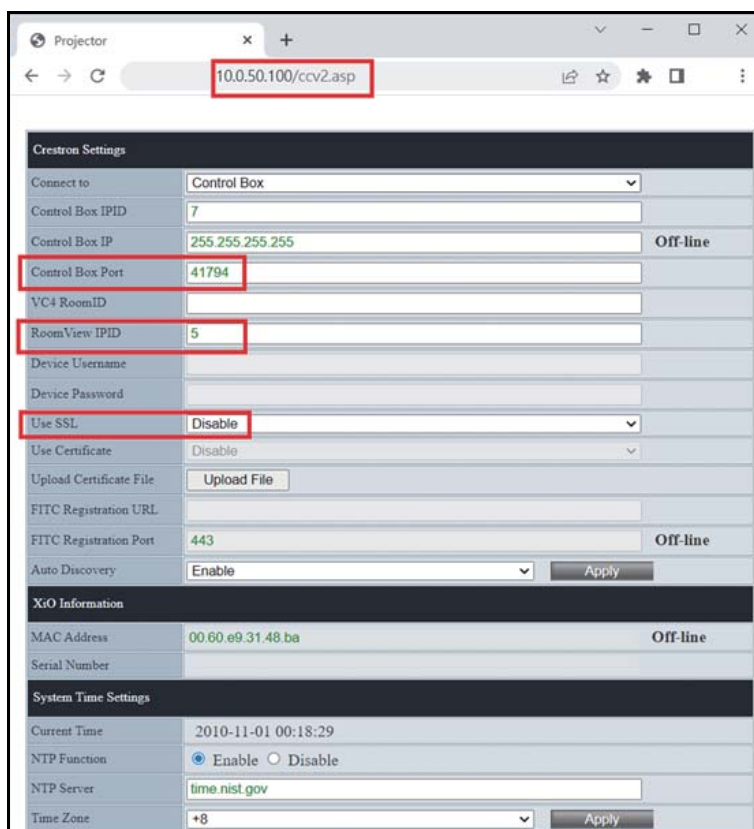

Crestron Settings	
Connect to	Control Box
Control Box IPID	7
Control Box IP	255.255.255.255 Off-line
Control Box Port	41794
VC4 RoomID	
RoomView IPID	5
Device Username	
Device Password	
Use SSL	Disable
Use Certificate	Disable
Upload Certificate File	Upload File
FITC Registration URL	
FITC Registration Port	443 Off-line
Auto Discovery	Enable Apply
XiO Information	
MAC Address	00.60.e9.31.48.ba Off-line
Serial Number	
System Time Settings	
Current Time	2010-11-01 00:18:29
NTP Function	<input checked="" type="radio"/> Enable <input type="radio"/> Disable
NTP Server	time.nist.gov
Time Zone	+8 Apply

For more information, visit <http://www.crestron.com> & www.crestron.com/getroomview.

Crestron RoomView

On the “Edit Room” page, enter the IP Address (or hostname) as shown on the projector’s on-screen display (OSD) menu, and “02” for IPID, “41794” for the reserved Crestron control port.

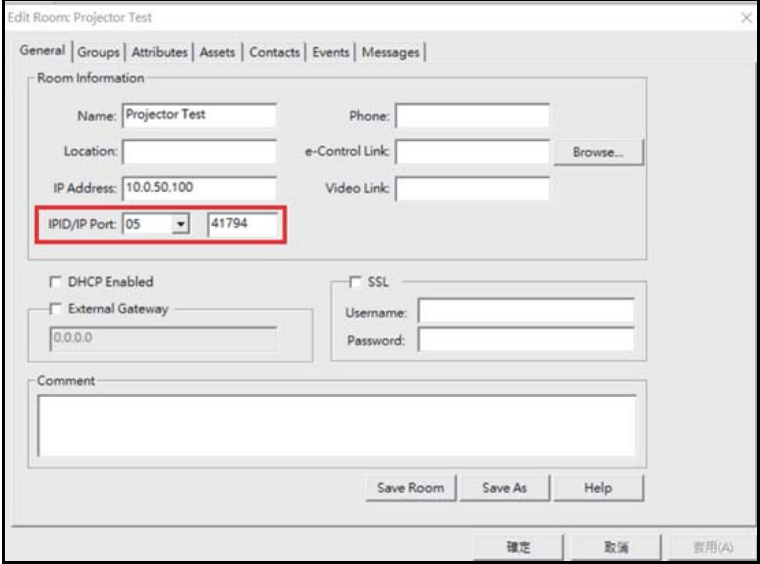

Maintenance

The projector needs proper maintenance. You should keep the lens clean as dust, dirt or spots will project on the screen and diminish image quality. If any other parts need replacing, contact your dealer or qualified service personnel. When cleaning any part of the projector, always switch off and unplug the projector first.



Warning

- ***Never open any of the covers on the projector. Dangerous electrical voltages inside the projector can cause severe injury. Do not attempt to service this product yourself. Refer all servicing to qualified service personnel.***

Cleaning the projector housing

Gently wipe with a soft cloth. If dirt and stains are not easily removed, use a soft cloth dampened with water, or water and neutral detergent, and wipe dry with a soft, dry cloth.



Note

- ***Turn off the projector and remove the AC power cord from the power outlet before beginning maintenance work.***
- ***Make sure the lens is cool before cleaning.***
- ***Do not use detergents or chemicals other than those noted above. Do not use benzene or thinners.***
- ***Do not use chemical sprays.***
- ***Use a soft cloth or lens paper only.***

Specifications

Model name	DW2650Z	DW2650Z-ST	DH2660Z	DH2660Z-ST	DH2661Z	DH2361Z-ST
Native resolution	0.65" WXGA, 1280x800(S450)		0.65" 1080p, 1920x1080(S600)			
Aspect ratio	Native 16:10		Native 16:9			
Throw ratio	1.544 - 1.860	0.492	1.475 - 1.753	0.48	1.475 - 1.753	0.48
Zoom ratio	1.2X	Fix	1.2X	Fix	1.2X	Fix
Light source	Laser Phosphor Display					
Keystone adjustment	1D, Vertical ±30 degrees	2D, Vertical ±30 degrees Horizontal ±30 degrees				
Auto Keystone	Yes (Vertical)					
4 Corners correction	No	Yes				
Projection offset	104%±5%		107%±5%			
Resolution support	VGA (640x480) to WUXGA (1920x1200)	VGA(640x480) to UHD(3840x2160)				
HDTV compatibility	480i, 480p, 576i, 567p, 720p, 1080i, 1080p					
Horizontal frequency	15 - 102 KHz					
Vertical frequency	23 - 120 KHz					
Focus range (image size)	Mechanical: 40"(1.31m) ~ 300"(10.21m) Optical: 40"(1.31m) ~ 300"(10.21m)	Mechanical: 50"(0.53m) ~ 150"(1.59m) Optical: 70"(0.74m) ~ 100"(1.0m)	Mechanical: 40"(1.28m) ~ 300"(10.10m) Optical: 50"(1.62m) ~ 200"(6.71m)	Mechanical: 50"(0.52m) ~ 150"(1.61m) Optical: 70"(0.74m) ~ 100"(1.06m)	Mechanical: 40"(1.28m) ~ 300"(10.10m) Optical: 50"(1.62m) ~ 200"(6.71m)	Mechanical: 50"(0.52m) ~ 150"(1.61m) Optical: 70"(0.74m) ~ 100"(1.06m)
Computer in (D-sub 15pin)	x1					
HDMI (1.4)	x2	N/A				
HDMI (2.0)	N/A	x2				
LAN (RJ45)	No				Yes	
RS232 (DB-9pin)	x1					
USB (Type A)	External x1, USB 2.0 (5V/1.5A)					
USB (Type Mini B)	x1 (for FW upgrade)					
Audio in (mini jack)	x1					
Audio out (mini jack)	x1					
Speaker	10W x1					
IR receiver	x1 Front					
Dimension (W x H x D)	353 x 290 x 144 mm					
Weight	4.8kg					
Normal power	220W (max.)					
Power supply	AC 100 to 240 V, 50/60 Hz					

Standby power consumption	< 0.5W
Operating temperature	0 - 40°C
Note: Design and Specifications are subject to change without prior notice.	

Dimensions

Standard projector: 354.3 mm (W) x 294.49 mm (D) x 142.99 mm (H)

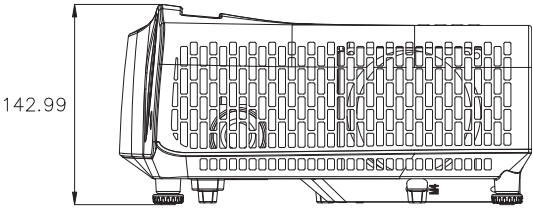
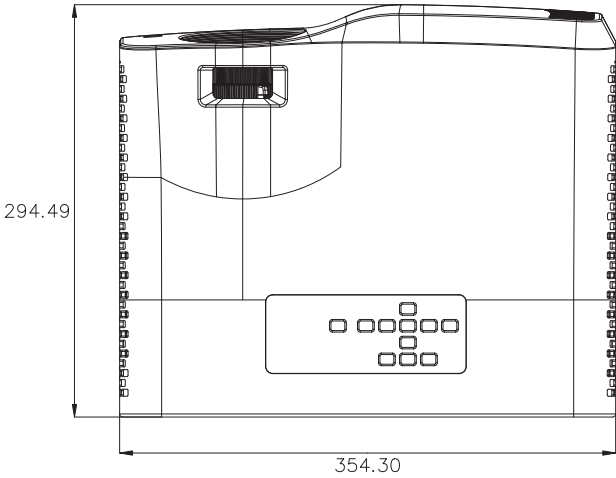

Short-Throw projector: 354.3 mm (W) x 294.49 mm (D) x 142.99 mm (H)

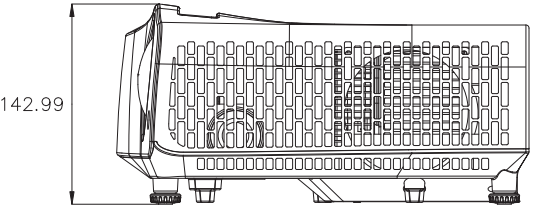
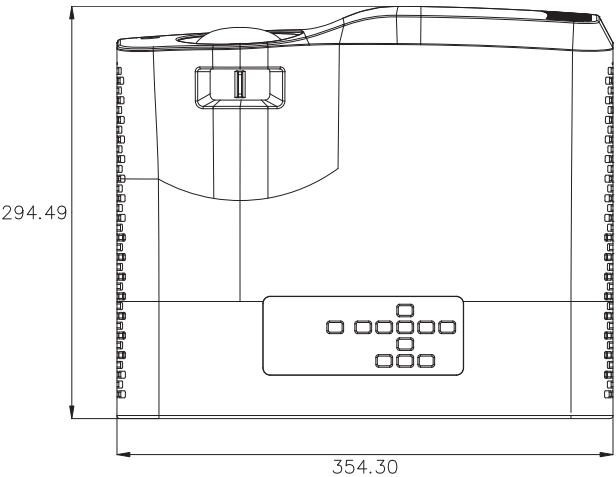

Ceiling mount installation

Standard projector

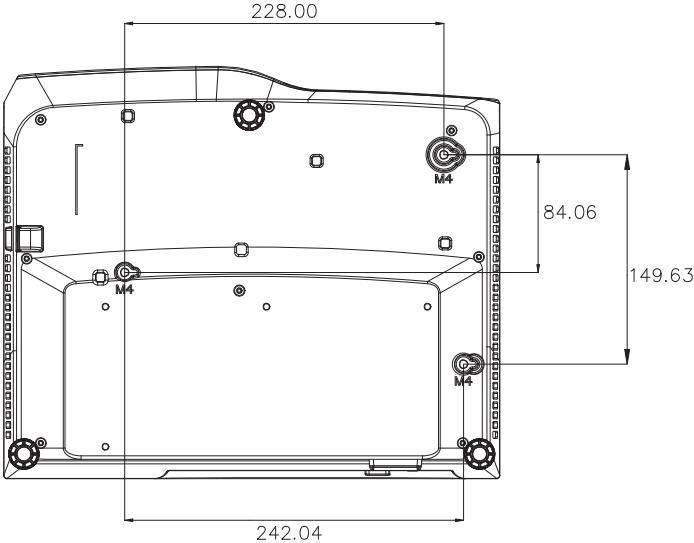

Ceiling mount screws: 3 PCS
Screws specs: $\Phi=4\text{mm}$ L=10mm

Short-Throw projector

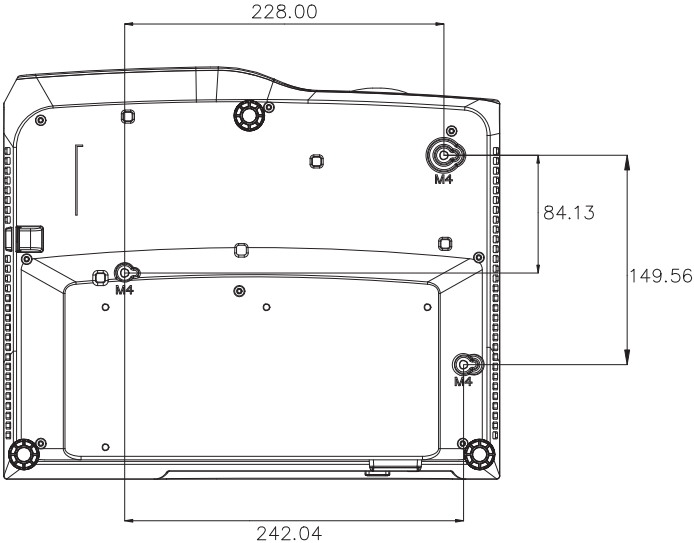

Ceiling mount screws: 3 PCS
Screws specs: $\Phi=4\text{mm}$ L=10mm

Appendices

LED indicator messages

LED Type	Color	Status	Meaning
Power LED	Amber	Flash	Normal power of standby mode.
Temp LED	Red	Off	
Light LED	Red	Off	
Power LED	Amber	Flash	Low power of standby mode.
Temp LED	Red	Off	
Light LED	Red	Off	
Power LED	Amber	Flash	Powering up
Temp LED	Red	Off	
Light LED	Red	Off	
Power LED	Green	Solid	Normal operation
Temp LED	Red	Off	
Light LED	Red	Off	
Power LED	Green	Solid	Powering down
Temp LED	Red	Off	
Light LED	Red	Off	
Power LED	Amber	Solid	If the projector system has some problems with its fans, the projector will shut down.
Temp LED	Red	Off	
Light LED	Red	Off	
Power LED	Amber	Solid	1. Temperature is too high. The light will turn off. The fan motor is cooling the light. Or 2. The cooling process is not complete after the projector is shut down and re-started right away.
Temp LED	Red	Flash	
Light LED	Red	Off	
Power LED	Amber	Flash	The light ignition failed. If temperature is too high, the fans will cool the light.
Temp LED	Red	Off	
Light LED	Red	Solid	
Power LED	Amber	Solid	Color wheel start fail
Temp LED	Red	Solid	
Light LED	Red	Solid	
Power LED	Green	Solid	FAN error
Temp LED	Red	Solid	
Light LED	Red	Off	
Power LED	Green	Solid	Laser lit error
Temp LED	Red	Off	
Light LED	Red	Solid	

Compatibility modes

1. VGA Analog

Supported timing for PC input

Resolution	Timing	Horizontal Frequency (KHz)	Vertical Frequency (Hz)	Pixel Frequency (MHz)	3D Field Sequential	3D Top-Bottom	3D Side by Side
640 x 480	VGA_60	59.94	31.469	25.175	⊙	⊙	⊙
	VGA_72	72.809	37.861	31.500			
	VGA_75	75	37.5	31.500			
	VGA_85	85.008	43.269	36.000			
720 x 400	720 x 400_70	70.087	31.469	28.3221			
800 x 600	SVGA_60	60.317	37.879	40.000	⊙	⊙	⊙
	SVGA_72	72.188	48.077	50.000			
	SVGA_75	75	46.875	49.500			
	SVGA_85	85.061	53.674	56.250			
	SVGA_120 (Reduce Blanking)	119.854	77.425	83.000	⊙		
1024 x 768	XGA_60	60.004	48.363	65.000	⊙	⊙	⊙
	XGA_70	70.069	56.476	75.000			
	XGA_75	75.029	60.023	78.750			
	XGA_85	84.997	68.667	94.500			
	XGA_120 (Reduce Blanking)	119.989	97.551	115.5	⊙		
1152 x 864	1152 x 864_75	75	67.5	108			
1280 x 720	1280 x 720_60	60	45	74.250	⊙	⊙	⊙
	1280 x 720_120	120	90.000	148.500	⊙		
1280 x 768	1280 x 768_60	59.87	47.776	79.5	⊙	⊙	⊙
1280 x 800	WXGA_60	59.81	49.702	83.500	⊙	⊙	⊙
	WXGA_75	74.934	62.795	106.500			
	WXGA_85	84.88	71.554	122.500			
	WXGA_120 (Reduce Blanking)	119.909	101.563	146.25	⊙		
1280 x 1024	SXGA_60	60.02	63.981	108.000		⊙	⊙
	SXGA_75	75.025	79.976	135.000			
	SXGA_85	85.024	91.146	157.500			
1280 x 960	1280 x 960_60	60	60	108.000		⊙	⊙
	1280 x 960_85	85.002	85.938	148.500			

1360 x 768	1360 x 768_60	60.015	47.712	85.5		⊙	⊙
1440 x 900	WXGA+_60	59.887	55.935	106.500		⊙	⊙
1400 x 1050	SXGA+_60	59.978	65.317	121.750		⊙	⊙
1600 x 1200	UXGA	60	75	162.000		⊙	⊙
1680 x 1050	1680 x 1050_60	59.954	65.29	146.25		⊙	⊙
1920 x 1080	1920 x 1080_60 (Reduce Blanking)	67.5	60	148.5			
1920 x 1200	1920 x 1200_60 (Reduce Blanking)	59.95	74.038	154.000			
640 x 480 @67Hz	MAC13	66.667	35	30.240			
832 x 624 @75Hz	MAC16	74.546	49.722	57.280			
1024 x 768 @75Hz	MAC19	75.02	60.241	80.000			
1152 x 870 @75Hz	MAC21	75.06	68.68	100.000			

- The timings showing above may not be supported due to EDID file and VGA graphic card limitations. It is possible that some timings cannot be chosen.

Supported timing for Component-YPbPr input

Timing	Resolution	Horizontal Frequency (KHz)	Vertical Frequency (Hz)	Pixel Frequency (MHz)	3D Field Sequential
480i	720 x 480	15.73	59.94	13.5	⊙
480p	720 x 480	31.47	59.94	27	⊙
576i	720 x 576	15.63	50	13.5	
576p	720 x 576	31.25	50	27	
720/50p	1280 x 720	37.5	50	74.25	
720/60p	1280 x 720	45.00	60	74.25	⊙
1080/50i	1920 x 1080	28.13	50	74.25	
1080/60i	1920 x 1080	33.75	60	74.25	
1080/24P	1920 x 1080	27	24	74.25	
1080/25P	1920 x 1080	28.13	25	74.25	
1080/30P	1920 x 1080	33.75	30	74.25	
1080/50P	1920 x 1080	56.25	50	148.5	
1080/60P	1920 x 1080	67.5	60	148.5	

2. HDMI Digital

Supported timing for PC input

Resolution	Timing	Horizontal Frequency (KHz)	Vertical Frequency (Hz)	Pixel Frequency (MHz)	3D Field Sequential	3D Top-Bottom	3D Side by Side
640 x 480	VGA_60	59.94	31.469	25.175	◎	◎	◎
	VGA_72	72.809	37.861	31.500			
	VGA_75	75	37.5	31.500			
	VGA_85	85.008	43.269	36.000			
720 x 400	720 x 400_70	70.087	31.469	28.3221			
800 x 600	SVGA_60	60.317	37.879	40.000	◎	◎	◎
	SVGA_72	72.188	48.077	50.000			
	SVGA_75	75	46.875	49.500			
	SVGA_85	85.061	53.674	56.250			
	SVGA_120 (Reduce Blanking)	119.854	77.425	83.000	◎		
1024 x 768	XGA_60	60.004	48.363	65.000	◎	◎	◎
	XGA_70	70.069	56.476	75.000			
	XGA_75	75.029	60.023	78.750			
	XGA_85	84.997	68.667	94.500			
	XGA_120 (Reduce Blanking)	119.989	97.551	115.5	◎		
1152 x 864	1152 x 864_75	75	67.5	108			
1280 x 720	1280 x 720_60	60	45	74.250	◎	◎	◎
1280 x 768	1280 x 768_60	59.87	47.776	79.5	◎	◎	◎
1280 x 800	WXGA_60	59.81	49.702	83.500	◎	◎	◎
	WXGA_75	74.934	62.795	106.500			
	WXGA_85	84.88	71.554	122.500			
	WXGA_120 (Reduce Blanking)	119.909	101.563	146.25	◎		
1280 x 1024	SXGA_60	60.02	63.981	108.000		◎	◎
	SXGA_75	75.025	79.976	135.000			
	SXGA_85	85.024	91.146	157.500			
1280 x 960	1280 x 960_60	60	60	108.000		◎	◎
	1280 x 960_85	85.002	85.938	148.500			
1360 x 768	1360 x 768_60	60.015	47.712	85.5		◎	◎
1440 x 900	WXGA+_60	59.887	55.935	106.500		◎	◎
1400 x 1050	SXGA+_60	59.978	65.317	121.750		◎	◎

1600 x 1200	UXGA	60	75	162.000		◎	◎
1680 x 1050	1680 x 1050_60	59.954	65.29	146.25		◎	◎
640 x 480 @67Hz	MAC13	66.667	35	30.240			
832 x 624 @75Hz	MAC16	74.546	49.722	57.280			
1024 x 768 @75Hz	MAC19	75.02	60.241	80.000			
1152 x 870 @75Hz	MAC21	75.06	68.68	100.000			
1920 x 1080	1920 x 1080_60 (Reduce Blanking)	67.5	60	148.5			
1920 x 1200	1920 x 1200_60 (Reduce Blanking)	59.95	74.038	154.000			
3840 x 2160*	3840 x 2160_30	30	67.5	297			
3840 x 2160*	3840 x 2160_60	60	135	594			

- The timings showing above may not be supported due to EDID file and VGA graphic card limitations. It is possible that some timings cannot be chosen.
- *DW2650Z is not supported.

Supported timing for video input

Timing	Resolution	Horizontal Frequency (KHz)	Vertical Frequency (Hz)	Pixel Frequency (MHz)	3D Field Sequential	3D Frame Packing	3D Top-Bottom	3D Side by Side
480i	720 (1440) x 480	15.73	59.94	27	⊙			
480p	720 x 480	31.47	59.94	27	⊙			
576i	720 (1440) x 576	15.63	50	27				
576p	720 x 576	31.25	50	27				
720/50p	1280 x 720	37.5	50	74.25		⊙	⊙	⊙
720/60p	1280 x 720	45.00	60	74.25	⊙	⊙	⊙	⊙
1080/50i	1920 x 1080	28.13	50	74.25				⊙
1080/60i	1920 x 1080	33.75	60	74.25				⊙
1080/24P	1920 x 1080	27	24	74.25		⊙	⊙	⊙
1080/25P	1920 x 1080	28.13	25	74.25				
1080/30P	1920 x 1080	33.75	30	74.25				
1080/50P	1920 x 1080	56.25	50	148.5			⊙	⊙
1080/60P	1920 x 1080	67.5	60	148.5			⊙	⊙
2160/24P*	3840 x 2160	54	24	297				
2160/25P*	3840 x 2160	56.25	25	297				
2160/30P*	3840 x 2160	67.5	30	297				
2160/50P*	3840 x 2160	112.5	50	594				
2160/60P*	3840 x 2160	135	60	594				

- *DW2650Z is not supported.

Troubleshooting

Refer to the symptoms and measures listed below before sending the projector for repairs. If the problem persists, contact your local reseller or service center. Please refer to "LED Indicator Messages" as well.

Start-up problems

If no lights turn on:

- Be sure that the power cord is securely connected to the projector and the other end is plugged into an outlet with power.
- Press the power button again.
- Unplug the power cord and wait for a short while, then plug it in and press the power button again.

Image problems

If the searching source is displayed:

- Press **Source** to select an active input source.
- Be sure the external source is turned on and connected.
- For a computer connection, ensure your notebook computer's external video port is turned on. Refer to the computer manual.

If the image is out of focus:

- While displaying the on-screen menu, adjust the focus ring. (The image size should not change; if it does, you are adjusting the zoom, not the focus.)
- Check the projection lens to see if it needs cleaning.
- If the image is flickering or unstable for a computer connection:
- Press **Menu**, go to **Display** and adjust **Phase** or **H.Size**.

Remote control problems

If the remote control does not operate:

- Be sure nothing is blocking the remote control receiver on the front of the projector. Use the remote control within the effective range.
- Aim the remote control at the screen or at the front of the projector.
- Move the remote control so it is more directly in front of the projector and not as far to the side.

RS-232 command and configuration

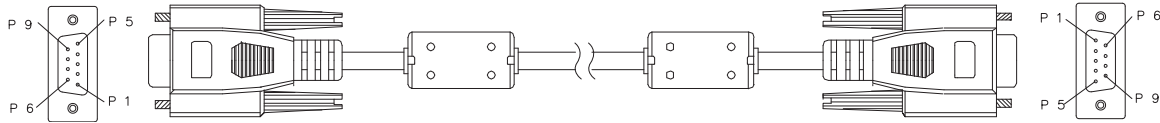

D-Sub 9 pin

1	1 CD
2	RXD
3	TXD
4	DTR
5	GND
6	DSR
7	RTS
8	CTS
9	RI

Wire List

C1	COLOR	C2
1	Black	1
2	Brown	3
3	Red	2
4	Orange	6
5	Yellow	5
6	Green	4
7	Blue	8
8	Purple	7
9	White	9
SHELL	DW	SHELL

You can use the serial control command to input commands for projector control or retrieve its operational data through Windows client terminal software.

Item	Parameter
Baud Rate	9600 bps
Data Length	8 bit
Parity Check	None
Stop Bit	1 bit
Flow Control	None

Operation commands

Operation command syntax

An operation command is prefixed by character "op", followed by control commands and settings separated by space blank [SP], and ended by carriage return pair "CR" and "ASCII hex 0D". Syntax of serial control commands:

op[SP]<operation command>[SP]<Setting Value>[CR]

- op** A constant indicating this is an operation command
- [SP]** Indicate one blank space
- [CR]** Indicate the command ending carriage return pair "CR" and "ASCII hex 0D"

Setting value Settings of operation command

Types of setup strings	Characters of settings	Description
Query current setup	?	Question mark "?" indicates querying current setup
Setup	= <settings>	Syntax: Symbol "=" suffixed with setup values
Query current setup	+	Some settings are changed in steps. Symbol "+" indicates changing one step up
Decrease setup order of adjustment items	-	Some settings are changed in steps. Symbol "-" indicates changing one step down
Execute operation command	None	Certain operation commands execute after input without further setting or regulators

Examples:

Control items	Input command row	Projector return message
Execute command	reset.all[CR]	RESET.ALL
Query current brightness	op bright ?[CR]	OP BRIGHT =50
Set up brightness	op bright =100[CR]	OP BRIGHT =100
Brightness value + 1	op bright +[CR]	OP BRIGHT ="new value"
Brightness value - 1	op bright -[CR]	OP BRIGHT ="new value"
Out of range or not support	op bright =200[CR]	OP BRIGHT =NA
Illegal command	op abright =100[CR]	*Illegal format#

Note:

When sending the multiple commands, make sure the return message of the last command is received before sending out the next one.

Function		Operation	Set	Get	Inc	Dec	EXE	Values
Display	Screen Color	blankscreen.color	V	V				0 = Off 1 = BlackBoard 2 = GreenBoard 3 = WhiteBoard
	Aspect Ratio	aspect	V	V				0 = Auto 1 = 4:3 2 = 16:9 3 = Panorama 4 = Anamorphic 5 = 2.35:1 6 = 16:10 7 = 16 :6
	Keystone	v.keystone	V	V	V	V		-30 ~ +30
		h.keystone	V	V	V	V		-30 ~ +30
	4 Corner Top Left X	4corner.tlx	V	V	V	V		0 ~ +60
	4 Corner Top Left Y	4corner.tly	V	V	V	V		0 ~ +60
	4 Corner Top Right X	4corner.trx	V	V	V	V		0 ~ +60
	4 Corner Top Right Y	4corner.try	V	V	V	V		0 ~ +60
	4 Corner Bottom Left X	4corner.blx	V	V	V	V		0 ~ +60
	4 Corner Bottom Left Y	4corner.bly	V	V	V	V		0 ~ +60
	4 Corner Bottom Right X	4corner.brx	V	V	V	V		0 ~ +60
	4 Corner Bottom Right y	4corner.bry	V	V	V	V		0 ~ +60
	4 Corner Reset	4corner.reset					V	
	Position X	h.pos	V	V	V	V		-5 ~ +5 -100 ~ +100(Auto Sync Off)
	Position Y	v.pos	V	V	V	V		-5 ~ +5 -100 ~ +100(Auto Sync Off)
	Phase	phase	V	V	V	V		0 ~ 31
	H.Size	h.size	V	V	V	V		-15~ +15
Digital Zoom	zoom	V	V	V	V		-10 ~ +10 (PC: 0.8X ~1.0x~2.0X)	
Image	Color Mode	pic.mode	V	V				0: Presentation 1: Bright 2: Movie
	Brightness	bright	V	V	V	V		0 ~ 100
	Contrast	contrast	V	V	V	V		0 ~ 100
	Color Temperature	color.temp	V	V				0 = Warm 1 = Normal 2 = Cold
	Gain	red.gain	V	V	V	V		0 ~ +100
		green.gain	V	V	V	V		0 ~ +100
		blue.gain	V	V	V	V		0 ~ +100
	Offset	red.offset	V	V	V	V		-50~ +50
		green.offset	V	V	V	V		-50~ +50
		blue.offset	V	V	V	V		-50~ +50
HDMI Format	color.space	V	V				0 : Auto 1 : RGB 2 : YUV	

Image	HDR	hdr.control	V	V				0 : Auto 1 : On 2 : Off
	HDMI Range	hdmi.range	V	V				0 : Auto 1 : Enhance 2 : Normal
	Sharpness	sharp	V	V	V	V		0 ~ 31
	Gamma	gamma	V	V				1 ~ 5
	Brilliant Color	bri.color	V	V	V	V		0 =Off, 1~ 10
	Noise Reduction	noise.reduce	V	V	V	V		0 ~ 31
	Color Manager/ Red Gain	hsg.r.gain	V	V	V	V		0 ~ 399
	Color Manager/ Green Gain	hsg.g.gain	V	V	V	V		0 ~ 399
	Color Manager/ Blue Gain	Hsg.b.gain	V	V	V	V		0 ~ 399
	Color Manager/ Cyan Gain	hsg.c.gain	V	V	V	V		0 ~ 399
	Color Manager/ Magenta Gain	hsg.m.gain	V	V	V	V		0 ~ 399
	Color Manager/ Yellow Gain	hsg.y.gain	V	V	V	V		0 ~ 399
	Color Manager/ Red Saturation	hsg.r.sat	V	V	V	V		0 ~ 399
	Color Manager/ Green Saturation	hsg.g.sat	V	V	V	V		0 ~ 399
	Color Manager/ Blue Saturation	Hsg.b.sat	V	V	V	V		0 ~ 399
	Color Manager/ Cyan Saturation	hsg.c.sat	V	V	V	V		0 ~ 399
	Color Manager/ Magenta Saturation	hsg.m.sat	V	V	V	V		0 ~ 399
	Color Manager/ Yellow Saturation	Hsg.y.sat	V	V	V	V		0 ~ 399
	Color Manager/ Red Hue	hsg.r.hue	V	V	V	V		0 ~ 399
	Color Manager/ Green Hue	hsg.g.hue	V	V	V	V		0 ~ 399
	Color Manager/ Blue Hue	Hsg.b. hue	V	V	V	V		0 ~ 399
	Color Manager/ Cyan Hue	hsg.c. hue	V	V	V	V		0 ~ 399
	Color Manager/ Magenta Hue	hsg.m. hue	V	V	V	V		0 ~ 399
	Color Manager/ Yellow Hue	Hsg.y. hue	V	V	V	V		0 ~ 399
	Color Manager/ White/Red Gain	hsg.wr.gain	V	V	V	V		0 ~ 399
Color Manager/ White/Green Gain	hsg.wg.gain	V	V	V	V		0 ~ 399	
Color Manager/ White/Blue Gain	Hsg.wb.gain	V	V	V	V		0 ~ 399	
Reset Color Settings	pic.mode.reset					V		
Source	Auto Source	auto.src	V	V				0 = Off 1 = On

Source	3D Format	threed.format	V	V				0 : Frame Sequential 1 : Top / Bottom 2 : Side by side 3 : Frame Packing 4 : Off 5: Auto
	3D Sync Invert	threed.syncinvert	V	V				0 = Off 1 = On
	Standby Setting	standby.power	V	V				0 : Off 1 : Active Audio Out 2 : LAN Control
	Auto Power On	pc.poweron	V	V				0 : Off 1 : On
		direct.poweron	V	V				0 : Off 1 : On
	Auto Power Off	nosignal.poweroff	V	V				0 : Disable 1 : 10 min 2 : 20 min 3 : 30 min
	Sleep Timer	sleep.timer	V	V				0 : Disable 1 : 30 min 2 : 1 hours 3 : 2 hours 4 : 3 hours 5: 4 hours 6: 8 hours 7: 12 hours
	Energy Saving	energy.save	V	V				0 : Off 1 : On
	NetWork / DHCP	net.dhcp	V	V				0 = Off 1 = On
	NetWork / IP Address	net.ipaddr	V	V				<string>
	NetWork / Subnet	net.subnet	V	V				<string>
	NetWork / Gate-way	net.gateway	V	V				<string>
	NetWork / DNS	net.dns	V	V				<string>
NetWork Apply	net.apply					V	0 : Cancel 1 : OK	

Setting 1	Language	lang	V	V			0 = English 1 = French 2 = German 3 = Spanish 4 = Portugues 5 = Simplified Chinese 6 = Traditional Chinese 7 = Italian 8 = Norwegian 9 = Swedish 10 = Dutch 11 = Russian 12 = Polish 13 = Finnish 15 = Korean 17 = Czech 19 = Turkish 21 = Japanese 22 = Thai 25 = Indonesia
	Projection	projection	V	V			0 = Front 1 = Rear 2 = Front Ceiling 3 = Rear Ceiling
	Menu Display Time	menu.timer	V	V			0 : Off 1 : 5 sec 2 : 10 sec 3 : 15 sec 4 : 20 sec 5 : 25 sec 6 : 30 sec
	Menu Position	menu.position	V	V			0 : Top Left 1 : Top Right 2 : Center 3 : Bottom Left 4 : Bottom Right
	Blank	blank.timer	V	V			0 : Disable 1 : 5 min 2 : 10 min 3 : 15 min 4 : 20 min 5 : 25 min 6 : 30min
	Splash Screen	logo	V	V			0 = Standard 1 = Black 2 = Blue 3 = Off
	Pattern	test.pattern	V	V			0 : Off 1 : On
	Message	message	V	V			0 : Off 1 : On

Setting 2	High Altitude Mode	fanspeed	V	V				0 : Off 1 : On	
	Mute	mute	V	V				0 : Off 1 : On	
	Audio Volume	volume	V	V	V	V		0 ~ 20	
	Ring Tone	ringtone	V	V				0 : Off 1 : On	
	Light Settings	light.mode	V	V				0 : ECO 1 : Normal	
	Light Hours	light1.hours		V				<string>	
	Light Hour Reset	light1.reset					V		
	Security Settings	security.lock		V	V				1 : Up 2 : Right 3 : Down 4 : Left Ex: op security.lock =111111
		security.unlock		V					1 : Up 2 : Right 3 : Down 4 : Left Ex: op security.unlock =111111
		security.power		V	V				0 : Off 1 : On
Panel Lock	keypad.lock	V	V				0 : Off 1 : On		
Reset All	reset.all					V			
Information	Power On	power.on					V		
	Power Off	power.off					V		
	Projector Status	status		V				0 : Off 1 : On	
	Input Source	input.sel	V	V				1 : RGB 6 : HDMI 1 9 : HDMI 2	
	Blank	blank	V	V				0 : Off 1 : On	
	Freeze	freeze	V	V				0 : Off 1 : On	
	Source Info	source.info		V				<string>	
	Software Version	sw.ver		V				<string>	
	Serial Number	ser.no		V				<string>	
	Model	model		V				<string>	
Pixel Clock	pixel.clock		V				<string>		

Service information

Europe, Middle East and Africa

Vivitek Service & Support

Zandsteen 15

2132 MZ Hoofddorp

The Netherlands

Tel: Monday - Friday 09:00 - 18:00

English (UK): 0333 0031993

Germany: 0231 7266 9190

France: 018 514 8582

Russian: +7 (495) 276-22-11

International: +31 (0) 20 721 9318

Email: support@vivitek.eu

URL: <http://www.vivitek.eu/support/contact-support>

North America

Vivitek Service Center

15700 Don Julian Road, Suite B

City of Industry, CA. 91745

U.S.A

Tel: 855-885-2378 (Toll-Free)

Email: T.services1@vivitekcorp.com

URL: www.vivitekusa.com

Asia and Taiwan

Vivitek Service Center

7F, No.186, Ruey Kuang Road, Neihu District

Taipei, Taiwan 11491

Tel: 886-2-8797-2088, ext. 6899 (Direct)

Tel: 0800-042-100 (Toll-Free)

Email: kenny.chang@vivitek.com.tw

URL: www.vivitek.com.tw

中国/China

Vivitek客服中心

上海市闵行区申长路618号绿谷广场A座7楼

邮政编码：201106

400客服热线：400 888 3526

公司电话：021-58360088

客服邮箱：service@vivitek.com.cn

官方网站：www.vivitek.com.cn



Visit www.vivitekcorp.com for more product info
Copyright (c) 2023 Delta Electronics, Inc. All Rights Reserved

A brand of  DELTA