

# datavideo

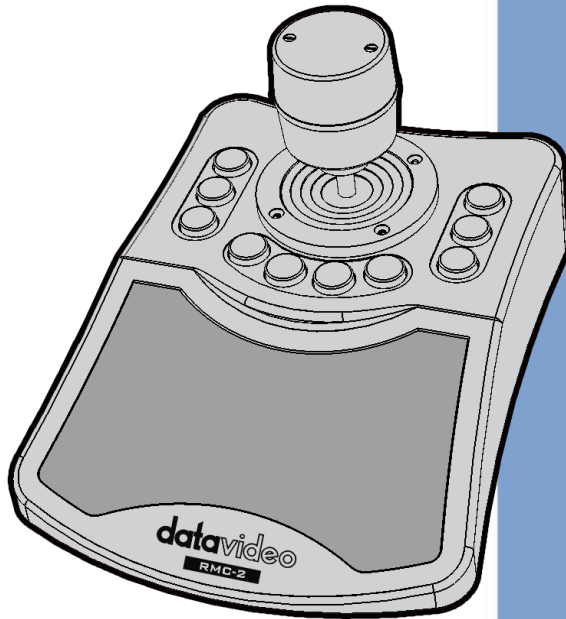

CAMERA CONTROLLER

## RMC-2

# Instruction Manual

[www.datavideo.com](http://www.datavideo.com)

# Table of Contents

TABLE OF CONTENTS .....	2
FCC COMPLIANCE STATEMENT .....	3
WARNINGS AND PRECAUTIONS .....	3
WARRANTY .....	5
<i>STANDARD WARRANTY</i> .....	5
<i>THREE YEAR WARRANTY</i> .....	5
DISPOSAL .....	6
1. PRODUCT OVERVIEW .....	7
FEATURES .....	7
2. LOCATION AND FUNCTION OF PARTS .....	8
3. HOW TO CONNECT YOUR RMC-2 CAMERA CONTROLLER .....	11
3.1 CONNECT TO THE PoE SWITCH .....	11
3.2 CONNECT TO iCAST MINI OR TPC-700 .....	12
4. HOW TO USE RMC-2 TO CONTROL YOUR CAMERA .....	16
5. DIMENSIONS .....	17
6. SPECIFICATIONS .....	18
SERVICE AND SUPPORT .....	20

## Disclaimer of Product and Services

The information offered in this instruction manual is intended as a guide only. At all times, Datavideo Technologies will try to give correct, complete and suitable information. However, Datavideo Technologies cannot exclude that some information in this manual, from time to time, may not be correct or may be incomplete. This manual may contain typing errors, omissions or incorrect information. Datavideo Technologies always recommend that you double check the information in this document for accuracy before making any purchase decision or using the product. Datavideo Technologies is not responsible for any omissions or errors, or for any subsequent loss or damage caused by using the information contained within this manual. Further advice on the content of this manual or on the product can be obtained by contacting your local Datavideo Office or dealer.

## **FCC Compliance Statement**

This device complies with part 15 of the FCC rules. Operation is subject to the following two conditions:

- (1) This device may not cause harmful interference, and
- (2) This device must accept any interference received, including interference that may cause undesired operation.

## **Warnings and Precautions**

1. Read all of these warnings and save them for later reference.
2. Follow all warnings and instructions marked on this unit.
3. Unplug this unit from the wall outlet before cleaning. Do not use liquid or aerosol cleaners. Use a damp cloth for cleaning.
4. Do not use this unit in or near water.
5. Do not place this unit on an unstable cart, stand, or table. The unit may fall, causing serious damage.
6. Slots and openings on the cabinet top, back, and bottom are provided for ventilation. To ensure safe and reliable operation of this unit, and to protect it from overheating, do not block or cover these openings. Do not place this unit on a bed, sofa, rug, or similar surface, as the ventilation openings on the bottom of the cabinet will be blocked. This unit should never be placed near or over a heat register or radiator. This unit should not be placed in a built-in installation unless proper ventilation is provided.
7. This product should only be operated from the type of power source indicated on the marking label of the AC adapter. If you are not sure of the type of power available, consult your Datavideo dealer or your local power company.
8. Do not allow anything to rest on the power cord. Do not locate this unit where the power cord will be walked on, rolled over, or otherwise stressed.

9. If an extension cord must be used with this unit, make sure that the total of the ampere ratings on the products plugged into the extension cord do not exceed the extension cord's rating.
10. Make sure that the total amperes of all the units that are plugged into a single wall outlet do not exceed 15 amperes.
11. Never push objects of any kind into this unit through the cabinet ventilation slots, as they may touch dangerous voltage points or short out parts that could result in risk of fire or electric shock. Never spill liquid of any kind onto or into this unit.
12. Except as specifically explained elsewhere in this manual, do not attempt to service this product yourself. Opening or removing covers that are marked "Do Not Remove" may expose you to dangerous voltage points or other risks, and will void your warranty. Refer all service issues to qualified service personnel.
13. Unplug this product from the wall outlet and refer to qualified service personnel under the following conditions:
  - a. When the power cord is damaged or frayed;
  - b. When liquid has spilled into the unit;
  - c. When the product has been exposed to rain or water;
  - d. When the product does not operate normally under normal operating conditions. Adjust only those controls that are covered by the operating instructions in this manual; improper adjustment of other controls may result in damage to the unit and may often require extensive work by a qualified technician to restore the unit to normal operation;
  - e. When the product has been dropped or the cabinet has been damaged;
  - f. When the product exhibits a distinct change in performance, indicating a need for service.

# Warranty

## ***Standard Warranty***

- Datavideo equipment are guaranteed against any manufacturing defects for one year from the date of purchase.
- The original purchase invoice or other documentary evidence should be supplied at the time of any request for repair under warranty.
- The product warranty period begins on the purchase date. If the purchase date is unknown, the product warranty period begins on the thirtieth day after shipment from a Datavideo office.
- All non-Datavideo manufactured products (product without Datavideo logo) have only one year warranty from the date of purchase.
- Damage caused by accident, misuse, unauthorized repairs, sand, grit or water is not covered under warranty.
- Viruses and malware infections on the computer systems are not covered under warranty.
- Any errors that are caused by unauthorized third-party software installations, which are not required by our computer systems, are not covered under warranty.
- All mail or transportation costs including insurance are at the expense of the owner.
- All other claims of any nature are not covered.
- All accessories including headphones, cables, and batteries are not covered under warranty.
- Warranty only valid in the country or region of purchase.
- Your statutory rights are not affected.

## ***Three Year Warranty***

- All Datavideo products purchased after July 1st, 2017 are qualified for a free two years extension to the standard warranty, providing the product is registered with Datavideo within 30 days of purchase.



- Certain parts with limited lifetime expectancy such as LCD panels, DVD drives, Hard Drive, Solid State Drive, SD Card, USB Thumb Drive, Lighting, Camera module, PCIe Card are covered for 1 year.
- The three-year warranty must be registered on Datavideo's official website or with your local Datavideo office or one of its authorized distributors within 30 days of purchase.

## Disposal

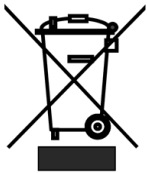

### **For EU Customers only - WEEE Marking**

This symbol on the product or on its packaging indicates that this product must not be disposed of with your other household waste. Instead, it is your responsibility to dispose of your waste equipment by handing it over to a designated collection point for the recycling of waste electrical and electronic equipment. The separate collection and recycling of your waste equipment at the time of disposal will help to conserve natural resources and ensure that it is recycled in a manner that protects human health and the environment. For more information about where you can drop off your waste equipment for recycling, please contact your local city office, your household waste disposal service or the shop where you purchased the product.

# 1. Product Overview

The Datavideo RMC-2 is a simple and versatile camera controller which is designed for controlling Datavideo PTZ series camera via the DVIP protocol. It allows you to recall the pre-saved 1 to 4 presets for each camera rapidly by pressing the Preset button only. Moreover, you can use the pan, tilt and zoom axes of the joystick to control the pan, tilt and zoom functions of the PTZ camera. Furthermore, the RMC-2 also provides three buttons including “FAST”, “MID” and “SLOW” for you to control the speed for panning and tilting of the camera by pressing one button only.

## Features

- The RMC-2 can be used with the TPC-700 or iCAST MINI by connecting an adapter cable from its USB interface.
- It can be controlled by the DVIP Protocol.
- Supports PoE(PD) IEEE 802.3 af Power over Ethernet Standard.
- It can control up to 3 cameras.
- Supports up to 4 preset positions for each connected camera.
- It is a 3 axes joystick to control PTZ camera panning, tilting and zooming.

## 2. Location and Function of Parts



1	<p><b>Joystick</b></p> <p>This is a three axes joystick for you to control the panning and tilting angles of your PTZ camera by pulling the joystick to the up, down, left and right sides. Moreover, it allows you to rotate the joystick to control the automatic Zoom IN/Zoom OUT. Please rotate the joystick to the left side for Zooming OUT and rotate the joystick to the right side for Zooming IN.</p>
---	---



2	<p><b>Camera Selection Buttons</b></p> <p>The RMC-2 allows you to control up to 3 cameras. Please press CAM1, CAM2 or CAM3 button to select your desired camera for further controlling. The currently selected camera number button will be lit in solid red, and other buttons will be lit in solid white.</p>
3	<p><b>Camera Movement Speed Selection Buttons</b></p> <p>The FAST, MID, SLOW buttons here allow you to select your desired camera movement speed. The currently selected option will be lit in solid red, and other buttons will be lit in solid white.</p>
4	<p><b>Preset Positions 1-4</b></p> <p>When your desired preset positions are set in iCAST MINI or in ZR-1 app which is installed in the TPC-700 in advance, you can connect the RMC-2 for recalling the Preset 1 to 4 screens by corresponding Preset buttons. The currently selected option will be lit in solid red, and other buttons will be lit in solid white.</p>
5	<p><b>Ergonomic anti-slip wrist support pad</b></p> <p>This is an Ergonomic, anti-slip and skin friendly wrist support pad which can support your wrist when using the RMC-2 to relieve your fatigue for long-term operation.</p>

## Rear Panel



1	<p><b>DVIP Port</b> <b>This port is currently unavailable.</b></p> <p>If you connect your RMC-2 to a POE switch by this DVIP port and then connect your camera to the same PoE switch by the camera's DVIP port, the PoE switch can supply power for those devices and then you can control the connected cameras by the RMC-2.</p>
2	<p><b>USB Type C Interface</b></p> <p>Take iCAST MINI for example, you can connect from iCAST MINI's USB Type A port to the USB Type C port of the RMC-2 by a USB Type A to USB Type C adapter cable. After that, please connect the iCAST MINI and your camera to the same router and set within the same LAN. After that, please set your desired Preset positions within the iCAST MINI in advance. Finally, you can use your RMC-2 to control your camera and to recall the pre-saved Preset 1 to 4 preset positions.</p>

### 3. How to Connect your RMC-2 Camera Controller

The RMC-2 camera controller allows you to connect to a PoE switch for controlling up to 3 cameras. You can also connect the RMC-2 to the iCAST MINI 4K Dual Channel Presentation Switcher or TPC-700/TPC-700P Touch Panel Controller/Touch Panel Controller with POE to control your camera. Please refer to the following paragraph for the detailed ways of connection.

#### 3.1 Connect to the PoE Switch

Please connect your RMC-2 and up to 3 PTZ cameras to the same PoE switch by the Ethernet cable according to the following diagram. After that, you can use the RMC-2 to control the Panning, Tilting, Zooming and Preset Recalling functions for up to 3 cameras. **Note: The function for RMC-2's DVIP port is currently unavailable.**

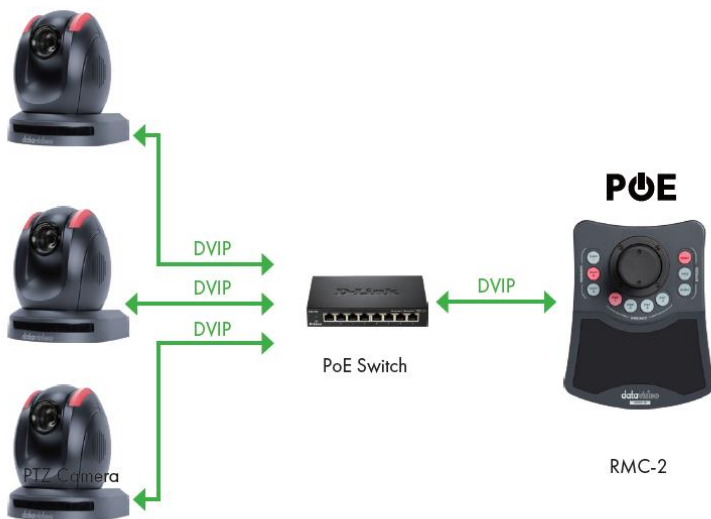

## 3.2 Connect to iCAST MINI or TPC-700

You can connect your RMC-2 camera controller to iCAST MINI or TPC-700 for controlling your camera. We will take iCAST MINI as an example in this chapter. Please connect your RMC-2 camera controller to iCAST MINI according to the diagram below. The factory default for Datavideo iCAST MINI and PTZ series cameras is DHCP mode.

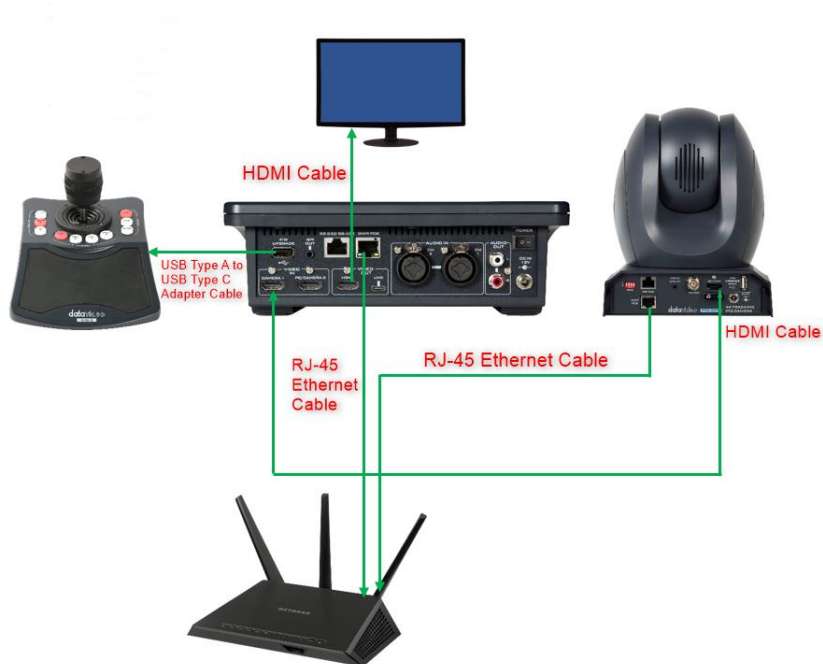

1. At first, please use an Ethernet cable to connect from the “DVIP” interface which is located on the rear panel of your PTZ camera to the “LAN” interface of one router.
2. After that, please use another Ethernet cable to connect from the “DVIP/POE” interface which is located on the rear panel of the iCAST MINI to the “LAN” interface of the same router.
3. Please connect a DC12V power cable to the DCIN 12V power interface which is on the rear panel of the iCAST MINI. After that, please make sure that the power of your iCAST MINI is turned on, and then please connect another DC12V power cable to the DC12V power interface on the rear panel of your PTC series camera.

4. Please tap the camera icon which is located at the top-right corner of the iCAST MINI main interface. After that, please select “DVIP>Scan” from the “Connect” interface.

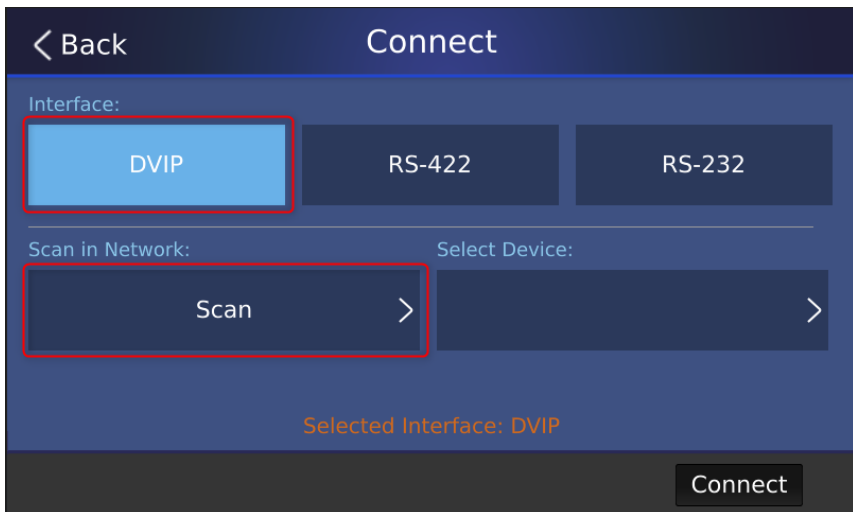



5. If there is only one camera connected, please tap the “Connect” button after the IP address of the connected camera is found by the iCAST MINI. If multiple cameras are connected, please tap “Select Device” option to select the camera that you want to connect, and then please tap the “Apply” button. Finally, please tap the “Connect” button and then wait until the camera icon which is located at the top-right corner of the iCAST MINI main interface becomes selectable, which means that the camera is connected successfully.

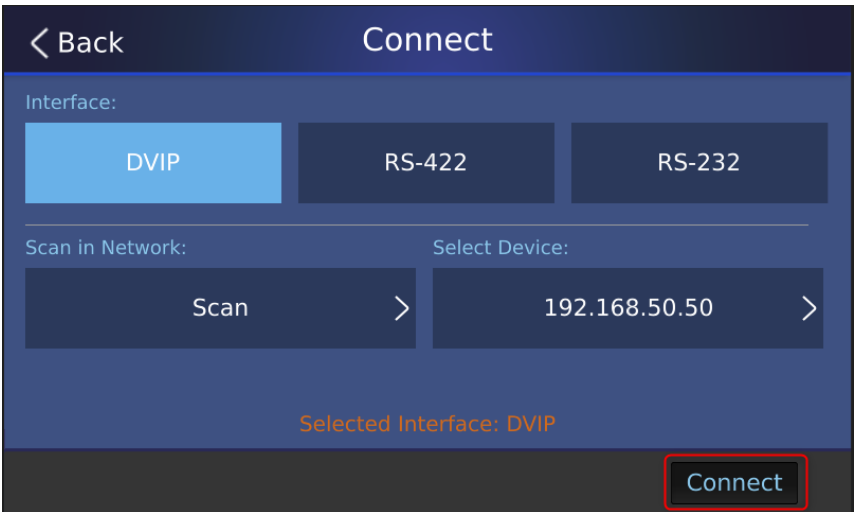



6. Please use a USB type C to USB type A adapter cable to connect from your RMC-2 to the F/W UPGRADE interface which is located on the rear panel of the iCAST MINI. After that, you can use the RMC-2 to control the PTZ camera which is connected to the same LAN as the iCAST MINI. At this time, you can recall the presets which are saved in the iCAST MINI in advance by pressing four PRESET buttons including PST 1 to PST 4.

Note: If you want to connect your RMC-2 to your TPC-700 or TPC-700P in order to control the PTZ cameras which are connected to the iCAST 10NDI, please connect your devices according to the system diagram as below. After that, please set your desired preset positions within ZR-1 app in advance. Finally, you can use the RMC-2 to recall the presaved preset positions.

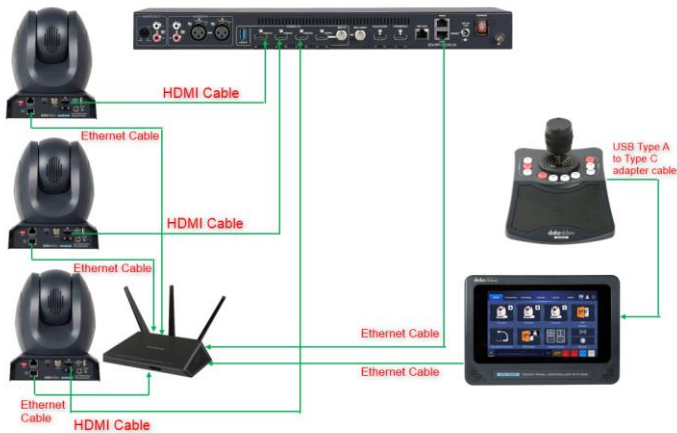

## 4. How to use RMC-2 to Control your Camera

Datavideo RMC-2 provides four sections including “CAMERA”, “PRESET”, “SPEED” and joystick for you to control your PTZ cameras.

- **CAMERA:** If you have more than one camera and those cameras are connected to Datavideo iCAST 10NDI and controlled by TPC-700 or TPC-700P’s ZR-1 app. You can use the CAM1, CAM2 or CAM3 button in this area to select the camera that you want to control.
- **PRESET:** When the PRESET positions are set in advance within the iCAST MINI or the ZR-1 app within the TPC-700 series, you can use the Preset 1 to 4 buttons to recall your desired preset positions.
- **SPEED:** This option allows you to adjust the Pan and Tilt speeds of your camera. There are three speed levels including “FAST”, “MID” and “SLOW” for you to select.
- **Joystick:** This joystick allows you to adjust the Zoom In/Zoom Out of the camera. For Zooming Out, please rotate the joystick to the left side. For Zooming In, please rotate the joystick to the right side.



# 5. Dimensions

Unit: mm

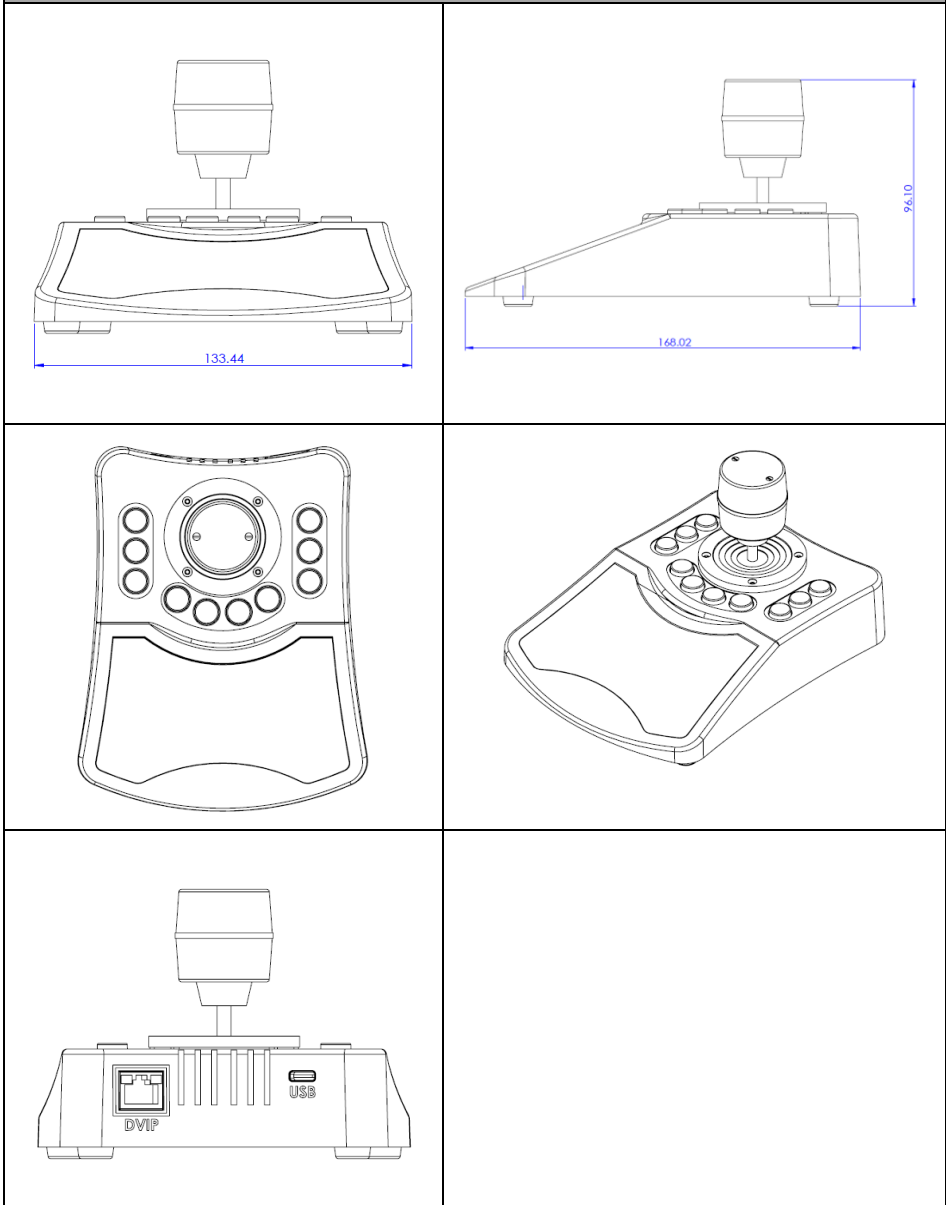

## 6. Specifications

<b>Model Name</b>	<b>RMC-2</b>
<b>Product Name</b>	<b>3 Camera Controller</b>
<b>Maximum Camera Control</b>	3
<b>Present (Position)</b>	4 for each camera
<b>Control Protocol</b>	Datavideo DVIP
<b>Connection to Cameras</b>	Ethernet
<b>Input/Output</b>	USB 2.0 x1 10/100Mbps Ethernet (RJ-45 connector) x1
<b>Firmware Upgrade</b>	Via USB
<b>Dimension</b>	134x169x97 mm
<b>Weight</b>	0.36kg
<b>Operating Temp. Range</b>	0°C ~ 40°C (32°F~104°F)
<b>Storage Temperature</b>	- 10°C ~ 60°C (14°F~140°F)
<b>Operating Humidity</b>	10 % to 80 % (non-condensing)
<b>Power</b>	DC 5V, 8W or IEEE 802.3af
<b>What's in the Box</b>	1 X RMC-2 main unit 1x USB type C to type A cable

# Note

## Service & Support

It is our goal to make your products ownership a satisfying experience. Our supporting staff is available to assist you in setting up and operating your system. Please refer to our web site [www.datavideo.com](http://www.datavideo.com) for answers to common questions, support requests or contact your local office below.

Please visit our website for latest manual update.

[www.datavideo.com/product/RMC-2](http://www.datavideo.com/product/RMC-2)

**datavideo**  
[www.datavideo.com](http://www.datavideo.com)



@DatavideoUSA @DatavideoIndia2016  
@DatavideoEMEA @Datavideojapan  
@DatavideoTaiwan @DatavideoLatam  
@DatavideoAsia @DatavideoBrasil



@Datavideo  
@Datavideo\_EMEA  
@Datavideo\_Taiwan



@DatavideoUSA  
@DVTWDVCN



@DatavideoUSA  
@DatavideoEurope

All the trademarks are the properties of their respective owners.