

USER MANUAL

ProLite

LCD Monitor

ENGLISH

ProLite T1633MC
ProLite TF1633MC

Thank you very much for choosing the iiyama LCD monitor.

We recommend that you take a few minutes to read this comprehensive manual carefully before installing and switching on the monitor. Please keep this manual in a safe place for your future reference.



Dear user, we congratulate you on the purchase of your iiyama LCD.

For details on warranty and locally used pixel policies that apply directly after installation of your product please check the iiyama website.

To report a fault, please contact your local support centre found at <https://iiyama.com>

Things to check before you call the iiyama information line

- | if the power cable is connected securely and turned on?
- | if the display has been turned on?
- | if the signal cable is connected securely and the correct input selected?
- | if the computer has been restarted with the display connected?
- | if the graphics card is correctly installed with the latest drivers possible?
- | if the correct native resolution has been selected via 'Display Properties'?
- | If the R/G/B signal configuration is correct?
- | if the displays On Screen Menu is shown?
- | if the correct brightness and contrast settings have been set?
- | if given display tolerances and compatibility have been considered?
- | if via the On Screen Menu you have performed a Factory Reset/Recall?

Before reporting the screen defect, please prepare the following information/evidence:

- | model number *
- | purchase receipt and serial number *
- | name and address for collection
- | telephone/fax number, for availability during the day
- | convenient collection date (date, time)
- | short description of the defect

Important Note:

If there is no fault found in the collected equipment after inspection, the transferring party shall incur charges for transport and administration.

If you have checked all of the above and there is still no picture, call our information line for assistance in your country.

Feedback on health and safety issues

If you have any health and safety concerns or questions about the product (including when using the product), please contact iiyama support through our website. You can also contact us by calling +31 204460404. After receiving your feedback, we will ask the responsible unit to handle it as soon as possible and a dedicated person will get back to you. Your feedback will also be recorded and incorporated into our evaluation for improvements

* see the identification plate on the back of the case.

CE MARKING DECLARATION OF CONFORMITY

This LCD monitor complies with the requirements of the EC/EU Directive 2014/30/EU "EMC Directive", 2014/35/EU "Low Voltage Directive", 2009/125/EC "ErP Directive" and 2011/65/EU "RoHS Directive".

The electro-magnetic susceptibility has been chosen at a level that gives correct operation in residential areas, business and light industrial premises and small-scale enterprises, inside as well as outside of the buildings. All places of operation are characterised by their connection to the public low voltage power supply system.

IYYAMA CORPORATION: Wijkemeerstraat 8, 2131 HA Hoofddorp, The Netherlands

Model No. : PLT1633M



We recommend recycling of used product. Please contact your dealer or iiyama service center. Recycle information is obtained via the Internet, using the address: <https://iiyama.com>

You can access the Web page of different countries from there.

- We reserve the right to change specifications without notice.
- All trademarks used in this user manual are the property of their respective owners.
- Eprel registration number T1633MSC-B1 : 1629639, TF1633MSC-B1 : 1629699

TABLE OF CONTENTS

FOR YOUR SAFETY.....	1
SAFETY PRECAUTIONS.....	1
SPECIAL NOTES ON LCD MONITORS.....	3
CUSTOMER SERVICE.....	3
CLEANING.....	3
BEFORE YOU OPERATE THE MONITOR.....	4
FEATURES.....	4
SPECIAL NOTES ON TOUCH PANEL.....	4
BUILT-IN EQUIPMENT.....	4
CHECKING THE CONTENTS OF THE PACKAGE.....	5
INSTALLATION.....	6
FITTING AND REMOVAL OF STAND : ProLite T1633MSC.....	7
CONTROLS AND CONNECTORS.....	8
CONNECTING YOUR MONITOR.....	9
FITTING OF CABLE COVER : ProLite T1633MSC.....	10
ADJUSTING THE VIEWING ANGLE :	
ProLite T1633MSC / ProLite TF1633MSC.....	10
COMPUTER SETTING.....	11
OPERATING THE MONITOR.....	13
ADJUSTMENT MENU CONTENTS.....	14
STANDBY FEATURE.....	19
TROUBLE SHOOTING.....	20
RECYCLING INFORMATION.....	21
APPENDIX.....	22
SPECIFICATIONS : ProLite T1633MSC-B1.....	22
SPECIFICATIONS : ProLite TF1633MSC-B1.....	23
DIMENSIONS : ProLite T1633MSC.....	24
DIMENSIONS : ProLite TF1633MSC.....	24
COMPLIANT TIMING.....	24

FOR YOUR SAFETY

SAFETY PRECAUTIONS

WARNING

STOP OPERATING THE MONITOR WHEN YOU SENSE TROUBLE

If you notice any abnormal phenomena such as smoke, strange sounds or fumes, unplug the monitor and contact your dealer or iiyama service center immediately. Further use may be dangerous and can cause fire or electric shock.

NEVER REMOVE THE CABINET

High voltage circuits are inside the monitor. Removing the cabinet may expose you to the danger of fire or electric shock.

DO NOT PUT ANY OBJECT INTO THE MONITOR

Do not put any solid objects or liquids such as water into the monitor. In case of an accident, unplug your monitor immediately and contact your dealer or iiyama service center. Using the monitor with any object inside may cause fire, electric shock or damage.

INSTALL THE MONITOR ON A FLAT, STABLE SURFACE

The monitor may cause an injury if it falls or is dropped.

DO NOT USE THE MONITOR NEAR WATER

Do not use where water may be splashed or spilt onto the monitor as it may cause fire or electric shock.

OPERATE UNDER THE SPECIFIED POWER SUPPLY

Be sure to operate the monitor only with the specified power supply. Use of an incorrect voltage will cause malfunction and may cause fire or electric shock.

CORRECT USE OF THE AC ADAPTER

Use only the AC Adapter provided by iiyama. Any deviation from this by using another type of adapter may result in damage to the accessory and the monitor by fire or electric shock.

DO NOT DISASSEMBLE THE AC ADAPTER

Disassembling the AC Adapter may expose you to the danger of fire or electric shock.

PROTECT THE CABLES

Do not pull or bend the power cable and signal cable. Do not place the monitor or any other heavy objects on the cables. If damaged, the cables may cause fire or electric shock.

ADVERSE WEATHER CONDITIONS

It is advisable not to operate the monitor during a heavy thunder storm as the continual breaks in power may cause malfunction. It is also advised not to touch the plug in these circumstances as it may cause electric shock.

CAUTION

INSTALLATION LOCATION

Do not install the monitor where sudden temperature changes may occur, or in humid, dusty or smoky areas as it may cause fire, electric shock or damage. You should also avoid areas where the sun shines directly on the monitor.

DO NOT PLACE THE MONITOR IN A HAZARDOUS POSITION

The monitor may topple and cause injury if not suitably located. Please also ensure that you do not place any heavy objects on the monitor, and that all cables are routed such that children may not pull the cables and possibly cause injury.

MAINTAIN GOOD VENTILATION

Ventilation slots are provided to keep the monitor from overheating. Covering the slots may cause fire. To allow adequate air circulation, place the monitor at least 10cm (or 4 inches) from any walls. When removing the tilt stand, the ventilation slots on the back side of the monitor can be blocked. This may overheat the monitor and may cause fire or damage. Make sure to allow enough ventilation when removing the tilt stand. Operating the monitor on its back, side, upside down or on a carpet or any other soft material may also cause damage.

DISCONNECT THE CABLES WHEN YOU MOVE THE MONITOR

When you move the monitor, turn off the Power Button, unplug the monitor and be sure the signal cable is disconnected. If you do not disconnect them, it may cause fire or electric shock.

UNPLUG THE MONITOR

If the monitor is not in use for a long period of time, it is recommended that it is left unplugged to avoid accidents.

HOLD THE PLUG WHEN DISCONNECTING

To disconnect the AC adapter, the power cable or signal cable, always pull it by the plug. Never pull on the cable itself as this may cause fire or electric shock.

DO NOT TOUCH THE PLUG WITH WET HANDS

Pulling or inserting the plug with wet hands may cause electric shock.

WHEN YOU INSTALL THE MONITOR ON YOUR COMPUTER

Be sure the computer is strong enough to hold the weight of the monitor, otherwise, you may damage your computer.

REMARK FOR 24/7 USAGE

This product is not specifically designed for 24/7 usage in all environments.

OTHERS

ERGONOMIC RECOMMENDATIONS

To eliminate eye fatigue, do not operate the monitor against a bright background or in a dark room. For optimal viewing comfort, the monitor should be just below eye level and 40-60cm (16-24 inches) away from your eyes. When using the monitor over a prolonged time, a ten minute break every hour is recommended as looking at the screen continuously can cause eye strain.

SPECIAL NOTES ON LCD MONITORS

The following symptoms are normal with LCD monitors and do not indicate a problem.

NOTE

- When you first turn on the LCD monitor, the picture may not fit in the display area because of the type of computer that is used. In this case, adjust the picture position to the correct position.
- You may find slightly uneven brightness on the screen depending on the desktop pattern you use.
- Due to the nature of the LCD screen, an afterimage of the previous screen may remain after switching the image, when the same image is displayed for hours. In this case, the screen is recovered slowly by changing the image or turning off the Power Button for hours.

CUSTOMER SERVICE

NOTE

- If you have to return your unit for service and the original packaging has been discarded, please contact your dealer or iiyama service center for advice or replacement packaging.

CLEANING

WARNING

- If you drop any materials or liquids such as water into the monitor when cleaning, unplug the power cable immediately and contact your dealer or iiyama service center.

NOTE

- To protect the Touch screen surface, do not scratch or rub the screen with a hard object.
- Never use any of the following strong solvents. These will damage the cabinet and the Touch screen surface.
Abrasive cleaner Wax Acid or Alkaline solvent
- Touching the cabinet with any product made from rubber or plastic for a long time may cause degeneration or loss of paint on the cabinet.

CABINET

Stains can be removed with a cloth lightly moistened with a mild detergent solvent. Then wipe the cabinet with a soft dry cloth.

TOUCH SCREEN

Touch screen surface may be cleaned using a soft clean cloth moistened with mild window glass commercial cleaners or 50/50 mixture of water and isopropyl alcohol.

BEFORE YOU OPERATE THE MONITOR

FEATURES

- ◆ Supports Resolutions up to 1920 × 1080
- ◆ High Contrast 1000:1 (Typical)
Brightness 450cd/m² (Typical), 385cd/m² (with Touch Panel)
- ◆ Blue Light Reducer
- ◆ Digital Character Smoothing
- ◆ Stereo Speakers
2 × 2W Stereo Speakers
- ◆ Standby Feature
- ◆ VESA Mounting Standard (100mm×100mm) Compliant
- ◆ IP54 Standard Compliant (Only Front Face)
- ◆ Keyhole for Security Lock
- ◆ 10 point Touch

■ Windows 7/8/8.1/10/11 touch environment

Basic touch operations can be performed under Windows 7/8/8.1/10/11.

However, please be informed that full touch functionality and normal operational performance are not guaranteed.

SPECIAL NOTES ON TOUCH PANEL

Permanent damage can occur if Sharp Edged, Pointed or Metal items are used to activate Touch.

This could invalidate any remaining warranty.

We recommend to use a plastic stylus (tip R0.8 or over) or finger.

BUILT-IN EQUIPMENT

CAUTION

This product is not designed for the purpose of being used in high temperature environment.

If the product is placed in an external cabinet, you need to design cooling fans and vents to keep the temperature low enough to fit in the product temperature specification.

CHECKING THE CONTENTS OF THE PACKAGE

The following accessories are included in your package. Check to see if they are enclosed with the monitor. If anything is missing or damaged, please contact your local iiyama dealer or regional iiyama office.

- AC Adapter*¹
- USB Cable
- Screwdriver*²
- Safety Guide
- Power Cable*¹
- Stand-Neck with a screw*²
- Cable Cover
- Quick Start Guide
- HDMI Cable
- Stand-Base with a screw*²
- Screws for Cable Cover (2pcs)

CAUTION

*¹ 1. TO USERS IN 120V AREA

The rating of the Power Cable enclosed in 120V area is 10A/125V. If you are using a power supply higher than this rating, then a power cable with a rating of 10A/250V must be used.

However, all guarantees and warranties are void for any problems or damage caused by a power cable or AC adapter not supplied by iiyama.

2. The AC Adapter has the specifications shown in the table below.

3. An approved power cable greater or equal to H05VVF, 3G, 0.75mm² must be used.

*² Accessory for ProLite T1633MSC.

AC Adapter Specifications

Type Name	ADPC1245
Manufacturer	TPV Electronics (Fujian) Co., Ltd. Rongqiao Economic and Technological Development Zone, Fuqing City, Fujian Province, P.R.China
Input Voltage	100-240VAC
Input AC Frequency	50-60Hz
Output Voltage	12.0V
Output Current	3.75A
Output Power	45.0W
Average Active Efficiency (230V/50Hz)	89.4% minimum
Efficiency at Low Load (10%) (230V/50Hz)	87.2% minimum
No-Load Power Consumption (230V/50Hz)	0.09W maximum

INSTALLATION

- CAUTION** ■ Before installation, make sure the wall, ceiling or desktop arm is strong enough to hold the necessary weight of the display and the mount.

< WALL MOUNTING >

- CAUTION** When you use with the wall mounting, in consideration of thickness of the mounting stage, tighten the M4 Screws (4pcs) which "L" length is 8mm to fasten the monitor. Using the screw longer than this may cause electric shock or damage because it may contact with the electrical parts inside the monitor.

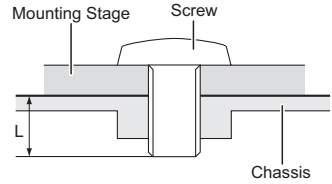

< ROTATING THE MONITOR >

It is designed to be compatible in landscape mode.

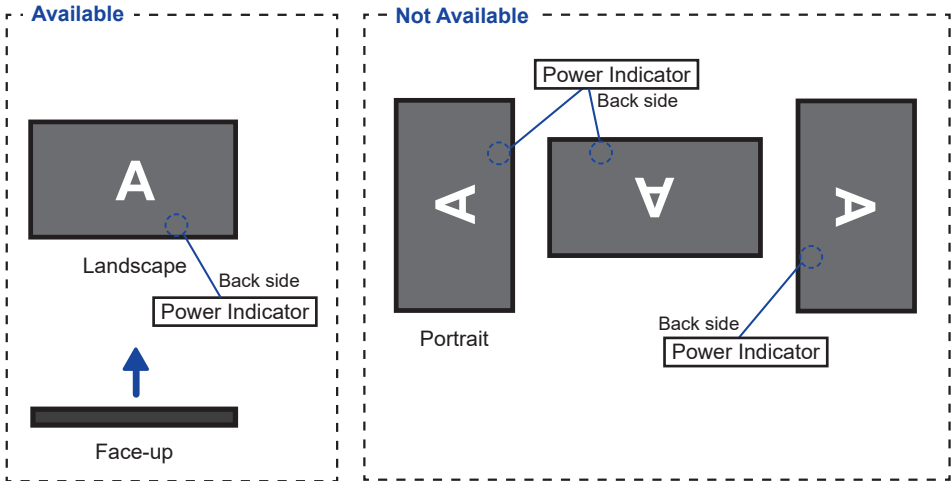

FITTING AND REMOVAL OF STAND : ProLite T1633MSC

CAUTION

- Put the monitor on a stable surface. The monitor may cause injury or damage if it falls or is dropped.
- Do not give a strong impact to the monitor. It may cause damage.
- Unplug the monitor before removal or installation to avoid an electric shock or a damage.

<Installation>

- ① Put a piece of soft cloth on the table beforehand to prevent the monitor from being scratched. Lay the monitor flat on a table with front face down.
- ② Hold the monitor and install the Stand-Neck to the monitor and secure it in using the provided screws and screwdriver.

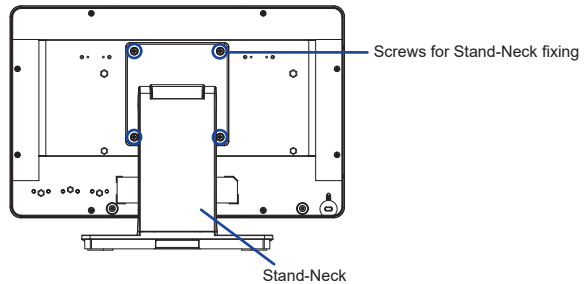

- ③ Use the 'thumb screw' provided to secure the Stand-base to the Stand-Neck.

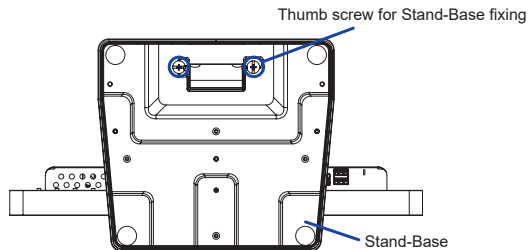

<Removal>

- ① Put a piece of soft cloth on the table beforehand to prevent the monitor from being scratched. Lay the monitor flat on a table with front face down.
- ② Loosen the 'thumb screw' to remove the Stand-Base from the Stand-Neck.
- ③ Loosen the screws with the provided screwdriver to remove the Stand-Neck from the monitor.

CONTROLS AND CONNECTORS

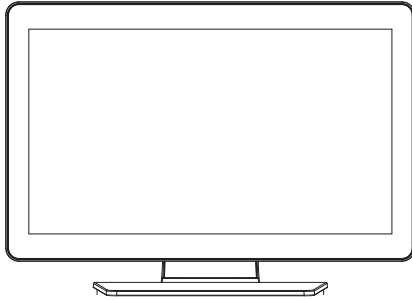

<Front>

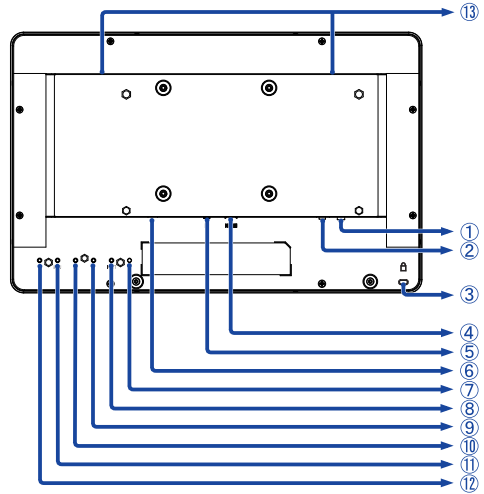

<Back>

① USB Downstream Connector (USB : 5V, 500mA)

② USB Upstream Connector (USB)

③ Keyhole for Security Lock

NOTE You can fasten a security lock and cable to prevent the monitor from being removed without your permission.

④ HDMI Connector (HDMI)

⑤ DisplayPort Connector (DP)

⑥ Connector for AC Adapter (⎓ : Direct current, DC-IN)

⑦ Power Indicator

NOTE Green: Normal operation
Orange: Standby Mode

⑧ Input Select Button (INPUT) *¹

⑨ - / Volume Button (-) *¹

⑩ + / Volume Button (+) *¹

⑪ Menu Button (MENU)

⑫ Power Button (⏻)

⑬ Speakers

*¹ You can skip the Menu items and directly display an option setting screen.

*² With stand: ProLite T1633MSC, Without stand: ProLite TF1633MSC

CONNECTING YOUR MONITOR

- ① Ensure that both the computer and the monitor are switched off.
- ② Connect the computer to the monitor with the signal cable.
- ③ Connect the computer to the monitor with the USB Cable.
- ④ Connect the HDMI cable to the monitor and the AV equipment when using an AV equipment compliant to HDMI connection.
- ⑤ Connect the AC Adapter to the monitor. Connect the Power Cable to the AC Adapter first and then to the power source.
- ⑥ Turn on your monitor and computer.

- NOTE**
- Make sure that the building installation has a circuit breaker of 120/240V, 20A (maximum).
 - The signal cables used for connecting the computer and monitor may vary with the type of computer used. An incorrect connection may cause serious damage to both the monitor and the computer. The cable supplied with the monitor is for a standard connector. If a special cable is required please contact your local iiyama dealer or regional iiyama office.
 - Make sure you tighten the finger screws at each end of the Signal Cable.
 - The Class I pluggable equipment Type A must be connected to protective earth.
 - The socket-outlet shall be installed near the equipment and shall be easily accessible.

[Example of Connection]

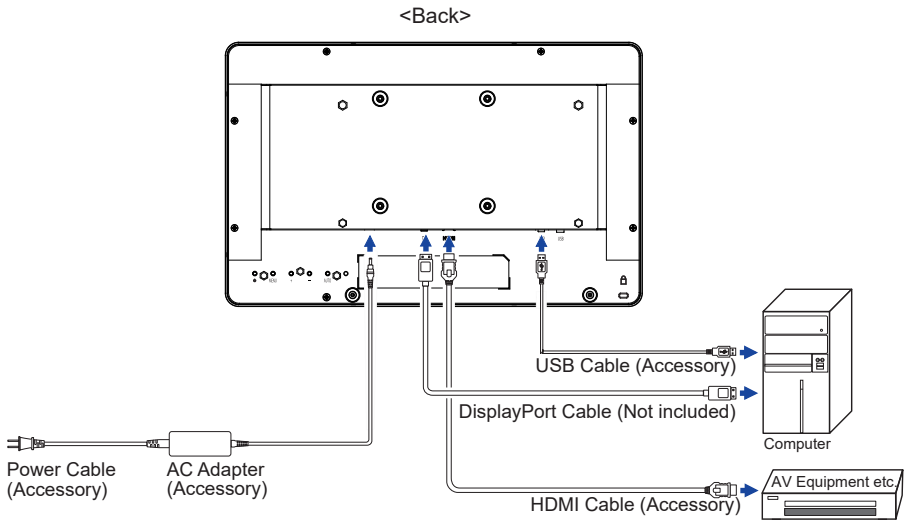

FITTING OF CABLE COVER : ProLite T1633MSC

Put a piece of soft cloth on the table beforehand to prevent the monitor from being scratched. Lay the monitor flat on a table with front face down.

- ① As shown in Step1, connect the cables and put those through the cable hole. Removing the stand-neck's cable cover makes it easier to pass through.

Step1

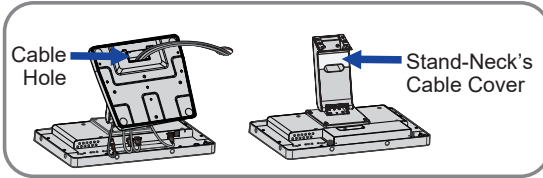

- ② As shown in Step 2, place the cable cover and fix it firmly with the hand screws.

Step2

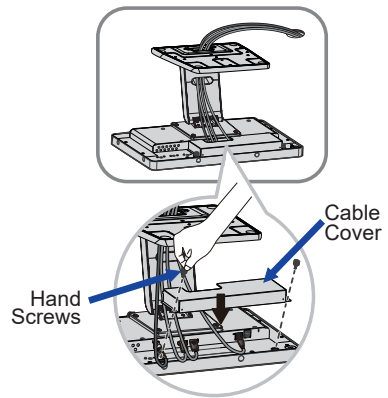

ADJUSTING THE VIEWING ANGLE : ProLite T1633MSC / ProLite TF1633MSC

- For optimal viewing it is recommended to look at the full face of the monitor.
- Hold the panel so that the monitor does not topple when you change the monitor's angle.
- You are able to adjust the monitor's angle up to 90 degrees upward, 5 degrees downward.

- NOTE**
- Do not touch the LCD screen when you change the angle. It may cause damage or break the LCD screen.
 - Careful attention is required not to pinch your fingers or hands into the moving part of the stand when you change the angle.
 - Without stand: ProLite TF1633MSC

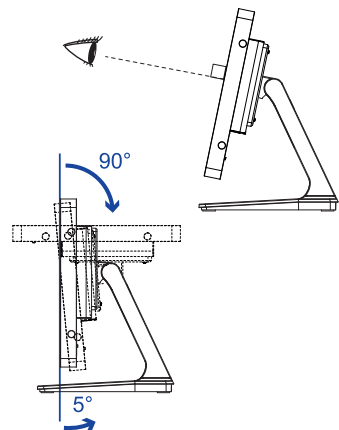

COMPUTER SETTING

■ Signal Timing

Change to the desired signal timing listed on page 24: COMPLIANT TIMING.

■ Procedure for turning ON the Power Button

Turn ON the monitor first, and then the computer.

■ Touch method

Fingers, Conductive stylus

NOTE If you would like to use conductive stylus, please select 8mm diameter conductive stylus. However, we cannot guarantee all 8mm diameter stylus work on our touch monitor.

■ TOUCH support operation system

	Mouse	Digitizer	Gestures*
Windows8/8.1/10/11	○	○	○
Mac OS/OS X	×	×	×
Linux	×	×	×
Android	×	×	×
Functions	Click Drag Double-Click	Mouse function Right-Click Flick Visual feedback	Mouse & Digitizer functions Press & Tap, Rotate, Zoom-in/out

The other OS Versions not listed are not supported.

○ : Supported × : Not supported

* Gestures can be supported by application programs.

■ Touch Input Settings in Dual Screen Mode

- ① Connect the primary monitor to the computer first.
 Set Control Panel > Hardware and Sound > Tablet PC Settings > Display > Setup.

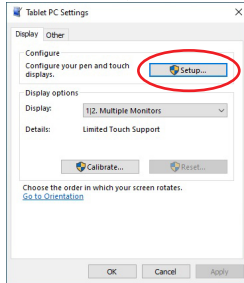
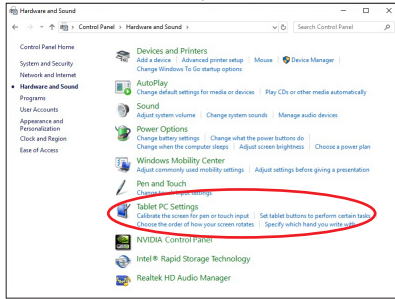
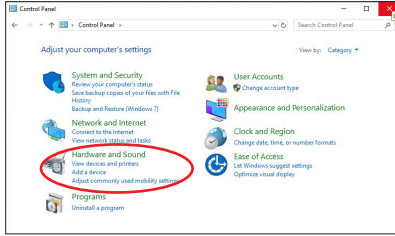

The following message will appear on the screen. Please follow the instructions.

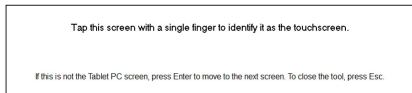

- ② After setting ①, connect a second monitor and perform the setup as in ①.

NOTE The monitors are recognized as dual-display, and touch operation cannot be performed on two monitors at the same time.
 You can perform touch operation on only one of the monitors.

OPERATING THE MONITOR

To create the best picture, your iiyama LCD monitor has been preset at the factory with the COMPLIANT TIMING shown on page 24. You are also able to adjust the picture by following the button operation shown below.

- ① Press the MENU Button to start the On Screen Display feature. There are additional Menu items which can be switched by using the + / – Buttons.

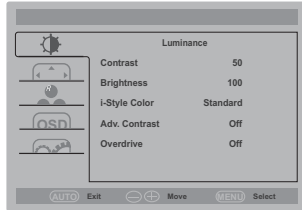

- ② Select the Menu item which contains the adjustment icon relating to the adjustment you want to make. Press the MENU Button. Then, use the + / – Buttons to highlight the desired adjustment icon.
- ③ Press the MENU Button again. Use the + / – Buttons to make the appropriate adjustment or setting.
- ④ Press the INPUT Button to leave the menu, and the settings you just made would be automatically saved.

For example, to correct for OSD vertical position, select Menu item of Image OSD Setup and then press the MENU Button. Then, select V. Position by using the + / – Buttons.

An adjustment page appears after you press the MENU Button. Then, use the + / – Buttons to change the OSD vertical position settings. The OSD vertical position of the overall display should be changing accordingly while you are doing this.

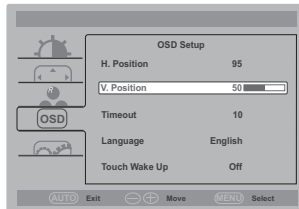

Press the INPUT Button lastly and all changes are saved in the memory.









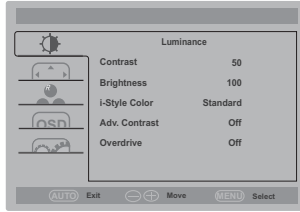



NOTE

- When button operations are aborted during adjustment, On-Screen Display disappears when the time set for the OSD Timeout has passed. Also, the INPUT Button can be used to return previous menu and turn off the On-Screen Display.
- Any changes are automatically saved in the memory when the On Screen Display disappears. Turning off the power should be avoided while using the Menu.
- All adjustments have only one setting which applies to all signal timings.

ADJUSTMENT MENU CONTENTS

Luminance



Adjustment Item	Problem / Option	Button to Press
Contrast	Too dull	 
	Too intense	  
Brightness * ¹	Too dark	 
	Too bright	  
i-Style Color * ²	Standard	For general windows environment and monitor default setting.
	Text	For text editing and viewing in a word processing environment.
	Internet	For internet environment.
	Game	For PC game environment.
	Movie	For movie and video environment.
	Sports	For sport environment.
Adv. Contrast	Off	Typical Contrast Ratio
	On	Increased Contrast Ratio
<p>NOTE Adv. Contrast adjusts brightness according to the image, and improve the contrast ratio during movie playing. Contrast, Brightness, Color Temp., Eco, i-Style Color and Blue Light Reducer cannot be adjusted and selected while Adv. Contrast is active.</p>		
Overdrive * ³	Off / 1 / 2 / 3 / 4 / 5 It will improve the gray level response time of the LCD panel. A higher level results in a faster response time.	  



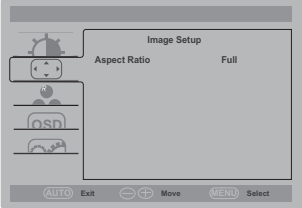

*¹ Adjust the Brightness when you are using the monitor in a dark room and feel the screen is too bright. Brightness adjustment is disabled when Eco is activated.

*² i-Style Color cannot be adjusted and selected while Blue Light Reducer is active.

*³ When Overdrive is activated, some level of image retention will be caused.

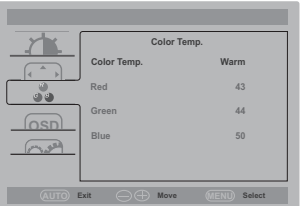
 Image Setup				
Adjustment Item		Problem / Option		Button to Press
Aspect Ratio *	Full	Expanded display		
	Aspect	Expanded display by Aspect ratio		

* Enabled when the resolution is 1680x1050 or less.

 Color Temp. *					
Adjustment Item		Problem / Option		Button to Press	
Color Temp.		Cool			
		Normal			
		Warm			
		User	Red	Too weak Too strong	   
			Green		
		Blue			

* Color Temp. cannot be adjusted and selected while Blue Light Reducer is active.

OSD OSD Setup

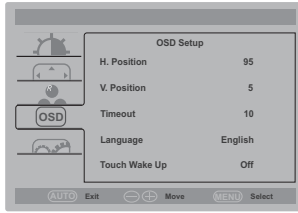

Adjustment Item	Problem / Option				Button to Press
H. Position	OSD is too left OSD is too right				+ -
V. Position	OSD is too low OSD is too high				+ -
Timeout	You can set the OSD display duration time between 5 and 100 seconds.				+ -
Language	English	English	Italiano	Italian	
	Français	French	Čeština	Czech	
	Español	Spanish	Nederlands	Dutch	
	Português	Portuguese	Polski	Polish	
	Русский	Russian	日本語	Japanese	
Touch Wake Up	Off	Touch Wake Up is turned off.			
	On	Touch and USB hub are still functional during the display stand by.			

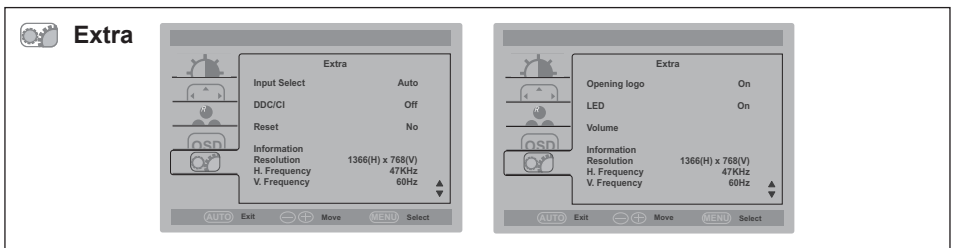

Adjustment Item	Problem / Option	
Input Select Direct	Auto	Select the signal input automatically.
	HDMI	Select the Digital (HDMI) input.
	DP	Select the Digital (DisplayPort) input.
DDC/CI	Off	DDC/CI is Off.
	On	DDC/CI is On.
Reset	Yes	Factory-preset data is restored.
	No	Return to Menu.
Opening Logo	Off	iiyama Logo does not display when the monitor is turned on.
	On	iiyama Logo displayed when the monitor is turned on.
LED	Off	The Power Indicator is turned Off.
	On	The Power Indicator is turned On.
NOTE Turn Off the Power Indicator when you are bothered by the light.		
Volume Direct	Too soft Too loud	
Information	Displays information regarding the current input signal coming from the graphic card in your computer. NOTE See your graphic card user guide for more information about changing the resolution and refresh.	

Direct

You can skip the Menu items and directly display an option setting screen by using the following button operations.

- Input Select: Press the INPUT Button when the Menu is not displayed.
- Volume: Press the + / – Button when the Menu is not displayed.

Direct

You can skip the Menu items and directly display an option setting screen or an adjustment scale by using the following button operations.

- Eco * : Pressing and holding of the – Button for about 3 seconds when the Menu is not displayed.
Off : Normal
Mode1 : Brightness of back-light is reduced.
Mode2 : Brightness of back-light is reduced more than 1.
Mode3 : Brightness of back-light is reduced more than 2.
- * Eco is disabled when i-Style Color or Adv. Contrast is activated.

- Blue Light Reducer * : Pressing and holding of the + Button for about 3 seconds when the Menu is not displayed.
Off : Normal
Mode1 : Blue light is reduced.
Mode2 : Blue light is reduced more than Mode1.
Mode3 : Blue light is reduced more than Mode2.
- * Blue Light Reducer is disabled when i-Style Color is activated.

- Lock Mode:

<OSD>

Hold the MENU Button and turn on the monitor when the monitor is power-off, it will lock/unlock the OSD.

<Power / OSD>

Keep pressing the MENU Button for 10 seconds when Menu is not displayed, it will lock/unlock the Power Button / OSD.

STANDBY FEATURE

This product features the standby function. When activated, it automatically reduces unnecessary power consumption of the monitor when your computer is not in use.

There is a standby step the monitor takes as described below. The standby function, including any timer settings is configured by the operating system. Check your operating system manual for information on how this can be configured.

■ Standby Mode

When the video signal from the computer is off, the monitor enters into Standby Mode which reduces the power consumption to less than 0.5W(1.5W)*. The screen becomes dark, and the power indicator turns to orange. From Standby Mode, the image reappears in several seconds when either the keyboard or the mouse are touched again.

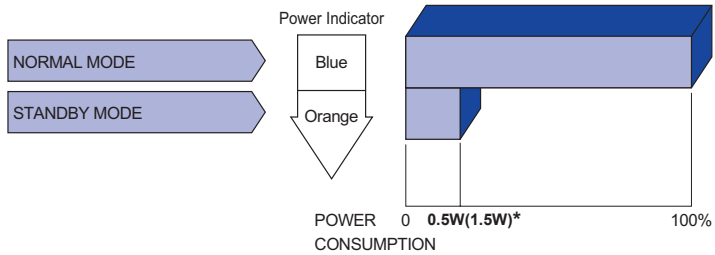

* 0.5W: When the USB devices are not connected.

1.5W: When the USB devices are connected.

TROUBLE SHOOTING

If the monitor fails to operate correctly, please follow the steps below for a possible solution.

1. Perform the adjustments described in OPERATING THE MONITOR, depending on the problem you have. If the monitor does not get a picture, skip to 2.
2. Consult the following items if you cannot find an appropriate adjustment item in OPERATING THE MONITOR or if the problem persists.
3. If you are experiencing a problem which is not described below or you cannot correct the problem, discontinue using the monitor and contact your dealer or iiyama service center for further assistance.

Problem

Check

- | | |
|--|--|
| ① The picture does not appear.
(Power indicator does not light up.) | <input type="checkbox"/> The AC Adapter is firmly seated in the connector.
<input type="checkbox"/> The Power Cable is firmly seated in the socket of the AC Adapter.
<input type="checkbox"/> The Power Cable is firmly seated in the socket.
<input type="checkbox"/> The Power Button is turned ON.
<input type="checkbox"/> The AC socket is live. Please check with another piece of equipment. |
| (Power indicator is green.) | <input type="checkbox"/> If the blank screen saver is in active mode, touch the keyboard or the mouse.
<input type="checkbox"/> Increase the Contrast and/or Brightness.
<input type="checkbox"/> The computer is ON.
<input type="checkbox"/> The Signal Cable is properly connected.
<input type="checkbox"/> The signal timing of the computer is within the specification of the monitor. |
| (Power indicator is orange.) | <input type="checkbox"/> If the monitor is in standby mode, touch the keyboard or the mouse.
<input type="checkbox"/> The computer is ON.
<input type="checkbox"/> The Signal Cable is properly connected.
<input type="checkbox"/> The signal timing of the computer is within the specification of the monitor. |
| ② The screen is not synchronized. | <input type="checkbox"/> The Signal Cable is properly connected.
<input type="checkbox"/> The signal timing of the computer is within the specification of the monitor. |
| ③ The screen position is not in the center. | <input type="checkbox"/> The signal timing of the computer is within the specification of the monitor. |
| ④ The screen is too bright or too dark. | <input type="checkbox"/> The video output level of the computer is within the specification of the monitor. |
| ⑤ The screen is shaking. | <input type="checkbox"/> The power voltage is within the specification of the monitor.
<input type="checkbox"/> The signal timing of the computer is within the specification of the monitor. |
| ⑥ The touch screen shows no response. | <input type="checkbox"/> The USB Cable is firmly seated in the socket.
<input type="checkbox"/> Touch screen driver software is installed. |
| ⑦ The touch position does not deviate. | <input type="checkbox"/> The calibration function set up correctly. |

RECYCLING INFORMATION

For better environment protection please don't dispose your monitor.
Please visit our web site: <https://iiyama.com> for monitor recycling.

APPENDIX

Design and specifications are subject to change without prior notice.

SPECIFICATIONS : ProLite T1633MSC-B1

Touch Screen	Technology	Projected capacitive 10pt touch
	Light transmission	85%
	Communication system	USB
Size Category		15.6"
LCD Panel	Panel technology	IPS (In-Plane-Switching)
	Size	Diagonal: 15.6" (39.5cm)
	Pixel pitch	0.179mm H × 0.179mm V
	Brightness	450cd/m ² (Typical), 385cd/m ² (with Touch panel), 155cd/m ² (Default / Energy Saving)
	Contrast ratio	1000 : 1 (Typical)
	Viewable angle	Horizontal : 178 degrees, Vertical: 178 degrees (Typical)
	Response time	5ms (Gray to Gray, by Overdrive)
Display Colors		Approx. 16.7M
Sync Frequency		Horizontal: 30.0-68.0kHz, Vertical: 60Hz
Native Resolution		1920 × 1080, 2.1 MegaPixels
Support max. resolution		1920 × 1080 60Hz
Input Connector		HDMI, DisplayPort
USB Standard		USB2.0 (DC5V, 500mA)
Input Video Signal		HDMI, DisplayPort
Speakers		2W × 2 (Stereo speakers)
Maximum Screen Size		344.2mm W × 193.6mm H / 13.6" W × 7.6" H
Power Source		12VDC, 3.75A
AC Adapter (accessory)		Input: 100-240VAC, 50-60Hz
Power Consumption* ¹		12W typical, 8W (Default / Energy Saving), Standby mode: 0.5W(1.5W) maximum* ³ , Off mode: 0.3W maximum
Dimensions / Net Weight		389.0 × 284.0 × 200.0mm / 15.3 × 11.2 × 7.9" (W×H×D) 3.4kg / 7.5lbs (Excluding the AC Adapter)
Tilt Angle		Upward: 90 degrees Downward: 5 degrees
Environmental Considerations		Operating: Temperature 0 to 40°C / 32 to 104°F Humidity 20 to 80% (No condensation) Storage: Temperature -20 to 60°C / -4 to 140°F Humidity 10 to 90% (No condensation)
Approvals		CE, UKCA, TÜV-Bauart, EAC, IP54* ²

NOTE *¹ When the USB devices are not connected.

*² IP54 Standard Compliant : Only front face

*³ 0.5W: When the USB devices are not connected.

1.5W: When the USB devices are connected.

SPECIFICATIONS : ProLite TF1633MSC-B1

Touch Screen	Technology	Projected capacitive 10pt touch
	Light transmission	85%
	Communication system	USB
Size Category		15.6"
LCD Panel	Panel technology	IPS (In-Plane-Switching)
	Size	Diagonal: 15.6" (39.5cm)
	Pixel pitch	0.179mm H × 0.179mm V
	Brightness	450cd/m ² (Typical), 385cd/m ² (with Touch panel), 155cd/m ² (Default / Energy Saving)
	Contrast ratio	1000 : 1 (Typical)
	Viewable angle	Horizontal : 178 degrees, Vertical: 178 degrees (Typical)
	Response time	5ms (Gray to Gray, by Overdrive)
Display Colors		Approx. 16.7M
Sync Frequency		Horizontal: 30.0-68.0kHz, Vertical: 60Hz
Native Resolution		1920 × 1080, 2.1 MegaPixels
Support max. resolution		1920 × 1080 60Hz
Input Connector		HDMI, DisplayPort
USB Standard		USB2.0 (DC5V, 500mA)
Input Video Signal		HDMI, DisplayPort
Speakers		2W × 2 (Stereo speakers)
Maximum Screen Size		344.2mm W × 193.6mm H / 13.6" W × 7.6" H
Power Source		12VDC, 3.75A
AC Adapter (accessory)		Input: 100-240VAC, 50-60Hz
Power Consumption* ¹		12W typical, 8W (Default / Energy Saving), Standby mode: 0.5W(1.5W) maximum* ³ , Off mode: 0.3W maximum
Dimensions / Net Weight		389.0 × 246.5 × 45.5mm / 15.3 × 9.7 × 1.8" (W×H×D) 2.0kg / 4.4lbs (Excluding the AC Adapter)
Usable angle		Upward: 90 degrees Downward: 5 degrees
Environmental Considerations		Operating: Temperature 0 to 40°C / 32 to 104°F Humidity 20 to 80% (No condensation) Storage: Temperature -20 to 60°C / -4 to 140°F Humidity 10 to 90% (No condensation)
Approvals		CE, UKCA, TÜV-Bauart, EAC, IP54* ²

NOTE

*¹ When the USB devices are not connected.

*² IP54 Standard Compliant : Only front face

*³ 0.5W: When the USB devices are not connected.

1.5W: When the USB devices are connected.

DIMENSIONS : ProLite T1633MSC

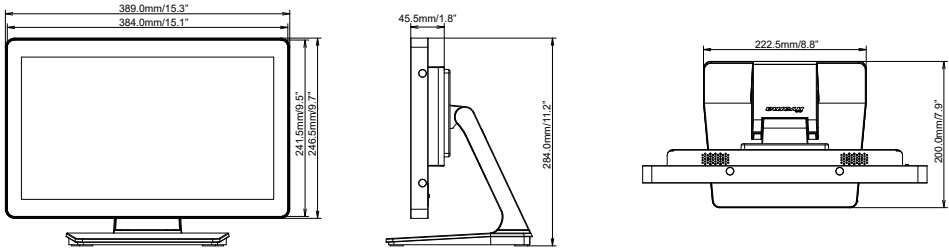

DIMENSIONS : ProLite TF1633MSC

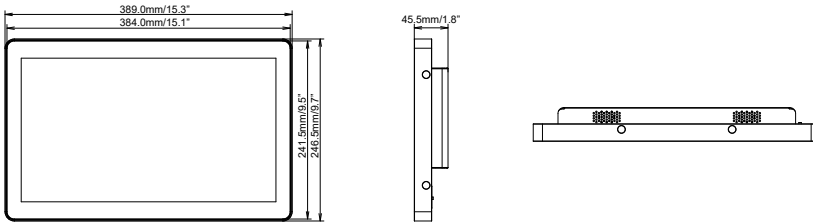

COMPLIANT TIMING

Video Mode	Horizontal Frequency	Vertical Frequency	Dot Clock
640 × 480	31.469kHz	59.940Hz	25.175MHz
800 × 600	37.879kHz	60.317Hz	40.000MHz
1024 × 768	48.363kHz	60.004Hz	65.000MHz
1280 × 1024	63.981kHz	60.020Hz	108.000MHz
1680 × 1050	65.290kHz	60.000Hz	146.250MHz
1920 × 1080	67.500kHz	60.000Hz	148.500MHz