



User Guide

Outdoor Security Wi-Fi Camera

Contents

| | |
|--|----|
| About This Guide | 1 |
| Introduction | 2 |
| Appearance | 3 |
| Set Up Your Camera | 5 |
| Set Up Using Amazon Frustration-Free Setup | 7 |
| Install a microSD Card | 11 |
| Mount Your Camera | 12 |
| Install Waterproof Items | 13 |
| How to Reset Your Camera | 14 |
| Authentication | 15 |

About This Guide

This guide provides a brief introduction to the Outdoor Security Wi-Fi Camera and the Tapo app, as well as regulatory information.

Please note that features available in Tapo may vary by model and software version. Tapo availability may also vary by region. All images, steps, and descriptions in this guide are only examples and may not reflect your actual Tapo Camera experience.

Conventions

In this guide, the following convention is used:

| Convention | Description |
|------------------|--|
| Blue | Key information appears in blue, including management page text such as menus, items, buttons and so on. |
| <u>Underline</u> | Hyperlinks are in blue and underlined. You can click to redirect to a website. |
| ■ Note: | Ignoring this type of note might result in a malfunction or damage to the device. |

More Info

- Specifications can be found on the product page at <https://www.tapo.com>.
- Our Technical Support and troubleshooting information can be found at <https://www.tapo.com/support/>.
- The setup video and waterproof cable attachments video can be found at <https://www.tp-link.com/support/setup-video/>.

Introduction

Tapo C310 is a full-featured weatherproof security camera that you can access from anywhere. Receive instant notifications when a person or motion is detected to keep an eye on vital areas. The sound alarm will also trigger automatically to frighten away unwanted visitors. Day or night, rain or shine, the Tapo camera protects what you love most.

- **2K Resolution** – Reveals clearer images and more details than 1080p.
- **IP66 Weatherproof** – Helps Tapo C310 perform well even in harsh environments with rain and dust.
- **Dual Powerful Antennas** – Provides wider Wi-Fi coverage and more stable wireless connection with dual external antennas.
- **Night Vision(Up to 98 ft)** – Provides a visual distance of up to 98 ft (30 m) even in total darkness to always keep you safe.
- **Activity Zones** – Set up activity zones to only receive alerts that matter.
- **Sound Alarm** – Triggers sound effects to frighten away unwanted visitors.
- **Local microSD Storage (Up to 512GB)* and Cloud Storage**** – Save recorded videos to an installed microSD card (up to 512 GB) or by using Tapo Care** cloud storage service.

*microSD card must be purchased separately.

**Subscribe for cloud storage at <https://www.tapo.com/tapocare/>

- **Wired/Wireless Networking** – Connect the camera to your network through Ethernet or Wi-Fi for more flexible installation.
- **Two-Way Audio** – Communicate remotely with a delivery person in real time.

Appearance

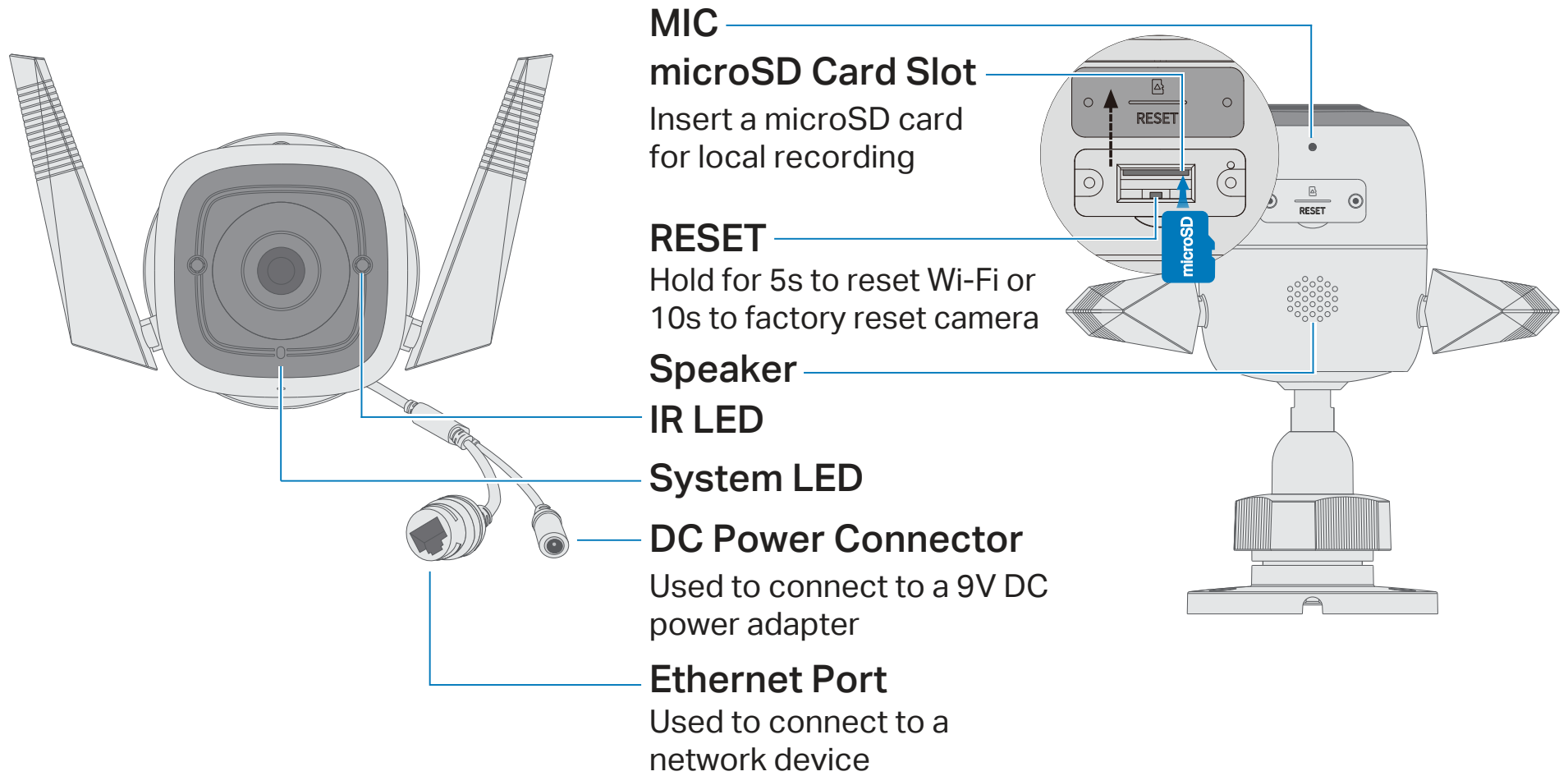

System LED Indication

| | |
|--|--|
| Solid red | Starting up |
| Blinking red and green (for Wi-Fi setup) | Ready for setup |
| Blinking red slowly (for Wi-Fi setup) | Connecting to Wi-Fi |
| Solid amber | Connected to Wi-Fi or wired network |
| Solid green | Connected to the cloud |
| Blinking red quickly | Camera resetting |
| Blinking green quickly | Camera updating |

Set Up Your Camera

Follow the steps below to get started with your new camera.

Step 1. Download Tapo App

Get the [Tapo](#) app from the App Store or Google Play, or by scanning the QR code below.



OR

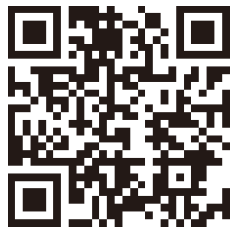

Step 2. Log In

Open the app, and log in with your TP-Link ID. If you don't have an account, create one first.

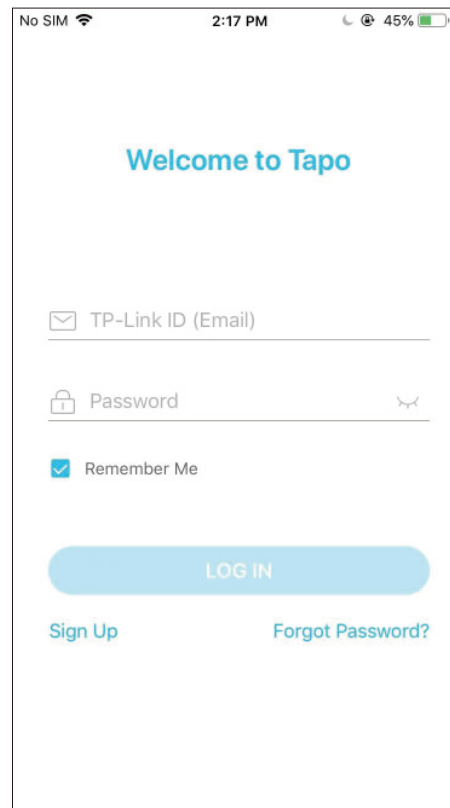

Step 3. Add Your Camera

Tap the  button in the app and select your model.

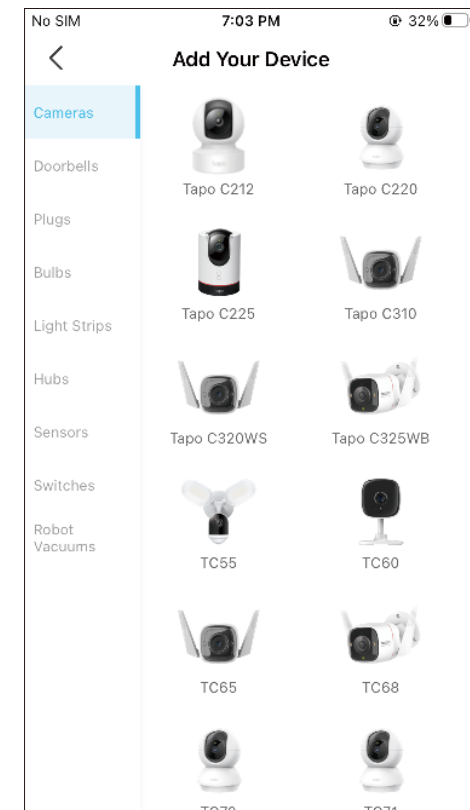

Step 4. Configure Camera

Follow app instructions to set up your camera via wired or wireless connection (for setup only), and add it to your home network. After setup, you can use your camera via wired connection or wirelessly.

■ **Note:** For Wireless setup, if your camera is connected to your router via an Ethernet cable, please unplug the cable first.

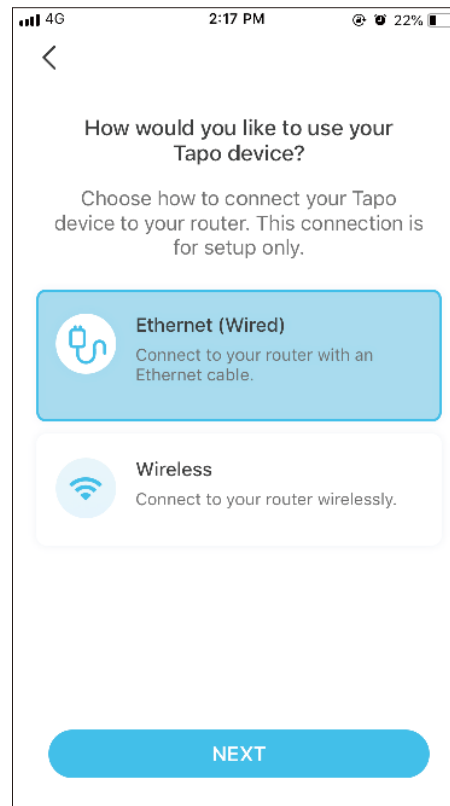

Set Up Using Amazon Frustration-Free Setup

What is Amazon Frustration-Free Setup?

Amazon Frustration-Free Setup can help connect and set up Tapo smart devices in fewer steps, without having to remember and re-enter your Wi-Fi password on each device.

To use this feature, confirm the following:

- The new Tapo device supports Amazon FFS.
- The new Tapo device is purchased from Amazon.
- You have an Amazon FFS enabled Alexa device or router.
- You have saved your Wi-Fi information to Amazon by using Alexa echo.
- Your Tapo device and router are on the same network as your Alexa echo.

LED Indications during Amazon Frustration-Free Setup

| LED | Status |
|------------------------|-----------------------|
| Blinking red and green | Ready for setup |
| Blinking amber | FFS setup in progress |
| Solid green | Working properly |

If the LED does not turn solid green after a long time, you can try to add the Tapo device manually. (Press the Reset button on your Tapo device once. Then open the Tapo app, tap the + button on the page, select your device model, and follow the app instructions.)

How to use Amazon Frustration-Free Setup with Tapo devices

1. Open the Amazon Alexa app. Then tap **More** and select **Skills & Games**.

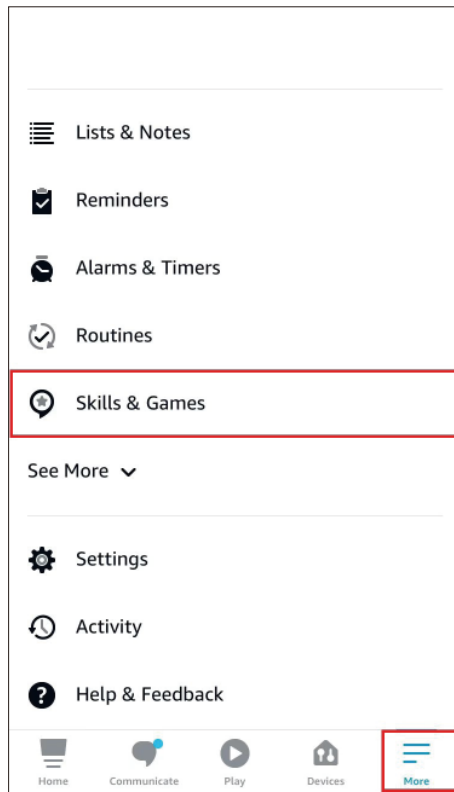

2. Enter **Tapo** in the search bar and choose **Tapo**.

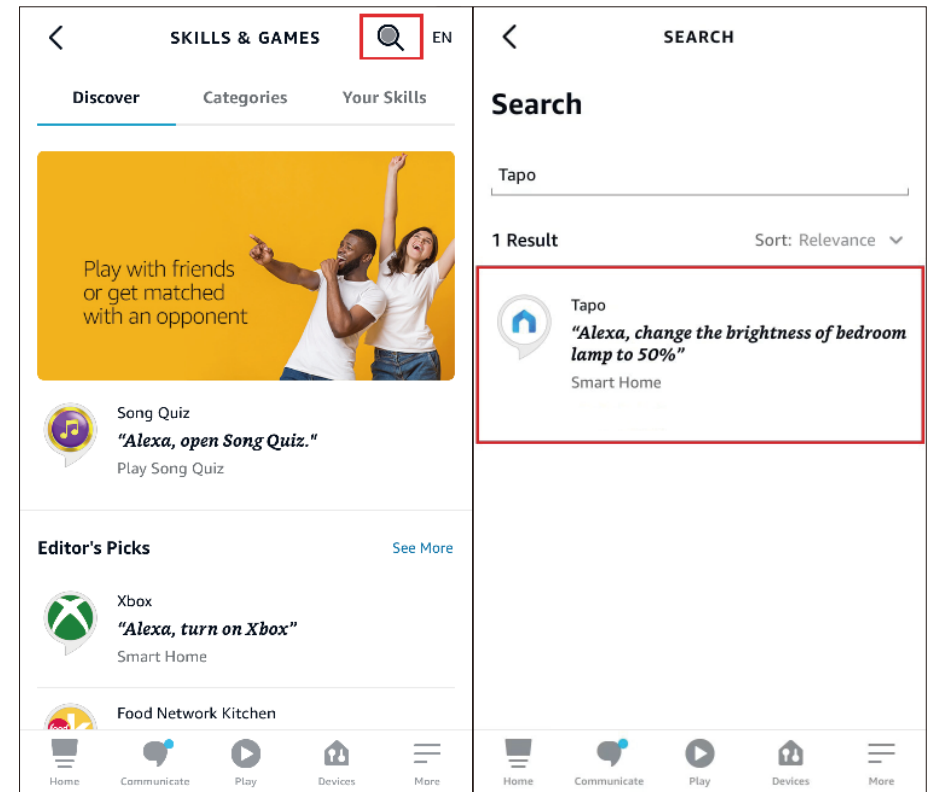

3. Tap the **ENABLE TO USE** button.

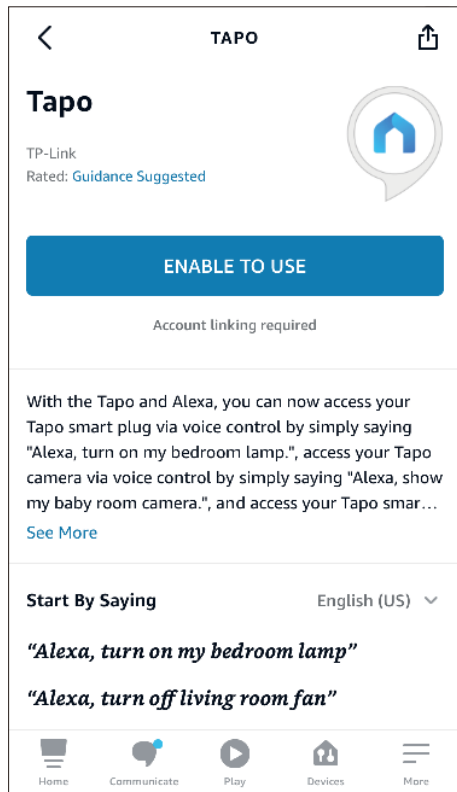

4. Log in with your TP-Link ID that has bound to your Tapo device, and tap **Authorize**. After authorized successfully, the message **Tapo has been successfully linked** will come up.

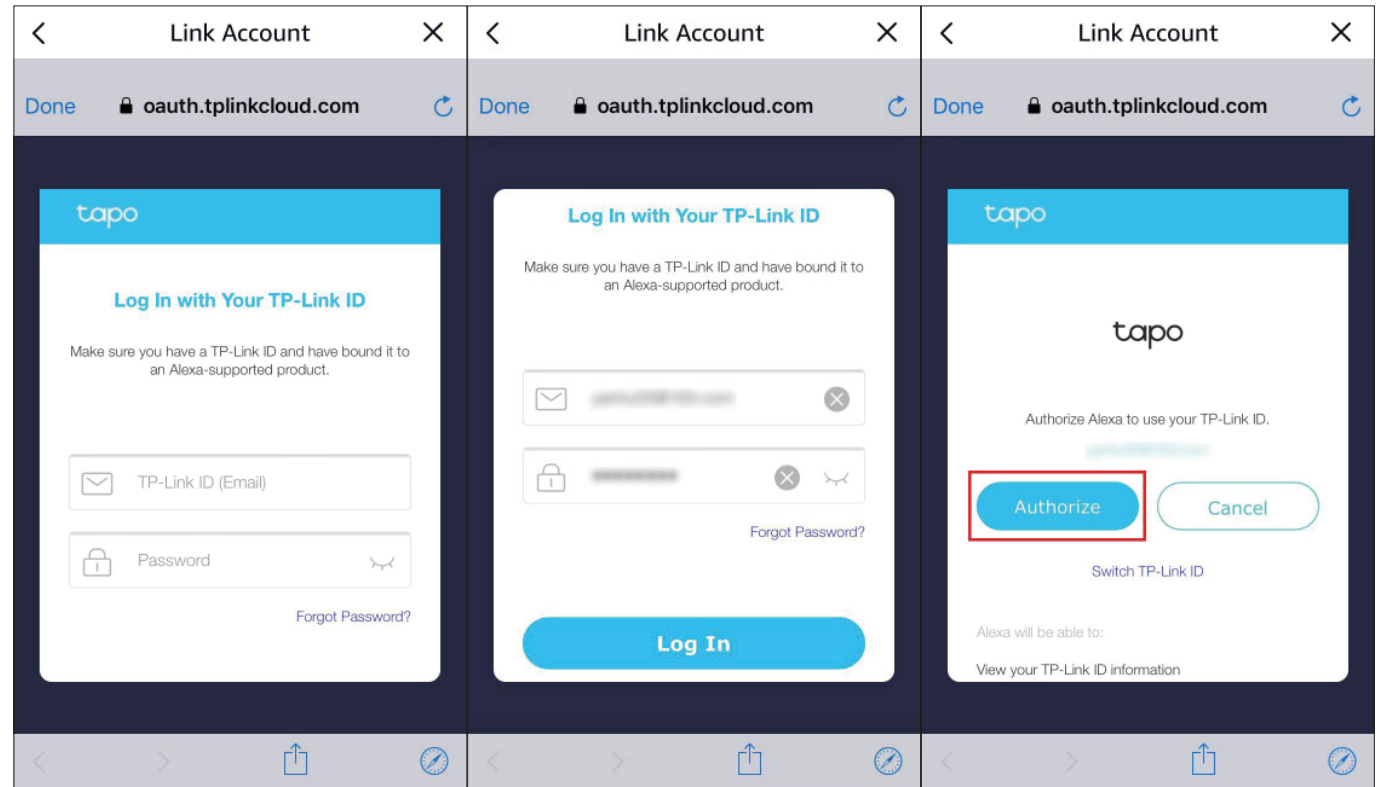

5. Plug in your Tapo device and the setup will complete automatically in two minutes.

For setting up more Tapo devices, just plug in and enjoy!

Done!

If this device displays on the Home page in the Tapo app, it indicates this device has been successfully associated with your Amazon account and joined your Wi-Fi network automatically.

If this device does not display on the Home page in the Tapo app, try setting it up manually. (Tap the + button on the page, select your device model, and then follow the app instructions.)

Install a microSD Card

Follow the steps below to install the microSD card for local recording.

You can go to [Camera Settings](#) > [microSD Card](#) in the Tapo app to check the card status or format your card.

1. Loosen the screws on the bottom panel and remove the cover.
2. Identify the direction of the microSD card and carefully insert the card into the slot. Push in the card until you hear a clicking sound.

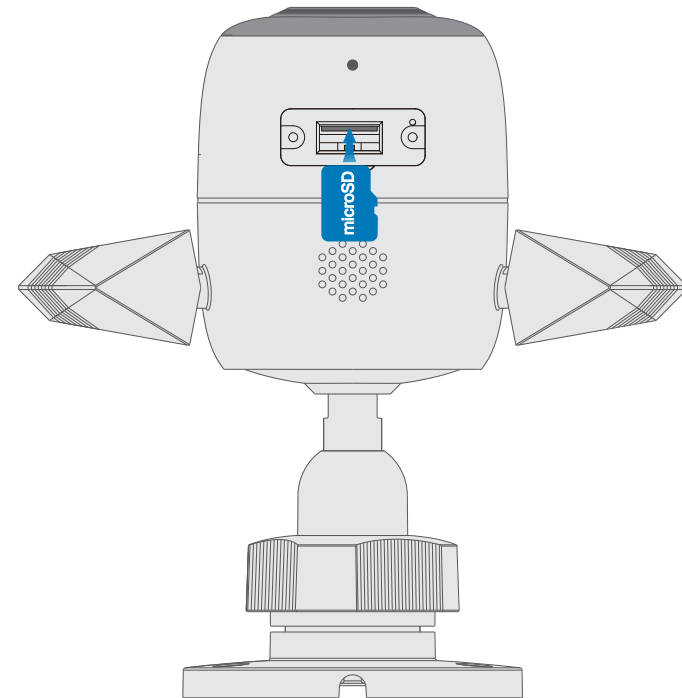
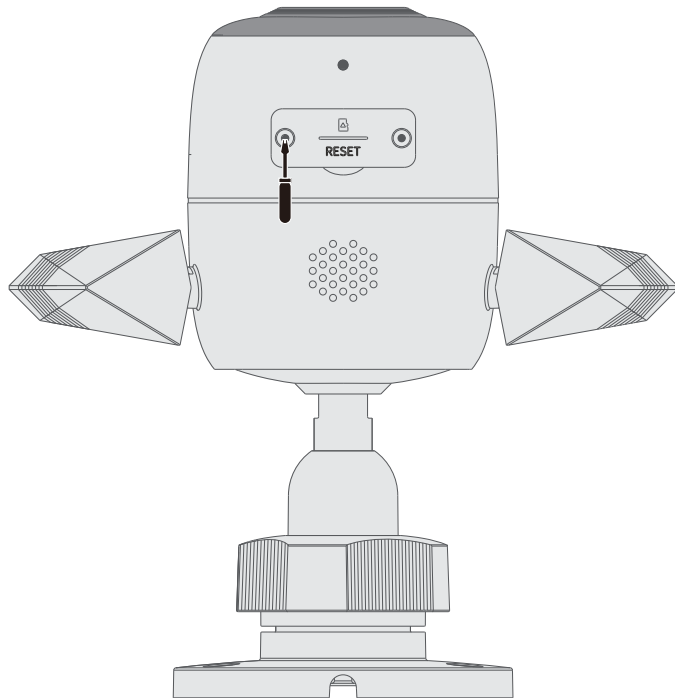

Mount Your Camera

When you finish adding your camera in the Tapo app, you can mount it on a wall with the provided mounting template and screws. Follow the steps below to mount your new camera.

■Note: Install the waterproof cable attachments for the network interface when the camera is installed outdoors.

1. Drill Holes

Stick the mounting template to the desired mounting place. Drill 3 screw holes according to the template.

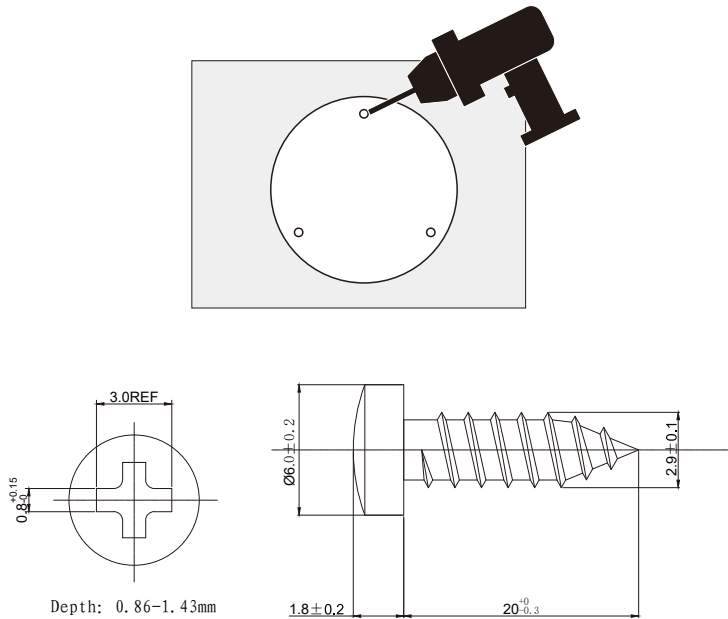

2. Mount Camera

Insert three anchors into the holes and use the screws to affix the camera over the anchors.

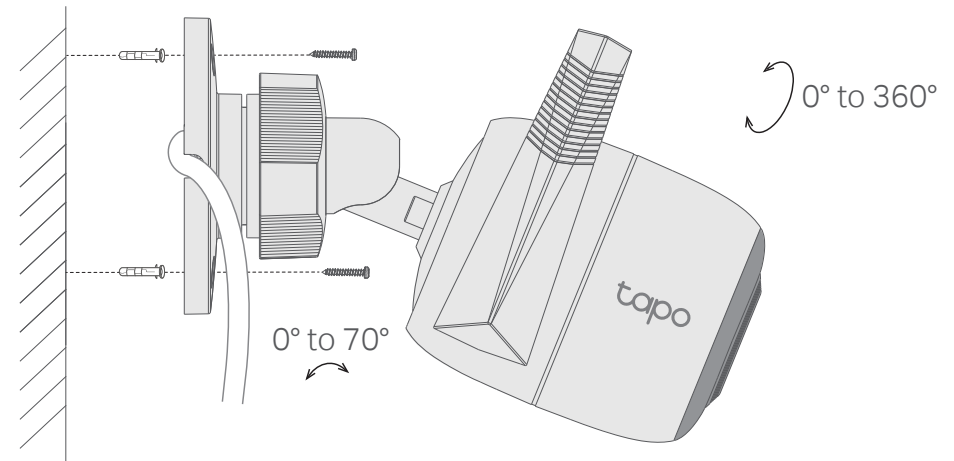

Note: After mounting the camera, remember to connect it to a power outlet using the provided power adapter.

Install Waterproof Items

When the camera is installed outdoors, please install waterproof items to waterproof your camera. Make sure each part is securely attached and the water-proofing rings are flush to keep out water.

Follow the steps below to install waterproof items.

Install Waterproof Seal for Power Connectors

Connect the camera to a power outlet using the provided power adapter. Install the waterproof seal for the power connectors when the camera is installed outdoors.

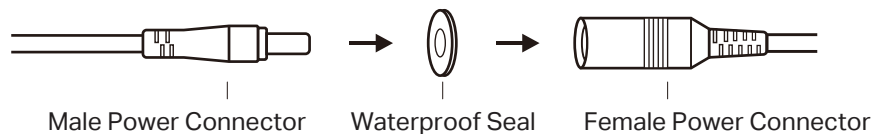

Install Waterproof Cable Attachments

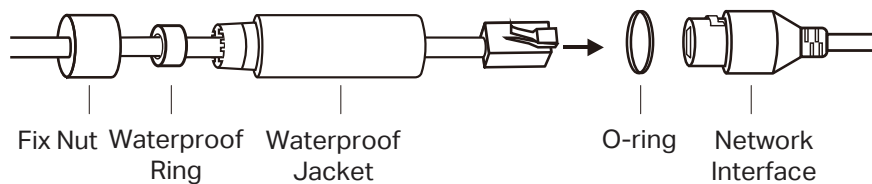

1. Route the network cable through the following components in order: fix nut, waterproof ring, and then the waterproof jacket.
2. Insert the waterproof ring into the waterproof jacket.
3. Fix the O-ring to the network interface of the camera and connect the network cables.
4. Attach the network interface with the waterproof jacket, then twist to lock. Rotate the fix nut to secure it to the waterproof jacket.

How to Reset Your Camera

Follow the steps below to reset your camera via the Reset button.

You can also go to [Camera Settings](#) in the Tapo app and tap [Remove Device](#) at the bottom to factory reset your camera.

1. Loosen the screws on the bottom panel and remove the cover.

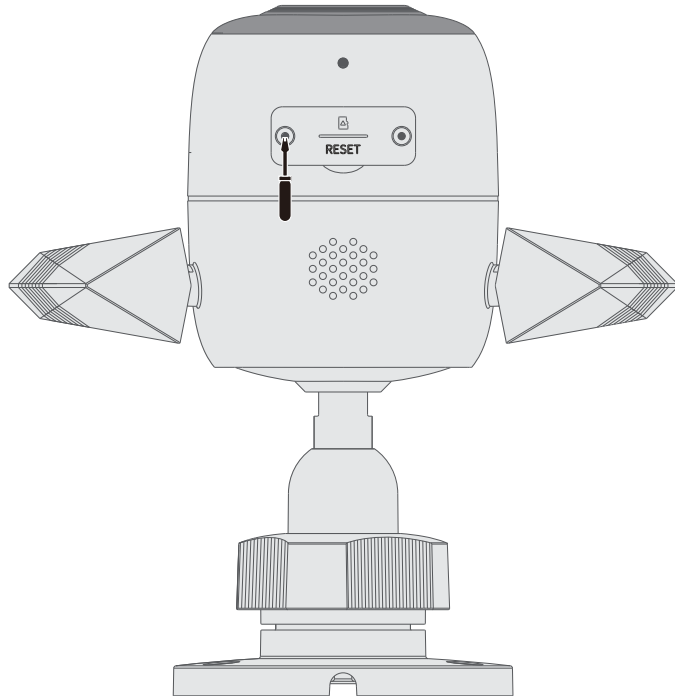

2. Press and hold the RESET button to reset the camera.

- Press and hold for 5s until the LED blinks red slowly: Reset Wi-Fi settings only
- Press and hold for 10s until the LED blinks red quickly: Reset to factory settings

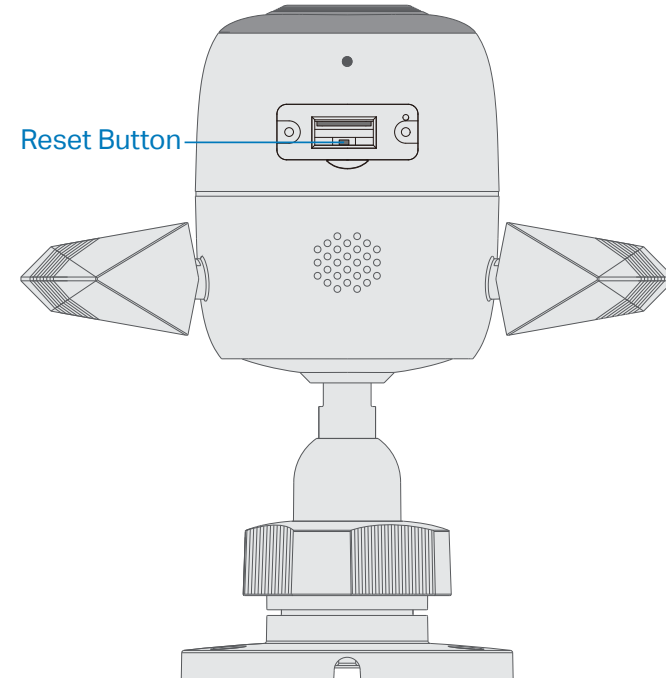

Authentication

FCC compliance information statement



Product Name: Outdoor Security Wi-Fi Camera

Model Number: Tapo C310/Tapo C310P2

| Component Name | Model |
|---------------------|-------------|
| I.T.E. Power Supply | T090060-2B1 |

Responsible Party:

TP-Link USA Corporation

Address: 10 Mauchly, Irvine, CA 92618

Website: <http://www.tp-link.com/us/>

Tel: +1 626 333 0234

Fax: +1 909 527 6804

E-mail: sales.usa@tp-link.com

This equipment has been tested and found to comply with the limits for a Class B digital device, pursuant to part 15 of the FCC Rules. These limits are designed to provide reasonable protection against harmful interference in a residential installation. This equipment generates, uses and can radiate radio frequency energy and, if not installed and used in accordance with the instructions, may cause harmful interference to radio communications. However, there is no guarantee that interference will not occur in a particular installation. If this equipment does cause harmful interference to radio or television reception, which can be determined by turning the equipment off and on, the user is encouraged to try to correct the interference by one or more of the following measures:

- Reorient or relocate the receiving antenna.
- Increase the separation between the equipment and receiver.
- Connect the equipment into an outlet on a circuit different from that to which the receiver is connected.
- Consult the dealer or an experienced radio/ TV technician for help.

This device complies with part 15 of the FCC Rules. Operation is subject to the following two conditions:

1. This device may not cause harmful interference.
2. This device must accept any interference received, including interference that may cause undesired operation.

Any changes or modifications not expressly approved by the party responsible for compliance could void the user's authority to operate the equipment.

Note: The manufacturer is not responsible for any radio or TV interference caused by unauthorized modifications to this equipment. Such modifications could void the user's authority to operate the equipment.

FCC RF Radiation Exposure Statement

This equipment complies with FCC RF radiation exposure limits set forth for an uncontrolled environment. This device and its antenna must not be co-located or operating in conjunction with any other antenna or transmitter.

"To comply with FCC RF exposure compliance requirements, this grant is applicable to only Mobile Configurations. The antennas used for this transmitter must be installed to provide a separation distance of at least 20 cm from all persons and must not be co-located or operating in conjunction with any other antenna or transmitter."

We, **TP-Link USA Corporation**, has determined that the equipment shown as above has been shown to comply with the applicable technical standards, FCC part 15. There is no unauthorized change is made in the equipment and the equipment is properly maintained and operated.

Issue Date: 2023-06-30

FCC compliance information statement

Product Name: I.T.E. Power Supply

Model Number: T090060-2B1

Responsible Party:

TP-Link USA Corporation

Address: 10 Mauchly, Irvine, CA 92618

Website: <http://www.tp-link.com/us/>

Tel: +1 626 333 0234

Fax: +1 909 527 6804

E-mail: sales.usa@tp-link.com

This equipment has been tested and found to comply with the limits for a Class B digital device, pursuant to part 15 of the FCC Rules. These limits are

designed to provide reasonable protection against harmful interference in a residential installation. This equipment generates, uses and can radiate radio frequency energy and, if not installed and used in accordance with the instructions, may cause harmful interference to radio communications. However, there is no guarantee that interference will not occur in a particular installation. If this equipment does cause harmful interference to radio or television reception, which can be determined by turning the equipment off and on, the user is encouraged to try to correct the interference by one or more of the following measures:

- Reorient or relocate the receiving antenna.
- Increase the separation between the equipment and receiver.
- Connect the equipment into an outlet on a circuit different from that to which the receiver is connected.
- Consult the dealer or an experienced radio/ TV technician for help.

This device complies with part 15 of the FCC Rules. Operation is subject to the following two conditions:

1. This device may not cause harmful interference.
2. This device must accept any interference received, including interference that may cause undesired operation.

Any changes or modifications not expressly approved by the party responsible for compliance could void the user's authority to operate the equipment.

We, **TP-Link USA Corporation**, has determined that the equipment shown as above has been shown to comply with the applicable technical standards, FCC part 15. There is no unauthorized change is made in the equipment and the equipment is properly maintained and operated.

Issue Date: 2023-06-30

CE Mark Warning



This is a class B product. In a domestic environment, this product may cause radio interference, in which case the user may be required to take adequate measures.

OPERATING FREQUENCY (the maximum transmitted power)

2412MHz—2472MHz (20dBm)

EU Declaration of Conformity

TP-Link hereby declares that the device is in compliance with the essential requirements and other relevant provisions of directives 2014/53/EU, 2009/125/EC, 2011/65/EU and (EU)2015/863.

The original EU Declaration of Conformity may be found at <https://www.tapo.com/en/support/ce/>.

RF Exposure Information

This device meets the EU requirements (2014/53/EU Article 3.1a) on the limitation of exposure of the general public to electromagnetic fields by way of health protection.

The device complies with RF specifications when the device used at 20 cm from your body.

UKCA Mark



UK Declaration of Conformity

TP-Link hereby declares that the device is in compliance with the essential requirements and other relevant provisions of the Radio Equipment Regulations 2017.

The original UK Declaration of Conformity may be found at <https://www.tapo.com/support/ukca/>.

Canadian Compliance Statement

This device contains licence-exempt transmitter(s)/receiver(s) that comply with Innovation, Science and Economic Development Canada's licence-exempt RSS(s). Operation is subject to the following two conditions:

1. This device may not cause interference.
2. This device must accept any interference, including interference that may cause undesired operation of the device.

L'émetteur/récepteur exempt de licence contenu dans le présent appareil est conforme aux CNR d'Innovation, Sciences et Développement économique Canada applicables aux appareils radio exempts de licence. L'exploitation est autorisée aux deux conditions suivantes :

1. l'appareil ne doit pas produire de brouillage;
2. l'utilisateur de l'appareil doit accepter tout brouillage radioélectrique subi, même si le brouillage est susceptible d'en compromettre le fonctionnement

Radiation Exposure Statement:

This equipment complies with IC radiation exposure limits set forth for an uncontrolled environment. This equipment should be installed and operated with minimum distance 20cm between the radiator & your body.

Déclaration d'exposition aux radiations:

Cet équipement est conforme aux limites d'exposition aux rayonnements IC établies pour un environnement non contrôlé. Cet équipement doit être installé et utilisé avec un minimum de 20 cm de distance entre la source de rayonnement et votre corps.

Industry Canada Statement

CAN ICES-3 (B)/NMB-3(B)



Korea Warning Statements:

당해 무선설비는 운용중 전파혼신 가능성이 있음.

NCC Notice & BSMI Notice

注意!

取得審驗證明之低功率射頻器材，非經核准，公司、商號或使用者均不得擅自變更頻率、加大功率或變更原設計之特性及功能。

低功率射頻器材之使用不得影響飛航安全及干擾合法通信；經發現有干擾現象時，應立即停用，並改善至無干擾時方得繼續使用。

前述合法通信，指依電信管理法規定作業之無線電通信。

低功率射頻器材須忍受合法通信或工業、科學及醫療用電波輻射性電機設備之干擾。

為避免本器材影像畫面遭偷窺或擷取，本器材使用者應先修改預設密碼，並定期更新密碼。

安全諮詢及注意事項

- 請使用原裝電源供應器或只能按照本產品注明的電源類型使用本產品。
- 清潔本產品之前請先拔掉電源線。請勿使用液體、噴霧清潔劑或濕布進行清潔。
- 注意防潮，請勿將水或其他液體潑灑到本產品上。
- 插槽與開口供通風使用，以確保本產品的操作可靠並防止過熱，請勿堵塞或覆蓋開口。
- 請勿將本產品置放於靠近熱源的地方。除非有正常的通風，否則不可放在密閉位置中。
- 不要私自拆開機殼或自行維修，如產品有故障請與原廠或代理商聯繫。
- 電源供應器應使用在環境溫度低於或等於40°C的室內。

限用物質含有情況標示聲明書

| | | | | | | |
|------------------------------------|--|------------------------------|----------------------|---|---|---|
| 設備名稱：Outdoor Security Wi-Fi Camera | | 型號（型式）：Tapo C310/Tapo C310P2 | | | | |
| Equipment name | | Type designation (Type) | | | | |
| 單元 Unit | 限用物質及其化學符號 Restricted substances and its chemical symbols | | | | | |
| | 鉛 Lead (Pb) | 汞 Mercury (Hg) | 鎘 Cadmium (Cd) | 六價鉻 Hexavalent chromium (Cr ⁺⁶) | 多溴聯苯 Polybrominated biphenyls (PBB) | 多溴二苯醚 Polybrominated diphenyl ethers (PBDE) |
| PCB | ○ | ○ | ○ | ○ | ○ | ○ |

| | | | | | | |
|------------|---|---|---|---|---|---|
| 外殼 | ○ | ○ | ○ | ○ | ○ | ○ |
| 電源供應器 | — | ○ | ○ | ○ | ○ | ○ |
| 其他及其 配件 | — | ○ | ○ | ○ | ○ | ○ |

備考 1. “超出 0.1 wt %” 及 “超出 0.01 wt %” 係指限用物質之百分比含量超出百分比含量基準值

Note 1: “Exceeding 0.1 wt %” and “exceeding 0.01 wt %” indicate that the percentage content of the restricted substance exceeds the reference percentage value of presence condition.

備考 2. “○” 係指該項限用物質之百分比含量未超出百分比含量基準值。

Note 2: “○” indicates that the percentage content of the restricted substance does not exceed the percentage of reference value of presence.

備考 3. “—” 係指該項限用物質為排除項目。

Note 3: The “—” indicates that the restricted substance corresponds to the exemption.



Продукт сертифіковано згідно з правилами системи УкрСЕПРО на відповідність вимогам нормативних документів та вимогам, що передбачені чинними законодавчими актами України.















Safety Information











- Keep the device away from fire or hot environments. DO NOT immerse in water or any other liquid.
- Do not attempt to disassemble, repair, or modify the device. If you need service, please contact us.
- Do not use damaged charger or USB cable to charge the device.
- Do not use any other chargers than those recommended
- Do not use the device where wireless devices are not allowed.
- Adapter shall be easily accessible.
- Use only power supplies which are provided by manufacturer and in the original packing of this product. If you have any questions, please don't hesitate to contact us.
- Adapter should be used indoors where the ambient temperature is lower than or equal to 40°C.
- This product uses radios and other components that emit electromagnetic fields. Electromagnetic fields and magnets may interfere with pacemakers and other implanted medical devices. Always keep the product and its power adapter more than 15 cm (6 inches) away from any pacemakers or other implanted medical devices. If you suspect your product is interfering with your pacemaker or any other implanted medical device, turn off your product and consult your physician for information specific to your medical device.
- Operating Temperature: -20°C ~ 45°C (-4°F ~ 113°F)

Please read and follow the above safety information when operating the device. We cannot guarantee that no accidents or damage will occur due to improper use of the device. Please use this product with care and operate at your own risk.

Explanation of the symbols on the product label

Symbols may vary from products

| Symbol | Explanation |
|---|---|
|  | Class II equipment |
|  | Class II equipment with functional earthing |
|  | Alternating current |
|  | DC voltage |
|  | Polarity of output terminals |
|  | Indoor use only |
|  | Dangerous voltage |
|  | Caution, risk of electric shock |
|  | Energy efficiency Marking |
|  | Protective earth |
|  | Earth |
|  | Frame or chassis |

| Symbol | Explanation |
|---|--|
|  | Functional earthing |
|  | Caution, hot surface |
|  | Caution |
|  | Operator's manual |
|  | Stand-by |
|  | "ON"/"OFF" (push-push) |
|  | Fuse |
|  | Fuse is used in neutral N |
|  | <p>RECYCLING</p> <p>This product bears the selective sorting symbol for Waste electrical and electronic equipment (WEEE). This means that this product must be handled pursuant to European directive 2012/19/EU in order to be recycled or dismantled to minimize its impact on the environment.</p> <p>User has the choice to give his product to a competent recycling organization or to the retailer when he buys a new electrical or electronic equipment.</p> |
|  | Caution, avoid listening at high volume levels for long periods |
|  | Disconnection, all power plugs |

| Symbol | Explanation |
|---------------|--|
| m | Switch of mini-gap construction |
| μ | Switch of micro-gap construction (for US version) Switch of micro-gap / micro-disconnection construction (for other versions except US) |
| ε | Switch without contact gap (Semiconductor switching device) |