



User Guide

Managed Switches

1910013560 REV5.0.0

November 2023

CONTENTS

About This Guide

Intended Readers	1
Conventions.....	1
More Information	2

Accessing the Switch

Determine the Management Method	4
Web Interface Access.....	5
Login.....	5
Save the Configuration File.....	6
Disable the Web Server	7
Configure the Switch's IP Address and Default Gateway	8
Command Line Interface Access	10
Console Login (only for switch with console port).....	10
SSH Login.....	12
Telnet Login.....	16
Disable SSH login	17
Disable Telnet login.....	18
Copy running-config startup-config.....	18
Change the Switch's IP Address and Default Gateway.....	19

Managing System

System.....	21
Overview.....	21
Supported Features.....	21
System Info Configurations	23
Using the GUI	23
Viewing the System Summary.....	23
Configuring the Device Description.....	27
Configuring the System Time	27
Configuring the Daylight Saving Time.....	28
Configuring LED (Only for Certain Devices).....	29
Using the CLI.....	30
Viewing the System Summary.....	30

Configuring the Device Description	31
Configuring the System Time	32
Configuring the Daylight Saving Time	35
Configuring LED (Only for Certain Devices)	37
User Management Configurations	38
Using the GUI	38
Creating Accounts	38
Configuring Enable Password.....	39
Using the CLI	40
Creating Accounts	40
Configuring Enable Password.....	41
System Tools Configurations	44
Using the GUI	44
Configuring the Boot File	44
Restoring the Configuration of the Switch	46
Backing up the Configuration File	46
Upgrading the Firmware	47
Configuring DHCP Auto Install (Only for Certain Devices)	47
Rebooting the switch.....	49
Reseting the Switch.....	50
Using the CLI	51
Configuring the Boot File	51
Restoring the Configuration of the Switch	52
Backing up the Configuration File	52
Upgrading the Firmware	53
Upgrading the MCU-Firmware.....	54
Configuring DHCP Auto Install (Only for Certain Devices)	54
Rebooting the Switch	55
Reseting the Switch.....	57
EEE Configuration.....	58
Using the CLI	58
PoE Configurations (Only for Certain Devices)	60
Using the GUI	61
Configuring the PoE Parameters Manually.....	61
Configuring the PoE Parameters Using the Profile	64
Configuring the PoE Auto Recovery Parameters Manually.....	67
Using the CLI	69
Configuring the PoE Parameters Manually.....	69

Configuring the PoE Parameters Using the Profile.....	71
Management Port Configurations (Only for Certain Devices).....	74
Using the CLI.....	74
Power Supply Configurations (Only for Certain Devices).....	76
Using the CLI.....	76
Configuring the Power Backup Mode.....	76
SDM Template Configuration.....	77
Using the GUI.....	77
Using the CLI.....	78
Time Range Configuration.....	80
Using the GUI.....	80
Adding Time Range Entries.....	80
Configuring Holiday.....	82
Using the CLI.....	83
Adding Time Range Entries.....	83
Configuring Holiday.....	84
Controller Settings (Only for Certain Devices).....	86
Using the GUI.....	86
Enabling Cloud-Based Controller Management.....	86
Configuring Controller Inform URL.....	87
Using the CLI.....	87
Enabling Cloud-Based Controller Management.....	87
Configuring Controller Inform URL.....	87
File System Configurations.....	89
Using the CLI.....	89
Configuring the File System.....	89
FTP, SFTP and SCP Configurations.....	91
Using the CLI.....	91
Using the FTP.....	91
Using the SFTP.....	92
Using the SCP.....	92
Example for PoE Configurations.....	93
Network Requirements.....	93
Configuring Scheme.....	93
Using the GUI.....	93
Using the CLI.....	96
Appendix: Default Parameters.....	98

Managing Physical Interfaces

Physical Interface	102
Overview	102
Supported Features	102
Basic Parameters Configurations.....	103
Using the GUI	103
Using the CLI.....	104
Port Isolation Configurations	107
Using the GUI	107
Using the CLI.....	108
Loopback Detection Configuration	110
Using the GUI	110
Using the CLI.....	112
Configuration Examples	114
Example for Port Isolation.....	114
Network Requirements	114
Configuration Scheme.....	114
Using the GUI.....	114
Using the CLI	116
Example for Loopback Detection.....	117
Network Requirements	117
Configuration Scheme.....	117
Using the GUI.....	118
Using the CLI	119
Appendix: Default Parameters.....	120

Configuring Stack

Overview	122
Stack Concepts	123
Stack Operation Procedure.....	125
Stack Topology.....	127
Stack Operation Procedure.....	129
Using the GUI	129
Viewing the Stack Information.....	129
Configuring the Provision Info	130
Configuring the Provisioned Member	131
Configuring the Stack Member	131

Configuring the Stack Port Group	132
Using the CLI	136
Configuring Stack System Name.....	136
Entering Stack Port Group View	136
Configuring Stack Port.....	136
Viewing Current Stack Port Group Info.....	137
Configuring Stack Device Priority.....	137
Modifying Stack Unit ID.....	138
Configuring Provision Entries.....	138
Viewing Stack Info	139
Appendix: Default Parameters.....	140

Configuring DDM (Only for Certain Devices)

Overview	142
DDM Configuration.....	143
Using the GUI	143
Configuring DDM Globally	143
Configuring the Threshold.....	144
Viewing DDM Status.....	149
Using the CLI	149
Configuring DDM Globally	149
Configuring DDM Shutdown.....	150
Configuring the Threshold.....	151
Viewing DDM Configuration.....	157
Viewing DDM Status.....	158
Appendix: Default Parameters.....	159

Configuring LAG

LAG.....	161
Overview.....	161
Supported Features	161
LAG Configuration	162
Using the GUI	163
Configuring Load-balancing Algorithm	163
Configuring Static LAG or LACP.....	164
Using the CLI	166
Configuring Load-balancing Algorithm	166

Configuring Static LAG or LACP.....	168
Configuration Examples.....	172
Example for Static LAG.....	172
Network Requirements.....	172
Configuration Scheme.....	172
Using the GUI.....	172
Using the CLI.....	173
Example for LACP.....	174
Network Requirements.....	174
Configuration Scheme.....	174
Using the GUI.....	175
Using the CLI.....	176
Appendix: Default Parameters.....	179

Managing MAC Address Table

MAC Address Table.....	181
Overview.....	181
Supported Features.....	181
MAC Address Configurations.....	183
Using the GUI.....	183
Adding Static MAC Address Entries.....	183
Modifying the Aging Time of Dynamic Address Entries.....	185
Adding MAC Filtering Address Entries.....	185
Viewing Address Table Entries.....	186
Using the CLI.....	186
Adding Static MAC Address Entries.....	186
Modifying the Aging Time of Dynamic Address Entries.....	188
Adding MAC Filtering Address Entries.....	188
Security Configurations.....	190
Using the GUI.....	191
Configuring MAC Notification Traps.....	191
Limiting the Number of MAC Addresses Learned in VLANs.....	192
Using the CLI.....	194
Configuring MAC Notification Traps.....	194
Limiting the Number of MAC Addresses in VLANs.....	196
Example for Security Configurations.....	198
Network Requirements.....	198

Configuration Scheme	198
Using the GUI	199
Using the CLI	200
Appendix: Default Parameters	201

Configuring 802.1Q VLAN

Overview	203
802.1Q VLAN Configuration	204
Using the GUI	204
Configuring the VLAN	204
Configuring Port Parameters for 802.1Q VLAN	205
Using the CLI	206
Creating a VLAN	206
Adding the Port to the Specified VLAN	207
Configuring the Port	208
Configuration Example	210
Network Requirements	210
Configuration Scheme	210
Network Topology	211
Using the GUI	211
Using the CLI	214
Appendix: Default Parameters	216

Configuring MAC VLAN

Overview	218
MAC VLAN Configuration	219
Using the GUI	219
Configuring 802.1Q VLAN	219
Binding the MAC Address to the VLAN	219
Enabling MAC VLAN for the Port	220
Using the CLI	221
Configuring 802.1Q VLAN	221
Binding the MAC Address to the VLAN	221
Enabling MAC VLAN for the Port	222
Configuration Example	223
Network Requirements	223
Configuration Scheme	223

Using the GUI	224
Using the CLI	227
Appendix: Default Parameters	230

Configuring Protocol VLAN

Overview	232
Protocol VLAN Configuration.....	233
Using the GUI	233
Configuring 802.1Q VLAN	233
Creating Protocol Template	234
Configuring Protocol VLAN.....	235
Using the CLI	236
Configuring 802.1Q VLAN	236
Creating a Protocol Template.....	236
Configuring Protocol VLAN.....	237
Configuration Example	240
Network Requirements.....	240
Configuration Scheme	240
Using the GUI	241
Using the CLI.....	246
Appendix: Default Parameters.....	250

Configuring VLAN-VPN (Only for Certain Devices)

VLAN-VPN	252
Overview.....	252
Supported Features.....	253
Basic VLAN-VPN Configuration	254
Using the GUI	254
Configuring 802.1Q VLAN	254
Configuring Basic VLAN-VPN	255
Using the CLI	256
Configuring 802.1Q VLAN	256
Configuring Basic VLAN-VPN	256
Flexible VLAN-VPN Configuration.....	259
Using the GUI	259
Using the CLI.....	260
Configuration Examples.....	262

Example for Basic VLAN VPN	262
Network Requirements	262
Configuration Scheme	262
Using the GUI	263
Using the CLI	268
Example for Flexible VLAN VPN	272
Network Requirements	272
Configuration Scheme	272
Using the GUI	273
Using the CLI	280
Appendix: Default Parameters	283

Configuring GVRP

Overview	285
GVRP Configuration	286
Using the GUI	287
Using the CLI	288
Configuration Example	291
Network Requirements	291
Configuration Scheme	291
Using the GUI	292
Using the CLI	296
Appendix: Default Parameters	300

Configuring Private VLAN (Only for Certain Devices)

Overview	302
Private VLAN Configurations	304
Using the GUI	304
Using the CLI	305
Creating Private VLAN	305
Configuring the Up-link Port	307
Configuring the Down-link Port	309
Configuration Example	311
Network Requirements	311
Configuration Scheme	311
Network Topology	311
Using the GUI	312

Using the CLI.....	316
Appendix: Default Parameters.....	320

Configuring Multicast

Layer 2 Multicast.....	322
Overview.....	322
Supported Features.....	324
IGMP Snooping Configuration.....	326
Using the GUI.....	326
Configuring IGMP Snooping Globally.....	326
Configuring IGMP Snooping for VLANs.....	327
Configuring IGMP Snooping for Ports.....	330
Configuring Hosts to Statically Join a Group.....	331
Configuring IGMP Accounting and Authentication Features.....	332
Using the CLI.....	333
Configuring IGMP Snooping Globally.....	333
Configuring IGMP Snooping for VLANs.....	334
Configuring IGMP Snooping for Ports.....	339
Configuring Hosts to Statically Join a Group.....	340
Configuring IGMP Accounting and Authentication Features.....	341
MLD Snooping Configuration.....	345
Using the GUI.....	345
Configuring MLD Snooping Globally.....	345
Configuring MLD Snooping for VLANs.....	346
Configuring MLD Snooping for Ports.....	349
Configuring Hosts to Statically Join a Group.....	349
Using the CLI.....	350
Configuring MLD Snooping Globally.....	350
Configuring MLD Snooping for VLANs.....	351
Configuring MLD Snooping for Ports.....	356
Configuring Hosts to Statically Join a Group.....	357
MVR Configuration.....	359
Using the GUI.....	359
Configuring 802.1Q VLANs.....	359
Configuring MVR Globally.....	360
Adding Multicast Groups to MVR.....	361
Configuring MVR for the Port.....	362

(Optional) Adding Ports to MVR Groups Statically	363
Using the CLI.....	364
Configuring 802.1Q VLANs.....	364
Configuring MVR Globally.....	364
Configuring MVR for the Ports	366
Multicast Filtering Configuration.....	369
Using the GUI	369
Creating the Multicast Profile.....	369
Configure Multicast Filtering for Ports	371
Using the CLI.....	372
Creating the Multicast Profile.....	372
Binding the Profile to Ports.....	375
Viewing Multicast Snooping Information.....	379
Using the GUI	379
Viewing IPv4 Multicast Table.....	379
Viewing IPv4 Multicast Statistics on Each Port.....	380
Viewing IPv6 Multicast Table.....	381
Viewing IPv6 Multicast Statistics on Each Port.....	382
Using the CLI.....	383
Viewing IPv4 Multicast Snooping Information.....	383
Viewing IPv6 Multicast Snooping Configurations.....	384
PIM Configuration.....	385
Using the CLI.....	385
Configuring IP Multicast-routing Globally.....	385
Configuring IP PIM Globally	385
Configuring IP PIM On Specified Port.....	386
Configuring IP PIM Hello-Interval.....	387
Viewing IP Multicast Info	387
Viewing IP Mroute	388
Viewing IP PIM Interface Info	388
Viewing IP PIM Neighbor Info	389
Viewing IP PIM Statistic	390
Static Multicast-Routing Configuration.....	391
Using the CLI.....	391
Configuring Static Multicast-routing Entries.....	391
Viewing IP Mroute Static Info	391
Layer 3 IGMP Configuration.....	393
Using the CLI.....	393

Configuring IP IGMP Globally.....	393
Configuring IP IGMP On Ports.....	393
Configuration Examples	398
Example for Configuring Basic IGMP Snooping.....	398
Network Requirements	398
Configuration Scheme.....	398
Using the GUI.....	399
Using the CLI	401
Example for Configuring MVR	403
Network Requirements	403
Network Topology.....	403
Configuration Scheme.....	404
Using the GUI.....	404
Using the CLI	407
Example for Configuring Unknown Multicast and Fast Leave.....	410
Network Requirement.....	410
Configuration Scheme.....	411
Using the GUI.....	411
Using the CLI	413
Example for Configuring Multicast Filtering.....	414
Network Requirements	414
Configuration Scheme.....	414
Network Topology.....	414
Using the GUI.....	415
Using the CLI	419
Appendix: Default Parameters	422
Default Parameters for IGMP Snooping	422
Default Parameters for MLD Snooping.....	423
Default Parameters for MVR.....	424
Default Parameters for Multicast Filtering.....	424
Default Parameters for PIM.....	424
Default Parameters for Static Multicast-Routing.....	425
Default Parameters for Layer 3 IGMP.....	425

Configuring Spanning Tree

Spanning Tree.....	427
Overview.....	427

Basic Concepts	427
STP/RSTP Concepts.....	427
MSTP Concepts	431
STP Security.....	432
STP/RSTP Configurations	435
Using the GUI	435
Configuring STP/RSTP Parameters on Ports.....	435
Configuring STP/RSTP Globally.....	437
Verifying the STP/RSTP Configurations.....	439
Using the CLI.....	441
Configuring STP/RSTP Parameters on Ports.....	441
Configuring Global STP/RSTP Parameters	443
Enabling STP/RSTP Globally.....	444
MSTP Configurations	447
Using the GUI	447
Configuring Parameters on Ports in CIST	447
Configuring the MSTP Region	450
Configuring MSTP Globally.....	454
Verifying the MSTP Configurations	456
Using the CLI.....	457
Configuring Parameters on Ports in CIST	457
Configuring the MSTP Region	460
Configuring Global MSTP Parameters	463
Enabling Spanning Tree Globally.....	465
STP Security Configurations	467
Using the GUI	467
Using the CLI.....	468
Configuring the STP Security.....	468
Configuration Example for MSTP	471
Network Requirements.....	471
Configuration Scheme	471
Using the GUI	472
Using the CLI.....	478
Appendix: Default Parameters.....	485
Configuring LLDP	
LLDP.....	488

Overview.....	488
Supported Features.....	488
LLDP Configurations	489
Using the GUI.....	489
Configuring LLDP Globally.....	489
Configuring LLDP For the Port.....	491
Using the CLI.....	492
Global Config.....	492
Port Config.....	494
LLDP-MED Configurations.....	497
Using the GUI.....	497
Configuring LLDP Globally.....	497
Configuring LLDP-MED Globally.....	497
Configuring LLDP-MED for Ports.....	498
Using the CLI.....	500
Global Config.....	500
Port Config.....	501
Viewing LLDP Settings.....	504
Using GUI.....	504
Viewing LLDP Device Info.....	504
Viewing LLDP Statistics.....	508
Using CLI.....	509
Viewing LLDP-MED Settings.....	510
Using GUI.....	510
Using CLI.....	513
Configuration Example.....	514
Configuration Example for LLDP.....	514
Network Requirements.....	514
Network Topology.....	514
Configuration Scheme.....	514
Using the GUI.....	514
Using CLI.....	515
Example for LLDP-MED.....	521
Network Requirements.....	521
Configuration Scheme.....	521
Using the GUI.....	521
Using CLI.....	524
Appendix: Default Parameters.....	527

Configuring L2PT (Only for Certain Devices)

Overview	529
L2PT Configuration	531
Using the GUI	531
Using the CLI	532
Configuration Example	536
Network Requirements	536
Configuration Scheme	536
Using the GUI	536
Using the CLI	537
Appendix: Default Parameters	539

Configuring PPPoE ID Insertion (Only for Certain Devices)

Overview	541
PPPoE ID Insertion Configuration	542
Using the GUI	542
Using the CLI	543
Appendix: Default Parameters	546

Configuring Layer 3 Interfaces

Overview	548
Layer 3 Interface Configurations	549
Using the GUI	549
Creating an Layer 3 Interface	549
Configuring IPv4 Parameters of the Interface	551
Configuring IPv6 Parameters of the Interface	552
Viewing Detail Information of the Interface	555
Using the CLI	556
Creating an Layer 3 Interface	556
Configuring IPv4 Parameters of the Interface	558
Configuring IPv6 Parameters of the Interface	559
Configuration Example	562
Network Requirement	562
Configuration Scheme	562
Using the GUI	562
Using the CLI	563
Appendix: Default Parameters	565

Configuring Routing

Overview	567
IPv4 Static Routing Configuration	568
Using the GUI	568
Using the CLI	569
IPv6 Static Routing Configuration	570
Using the GUI	570
Using the CLI	570
Viewing Routing Table	572
Using the GUI	572
Viewing IPv4 Routing Table	572
Viewing IPv6 Routing Table	573
Using the CLI	573
Viewing IPv4 Routing Table	573
Viewing IPv6 Routing Table	574
RIP Configurations.....	575
Using the CLI	575
Enabling RIP Funtion.....	575
Enabling RIP Funtion for Specific Network Segment.....	575
Configuring RIP Message Version.....	576
Configuring RIP Timer.....	577
Configuring Management Distance	578
Enabling Auto-summary Function.....	579
Setting Default Metric.....	579
Configuring RIP Redirection.....	580
Enabling ECMP Funtion	581
Introducing Default Route	582
Configuring RIP Neighbor.....	582
Configuring Passive-Interface.....	583
Configuring Authentication Mode	584
Configuring Authentication String.....	585
Configuring Authentication Key-chain.....	585
Configuring Receive Version.....	586
Configuring Send Version.....	587
Configuring Split Horizon.....	588
Enabling RIPv2 Packet Broadcast	589
Viewing RIP Routing Table	589

Viewing IP Status.....	590
Clearing IP RIP	590
RIPng Configurations	592
Using the CLI.....	592
Enabling RIPng Funtion.....	592
Enabling RIP Funtion on Specific Port.....	592
Configuring RIPng Timer	593
Setting Default Metric.....	594
Configuring RIPng Redirection	595
Enabling ECMP Funtion	596
Introducing Default Route	597
Configuring Passive-Interface.....	597
Configuring Split Horizon.....	598
Viewing RIPng Routing Table.....	599
Viewing IPv6 Status	599
Clearing IPv6 RIP	600
OSPF Configurations.....	601
Using the CLI.....	601
Configuring Router OSPF	601
Configuring Router ID	602
Configuring Network	602
Configuring Max-Paths.....	603
Configuring ASBR	604
Configuring Default-Metric.....	605
Configuring Default-Information Originate.....	606
Configuring Auto-Cost.....	607
Configuring OSPF Administrative Distance	608
Configuring Computing Delay and Interval	609
Configuring RFC 1583	610
Defining Stub Area	611
Defining NSSA Area	612
Configuring Area Default-Cost	613
Configuring Summary Route	614
Configuring Area Authentication	616
Configuring Virtual-Link	616
Configuring Virtual-Link Authentication	617
Configuring Area Virtual-Link Simple Authentication Key	618
Configuring Area Virtual-Link Message-Digest-Key	619

Configuring Interface Cost	620
Configuring IP OSPF Retransmit-Interval.....	621
Configuring IP OSPF Transmit-Delay	622
Configuring IP OSPF Priority.....	623
Configuring IP OSPF Hello-Interval.....	624
Configuring IP OSPF Dead-Interval	624
Configuring IP OSPF Authentication.....	625
Configuring IP OSPF Authentication-Key	626
Configuring IP OSPF Message-Digest-Key	627
Configuring IP OSPF Network Type.....	628
Ignoring MTU Check.....	629
Preventing OSPF Packets.....	629
Reseting OSPF Process.....	630
Viewing OSPF Configuration Info.....	630
OSPFv3 Configurations.....	632
Using the CLI.....	632
Enabling OSPFv3 Routing	632
Configuring Router ID	632
Configuring Max-Paths.....	633
Configuring ASBR	634
Configuring Default-Information Originate.....	635
Configuring Auto-Cost.....	636
Configuring OSPFv3 Administrative Distance.....	636
Configuring OSPFv3 Distance.....	637
Configuring Computing Delay and Interval	638
Configuring OSPFv3 LSA Reception Interval.....	639
Defining Stub Area	639
Defining NSSA Area	640
Configuring Summary Route	641
Assigning Interfaces	642
Configuring Interface Cost	643
Configuring IPv6 OSPF Retransmit-Interval.....	644
Configuring IPv6 OSPF Transmit-Delay	645
Configuring IPv6 OSPF Priority	646
Configuring IPv6 OSPF Hello-Interval.....	647
Configuring IPv6 OSPF Dead-Interval.....	647
Configuring IPv6 OSPF Network Type	648
Ignoring MTU Check.....	649

Preventing OSPFv3 Packets	650
Resetting OSPFv3 Process	651
Viewing OSPFv3 Configuration Info	651
Example for Static Routing	652
Network Requirements	652
Configuration Scheme	652
Using the GUI	652
Using the CLI	654

Configuring DHCP Service

DHCP	659
Overview	659
Supported Features	659
DHCP Server Configuration	664
Using the GUI	664
Enabling DHCP Server	664
Configuring DHCP Server Pool	666
Configuring Manual Binding	667
Using the CLI	668
Enabling DHCP Server	668
Configuring DHCP Server Pool	671
Configuring Manual Binding	674
DHCP Relay Configuration	677
Using the GUI	677
Enabling DHCP Relay and Configuring Option 82	677
Configuring DHCP Interface Relay	679
Configuring DHCP VLAN Relay	679
Using the CLI	681
Enabling DHCP Relay	681
(Optional) Configuring Option 82	682
Configuring DHCP Interface Relay	684
Configuring DHCP VLAN Relay	685
DHCP L2 Relay Configuration	688
Using the GUI	688
Enabling DHCP L2 Relay	688
Configuring Option 82 for Ports	689
Using the CLI	690

Enabling DHCP L2 Relay	690
Configuring Option 82 for Ports	691
Configuration Examples	694
Example for DHCP Server	694
Network Requirements	694
Configuration Scheme	694
Using the GUI	694
Using the CLI	696
Example for DHCP Interface Relay	696
Network Requirements	696
Configuration Scheme	697
Using the GUI	698
Using the CLI	703
Example for DHCP VLAN Relay	706
Network Requirements	706
Configuration Scheme	706
Using the GUI	707
Using the CLI	710
Example for Option 82 in DHCP Relay	712
Network Requirements	712
Configuration Scheme	713
Configuring the DHCP Relay Switch	714
Configuring the DHCP Server	716
Example for DHCP L2 Relay	718
Network Requirements	718
Configuration Scheme	718
Configuring the DHCP Relay Switch	719
Configuring the DHCP Server	722
Appendix: Default Parameters	724

Configuring ARP

Overview	728
Supported Features	728
ARP Configurations	730
Using the GUI	730
Viewing the ARP Entries	730
Adding Static ARP Entries Manually	731

Configuring Gratuitous ARP	731
Configuring Proxy ARP	732
Configuring Local Proxy ARP	733
Using the CLI	734
Configuring the ARP Entry	734
Configuring the Gratuitous ARP	736
Configuring Proxy ARP	739
Appendix: Default Parameters.....	741

Configuring VRRP

Overview	743
VRRP Configuration	744
Using the CLI	744
Configuring VRRP on Specified Ports	744
Appendix: Default Parameters.....	749

Configuring QoS

QoS.....	751
Overview.....	751
Supported Features.....	751
Class of Service Configuration.....	753
Using the GUI	754
Configuring Port Priority.....	754
Configuring 802.1p Priority	756
Configuring DSCP Priority.....	759
Specifying the Scheduler Settings	762
Using CLI	765
Configuring Port Priority.....	765
Configuring 802.1p Priority	767
Configuring DSCP Priority.....	770
Specifying the Scheduler Settings	776
Bandwidth Control Configuration.....	780
Using the GUI	780
Configuring Rate Limit.....	780
Configuring Storm Control	781
Using the CLI.....	782
Configuring Rate Limit.....	782

Configuring Storm Control	784
Voice VLAN Configuration	786
Using the GUI	786
Configuring OUI Addresses	786
Configuring Voice VLAN Globally	788
Adding Ports to Voice VLAN	788
Using the CLI	789
Auto VoIP Configuration	792
Using the GUI	792
Using the CLI	793
Configuration Examples	797
Example for Class of Service	797
Network Requirements	797
Configuration Scheme	797
Using the GUI	798
Using the CLI	800
Example for Voice VLAN	802
Network Requirements	802
Configuration Scheme	803
Using the GUI	803
Using the CLI	807
Example for Auto VoIP	810
Network Requirements	810
Configuration Scheme	811
Using the GUI	811
Using the CLI	815
Appendix: Default Parameters	821

Configuring Access Security

Access Security	826
Overview	826
Supported Features	826
Access Security Configurations	827
Using the GUI	827
Configuring the Access Control Feature	827
Configuring the HTTP Function	830
Configuring the HTTPS Function	832

Configuring the SSH Feature	835
Configuring the Telnet Function.....	836
Configuring the Serial Port Parameters.....	837
Using the CLI.....	837
Configuring the Access Control Feature.....	837
Configuring the HTTP Function	839
Configuring the HTTPS Function	841
Configuring the SSH Feature	844
Configuring the Telnet Function.....	846
Configuring the Serial Port Parameters.....	846
Appendix: Default Parameters.....	848

Configuring AAA

Overview	851
AAA Configuration.....	852
Using the GUI	853
Adding Servers.....	853
Configuring Server Groups.....	855
Configuring the Method List.....	856
Configuring the AAA Application List	858
Configuring Login Account and Enable Password	858
Using the CLI.....	859
Adding Servers.....	859
Configuring Server Groups.....	862
Configuring the Method List.....	863
Configuring the AAA Application List	864
Configuring Login Account and Enable Password	868
Configuration Example	871
Network Requirements.....	871
Configuration Scheme	871
Using the GUI	872
Using the CLI.....	874
Appendix: Default Parameters.....	877

Configuring 802.1x

Overview	880
802.1x Configuration.....	881

Using the GUI	881
Configuring the RADIUS Server	881
Configuring 802.1x Globally.....	884
Configuring 802.1x on Ports.....	885
View the Authenticator State.....	887
Using the CLI.....	888
Configuring the RADIUS Server.....	888
Configuring 802.1x Globally.....	890
Configuring 802.1x on Ports.....	892
Viewing Authenticator State.....	894
Configuration Example	896
Network Requirements.....	896
Configuration Scheme	896
Network Topology.....	896
Using the GUI	897
Using the CLI.....	899
Appendix: Default Parameters.....	902

Configuring Port Security

Overview	904
Port Security Configuration.....	905
Using the GUI	905
Using the CLI.....	906
Appendix: Default Parameters.....	909

Configuring ACL

Overview	911
ACL Configuration	912
Using the GUI	912
Configuring Time Range	912
Creating an ACL.....	912
Configuring ACL Rules.....	913
Configuring MAC ACL Rule.....	913
Configuring IP ACL Rule.....	918
Configuring Combined ACL Rule.....	922
Configuring the IPv6 ACL Rule.....	927
Configuring the Packet Content ACL Rule.....	931

Configuring ACL Binding.....	936
Using the CLI.....	937
Configuring Time Range	937
Configuring ACL	937
Configuring Policy.....	947
Configuring ACL Binding.....	949
Viewing ACL Counting	950
Configuration Example for ACL.....	951
Configuration Example for MAC ACL.....	951
Network Requirements	951
Configuration Scheme.....	951
Using the GUI.....	952
Using the CLI	958
Configuration Example for IP ACL.....	959
Network Requirements	959
Configuration Scheme.....	960
Using the GUI.....	960
Using the CLI	966
Configuration Example for Combined ACL.....	968
Network Requirements	968
Configuration Scheme.....	968
Using the GUI.....	969
Using the CLI	974
Appendix: Default Parameters.....	976

Configuring IPv4 IMPB

IPv4 IMPB	979
Overview.....	979
Supported Features.....	979
IP-MAC Binding Configuration.....	980
Using the GUI	980
Binding Entries Manually	980
Binding Entries via ARP Scanning.....	981
Binding Entries via DHCP Snooping.....	983
Viewing the Binding Entries.....	985
Using the CLI.....	986
Binding Entries Manually	986

Binding Entries via DHCP Snooping.....	988
Viewing Binding Entries	989
ARP Detection Configuration.....	990
Using the GUI	990
Adding IP-MAC Binding Entries	990
Enabling ARP Detection.....	990
Configuring ARP Detection on Ports	991
Viewing ARP Statistics.....	992
Using the CLI.....	993
Adding IP-MAC Binding Entries	993
Enabling ARP Detection.....	993
Configuring ARP Detection on Ports	994
Viewing ARP Statistics.....	996
IPv4 Source Guard Configuration.....	997
Using the GUI	997
Adding IP-MAC Binding Entries	997
Configuring IPv4 Source Guard	997
Using the CLI.....	998
Adding IP-MAC Binding Entries	998
Configuring IPv4 Source Guard	998
Configuration Examples.....	1000
Example for ARP Detection	1000
Network Requirements	1000
Configuration Scheme.....	1000
Using the GUI.....	1001
Using the CLI	1003
Example for IP Source Guard.....	1005
Network Requirements	1005
Configuration Scheme.....	1005
Using the GUI.....	1005
Using the CLI	1007
Appendix: Default Parameters.....	1008
Configuring IPv6 IMPB	
IPv6 IMPB	1011
Overview.....	1011
Supported Features.....	1011

IPv6-MAC Binding Configuration.....	1013
Using the GUI	1013
Binding Entries Manually	1013
Binding Entries via ND Snooping.....	1014
Binding Entries via DHCPv6 Snooping.....	1016
Viewing the Binding Entries.....	1017
Using the CLI.....	1018
Binding Entries Manually	1018
Binding Entries via ND Snooping.....	1020
Binding Entries via DHCPv6 Snooping.....	1021
Viewing Binding Entries	1022
ND Detection Configuration	1023
Using the GUI	1023
Adding IPv6-MAC Binding Entries.....	1023
Enabling ND Detection.....	1023
Configuring ND Detection on Ports.....	1024
Viewing ND Statistics.....	1024
Using the CLI.....	1025
Adding IPv6-MAC Binding Entries.....	1025
Enabling ND Detection.....	1025
Configuring ND Detection on Ports.....	1026
Viewing ND Statistics.....	1027
IPv6 Source Guard Configuration.....	1028
Using the GUI	1028
Adding IPv6-MAC Binding Entries.....	1028
Configuring IPv6 Source Guard	1028
Using the CLI.....	1029
Adding IPv6-MAC Binding Entries.....	1029
Configuring IPv6 Source Guard	1029
Configuration Examples	1031
Example for ND Detection.....	1031
Network Requirements	1031
Configuration Scheme.....	1031
Using the GUI.....	1032
Using the CLI	1034
Example for IPv6 Source Guard	1035
Network Requirements	1035
Configuration Scheme.....	1036

Using the GUI.....	1036
Using the CLI	1037
Appendix: Default Parameters.....	1039

Configuring DHCP Filter

DHCP Filter	1042
Overview.....	1042
Supported Features.....	1042
DHCPv4 Filter Configuration	1044
Using the GUI	1044
Configuring the Basic DHCPv4 Filter Parameters.....	1044
Configuring Legal DHCPv4 Servers.....	1045
Using the CLI.....	1046
Configuring the Basic DHCPv4 Filter Parameters.....	1046
Configuring Legal DHCPv4 Servers.....	1048
DHCPv6 Filter Configuration	1050
Using the GUI	1050
Configuring the Basic DHCPv6 Filter Parameters.....	1050
Configuring Legal DHCPv6 Servers.....	1051
Using the CLI.....	1052
Configuring the Basic DHCPv6 Filter Parameters.....	1052
Configuring Legal DHCPv6 Servers.....	1053
Configuration Examples.....	1055
Example for DHCPv4 Filter.....	1055
Network Requirements.....	1055
Configuration Scheme.....	1055
Using the GUI.....	1056
Using the CLI	1057
Example for DHCPv6 Filter.....	1058
Network Requirements.....	1058
Configuration Scheme.....	1059
Using the GUI.....	1059
Using the CLI	1060
Appendix: Default Parameters.....	1062

Configuring DoS Defend

Overview	1064
-----------------------	-------------

DoS Defend Configuration	1065
Using the GUI	1065
Using the CLI	1066
Appendix: Default Parameters	1069

Monitoring the System

Overview	1071
Monitoring the CPU	1072
Using the GUI	1072
Using the CLI	1072
Monitoring the Memory	1074
Using the GUI	1074
Using the CLI	1074

Monitoring Traffic

Traffic Monitor	1077
Using the GUI	1077
Using the CLI	1081
Appendix: Default Parameters	1082

Mirroring Traffic

Mirroring	1084
Using the GUI	1084
Using the CLI	1086
Configuration Examples	1088
Network Requirements	1088
Configuration Scheme	1088
Using the GUI	1088
Using the CLI	1089
Appendix: Default Parameters	1091

Configuring sFlow (Only for Certain Devices)

Overview	1093
sFlow Configuration	1094
Using the GUI	1094
Configuring the sFlow Agent	1094
Configuring the sFlow Collector	1095

Configuring the sFlow Sampler	1095
Using the CLI	1097
Configuration Example	1100
Network Requirements.....	1100
Configuration Scheme	1100
Using the GUI	1100
Using the CLI	1101
Appendix: Default Parameters.....	1104

Configuring OAM (Only for Certain Devices)

Ethernet OAM.....	1106
Overview.....	1106
Supported Features	1107
Ethernet OAM Configurations.....	1110
Using the GUI	1110
Enabling OAM and Configuring OAM Mode	1110
Configuring Link Monitoring.....	1111
Configuring RFI.....	1113
Configuring Remote Loopback.....	1114
Viewing OAM Status.....	1115
Using the CLI	1117
Enabling OAM and Configuring OAM Mode	1117
Configuring Link Monitoring.....	1118
Configuring Remote Failure Indication.....	1124
Configuring Remote Loopback.....	1125
Verifying OAM Connection.....	1126
Viewing OAM Statistics	1129
Using the GUI	1129
Viewing OAMPDUs.....	1129
Viewing Event Logs.....	1131
Using the CLI	1132
Viewing OAMPDUs.....	1132
Viewing Event Logs.....	1134
Configuration Example	1136
Network Requirements.....	1136
Configuration Scheme	1136
Using the GUI.....	1136

Using the CLI	1140
Appendix: Default Parameters.....	1144

Configuring DLDP

Overview	1146
DLDP Configuration.....	1147
Using the GUI	1147
Using the CLI.....	1149
Appendix: Default Parameters.....	1151

Configuring SNMP & RMON

SNMP	1153
Overview.....	1153
Basic Concepts.....	1153
SNMP Configurations.....	1157
Using the GUI	1157
Enabling SNMP.....	1157
Creating an SNMP View.....	1158
Creating SNMP Communities (For SNMP v1/v2c)	1159
Creating an SNMP Group (For SNMP v3).....	1160
Creating SNMP Users (For SNMP v3).....	1161
Using the CLI.....	1162
Enabling SNMP.....	1162
Creating an SNMP View.....	1164
Creating SNMP Communities (For SNMP v1/v2c)	1165
Creating an SNMP Group (For SNMPv3).....	1166
Creating SNMP Users (For SNMPv3).....	1168
Notification Configurations.....	1170
Using the GUI	1170
Configuring the Information of NMS Hosts.....	1170
Enabling SNMP Traps.....	1172
Using the CLI.....	1175
Configuring the NMS Host.....	1175
Enabling SNMP Traps.....	1177
RMON	1185
RMON Configurations.....	1186
Using the GUI	1186

Configuring the Statistics Group.....	1186
Configuring History Group.....	1187
Configuring Event Group.....	1188
Configuring Alarm Group.....	1189
Using the CLI.....	1191
Configuring Statistics.....	1191
Configuring History.....	1193
Configuring Event.....	1194
Configuring Alarm.....	1195
Configuration Example.....	1198
Network Requirements.....	1198
Configuration Scheme.....	1199
Using the GUI.....	1199
Using the CLI.....	1204
Appendix: Default Parameters.....	1210

Diagnosing the Device & Network

Diagnosing the Device.....	1215
Using the GUI.....	1215
Using the CLI.....	1216
Diagnosing the Network.....	1217
Using the GUI.....	1217
Troubleshooting with Ping Testing.....	1217
Troubleshooting with Tracert Testing.....	1218
Using the CLI.....	1219
Configuring the Ping Test.....	1219
Configuring the Tracert Test.....	1220
Appendix: Default Parameters.....	1221

Configuring System Logs

Overview.....	1223
System Logs Configurations.....	1224
Using the GUI.....	1225
Configuring the Local Logs.....	1225
Configuring the Remote Logs.....	1225
Backing up the Logs.....	1226
Viewing the Log Table.....	1227

Using the CLI.....	1227
Configuring the Local Logs.....	1227
Configuring the Remote Logs.....	1229
Configuration Example	1231
Network Requirements.....	1231
Configuration Scheme	1231
Using the GUI	1231
Using the CLI	1232
Appendix: Default Parameters.....	1233

About This Guide

This User Guide provides information for managing Managed Switches. Please read this guide carefully before operation.

Intended Readers

This Guide is intended for network managers familiar with IT concepts and network terminologies.

Conventions

When using this guide, notice that features available in Managed Switches may vary by model and software version. Availability of Managed Switches may also vary by region or ISP. All images, steps, and descriptions in this guide are only examples and may not reflect your actual experience.

Some models featured in this guide may be unavailable in your country or region. For local sales information, visit <https://www.tp-link.com>.

The information in this document is subject to change without notice. Every effort has been made in the preparation of this document to ensure accuracy of the contents, but all statements, information, and recommendations in this document do not constitute the warranty of any kind, express or implied. Users must take full responsibility for their application of any products.

In this Guide, the following conventions are used:

PoE budget calculations are based on laboratory testing. Actual PoE power budget is not guaranteed and will vary as a result of client limitations and environmental factors.

The symbol  stands for Note. Notes contains suggestions or references that helps you make better use of your device.

- For GUI:

Menu Name > Submenu Name > Tab page indicates the menu structure. **System > System Info > System Summary** means the System Summary page under the System Info menu option that is located under the System menu.

Bold font indicates a button, a toolbar icon, menu or menu item.

- For CLI:

Bold Font	An unalterable keyword. For example: show logging
------------------	---

Normal Font	A constant (several options are enumerated and only one can be selected). For example: no bandwidth {all ingress egress}
{ }	Items in braces { } are required.
[]	Items in square brackets [] are optional.
	Alternative items are grouped in braces and separated by vertical bars . For example: speed {10 100 1000}
Italic Font	A variable (an actual value must be assigned). For example: bridge aging-time aging-time

Common combination:

{ [] [] }	A least one item in the square brackets must be selected. For example: bandwidth {[ingress ingress-rate] [egress egress-rate]}
	This command can be used on three occasions: bandwidth ingress ingress-rate is used to restrict ingress bandwidth. bandwidth egress egress-rate is used to restrict egress bandwidth. bandwidth ingress ingress-rate egress egress-rate is used to restrict ingress and egress bandwidth.

More Information

- The latest software and documentations can be found at Download Center at <https://www.tp-link.com/support>.
- The Installation Guide (IG) can be found where you find this guide or inside the package of the switch.
- The authentication information can be found where you find this guide.
- Specifications can be found on the product page at <https://www.tp-link.com>.
- To ask questions, find answers, and communicate with TP-Link users or engineers, please visit <https://community.tp-link.com> to join TP-Link Community.
- Our Technical Support contact information can be found at the Contact Technical Support page at <https://www.tp-link.com/support>.

Part 1

Accessing the Switch

CHAPTERS

1. Determine the Management Method
2. Web Interface Access
3. Command Line Interface Access

1 Determine the Management Method

Before building your network, choose a proper method to manage your switch based on your actual network situation. The switch supports two configuration options: Standalone Mode or Controller Mode.

 **Note:**

Controller Mode is only available on certain devices. To check whether your device supports this feature, refer to the actual web interface. If Controller Mode is available, there is **SYSTEM > Controller Settings** in the menu structure.

■ **Controller Mode**

If you want to configure and manage a large-scale network centrally, which consists of mass devices such as access points, switches, and gateways, Controller Mode is recommended. In Controller Mode, the switch can be centrally configured and monitored via Omada SDN Controller.

To prepare the switch for Omada SDN Controller Management, refer to [Controller Settings \(Only for Certain Devices\)](#). For detailed instructions about the network topology in such situations and how to use Omada SDN Controller, refer to the User Guide of Omada SDN Controller. The guide can be found on the download center of our official website: <https://www.tp-link.com/support/download/>

■ **Standalone Mode**

If you have a relatively small-sized network and only one or just a small number of devices need to be managed, Standalone Mode is recommended. In Standalone Mode, the switch can be singly configured and monitored via the GUI (Graphical User Interface, also called web interface in this text) or via the CLI (Command Line Interface). There are equivalent functions in the web interface and the command line interface, while web configuration is easier and more visual than the CLI configuration. You can choose the method according to their available applications and preference.

This User Guide introduces how to configure and monitor the switch in Standalone Mode.

 **Note:**

- The GUI and CLI is inaccessible while the switch is managed by a controller. To turn the switch back to Standalone Mode and access its GUI and CLI, you can forget the switch on the controller or reset the switch.
 - The first time you log in, change the password to better protect your network and devices.
-

2 Web Interface Access

You can access the switch's web interface through the web-based authentication. The switch uses two built-in web servers, HTTP server and HTTPS server, for user authentication.

Or you can access the switch's web interface through the Management Port. The Management Port is a dedicated Ethernet port for out-of-band management of the device. Traffic on this port is segregated from operational network traffic on the switch ports and cannot be switched or routed to the operational network. The Management Port is located next to the Console port and can connect to 10Mbps, 100Mbps or 1000Mbps devices. It needs an assigned IP for device management.

The following example shows how to login via the HTTP server.

2.1 Login

To manage your switch through a web browser in the host PC:

- 1) Make sure that the route between the host PC and the switch is available.
- 2) Launch a web browser. The supported web browsers include, but are not limited to, the following types:
 - IE 8.0, 9.0, 10.0, 11.0
 - Firefox 26.0, 27.0
 - Chrome 32.0, 33.0
- 3) Enter the switch's IP address in the web browser's address bar. The switch's default IP address is 192.168.0.1.

Figure 2-1 Enter the Switch's IP Address in the Browser

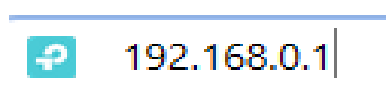

- 4) Enter the username and password (both **admin** by default) in the pop-up login window.

Figure 2-2 Login Authentication

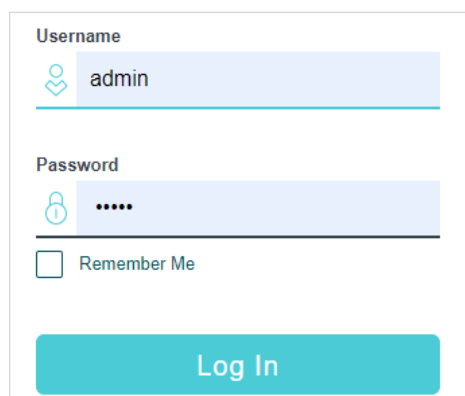
A screenshot of a login authentication form. It features two input fields: "Username" with a person icon and the text "admin" entered, and "Password" with a lock icon and six dots entered. Below these fields is a checkbox labeled "Remember Me" which is currently unchecked. At the bottom of the form is a large teal button labeled "Log In".

 **Note:**

- The first time you log in, change the password to better protect your network and devices.
- With Allow Data Collection enabled, the device will report the device name, device ID, MAC address, hardware ID, device model, hardware version, and software version to the cloud. The information is only used to help us understand the device activation status to provide you with better services. If you do not want the device to report the information, you can disable the feature at any time.

5) The typical web interface displays below. You can view the switch’s running status and configure the switch on this interface.

Figure 2-3 Web Interface

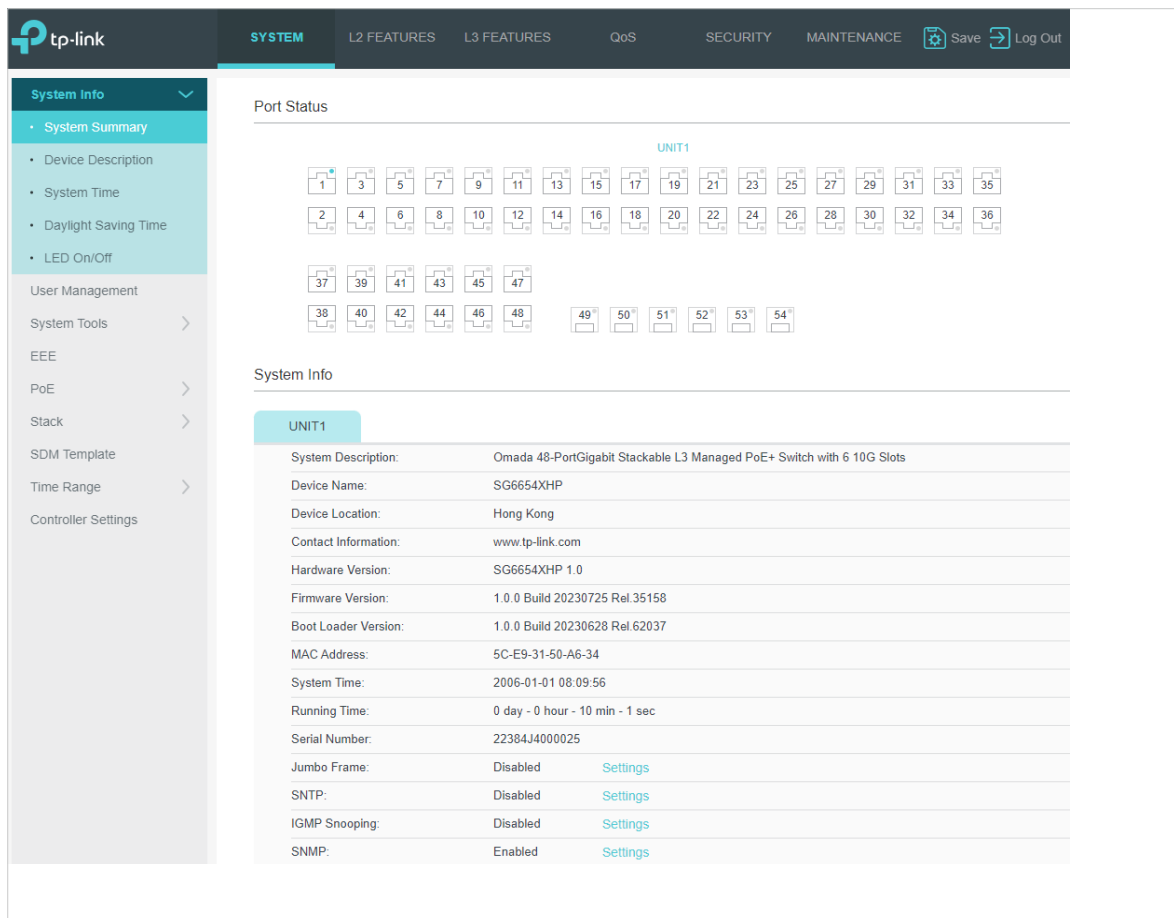

2.2 Save the Configuration File

The switch’s configuration files fall into two types: the running configuration file and the start-up configuration file.

After you perform configurations on the sub-interfaces and click **Apply**, the modifications will be saved in the running configuration file. The configurations will be lost when the switch reboots.

If you need to keep the configurations after the switch reboots, please click  **Save** on the main interface to save the configurations in the start-up configuration file.

Figure 2-4 Save the Configuration



2.3 Disable the Web Server

You can shut down the HTTP server and HTTPS server to block any access to the web interface.

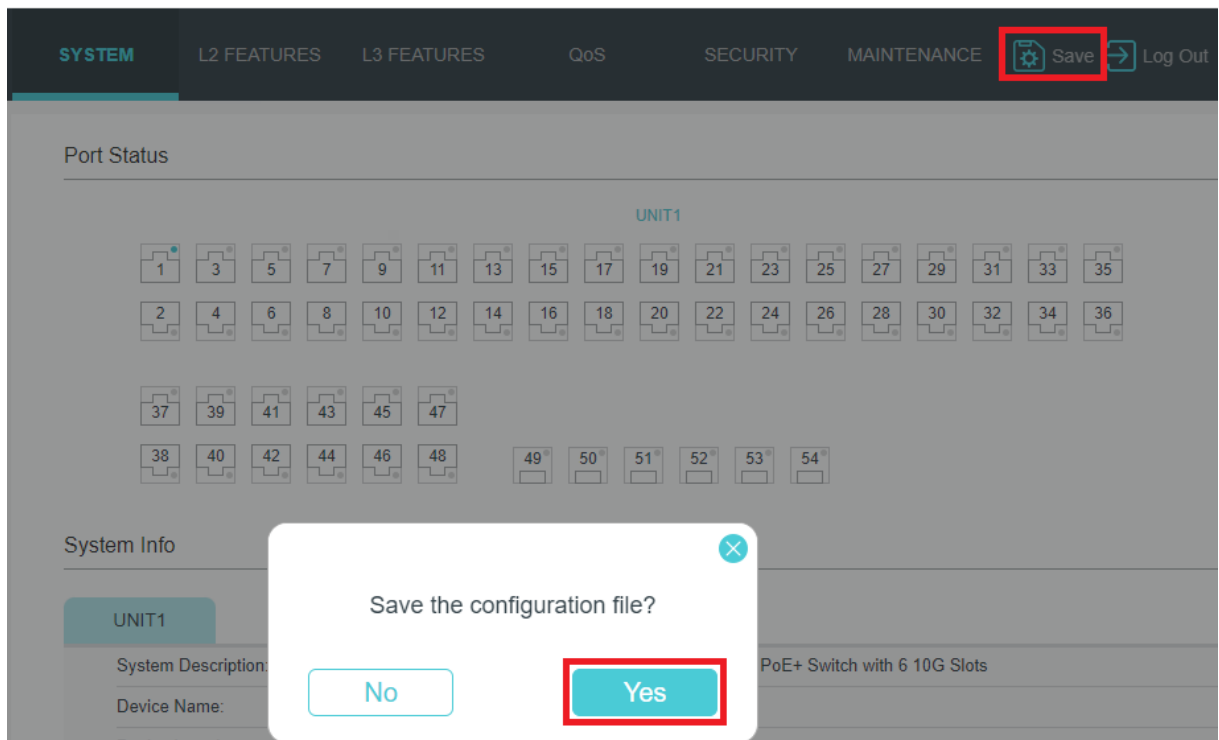
Go to **SECURITY > Access Security > HTTP Config**, disable the HTTP server and click **Apply**.

Figure 2-5 Shut Down HTTP Server

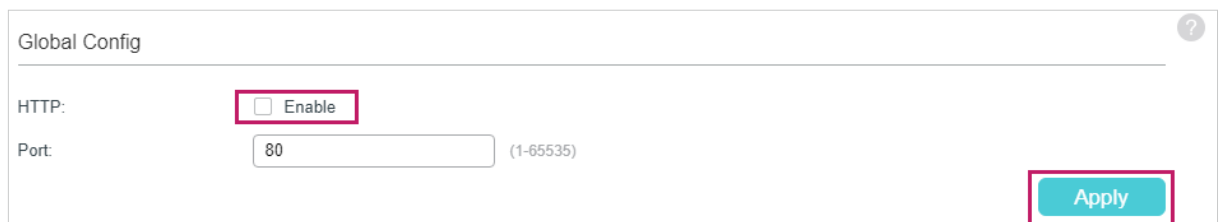

Go to **SECURITY > Access Security > HTTPS Config**, disable the HTTPS server and click **Apply**.

Figure 2-6 Disbale the HTTPS Server



2.4 Configure the Switch's IP Address and Default Gateway

If you want to access the switch via a specified port (hereafter referred to as the access port), you can configure the port as a routed port and specify its IP address, or configure the IP address of the VLAN which the access port belongs to.

■ Change the IP Address

By default, all the ports belong to VLAN 1 with the VLAN interface IP 192.168.0.1.

The following example shows how to change the switch's default access IP address 192.168.0.1.

- 1) Go to **L3 FEATURES > Interface**. The default access IP address in VLAN 1 in the Interface List. Click **Edit IPv4** to modify VLAN1's IP address.

Figure 2-7 Change VLAN1's IP Address

The screenshot shows the 'Routing Config' page. Under 'IPv4 Routing', the 'Enable' checkbox is checked. Under 'IPv6 Routing', the 'Enable' checkbox is unchecked. An 'Apply' button is visible. Below is the 'Interface List' section, which includes a table with the following data:

Interface ID	IP Address Mode	IP Address	Subnet Mask	Interface Name	Status	Operation
VLAN1	Static	192.168.0.100	255.255.255.0		Up	Edit IPv4 Edit IPv6 Detail

The 'Total: 1' indicator is shown at the bottom of the table.

- 2) Choose the **IP Address Mode** as **Static**. Enter the new access address in the **IP Address** field and click **Apply**. Make sure that the route between the host PC and the switch's new IP address is available.

Figure 2-8 Specify the IP Address

The screenshot shows the 'Modify IPv4 Interface' page. The 'Interface ID' is set to 'VLAN1'. The 'Admin Status' is checked 'Enable'. The 'Interface Name' field is empty. The 'IP Address Mode' is set to 'Static' (highlighted with a red box). The 'IP Address' field contains '192.168.0.100' (highlighted with a red box). The 'Subnet Mask' field contains '255.255.255.0'. An 'Apply' button is highlighted with a red box at the bottom right.

- 3) Enter the new IP address in the web browser to access the switch.

4) Click  Save to save the settings.

■ Configure the Default Gateway

The following example shows how to configure the switch’s gateway. By default, the switch has no default gateway.

1) Go to page **L3 FEATURES > Static Routing > IPv4 Static Routing Config**. Click  Add to load the following page and configure the parameters related to the switch’s gateway. Then click **Create**.

Figure 2-9 Configure the Default Gateway



IPv4 Static Routing

Destination: (Format: 10.10.10.0)

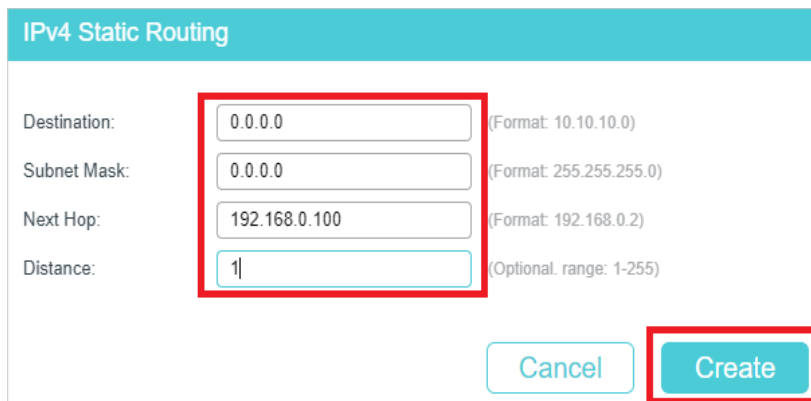
Subnet Mask: (Format: 255.255.255.0)

Next Hop: (Format: 192.168.0.2)

Distance: (Optional, range: 1-255)

Destination	Specify the destination IPv4 address of the packets.
Subnet Mask	Specify the subnet mask of the destination IPv4 address.
Next Hop	Specify the IPv4 gateway address to which the packet should be sent next.
Distance	Specify the administrative distance. The distance is the trust rating of a routing entry. A higher value means a lower trust rating. Among routes to the same destination, the route with the lowest distance value will be recorded in the routing table.

2) Click  Save to save the settings.

3) Check the routing table to verify the default gateway you configured. The entry marked in red box displays the valid default gateway.

Figure 2-10 View the Default Gateway

IPv4 Routing Information Summary

 Refresh

Protocol	Destination Network	Next Hop	Distance	Metric	Interface Name
Static	0.0.0.0/24	192.168.0.100	1	0	VLAN1
Connected	192.168.0.0/24	192.168.0.100	0	1	VLAN1
Total: 2					

3 Command Line Interface Access

Users can access the switch's command line interface through the console port or management port (only for switch with console port or management port), Telnet or SSH connection, and manage the switch with the command lines.

Console connection requires the host PC connecting to the switch's console port directly, while Telnet and SSH connection support both local and remote access.

The following table shows the typical applications used in the CLI access.

Table 3-1 Method list

Method	Using Port	Typical Applications
Console	Console port (connected directly)	Hyper Terminal
Telnet	RJ-45 port	CMD
SSH	RJ-45 port	Putty

3.1 Console Login (only for switch with console port)

Follow these steps to log in to the switch via the Console port:

- 1) Connect the PC or terminal to the Console port on the switch with the serial cable.
- 2) Start the terminal emulation program (such as the Hyper Terminal) on the PC and configure the terminal emulation program as follows:
 - Baud Rate: 38400bps
 - Data Bits: 8
 - Parity: None
 - Stop Bits: 1
 - Flow Control: None
- 3) Type the User name and Password in the Hyper Terminal window. The default value for both of them is **admin**. Press **Enter** in the main window and **Switch>** will appear, which

indicates that you have successfully logged in to the switch and you can use the CLI now.

Figure 3-1 CLI Main Window

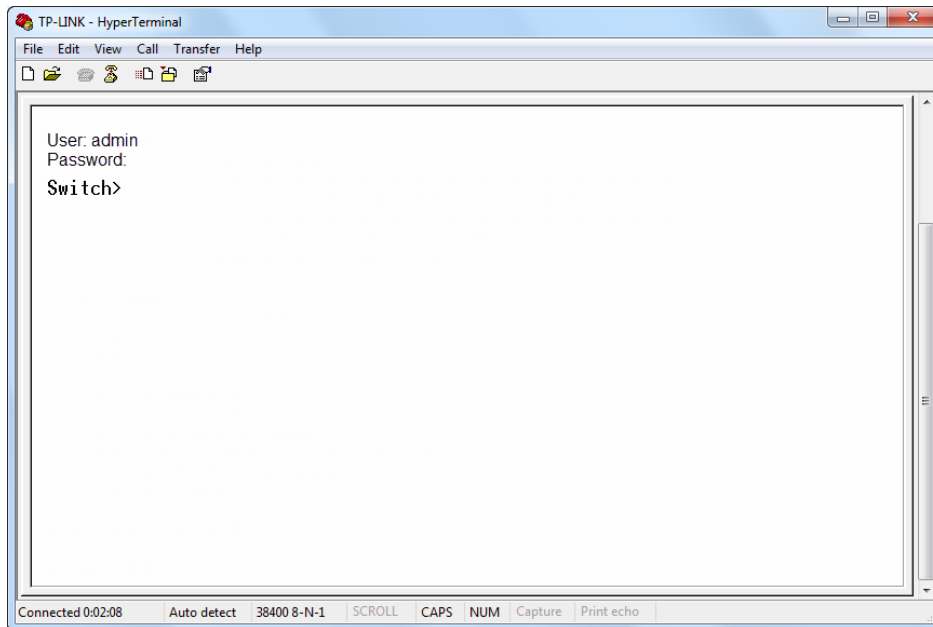

 **Note:**

The first time you log in, change the password to better protect your network and devices.

- 4) Enter **enable** to enter the User EXEC Mode to further configure the switch.

Figure 3-2 User EXEC Mode

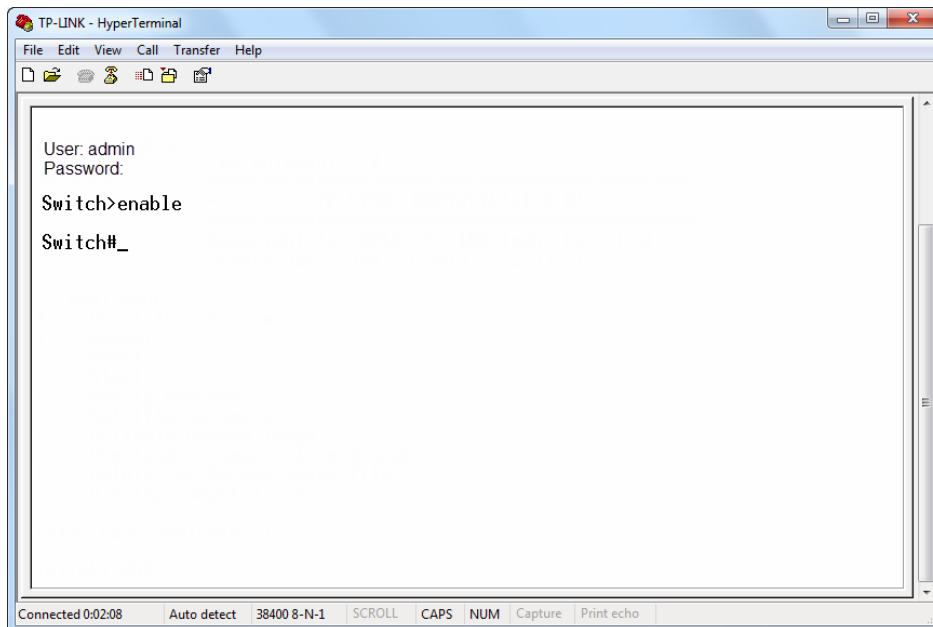

 **Note:**

In Windows XP, go to **Start > All Programs > Accessories > Communications > Hyper Terminal** to open the Hyper Terminal and configure the above settings to log in to the switch.

3.2 SSH Login

SSH login supports the following two modes: Password Authentication Mode and Key Authentication Mode. You can choose one according to your needs:

- Password Authentication Mode: Username and password are required, which are both **admin** by default.
- Key Authentication Mode (Recommended): A public key for the switch and a private key for the client software (PuTTY) are required. You can generate the public key and the private key through the PuTTY Key Generator.

Before logging in via SSH, follow the steps below to enable SSH on the terminal emulation program:

Figure 3-3 Enable SSH

```
***** User Access Login *****
User:admin
Password:

SG6654X>enable
SG6654X#config
SG6654X(config)#ip ssh server
SG6654X(config)#
```

Password Authentication Mode

- 1) Open PuTTY and go to the Session page. Enter the IP address of the switch in the **Host Name** field and keep the default value 22 in the **Port** field; select **SSH** as the Connection type. Click **Open**.

Figure 3-4 Configurations in PuTTY

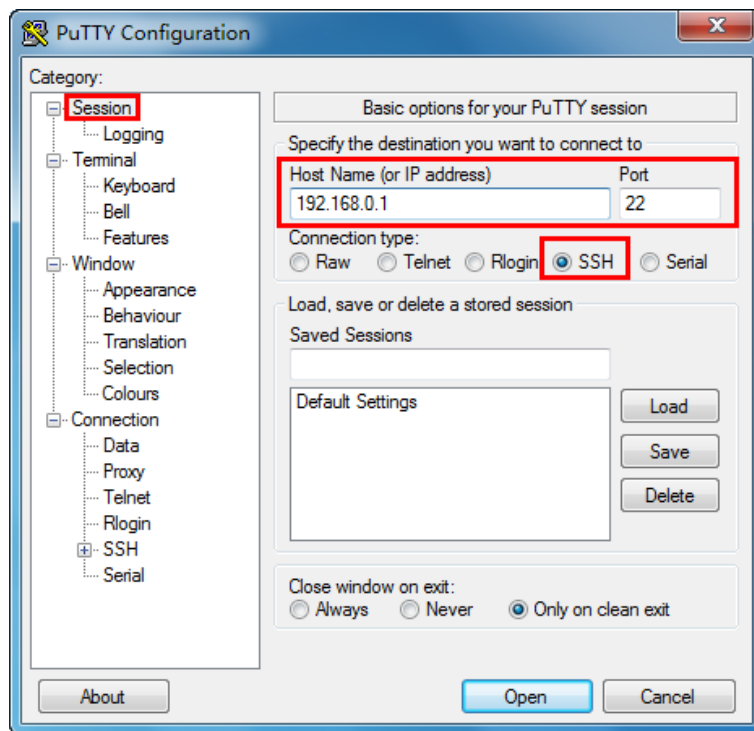

- 2) Enter the login username and password to log in to the switch, and you can continue to configure the switch.

Figure 3-5 Log In to the Switch

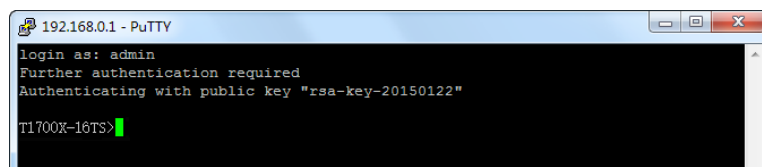

Note:

The first time you log in, change the password to better protect your network and devices.

Key Authentication Mode

- 1) Open the PuTTY Key Generator. In the Parameters section, select the key type and enter the key length. In the **Actions** section, click **Generate** to generate a public/private key pair. In the following figure, an SSH-2 RSA key pair is generated, and the length of each key is 1024 bits.

Figure 3-6 Generate a Public/Private Key Pair

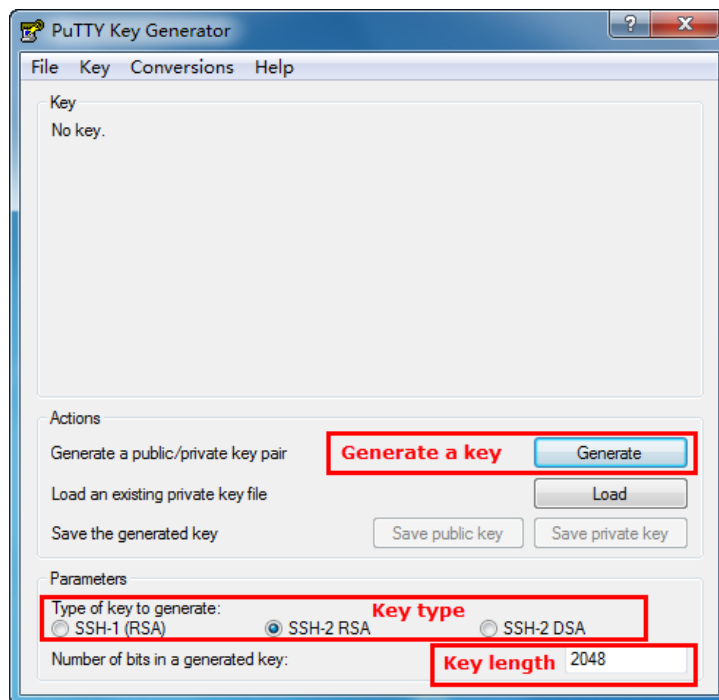

Note:

- The key length should be between 512 and 3072 bits.
- You can accelerate the key generation process by moving the mouse quickly and randomly in the Key section.

- 2) After the keys are successfully generated, click **Save public key** to save the public key to a TFTP server; click **Save private key** to save the private key to the host PC.

Figure 3-7 Save the Generated Keys

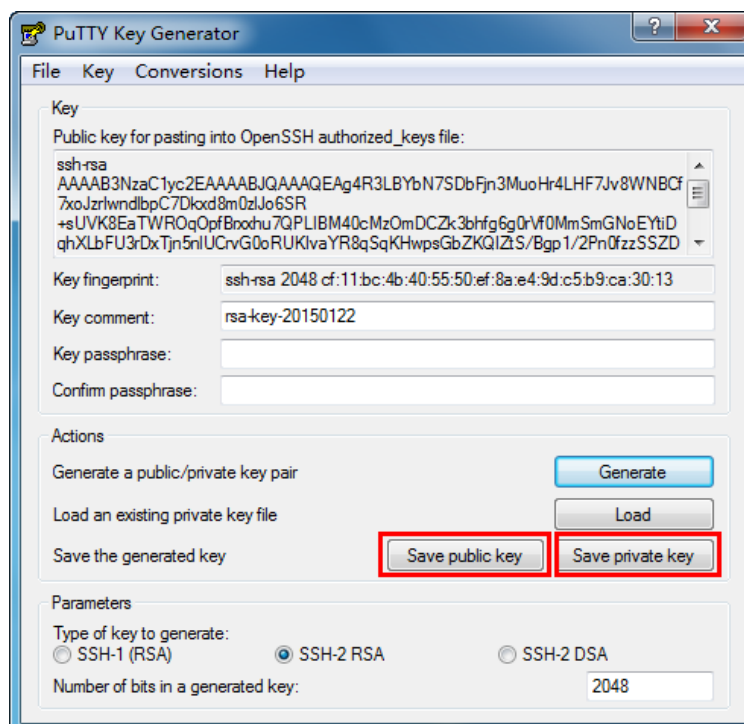

- 3) On Hyper Terminal, download the public key file from the TFTP server to the switch as shown in the following figure:

Figure 3-8 Download the Public Key to the Switch

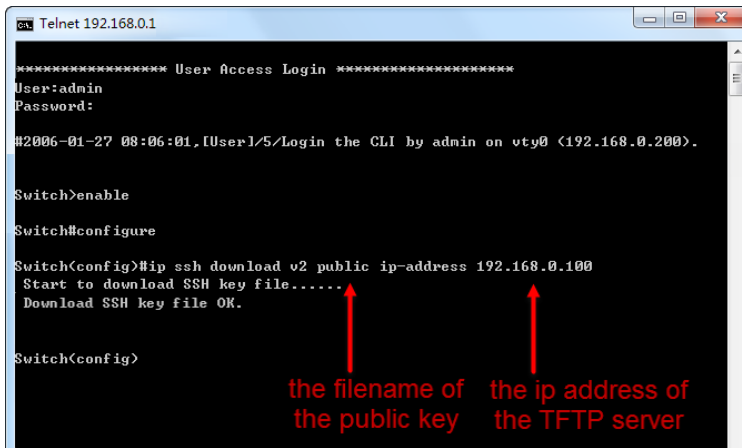

Note:

- The key type should accord with the type of the key file. In the above CLI, v1 corresponds to SSH-1 (RSA), and v2 corresponds to SSH-2 RSA and SSH-2 DSA.
- The key downloading process cannot be interrupted.

- 4) After the public key is downloaded, open PuTTY and go to the **Session** page. Enter the IP address of the switch and select **SSH** as the Connection type (keep the default value in the Port field).

Figure 3-9 Configure the Host Name and Connection Type

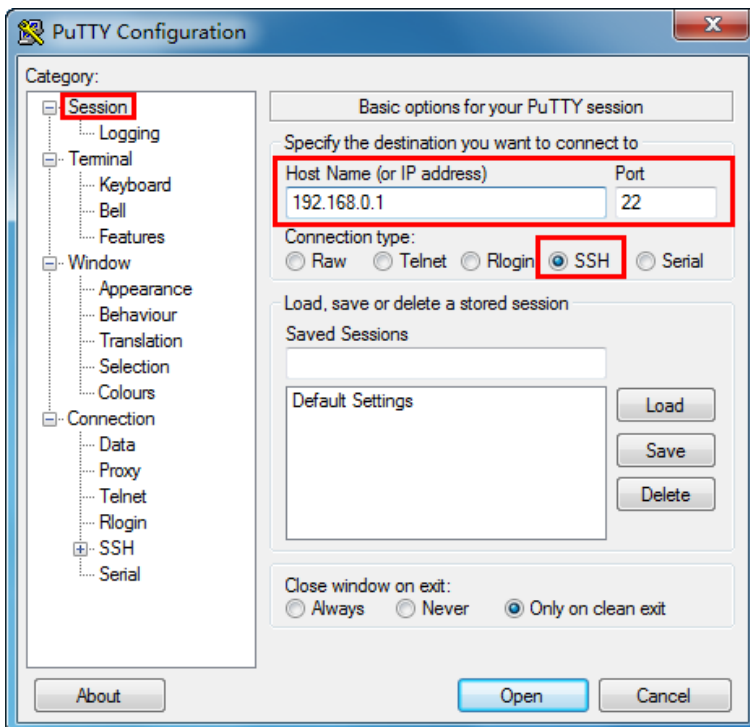

- 5) Go to **Connection > SSH > Auth**. Click **Browse** to download the private key file to PuTTY. Click **Open** to start the connection and negotiation.

Figure 3-10 Download the Private Key to PuTTY

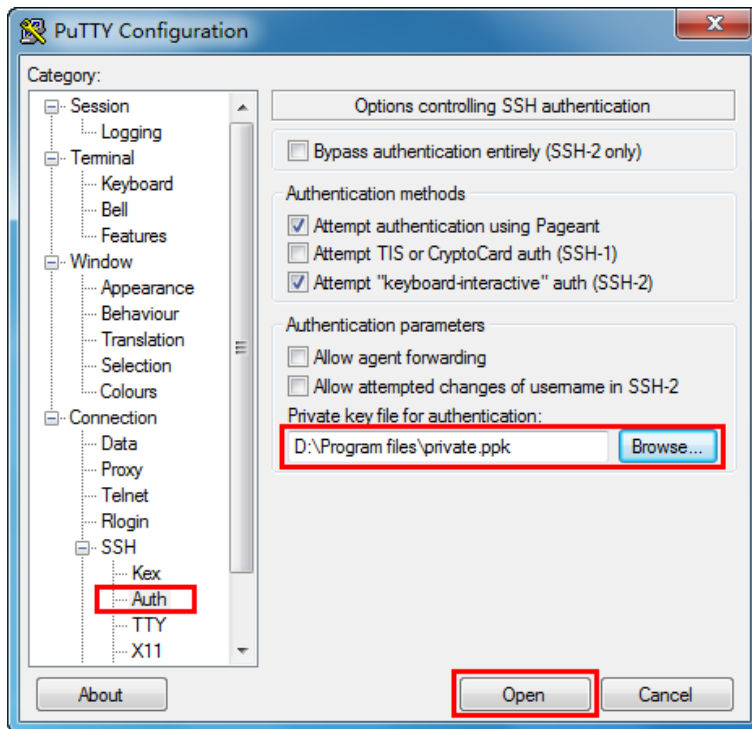

- 6) After negotiation is completed, enter the username to log in. If you can log in without entering the password, the key authentication completed successfully.

Figure 3-11 Log In to the Switch

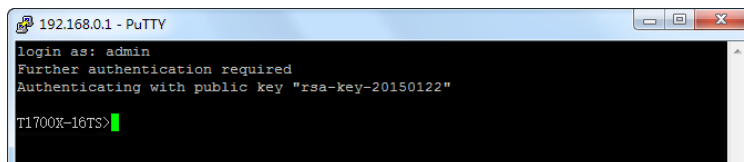

Note:

The first time you log in, change the password to better protect your network and devices.

3.3 Telnet Login

The switch supports Login Local Mode for authentication by default.

Before logging in via Telnet, enable Telnet on the terminal emulation program via SSH or serial cable.

Login Local Mode: Username and password are required, which are both admin by default.

The following steps show how to manage the switch via the Login Local Mode:

- 1) Make sure the switch and the PC are in the same LAN (Local Area Network). Click **Start** and type in **cmd** in the Search bar and press **Enter**.

Figure 3-12 Open the CMD Window

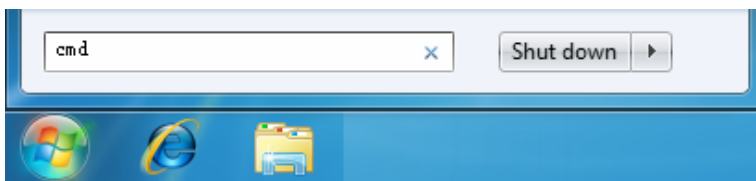

- 2) Type in **telnet 192.168.0.1** in the CMD window and press **Enter**.

Figure 3-13 Log In to the Switch

```
Microsoft Windows [Version 10.0.19045.2965]
(c) Microsoft Corporation. All rights reserved.

C:\Users\admin>telnet 192.168.0.1_
```

- 3) Type in the login username and password (both **admin** by default). Press **Enter** and you will enter User EXEC Mode.

Figure 3-14 Enter User EXEC Mode

```
***** User Access Login *****

User:admin
Password:

SG6654X>_
```

Note:

The first time you log in, change the password to better protect your network and devices.

- 4) Type in **enable** command and you will enter Privileged EXEC Mode. By default no password is needed. Later you can set a password for users who want to access the Privileged EXEC Mode.

Figure 3-15 Enter Privileged EXEC Mode

```
***** User Access Login *****

User:admin
Password:

SG6654X>enable

SG6654X#_
```

Now you can manage your switch with CLI commands through Telnet connection.

3.4 Disable SSH login

You can shut down the SSH server to block any SSH access to the CLI interface.

- Using the GUI:

Go to **SECURITY > Access Security > SSH Config**, disable the SSH server and click **Apply**.

Figure 3-16 Shut down SSH server



The screenshot shows the 'Global Config' page for SSH. The 'SSH:' checkbox is unchecked and highlighted with a red box. Other settings include 'Protocol V1' and 'Protocol V2' checked, 'Idle Timeout' at 120 seconds, 'Maximum Connections' at 5, and 'Port' at 22. An 'Apply' button is highlighted with a red box in the bottom right corner.

- Using the CLI:

```
Switch#configure
```

```
Switch(config)#no ip ssh server
```

3.5 Disable Telnet login

You can shut down the Telnet function to block any Telnet access to the CLI interface.

- Using the GUI:

Go to **SECURITY > Access Security > Telnet Config**, disable the Telnet function and click **Apply**.

Figure 3-17 Disable Telnet login

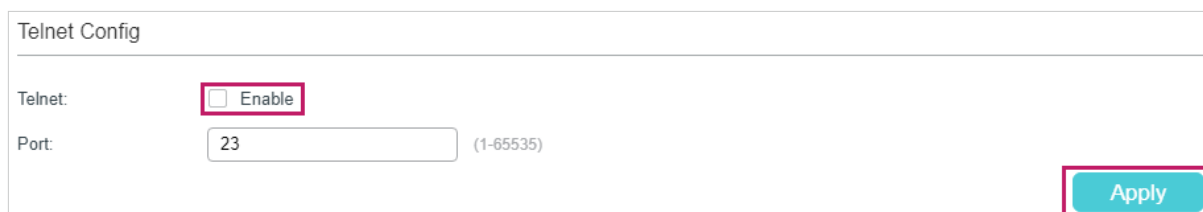

The screenshot shows the 'Telnet Config' page. The 'Telnet:' checkbox is unchecked and highlighted with a red box. The 'Port:' is set to 23. An 'Apply' button is highlighted with a red box in the bottom right corner.

- Using the CLI:

```
Switch#configure
```

```
Switch(config)#telnet disable
```

3.6 Copy running-config startup-config

The switch's configuration files fall into two types: the running configuration file and the start-up configuration file.

After you enter each command line, the modifications will be saved in the running configuration file. The configurations will be lost when the switch reboots.

If you need to keep the configurations after the switch reboots, please use the command **copy running-config startup-config** to save the configurations in the start-up configuration file.

```
Switch(config)#end
```

```
Switch#copy running-config startup-config
```

3.7 Change the Switch's IP Address and Default Gateway

If you want to access the switch via a specified port (hereafter referred to as the access port), you can configure the port as a routed port and specify its IP address, or configure the IP address of the VLAN which the access port belongs to.

■ Change the IP Address

By default, all the ports belong to VLAN 1 with the VLAN interface IP 192.168.0.1/24. In the following example, we will show how to replace the switch's default access IP address 192.168.0.1/24 with 192.168.0.10/24.

```
Switch#configure
```

```
Switch(config)#interface vlan 1
```

```
Switch(config-if)#ip address 192.168.0.10 255.255.255.0
```

The connection will be interrupted and you should telnet to the switch's new IP address 192.168.0.10.

```
C:\Users\Administrator>telnet 192.168.0.10
```

```
User:admin
```

```
Password:tplink
```

```
Switch>enable
```

```
Switch#copy running-config startup-config
```

■ Configure the Default Gateway

In the following example, we will show how to configure the switch's gateway as 192.168.0.100. By default, the switch has no default gateway.

```
Switch#configure
```

```
Switch(config)#ip route 0.0.0.0 0.0.0.0 192.168.0.100 1
```

```
Switch(config)#end
```

```
Switch#copy running-config startup-config
```

Part 2

Managing System

CHAPTERS

1. System
2. System Info Configurations
3. User Management Configurations
4. System Tools Configurations
5. EEE Configuration
6. PoE Configurations (Only for Certain Devices)
7. Management Port Configurations (Only for Certain Devices)
8. Power Supply Configurations
9. SDM Template Configurations
10. Time Range Configurations
11. Controller Settings (Only for Certain Devices)
12. File System Configurations
13. FTP, SFTP and SCP Configurations
14. Example for PoE Configurations
15. Appendix: Default Parameters

1 System

1.1 Overview

In System part, you can view the system information and configure the system parameters and features of the switch.

1.2 Supported Features

System Info

You can view the switch's port status and system information, and configure the device description, system time, daylight saving time and LED status.

User Management

You can manage the user accounts for login to the switch. There are multiple user types which have different access levels, and you can create different user accounts according to your need.

System Tools

You can configure the boot file of the switch, backup and restore the configurations, update the firmware, reset the switch, and reboot the switch.

EEE

EEE (Energy Efficient Ethernet) is used to reduce the power consumption of the switch during periods of low data transmission. You can simply enable this feature on ports to allow power reduction.

PoE

Note:

PoE configuration is only available on certain devices. To check whether your device supports this feature, refer to the actual web interface. If PoE configuration is available, there is **SYSTEM > PoE** in the menu structure.

Power over Ethernet (PoE) is a remote power supply function. With this function, the switch can supply power in addition to data to connected devices over twisted-pair cables.

Some devices such as IP phones, access points (APs) and cameras may be located far away from the AC power source in actual use. PoE can provide power for these devices without requiring to deploy power cables. This allows a single cable to provide both data connection and electric power to devices.

IEEE 802.3af and 802.3at are both PoE standards. The standard process of PoE power supply contains powered-device discovery, power administration, disconnect detection and optional power-device power classification.

■ PSE

Power sourcing equipment (PSE) is a device that provides power for PDs on the Ethernet, for example, the PoE switch. PSE can detect the PDs and determine the device power requirements.

■ PD

Powered device (PD) is a device receiving power from the PSE, for example, IP phones and access points. According to whether PDs comply with IEEE standard, they can be classified into standard PDs and non-standard PDs. Only standard PDs can be powered via TP-Link PoE switches.

Stack

Note:

This feature is only supported on stackable switches.

With stackable design, the switches can be stacked into one stack topology for higher reliability, larger bandwidth, and simpler networking. To build the stack topology, you need to prepare 2-4 switches and enough SFP+/SFP28 modules/cables.

SDM Template

SDM (Switch Database Management) Template is used to distribute system resources to different applications such as ACL and ARP Detection. The switch provides three templates with different resource allocations. You can view the details of the three templates and choose one according to your needs.

Time Range

With this feature, you can configure a time range. You can use the time range when you configure other features like ACL.

Controller Settings

Note:

Controller Settings is only available on certain devices. To check whether your device supports this feature, refer to the actual web interface. If Controller Settings is available, there is **SYSTEM > Controller Settings** in the menu structure.

With this feature, you can configure your switch to be discovered by Omada SDN Controller on this page, then it can be managed centrally via Omada SDN Controller.

2 System Info Configurations

With system information configurations, you can:

- View the System Summary
- Configure the Device Description
- Configure the System Time
- Configure the Daylight Saving Time
- Configuring LED (Only for Certain Devices)

2.1 Using the GUI

2.1.1 Viewing the System Summary

Choose the menu **SYSTEM > System Info > System Summary** to load the System Summary page. You can view the port status and system information of the switch.





Viewing the Port Status

In the **Port Status** section, you can view the status and bandwidth utilization of each port.

Figure 2-1 Viewing the System Summary



The following table introduces the meaning of each port status:

Port Status	Indication
	Indicates the Ethernet port is not connected to a device.
	Indicates the Ethernet port is transmitting and receiving data at the highest speed.
	Indicates the Ethernet port is transmitting and receiving data, but not at the highest speed.
	Indicates the SFP port is not connected to a device.



Indicates the SFP port is transmitting and receiving data at the highest speed.



Indicates the SFP port is transmitting and receiving data, but not at the highest speed.

You can move your cursor to a port to view the detailed information of the port.

Figure 2-2 Port Information

Port:1/0/4	
Type:	Auto RJ45
Speed:	1000M, Full Duplex
Status:	Link Up

Port Information	Indication
Port	Displays the port number.
Type	Displays the type of the port.
Speed	Displays the maximum transmission rate and duplex mode of the port.
Status	Displays the connection status of the port.

You can click a port to view the bandwidth utilization on this port.

Figure 2-3 Bnadwidth Utilization

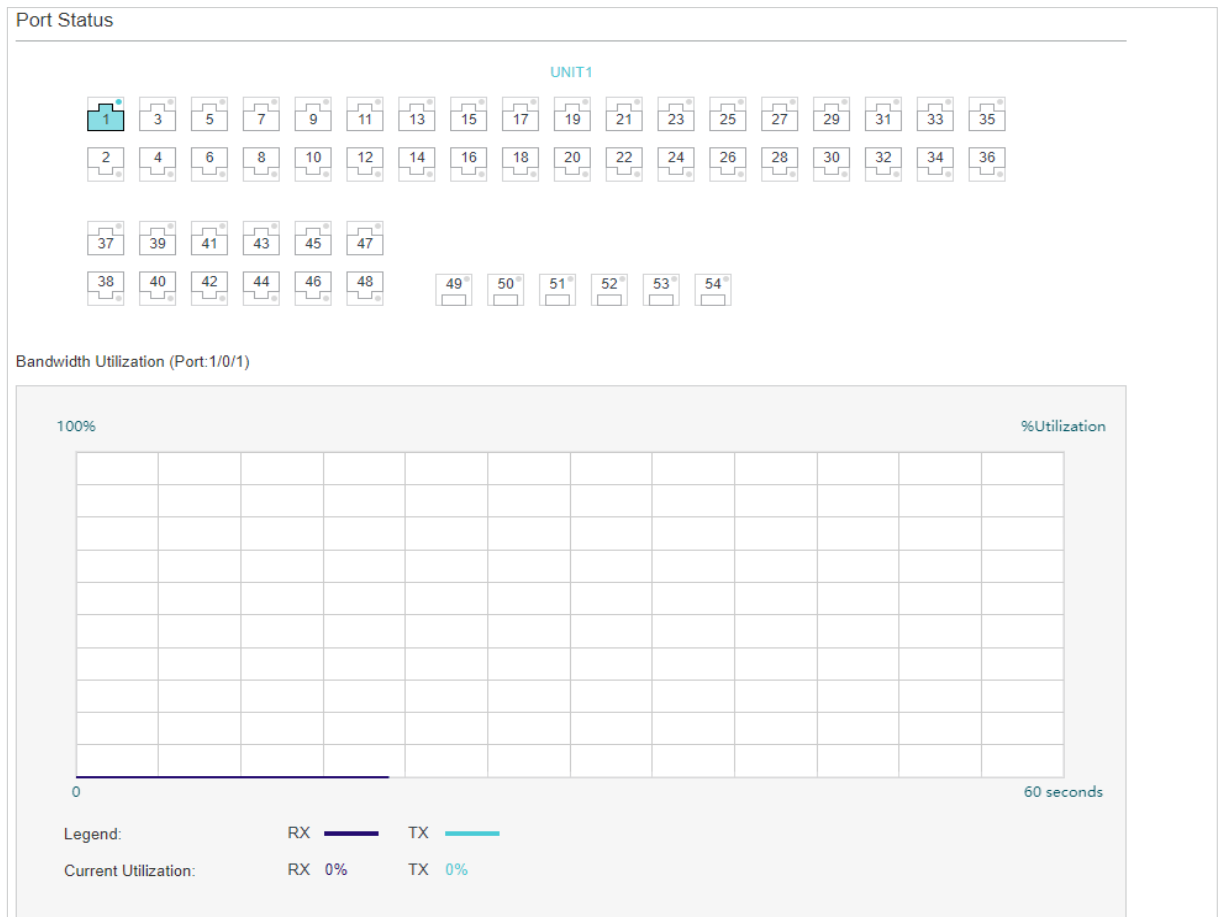

RX	Displays the bandwidth utilization of receiving packets on this port.
TX	Displays the bandwidth utilization of sending packets on this port.

Viewing the System Information

In the **System Info** section, you can view the system information of the switch.

Figure 2-4 System Information

System Info		
UNIT1		
System Description:	Omada 48-Port Gigabit Stackable L3 Managed PoE+ Switch with 6 10G Slots	
Device Name:	SG6654XHP	
Device Location:	Hong Kong	
Contact Information:	www.tp-link.com	
Hardware Version:	SG6654XHP 1.0	
Firmware Version:	1.0.0 Build 20231105 Rel.68404	
Boot Loader Version:	1.0.0 Build 20230821 Rel.74148	
MAC Address:	5C-E9-31-50-A6-34	
System Time:	2023-11-13 14:36:28	
Running Time:	0 day - 0 hour - 39 min - 50 sec	
Serial Number:	22384J4000025	
Jumbo Frame:	Disabled	Settings
SNTP:	Disabled	Settings
IGMP Snooping:	Disabled	Settings
SNMP:	Enabled	Settings
Spanning Tree:	Disabled	Settings
DHCP Relay:	Disabled	Settings
802.1X:	Disabled	Settings
HTTP Server:	Enabled	Settings
Telnet:	Disabled	Settings
SSH:	Enabled	Settings

System Description	Displays the system description of the switch.
Device Name	Displays the name of the switch. You can edit it on the Device Description page.
Device Location	Displays the location of the switch. You can edit it on the Device Description page.
Contact Information	Displays the contact information of the switch. You can edit it on the Device Description page
Hardware Version	Displays the hardware version of the switch.

Firmware Version	Displays the firmware version of the switch.
Boot Loader Version	Displays the boot loader version of the switch.
MAC Address	Displays the MAC address of the switch.
System Time	Displays the system time of the switch.
Running Time	Displays the running time of the switch.
Serial Number	Displays the serial number of the switch.
Jumbo Frame	Displays whether Jumbo Frame is enabled. You can click Settings to jump to the Jumbo Frame configuration page.
SNTP	Displays whether the switch gets system time from NTP Server. You can click Settings to jump to the System Time configuration page.
IGMP Snooping	Displays whether IGMP Snooping is enabled. You can click Settings to jump to the IGMP Snooping configuration page.
SNMP	Displays whether SNMP is enabled. You can click Settings to jump to the SNMP configuration page.
Spanning Tree	Displays whether Spanning Tree is enabled. You can click Settings to jump to the Spanning Tree configuration page.
DHCP Relay	Displays whether DHCP Relay is enabled. You can click Settings to jump to the DHCP Relay configuration page.
802.1x	Displays whether 802.1x is enabled. You can click Settings to jump to the 802.1x configuration page.
HTTP Server	Displays whether HTTP server is enabled. You can click Settings to jump to the HTTP configuration page.
Telnet	Displays whether Telnet is enabled. You can click Settings to jump to the Telnet configuration page.
SSH	Displays whether SSH is enabled. You can click Settings to jump to the SSH configuration page.

2.1.2 Configuring the Device Description

Choose the menu **SYSTEM > System Info > Device Description** to load the following page.

Figure 2-5 Configuring the Device Description

Device Description

Device Name: (1-255 characters)

Device Location: (1-255 characters)

System Contact: (1-255 characters)

1) In the **Device Description** section, configure the following parameters.

Device Name	Specify a name for the switch.
Device Location	Enter the location of the switch.
System Contact	Enter the contact information.

2) Click **Apply**.

2.1.3 Configuring the System Time

Choose the menu **SYSTEM > System Info > System Time** to load the following page.

Figure 2-6 Configuring the System Time

Time Info

Current System Time: Wednesday, November 8, 2023 17:17:17

Current Time Source: PC's Clock

Time Config

Configure Manually Get Time from NTP Server Synchronize with PC's Clock

Time Zone:

Primary NTP Server: (Format: 192.168.0.1 or 2001::1)

Secondary NTP Server: (Format: 192.168.0.1 or 2001::1)

Update Rate: hours (1-24)

In the **Time Info** section, you can view the current time information of the switch.

Current System Time	Displays the current date and time of the switch.
Current Time Source	Displays the current time source of the switch.

In the **Time Config** section, there are three methods to configure the system time: Manual, Get Time from NTP Server and Synchronize with PC's Clock. Follow these steps to configure the system time:

- 1) Choose one method to set the system time and specify the related parameters.

Manual	Set the system time manually.
	Date: Specify the date of the system.
	Time: Specify the time of the system.
Get Time from NTP Server	Get the system time from an NTP server. Make sure the NTP server is accessible on your network. If the NTP server is on the internet, connect the switch to the internet first.
	Time Zone: Select your local time zone.
	Primary Server: Enter the IP Address of the primary NTP server.
	Secondary Server: Enter the IP Address of the secondary NTP server. Once the primary NTP server is down, the switch can get the system time from the secondary NTP server.
	Update Rate: Specify the interval the switch fetching time from NTP server, which ranges from 1 to 24 hours.
Synchronize with PC's Clock	Synchronize the system time of the switch with PC's clock.

- 2) Click **Apply**.

2.1.4 Configuring the Daylight Saving Time

Choose the menu **SYSTEM > System Info > Daylight Saving Time** to load the following page.

Figure 2-7 Configuring the Daylight Saving Time

DST Config

DST: Enable

Mode: Predefined Mode Recurring Mode Date Mode

Predefined Profile:

Follow these steps to configure Daylight Saving Time:

- 1) In the **DST Config** section, enable the Daylight Saving Time function.
- 2) Choose one method to set the Daylight Saving Time and specify the related parameters.

Predefined Mode

If you select **Predefined Mode**, choose a predefined DST schedule for the switch.

USA: Select the Daylight Saving Time of the USA. It is from 2: 00 a.m. on the Second Sunday in March to 2:00 a.m. on the First Sunday in November.

Australia: Select the Daylight Saving Time of Australia. It is from 2:00 a.m. on the First Sunday in October to 3:00 a.m. on the First Sunday in April.

Europe: Select the Daylight Saving Time of Europe. It is from 1: 00 a.m. on the Last Sunday in March to 1:00 a.m. on the Last Sunday in October.

New Zealand: Select the Daylight Saving Time of New Zealand. It is from 2: 00 a.m. on the Last Sunday in September to 3:00 a.m. on the First Sunday in April.

Recurring Mode

If you select **Recurring Mode**, specify a cycle time range for the Daylight Saving Time of the switch. This configuration will be used every year.

Offset: Specify the time to set the clock forward by.

Start Time: Specify the start time of Daylight Saving Time. The interval between start time and end time should be more than 1 day and less than 1 year(365 days).

End Time: Specify the end time of Daylight Saving Time. The interval between start time and end time should be more than 1 day and less than 1 year (365 days).

Date Mode

If you select **Date Mode**, specify an absolute time range for the Daylight Saving Time of the switch. This configuration will be used only one time.

Offset: Specify the time to set the clock forward by.

Start Time: Specify the start time of Daylight Saving Time. The interval between start time and end time should be more than 1 day and less than 1 year(365 days).

End Time: Specify the end time of Daylight Saving Time. The interval between start time and end time should be more than 1 day and less than 1 year (365 days).

3) Click **Apply**.

2.1.5 Configuring LED (Only for Certain Devices)

Note:

Configuring LED is only available on certain devices. To check whether your device supports this feature, refer to the actual web interface. If configuring LED is available, there is **SYSTEM > LED On/Off** in the menu structure.

Choose the menu **System > LED On/Off** to load the following page. Choose the LED status and click **Apply**.

Figure 2-8 Configuring LED On/Off

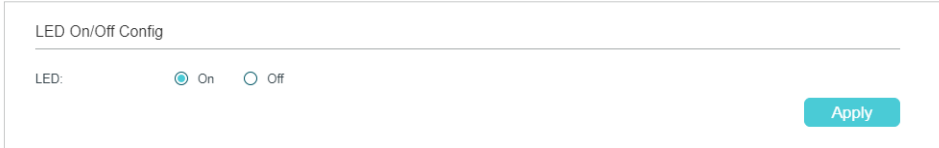

2.2 Using the CLI

2.2.1 Viewing the System Summary

On privileged EXEC mode or any other configuration mode, you can use the following commands to view the system information of the switch:

```
show interface status [ fastEthernet port | gigabitEthernet port | ten-gigabitEthernet port ]
```

View status of the interface.

port: Enter the number of the Ethernet port.

```
show system-info
```

View the system information including System Description, Device Name, Device Location, System Contact, Hardware Version, Firmware Version, System Time, Run Time and so on.

The following example shows how to view the interface status and the system information of the switch.

Switch#show interface status

Port	Status	Speed	Duplex	FlowCtrl	Active-Medium	Description
-----	-----	-----	-----	-----	-----	-----
Gi1/0/1	LinkDown	N/A	N/A	N/A	Copper	
Gi1/0/2	LinkDown	N/A	N/A	N/A	Copper	
Gi1/0/3	LinkUp	1000M	Full	Disable	Copper	
...						

Switch#show system-info

System Description - Omada 48-Port Gigabit Stackable L3 Managed Switch with 6 10G Slots

Device Name - SG6654X

Device Location - Hong Kong

Contact Information - www.tp-link.com

Hardware Version - SG6654X 1.0

Software Version - 1.0.0 Build 20231105 Rel.68404

Bootloader Version - 1.0.0 Build 20230821 Rel.74148

MAC Address - 5C-E9-31-43-31-FA

Serial Number - 2238481000146

System Time - 2023-12-01 11:19:40

Running Time - 0 day - 0 hour - 3 min - 43 sec

Device Info

Unit 1

Unit State - Provisioned

Hardware Version - SG6654X

Unit 2

Unit State - Ready

Hardware Version - SG6654X 1.0

Firmware Version - 1.0.0 Build 20231105 Rel.68404

Bootloader Version - 1.0.0 Build 20230821 Rel.74148

Serial Number - 2238481000146

Running Time - 0 day - 0 hour - 3 min - 43 sec

Power Supply Module - Operational

Redundant Power Supply - Support

2.2.2 Configuring the Device Description

Follow these steps to configure the device description:

Step 1 **configure**

Enter global configuration mode.

Step 2 **hostname [hostname]**

Specify the system name of the switch.

hostname: Enter the device name. The length of the name ranges from 1 to 32 characters. By default, it is the model name of the switch.

Step 3 **location [location]**

Specify the system location of the switch.

location: Enter the device location. It should consist of no more than 32 characters. By default, it is "SHENZHEN".

Step 4 **contact-info [contact-info]**

Specify the system contact Information.

contact-info: Enter the contact information. It should consist of no more than 32 characters. By default, it is "www.tp-link.com".

-
- Step 5 **show system-info**
Verify the system information including system Description, Device Name, Device Location, System Contact, Hardware Version, Firmware Version, System Time, Run Time and so on.
-
- Step 6 **end**
Return to privileged EXEC mode.
-
- Step 7 **copy running-config startup-config**
Save the settings in the configuration file.
-

The following example shows how to set the device name as Switch_A, set the location as BEIJING and set the contact information as <https://www.tp-link.com>.

Switch#configure

Switch(config)#hostname Switch

Switch(config)#location HongKong

Switch(config)#contact-info <https://www.tp-link.com>

Switch(config)#show system-info

System Description - Omada 48-Port Gigabit Stackable L3 Managed Switch with 6 10G Slots

Device Name - Switch

Device Location - HongKong

Contact Information - www.tp-link.com

...

Switch(config)#end

Switch#copy running-config startup-config

2.2.3 Configuring the System Time

Follow these steps to configure the system time:

 **Note:**

The mode of Synchronize with PC's Clock does not support CLI command.

-
- Step 1 **configure**
Enter global configuration mode.
-
- Step 2 Use the following command to set the system time manually:
system-time manual time
Configure the system time manually.
-

time: Specify the date and time manually in the format of MM/DD/YYYY-HH:MM:SS. The valid value of the year ranges from 2000 to 2037.

Use the following command to set the system time by getting time from the NTP server. Ensure the NTP server is accessible. If the NTP server is on the internet, connect the switch to the internet first.

system-time ntp { *timezone* } { *ntp-server* } { *backup-ntp-server* } { *fetching-rate* }

timezone: Enter your local time-zone, which ranges from UTC-12:00 to UTC+13:00.

The detailed information of each time-zone are displayed as follows:

UTC-12:00 — TimeZone for International Date Line West.

UTC-11:00 — TimeZone for Coordinated Universal Time-11.

UTC-10:00 — TimeZone for Hawaii.

UTC-09:00 — TimeZone for Alaska.

UTC-08:00 — TimeZone for Pacific Time (US Canada).

UTC-07:00 — TimeZone for Mountain Time (US Canada).

UTC-06:00 — TimeZone for Central Time (US Canada).

UTC-05:00 — TimeZone for Eastern Time (US Canada).

UTC-04:30 — TimeZone for Caracas.

UTC-04:00 — TimeZone for Atlantic Time (Canada).

UTC-03:30 — TimeZone for Newfoundland.

UTC-03:00 — TimeZone for Buenos Aires, Salvador, Brasilia.

UTC-02:00 — TimeZone for Mid-Atlantic.

UTC-01:00 — TimeZone for Azores, Cape Verde Is.

UTC — TimeZone for Dublin, Edinburgh, Lisbon, London.

UTC+01:00 — TimeZone for Amsterdam, Berlin, Bern, Rome, Stockholm, Vienna.

UTC+02:00 — TimeZone for Cairo, Athens, Bucharest, Amman, Beirut, Jerusalem.

UTC+03:00 — TimeZone for Kuwait, Riyadh, Baghdad.

UTC+03:30 — TimeZone for Tehran.

UTC+04:00 — TimeZone for Moscow, St.Petersburg, Volgograd, Tbilisi, Port Louis.

UTC+04:30 — TimeZone for Kabul.

UTC+05:00 — TimeZone for Islamabad, Karachi, Tashkent.

UTC+05:30 — TimeZone for Chennai, Kolkata, Mumbai, New Delhi.

UTC+05:45 — TimeZone for Kathmandu.

UTC+06:00 — TimeZone for Dhaka, Astana, Ekaterinburg.

UTC+06:30 — TimeZone for Yangon (Rangoon).

UTC+07:00 — TimeZone for Novosibirsk, Bangkok, Hanoi, Jakarta.

UTC+08:00 — TimeZone for Beijing, Chongqing, Hong Kong, Urumqi, Singapore.

UTC+09:00 — TimeZone for Seoul, Irkutsk, Osaka, Sapporo, Tokyo.

UTC+09:30 — TimeZone for Darwin, Adelaide.

UTC+10:00 — TimeZone for Canberra, Melbourne, Sydney, Brisbane.

UTC+11:00 — TimeZone for Solomon Is., New Caledonia, Vladivostok.

UTC+12:00 — TimeZone for Fiji, Magadan, Auckland, Wellington.

UTC+13:00 — TimeZone for Nuku'alofa, Samoa.

ntp-server: Specify the IP address of the primary NTP server.

backup-ntp-server: Specify the IP address of the backup NTP server.

fetching-rate: Specify the interval fetching time from the NTP server.

Step 3 Use the following command to verify the system time information.

show system-time

Verify the system time information.

Use the following command to verify the NTP mode configuration information.

show system-time ntp

Verify the system time information of NTP mode.

Step 4 **end**
Return to privileged EXEC mode.

Step 5 **copy running-config startup-config**
Save the settings in the configuration file.

The following example shows how to set the system time by Get Time from NTP Server and set the time zone as UTC+08:00, set the NTP server as 133.100.9.2, set the backup NTP server as 139.78.100.163 and set the update rate as 11.

Switch#configure

Switch(config)#system-time ntp UTC+08:00 133.100.9.2 139.78.100.163 11

Switch(config)#show system-time ntp

Time zone : UTC+08:00

Prefered NTP server: 133.100.9.2

Backup NTP server: 139.78.100.163

Last successful NTP server: 133.100.9.2

Update Rate: 11 hour(s)

Switch(config)#end

Switch#copy running-config startup-config

2.2.4 Configuring the Daylight Saving Time

Follow these steps to configure the Daylight Saving Time:

Step 1 **configure**

Enter global configuration mode.

Step 2 Use the following command to select a predefined Daylight Saving Time configuration:

system-time dst predefined [USA | Australia | Europe | New-Zealand]

Specify the Daylight Saving Time using a predefined schedule.

USA | Australia | Europe | New-Zealand: Select one mode of Daylight Saving Time.

USA: 02:00 a.m. on the Second Sunday in March ~ 02:00 a.m. on the First Sunday in November.

Australia: 02:00 a.m. on the First Sunday in October ~ 03:00 a.m. on the First Sunday in April.

Europe: 01:00 a.m. on the Last Sunday in March ~ 01:00 a.m. on the Last Sunday in October.

New Zealand: 02:00 a.m. on the Last Sunday in September ~ 03:00 a.m. on the First Sunday in April.

Use the following command to set the Daylight Saving Time in recurring mode:

system-time dst recurring { sweek } { sday } { smonth } { stime } { eweek } { eday } { emonth } { etime } [offset]

Specify the Daylight Saving Time in Recuring mode.

sweek: Enter the start week of Daylight Saving Time. There are 5 values showing as follows: first, second, third, fourth, last.

sday: Enter the start day of Daylight Saving Time. There are 7 values showing as follows: Sun, Mon, Tue, Wed, Thu, Fri, Sat.

smonth: Enter the start month of Daylight Saving Time. There are 12 values showing as follows: Jan, Feb, Mar, Apr, May, Jun, Jul, Aug, Sep, Oct, Nov, Dec.

stime: Enter the start time of Daylight Saving Time, in the format of HH:MM.

ewEEK: Enter the end week of Daylight Saving Time. There are 5 values showing as follows: first, second, third, fourth, last.

eday: Enter the end day of Daylight Saving Time. There are 7 values showing as follows: Sun, Mon, Tue, Wed, Thu, Fri, Sat.

emonth: Enter the end month of Daylight Saving Time. There are 12 values showing as follows: Jan, Feb, Mar, Apr, May, Jun, Jul, Aug, Sep, Oct, Nov, Dec.

etime: Enter the end time of Daylight Saving Time, in the format of HH:MM.

offset: Enter the offset of Daylight Saving Time. The default value is 60.

Use the following command to set the Daylight Saving Time in date mode:

```
system-time dst date { smonth } { sday } { stime } { syear } { emonth } { eday } { etime } { eyear } [ offset ]
```

Specify the Daylight Saving Time in Date mode.

smonth: Enter the start month of Daylight Saving Time. There are 12 values showing as follows: Jan, Feb, Mar, Apr, May, Jun, Jul, Aug, Sep, Oct, Nov, Dec.

sday: Enter the start day of Daylight Saving Time, which ranges from 1 to 31.

stime: Enter the start time of Daylight Saving Time, in the format of HH:MM.

syear: Enter the start year of Daylight Saving Time.

emonth: Enter the end month of Daylight Saving Time. There are 12 values showing as follows: Jan, Feb, Mar, Apr, May, Jun, Jul, Aug, Sep, Oct, Nov, Dec.

eday: Enter the end day of Daylight Saving Time, which ranges from 1 to 31.

etime: Enter the end time of Daylight Saving Time, in the format of HH:MM.

eyear: Enter the end year of Daylight Saving Time.

offset: Enter the offset of Daylight Saving Time. The default value is 60.

Step 3 **show system-time dst**
Verify the DST information of the switch.

Step 4 **end**
Return to privileged EXEC mode.

Step 5 **copy running-config startup-config**
Save the settings in the configuration file.

The following example shows how to set the Daylight Saving Time by Date Mode. Set the start time as 01:00 August 1st, 2017, set the end time as 01:00 September 1st, 2017 and set the offset as 50.

Switch#configure

Switch(config)#system-time dst date Aug 1 01:00 2017 Sep 1 01:00 2017 50

Switch(config)#show system-time dst

DST starts at 01:00:00 on Aug 1 2017

DST ends at 01:00:00 on Sep 1 2017

DST offset is 50 minutes

DST configuration is one-off

Switch(config)#end

Switch#copy running-config startup-config

2.2.5 Configuring LED (Only for Certain Devices)

 **Note:**

LED configuration is only available on certain devices. To check whether your device supports this feature, refer to the actual web interface. If LED configuration is available, there is **SYSTEM > LED On/Off** in the menu structure.

Follow these steps to configure the LED status:

Step 1 **configure**

Enter global configuration mode.

Step 2 **led {on | off}**

Configure the LED status. By default, the LEDs are on.

on | off: Turn on or turn off the LEDs.

3 User Management Configurations

You can create and manage accounts with different access levels to prevent settings from being changed by unauthorized individuals.

3.1 Using the GUI

There are four types of user accounts with different access levels: Admin, Operator, Power User and User.

- There is a default Admin account which cannot be deleted. The default username and password of this account are both admin. You can also create more Admin accounts.
- If you create Operator, Power User or User accounts, you need go to the AAA section to create an Enable Password. If needed, these types of users can use the Enable Password to change their access level to Admin.



3.1.1 Creating Accounts

Choose the menu **SYSTEM > User Management > User Config** to load the following page.

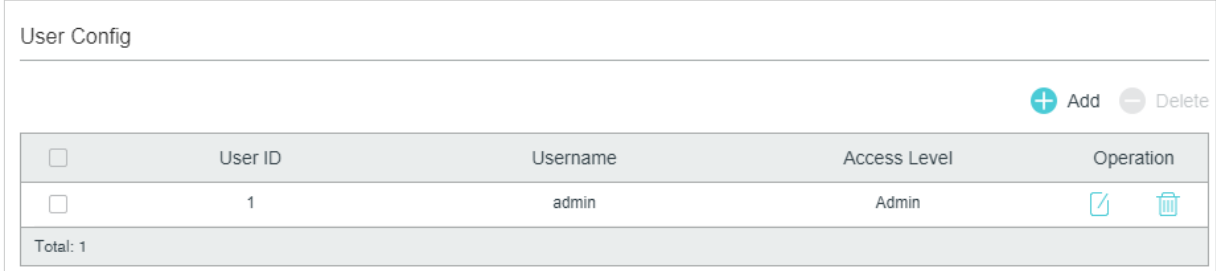
Figure 3-1 User Config Page



The screenshot shows the 'User Config' page. At the top right, there are '+ Add' and '- Delete' buttons. Below is a table with the following data:

<input type="checkbox"/>	User ID	Username	Access Level	Operation
<input type="checkbox"/>	1	admin	Admin	 

Total: 1

By default, there is a default Admin account in the table. You can click  to edit this Admin account but you cannot delete it.

You can create new user accounts. Click  **Add** and the following window will pop up.

Figure 3-2 Adding Account

Follow these steps to create a new user account.

1) Configure the following parameters:

Username	Specify a username for the account. It should contain 16 characters at most, and be composed of digits, English letters and underscores only.
Access Level	Select the access level. There are four options provided: Admin: Admins are able to view and modify all function settings. Operator: Operators are able to view and modify most function settings. Power User: Power Users are able to view and modify limited function settings. User: Users are able only to view function settings without the permission to modify them.
Password	Specify a password for the account.
Confirm Password	Retype the password.

2) Click **Create**.

3.1.2 Configuring Enable Password

Choose the menu **SECURITY > AAA > Global Config** to load the following page.

Figure 3-3 Configure Enable Password

Follow these steps to configure Enable Password:

- 1) Select **Set Password** and specify the enable password in the **Password** field. It should be a string with 31 characters at most, which can contain only English letters (case-sensitive), digits and 17 kinds of special characters. The special characters are **!\$%()'*,-./_{}.**
- 2) Click **Apply**.

Tips:

The logged-in users can enter the Enable Password on this page to get the administrative privileges.

3.2 Using the CLI

There are four types of user accounts with different access levels: Admin, Operator, Power User and User.

- There is a default Admin account which cannot be deleted. The default username and password of this account are both admin. You can also create more Admin accounts.
- If you create Operator, Power User or User accounts, you need go to the AAA section to create an Enable Password. If needed, these types of users can use the Enable Password to change their access level to Admin.

3.2.1 Creating Accounts

Follow these steps to create an account:

Step 1	<p>configure</p> <p>Enter global configuration mode.</p>
Step 2	<p>Use the following command to create an account unencrypted or symmetric encrypted.</p> <p>user name name { privilege admin operator power_user user } password { [0] password 7 encrypted-password }</p> <p>name: Enter a user name for users' login. It contains 16 characters at most, composed of digits, English letters and symbols. No spaces, question marks and double quotation marks are allowed.</p> <p>admin operator power_user user: Specify the access level for the user. Admin can edit, modify and view all the settings of different functions. Operator can edit, modify and view mostly the settings of different functions. Power User can edit, modify and view some of the settings of different functions. User can only view the settings without the right to edit and modify.</p> <p>0: Specify the encryption type. 0 indicates that the password you entered is unencrypted, and the password is saved to the configuration file unencrypted. By default, the encryption type is 0.</p> <p>password: Enter a password for users' login. It contains 6–31 alphanumeric characters (case-sensitive) and symbols. No spaces are allowed.</p>

7: Specify the encryption type. 7 indicates that the password you entered is symmetric encrypted, and the password is saved to the configuration file symmetric encrypted.

encrypted-password: Enter a symmetric encrypted password with fixed length, which you can copy from another switch's configuration file. After the encrypted password is configured, you should use the corresponding unencrypted password to reenter this mode.

Use the following command to create an account MD5 encrypted.

user name name { privilege admin | operator | power_user | user } secret { [0] password | 5 encrypted-password }

Create an account whose access level is Admin.

name: Enter a user name for users' login. It contains 16 characters at most, composed of digits, English letters and symbols. No spaces, question marks and double quotation marks are allowed.

admin | operator | power_user | user: Specify the access level for the user. Admin can edit, modify and view all the settings of different functions. Operator can edit, modify and view mostly the settings of different functions. Power User can edit, modify and view some of the settings of different functions. User can only view the settings without the right to edit and modify.

0: Specify the encryption type. 0 indicates that the password you entered is unencrypted, but the password is saved to the configuration file MD5 encrypted. By default, the encryption type is 0.

password: Enter a password for users' login. It contains 6–31 alphanumeric characters (case-sensitive) and symbols. No spaces are allowed.

5: Specify the encryption type. 5 indicates that the password you entered is MD5 encrypted, and the password is saved to the configuration file MD5 encrypted.

encrypted-password: Enter a MD5 encrypted password with fixed length, which you can copy from another switch's configuration file.

Step 3 **show user account-list**
Verify the information of the current users.

Step 4 **end**
Return to privileged EXEC mode.

Step 5 **copy running-config startup-config**
Save the settings in the configuration file.

3.2.2 Configuring Enable Password

Follow these steps to create an account of other type:

Step 1 **configure**
Enter global configuration mode.

-
- Step 2 Use the following command to create an enable password unencrypted or symmetric encrypted.
- enable admin password { [0] password | 7 encrypted-password }**
- Create an Enable Password. It can change the users' access level to Admin. By default, it is empty.
- 0:** Specify the encryption type. 0 indicates that the password you entered is unencrypted, and the password is saved to the configuration file unencrypted. By default, the encryption type is 0.
- password:** Enter an enable password. It is a string with 31 characters at most, which can contain only English letters (case-sensitive), digits and 17 kinds of special characters. The special characters are **!\$%()*,-./[]_{}.**
- 7:** Specify the encryption type. 7 indicates that the password you entered is symmetric encrypted, and the password is saved to the configuration file symmetric encrypted.
- encrypted-password:** Enter a symmetric encrypted password with fixed length, which you can copy from another switch's configuration file. After the encrypted password is configured, you should use the corresponding unencrypted password to reenter this mode.
- Use the following command to create an enable password unencrypted or MD5 encrypted.
- enable admin secret { [0] password | 5 encrypted-password }**
- Create an Enable Password. It can change the users' access level to Admin. By default, it is empty.
- 0:** Specify the encryption type. 0 indicates that the password you entered is unencrypted, but the password is saved to the configuration file MD5 encrypted. By default, the encryption type is 0.
- password:** Enter an enable password. It is a string with 31 characters at most, which can contain only English letters (case-sensitive), digits and 17 kinds of special characters. The special characters are **!\$%()*,-./[]_{}.**
- 5:** Specify the encryption type. 5 indicates that the password you entered is MD5 encrypted, and the password is saved to the configuration file MD5 encrypted.
- encrypted-password:** Enter a MD5 encrypted password with fixed length, which you can copy from another switch's configuration file. After the encrypted password is configured, you should use the corresponding unencrypted password to reenter this mode.
-
- Step 3 **show user account-list**
Verify the information of the current users.
-
- Step 4 **end**
Return to privileged EXEC mode.
-
- Step 5 **copy running-config startup-config**
Save the settings in the configuration file.
-

Tips:

The logged-in users can enter the **enable-admin** command and the Enable Password to get the administrative privileges.

The following example shows how to create a user with the access level of Operator, set the username as user1 and password as 123, and set the enable password as abc123.

Switch#config

Switch(config)#user name user1 privilege operator password 123

Switch(config)#enable admin password abc123

Switch(config)#show user account-list

Index	User-Name	User-Type
-----	-----	-----
1	user1	Operator
2	admin	Admin

Switch(config)#end

Switch#copy running-config startup-config

4 System Tools Configurations

With System Tools, you can:

- Configure the boot file
- Restore the configuration of the switch
- Back up the configuration file
- Upgrade the firmware
- Configure DHCP Auto Install
- Reboot the switch
- Reset the switch

4.1 Using the GUI

4.1.1 Configuring the Boot File

Choose the menu **SYSTEM > System Tools > Boot Config** to load the following page.

Figure 4-1 Configuring the Boot File

Boot Config

<input type="checkbox"/>	Unit	Current Startup Image	Next Startup Image	Backup Image	Current Startup Config	Next Startup Config	Backup Config
<input type="checkbox"/>	1	image1.bin	image1.bin	image2.bin	config1.cfg	config1.cfg	config2.cfg
Total: 1							

Restore

Image Table

UNIT1

- ▼

Current Startup Image

Image Name:	image1.bin
Software Version:	1.0.0
Flash Version:	1.3.0
- ▼

Next Startup Image

Image Name:	image1.bin
Software Version:	1.0.0
Flash Version:	1.3.0
- ▼

Backup Image

Image Name:	image2.bin
Software Version:	1.0.0
Flash Version:	1.3.0

Follow these steps to configure the boot file:

- 1) In the **Boot Table** section, select one or more units and configure the relevant parameters.

Unit	Displays the number of the unit.
Current Startup Image	Displays the current startup image.
Next Startup Image	Select the next startup image. When the switch is powered on, it will try to start up with the next startup image. The next startup and backup image should not be the same.
Backup Image	Select the backup image. When the switch fails to start up with the next startup image, it will try to start up with the backup image. The next startup and backup image should not be the same.
Current Startup Config	Displays the current startup configuration.
Next Startup Config	Specify the next startup configuration. When the switch is powered on, it will try to start up with the next startup configuration. The next startup configuration and backup configuration should not be the same.
Backup Config	Specify the backup configuration. When the switch fails to start up with the next startup configuration, it will try to start up with the backup configuration. The next startup and backup configuration should not be the same.

- 2) Click **Apply**.

In the Image Table, you can view the information of the current startup image, next startup image and backup image. Click your desired image type and the following information will be displayed:

Image Name	Displays the name of the image.
Software Version	Displays the software version of the image.
Flash Version	Displays the flash version of the image.

4.1.2 Restoring the Configuration of the Switch

Choose the menu **SYSTEM > System Tools > Restore Config** to load the following page.

Figure 4-2 Restoring the Configuration of the Switch

Follow these steps to restore the current configuration of the switch:

- 1) In the **Restore Config** section, select the unit to be restored.
- 2) Click **Browse** and select the desired configuration file to be imported.
- 3) Choose whether to reboot the switch after restoring is completed. Only after the switch is rebooted will the imported configuration take effect.
- 4) Click **Import** to import the configuration file.

Note:

It will take some time to restore the configuration. Please wait without any operation.

4.1.3 Backing up the Configuration File

Choose the menu **SYSTEM > System Tools > Backup Config** to load the following page.

Figure 4-3 Backing up the Configuration File

In the **Config Backup** section, select one unit and click **Export** to export the configuration file.

Note:

It will take some time to export the configuration. Please wait without any operation.

4.1.4 Upgrading the Firmware

Choose the menu **SYSTEM > System Tools > Firmware Upgrade** to load the following page.

Figure 4-4 Upgrading the Firmware

Firmware Upgrade

You can upgrade the firmware of the switch using the new upgrade file.

Firmware Version: 1.0.0 Build 20230725 Rel.35158

Hardware Version: SG6654XHP 1.0

Image Name: Backup Image

Firmware File: Browse

Reboot the switch using the backup image after upgrading is completed.

Upgrade

You can view the current firmware information on this page:

Firmware Version	Displays the current firmware version of the system.
Hardware Version	Displays the current hardware version of the system.
Image Name	Displays the image to upgrade. The operation will only affect the image displayed here.

Follow these steps to upgrade the firmware of the switch:

- 1) Click **Browse** and select the proper firmware upgrade file.
- 2) Choose whether to reboot the switch after upgrading is completed. Only after the switch is rebooted will the new firmware take effect.
- 3) Click **Upgrade** to upgrade the system.

Note:

- It is recommended to back up the configurations before upgrading.
- Select the appropriate upgrade software version that matches your hardware.
- To avoid damage, DO NOT turn off the device while upgrading.

4.1.5 Configuring DHCP Auto Install (Only for Certain Devices)

Note:

DHCP Auto Install is only available on certain devices. To check whether your device supports this feature, refer to the actual web interface. If DHCP Auto Install is available, there is **SYSTEM > System Tools > DHCP Auto Install** in the menu structure.

This feature is used to download configuration files and images from the TFTP server automatically. It requires a TFTP server and a DHCP server that supports option 67,

125 and 150 on your network. When Auto Install function starts, the switch tries to get configuration file name, image file path and TFTP server IP address from the DHCP server, and then downloads the new image and configuration file from the TFTP server. The downloaded configuration file can be saved as a startup configuration file and the downloaded image will update the backup image of the switch.

Choose the menu **SYSTEM > System Tools > DHCP Auto Install** to load the following page.

Figure 4-5 Configuring DHCP Auto Install

DHCP Auto Install

DHCP Auto Install: Enable

Auto Install Persistent Mode: Enable

Auto Save Mode: Enable

Auto Reboot Mode: Enable

Auto Install Retry Count: (1-3)

Auto Install State: Stopped

Apply

Configure the following parameters and click **Apply**:

DHCP Auto Install	Enable or disable DHCP Auto Install.
Auto Install Persistent Mode	Enable or disable Auto Install Persistent Mode. With this mode enabled, the switch will start Auto Install progress once the switch has rebooted.
Auto Save Mode	Enable or disable Auto Save Mode. With this mode enabled, the downloaded configuration file will be saved as the startup configuration file. The downloaded configuration will be effective after the next reboot.
Auto Reboot Mode	Enable or disable Auto Reboot Mode. With this mode enabled, the switch will reboot automatically once the auto install process is complete.
Auto Install Retry Count	Specify how many times the switch can try to get the configuration file or image file from the TFTP server in one cycle. If the number of tries has reached this limit, the switch will wait for 10 minutes before trying to get the files again. This process will be repeated until the switch succeeds in getting either the image file or configuration file, or until you stop Auto Install manually.
Auto Install State	Displays the status of Auto Install process.

For configuration example and detailed instructions, refer to [FAQ](#).

Note:

- If Auto Install fails to get the configuration file, this procedure will be retried every 10 minutes.
- If DHCP Auto Install is enabled and there is no layer 3 interface whose IP address mode is DHCP, the switch will choose a layer 3 interface and change its IP address mode to DHCP.

4.1.6 Rebooting the switch

There are two methods to reboot the switch: manually reboot the switch and configure reboot schedule to automatically reboot the switch.

Manually Rebooting the Switch

Choose the menu **SYSTEM > System Tools > System Reboot > System Reboot** to load the following page.

Figure 4-6 Manually Rebooting the Switch

The screenshot shows the 'System Reboot' configuration page. At the top, it says 'System Reboot'. Below that, there is a 'Target Unit:' label followed by a dropdown menu currently showing 'All Unit'. Underneath the dropdown is a checkbox labeled 'Save the current configuration before reboot' which is currently unchecked. In the bottom right corner, there is a blue button labeled 'Reboot'.

Follow these steps to reboot the switch:

- 1) In the **System Reboot** section, select the desired unit.
- 2) Choose whether to save the current configuration before reboot.
- 3) Click **Reboot**.

Note:

- To avoid damage, DO NOT turn off the device while rebooting.

Configuring Reboot Schedule

Choose the menu **SYSTEM > System Tools > System Reboot > Reboot Schedule** to load the following page.

Figure 4-7 Configuring the Reboot Schedule

The screenshot shows the 'Reboot Schedule Config' page. At the top, it says 'Reboot Schedule Config'. Below that, there is a 'Reboot Schedule:' label followed by a checked checkbox labeled 'Enable'. Underneath, there are two radio button options: 'Time Interval:' (which is selected) and 'Special Time:'. The 'Time Interval:' option has a text input field containing '360' and the unit 'minutes (1-43200)'. The 'Special Time:' option has four dropdown menus: 'Month' (set to 'January'), 'Day' (set to '1'), 'Year' (set to '2000'), and 'Time (HH:MM)'. Below these options is a checkbox labeled 'Save the current configuration before reboot' which is currently unchecked. In the bottom right corner, there is a blue button labeled 'Apply'.

Follow these steps to configure the reboot schedule:

- 1) Enable Reboot Schedule, and select one time schedule for the switch to reboot.

Time Interval	Specify the time interval when the switch will be rebooted. The switch will reboot after this period. Valid values are from 1 to 43200 minutes. To make this schedule recur, you need to click  Save to save current configuration or enable the option Save the current configuration before reboot .
Special Time	Specify the date and time for the switch to reboot. Month/Day/Year: Specify the date for the switch to reboot. Time (HH:MM): Specify the time for the switch to reboot, in the format of HH:MM.
Save the current configuration before reboot	Select whether the configuration of the switch will be saved before reboot.

- 2) Choose whether to save the current configuration before the reboot.
- 3) Click **Apply**.

Tips:

To delete the reboot schedule configurations, you can click **Delete** and the configurations will be empty.

4.1.7 Resetting the Switch

Choose the menu **SYSTEM > System Tools > System Reset** to load the following page.

Figure 4-8 Resetting the Switch

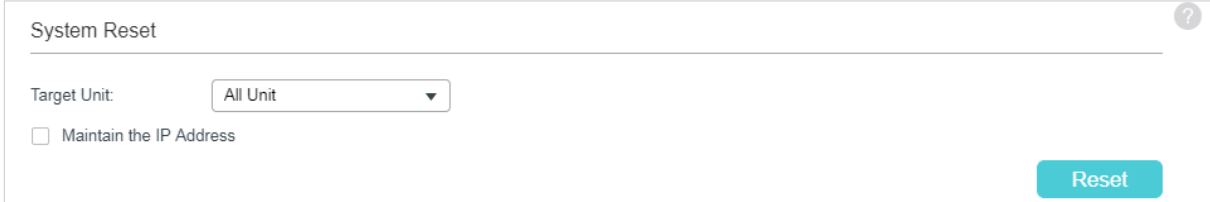

Follow these steps to reset the switch:

- 1) In the **System Reset** section, select the desired unit.
- 2) Choose whether to maintain the IP address of selected unit when resetting.
- 3) Click **Reset**.

After reset, all configurations of the switch will be reset to the factory defaults.

4.2 Using the CLI

4.2.1 Configuring the Boot File

Follow these steps to configure the boot file:

Step 1	configure Enter global configuration mode.
Step 2	boot application filename { image1 image2 } { startup backup } Specify the configuration of the boot file. By default, image1.bin is the startup image and image2.bin is the backup image. image1 image2: Select the image file to be configured. startup backup: Select the property of the image file.
Step 3	boot config filename { config1 config2 } { startup backup } Specify the configuration of the boot file. By default, config1.cfg is the startup configuration file and config2.cfg is the backup configuration file. config1 config2: Select the configuration file to be configured. startup backup: Specify the property of the configuration file.
Step 4	show boot Verify the boot configuration of the system.
Step 5	end Return to privileged EXEC mode.
Step 6	copy running-config startup-config Save the settings in the configuration file.

The following example shows how to set the next startup image as image1, the backup image as image2, the next startup configuration file as config1 and the backup configuration file as config2.

Switch#configure

Switch(config)#boot application filename image1 startup

Switch(config)#boot application filename image2 backup

Switch(config)#boot config filename config1 startup

Switch(config)#boot config filename config2 backup

Switch(config)#show boot

Boot config:

Current Startup Image - image2.bin

```

Next Startup Image      - image1.bin
Backup Image           - image2.bin
Current Startup Config  - config2.cfg
Next Startup Config    - config1.cfg
Backup Config          - config2.cfg

```

```
Switch(config)#end
```

```
Switch#copy running-config startup-config
```

4.2.2 Restoring the Configuration of the Switch

Follow these steps to restore the configuration of the switch:

-
- Step 1 **enable**
Enter privileged mode.
-
- Step 2 **copy tftp startup-config ip-address ip-addr filename name**
Download the configuration file to the switch from TFTP server.
- ip-addr*: Specify the IP address of the TFTP server. Both IPv4 and IPv6 addresses are supported.
- name*: Specify the name of the configuration file to be downloaded.
-

Note:

It will take some time to restore the configuration. Please wait without any operation.

The following example shows how to restore the configuration file named file1 from the TFTP server with IP address 192.168.0.100.

```
Switch>enable
```

```
Switch#copy tftp startup-config ip-address 192.168.0.100 filename file1
```

```
Start to load user config file...
```

```
Operation OK! Now rebooting system...
```

4.2.3 Backing up the Configuration File

Follow these steps to back up the current configuration of the switch in a file:

-
- Step 1 **enable**
Enter privileged mode.
-

Step 2 **copy startup-config tftp ip-address** *ip-addr filename name*

Back up the configuration file to TFTP server.

ip-addr: Specify the IP address of the TFTP server. Both IPv4 and IPv6 addresses are supported.

name: Specify the name of the configuration file to be saved.

The following example shows how to backup the configuration file named file2 to TFTP server with IP address 192.168.0.100.

Switch>enable

Switch#copy startup-config tftp ip-address 192.168.0.100 **filename** file2

Start to backup user config file...

Backup user config file OK.

4.2.4 Upgrading the Firmware

Follow these steps to upgrade the firmware:

Step 1 **enable**

Enter privileged mode.

Step 2 **firmware upgrade tftp ip-address** *ip-addr filename name*

Upgrade the switch's backup image via TFTP server. To boot up with the new firmware, you need to choose to reboot the switch with the backup image.

ip-addr: Specify the IP address of the TFTP server. Both IPv4 and IPv6 addresses are supported.

name: Specify the name of the desired firmware file.

Step 3 Enter Y to continue and then enter Y to reboot the switch with the backup image.

The following example shows how to upgrade the firmware using the configuration file named file3.bin. The TFTP server is 190.168.0.100.

Switch>enable

Switch#firmware upgrade tftp ip-address 192.168.0.100 **filename** file3.bin

It will only upgrade the backup image. Continue? (Y/N):Y

Operation OK!

Reboot with the backup image? (Y/N): Y

4.2.5 Upgrading the MCU-Firmware

Follow these steps to upgrade the MCU-firmware:

Step 1	enable Enter privileged mode.
Step 2	mcu-firmware unit <i>unit id</i> type <i>mcu-type</i> upgrade Upgrade the switch's MCU-firmware online. <i>unit id</i> : Stack unit ID, ranging from 1 to 4. <i>mcu-type</i> : MCU device type, which can be pse, crps, fan, monitor.
Step 3	mcu-firmware type <i>mcu-type</i> version View the MCU version information. <i>mcu-type</i> : MCU device type, which can be pse, crps, fan, monitor.

4.2.6 Configuring DHCP Auto Install (Only for Certain Devices)

Note:

DHCP Auto Install is only available on certain devices. To check whether your device supports this feature, refer to the actual web interface. If DHCP Auto Install is available, there is **SYSTEM > System Tools > DHCP Auto Install** in the menu structure.

This feature is used to download configuration files and images from the TFTP server automatically. It requires a TFTP server and a DHCP server that supports option 67, 125 and 150 on your network. When Auto Install function starts, the switch tries to get configuration file name, image file path and TFTP server IP address from the DHCP server, and then downloads the new image and configuration file from the TFTP server.

Follow these steps to configure the DHCP Auto Install.

Step 1	configure Enter global configuration mode.
Step 2	boot autoinstall persistent-mode Enable the auto install persistent mode. After saving configuration, the switch will start the Auto Install function automatically during next reboot process.
Step 3	boot autoinstall auto-save Enable the auto save mode and the switch will save the configuration file downloaded as startup configuration file automatically.
Step 4	boot autoinstall auto-reboot Enable the auto reboot mode and the switch will reboot automatically after the auto install process is completed successfully.

-
- Step 5 **boot autoinstall retry-count count**
Specify the auto install retry count which ranges from 1 to 3. The default value is 1.
-
- Step 6 **boot autoinstall start**
Start the Auto Install process and the switch will download the configuration file and the backup image automatically.
-
- Step 7 **end**
Return to privileged EXEC mode.
-
- Step 8 **copy running-config startup-config**
Save the settings in the configuration file.
-

 **Note:**

- If Auto Install fails to get the configuration file, this procedure will be retried every 10 minutes.
 - If DHCP Auto Install is enabled and there is no layer 3 interface whose IP address mode is DHCP, the switch will choose a layer 3 interface and change its IP address mode to DHCP.
-

The following example shows how to configure the Auto Install function.

Switch#configure

Switch(config)#boot autoinstall persistent-mode

Switch(config)#boot autoinstall auto-save

Switch(config)#boot autoinstall auto-reboot

Switch(config)#boot autoinstall retry-count 2

Switch(config)#show boot autoinstall

```
Auto Insatll Mode.....Stop
Auto Insatll Persistent Mode.....Enabled
Auto Save Mode.....Enabled
Auto Reboot Mode.....Enabled
Auto Insatll Retry Count.....2
Auto Insatll sate.....Stopped
```

4.2.7 Rebooting the Switch

Manually Rebooting the Switch

Follow these steps to reboot the switch:

Step 1 **enable**
Enter privileged mode.

Step 2 **reboot**
Reboot the switch.

Configuring Reboot Schedule

Follow these steps to configure the reboot schedule:

Step 1 **configure**
Enter global configuration mode.

Step 2 Use the following command to set the interval of reboot:

reboot-schedule in interval [save_before_reboot]

(Optional) Specify the reboot schedule.

interval: Specify a period of time. The switch will reboot after this period. The valid values are from 1 to 43200 minutes.

save_before_reboot: Save the configuration file before the switch reboots. To make this schedule recur, you can add this part to the command.

Use the following command to set the special time of reboot:

reboot-schedule at time [date] [save_before_reboot]

(Optional) Specify the reboot schedule.

time: Specify the time for the switch to reboot, in the format of HH:MM.

date: Specify the date for the switch to reboot, in the format of DD/MM/YYYY. The date should be within 30 days.

save_before_reboot: Save the configuration file before the switch reboots.

If no date is specified, the switch will reboot according to the time you have set. If the time you set is later than the time that this command is executed, the switch will reboot later the same day; otherwise the switch will reboot the next day.

Step 3 **end**
Return to privileged EXEC mode.

Step 4 **copy running-config startup-config**
Save the settings in the configuration file.

The following example shows how to set the switch to reboot at 12:00 on 15/08/2017.

Switch#configure

Switch(config)#reboot-schedule at 12:00 15/08/2017 save_before_reboot

Reboot system at 15/08/2017 12:00. Continue? (Y/N): Y

Reboot Schedule Settings

Reboot schedule at 2017-08-15 12:00 (in 25582 minutes)

Save before reboot: Yes

Switch(config)#end

Switch#copy running-config startup-config

4.2.8 Resetting the Switch

Follow these steps to reset the switch:

Step 1 **enable**

Enter privileged mode.

Step 2 **reset [except-ip]**

Reset the switch, and all configurations of the switch will be reset to the factory defaults.

except-ip: To maintain the IP address when resetting the switch, add this part to the command.

Follow these steps to disable the reset function of console port or reset button:

Step 1 **configure**

Enter global configuration mode.

Step 2 **service reset-disable**

Disable the reset function of console port or reset button. By default, the reset function is enabled.

Note: use the **no service reset-disable** command to enable the reset function of console port.

5 EEE Configuration

Choose the menu **SYSTEM** > **EEE** to load the following page.

Figure 5-1 Configuring EEE

EEE Config		
UNIT1	LAGS	
<input type="checkbox"/>	Port	Status
<input type="checkbox"/>	1/0/1	Disabled
<input type="checkbox"/>	1/0/2	Disabled
<input type="checkbox"/>	1/0/3	Disabled
<input type="checkbox"/>	1/0/4	Disabled
<input type="checkbox"/>	1/0/5	Disabled
<input type="checkbox"/>	1/0/6	Disabled
<input type="checkbox"/>	1/0/7	Disabled
<input type="checkbox"/>	1/0/8	Disabled
<input type="checkbox"/>	1/0/9	Disabled
<input type="checkbox"/>	1/0/10	Disabled
Total: 48		

Follow these steps to configure EEE:

- 1) In the **EEE Config** section, select one or more ports to be configured.
- 2) Enable or disable EEE on the selected port(s).
- 3) Click **Apply**.

5.1 Using the CLI

Follow these steps to configure EEE:

Step 1	configure Enter global configuration mode.
Step 2	interface { fastEthernet port range fastEthernet port-list gigabitEthernet port range gigabitEthernet port-list ten-gigabitEthernet port range ten-gigabitEthernet port-list } Enter interface configuration mode.
Step 3	eee Enable EEE on the port.
Step 4	end Return to privileged EXEC mode.

Step 5 **copy running-config startup-config**

Save the settings in the configuration file.

The following example shows how to enable the EEE feature on port 1/0/1.

Switch#config

Switch(config)#interface gigabitEthernet 1/0/1

Switch(config-if)#eee

Switch(config-if)#show interface eee

Port EEE status

Gi1/0/1 Enable

Gi1/0/2 Disable

...

Switch(config-if)#end

Switch#copy running-config startup-config

6 PoE Configurations (Only for Certain Devices)

 **Note:**

PoE configuration is only available on certain devices. To check whether your device supports this feature, refer to the actual web interface. If PoE configuration is available, there is **SYSTEM > PoE** in the menu structure.

With the PoE feature, you can:

- Configure the PoE parameters manually
- Configure the PoE parameters using the profile
- Configure the PoE Auto Recovery parameters manually

You can configure the PoE parameters one by one via configuring the PoE parameters manually. You can also set a profile with the desired parameters and bind the profile to the corresponding ports to quickly configure the PoE parameters. PoE Auto Recovery uses ping packets to detect the link status between PoE ports and connected PoE powered devices (PDs). The switch pings the IP addresses of PDs constantly. If a PD loses connection, the switch will reboot it automatically.

6.1 Using the GUI

6.1.1 Configuring the PoE Parameters Manually

Choose the menu **SYSTEM > PoE > PoE Config** to load the following page.

Figure 6-1 Configuring PoE Parameters Manually

PoE Config										
Unit	System Power Limit (W)	System Power Consumption (W)	System Power Remain (W)	Operation						
Unit1	800.0	0.0	800.0							
Total: 1										
Port Config										
UNIT1										
<input type="checkbox"/>	Port	PoE Status	PoE Priority	Power Limit	Power Limit Value (0.1-30.0 W)	Time Range	PoE Profile	Power (W)	Current	
<input type="checkbox"/>	1/0/1	Enabled	Low	Class4	30	No Limit	None	0		
<input type="checkbox"/>	1/0/2	Enabled	Low	Class4	30	No Limit	None	0		
<input type="checkbox"/>	1/0/3	Enabled	Low	Class4	30	No Limit	None	0		
<input type="checkbox"/>	1/0/4	Enabled	Low	Class4	30	No Limit	None	0		
<input type="checkbox"/>	1/0/5	Enabled	Low	Class4	30	No Limit	None	0		
<input type="checkbox"/>	1/0/6	Enabled	Low	Class4	30	No Limit	None	0		
<input type="checkbox"/>	1/0/7	Enabled	Low	Class4	30	No Limit	None	0		
<input type="checkbox"/>	1/0/8	Enabled	Low	Class4	30	No Limit	None	0		
<input type="checkbox"/>	1/0/9	Enabled	Low	Class4	30	No Limit	None	0		
<input type="checkbox"/>	1/0/10	Enabled	Low	Class4	30	No Limit	None	0		
Total: 48										

Follow these steps to configure the basic PoE parameters:

- 1) In the **PoE Config** section, you can view the current PoE parameters.

System Power Limit (W)	Specify the maximum power the PoE switch can supply.
System Power Consumption (W)	Displays the real-time system power consumption of the PoE switch.
System Power Remain (W)	Displays the real-time power remained for the connected devices.

In addition, you can click and configure the System Power Limit. Click **Apply**.

Figure 6-2 Configuring System Power Limit

The screenshot shows a configuration window titled "PoE Config". It contains the following fields and buttons:

- Unit:** 1
- System Power Limit:** 800.0 W (1-800)
- Buttons:** Cancel, Save

Unit	Displays the unit ID.
System Power Limit	Specify the maximum power the PoE switch can supply.

2) In the **Port Config** section, select the port you want to configure and specify the parameters. Click **Apply**.

PoE Status	Enable or disable the PoE function for the corresponding port. The port can supply power to the PD when its status is enable.
PoE Priority	Select the priority level for the corresponding port. When the power required exceeds the system power limit, the switch will power off PDs on low-priority ports to ensure stable running of other PDs.
Power Limit	Specify the maximum power the port can supply. The following options are provided: Auto: The switch will allocate a value as the maximum power that the port can supply automatically. Class1: The maximum power that the port can supply is 4 W. Class2: The maximum power that the port can supply is 7 W. Class3: The maximum power that the port can supply is 15.4 W. Class4: The maximum power that the port can supply is 30 W. Class5: The maximum power that the port can supply is 45W. Class6: The maximum power that the port can supply is 60W. Manual: Enter a value manually.
Power Limit Value (0.1–30.0 W)	If you select Manual as Power Limit mode, specify a maximum power supply value in this field. If you select Class1 to Class4 as Power Limit mode, you can view the maximum power supply value in this field.
Time Range	Select a time range. The port will supply power only during the time range. For how to create a time range, refer to Time Range Configuration .

PoE Profile	A quick configuration method for the corresponding ports. Select a profile to use its preset configurations. You will be unable to modify the PoE status, PoE priority or power limit manually. For how to create a profile, refer to Configuring the PoE Parameters Using the Profile .
Power (W)	Displays the real-time power supply of the port.
Current (mA)	Displays the real-time current of the port.
Voltage (V)	Displays the real-time voltage of the port.
PD Class	Displays the class the connected PD belongs to.
Power Status	Displays the real-time power status of the port.

6.1.2 Configuring the PoE Parameters Using the Profile

■ Creating a PoE Profile

Choose the menu **SYSTEM > PoE > PoE Profile** and click  **Add** to load the following page.

Figure 6-3 Creating a PoE Profile

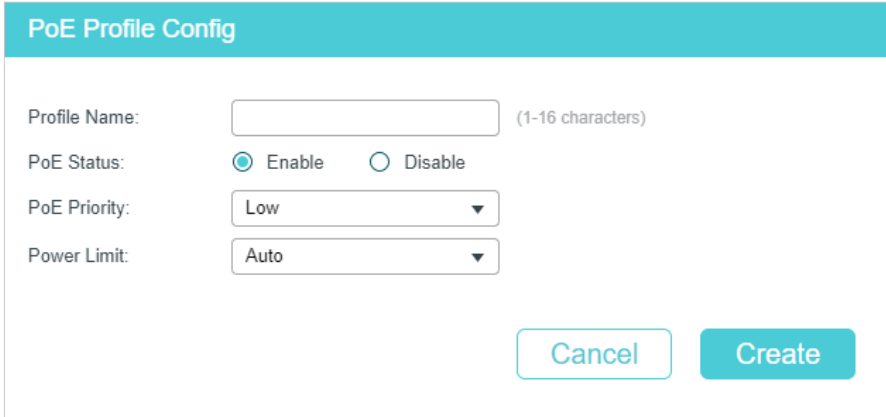

Follow these steps to create a PoE profile:

- 1) In the **PoE Profile Config** section, specify the desired configurations of the profile.

Profile Name	Specify a name for the PoE profile.
PoE Status	Specify the PoE status for the PoE profile.
PoE Priority	Specify the priority level for the PoE profile. The following options are provided: High , Middle and Low . When the supply power exceeds the system power limit, the switch will power off PDs on low-priority ports to ensure stable running of other PDs.
Power Limit	Specify the maximum power the port can supply. The following options are provided: Auto: The switch will allocate a value as the maximum power that the port can supply automatically. Class1: The maximum power that the port can supply is 4W. Class2: The maximum power that the port can supply is 7 W. Class3: The maximum power that the port can supply is 15.4 W. Class4: The maximum power that the port can supply is 30 W. Class5: The maximum power that the port can supply is 45 W. Class6: The maximum power that the port can supply is 60 W. Manual: Enter a value manually.

- 2) Click **Create**.

■ Binding the Profile to the Corresponding Ports

Choose the menu **SYSTEM > PoE > PoE Config** to load the following page.

Figure 6-4 Binding the Profile to the Corresponding Ports

PoE Config									
Unit	System Power Limit (W)	System Power Consumption (W)	System Power Remain (W)	Operation					
Unit1	800.0	0.0	800.0						
Total: 1									

Port Config									
UNIT1									
<input type="checkbox"/>	Port	PoE Status	PoE Priority	Power Limit	Power Limit Value (0.1-30.0 W)	Time Range	PoE Profile	Power (W)	Current
<input type="checkbox"/>	1/0/1	Enabled	Low	Class4	30	No Limit	None	0	
<input type="checkbox"/>	1/0/2	Enabled	Low	Class4	30	No Limit	None	0	
<input type="checkbox"/>	1/0/3	Enabled	Low	Class4	30	No Limit	None	0	
<input type="checkbox"/>	1/0/4	Enabled	Low	Class4	30	No Limit	None	0	
<input type="checkbox"/>	1/0/5	Enabled	Low	Class4	30	No Limit	None	0	
<input type="checkbox"/>	1/0/6	Enabled	Low	Class4	30	No Limit	None	0	
<input type="checkbox"/>	1/0/7	Enabled	Low	Class4	30	No Limit	None	0	
<input type="checkbox"/>	1/0/8	Enabled	Low	Class4	30	No Limit	None	0	
<input type="checkbox"/>	1/0/9	Enabled	Low	Class4	30	No Limit	None	0	
<input type="checkbox"/>	1/0/10	Enabled	Low	Class4	30	No Limit	None	0	
Total: 48									

Follow these steps to bind the profile to the corresponding ports:

- 1) In the **PoE Config** section, you can view the current PoE parameters.

System Power Limit (W)	Specify the maximum power the PoE switch can supply.
System Power Consumption (W)	Displays the real-time system power consumption of the PoE switch.
System Power Remain (W)	Displays the real-time power remained for the connected devices.

In addition, you can click and configure the System Power Limit. Click **Apply**.

Figure 6-5 Configuring System Power Limit

The screenshot shows a configuration window titled "PoE Config". It contains the following fields and controls:

- Unit:** A text field containing the value "1".
- System Power Limit:** A text input field containing "800.0" and a unit selector dropdown showing "W (1-800)".
- Buttons:** Two buttons at the bottom right, "Cancel" (light blue) and "Save" (teal).

Unit	Displays the unit number.
System Power Limit	Specify the maximum power the PoE switch can supply.

- 2) In the **Port Config** section, select one or more ports and configure the following two parameters: Time Range and PoE Profile. Click **Apply** and the PoE parameters of the selected PoE Profile, such as PoE Status and PoE Priority, will be displayed in the table.

PoE Status	Enable or disable the PoE function for the corresponding port. The port can supply power to the PD when its status is enable.
PoE Priority	Select the priority level for the corresponding port. When the power required exceeds the system power limit, the switch will power off PDs on low-priority ports to ensure stable running of other PDs.
Power Limit	<p>Specify the maximum power the port can supply. The following options are provided:</p> <p>Auto: The switch will allocate a value as the maximum power that the port can supply automatically.</p> <p>Class1: The maximum power that the port can supply is 4W.</p> <p>Class2: The maximum power that the port can supply is 7 W.</p> <p>Class3: The maximum power that the port can supply is 15.4 W.</p> <p>Class4: The maximum power that the port can supply is 30 W.</p> <p>Class5: The maximum power that the port can supply is 45 W.</p> <p>Class6: The maximum power that the port can supply is 60 W.</p> <p>Manual: Enter a value manually.</p>
Power Limit Value (0.1–30.0 W)	<p>If you select Manual as Power Limit mode, specify a maximum power supply value in this field.</p> <p>If you select Class1 to Class4 as Power Limit mode, you can view the maximum power supply value in this field.</p>

Time Range	Select a time range. The port will supply power only during the time range. For how to create a time range, refer to Time Range Configuration .
PoE Profile	A quick configuration method for the corresponding ports. Select a profile to use its preset configurations. You will be unable to modify the PoE status, PoE priority or power limit manually.
Power (W)	Displays the real-time power supply of the port.
Current (mA)	Displays the real-time current of the port.
Voltage (V)	Displays the real-time voltage of the port.
PD Class	Displays the class the connected PD belongs to.
Power Status	Displays the real-time power status of the port.

6.1.3 Configuring the PoE Auto Recovery Parameters Manually

Choose the menu **SYSTEM > PoE > PoE Auto Recovery Config** to load the following page.

Figure 6-6 Enabling PoE Auto Recovery

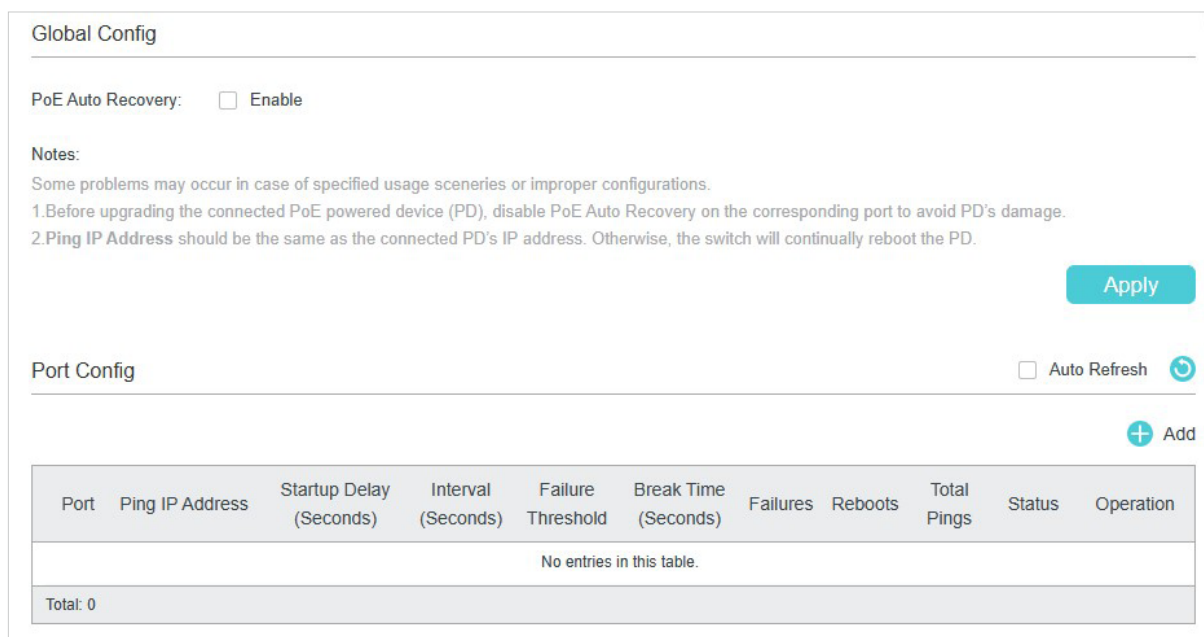

Follow these steps to configure the basic PoE Auto Recovery parameters:

- 1) In the **Global Config** section, you can enable the PoE Auto Recovery function globally.
- 2) In the **Port Config** section, click **Add** to load the following page.

Figure 6-7 Configuring PoE Auto Recovery

PoE Auto Recovery Config

Port:

1

3

5

7

9

11

13

15

17

19

21

23

25

27

29

31

33

35

37

39

41

43

2

4

6

8

10

12

14

16

18

20

22

24

26

28

30

32

34

36

38

40

42

44

45

47

46

48

Selected

Unselected

Not Available

PoE Auto Recovery: Enable

Ping IP Address:

Startup Delay: (30-600)

Interval: (10-120)

Failure Threshold: (1-10)

Break Time: (3-120)

Cancel

Create

Here you can view, add, edit and delete the PoE Auto Recovery entries.

Auto Refresh	When enabled, the switch refreshes the data every 5 seconds so you can get the real-time ping statistics.
Port	Display which port this entry takes effect on.
Ping IP Address	Display the IP address of the PD connected to the port. Make sure the IP address configured here is the same as that of the PD connected to the corresponding port. Otherwise, the switch will continually reboot the PD.
Startup Delay	Display the time that the switch will wait before starting to ping the IP address, which is to reserve time for the connected PD's rebooting. It ranges from 30 to 600 seconds.
Interval	Display the interval between two consecutive ping packets. It ranges from 10 to 120 seconds.
Failure Threshold	Display the threshold that the switch consecutively fails to receive the responses from the PD on the port. Once the failures reach the threshold, the switch will reboot the device. It ranges from 1 to 10.
Break Time	Display the time that the switch powers off the PD after the connection failures it detected have reached Failure Threshold. It ranges from 3 to 120 seconds.
Failures	Display the number of PD's reboots. It will be reset after reaching 9,999 or when the switch is rebooted.
Total Pings	Display the total number of ping packets that the switch sends to the connected PD. It will be reset after reaching 9,999 or when the switch is rebooted.

User Guide ■ 68

Status	Display the status of PoE Auto Recovery on the port. To make it enabled, enable PoE Auto Recovery both globally and on the port.
Operation	Here you can edit or delete the desired entry.

6.2 Using the CLI

6.2.1 Configuring the PoE Parameters Manually

Follow these steps to configure the basic PoE parameters:

Step 1	configure Enter global configuration mode.
Step 2	power inline consumption power-limit Specify the maximum power the PoE switch can supply globally. <i>power-limit</i> : Specify the maximum power the PoE switch can supply.
Step 3	(Optional) power inline unit unit id consumption power-limit Specify the maximum power a stack unit can supply globally. <i>unit id</i> : Stack unit ID <i>power-limit</i> : Specify the maximum power the PoE switch can supply.
Step 4	interface { fastEthernet port range fastEthernet port-list gigabitEthernet port range gigabitEthernet port-list ten-gigabitEthernet port range ten-gigabitEthernet port-list } Enter Interface Configuration mode. <i>port</i> : Specify the Ethernet port number, for example 1/0/1. <i>port-list</i> : Specify the list of Ethernet ports, for example 1/0/1-3, 1/0/5.
Step 5	power inline supply { enable disable } Specify the PoE status for the corresponding port. <i>enable disable</i> : Enable or disable the PoE function. By default, it is enable.
Step 6	power inline priority { low middle high } Specify the PoE priority for the corresponding port. <i>low middle high</i> : Select the priority level for the corresponding port. When the supply power exceeds the system power limit, the switch will power off PDs on low-priority ports to ensure stable running of other PDs. The default setting is low.

-
- Step 7 **power inline consumption { power-limit | auto | class1 | class2 | class3 | class4 }**
 Specify the maximum power the corresponding port can supply.
power-limit | auto | class1 | class2 | class3 | class4: Select or enter the maximum power the corresponding port can supply. The following options are provided: Auto represents that the switch will allocate the maximum power that the port can supply automatically. Class1 represents 4 W, Class2 represents 7W , Class3 represents 15.4 W and Class4 represents 30 W, or you can enter a value manually. The value ranges from 1 to 300. It is in the unit of 0.1 watt. For instance, if you want to configure the maximum power as 5 W, you should enter 50. By default, it is Class4.
-
- Step 8 **power inline time-range name**
 Specify a time range for the port. Then the port will supply power only during the time range. For how to create a time range, refer to [Time Range Configuration](#).
name: Specify the name of the time range.
-
- Step 9 **show power inline**
 Verify the global PoE information of the system.
-
- Step 10 **show power inline configuration interface [fastEthernet { port | port-list } | gigabitEthernet { port | port-list } | ten-gigabitEthernet { port | port-list }]**
 Verify the PoE configuration of the corresponding port.
port: Specify the Ethernet port number, for example 1/0/1.
port-list: Specify the list of Ethernet ports, in the format of 1/0/1-3, 1/0/5.
-
- Step 11 **show power inline information interface [fastEthernet { port | port-list } | gigabitEthernet { port | port-list } | ten-gigabitEthernet { port | port-list }]**
 Verify the real-time PoE status of the corresponding port.
port: Specify the Ethernet port number, for example 1/0/1.
port-list: Specify the list of Ethernet ports, in the format of 1/0/1-3, 1/0/5.
-
- Step 12 **end**
 Return to privileged EXEC mode.
-
- Step 13 **copy running-config startup-config**
 Save the settings in the configuration file.
-

The following example shows how to set the system power limit as 160 W. Set the priority as middle and set the power limit as class3 for the port 1/0/5.

Switch#configure

Switch(config)#power inline consumption 160

Switch(config)#interface gigabitEthernet 1/0/5

Switch(config-if)#power inline supply enable

Switch(config-if)#power inline priority middle

```
Switch(config-if)#power inline consumption class3
```

```
Switch(config-if)#show power inline
```

```
System Power Limit: 160.0w
```

```
System Power Consumption: 0.0w
```

```
System Power Remain: 160.0w
```

```
Switch(config-if)#show power inline configuration interface gigabitEthernet 1/0/5
```

Interface	PoE-Status	PoE-Prio	Power-Limit(w)	Time-Range	PoE-Profile
Gi1/0/5	Enable	Middle	Class3	No Limit	None

```
Switch(config-if)#show power inline information interface gigabitEthernet 1/0/5
```

Interface	Power(w)	Current(mA)	Voltage(v)	PD-Class	Power-Status
Gi1/0/5	1.3	26	53.5	Class 2	ON

```
Switch(config-if)#end
```

```
Switch#copy running-config startup-config
```

6.2.2 Configuring the PoE Parameters Using the Profile

Follow these steps to configure the PoE profile:

Step 1 **configure**

Enter global configuration mode.

Step 2 **power inline consumption power-limit**

Specify the maximum power the PoE switch can supply globally.

power-limit: Specify the maximum power the PoE switch can supply.

Step 3 **power profile name [supply { enable | disable } [priority { low | middle | high } [consumption { power-limit | auto | class1 | class2 | class3 | class4 }]]]**

Create a PoE profile for the switch. In a profile, the PoE status, PoE priority and power limit are configured. You can bind a profile to the corresponding port to quickly configure the PoE function.

name: Specify a name for the PoE profile. It ranges from 1 to 16 characters. If the name contains spaces, enclose the name in double quotes.

enable | disable: Specify the PoE status for the profile. By default, it is enable.

low | middle | high: Select the priority level for the profile. When the supply power exceeds the system power limit, the switch will power off PDs on low-priority ports to ensure stable running of other PDs.

power-limit | auto | class1 | class2 | class3 | class4: Select or enter the maximum power the corresponding port can supply. The following options are provided: Auto represents that the switch will assign a value of maximum power automatically. Class1 represents 4W, Class2 represents 7W, Class3 represents 15.4W and Class4 represents 30W or you can enter a value manually. The value ranges from 1 to 300. It is in the unit of 0.1 watt. For instance, if you want to configure the maximum power as 5W, you should enter 50.

Step 4 **interface { fastEthernet port | range fastEthernet port-list | gigabitEthernet port | range gigabitEthernet port-list | ten-gigabitEthernet port | range ten-gigabitEthernet port-list }**

Enter Interface Configuration mode.

port: Specify the Ethernet port number, for example 1/0/1.

port-list: Specify the list of Ethernet ports, for example 1/0/1-3, 1/0/5.

Step 5 **power inline profile name**

Bind a PoE profile to the desired port. If one profile is selected, you will not be able to modify PoE status, PoE priority or power limit manually.

name: Specify the name of the PoE profile. If the name contains spaces, enclose the name in double quotes.

Step 6 **power inline time-range name**

Specify a time range for the port. Then the port will supply power only during the time range. For how to create a time range, refer to [Time Range Configuration](#).

name: Specify the name of the time range.

Step 7 **show power profile**

Verify the defined PoE profile.

Step 8 **show power inline configuration interface [fastEthernet { port | port-list } | gigabitEthernet { port | port-list } | ten-gigabitEthernet { port | port-list }]**

Verify the PoE configuration of the corresponding port.

port: Specify the Ethernet port number, for example 1/0/1.

port-list: Specify the list of Ethernet ports, in the format of 1/0/1-3, 1/0/5.

Step 9 **show power inline information interface [fastEthernet { port | port-list } | gigabitEthernet { port | port-list } | ten-gigabitEthernet { port | port-list }]**

Verify the real-time PoE status of the corresponding port.

port: Specify the Ethernet port number, for example 1/0/1.

port-list: Specify the list of Ethernet ports, in the format of 1/0/1-3, 1/0/5.

Step 10 **end**

Return to privileged EXEC mode.

Step 11 **copy running-config startup-config**

Save the settings in the configuration file.

The following example shows how to create a profile named profile1 and bind the profile to the port 1/0/6.

Switch#configure

Switch(config)#power profile profile1 supply enable priority middle consumption class2

Switch(config)#show power profile

Index	Name	Status	Priority	Power-Limit(w)
1	profile1	Enable	Middle	Class2

Switch(config)#interface gigabitEthernet 1/0/6

Switch(config-if)#power inline profile profile1

Switch(config-if)#show power inline configuration interface gigabitEthernet 1/0/6

Interface	PoE-Status	PoE-Prio	Power-Limit(w)	Time-Range	PoE-Profile
Gi1/0/6	Enable	Middle	Class2	No Limit	profile1

Switch(config-if)#end

Switch#copy running-config startup-config

7 Management Port Configurations (Only for Certain Devices)

7.1 Using the CLI

Follow these steps to configure the Management Port:

Step 1	configure Enter global configuration mode.
Step 2	management-port protocol {dhcp none} Enable/Disable the IPv4 DHCP function on the management port. <i>dhcp</i> : Enable the DHCP function. <i>none</i> : Disable the DHCP function.
Step 3	management-port ip {ip-addr}{mask} Configure the IPv4 address of the management port. To delete the address, use the no management-port ip command. <i>ip_addr</i> : IPv4 address. <i>mask</i> : IP mask.
Step 4	management-port ipv6 enable Enable the management-port ipv6 function. To disable the function, use the no management-port ipv6 enable command.
Step 5	management-port ipv6 address {ipv6-addr} [eui64] Configure the IPv6 address of the management port. To delete the address, use the no management-port ipv6 address command. <i>ipv6_addr</i> : IPv6 address, you need to specify the prefix length. <i>eui64</i> : Create the address in eui64 mode.
Step 6	show management-port View the configuration information of the management port.
Step 7	end Return to privileged EXEC mode.
Step 8	copy running-config startup-config Save the settings in the configuration file.

The following example shows how to configure the management port.

```
Switch#configure
```

```
Switch(config)#management-port protocol none
```

```
Switch(config)#management-port ip 192.168.10.1 255.255.255.0
```

```
Switch(config)#management-port ipv6 enable
```

```
Switch(config)#management-port ipv6 address 2001::1/64
```

```
Switch(config)#management-port ipv6 address 2001::1/64 eui64
```

```
Switch(config)#show management-port
```

```
Interface Status..... Down
```

```
IP Address..... 192.168.10.1
```

```
Subnet Mask..... 255.255.255.0
```

```
Default Gateway..... 0.0.0.0
```

```
IPv6 Administrative Mode..... Enabled
```

```
IPv6 Prefix is..... 2001::1/64
```

```
Configured IPv4 Protocol..... None
```

```
Configured IPv6 Protocol..... None
```

```
IPv6 AutoConfig Mode..... Disabled
```

```
Burned In MAC Address..... 5c:e9:31:43:31:7b
```

```
Switch(config)#end
```

```
Switch#copy running-config startup-config
```

8 Power Supply Configurations (Only for Certain Devices)

8.1 Using the CLI

8.1.1 Configuring the Power Backup Mode

Follow these steps to configure the power backup mode:

-
- | | |
|--------|--|
| Step 1 | configure
Enter global configuration mode. |
|--------|--|
-
- | | |
|--------|--|
| Step 2 | power backup unit {unit id} {power} mode {mode}
Configure the power backup mode.

<i>unit id</i> : Stack unit ID, ranging from 1-4.
<i>power</i> : power supply module number.
<i>mode</i> : Power backup mode. |
|--------|--|
-
- | | |
|--------|--|
| Step 3 | show power
View the power details. |
|--------|--|
-
- | | |
|--------|---|
| Step 4 | end
Return to privileged EXEC mode. |
|--------|---|
-
- | | |
|--------|---|
| Step 5 | copy running-config startup-config
Save the settings in the configuration file. |
|--------|---|
-

The following example shows how to configure pwr1 of unit 1 as the backup power.

```
Switch#configure
```

```
Switch(config)#power backup unit 1 pwr1 mode enable
```

```
switch(config)#show power
```

```
Switch(config)#end
```

```
Switch#copy running-config startup-config
```

9 SDM Template Configuration

9.1 Using the GUI

Choose the menu **SYSTEM > SDM Template** to load the following page.

Figure 9-1 Configuring SDM Template

SDM Template Config

Current Template: default

Next Template: default

Select Next Template:

[Apply](#)

SDM Template Table

SDM Template	IP ACL Rules	MAC ACL Rules	Combined ACL Rules	IPv6 ACL Rules	IPv4 Source Guard Entries	IPv6 Source Guard Entries
default	300	300	300	0	300	0
enterpriseV4	0	300	500	0	500	0
enterpriseV6	0	200	0	250	0	250
Total: 3						

In **SDM Template Config** section, select one template and click **Apply**. The setting will be effective after the switch is rebooted.

Current Template	Displays the template currently in effect.
Next Template	Displays the template that will take effect after reboot.
Select Next Template	<p>Select the template that will take effect after reboot. You can check the details of the template in template table.</p> <p>Default: It is the default setting. This template gives balance to the IP ACL rules, MAC ACL rules and ARP detection entries.</p> <p>EnterpriseV4: This template maximizes system resources for IP ACL rules and MAC ACL rules.</p> <p>EnterpriseV6: This template allocates resources to IPv6 ACL rules.</p>

You can view the details of each template in the SDM Template Table section.

SDM Template	Displays the name of the template.
IP ACL Rules	Displays the number of IP ACL Rules including layer 3 ACL rules and layer 4 ACL rules.

MAC ACL Rules	Displays the number of layer 2 ACL rules.
Combined ACL Rules	Displays the number of Combined ACL rules.
IPv6 ACL Rules	Displays the number of IPv6 ACL rules.
IPv4 Source Guard Entries	Displays the number of IPv4 Source Guard entries.
IPv6 Source Guard Entries	Displays the number of IPv6 Source Guard entries.

9.2 Using the CLI

Follow these steps to configure the SDM template:

Step 1	configure Enter global configuration mode.
Step 2	show sdm prefer { used default enterpriseV4 enterpriseV6 } View the template table. It will help you determine which template is suitable for your network. used: Displays the resource allocation of the current template. default: Displays the resource allocation of the default template. enterpriseV4: Displays the resource allocation of the enterpriseV4 template. enterpriseV6: Displays the resource allocation of the enterpriseV6 template.
Step 3	sdm prefer { default enterpriseV4 enterpriseV6 } Select the template that will be effective after the switch is rebooted. default: Select the template of default. It gives balance to the IP ACL rules, MAC ACL rules and ARP detection entries. enterpriseV4: Select the template of enterpriseV4. It maximizes system resources for IP ACL rules and MAC ACL rules. enterpriseV6: Select the template of enterpriseV4. It allocates resources to IPv6 ACL rules.
Step 4	end Return to privileged EXEC mode.
Step 5	copy running-config startup-config Save the settings in the configuration file.

The following example shows how to set the SDM template as enterpriseV4.

Switch#config

Switch(config)#show sdm prefer enterpriseV4

"enterpriseV4" template:

number of IP ACL Rules : 120

number of MAC ACL Rules : 84

number of IPV6 ACL Rules : 0

number of IPV4 Source Guard Entries : 253

number of IPV6 Source Guard Entries : 0

Switch(config)#sdm prefer enterpriseV4

Switch to "enterpriseV4" template.

Changes to the running SDM preferences have been stored, but cannot take effect until reboot the switch.

Switch(config)#end

Switch#copy running-config startup-config

10 Time Range Configuration

Time ranges can be referenced by other functions like PoE or ACL rules, which can decide the effective time period of the functions. To complete Time Range configuration, follow these steps:

- 1) Add time range entries.
- 2) Configure Holiday time range.

10.1 Using the GUI

10.1.1 Adding Time Range Entries

Choose the menu **SYSTEM > Time Range > Time Range Config** and click  Add to load the following page.



Figure 10-1 Configuring Time Range

Time-Range Config

Name: (1-16 characters)

Holiday: Exclude Include

Period Time Config

 Add  Delete

<input type="checkbox"/>	Index	Date	Day	Time	Operation
No entries in this table.					
Total: 0					

Follow these steps to add time range entries:

- 1) In the **Time-Range Config** section, specify a name for the entry and select the Holiday mode.

Name	Specify a name for the entry.
Holiday	Select to include or exclude the holiday in the time range. Exclude: The time range will not take effect on holidays. Include: The time range will still take effect on holidays. To configure Holiday, refer to Configuring Holiday .

- 2) In the **Period Time Config** section, click  **Add** and the following window will pop up.

Figure 10-2 Adding Period Time

Period Time Config

Date

From Month: Day: Year:

To Month: Day: Year:

Time

From: (Format: HH:MM)

To: (Format: HH:MM)

Day of Week

Mon Tue Wed Thu Fri Sat Sun

Configure the following parameters and click **Create**:

Date	Specify the start date and end date for this time range.
Time	Specify the start time and end time each day for this time range.
Day of Week	Select the days of the week for this time range.

- 3) Similarly, you can add more entries of period time according to your needs. The final period time is the sum of all the periods in the table. Click **Create**.

Figure 10-3 View Configuration Result

Time-Range Config

Name: (1-16 characters)

Holiday: Exclude Include

Period Time Config

+ Add - Delete

<input type="checkbox"/>	Index	Date	Day	Time	Operation
<input type="checkbox"/>	0	January 1, 2023 - January 1, 2024	Mon, Tue, Wed, Thu, Fri	08:00 - 20:00	✎ 🗑
Total: 0					

Discard
Create

10.1.2 Configuring Holiday

Choose the menu **SYSTEM > Time Range > Holiday Config** and click + Add to load the following page.

Figure 10-1 Configuring Holiday

Holiday Config

Holiday Name: (1-16 characters)

Start Date

Month: Day:

End Date

Month: Day:

Cancel
Create

Configure the following parameters and click **Create** to add a Holiday entry.

Holiday Name	Specify a name for the entry.
Start Date	Specify the start date of the Holiday time range.
End Date	Specify the end date of the Holiday time range.

Similarly, you can add more Holiday entries. The final Holiday time range is the sum of all the entries.

10.2 Using the CLI

10.2.1 Adding Time Range Entries

Follow these steps to add time range entries:

Step 1	configure Enter global configuration mode.
Step 2	time-range name Create a time-range entry. <i>name</i> : Specify a name for the entry.
Step 3	holiday { exclude include } Include or exclude the holiday in the time range. <i>exclude</i> : The time range will not take effect on holiday. <i>include</i> : The time range will not be affected by holiday. To configure Holiday, refer to Configuring Holiday .
Step 4	absolute from start-date to end-date Specify the start date and end date of this time range. <i>start-date</i> : Specify the start date in the format MM/DD/YYYY. <i>end-date</i> : Specify the end date in the format MM/DD/YYYY.
Step 5	periodic start start-time end end-time day-of-the-week week-day Specify days of a week as the period of this time range. <i>start-time</i> : Specify the start end time of a day in the format HH:MM. <i>end-time</i> : Specify the end time and end time of a day in the format HH:MM. <i>week-day</i> : Specify the days of week in the format of 1-3, 7. The numbers 1-7 respectively represent Monday, Tuesday, Wednesday, Thursday, Friday, Saturday and Sunday.
Step 6	show time-range View the configuration of Time Range.
Step 7	end Return to privileged EXEC mode.
Step 8	copy running-config startup-config Save the settings in the configuration file.

The following example shows how to create a time range entry and set the name as time1, holiday mode as exclude, absolute time as 10/01/2017 to 10/31/2017 and periodic time as 8:00 to 20:00 on every Monday and Tuesday:

Switch#config

Switch(config)#time-range time1

Switch(config-time-range)#holiday exclude

Switch(config-time-range)#absolute from 12/01/2023 to 12/31/2023

Switch(config-time-range)#periodic start 08:00 end 20:00 **day-of-the-week** 1,2

Switch(config-time-range)#show time-range

Time-range entry: 12 (Inactive)

Time-range entry: time1 (Inactive)

holiday: exclude

number of time slice: 1

01 - 12/01/2023 to 12/31/2023

- 08:00 to 20:00 on 1,2

Switch(config-time-range)#end

Switch#copy running-config startup-config

10.2.2 Configuring Holiday

Follow these steps to configure Holiday time range:

-
- | | |
|--------|---|
| Step 1 | <p>configure</p> <p>Enter global configuration mode.</p> |
|--------|---|
-
- | | |
|--------|---|
| Step 2 | <p>holiday <i>name</i> start-date <i>start-date</i> end-date <i>end-date</i></p> <p>Create a holiday entry.</p> <p><i>name</i>: Specify a name for the entry.</p> <p><i>start-date</i> : Specify the start date in the format MM/DD.</p> <p><i>end-date</i>: Specify the end date in the format MM/DD.</p> |
|--------|---|
-
- | | |
|--------|--|
| Step 3 | <p>show holiday</p> <p>View the configuration of Holiday.</p> |
|--------|--|
-
- | | |
|--------|--|
| Step 4 | <p>end</p> <p>Return to privileged EXEC mode.</p> |
|--------|--|
-

Step 8 **copy running-config startup-config**

Save the settings in the configuration file.

The following example shows how to create a holiday entry and set the entry name as holiday1 and set start date and end date as 07/01 and 09/01:

Switch#config**Switch(config)#holiday** holiday1 **start-date** 07/01 **end-date** 09/01**Switch(config)#show holiday**

Index	Holiday Name	Start-End
-----	-----	-----
1	holiday1	07.01-09.01

Switch(config)#end**Switch#copy running-config startup-config**

11 Controller Settings (Only for Certain Devices)

Note:

Controller Settings is only available on certain devices. To check whether your device supports this feature, refer to the actual web interface. If Controller Settings is available, there is **SYSTEM > Controller Settings** in the menu structure.

This feature prepares the switch for Omada SDN Controller Management in either of the following scenarios:

- If you are using Omada Cloud-Based Controller, enable Cloud-Based Controller Management on this page, then you can further add your devices to your Omada Cloud-Based Controller.
- If your switch and Omada SDN Controller are located on the same subnet, the controller can discover and manage the switch without any controller settings. Otherwise, you need to inform the switch of the controller's URL/IP address.

11.1 Using the GUI

11.1.1 Enabling Cloud-Based Controller Management

Choose the menu **SYSTEM > Controller Settings** to load the following page. In the **Cloud-Based Controller Management** section, enable Cloud-Based Controller Management and click **Apply**. After you add the switch to your Omada Cloud-Based Controller, you can check the connection status on this page.

Figure 11-1 Enabling Cloud-Based Controller Management

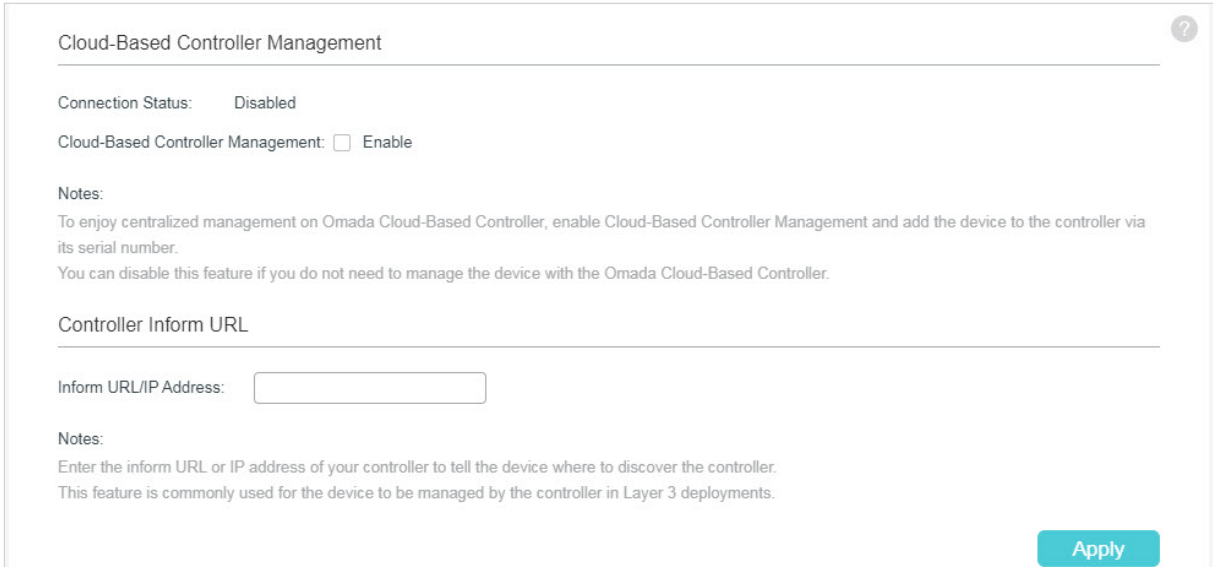

The screenshot shows a web interface for "Cloud-Based Controller Management". At the top right is a help icon (question mark). The "Connection Status" is "Disabled". Below it, "Cloud-Based Controller Management" is set to "Enable" with an unchecked checkbox. A "Notes" section contains two paragraphs: "To enjoy centralized management on Omada Cloud-Based Controller, enable Cloud-Based Controller Management and add the device to the controller via its serial number." and "You can disable this feature if you do not need to manage the device with the Omada Cloud-Based Controller." Below this is a section for "Controller Inform URL" with a text input field for "Inform URL/IP Address:". A second "Notes" section states: "Enter the inform URL or IP address of your controller to tell the device where to discover the controller. This feature is commonly used for the device to be managed by the controller in Layer 3 deployments." An "Apply" button is located at the bottom right.

11.1.2 Configuring Controller Inform URL

Choose the menu **SYSTEM > Controller Settings** to load the following page. In the **Cloud-Based Controller Management** section, check **Enable** and accept the Terms of Use and the Privacy Policy. In the **Controller Inform URL** section, inform the switch of the controller's URL/IP address, and click **Apply**.

Figure 11-1 Configuring Controller Inform URL

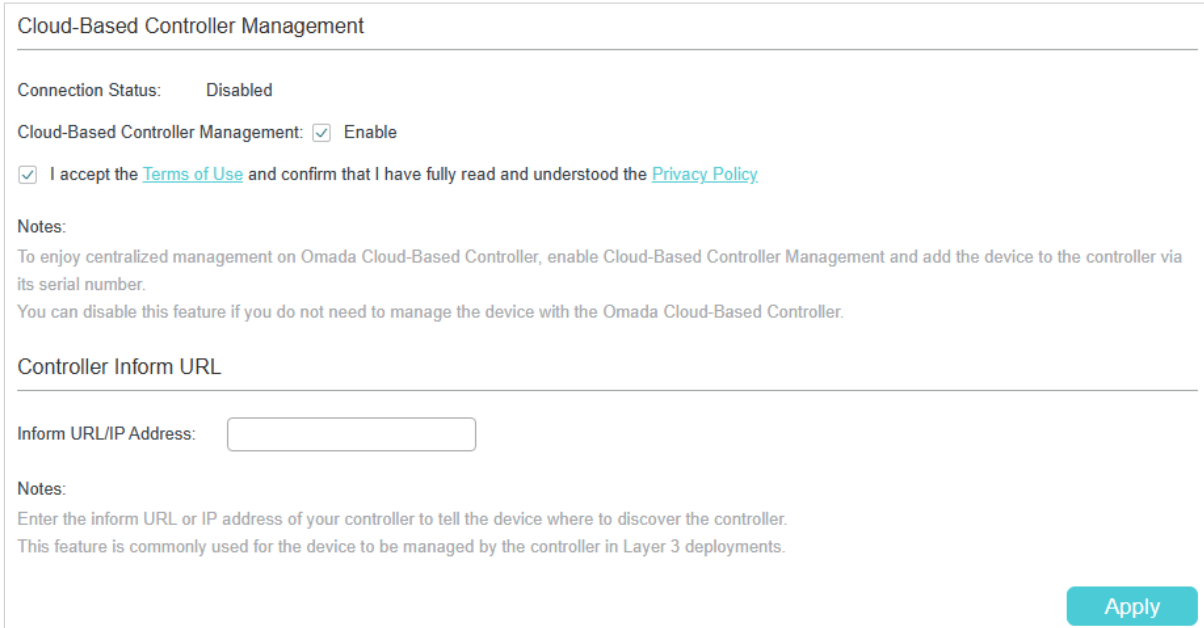

The screenshot shows a web interface for configuring controller settings. It is divided into two main sections: "Cloud-Based Controller Management" and "Controller Inform URL".

Cloud-Based Controller Management

- Connection Status: Disabled
- Cloud-Based Controller Management: Enable
- I accept the [Terms of Use](#) and confirm that I have fully read and understood the [Privacy Policy](#).
- Notes:**
To enjoy centralized management on Omada Cloud-Based Controller, enable Cloud-Based Controller Management and add the device to the controller via its serial number.
You can disable this feature if you do not need to manage the device with the Omada Cloud-Based Controller.

Controller Inform URL

- Inform URL/IP Address:
- Notes:**
Enter the inform URL or IP address of your controller to tell the device where to discover the controller.
This feature is commonly used for the device to be managed by the controller in Layer 3 deployments.

An "Apply" button is located at the bottom right of the form.

11.2 Using the CLI

11.2.1 Enabling Cloud-Based Controller Management

Follow these steps to enable cloud-based controller management:

Step 1	configure Enter global configuration mode.
Step 2	controller cloud-based Enable cloud-based controller management.
Step 3	show controller View the controller settings and status.

11.2.2 Configuring Controller Inform URL

Follow these steps to configure controller inform URL:

-
- Step 1 **configure**
Enter global configuration mode.
-
- Step 2 **controller inform-url [controller-url | controller-ip]**
Inform the switch of the controller's URL/IP address.
-
- Step 3 **show controller**
View the controller settings and status.
-

The following example shows how to inform the switch of the controller whose IP address is 192.168.1.1:

Switch#config

Switch(config)#controller inform-url 192.168.1.1

Switch(config)#show controller

Cloud-Based Controller Management : Disabled

Connection Status : Disabled

Cloud-Based Privacy Policy : Enabled

Inform URL/IP Address :

192.168.1.1?dPort=29810&mPort=0&omadaId=c21f969b5f03d33d43e04f8f136e7682

12 File System Configurations

12.1 Using the CLI

12.1.1 Configuring the File System

Follow these instructions to configure the file system:

Function 1 **copy** {flash|usbflash1|usbflash2} {filename} {destination}

Copy the specified file.

flash|usbflash1|usbflash2: The flash type of the source file.

filename: File name.

destination: Copied file path.

Function 2 **cd** {filename|flash|usbflash1|usbflash2} [filename]

Change the current file path.

filename|flash|usbflash1|usbflash2: The path that needs to be switched. If you enter filename, the file will be found in the current path by default.

filename: Specify the file in the corresponding flash.

Function 3 **dir** [flash|usbflash1|usbflash2] [filename]

List files and subdirectories contained in the specified working directory.

flash|usbflash1|usbflash2: Specify path.

filename: Specify the file in the corresponding flash.

Function 4 **pwd**

Display the absolute path name of the current working directory.

Function 5 **rename** {srcFilename} {dstFilename}

Rename a file.

srcFilename: Source file name.

dstFilename: Renamed file name.

Function **delete** {filename|flash|usbflash1|usbflash2} [filename]

6 Delete a file.

filename|flash|usbflash1|usbflash2: The file that needs to be deleted. If you enter filename, the file will be found in the current working path by default.

filename: Specify the file in the corresponding flash.

13 FTP, SFTP and SCP Configurations

13.1 Using the CLI

13.1.1 Using the FTP

Follow these steps to use the FTP (File Transfer Protocol):

Step 1	ftp Enter the FTP view
Step 2	open [ipv6] {hostIp} Connect to FTP server. ipv6: Specify the FTP server type as IPv6. hostIp: FTP server IP.
Step 3	put {srcFilename} {dstFilename} Upload files to FTP server. srcFilename: Source file name. dstFilename: Renamed file name.
Step 4	get {srcFilename} {dstFilename} Download files from FTP server. srcFilename: Source file name. dstFilename: Renamed file name.
Step 5	close Close current FTP connection.

The following example shows how to use the FTP:

```
Switch#configure
```

```
Switch(config)#ftp
```

```
Switch(ftp)#open 192.168.0.146
```

```
Switch(ftp)#open 192.168.0.146
```

```
Switch(ftp)#put src.c dst.c
```

```
Switch(ftp)#get src.c dst.c
```

```
Switch(ftp)#close
```

13.1.2 Using the SFTP

Follow these steps to use the SFTP (Secure File Transfer Protocol):

-
- Step 1 **sftp {open} {hostIp} {username}**
Connect to SFTP server.
- open**: Establish a connection to the server.
- hostIp**: SFTP server name.
- username**: SFTP server IP.
-
- Step 2 **sftp {get | put} {srcFileName} {dstFileName}**
Connect to SFTP server.
- get | put**: Download/Upload files from/to SFTP server
- srcFilename**: Source file name.
- dstFilename**: Destination file name.
-

The following example shows how to use the SFTP:

```
Switch#sftp open 192.168.0.10 admin
```

```
Switch#sftp get test1.txt test2.txt
```

13.1.3 Using the SCP

Follow these steps to use the SCP (Secure Copy):

-
- Step 1 **scp {get | put} {username} {serverIp} {srcFileName} {dstFileName}**
Connect to SFTP server.
- get | put**: Download/Upload files from/to SFTP server
- username**: SCP server IP
- serverIp**: SCP server IP.
- srcFilename**: Source file name.
- dstFilename**: Destination file name.
-

The following example shows how to use the SFTP:

```
Switch#scp get admin 1.1.1.1 test1.txt test2.txt
```

14 Example for PoE Configurations

14.1 Network Requirements

The network topology of a company is shown as below. Camera1 and Camera2 work for the security of the company and cannot be power off all the time. AP1 and AP2 provide the internet service and only work in the office time.

Figure 14-1 Network Topology

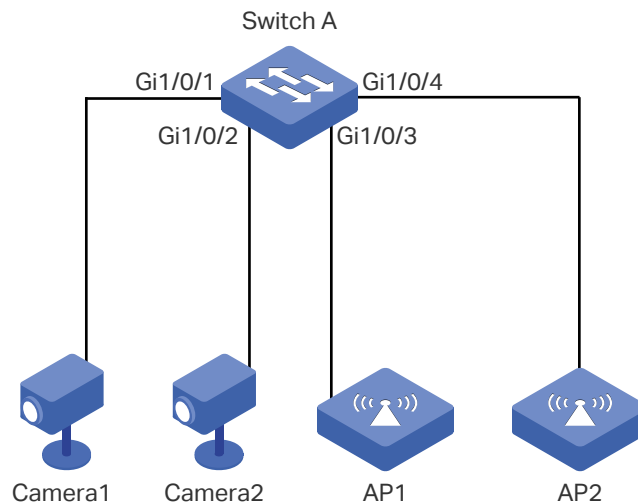

14.2 Configuring Scheme

To implement this requirement, you can set a PoE time-range as the office time, for example, from 08:30 to 18:00 on work days. Then apply the settings to port 1/0/3 and 1/0/4. Port 1/0/1 and port 1/0/2 need to supply power all the time, so the time range configurations can be left as the default settings here.

14.3 Using the GUI

The configurations of port 1/0/4 is similar with the configurations of port 1/0/3. Here we take port 1/0/3 for example.

- 1) Choose the menu **SYSTEM > Time Range > Time Range Create** and click  Add to load the following page.

Figure 14-2 Creating Time Range

Time-Range Config

Name: (1-16 characters)

Holiday: Exclude Include

Period Time Config

<input type="checkbox"/>	ID	Date	Day	Time	Operation
No entries in this table.					
Total: 0					

- 2) Click and the following window will pop up. Set **Date**, **Time** and **Day** of Week as the following figure shows. Click **Create**.

Figure 14-3 Creating a Periodic Time

Period Time Config

Date

From:
 Month: Day: Year:

To:
 Month: Day: Year:

Time

From: 08:30 (Format: HH:MM)

To: 18:00 (Format: HH:MM)

Day of Week

Mon Tue Wed Thu Fri
 Sat Sun

- 3) Specify a name for the time range. Click **Create**.

Figure 14-4 Configuring Time Range

Time-Range Config

Name: (1-16 characters)

Holiday: Exclude Include

Period Time Config

+ Add - Delete

<input type="checkbox"/>	ID	Date	Day	Time	Operation
<input type="checkbox"/>	0	January 1, 2017 - January 1, 2018	Mon,Tue,Wed,Thu,Fri	08:30 - 18:00	
Total: 0					

- 4) Choose the menu **SYSTEM > PoE > PoE Config** to load the following page. Select port 1/0/3 and set the **Time Range** as OfficeTime. Click **Apply**.

Figure 14-5 Configure the Port

PoE Config

Unit	System Power Limit (W)	System Power Consumption (W)	System Power Remain (W)	Operation
Unit1	192.0	0.0	192.0	
Total: 1				

Port Config

UNIT1

<input type="checkbox"/>	Port	PoE Status	PoE Priority	Power Limit	Power Limit Value (0.1-30.0 W)	Time Range	PoE Profile	Power (W)	Current
<input type="checkbox"/>	1	Enabled	Low	Class4	30	No Limit	None	0	
<input type="checkbox"/>	2	Enabled	Low	Class4	30	No Limit	None	0	
<input checked="" type="checkbox"/>	3	Enabled	Low	Class4	30	OfficeTime	None	0	
<input type="checkbox"/>	4	Enabled	Low	Class4	30	No Limit	None	0	
<input type="checkbox"/>	5	Enabled	Low	Class4	30	No Limit	None	0	
<input type="checkbox"/>	6	Enabled	Low	Class4	30	No Limit	None	0	
<input type="checkbox"/>	7	Enabled	Low	Class4	30	No Limit	None	0	
<input type="checkbox"/>	8	Enabled	Low	Class4	30	No Limit	None	0	
<input type="checkbox"/>	9	Enabled	Low	Class4	30	No Limit	None	0	
<input type="checkbox"/>	10	Enabled	Low	Class4	30	No Limit	None	0	

Total: 24 1 entry selected.

- 5) Click Save to save the settings.

14.4 Using the CLI

The configurations of Port1/0/4 is similar with the configuration of port 1/0/3. Here we take port 1/0/3 for example.

- 1) Create a time-range.

```
Switch_A#config
```

```
Switch_A(config)#time-range office-time
```

```
Switch_A(config-time-range)#holiday exclude
```

```
Switch_A(config-time-range)#absolute from 01/01/2023 to 01/01/2024
```

```
Switch_A(config-time-range)#periodic start 08:30 end 18:00 day-of-the-week 1-5
```

```
Switch_A(config-time-range)#exit
```

- 2) Enable the PoE function on the port 1/0/3. Specify the basic parameters for the port 1/0/3 and bind the time-range office-time to the port.

```
Switch_A(config)#interface gigabitEthernet 1/0/3
```

```
Switch_A(config-if)#power inline supply enable
```

```
Switch_A(config-if)#power inline time-range office-time
```

```
Switch_A(config-if)#end
```

```
Switch_A#copy running-config startup-config
```

Verify the Configuration

Verify the configuration of the time-range:

```
Switch_A#show time-range
```

```
Time-range entry: office-time (Active)
```

```
holiday: exclude
```

```
number of time slice: 1
```

```
01 - 01/01/2023 to 01/01/2024
```

```
- 08:00 to 18:00 on 1,2,3,4,5
```

Verify the configuration of the PoE basic parameters:

```
Switch_A#show power inline configuration interface gigabitEthernet 1/0/3
```

Interface	PoE-Status	PoE-Prio	Power-Limit(w)	Time-Range	PoE-Profile
-----	-----	-----	-----	-----	-----
Gi1/0/3	Enable	Low	Class4	office-time	None

15 Appendix: Default Parameters

Default settings of System Info are listed in the following tables.

Table 15-1 Default Settings of Device Description Configuration

Parameter	Default Setting
Device Name	The model name of the switch
Device Location	Hong Kong
System Contact	www.tp-link.com

Table 15-2 Default Settings of System Time Configuration

Parameter	Default Setting
Time Source	Manual

Table 15-3 Default Settings of Daylight Saving Time Configuration

Parameter	Default Setting
DST status	Disabled

Default settings of User Management are listed in the following table.

Table 15-4 Default Settings of User Configuration

Parameter	Default Setting
User Name	admin
Password	admin
Access Level	Admin

Default settings of System Tools are listed in the following table.

Table 15-5 Default Settings of Boot Configuration

Parameter	Default Setting
Current Startup Image	image1.bin
Next Startup Image	image1.bin
Backup Image	image2.bin
Current Startup Config	config1.cfg
Next Startup Config	config1.cfg

Parameter	Default Setting
Backup Config	config2.cfg

Default setting of EEE is listed in the following table.

Table 15-6 Default Settings of EEE Configuration

Parameter	Default Setting
Status	Disabled

(Only for certain devices) Default settings of PoE is listed in the following table.

Table 15-7 Default Settings of PoE Configuration

Parameter	Default Setting
PoE Config	
System Power Limit	(Refer to the actual web interface)
Port Config	
PoE Status	Enabled
PoE Priority	Low
Power Limit (0.1w-30.0w)	Class 4
Time Range	No Limit
PoE Profile	None
Profile Config	
Profile Name	None
PoE Status	Enabled
PoE Priority	Low
Power Limit	Auto

Default settings of SDM Template are listed in the following table.

Table 15-8 Default Settings of SDM Template Configuration

Parameter	Default Setting
Current Template ID	Default
Next Template ID	Default

Default settings of Time Range are listed in the following table.

Table 15-9 Default Settings of Time Range Configuration

Parameter	Default Setting
Holiday	Include

Part 3

Managing Physical Interfaces

CHAPTERS

1. Physical Interface
2. Basic Parameters Configurations
3. Port Isolation Configurations
4. Loopback Detection Configuration
5. Configuration Examples
6. Configuring Management Port
7. Configuring RSPAN Monitoring
8. Appendix: Default Parameters

1 Physical Interface

1.1 Overview

Interfaces are used to exchange data and interact with interfaces of other network devices. Interfaces are classified into physical interfaces and layer 3 interfaces.

- Physical interfaces are the ports on the switch panel. They forward packets based on MAC address table.
- Layer 3 interfaces are used to forward IPv4 and IPv6 packets using static or dynamic routing protocols. You can use Layer 3 interfaces for IP routing and inter-VLAN routing.

This chapter introduces the configurations for physical interfaces.

1.2 Supported Features

The switch supports the following features about physical interfaces:

Basic Parameters

You can configure port status, speed mode, duplex mode, flow control and other basic parameters for ports.

Port Isolation

You can use this feature to restrict a specific port to sending packets to only the ports in a configured forwarding port list.

Loopback Detection

This function allows the switch to detect loops that occur on a specific port. When a loop is detected on a port, the switch will display an alert on the management interface and block the corresponding port according to your configurations.

2 Basic Parameters Configurations

2.1 Using the GUI

Choose the menu **L2 FEATURES > Switching > Port > Port Config** to load the following page.

Figure 2-1 Configuring Basic Parameters

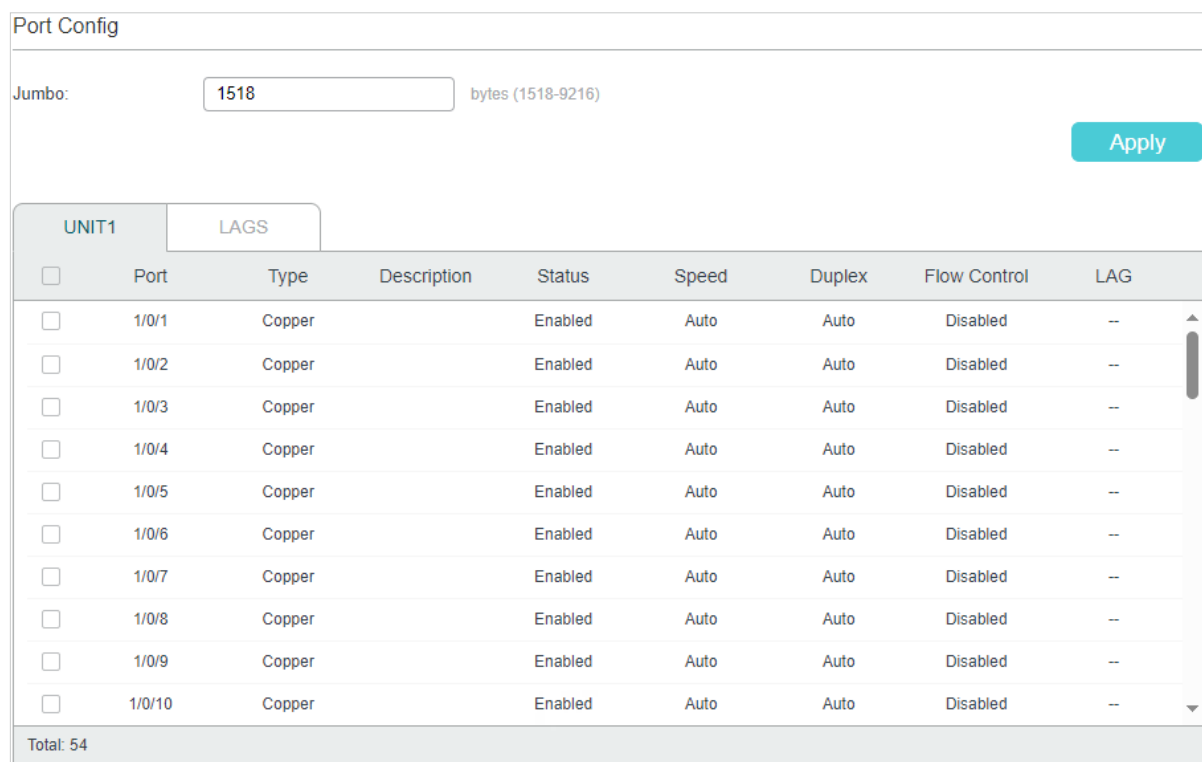

Follow these steps to configure basic parameters for the ports:

- 1) Configure the MTU size of jumbo frames for all the ports, then click **Apply**.

Jumbo	Configure the size of jumbo frames. By default, it is 1518 bytes. Generally, the MTU (Maximum Transmission Unit) size of a normal frame is 1518 bytes. If you want the switch supports to transmit frames of which the MTU size is greater than 1518 bytes, you can configure the MTU size manually here.
--------------	--

- 2) Select one or more ports to configure the basic parameters. Then click **Apply**.

UNIT/LAGS	Click the UNIT number to configure physical ports. Click LAGS to configure LAGs.
Type	Displays the medium type of the port. Copper indicates an Ethernet port, and Fiber indicates an SFP port.
Description	(Optional) Enter a description for the port.

Status	With this option enabled, the port forwards packets normally. Otherwise, the port cannot work. By default, it is enabled.
Speed	Choose the speed mode of the port. You can select ' Auto ', or manually specify the speed mode. ' Auto ' means the speed will be automatically determined by auto-negotiation. The device connected to the port should be in the same speed and duplex mode as the port.
Duplex	Choose the duplex mode of the port. There are three options: Half , Full and Auto . The default setting is Auto . Half : The port can send and receive packets, but only one-way at a time. Full : The port can send and receive packets simultaneously. Auto : The port automatically negotiates duplex mode with the peer device.
Flow Control	With this option enabled, when a device gets overloaded it will send a PAUSE frame to notify the peer device to stop sending data for a specified period of time, thus avoiding the packet loss caused by congestion.
LAG	Displays the LAG that the port belongs to.

 **Note:**

If the port is a member port of an LAG, it will follow the port configuration of the LAG and not its own.

2.2 Using the CLI

Follow these steps to set basic parameters for the ports.

Step 1	configure Enter global configuration mode.
Step 2	jumbo-size size Change the MTU (Maximum Transmission Unit) size to support jumbo frames. The default MTU size for frames received and sent on all ports is 1518 bytes. To transmit jumbo frames, you can manually configure MTU size of frames up to 9216 bytes. <i>size</i> : Configure the MTU size of jumbo frames. The value ranges from 1518 to 9216bytes.
Step 3	interface {vlan vid fastEthernet port range fastEthernet port-list gigabitEthernet port range gigabitEthernet port-list ten-gigabitEthernet port range ten-gigabitEthernet port-list port-channel port-channel range port-channel port-channel-list } Enter interface configuration mode.

Step 4	<p>Configure basic parameters for the port:</p> <p>description <i>string</i></p> <p>Give a port description for identification.</p> <p><i>string</i>: Content of a port description, ranging from 1 to 16 characters.</p> <p>shutdown no shutdown</p> <p>Use shutdown to disable the port, and use no shutdown to enable the port. When the status is enabled, the port can forward packets normally, otherwise it will discard the received packets. By default, all ports are enabled.</p> <p>speed { 10 100 1000 10000 auto }</p> <p>Set the appropriate speed mode for the port.</p> <p>10 100 1000 10000 auto: Speed mode of the port. The options are subject to your actual product. The device connected to the port should be in the same speed and duplex mode with the port. When auto is selected, the speed mode will be determined by auto-negotiation.</p> <p>duplex { auto full half }</p> <p>Set the appropriate duplex mode for the port.</p> <p>auto full half: Duplex mode of the port. The device connected to the port should be in the same speed and duplex mode with the port. When auto is selected, the duplex mode will be determined by auto-negotiation.</p> <p>flow-control</p> <p>Enable the switch to synchronize the data transmission speed with the peer device, avoiding the packet loss caused by congestion. By default, it is disabled.</p>
Step 5	<p>show interface configuration [<i>fastEthernet port</i> <i>gigabitEthernet port</i> <i>ten-gigabitEthernet port</i> <i>port-channel port-channel-id</i>]</p> <p>Verify the configuration of the port or LAG.</p>
Step 6	<p>end</p> <p>Return to privileged EXEC mode.</p>
Step 7	<p>copy running-config startup-config</p> <p>Save the settings in the configuration file.</p>

The following example shows how to implement the basic configurations of port1/0/1, including setting a description for the port, configuring the jumbo frame, making the port automatically negotiate speed and duplex with the neighboring port, and enabling the flow-control:

Switch#configure

Switch#jumbo-size 9216

Switch(config)#interface gigabitEthernet 1/0/1

Switch(config-if)#no shutdown

```
Switch(config-if)#description router connection
```

```
Switch(config-if)#speed auto
```

```
Switch(config-if)#duplex auto
```

```
Switch(config-if)#flow-control
```

```
Switch(config-if)#show interface configuration gigabitEthernet 1/0/1
```

Port	State	Speed	Duplex	FlowCtrl	Description
-----	-----	-----	-----	-----	-----
Gi1/0/1	Enable	Auto	Auto	Enable	router connection

```
Switch(config-if)#show jumbo-size
```

```
Global jumbo size : 9216
```

```
Switch(config-if)#end
```

```
Switch#copy running-config startup-config
```

3 Port Isolation Configurations

3.1 Using the GUI

Port isolation is used to restrict a specific port to sending packets to only the ports in a configured forwarding port list.

Choose the menu **L2 FEATURES > Switching > Port > Port Isolation** to load the following page.

Figure 3-1 Port Isolation List

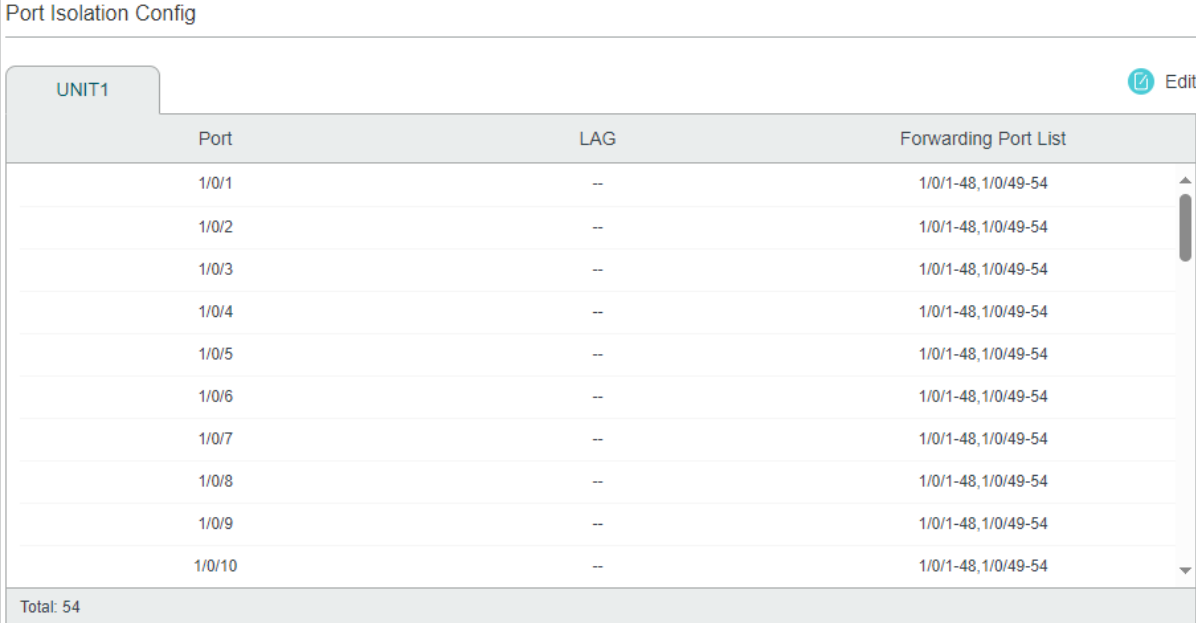

The screenshot shows the 'Port Isolation Config' page for 'UNIT1'. It features a table with columns for 'Port', 'LAG', and 'Forwarding Port List'. The table lists 10 ports (1/0/1 to 1/0/10) with LAG values of '--' and a forwarding port list of '1/0/1-48,1/0/49-54'. An 'Edit' button is visible in the top right corner. A 'Total: 54' indicator is at the bottom left of the table area.

Port	LAG	Forwarding Port List
1/0/1	--	1/0/1-48,1/0/49-54
1/0/2	--	1/0/1-48,1/0/49-54
1/0/3	--	1/0/1-48,1/0/49-54
1/0/4	--	1/0/1-48,1/0/49-54
1/0/5	--	1/0/1-48,1/0/49-54
1/0/6	--	1/0/1-48,1/0/49-54
1/0/7	--	1/0/1-48,1/0/49-54
1/0/8	--	1/0/1-48,1/0/49-54
1/0/9	--	1/0/1-48,1/0/49-54
1/0/10	--	1/0/1-48,1/0/49-54

The above page displays the port isolation list. Click  **Edit** to configure Port Isolation on the following page.

Figure 3-2 Port Isolation



Follow these steps to configure Port Isolation:

- 1) In the **Port** section, select one or multiple ports to be isolated.
- 2) In the **Forwarding Port List** section, select the forwarding ports or LAGs which the isolated ports can only communicate with. It is multi-optional.
- 3) Click **Apply**.

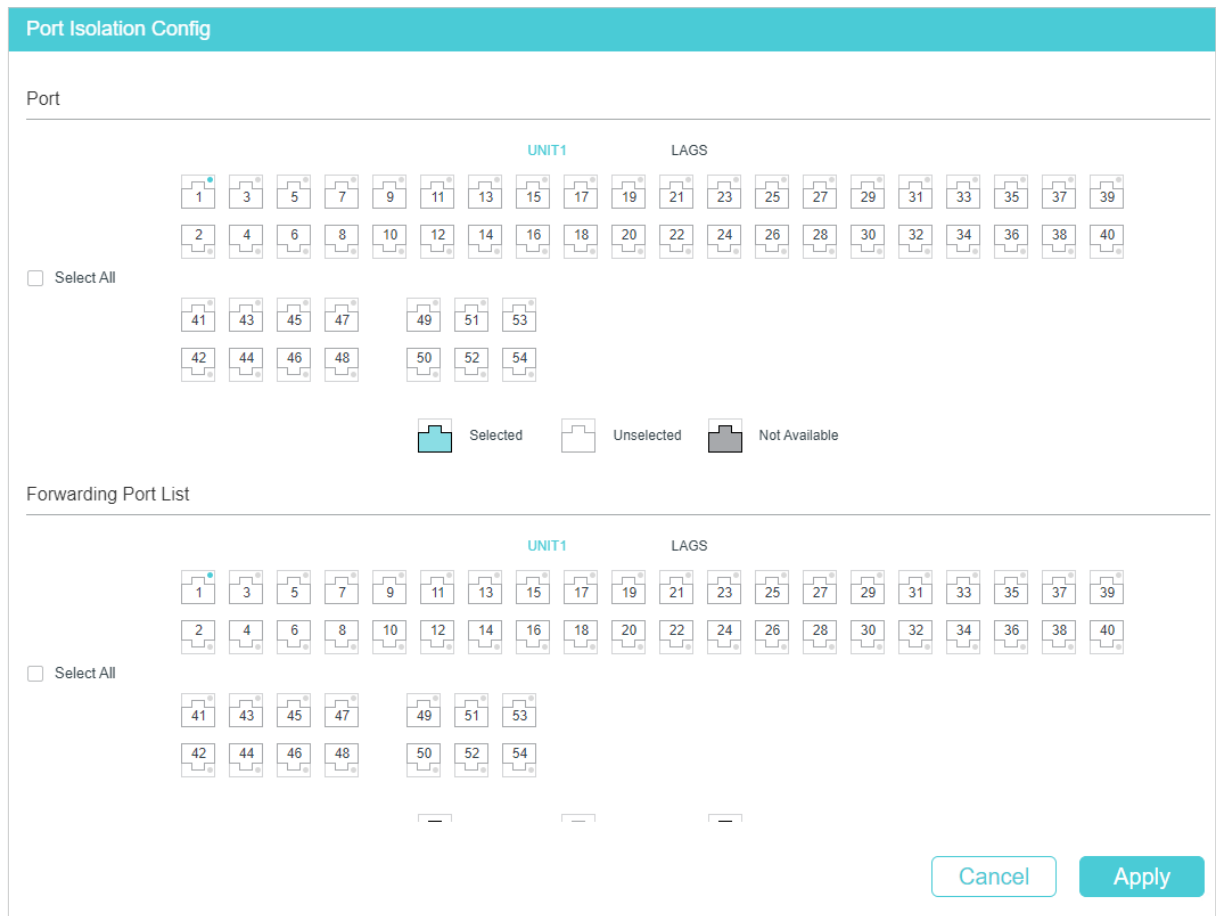
 **Note:**

If the port is a member port of an LAG, it will follow the port configuration of the LAG and not its own.

3.2 Using the CLI

Follow these steps to configure Port Isolation:

Step 1	<p>configure</p> <p>Enter global configuration mode.</p>
Step 2	<p>interface {vlan vid fastEthernet port range fastEthernet port-list gigabitEthernet port range gigabitEthernet port-list ten-gigabitEthernet port range ten-gigabitEthernet port-list port-channel port-channel range port-channel port-channel-list }</p> <p>Specify the port to be isolated and enter interface configuration mode.</p>

Step 3	<p>port isolation { [fa-forward-list fa-forward-list] [gi-forward-list gi-forward-list] [te-forward-list te-forward-list] [po-forward-list po-forward-list] }</p> <p>Add ports or LAGs to the forwarding port list of the isolated port. It is multi-optional.</p> <p><i>fa-forward-list / gi-forward-list / te-forward-list</i>: Specify the forwarding Ethernet ports.</p> <p><i>po-forward-list</i>: Specify the forwarding LAGs.</p>
Step 4	<p>show port isolation interface { fastEthernet port gigabitEthernet port ten-gigabitEthernet port port-channel port-channel }</p> <p>Verify the Port Isolation configuration of the specified port.</p>
Step 5	<p>end</p> <p>Return to privileged EXEC mode.</p>
Step 6	<p>copy running-config startup-config</p> <p>Save the settings in the configuration file.</p>

The following example shows how to add ports 1/0/1-3 and LAG 4 to the forwarding list of port 1/0/5:

Switch#configure

Switch(config)#interface gigabitEthernet 1/0/5

Switch(config-if)#port isolation gi-forward-list 1/0/1-3 po-forward-list 4

Switch(config-if)#show port isolation interface gigabitEthernet 1/0/5

Port	LAG	Forward-List
----	---	-----
Gi1/0/5	N/A	Gi1/0/1-3,Po4

Switch(config-if)#end

Switch#copy running-config startup-config

4 Loopback Detection Configuration

4.1 Using the GUI

To avoid broadcast storm, we recommend that you enable storm control before loopback detection is enabled. For detailed introductions about storm control, refer to [Configuring QoS](#).

Choose the menu **L2 FEATURES > Switching > Port > Loopback Detection** to load the following page.

Figure 4-1 Configuring Loopback Detection

Loopback Detection

Loopback Detection Status: Enable

Detection Interval: seconds (1-1000)

Auto-recovery Time: seconds (2-100,000)

Web Refresh Status: Enable

Web Refresh Interval: seconds (3-100)

Apply

Port Config

UNIT1 LAGS Recovery

<input type="checkbox"/>	Port	Status	Operation Mode	Recovery Mode	Loop Status	Block Status	Block VLAN	LAG
<input type="checkbox"/>	1/0/1	Disabled	Alert	Auto	--	--	--	--
<input type="checkbox"/>	1/0/2	Disabled	Alert	Auto	--	--	--	--
<input type="checkbox"/>	1/0/3	Disabled	Alert	Auto	--	--	--	--
<input type="checkbox"/>	1/0/4	Disabled	Alert	Auto	--	--	--	--
<input type="checkbox"/>	1/0/5	Disabled	Alert	Auto	--	--	--	--
<input type="checkbox"/>	1/0/6	Disabled	Alert	Auto	--	--	--	--
<input type="checkbox"/>	1/0/7	Disabled	Alert	Auto	--	--	--	--
<input type="checkbox"/>	1/0/8	Disabled	Alert	Auto	--	--	--	--
<input type="checkbox"/>	1/0/9	Disabled	Alert	Auto	--	--	--	--
<input type="checkbox"/>	1/0/10	Disabled	Alert	Auto	--	--	--	--

Total: 54

Follow these steps to configure loopback detection:

- 1) In the **Loopback Detection** section, enable loopback detection and configure the global parameters. Then click **Apply**.

Loopback Detection Status Enable or disable the loopback detection function globally.

Detection Interval	Specify the interval between successive sent loopback detection packets. The valid value ranges from 1 to 1000 and the default value is 30.
Auto-recovery Time	Set the auto-recovery time globally. The blocked port in Auto Recovery mode will automatically be recovered to normal status after the auto-recovery Time expires. The value ranges from 2 to 100,000 in seconds, and the default value is 90.
Web Refresh Status	Enable or disable web refresh status. With this option enabled, the web page will automatically be refreshed regularly according to the web refresh interval. By default, it is disabled.
Web Refresh Interval	If you have enabled web refresh status, set the refresh interval in seconds between 3 and 100. The default value is 6.

- 2) In the **Port Config** section, select one or more ports to configure the loopback detection parameters. Then click **Apply**.

Status	Enable or disable loopback detection for the port.
Operation Mode	Specify the operation to be taken when a loop is detected. Alert: The Loop Status will display if there is a loop detected on the corresponding port. It is the default setting. Port Based: The switch will display an alert and block the corresponding port when a loop is detected. VLAN-Based: The switch will display an alert and block the corresponding VLAN when a loop is detected.
Recovery Mode	If you select Port Based or VLAN-Based as the operation mode, you also need to configure the recovery mode for the blocked port: Auto: The blocked port will automatically recover to normal status after the auto-recovery time. It is the default setting. Manual: You need to manually release the blocked port. Click the Recovery button to release the selected port.

- 3) (Optional) View the loopback detection information.

Loop Status	Displays whether a loop is detected on the port.
Block Status	Displays whether the port is blocked.
Block VLAN	Displays whether the VLAN is blocked.
LAG	Displays the LAG that the port belongs to.

4.2 Using the CLI

Follow these steps to configure loopback detection:

Step 1	configure Enter global configuration mode.
Step 2	loopback-detection Enable the loopback detection feature globally. By default, it is disabled.
Step 3	loopback-detection interval <i>interval-time</i> Set the interval of sending loopback detection packets which is used to detect the loops in the network. <i>interval-time</i> : The interval of sending loopback detection packets. The valid values are from 1 to 1000 seconds. By default, the value is 30 seconds.
Step 4	loopback-detection recovery-time <i>recovery-time</i> Set the auto-recovery time, after which the blocked port in Auto Recovery mode can automatically be recovered to normal status. <i>recovery-time</i> : Specify the detection interval, ranging from 2 to 100,000 seconds. The default value is 90.
Step 5	interface {vlan <i>vid</i> fastEthernet <i>port</i> range fastEthernet <i>port-list</i> gigabitEthernet <i>port</i> range gigabitEthernet <i>port-list</i> ten-gigabitEthernet <i>port</i> range ten-gigabitEthernet <i>port-list</i> port-channel <i>port-channel</i> range port-channel <i>port-channel-list</i> } Enter interface configuration mode.
Step 6	loopback-detection Enable loopback detection for the port. By default, it is disabled.
Step 7	loopback-detection config process-mode { alert port-based vlan-based } recovery-mode { auto manual } Set the process mode when a loopback is detected on the port. There are three modes: alert : The switch will only display alerts when a loopback is detected. It is the default setting. port-based : In addition to displaying alerts, the switch will block the port on which the loop is detected. vlan-based : In addition to displaying alerts, the switch will block the VLAN of the port in which the loop is detected. Set the recovery mode for the blocked port. There are two modes: auto : After the recovery time expires, the blocked port will automatically recover to normal status and restart to detect loops in the network. manual : The blocked port can only be released manually. You can use the command 'loopback-detection recover' to recover the blocked port to normal status.
Step 9	show loopback-detection global Verify the global configuration of Loopback Detection.

Step 10	show loopback-detection interface { fastEthernet port gigabitEthernet port ten-gigabitEthernet port port-channel port-channel } Verify the Loopback Detection configuration of the specified port.
Step 11	end Return to privileged EXEC mode.
Step 12	copy running-config startup-config Save the settings in the configuration file.

The following example shows how to enable loopback detection globally (keep the default parameters):

```
Switch#configure
Switch(config)#loopback-detection
Switch(config)#show loopback-detection global
Loopback detection global status : enable
Loopback detection interval : 30s
Loopback detection recovery time : 3 intervals
Switch(config-if)#end
Switch#copy running-config startup-config
```

The following example shows how to enable loopback detection of port 1/0/3 and set the process mode as alert and recovery mode as auto:

```
Switch#configure
Switch(config)#interface gigabitEthernet 1/0/3
Switch(config-if)#loopback-detection
Switch(config-if)#loopback-detection config process-mode alert recovery-mode auto
Switch(config-if)#show loopback-detection interface gigabitEthernet 1/0/3
```

Port	Enable	Process Mode	Recovery Mode	Loopback	Block	LAG
----	-----	-----	-----	-----	----	----
Gi1/0/3	enable	alert	auto	N/A	N/A	N/A

```
Switch(config-if)#end
Switch#copy running-config startup-config
```

5 Configuration Examples

5.1 Example for Port Isolation

5.1.1 Network Requirements

As shown below, three hosts and a server are connected to the switch and all belong to VLAN 10. Without changing the VLAN configuration, Host A is not allowed to communicate with the other hosts except the server, even if the MAC address or IP address of Host A is changed.

Figure 5-1 Network Topology

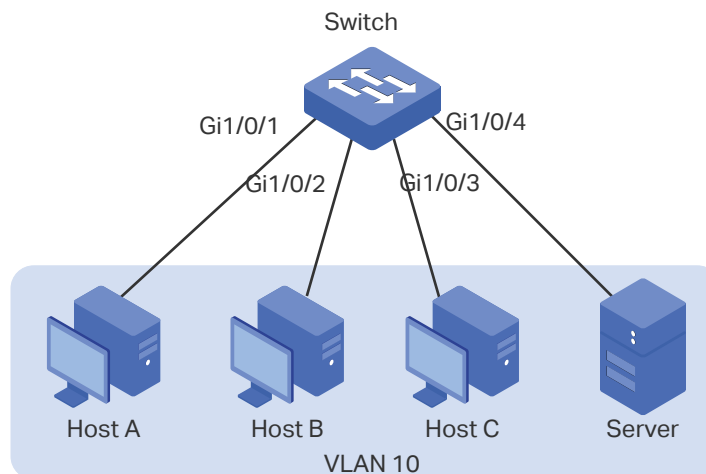

5.1.2 Configuration Scheme

You can configure port isolation to implement the requirement. Set port 1/0/4 as the only forwarding port for port 1/0/1, thus forbidding Host A to forward packets to the other hosts.

Since communications are bidirectional, if you want Host A and the server to communicate normally, you also need to add port 1/0/1 as the forwarding port for port 1/0/4.

Demonstrated with SG6654XHP, the following sections provide configuration procedure in two ways: using the GUI and using the CLI.

5.1.3 Using the GUI

- 1) Choose the menu **L2 FEATURES > Switching > Port > Port Isolation** to load the following page. It displays the port isolation list.

Figure 5-2 Port Isolation List

Port Isolation Config			
UNIT1 Edit			
Port	LAG	Forwarding Port List	
1/0/1	--	1/0/1-48, 1/0/49-54	
1/0/2	--	1/0/1-48, 1/0/49-54	
1/0/3	--	1/0/1-48, 1/0/49-54	
1/0/4	--	1/0/1-48, 1/0/49-54	
1/0/5	--	1/0/1-48, 1/0/49-54	
1/0/6	--	1/0/1-48, 1/0/49-54	
1/0/7	--	1/0/1-48, 1/0/49-54	
1/0/8	--	1/0/1-48, 1/0/49-54	
1/0/9	--	1/0/1-48, 1/0/49-54	
1/0/10	--	1/0/1-48, 1/0/49-54	

Total: 54

- Click **Edit** on the above page to load the following page. Select port 1/0/1 as the port to be isolated, and select port 1/0/4 as the forwarding port. Click **Apply**.

Figure 5-3 Port Isolation Configuration

Port Isolation Config

Port

UNIT1
LAGS

Select All

Selected

Unselected

Not Available

Forwarding Port List

UNIT1
LAGS

Select All

Cancel
Apply

- Select port 1/0/4 as the port to be isolated, and select port 1/0/1 as the forwarding port. Click **Apply**.

Figure 5-4 Port Isolation Configuration

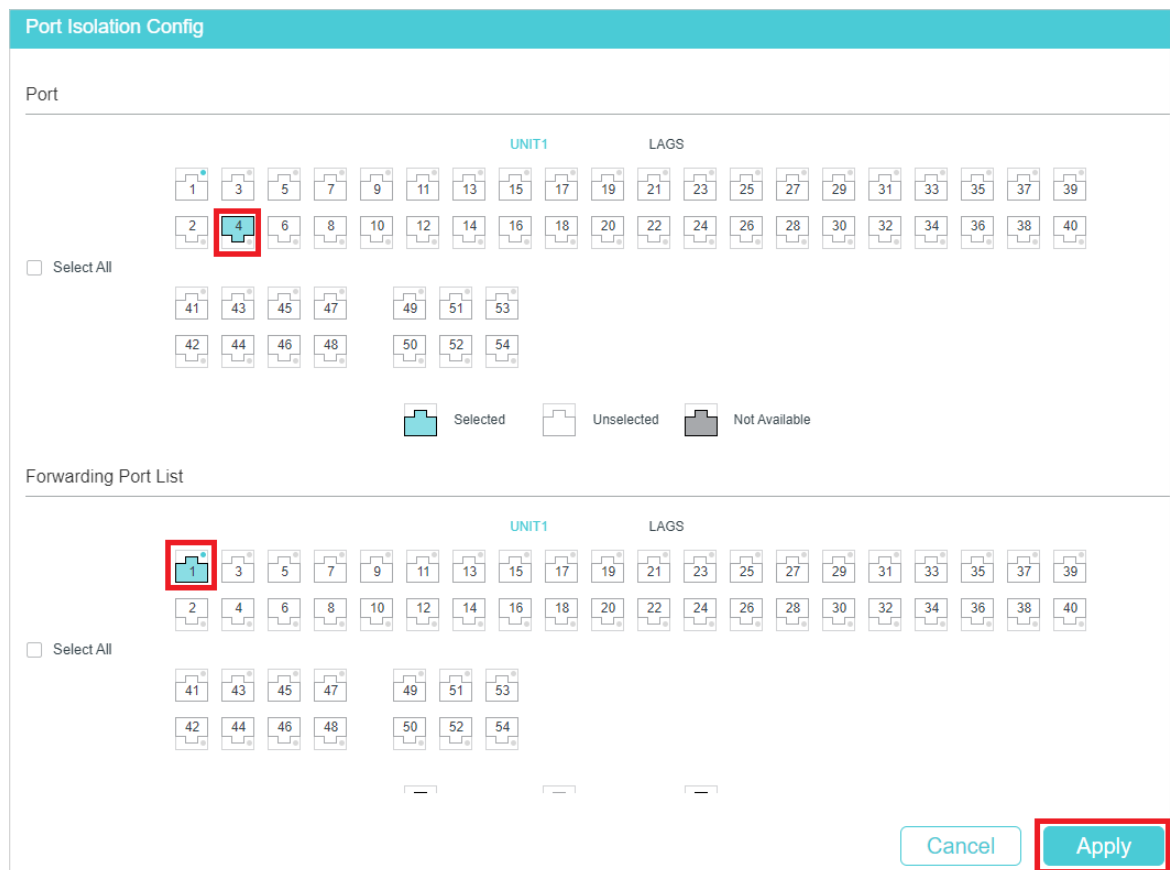

4) Click  Save to save the settings.

5.1.4 Using the CLI

```
Switch#configure
Switch(config)#interface gigabitEthernet 1/0/1
Switch(config-if)#port isolation gi-forward-list 1/0/4
Switch(config-if)#exit
Switch(config)#interface gigabitEthernet 1/0/4
Switch(config-if)#port isolation gi-forward-list 1/0/1
Switch(config-if)#end
Switch#copy running-config startup-config
```

Verify the Configuration

```
Switch#show port isolation interface
```

```
Port      LAG      Forward-List
-----  ---      -
```

```

Gi1/0/1 N/A Gi1/0/4
Gi1/0/2 N/A Gi1/0/1-48,Te1/0/49-54,Gi2/0/1-48,Te2/0/49-54
Gi1/0/3 N/A Gi1/0/1-48,Te1/0/49-54,Gi2/0/1-48,Te2/0/49-54
Gi1/0/4 N/A Gi1/0/1
Gi1/0/5 N/A Gi1/0/1-48,Te1/0/49-54,Gi2/0/1-48,Te2/0/49-54
...

```

5.2 Example for Loopback Detection

5.2.1 Network Requirements

As shown below, Switch A is a convergence-layer switch connecting to several access-layer switches. Loops can be easily caused in case of misoperation on the access-layer switches. If there is a loop on an access-layer switch, broadcast storms will occur on Switch A or even in the entire network, creating excessive traffic and degrading the network performance.

To reduce the impacts of broadcast storms, users need to detect loops in the network via Switch A and timely block the port on which a loop is detected.

Figure 5-5 Network Topology

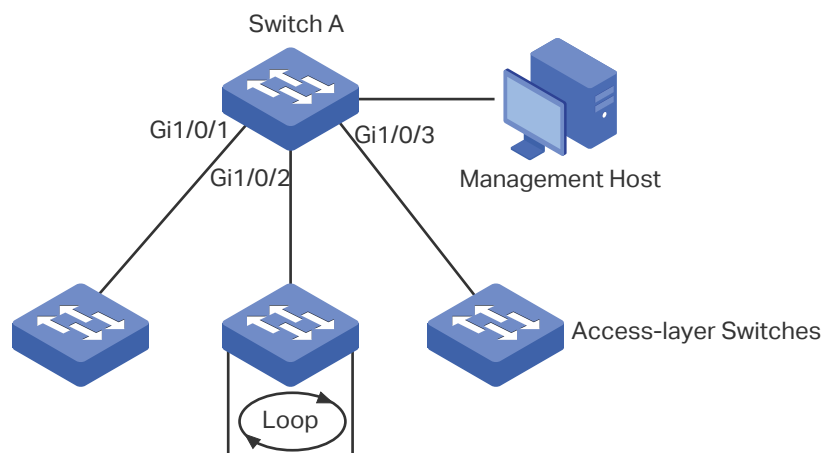

5.2.2 Configuration Scheme

Enable loopback detection on ports 1/0/1-3 and configure SNMP to receive the trap notifications. For detailed instructions about SNMP, refer to [Configuring SNMP & RMON](#). Here we introduce how to configure loopback detection and monitor the detection result on the management interface of the switch.

Demonstrated with SG6654XHP, the following sections provide configuration procedure in two ways: using the GUI and using the CLI.

5.2.3 Using the GUI

- 1) Choose the menu **L2 FEATURES > Switching > Port > Loopback Detection** to load the configuration page.
- 2) In the **Loopback Detection** section, enable loopback detection and web refresh globally. Keep the other parameters as default values and click **Apply**.

Figure 5-6 Global Configuration

Loopback Detection

Loopback Detection Status: Enable

Detection Interval: seconds (1-1000)

Auto-recovery Time: seconds (2-100,000)

Web Refresh Status: Enable

Web Refresh Interval: seconds (3-100)

- 3) In the **Port Config** section, enable ports 1/0/1-3, select the operation mode as **Port -Based** so that the port will be blocked when a loop is detected, and keep the recovery mode as **Auto** so that the port will automatically be recovered to normal status after the auto-recovery time. Click **Apply**.

Figure 5-7 Port Configuration

Port Config

	Port	Status	Operation Mode	Recovery Mode	Loop Status	Block Status	Block VLAN	LAG
<input checked="" type="checkbox"/>	1/0/1	Enabled	Port Based	Auto	---	---	--	---
<input checked="" type="checkbox"/>	1/0/2	Enabled	Port Based	Auto	---	---	--	---
<input checked="" type="checkbox"/>	1/0/3	Enabled	Port Based	Auto	---	---	--	---
<input type="checkbox"/>	1/0/4	Disabled	Alert	Auto	---	---	--	---
<input type="checkbox"/>	1/0/5	Disabled	Alert	Auto	---	---	--	---
<input type="checkbox"/>	1/0/6	Disabled	Alert	Auto	---	---	--	---
<input type="checkbox"/>	1/0/7	Disabled	Alert	Auto	---	---	--	---
<input type="checkbox"/>	1/0/8	Disabled	Alert	Auto	---	---	--	---
<input type="checkbox"/>	1/0/9	Disabled	Alert	Auto	---	---	--	---
<input type="checkbox"/>	1/0/10	Disabled	Alert	Auto	---	---	--	---

Total: 28 3 entries selected.

- 4) Monitor the detection result on the above page. The **Loop status** and **Block status** are displayed on the right side of ports.

5.2.4 Using the CLI

- 1) Enable loopback detection globally and configure the detection interval and recovery time.

```
Switch#configure
```

```
Switch(config)#loopback-detection
```

```
Switch(config)#loopback-detection interval 30
```

```
Switch(config)#loopback-detection recovery-time 3
```

- 2) Enable loopback detection on ports 1/0/1-3 and set the process mode and recovery mode.

```
Switch(config)#interface range gigabitEthernet 1/0/1-3
```

```
Switch(config-if-range)#loopback-detection
```

```
Switch(config-if-range)#loopback-detection config process-mode port-based
recovery-mode auto
```

```
Switch(config-if-range)#end
```

```
Switch#copy running-config startup-config
```

Verify the Configuration

Verify the global configuration:

```
Switch#show loopback-detection global
```

```
Loopback detection global status : enable
```

```
Loopback detection interval: 30 s
```

```
Loopback detection recovery time : 90 s
```

Verify the loopback detection configuration on ports:

```
Switch#show loopback-detection interface
```

Port	Enable	Process Mode	Recovery Mode	Loopback	Block	LAG
Gi1/0/1	enable	port-based	auto	N/A	N/A	N/A
Gi1/0/2	enable	port-based	auto	N/A	N/A	N/A
Gi1/0/3	enable	port-based	auto	N/A	N/A	N/A

6 Appendix: Default Parameters

Default settings of Switching are listed in the following tables.

Table 6-1 Configurations for Ports

Parameter	Default Setting
Port Config	
Jumbo	1518 bytes
Type	Copper (For RJ45 Ports) Fiber (For SFP/SFP+/SFP28/QSFP28 Ports)
Status	Enabled
Speed	Auto(For RJ45 Ports) 1000M (For SFP Ports) 10G(For SFP+ Ports) 25G(For SFP28 Ports) 100G(For QSFP28 Ports)
Duplex	Auto (For RJ45 Ports) Full (For SFP/SFP+/SFP28/QSFP28 Ports)
Flow Control	Disabled
Loopback Detection	
Loopback Detection Status	Disabled
Detection Interval	30 seconds
Auto-recovery Time	90 seconds
Web Refresh Status	Disabled
Web Refresh Interval	6 seconds
Port Status	Disabled
Operation mode	Alert
Recovery mode	Auto

Part 4

Configuring Stack

CHAPTERS

1. Overview
2. Stack Concepts
3. Stack Operation Procedure
4. Stack Topology
5. Stack Configuration
6. Appendix: Default Parameters

1 Overview

Stack is a device virtualization technology that connects two and above switches supporting stack features via cables through their stack ports, which logically virtualize them to one device as a whole to forward data in the network in Layer 2 and Layer 3 protocols. Through this feature, switches can be stacked to improve reliability, expand port numbers, increase bandwidth, simplify networking, and etc.

In a stack system, the switches can be categorized mainly into two roles: Master Switch and Member Switch. The master switch manages and controls devices in the whole stack system while the member switch only forwards data as a standby device of the master switch.

As the following figure shows, the switches are connected to form a stack which works as a unified system that enables multiple devices to collaborate under the management of the master switch as a whole.

Figure 1-1 Network Topology of a Stack System

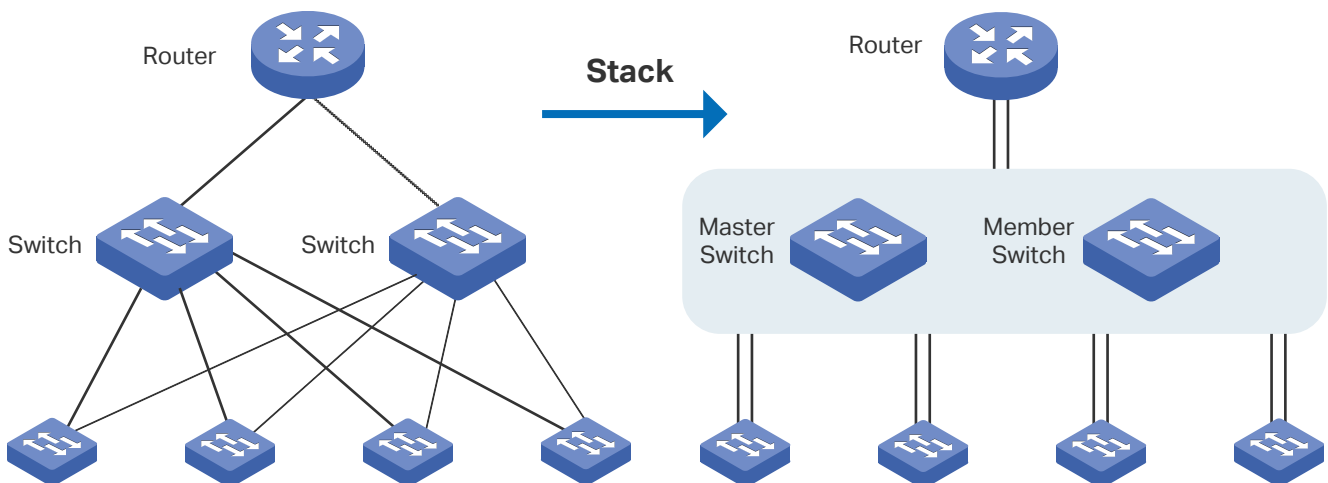

2 Stack Concepts

Concepts related with Stack will be introduced in this chapter to enable Stack establishment and configuration.

Stack Role

Every single device is called stack member once they form a stack system. Each stack member processes services packets and plays a role which is either master or member in the stack system according to the function that they perform:

- **Master:** The master switch manages the entire stack system and there's only one master switch in one stack system.
- **Member:** The member switch forwards data under the management of the master switch. And if the master switch fails, a new master will be selected from the member switches to succeed the previous master.

Unit ID

When the stack is running, Unit ID is used to identify and manage stack members. Every member has its own unique unit ID in a stack system. In order to keep its uniqueness, before establishing stack, you are kindly recommended to prepare a unit number assignment scheme and then manually configure it on each member device. When the stack is running, if you want to change the unit ID manually, only the unit numbers which have not been occupied by the other member devices are available for you to choose from.

Priority

As an attribute of the stack members, Priority can decide the role of the stack member during master election. The higher the priority value is, the more likely the member will be elected as the master. We recommend you manually assign the highest priority value to the switch that you prefer to be the stack master before stack establishment.

Stack Events

- **Merge:** It refers to the circumstance where two independent stacks merge into one stack due to stack link establishment. Once merge happens, the previous masters compete to be the new master. The stack members of the defeated stack will join the winner stack to form a new stack. Master will assign Unit ID to the newly joined members and compare their configuration files. The members with different configurations files with the master will download the configuration files of the master and re-configure.

- **Split:** It refers to the circumstance where stack splits into two or above stacks because of stack link failures. When it occurs, each newly established stack elects their own new master and uses the MAC address of the master as its stack MAC address. However, stack partition probably brings about routing and forwarding problems on the network since the partitioned stacks keep operating with the previous IP address by default, which results in same IP address being reused in the same LAN.

3 Stack Operation Procedure

Stack involves four stages: Connecting the stack members, Topology collection, Master election, and Stack management and maintenance.

1. Connecting the stack members

To establish a stack, please firstly physically connect the stack port groups of the member devices with cables to form a stack topology (will be introduced in Chapter 4). And then configure the stack port groups (one port can also be called as stack port group) of the switches to be stacked one by one via the GUI.

2. Topology Collection

Each member in the stack collects the topology of the whole stack by exchanging stack discovery packets with its neighbors. Discovery packet carries topology information including stack port connection status, unit ID, priorities, MAC addresses, etc.

Each member keeps a local record of the known topology information. When the device initializes, it only possesses the record of its own topology information. Then the stack members periodically send out their known topology information through the stack ports to its neighbors. When the neighbors receive the information, they will update their local topology information. After a period of time of broadcasting and updating information, all the stack members can collect the complete topology information (known as topology convergence).

Then the switch enters the master election stage.

3. Master Election

The stack will enter the master election stage after all members obtains the topology information. There's always one master in a stack system while the other devices are members. The stack role of the stack members is determined during master election.

Master election is held each time the topology changes, for example, when stack merge or split occurs, or the stack or the current master is reset.

The master is elected based on the following rules and in the order listed:

1. The switch that is currently the stack master.
2. The switch with the highest stack member priority value.
3. The switch with the lowest MAC address.

After master election, the stack forms and enters into stack management and maintenance stage.

4. Stack Management and Maintenance

- **Stack Management:** After the stack is established, all the stack members are integrated into a virtual device in the network and managed by the master. And you can log in the stack system through any member devices to configure and manage it.

But we highly recommend you to prepare the configuration planning with a clear set of the role and function of each member device before configuring the stack. Some configuration needs device reboot to take effect, so you are kindly recommended to configure the stack at first. Next, connect the devices physically after powering off them, then you can power them on and the devices will join the stack automatically.

The stack management can be implemented on the **Stack Info** and **Stack Config** page.

- **Stack Maintenance:** It enables the stack system to monitor the joining and leaving of member devices as well as the new topology to maintain the current topology.

When the stack is operating normally, packets are transmitted constantly between stack members. The switch can quickly detect the link status of the stack port via monitoring the response of the packets. Once the switch finds out that the link status changes, it will recollect system topology and update topology database to ensure the normal operation of the stack.

The events that will change the link status of the stack port and affect the system topology include: stack member failure or leaving, new member's coming, link failure or failure recovery, etc.

When the master switch fails, the stack system elects a new master from the remaining members to succeed the previous master.

4 Stack Topology

With the stack feature, switches can be stacked into one topology for higher reliability, larger bandwidth, and simpler networking.

And according to different using scenarios, there are generally three stack topology structures. Please build the proper topology according to your needs:

Chain Topology

Compared with the other two structures, Chain Topology is relatively simple without requiring cable connection between the first and last unit (see Figure 2-1). It is suitable for long-distance stacking, but its reliability is not ideal.

Figure 4-1 Chain Topology

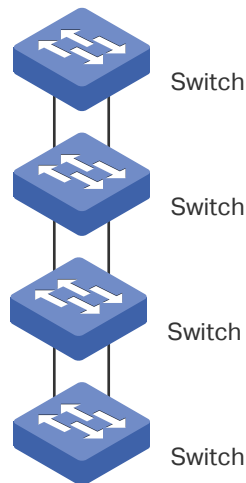

Ring Topology

Compared with Chain Topology, Ring Topology has higher reliability. The ring topology automatically turns into a chain topology when one of its connections fails, enabling the entire stack system to continue working. As the ring topology requires cable connection between the first and last unit, it's not suitable for long-distance stacking.

Figure 4-2 Ring Topology

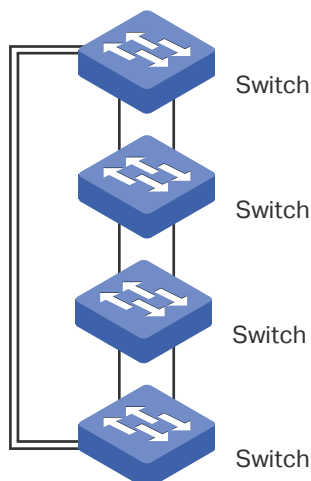

Star Topology

Star topology connects the switches to a central master switch, therefore, it can significantly increase the data forwarding rate between member switches while providing unified management.

Figure 4-3 Star Topology

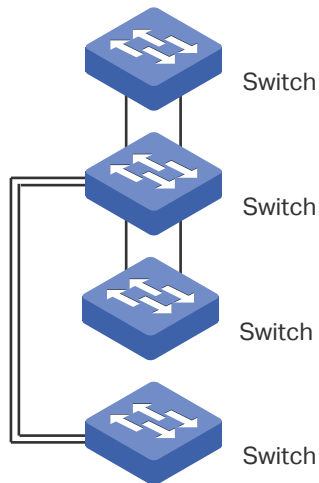

 **Note:**

Before stacking, make sure that the firmware versions of the switches to be stacked are compatible; otherwise, the stack may fail due to versions with large gaps

5 Stack Operation Procedure

5.1 Using the GUI

5.1.1 Viewing the Stack Information

Choose the menu **SYSTEM > Stack > Stack Info** to load the following page.

Figure 5-1 Stack Info

Stack Info							
Stack Topology:	Solo						
Stack MAC:	5c-e9-31-43-31-7a						
Stack Member Info							
Unit ID	New Unit ID	Role	MAC Address	Priority	Version	Device Type	State
1	1	Master	5c-e9-31-43-31-7a	5	1.0.0	SG6654X	Ready
Stack Port Info							
UNIT1							
Stack Port	Stack Port Group	Status	Neighbor				
1/0/49	0	Ethernet	none				
1/0/50	0	Ethernet	none				
1/0/51	0	Ethernet	none				
1/0/52	0	Ethernet	none				
1/0/53	0	Ethernet	none				
1/0/54	0	Ethernet	none				

You can view the stack information on this page.

Stack Topology	Displays the type of the stack topology.
Stack MAC	Displays the MAC address of the stack system. It is the MAC address of the master in the stack.
Unit ID	Displays the current Unit of the switch in the stack.
New Unit ID	Displays the new Unit ID for the switch.
Role	Displays the role of the switch in the stack.
MAC Address	Displays the MAC address of the switch in the stack.

Priority	Displays the priority of the switch in the stack.
State	Displays the state of the switch in the stack. <ul style="list-style-type: none"> Ready: The stack generation is completed. Processing: The stack generation is in process.
Stack Port	Displays the stack port number.
Stack Port Group	Displays the stack port group number.
Status	Displays the status of the port. <ul style="list-style-type: none"> Down: No device is connected to the port. OK: The stack is running normally on the port. Authentication Fail: The peer device is not compatible. Ethernet: The port works as an Ethernet port.
Neighbor	Displays the connected neighbor UNIT number.

5.1.2 Configuring the Provision Info

Choose the menu **SYSTEM > Stack > Stack Config** to load the following page.

Figure 5-2 Provision Info Config

Provision Info

Unit ID:

Device Type:

Apply

Follow these steps to configure Provision Info:

- 1) Choose the Unit ID of the provisioned switch.
- 2) Choose the Device Type of the provisioned switch.
- 3) Click **Apply**.

You can provision (to supply a configuration to) a new switch before it joins the switch stack. You can configure the Unit ID and device type in advance for the new switch. The switch that will be added to the stack and that receives this configuration is called a provisioned member.

Unit ID	Specify the Unit ID of the provisioned switch.
Device Type	Specify the device type of the provisioned switch, which needs to be stack-compatible with the devices in the current stack system.

5.1.3 Configuring the Provisioned Member

After the Provision Info Config succeeded, you can view and delete the provisioned member on the same page.

Figure 5-3 Provisioned Member Table

Provisioned Member			
			 Delete
<input type="checkbox"/>	Unit ID	Device Type	State
<input type="checkbox"/>	2	SG6654XHP	Provisioned
Total: 1			

Follow these steps to delete a provisioned member.

- 1) Choose and click the provisioned member to be deleted.
- 2) Click **Delete**.

Figure 5-4 Deleting Provisioned Member

Provisioned Member			
			 Delete
<input checked="" type="checkbox"/>	Unit ID	Device Type	State
<input checked="" type="checkbox"/>	2	SG6654XHP	Provisioned
Total: 1		1 entry selected.	

You can view or remove the provisioned switches of the stack in this section.

Unit ID	Displays the Unit ID of the provisioned switch.
Device Type	Displays the device type of the provisioned switch.
State	Displays the state of the provisioned switch.

5.1.4 Configuring the Stack Member

On the same page, you can view and configure the stack member info after provision configuration

Figure 5-5 Stack Member Table

Stack Member Config						
<input type="checkbox"/>	Unit ID	New Unit ID	Role	MAC Address	Priority	State
<input type="checkbox"/>	1	1	Master	5c-e9-31-43-31-7a	5	Ready
Total: 1						

Follow these steps to configure Stack Member info:

- 1) Choose the stack member to be configured.
- 2) Select the New Unit ID for the chosen stack member if it is to be changed.

- 3) Select the Priority for the chosen stack member if it is to be changed.
- 4) Click **Apply**.

Figure 5-6 Modifying Unit ID and Priority

Stack Member Config						
<input checked="" type="checkbox"/>	Unit ID	New Unit ID	Role	MAC Address	Priority	State
<input checked="" type="checkbox"/>	1	1	Master	5c-e9-31-43-31-7a	5	Ready
Total: 1			1 entry selected.		<input type="button" value="Cancel"/>	<input type="button" value="Apply"/>

You can config the Unit ID and priority of the switches in the stack.

Unit ID	Displays the current Unit of the switch in the stack.
New Unit ID	Configure a new Unit ID for the switch.
Role	Displays the role of the switch in the stack.
MAC Address	Displays the MAC address of the switch in the stack.
Priority	Displays the priority of the switch in the stack.
State	Displays the state of the switch in the stack. <ul style="list-style-type: none"> • Ready: The stack generation is completed. • Processing: The stack generation is in process.

Note:

If you change the New Unit ID of the stack member, the new setting will not take effect until rebooting the switch.

5.1.5 Configuring the Stack Port Group

On the same page, configure the Stack Port Groups (stack link aggregation groups) of the units to be stacked.

Figure 5-7 Stack Port Table

Stack Port Group Config			
UNIT1	UNIT2		
<input type="checkbox"/>	Stack Port	Stack Port Group	Status
<input type="checkbox"/>	1/0/49	1	Down
<input type="checkbox"/>	1/0/50	1	Down
<input type="checkbox"/>	1/0/51	---	Ethernet
<input type="checkbox"/>	1/0/52	---	Ethernet
<input type="checkbox"/>	1/0/53	---	Ethernet
<input type="checkbox"/>	1/0/54	---	Ethernet
Total: 6			

Follow these steps to configure Stack Port Group of UNIT 1 (here two units are used as an example of stack):

- 1) Choose the ports of UNIT1 to be configured.
- 2) Select the Stack Port Group NO. for the chosen ports.
- 3) Click **Apply**.

Figure 5-8 Configuring Stack Port Group of UNIT 1

Stack Port Group Config			
UNIT1	UNIT2		
<input type="checkbox"/>	Stack Port	Stack Port Group	Status
<input type="checkbox"/>	1/0/49	---	Ethernet
<input type="checkbox"/>	1/0/50	---	Ethernet
<input type="checkbox"/>	1/0/51	---	Ethernet
<input type="checkbox"/>	1/0/52	---	Ethernet
<input type="checkbox"/>	1/0/53	---	Ethernet
<input type="checkbox"/>	1/0/54	---	Ethernet
Total: 6			

After the configuration succeeded, the stack port table will show the current Stack Port Group NO. for the chosen ports.

Figure 5-9 Stack Port Table Showing the Stack Port Group NO.

Stack Port Group Config			
UNIT1		UNIT2	
<input type="checkbox"/>	Stack Port	Stack Port Group	Status
<input checked="" type="checkbox"/>	1/0/49		Ethernet
<input checked="" type="checkbox"/>	1/0/50		Ethernet
<input type="checkbox"/>	1/0/51		Ethernet
<input type="checkbox"/>	1/0/52		Ethernet
<input type="checkbox"/>	1/0/53		Ethernet
<input type="checkbox"/>	1/0/54		Ethernet
Total: 6		2 entries selected.	<input type="button" value="Cancel"/> <input type="button" value="Apply"/>

Then, log out the GUI of UNIT 1 and log in the GUI of UNIT 2, repeat the steps to configure Stack Port Group of UNIT 2:

- 1) Choose the ports of UNIT2 to be configured (here the Table shows UNIT 1 as the stack system hasn't formed).
- 2) Select the Stack Port Group NO. for the chosen ports.
- 3) Click **Apply**.

Figure 5-10 Configuring Stack Port Group of UNIT 2

Stack Port Group Config			
UNIT1		UNIT2	
<input type="checkbox"/>	Stack Port	Stack Port Group	Status
<input type="checkbox"/>	1/0/49	1	Down
<input type="checkbox"/>	1/0/50	1	Down
<input type="checkbox"/>	1/0/51	---	Ethernet
<input type="checkbox"/>	1/0/52	---	Ethernet
<input type="checkbox"/>	1/0/53	---	Ethernet
<input type="checkbox"/>	1/0/54	---	Ethernet
Total: 6			

After the two switches are physically connected through the stack port groups, the status will change to "OK" for both UNITS. And the State in Stack Member Config will change to "ready", which means the stack generation is completed.

Figure 5-11 The "OK" Status of the Port Group

Stack Port Group Config

UNIT1 UNIT2

<input type="checkbox"/>	Stack Port	Stack Port Group	Status
<input checked="" type="checkbox"/>	1/0/49		Down
<input checked="" type="checkbox"/>	1/0/50	None	Down
<input type="checkbox"/>	1/0/51	1	Ethernet
<input type="checkbox"/>	1/0/52	2	Ethernet
<input type="checkbox"/>	1/0/53	3	Ethernet
<input type="checkbox"/>	1/0/54	4	Ethernet
Total: 6		2 entries selected.	<input type="button" value="Cancel"/> <input type="button" value="Apply"/>

Figure 5-12 The "OK" Status of the Port Group

Stack Port Group Config

UNIT1 UNIT2

<input type="checkbox"/>	Stack Port	Stack Port Group	Status
<input type="checkbox"/>	1/0/49	1	OK
<input type="checkbox"/>	1/0/50	1	OK
<input type="checkbox"/>	1/0/51	---	Ethernet
<input type="checkbox"/>	1/0/52	---	Ethernet
<input type="checkbox"/>	1/0/53	---	Ethernet
<input type="checkbox"/>	1/0/54	---	Ethernet
Total: 6			

You can configure the stack ports in the stack.

Stack Port	Displays the stack port number.
Stack Port Group	Displays the stack port group number.
Status	<p>Displays the status of the port.</p> <ul style="list-style-type: none"> Down: No device is connected to the port. OK: The stack is running normally on the port. Authentication Fail: The peer device is not compatible. Ethernet: The port works as an Ethernet port.

 **Note:**

Stack port is not allowed to connect to non-stack port, as it may affect the operation of the device. Stack ports with the same group ID are not allowed to connect to stack ports with different group IDs. A stack port group is a logical port dedicated to stacking and needs to be bound to a stack port. A stack port group can be bound to one or more stack ports to improve bandwidth and reliability.

5.2 Using the CLI

5.2.1 Configuring Stack System Name

Follow these steps to configure the name of the stack system:

-
- | | |
|--------|---|
| Step 1 | configure
Enter global configuration mode. |
| Step 2 | switch stack-name name
Specify the name of the stack system.
<i>name</i> : Specify the name of the stack system. |
-

The following example shows how to specify the name of the stack system.

Switch#configure

Switch(config)#switch stack-name "test"

5.2.2 Entering Stack Port Group View

Follow these steps to access the viewing page of a specified stack port group configuration of the specified device:

-
- | | |
|--------|---|
| Step 1 | configure
Enter global configuration mode. |
| Step 2 | switch unitid stack-group groupid
Enter the viewing page of a specified stack port group of the specified device.
<i>unitid</i> : Device ID in the stack system.
<i>groupid</i> : ID of the stack port group. |
-

The following example shows how to enter the viewing page of a stack port group 1 on switch 1.

Switch#configure

switch(config)# switch 1 stack-group 1

5.2.3 Configuring Stack Port

Follow these steps to enable the stack function for a specified slot:

-
- | | |
|--------|--|
| Step 1 | configure
Enter global configuration mode. |
|--------|--|
-

Step 2 **switch 2 stack-group 1**

Enter stack group mode.

Step 3 **switch(stack-group)# [no] interface port**

Enable/disable the stack function for a specified port, and add the port to the stack group.

group info: Enable/disable the stack function for a specified slot.

The following example shows how to configure 1/0/28 as a stack port and join stack-group 1 of unit 2.

Switch#configure

switch(config)# switch 2 stack-group 1

switch(stack-group)# interface 1/0/28

5.2.4 Viewing Current Stack Port Group Info

Follow these steps to view the information of the current stack port group:

Step 1 **configure**

Enter global configuration mode.

Step 2 **switch 2 stack-group 1**

Enter stack group mode.

Step 2 **switch(stack-group)# group-info**

view the specified stack port group configuration of the specified device

group info: Displays the information of the stack group.

The following example shows how to view the information of the stack port group 1 on switch 2.

Switch#configure

switch(config)# switch 2 stack-group 1

switch(stack-group)# group-info

5.2.5 Configuring Stack Device Priority

Follow these steps to configure the stack priority of the device with specified unit ID:

Step 1 **configure**

Enter global configuration mode.

Step 2 **switch** *unitid* **priority** *priority*

Configure the stack priority of the device with specified unit ID.

unitid: Device ID in the stack system, ranging from 1 to 4.

Priority: Stack priority. The higher the priority, the more likely the device is to become the master device. The value ranges from 1 to 255.

The following example shows how to configure the stack priority of unit 1 as 5.

Switch#configure

switch(config)#switch 1 priority 5

5.2.6 Modifying Stack Unit ID

Follow these steps to modify the stack unit ID of a specified device:

Step 1 **configure**

Enter global configuration mode.

Step 2 **switch** *unitid* **renumber** *new-unitid*

Modify the stack unit ID of a specified device, which will take effect after rebooting.

unitid: Device ID in the stack system, ranging from 1 to 4.

new-unitid: New device ID to be configured, ranging from 1 to 4.

The following example shows how to renumber the stack unit ID of unit 1 as 2.

Switch#configure

switch(config)#switch 1 renumber 2

 **Note:**

Changing the Unit number may result in a configuration change for that unit. The interface configuration associated with the old unit number will remain as a provisioned configuration. Do you want to continue?[Y/N] y

Changing Unit Number 1 to Unid Number 1. New Unit Number will be effective after next reboot.

5.2.7 Configuring Provision Entries

Follow these steps to configure provision entries:

Step 1 **configure**

Enter global configuration mode.

Step 2 **switch** *unitid* **provision** *device-type*

Create a provisioned entry specifying unit ID and device-type. After creation, you can use other configuration commands to configure the unit. The configuration will take effect after the stack is connected. To delete the entry, use the `no switch unitid provision device-type` command.

unitid: Device ID, which should be less than 32 characters and range from 1 to 4.

device-type: Device type. The provision device needs to be of the same type as the connected device

The following example shows how to configure provision entries.

Switch#configure

switch(config)#switch 1 provision 3

5.2.8 Viewing Stack Info

Follow these steps to view the stack information:

Step 1 **show switch stack-ports**

View the stack port information of all members of the stack group.

Step 2 **show switch**

View information of all devices in the stack system.

Step 3 **show switch** *unitid*

View information about specified stack member devices.

Step 4 **show switch neighbors**

View the group ID of the stack port and the unit ID of its neighboring member device in the current stack system.

6 Appendix: Default Parameters

Default settings of Stack are listed in the following tables.

Table 6-1 Default Settings of Stack

Parameter	Default Setting
Stack Member Config	
Priority	5
Stack Port Group Config	
Stack Port Group	None

Part 5

Configuring DDM

(Only for Certain Devices)

CHAPTERS

1. Overview
2. DDM Configuration
3. Appendix: Default Parameters

1 Overview

 **Note:**

DDM is only available on certain devices. To check whether your device supports this feature, refer to the actual web interface. If DDM is available, there is **L2 FEATURES > Switching > DDM** in the menu structure.

The DDM (Digital Diagnostic Monitoring) function is used to monitor and manage the SFP modules inserted into the SFP ports. With this function, the user can configure multiple thresholds for the SFP module. The SFP port can be automatically shut down when the switch detects the operating parameter of the module exceeds the threshold. The monitored parameters include: Temperature, Voltage, Bias Current, Tx Power and Rx Power.

2 DDM Configuration

To complete DDM configuration, follow these steps:

- 1) Enable DDM function on the SFP port and configure the shutdown condition.
- 2) Configure the threshold for Warning or Alarm.

2.1 Using the GUI

2.1.1 Configuring DDM Globally

Choose the menu **L2 FEATURES > Switching > DDM > DDM Config** and select the desired SFP port to load the following page.

Figure 2-1 Configure DDM Globally

Port Config				
<input type="checkbox"/>	Port	DDM Status	Shutdown	LAG
<input type="checkbox"/>	1/0/49	Enabled	None	--
<input type="checkbox"/>	1/0/50	Enabled	None	--
<input type="checkbox"/>	1/0/51	Enabled	None	--
<input type="checkbox"/>	1/0/52	Enabled	None	--
<input type="checkbox"/>	1/0/53	Enabled	None	--
<input type="checkbox"/>	1/0/54	Enabled	None	--
Total: 6				

Follow these steps to configure the DDM parameters on SFP ports:

- 1) In the **Port Config** section, select one or multiple SFP ports to configure DDM parameters.

DDM Status	Enable or disable DDM function.
Shutdown	Specify whether to shut down the port when the operating parameter exceeds the Alarm or Warning threshold. None: The port will never be shut down regardless if the threshold ranges are exceeded or not. This is the default setting. Alarm: The port will be shut down when the configured alarm threshold range is exceeded. Warning: The port will be shut down when the configured warning threshold range is exceeded.
LAG	Displays the LAG that the port belongs to.

- 2) Click **Apply**.

2.1.2 Configuring the Threshold

Note:

The value of threshold parameters should conform to the following rule: High Alarm \geq High Warning \geq Low Warning \geq Low Alarm.

Choose the menu **L2 FEATURES > Switching > DDM > Threshold Config** to load the following page.

■ Configuring the Temperature Threshold

Figure 2-2 Configure Temperature Threshold

Temperature						
<input type="checkbox"/>	Port	High Alarm (-128-127.996 °C)	Low Alarm (-128-127.996 °C)	High Warning (-128-127.996 °C)	Low Warning (-128-127.996 °C)	LAG
<input type="checkbox"/>	1/0/49	---	---	---	---	--
<input type="checkbox"/>	1/0/50	---	---	---	---	--
<input type="checkbox"/>	1/0/51	---	---	---	---	--
<input type="checkbox"/>	1/0/52	---	---	---	---	--
<input type="checkbox"/>	1/0/53	---	---	---	---	--
<input type="checkbox"/>	1/0/54	---	---	---	---	--
Total: 6						

Follow these steps to configure DDM's temperature threshold:

- 1) In the **Temperature** table, select one or more SFP ports to configure temperature threshold of the SFP ports.

High Alarm	Specify the highest threshold for the alarm. When the operating parameter rises above this value, action associated with the alarm will be taken. The valid values are from -128 to 127.996.
Low Alarm	Specify the lowest threshold for the alarm. When the operating parameter falls below this value, action associated with the alarm will be taken. The valid values are from -128 to 127.996.
High Warning	Specify the highest threshold for the warning. When the operating parameter rises above this value, action associated with the warning will be taken. The valid values are from -128 to 127.996.
Low Warning	Specify the lowest threshold for the warning. When the operating parameter falls below this value, action associated with the warning will be taken. The valid values are from -128 to 127.996.
LAG	Displays the LAG that the port belongs to.

- 2) Click **Apply**.

■ Configuring the Voltage Threshold

Figure 2-3 Configure Voltage Threshold

Voltage						
<input type="checkbox"/>	Port	High Alarm (0-6.5535 V)	Low Alarm (0-6.5535 V)	High Warning (0-6.5535 V)	Low Warning (0-6.5535 V)	LAG
<input type="checkbox"/>	1/0/49	---	---	---	---	--
<input type="checkbox"/>	1/0/50	---	---	---	---	--
<input type="checkbox"/>	1/0/51	---	---	---	---	--
<input type="checkbox"/>	1/0/52	---	---	---	---	--
<input type="checkbox"/>	1/0/53	---	---	---	---	--
<input type="checkbox"/>	1/0/54	---	---	---	---	--
Total: 6						

Follow these steps to configure DDM's voltage threshold:

- 1) In the **Voltage** table, select one or more SFP ports to configure voltage threshold on the SFP ports.

High Alarm Specify the highest threshold for the alarm. When the operating parameter rises above this value, action associated with the alarm will be taken. The valid values are from 0 to 6.5535.

Low Alarm Specify the lowest threshold for the alarm. When the operating parameter falls below this value, action associated with the alarm will be taken. The valid values are from 0 to 6.5535.

High Warning Specify the highest threshold for the warning. When the operating parameter rises above this value, action associated with the warning will be taken. The valid values are from 0 to 6.5535.

Low Warning Specify the lowest threshold for the warning. When the operating parameter falls below this value, action associated with the warning will be taken. The valid values are from 0 to 6.5535.

LAG Displays the LAG that the port belongs to.

- 2) Click **Apply**.

■ **Configuring the Bias Current Threshold**

Figure 2-4 Configure Bias Current Threshold

Bias Current						
<input type="checkbox"/>	Port	High Alarm (0-131 mA)	Low Alarm (0-131 mA)	High Warning (0-131 mA)	Low Warning (0-131 mA)	LAG
<input type="checkbox"/>	1/0/49	---	---	---	---	--
<input type="checkbox"/>	1/0/50	---	---	---	---	--
<input type="checkbox"/>	1/0/51	---	---	---	---	--
<input type="checkbox"/>	1/0/52	---	---	---	---	--
<input type="checkbox"/>	1/0/53	---	---	---	---	--
<input type="checkbox"/>	1/0/54	---	---	---	---	--
Total: 6						

Follow these steps to configure DDM’s bias current threshold:

- 1) In the **Bias Current** table, select one or more SFP ports to configure bias current threshold on the SFP ports.

High Alarm	Specify the highest threshold for the alarm. When the operating parameter rises above this value, action associated with the alarm will be taken. The valid values are from 0 to 131.
Low Alarm	Specify the lowest threshold for the alarm. When the operating parameter falls below this value, action associated with the alarm will be taken. The valid values are from 0 to 131.
High Warning	Specify the highest threshold for the warning. When the operating parameter rises above this value, action associated with the warning will be taken. The valid values are from 0 to 131.
Low Warning	Specify the lowest threshold for the warning. When the operating parameter falls below this value, action associated with the warning will be taken. The valid values are from 0 to 131.
LAG	Displays the LAG that the port belongs to.

- 2) Click **Apply**.

■ Configuring the Tx Power Threshold

Figure 2-5 Configure Tx Power Threshold

TX Power						
<input type="checkbox"/>	Port	High Alarm (0-6.5535 mW)	Low Alarm (0-6.5535 mW)	High Warning (0-6.5535 mW)	Low Warning (0-6.5535 mW)	LAG
<input type="checkbox"/>	1/0/49	---	---	---	---	--
<input type="checkbox"/>	1/0/50	---	---	---	---	--
<input type="checkbox"/>	1/0/51	---	---	---	---	--
<input type="checkbox"/>	1/0/52	---	---	---	---	--
<input type="checkbox"/>	1/0/53	---	---	---	---	--
<input type="checkbox"/>	1/0/54	---	---	---	---	--
Total: 6						

Follow these steps to configure DDM's Tx power threshold:

- 1) In the **TX Power** table, select one or more SFP ports to configure Tx power threshold on the SFP ports.

High Alarm	Specify the highest threshold for the alarm. When the operating parameter rises above this value, action associated with the alarm will be taken. The valid values are from 0 to 6.5535.
Low Alarm	Specify the lowest threshold for the alarm. When the operating parameter falls below this value, action associated with the alarm will be taken. The valid values are from 0 to 6.5535.
High Warning	Specify the highest threshold for the warning. When the operating parameter rises above this value, action associated with the warning will be taken. The valid values are from 0 to 6.5535.
Low Warning	Specify the lowest threshold for the warning. When the operating parameter falls below this value, action associated with the warning will be taken. The valid values are from 0 to 6.5535.
LAG	Displays the LAG that the port belongs to.

- 2) Click **Apply**.

■ Configuring the Rx Power Threshold

Figure 2-6 Configure Rx Power Threshold

RX Power						
<input type="checkbox"/>	Port	High Alarm (0-6.5535 mW)	Low Alarm (0-6.5535 mW)	High Warning (0-6.5535 mW)	Low Warning (0-6.5535 mW)	LAG
<input type="checkbox"/>	1/0/49	---	---	---	---	--
<input type="checkbox"/>	1/0/50	---	---	---	---	--
<input type="checkbox"/>	1/0/51	---	---	---	---	--
<input type="checkbox"/>	1/0/52	---	---	---	---	--
<input type="checkbox"/>	1/0/53	---	---	---	---	--
<input type="checkbox"/>	1/0/54	---	---	---	---	--
Total: 6						

Follow these steps to configure DDM's Rx power threshold:

- 1) In the **RX Power** table, select one or more SFP ports to configure Rx power threshold on the SFP ports.

High Alarm	Specify the highest threshold for the alarm. When the operating parameter rises above this value, action associated with the alarm will be taken. The valid values are from 0 to 6.5535.
Low Alarm	Specify the lowest threshold for the alarm. When the operating parameter falls below this value, action associated with the alarm will be taken. The valid values are from 0 to 6.5535.
High Warning	Specify the highest threshold for the warning. When the operating parameter rises above this value, action associated with the warning will be taken. The valid values are from 0 to 6.5535.
Low Warning	Specify the lowest threshold for the warning. When the operating parameter falls below this value, action associated with the warning will be taken. The valid values are from 0 to 6.5535.
LAG	Displays the LAG that the port belongs to.

- 2) Click **Apply**.

2.1.3 Viewing DDM Status

Choose the menu **L2 FEATURES > Switching > DDM > DDM Status** to load the following page.

Figure 2-7 View DDM Status

DDM Status								
Port	Temperature (°C)	Voltage (V)	Bias Current (mA)	TX Power (mW)	RX Power (mW)	Transmit Fault	Loss of Signal	Data Ready
1/0/49	--	--	--	--	--	--	--	--
1/0/50	--	--	--	--	--	--	--	--
1/0/51	--	--	--	--	--	--	--	--
1/0/52	--	--	--	--	--	--	--	--
1/0/53	--	--	--	--	--	--	--	--
1/0/54	--	--	--	--	--	--	--	--
Total: 6								

In the **DDM Status** table, view the current operating parameters for the SFP modules inserted into the SFP ports.

Temperature	Displays the current temperature of the SFP module inserted into a specific port.
Voltage	Displays the current voltage of the SFP module inserted into a specific port.
Bias Current	Displays the current bias current of the SFP module inserted into a specific port.
Tx Power	Displays the current Tx power of the SFP module inserted into a specific port.
Rx Power	Displays the current Rx power of the SFP module inserted into a specific port.
Transmit Fault	Reports remote SFP module signal loss. The values are True, False and No Signal.
Loss of Signal	Reports local SFP module signal loss. The values are True and False.
Data Ready	Indicates whether the SFP module is operational. The values are True and False.

2.2 Using the CLI

2.2.1 Configuring DDM Globally

Follow these steps to enable DDM on specified SFP ports:

Step 1	configure Enter global configuration mode.
--------	--

Step 2	interface { fastEthernet port range fastEthernet port-list gigabitEthernet port range gigabitEthernet port-list ten-gigabitEthernet port range ten-gigabitEthernet port-list } Enter interface configuration mode.
Step 3	ddm state enable Enable DDM on this SFP port.
Step 4	show ddm configuration state Display the DDM state of the SFP ports.
Step 5	end Return to Privileged EXEC Mode.
Step 6	copy running-config startup-config Save the settings in the configuration file.

The following example shows how to enable DDM status on SFP port 1/0/25:

Switch#configure

Switch(config)#interface gigabitEthernet 1/0/25

Switch(config-if)#ddm state enable

Switch(config-if)#show ddm configuration state

Port	DDM Status	Shutdown
Gi1/0/25	Enable	None
...		

Switch(config-if)#end

Switch#copy running-config startup-config

2.2.2 Configuring DDM Shutdown

Follow these steps to configure settings for shutting down SFP ports when the alarm threshold or warning threshold is exceeded:

Step 1	configure Enter global configuration mode.
Step 2	interface { fastEthernet port range fastEthernet port-list gigabitEthernet port range gigabitEthernet port-list ten-gigabitEthernet port range ten-gigabitEthernet port-list } Enter interface configuration mode.

Step 3	ddm shutdown { none warning alarm } none: The port will not be shut down if the alarm threshold or warning threshold is exceeded. warning: Shut down the port when the warning threshold is exceeded. alarm: Shut down the port when the alarm threshold is exceeded.
Step 4	show ddm configuration state Display the DDM state of the SFP ports.
Step 5	end Return to Privileged EXEC Mode.
Step 6	copy running-config startup-config Save the settings in the configuration file.

The following example shows how to set SFP port 1/0/25 to shut down when the warning threshold is exceeded.

Switch#configure

Switch(config)#interface gigabitEthernet 1/0/25

Switch(config-if)#ddm shutdown warning

Switch(config-if)#show ddm configuration state

	DDM Status	Shutdown
Gi1/0/25	Enable	Warning

...

Switch(config-if)#end

Switch#copy running-config startup-config

2.2.3 Configuring the Threshold

■ Configuring Temperature Threshold

Follow these steps to configure the threshold of the DDM temperature on the specified SFP port.

Step 1	configure Enter global configuration mode.
Step 2	interface { fastEthernet port range fastEthernet port-list gigabitEthernet port range gigabitEthernet port-list ten-gigabitEthernet port range ten-gigabitEthernet port-list } Enter interface configuration mode.

-
- Step 3 **ddm temperature_threshold { high_alarm | high_warning | low_alarm | low_warning } value**
- high_alarm:** Specify the high threshold for the alarm. When the operating parameter rises above this value, action associated with the alarm will be taken.
- high_warning:** Specify the high threshold for the warning. When the operating parameter rises above this value, action associated with the warning will be taken.
- low_alarm:** Specify the low threshold for the alarm. When the operating parameter falls below this value, action associated with the alarm will be taken.
- low_warning:** Specify the low threshold for the warning. When the operating parameter falls below this value, action associated with the warning will be taken.
- value:** Enter the threshold value in Celsius. The valid values are from -128 to 127.996.
-
- Step 4 **show ddm configuration temperature**
- Display the DDM temperature threshold on the SFP ports.
-
- Step 5 **end**
- Return to Privileged EXEC Mode.
-
- Step 6 **copy running-config startup-config**
- Save the settings in the configuration file.
-

The following example shows how to set SFP port 1/0/27's high alarm temperature threshold as 110 Celsius.

Switch#configure

Switch(config)#interface gigabitEthernet 1/0/27

Switch(config-if)#ddm temperature_threshold high_alarm 110

Switch(config-if)#show ddm configuration temperature

Temperature Threshold(Celsius) :

	High Alarm	Low Alarm	High Warning	Low Warning
Gi1/0/27	110.000000	--	--	--

...

Switch(config-if)#end

Switch#copy running-config startup-config

■ Configuring Voltage Threshold

Follow these steps to configure the threshold of the DDM voltage on the specified SFP port.

Step 1	configure Enter global configuration mode.
Step 2	interface { fastEthernet port range fastEthernet port-list gigabitEthernet port range gigabitEthernet port-list ten-gigabitEthernet port range ten-gigabitEthernet port-list } Enter interface configuration mode.
Step 3	ddm voltage_threshold { high_alarm high_warning low_alarm low_warning } value high_alarm: Specify the high threshold for the alarm. When the operating parameter rises above this value, action associated with the alarm will be taken. high_warning: Specify the high threshold for the warning. When the operating parameter rises above this value, action associated with the warning will be taken. low_alarm: Specify the low threshold for the alarm. When the operating parameter falls below this value, action associated with the alarm will be taken. low_warning: Specify the low threshold for the warning. When the operating parameter falls below this value, action associated with the warning will be taken. value: Enter the threshold value in V. The valid values are from 0 to 6.5535.
Step 4	show ddm configuration voltage Display the DDM voltage threshold of the SFP ports.
Step 5	end Return to Privileged EXEC Mode.
Step 6	copy running-config startup-config Save the settings in the configuration file.

The following example shows how to set SFP port 1/0/27's high alarm threshold voltage as 5 V.

Switch#configure

Switch(config)#interface gigabitEthernet 1/0/27

Switch(config-if)#ddm vlotage_threshold high_alarm 5

Switch(config-if)#show ddm configuration voltage

Voltage Threshold(V) :

	High Alarm	Low Alarm	High Warning	Low Warning
Gi1/0/27	5.000000	--	--	--

...

Switch(config-if)#end**Switch#copy running-config startup-config**

- **Configuring Bias Current Threshold**

Follow these steps to configure the threshold of the DDM bias current on the specified SFP port.

Step 1	configure Enter global configuration mode.
Step 2	interface { fastEthernet port range fastEthernet port-list gigabitEthernet port range gigabitEthernet port-list ten-gigabitEthernet port range ten-gigabitEthernet port-list } Enter interface configuration mode.
Step 3	ddm bias_current_threshold { high_alarm high_warning low_alarm low_warning } value high_alarm: Specify the high threshold for the alarm. When the operating parameter rises above this value, action associated with the alarm will be taken. high_warning: Specify the high threshold for the warning. When the operating parameter rises above this value, action associated with the warning will be taken. low_alarm: Specify the low threshold for the alarm. When the operating parameter falls below this value, action associated with the alarm will be taken. low_warning: Specify the low threshold for the warning. When the operating parameter falls below this value, action associated with the warning will be taken. value: Enter the threshold value in mA. The valid values are from 0 to 131.
Step 4	show ddm configuration bias_current Display the DDM bias current threshold of the SFP ports.
Step 5	end Return to Privileged EXEC Mode.
Step 6	copy running-config startup-config Save the settings in the configuration file.

The following example shows how to set SFP port 1/0/27's high alarm threshold bias current as 120 mA.

Switch#configure**Switch(config)#interface gigabitEthernet 1/0/17****Switch(config-if)#ddm vltage_threshold high_alarm 120****Switch(config-if)#show ddm configuration bias_current**

Voltage Threshold(V) :

High Alarm Low Alarm High Warning Low Warning

```
Gi1/0/27    120.000000  --          --          --
...

```

```
Switch(config-if)#end
```

```
Switch#copy running-config startup-config
```

■ Configuring Rx Power Threshold

Follow these steps to configure the threshold of the DDM Rx power on the specified SFP port.

Step 1	configure Enter global configuration mode.
Step 2	interface { fastEthernet port range fastEthernet port-list gigabitEthernet port range gigabitEthernet port-list ten-gigabitEthernet port range ten-gigabitEthernet port-list } Enter interface configuration mode.
Step 3	ddm rx_power_threshold { high_alarm high_warning low_alarm low_warning } value high_alarm: Specify the high threshold for the alarm. When the operating parameter rises above this value, action associated with the alarm will be taken. high_warning: Specify the high threshold for the warning. When the operating parameter rises above this value, action associated with the warning will be taken. low_alarm: Specify the low threshold for the alarm. When the operating parameter falls below this value, action associated with the alarm will be taken. low_warning: Specify the low threshold for the warning. When the operating parameter falls below this value, action associated with the warning will be taken. value: Enter the threshold value in mW. The valid values are from 0 to 6.5535.
Step 4	show ddm configuration rx_power Display the DDM rx power threshold on the SFP ports.
Step 5	end Return to Privileged EXEC Mode.
Step 6	copy running-config startup-config Save the settings in the configuration file.

The following example shows how to set SFP port 1/0/27's high alarm threshold Rx power as 6 mW.

```
Switch#configure
```

```
Switch(config)#interface gigabitEthernet 1/0/27
```

```
Switch(config-if)#ddm rx_power_threshold high_alarm 6
```

```
Switch(config-if)#show ddm configuration rx_power
```

Rx Power Threshold(mW) :

	High Alarm	Low Alarm	High Warning	Low Warning
Gi1/0/27	6.000000	--	--	--

...

Switch(config-if)#end

Switch#copy running-config startup-config

■ Configuring Tx Power Threshold

Follow these steps to configure the threshold of the DDM Tx power on the specified SFP port.

Step 1	configure Enter global configuration mode.
Step 2	interface { fastEthernet port range fastEthernet port-list gigabitEthernet port range gigabitEthernet port-list ten-gigabitEthernet port range ten-gigabitEthernet port-list } Enter interface configuration mode.
Step 3	ddm tx_power_threshold { high_alarm high_warning low_alarm low_warning } value high_alarm: Specify the high threshold for the alarm. When the operating parameter rises above this value, action associated with the alarm will be taken. high_warning: Specify the high threshold for the warning. When the operating parameter rises above this value, action associated with the warning will be taken. low_alarm: Specify the low threshold for the alarm. When the operating parameter falls below this value, action associated with the alarm will be taken. low_warning: Specify the low threshold for the warning. When the operating parameter falls below this value, action associated with the warning will be taken. value: Enter the threshold value in mW. The valid values are from 0 to 6.5535.
Step 4	show ddm configuration tx_power Display the DDM tx power threshold on the SFP ports.
Step 5	end Return to Privileged EXEC Mode.
Step 6	copy running-config startup-config Save the settings in the configuration file.

The following example shows how to set SFP port 1/0/27's high alarm threshold Tx power as 6 mW.

Switch#configure

```
Switch(config)#interface gigabitEthernet 1/0/27
```

```
Switch(config-if)#ddm tx_power_threshold high_alarm 6
```

```
Switch(config-if)#show ddm configuration tx_power
```

Tx Power Threshold(mW) :

	High Alarm	Low Alarm	High Warning	Low Warning
Gi1/0/27	6.000000	--	--	--

...

```
Switch(config-if)#end
```

```
Switch#copy running-config startup-config
```

2.2.4 Viewing DDM Configuration

Follow these steps to view the DDM configuration.

Step 1	configure Enter global configuration mode.
Step 2	show ddm configuration { state temperature voltage bias_current tx_power rx_power} state: Displays the DDM configuration state. temperature: Displays the threshold of the DDM temperature value. voltage: Displays the threshold of the DDM voltage value. bias_current: Displays the threshold of the DDM bias current value. tx_power: Displays the threshold of the DDM Tx Power value. rx_power: Displays the threshold of the DDM Rx Power value.
Step 3	end Return to Privileged EXEC Mode.
Step 4	copy running-config startup-config Save the settings in the configuration file.

The following example shows how to view SFP ports' Rx power threshold.

```
Switch#configure
```

```
Switch(config)#show ddm configuration rx_power
```

Rx Power Threshold(mW) :

	High Alarm	Low Alarm	High Warning	Low Warning
Gi1/0/27	6.000000	--	--	--

```
Gi1/0/28    --          --          --          --
```

```
Switch(config)#end
```

2.2.5 Viewing DDM Status

Follow these steps to view the DDM status, which is the digital diagnostic monitoring status of SFP modules inserted into the switch's SFP ports.

Step 1	configure	Enter global configuration mode.
Step 2	show ddm status	Displays all the monitoring status of SFP modules.
Step 3	end	Return to Privileged EXEC Mode.

The following example shows how to view SFP ports' DDM status.

```
Switch#configure
```

```
Switch(config)#show ddm status
```

	Temperature(C) Rx Power(mW)	Voltage(V) Data Ready	Bias Current(mA) Rx Los	Tx Power(mW) Tx Fault
Gi1/0/27	-- --	-- --	-- --	-- --
Gi1/0/28	-- --	-- --	-- --	-- --

```
Switch(config)#end
```

3 Appendix: Default Parameters

Default settings of DDM are listed in the following table.

Table 3-1 Default Settings of DDM

Parameter	Default Setting
DDM Status	Enabled. All the SFP ports are being monitored.
Shutdown	None. The port will not be shut down even if the alarm or warning threshold is exceeded.

Part 6

Configuring LAG

CHAPTERS

1. LAG
2. LAG Configuration
3. Configuration Examples
4. Appendix: Default Parameters

1 LAG

1.1 Overview

LAG (Link Aggregation Group) is to combine multiple physical ports together to make a single logical channel, which can greatly extend bandwidth. The bandwidth of the LAG is the sum of the bandwidth of its member ports.

1.2 Supported Features

You can configure LAG in two ways: static LAG and LACP (Link Aggregation Control Protocol).

Static LAG

The member ports are manually added to the LAG.

LACP

The switch uses LACP to implement dynamic link aggregation and disaggregation by exchanging LACP packets with its peer device. LACP extends the flexibility of the LAG configuration.

2 LAG Configuration

To complete LAG configuration, follow these steps:

- 1) Configure the global load-balancing algorithm.
- 2) Configure Static LAG or LACP.

Configuration Guidelines

- Ensure that both ends of the aggregation link work in the same LAG mode. For example, if the local end works in LACP mode, the peer end should also be set as LACP mode.
- Ensure that devices on both ends of the aggregation link use the same number of physical ports with the same speed, duplex, jumbo and flow control mode.
- A port cannot be added to more than one LAG at the same time.
- LACP does not support half-duplex links.
- One static LAG supports up to eight member ports. All the member ports share the bandwidth evenly. If an active link fails, the other active links share the bandwidth evenly.
- One LACP LAG supports multiple member ports, but at most eight of them can work simultaneously, and the other member ports are backups. Using LACP protocol, the switches negotiate parameters and determine the working ports. When a working port fails, the backup port with the highest priority will replace the faulty port and start to forward data.
- For the functions like IGMP Snooping, 802.1Q VLAN, MAC VLAN, Protocol VLAN, VLAN-VPN, GVRP, Voice VLAN, STP, QoS, DHCP Snooping and Flow Control, the member port of an LAG follows the configuration of the LAG but not its own. The configurations of the port can take effect only after it leaves the LAG.
- The port enabled with Port Security, Port Mirror, MAC Notification or 802.1X cannot be added to an LAG, and the member port of an LAG cannot be enabled with these functions.

2.1 Using the GUI

2.1.1 Configuring Load-balancing Algorithm

Choose the menu **L2 FEATURES > Switching > LAG > LAG Table** to load the following page.

Figure 2-1 Global Config

The screenshot shows the 'Global Config' interface. At the top, there is a 'Hash Algorithm:' label followed by a dropdown menu currently set to 'SRC MAC+DST MAC'. To the right of this is a blue 'Apply' button. Below this is the 'LAG Table' section, which contains a table with columns for 'Group ID', 'Description', 'Members', and 'Operation'. The table is currently empty, with the text 'No entries in this table.' centered below the header. A 'Delete' button is visible in the top right corner of the table area. At the bottom left of the table area, it says 'Total: 0'.

In the **Global Config** section, select the load-balancing algorithm (Hash Algorithm), then click **Apply**.

Hash Algorithm

Select the Hash Algorithm, based on which the switch can choose the port to forward packets. In this way, different data flows are forwarded on different physical links to implement load balancing. There are six options:

SRC MAC: The computation is based on the source MAC addresses of the packets.

DST MAC: The computation is based on the destination MAC addresses of the packets.

SRC MAC+DST MAC: The computation is based on the source and destination MAC addresses of the packets.

SRC IP: The computation is based on the source IP addresses of the packets.

DST IP: The computation is based on the destination IP addresses of the packets.

SRC IP+DST IP: The computation is based on the source and destination IP addresses of the packets.

Tips:

- Load-balancing algorithm is effective only for outgoing traffic. If the data stream is not well shared by each link, you can change the algorithm of the outgoing interface.
- Please properly choose the load-balancing algorithm to avoid data stream transferring only on one physical link. For example, Switch A receives packets from several hosts and forwards them to the Server with the fixed MAC address, you can set the algorithm

as "SRC MAC" to allow Switch A to determine the forwarding port based on the source MAC addresses of the received packets.

Figure 2-2 Hash Algorithm Configuration

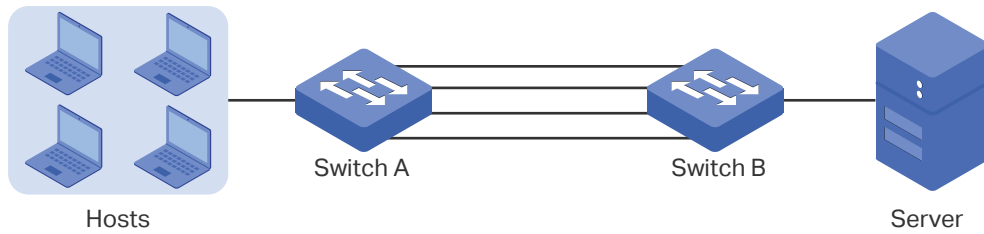

2.1.2 Configuring Static LAG or LACP

For one port, you can choose only one LAG mode: Static LAG or LACP. And make sure both ends of a link use the same LAG mode.

■ Configuring Static LAG

Choose the menu **L2 FEATURES > Switching > LAG > Static LAG** to load the following page.

Figure 2-3 Static LAG

LAG Config

Group ID:

Description:

Port: (Format: 1/0/1, input or choose below)

UNIT1

<input type="checkbox"/>	<input type="checkbox"/>	<input type="checkbox"/>	<input type="checkbox"/>	<input type="checkbox"/>	<input type="checkbox"/>	<input type="checkbox"/>	<input type="checkbox"/>	<input type="checkbox"/>	<input type="checkbox"/>	<input type="checkbox"/>	<input type="checkbox"/>	<input type="checkbox"/>	<input type="checkbox"/>	<input type="checkbox"/>	<input type="checkbox"/>	<input type="checkbox"/>
<input type="checkbox"/>	<input type="checkbox"/>	<input type="checkbox"/>	<input type="checkbox"/>	<input type="checkbox"/>	<input type="checkbox"/>	<input type="checkbox"/>	<input type="checkbox"/>	<input type="checkbox"/>	<input type="checkbox"/>	<input type="checkbox"/>	<input type="checkbox"/>	<input type="checkbox"/>	<input type="checkbox"/>	<input type="checkbox"/>	<input type="checkbox"/>	<input type="checkbox"/>
<input type="checkbox"/>	<input type="checkbox"/>	<input type="checkbox"/>	<input type="checkbox"/>	<input type="checkbox"/>	<input type="checkbox"/>	<input type="checkbox"/>	<input type="checkbox"/>	<input type="checkbox"/>	<input type="checkbox"/>	<input type="checkbox"/>	<input type="checkbox"/>	<input type="checkbox"/>	<input type="checkbox"/>	<input type="checkbox"/>	<input type="checkbox"/>	<input type="checkbox"/>
<input type="checkbox"/>	<input type="checkbox"/>	<input type="checkbox"/>	<input type="checkbox"/>	<input type="checkbox"/>	<input type="checkbox"/>	<input type="checkbox"/>	<input type="checkbox"/>	<input type="checkbox"/>	<input type="checkbox"/>	<input type="checkbox"/>	<input type="checkbox"/>	<input type="checkbox"/>	<input type="checkbox"/>	<input type="checkbox"/>	<input type="checkbox"/>	<input type="checkbox"/>

Selected

Unselected

Not Available

Follow these steps to configure the static LAG:

- 1) Select an LAG for configuration.

Group ID	Select an LAG for static LAG configuration.
Description	Displays the type of the LAG.

Port Enter the port number or simply click the port to choose the member ports of the LAG.

2) Select the member ports for the LAG. It is multi-optional.

3) Click **Apply**.

 **Note:**

Clearing all member ports will delete the LAG.

■ **Configuring LACP**

Choose the menu **L2 FEATURES > Switching > LAG > LACP** to load the following page.

Figure 2-4 LACP Config

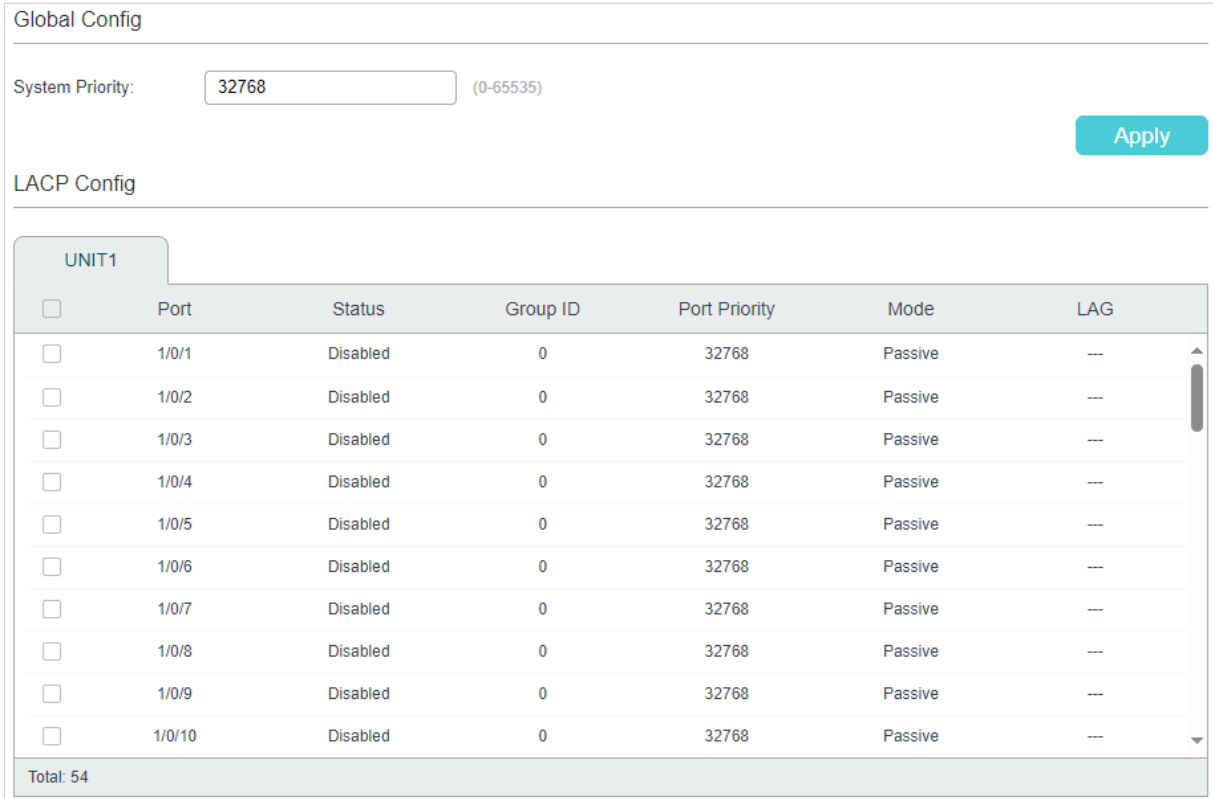

Global Config

System Priority: (0-65535) Apply

LACP Config

UNIT1						
<input type="checkbox"/>	Port	Status	Group ID	Port Priority	Mode	LAG
<input type="checkbox"/>	1/0/1	Disabled	0	32768	Passive	---
<input type="checkbox"/>	1/0/2	Disabled	0	32768	Passive	---
<input type="checkbox"/>	1/0/3	Disabled	0	32768	Passive	---
<input type="checkbox"/>	1/0/4	Disabled	0	32768	Passive	---
<input type="checkbox"/>	1/0/5	Disabled	0	32768	Passive	---
<input type="checkbox"/>	1/0/6	Disabled	0	32768	Passive	---
<input type="checkbox"/>	1/0/7	Disabled	0	32768	Passive	---
<input type="checkbox"/>	1/0/8	Disabled	0	32768	Passive	---
<input type="checkbox"/>	1/0/9	Disabled	0	32768	Passive	---
<input type="checkbox"/>	1/0/10	Disabled	0	32768	Passive	---
Total: 54						

Follow these steps to configure LACP:

1) Specify the system priority of the switch and click **Apply**.

System Priority Specify the system priority for the switch. A smaller value means a higher priority. When exchanging information between switches, the switch with higher priority determines the link aggregation a port belongs to, and the system with lower priority adds the proper ports to the link aggregation according to the selection of its peer.

- 2) Select the member port to be added to the LAG and configure the related parameters, then click **Apply**.

Port	Select one or more ports to configure.
Status	Enable or disable the LACP function of the port. By default, it is disabled.
Group ID	Specify the group ID of the LAG. Note that the value cannot be the same as the group number of other static LAGs. The valid value of the group ID is determined by the maximum number of LAG supported by your switch. For example, if your switch supports up to 14 LAGs, the valid value is from 1 to 14.
Port Priority (0-65535)	Specify the Port Priority. A smaller value means a higher port priority. The value ranges from 0 to 65535, and the default value is 32768. In an LAG, only eight ports can work simultaneously, the ports with higher priorities will be selected as the working port to forward data, and the other ports are backup ports. If two ports have the same priority value, the port with the smaller port number has the higher priority.
Mode	Select the LACP mode for the port. In LACP, the switch uses LACPDU (Link Aggregation Control Protocol Data Unit) to compare the LACP parameters with the peer end's. In this way, the two ends select working ports and form the aggregation link. The LACP mode determines whether the port will take the initiative to send the LACPDU at the beginning of the LACP process. There are two modes: Passive: The port will not send LACPDU before receiving the LACPDU from the peer end. Active: The port will take the initiative to send LACPDU.
LAG	Displays the LAG that the port belongs to.

2.2 Using the CLI

2.2.1 Configuring Load-balancing Algorithm

Follow these steps to configure the load-balancing algorithm:

Step 1	configure Enter global configuration mode.
--------	--

Step 2	port-channel load-balance { src-mac dst-mac src-dst-mac src-ip dst-ip src-dst-ip }
	Select the Hash Algorithm. The switch will choose the ports to transfer the packets based on the Hash Algorithm. In this way, different data flows are forwarded on different physical links to implement load balancing.
	src-mac: The computation is based on the source MAC addresses of the packets.
	dst-mac: The computation is based on the destination MAC addresses of the packets.
	src-dst-mac: The computation is based on the source and destination MAC addresses of the packets.
	src-ip: The computation is based on the source IP addresses of the packets.
	dst-ip: The computation is based on the destination IP addresses of the packets.
	src-dst-ip: The computation is based on the source and destination IP addresses of the packets.
Step 3	show etherchannel load-balance
	Verify the configuration of load-balancing algorithm.
Step 4	end
	Return to privileged EXEC mode.
Step 5	copy running-config startup-config
	Save the settings in the configuration file.

The following example shows how to set the global load-balancing mode as src-dst-mac:

Switch#configure

Switch(config)#port-channel load-balance src-dst-mac

Switch(config)#show etherchannel load-balance

EtherChannel Load-Balancing Configuration:

src-dst-mac

EtherChannel Load-Balancing Addresses Used Per-Protocol:

Non-IP: Source XOR Destination MAC address

IPv4: Source XOR Destination MAC address

IPv6: Source XOR Destination MAC address

Switch(config)#end

Switch#copy running-config startup-config

2.2.2 Configuring Static LAG or LACP

You can choose only one LAG mode for a port: Static LAG or LACP. And make sure both ends of a link use the same LAG mode.

■ Configuring Static LAG

Follow these steps to configure static LAG:

Step 1	configure Enter global configuration mode.
Step 2	interface {fastEthernet port range fastEthernet port-list gigabitEthernet port range gigabitEthernet port-list ten-gigabitEthernet port range ten-gigabitEthernet port-list } Enter interface configuration mode.
Step 3	channel-group num mode on Add the port to a static LAG. <i>num</i> : The group ID of the LAG.
Step 4	show etherchannel num summary Verify the configuration of the static LAG. <i>num</i> : The group ID of the LAG.
Step 5	end Return to privileged EXEC mode.
Step 6	copy running-config startup-config Save the settings in the configuration file.

The following example shows how to add ports 1/0/5-8 to LAG 2 and set the mode as static LAG:

```
Switch#configure
```

```
Switch(config)#interface range gigabitEthernet 1/0/5-8
```

```
Switch(config-if-range)#channel-group 2 mode on
```

```
Switch(config-if-range)#show etherchannel 2 summary
```

```
Flags: D - down          P - bundled in port-channel    U - in use
```

```
       I - stand-alone   H - hot-standby(LACP only)    s - suspended
```

```
       R - layer3        S - layer2          f - failed to allocate aggregator
```

```
       u - unsuitable for bundling  w - waiting to be aggregated  d - default port
```

Group	Port-channel	Protocol	Ports
-----	-----	-----	-----
2	Po2(S)	-	Gi1/0/5(D) Gi1/0/6(D) Gi1/0/7(D) Gi1/0/8(D)

Switch(config-if-range)#end

Switch#copy running-config startup-config

■ Configuring LACP

Follow these steps to configure LACP:

Step 1	<p>configure</p> <p>Enter global configuration mode.</p>
Step 2	<p>lacp system-priority pri</p> <p>Specify the system priority for the switch.</p> <p>To keep active ports consistent at both ends, you can set the priority of one device to be higher than that of the other device. The device with higher priority will determine its active ports, and the other device can select its active ports according to the selection result of the device with higher priority. If the two ends have the same system priority value, the end with a smaller MAC address has the higher priority.</p> <p>pri: System priority. The valid values are from 0 to 65535, and the default value is 32768. A smaller value means a higher device priority.</p>
Step 3	<p>interface {fastEthernet port range fastEthernet port-list gigabitEthernet port range gigabitEthernet port-list ten-gigabitEthernet port range ten-gigabitEthernet port-list }</p> <p>Enter interface configuration mode.</p>
Step 4	<p>channel-group num mode { active passive }</p> <p>Add the port to an LAG and set the mode as LACP.</p> <p>num: The group ID of the LAG.</p> <p>mode: LAG mode. Here you need to select LACP mode: active or passive.</p> <p>In LACP, the switch uses LACPDU (Link Aggregation Control Protocol Data Unit) to negotiate the parameters with the peer end. In this way, the two ends select active ports and form the aggregation link. The LACP mode determines whether the port will take the initiative to send the LACPDU.</p> <p>passive: The port will not send LACPDU before receiving the LACPDU from the peer end.</p> <p>active: The port will take the initiative to send LACPDU.</p>
Step 5	<p>lacp port-priority pri</p> <p>Specify the Port Priority. The port with higher priority in an LAG will be selected as the working port. If two ports have the same priority value, the port with a smaller port number has the higher priority.</p> <p>pri: Port priority. The valid values are from 0 to 65535, and the default value is 32768. A smaller value means a higher port priority.</p>

Step 6	show lacp sys-id Verify the global system priority.
Step 7	show lacp internal Verify the LACP configuration of the local switch.
Step 8	end Return to privileged EXEC mode.
Step 9	copy running-config startup-config Save the settings in the configuration file.

The following example shows how to specify the system priority of the switch as 2:

Switch#configure

Switch(config)#lacp system-priority 2

Switch(config)#show lacp sys-id

2,000a.eb13.2397

Switch(config)#end

Switch#copy running-config startup-config

The following example shows how to add ports 1/0/1-4 to LAG 6, set the mode as LACP, and select the LACPDU sending mode as active:

Switch#configure

Switch(config)#interface range gigabitEthernet 1/0/1-4

Switch(config-if-range)#channel-group 6 mode active

Switch(config-if-range)#show lacp internal

Flags: S - Device is requesting Slow LACPDU

F - Device is requesting Fast LACPDU

A - Device is in active mode

P - Device is in passive mode

Channel group 6

Port	Flags	State	LACP Port Priority	Admin Key	Oper Key	Port Number	Port State
Gi1/0/1	SA	Up	32768	0x6	0x4b1	0x1	0x7d
Gi1/0/2	SA	Down	32768	0x6	0	0x2	0x45
Gi1/0/3	SA	Down	32768	0x6	0	0x3	0x45

```
Gi1/0/4 SA Down 32768 0x6 0 0x4 0x45
```

```
Switch(config-if-range)#end
```

```
Switch#copy running-config startup-config
```

3 Configuration Examples

3.1 Example for Static LAG

3.1.1 Network Requirements

As shown below, hosts and servers are connected to switch A and switch B, and heavy traffic is transmitted between the two switches. To achieve high speed and reliability of data transmission, users need to improve the bandwidth and redundancy of the link between the two switches.

Figure 3-1 Network Topology

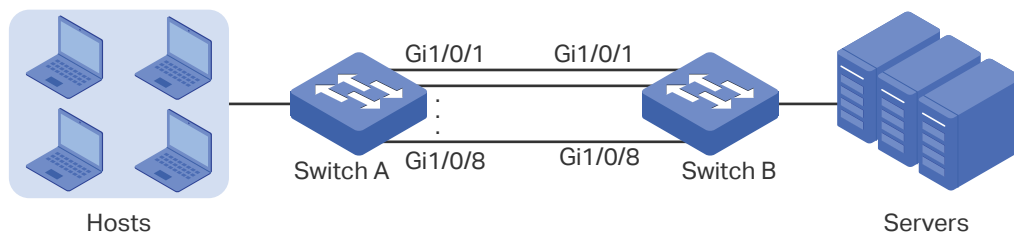

3.1.2 Configuration Scheme

LAG function can bundle multiple physical ports into one logical interface to increase bandwidth and improve reliability. In this case we can configure static LAG to meet the requirement.

The overview of the configuration is as follows:

- 1) Considering there are multiple devices on each end, configure the load-balancing algorithm as 'SRC MAC+DST MAC'.
- 2) Add ports 1/0/1-8 to a static LAG.

Demonstrated with SG6654XHP, the following sections provide configuration procedure in two ways: using the GUI and using the CLI.

3.1.3 Using the GUI

The configurations of switch A and switch B are similar. The following introductions take switch A as an example.

- 1) Choose the menu **L2 FEATURES > Switching > LAG > LAG Table** to load the following page. Select the hash algorithm as 'SRC MAC+DST MAC'.

Figure 3-2 Global Configuration

Global Config

Hash Algorithm: SRC MAC+DST MAC

Apply

- 2) Choose the menu **L2 FEATURES > Switching > LAG > Static LAG** to load the following page. Select LAG 1 and add ports 1/0/1-8 to LAG 1.

Figure 3-3 System Priority Configuration

LAG Config

Group ID: LAG1

Description: --

Port: 1/0/1-8 (Format: 1/0/1, input or choose below)

UNIT1

1	3	5	7	9	11	13	15	17	19	21	23	25	27	29	31	33	35
2	4	6	8	10	12	14	16	18	20	22	24	26	28	30	32	34	36
37	39	41	43	45	47	49	51	53									
38	40	42	44	46	48	50	52	54									

Selected
 Unselected
 Not Available

Apply

- 3) Click Save to save the settings.

3.1.4 Using the CLI

The configurations of switch A and switch B are similar. The following introductions take switch A as an example.

- 1) Configure the load-balancing algorithm as "src-dst-mac".

```
Switch#configure
```

```
Switch(config)#port-channel load-balance src-dst-mac
```

- 2) Add ports 1/0/1-8 to static LAG 1.

```
Switch(config)#interface range gigabitEthernet 1/0/1-8
```

```
Switch(config-if-range)#channel-group 1 mode on
```

```
Switch(config-if)#end
```

```
Switch#copy running-config startup-config
```

Verify the Configuration

```
Switch#show etherchannel 1 summary
```

Flags: D - down P - bundled in port-channel U - in use
 I - stand-alone H - hot-standby(LACP only) s - suspended
 R - layer3 S - layer2 f - failed to allocate aggregator
 u - unsuitable for bundling w - waiting to be aggregated d - default port

Group	Port-channel	Protocol	Ports
-----	-----	-----	-----
1	Po2(S)	-	Gi1/0/1(D) Gi1/0/2(D) Gi1/0/3(D) Gi1/0/4(D) Gi1/0/5(D) Gi1/0/6(D) Gi1/0/7(D) Gi1/0/8(D)

3.2 Example for LACP

3.2.1 Network Requirements

As shown below, hosts and servers are connected to Switch A and Switch B, and heavy traffic is transmitted between the two switches. To achieve high speed and reliability of data transmission, users need to improve the bandwidth and redundancy of the link between the two switches.

3.2.2 Configuration Scheme

LAG function can bundle multiple physical ports into one logical interface to increase bandwidth and improve reliability. In this case, we take LACP as an example.

As shown below, you can bundle up to eight physical ports into one logical aggregation group to transmit data between the two switches, and respectively connect the ports of the groups. In addition, another two redundant links can be set as the backup. To avoid traffic bottleneck between the servers and Switch B, you also need to configure LAG on them to increase link bandwidth. Here we mainly introduce the LAG configuration between the two switches.

Figure 3-1 Network Topology

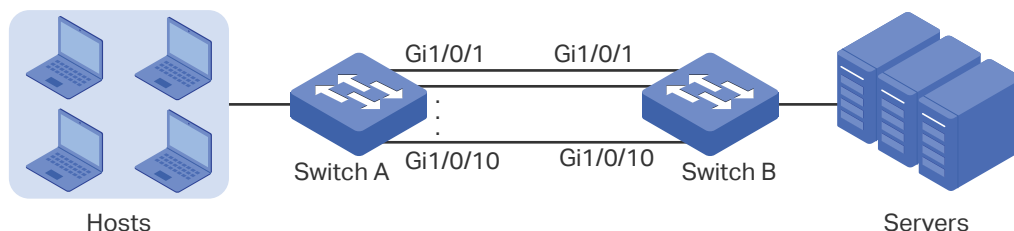

The overview of the configuration is as follows:

- 1) Considering there are multiple devices on each end, configure the load-balancing algorithm as 'SRC MAC+DST MAC'.

- 2) Specify the system priority for the switches. Here we choose Switch A as the dominate device and specify a higher system priority for it.
- 3) Add ports 1/0/1-10 to the LAG and set the mode as LACP.
- 4) Specify a lower port priority for ports 1/0/9-10 to set them as the backup ports. When any of ports 1/0/1-8 is down, the backup ports will automatically be enabled to transmit data.

Demonstrated with SG6654XHP, the following sections provide configuration procedure in two ways: using the GUI and using the CLI.

3.2.3 Using the GUI

The configurations of Switch A and Switch B are similar. The following introductions take Switch A as an example.

- 1) Choose the menu **L2 FEATURES > Switching > LAG > LAG Table** to load the following page. Select the hash algorithm as 'SRC MAC+DST MAC'.

Figure 3-2 Global Configuration

The screenshot shows a web interface titled "Global Config". Under the "Hash Algorithm:" label, a dropdown menu is open, displaying "SRC MAC+DST MAC" with a downward arrow. To the right of the dropdown is a red-bordered "Apply" button.

- 2) Choose the menu **L2 FEATURES > Switching > LAG > LACP Config** to load the following page. In the **Global Config** section, specify the system priority of Switch A as **0** and Click **Apply**. Remember to ensure that the system priority value of Switch B is bigger than 0.

Figure 3-3 System Priority Configuration

The screenshot shows a web interface titled "Global Config". Under the "System Priority:" label, there is a text input field containing the number "0". To the right of the input field is the text "(0-65535)". To the right of the entire section is a red-bordered "Apply" button.

- 3) In the **LACP Config** section, select ports 1/0/1-10, and respectively set the status, group ID, port priority and mode for each port as follows.

Figure 3-4 LACP Configuration

LACP Config

UNIT1

<input type="checkbox"/>	Port	Status	Group ID	Port Priority	Mode	LAG
		Enable ▾	1	0	Active ▾	
<input checked="" type="checkbox"/>	1/0/1	Enabled	1	0	Active	---
<input checked="" type="checkbox"/>	1/0/2	Enabled	1	0	Active	---
<input checked="" type="checkbox"/>	1/0/3	Enabled	1	0	Active	---
<input checked="" type="checkbox"/>	1/0/4	Enabled	1	0	Active	---
<input checked="" type="checkbox"/>	1/0/5	Enabled	1	0	Active	---
<input checked="" type="checkbox"/>	1/0/6	Enabled	1	0	Active	---
<input checked="" type="checkbox"/>	1/0/7	Enabled	1	0	Active	---
<input checked="" type="checkbox"/>	1/0/8	Enabled	1	0	Active	---
<input checked="" type="checkbox"/>	1/0/9	Enabled	1	0	Active	---
<input checked="" type="checkbox"/>	1/0/10	Enabled	1	0	Active	---

Total: 54 10 entries selected.

Cancel Apply

- 4) Click  Save to save the settings.

3.2.4 Using the CLI

The configurations of Switch A and Switch B are similar. The following introductions take Switch A as an example.

- 1) Configure the load-balancing algorithm as "src-dst-mac".

```
Switch#configure
```

```
Switch(config)#port-channel load-balance src-dst-mac
```

- 2) Specify the system priority of Switch A as 0. Remember to ensure that the system priority value of Switch B is bigger than 0.

```
Switch(config)#lacp system-priority 0
```

- 3) Add ports 1/0/1-8 to LAG 1 and set the mode as LACP. Then specify the port priority as 0 to make them active.

```
Switch(config)#interface range gigabitEthernet 1/0/1-8
```

```
Switch(config-if-range)#channel-group 1 mode active
```

```
Switch(config-if-range)#lacp port-priority 0
```

```
Switch(config-if-range)#exit
```

- 4) Add port 1/0/9 to LAG 1 and set the mode as LACP. Then specify the port priority as 1 to set it as a backup port. When any of the active ports is down, this port will be preferentially selected to work as an active port.

```
Switch(config)#interface gigabitEthernet 1/0/9
```

```
Switch(config-if)#channel-group 1 mode active
```

```
Switch(config-if)#lacp port-priority 1
```

```
Switch(config-if)#exit
```

- 5) Add port 1/0/10 to LAG 1 and set the mode as LACP. Then specify the port priority as 2 to set it as a backup port. The priority of this port is lower than port 1/0/9.

```
Switch(config)#interface gigabitEthernet 1/0/10
```

```
Switch(config-if)#channel-group 1 mode active
```

```
Switch(config-if)#lacp port-priority 2
```

```
Switch(config-if)#end
```

```
Switch#copy running-config startup-config
```

Verify the Configuration

Verify the system priority:

```
Switch#show lacp sys-id
```

```
0,000a.eb13.2397
```

Verify the LACP configuration:

```
Switch#show lacp internal
```

```
Flags: S - Device is requesting Slow LACPDUs
```

```
      F - Device is requesting Fast LACPDUs
```

```
      A - Device is in active mode
```

```
      P - Device is in passive mode
```

Channel group 1

Port	Flags	State	LACP Port Priority	Admin Key	Oper Key	Port Number	Port State
Gi1/0/1	SA	Down	0	0x1	0	0x1	0x45
Gi1/0/2	SA	Down	0	0x1	0	0x2	0x45
Gi1/0/3	SA	Down	0	0x1	0	0x3	0x45
Gi1/0/4	SA	Down	0	0x1	0	0x4	0x45
Gi1/0/5	SA	Down	0	0x1	0	0x5	0x45
Gi1/0/6	SA	Down	0	0x1	0	0x6	0x45
Gi1/0/7	SA	Down	0	0x1	0	0x7	0x45

Gi1/0/8	SA	Down	0	0x1	0	0x8	0x45
Gi1/0/9	SA	Down	1	0x1	0	0x9	0x45
Gi1/0/10	SA	Down	2	0x1	0	0xa	0x45

4 Appendix: Default Parameters

Default settings of Switching are listed in the following tables.

Table 4-1 Default Settings of LAG

Parameter	Default Setting
LAG Table	
Hash Algorithm	SRC MAC+DST MAC
LACP Config	
System Priority	32768
Admin Key	0
Port Priority	32768
Mode	Passive
Status	Disabled

Part 7

Managing MAC Address Table

CHAPTERS

1. MAC Address Table
2. MAC Address Configurations
3. Security Configurations
4. Example for Security Configurations
5. Appendix: Default Parameters

1 MAC Address Table

1.1 Overview

The MAC address table contains address information that the switch uses to forward packets. As shown below, the table lists map entries of MAC addresses, VLAN IDs and ports. These entries can be manually added or automatically learned by the switch. Based on the MAC-address-to-port mapping in the table, the switch can forward packets only to the associated port.

Table 1-1 The MAC Address Table

MAC Address	VLAN ID	Port	Type	Aging Status
00:00:00:00:00:01	1	1	Dynamic	Aging
00:00:00:00:00:02	1	2	Static	No-Aging
...				

1.2 Supported Features

The address table of the switch contains dynamic addresses, static addresses and filtering addresses. For devices which support security configurations, you can configure notification traps and limit the number of MAC addresses in a VLAN for traffic safety.

Address Configurations

■ Dynamic address

Dynamic addresses are addresses learned by the switch automatically, and the switch regularly ages out those that are not in use. That is, the switch removes the MAC address entries related to a network device if no packet is received from the device within the aging time. And you can specify the aging time if needed.

■ Static address

Static addresses are manually added to the address table and do not age. For some relatively fixed connection, for example, frequently visited server, you can manually set the MAC address of the server as a static entry to enhance the forwarding efficiency of the switch.

- Filtering address

The filtering address entry is used to block the undesired packets from being forwarded. The filtering address can be added or removed manually and does not age.

Security Configurations

 Note:

Security Configurations are only available on certain devices. To check whether your device supports this feature, refer to the actual web interface. If Security Configurations are available, there are **L2 FEATURES > Switching > MAC Address > MAC Notifications** and **L2 FEATURES > Switching > MAC Address > MAC VLAN Security** in the menu structure.

- Configuring MAC Notification Traps

You can configure traps and SNMP (Simple Network Management Protocol) to monitor and receive notifications of the usage of the MAC address table and the MAC address change activity. For example, you can configure the switch to send notifications when a new MAC address is learned, so the administrator knows a new users accesses the network.

- Limiting the Number of MAC Addresses in VLANs

You can configure VLAN Security to limit the number of MAC addresses that can be learned in specified VLANs. The switch will not learn addresses when the number of learned addresses has reached the limit, preventing the address table from being used up by broadcasting packets of MAC address attacks.

2 MAC Address Configurations

With MAC address table, you can:

- Add static MAC address entries
- Change the MAC address aging time
- Add filtering address entries
- View address table entries

2.1 Using the GUI

2.1.1 Adding Static MAC Address Entries

You can add static MAC address entries by manually specifying the desired MAC address or binding dynamic MAC address entries.

- Adding MAC Addresses Manually

Choose the menu **L2 FEATURES > Switching > MAC Address > Static Address** and click  **Add** to load the following page.

Figure 2-1 Adding MAC Addresses Manually



Follow these steps to add a static MAC address entry:

- 1) Enter the MAC address, VLAN ID and select a port to bind them together as an address entry.

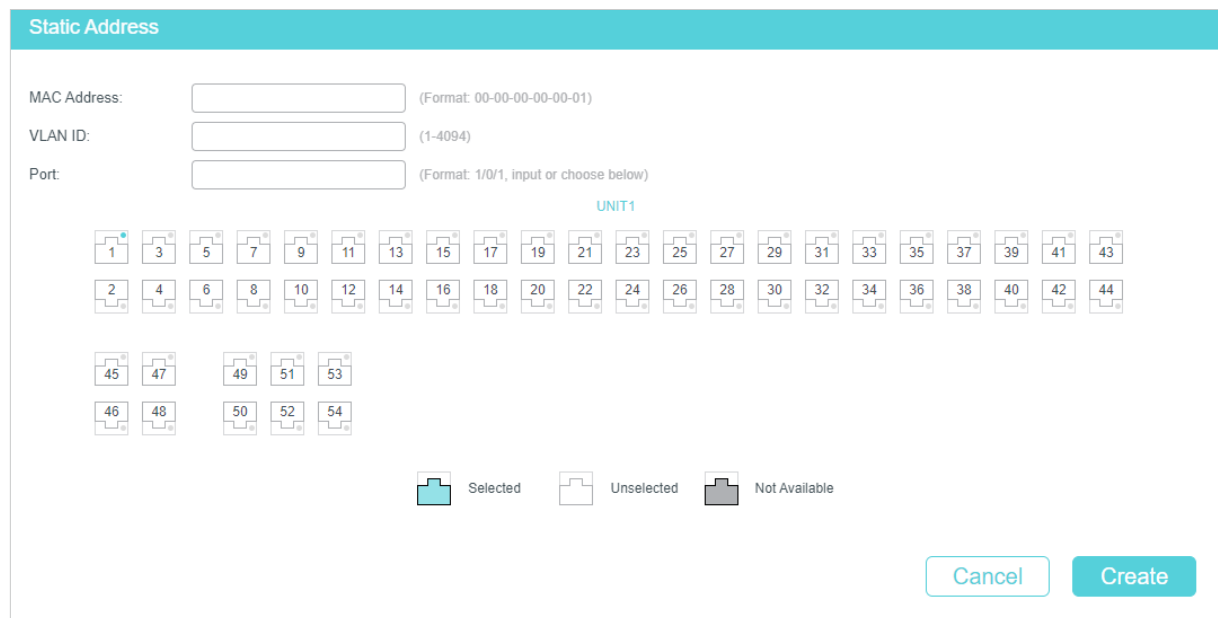
MAC Address	Enter the MAC address included in the static entry.
VLAN ID	Enter the VLAN ID included in the static entry.
Port	Select the corresponding port included in the static entry. The port must belong to the specified VLAN. After you have added the static MAC address, if the corresponding port number of the MAC address is not correct, or the connected port (or the device) has been changed, the switch cannot forward the packets correctly. Please reset the static address entry appropriately.

2) Click **Create**.

■ **Binding Dynamic Address Entries**

If some dynamic address entries are frequently used, you can bind these entries as static entries.

Choose the menu **L2 FEATURES > Switching > MAC Address > Dynamic Address** to load the following page.

Figure 2-2 Binding Dynamic MAC Address Entries

Aging Config

Auto Aging: Enable

Aging Time: seconds (10-630)

Apply

Dynamic Address Table

Search: All

UNIT1	MAC Address	VLAN ID	Port	Type	Aging Status
<input type="checkbox"/>	40-ED-00-22-30-40	1	1/0/1	Dynamic	Aging

Total: 1

Showing 1-1 of 1 records Items per page:

Follow these steps to bind dynamic MAC address entries:

- 1) In the **Dynamic Address Table** section, Select your desired MAC address entries.
- 2) Click **Bind**, and then the selected entries will become static MAC address entries.

Note:

- In the same VLAN, once an address is configured as a static address, it cannot be set as a filtering address, and vice versa.
- Multicast or broadcast addresses cannot be set as static addresses.
- Ports in LAGs (Link Aggregation Group) are not supported for static address configuration.

2.1.2 Modifying the Aging Time of Dynamic Address Entries

Choose the menu **L2 FEATURES > Switching > MAC Address > Dynamic Address** to load the following page.

Figure 2-3 Modifying the Aging Time of Dynamic Address Entries

The screenshot shows a configuration page titled "Aging Config". It has two main settings: "Auto Aging" which is checked and labeled "Enable", and "Aging Time" which is set to "300" in a text box, with the unit "seconds (10-630)" indicated to the right. A blue "Apply" button is located in the bottom right corner of the form.

Follow these steps to modify the aging time of dynamic address entries:

- 1) In the **Aging Config** section, enable Auto Aging, and enter your desired length of time.

Auto Aging	Enable or disable auto aging for the dynamic MAC address entries.
Aging Time	Specify the aging time for the dynamic MAC address entry. It is the duration that a dynamic entry remains in the MAC address table after the entry is used or updated. The valid values are from 10 to 630 seconds, and the default value is 300.

- 2) Click **Apply**.

2.1.3 Adding MAC Filtering Address Entries

Choose the menu **L2 FEATURES > Switching > MAC Address > Filtering Address** and click **+ Add** to load the following page.

Figure 2-4 Adding MAC Filtering Address Entries

The screenshot shows a form titled "Filtering Address". It contains two input fields: "MAC Address" with a format hint "(Format: 00-00-00-00-00-01)" and "VLAN ID" with a format hint "(1-4094)". At the bottom right, there are two buttons: "Cancel" and "Create".

Follow these steps to add MAC filtering address entries:

- 1) Enter the MAC Address and VLAN ID.

MAC Address	Enter the MAC address included in the filtering address entry.
VLAN ID	Enter the VLAN ID included in the filtering address entry.

- 2) Click **Create**.

Note:

- In the same VLAN, once an address is configured as a filtering address, it cannot be set as a static address, and vice versa.
- Multicast or broadcast addresses cannot be set as filtering addresses .

2.1.4 Viewing Address Table Entries

You can view entries in MAC address table to check your former operations and address information.

Choose the menu **L2 FEATURES > Switching > MAC Address > Address Table** and click  **Search** to load the following page.

Figure 2-5 Viewing Address Table Entries

Address Table  Search ^

MAC Address (Format: 00-00-00-00-00-01)

VLAN ID (1-4094)

Type Dynamic Static Filter

Port

MAC Address	VLAN ID	Port	Type	Aging Status
40-ED-00-22-30-40	1	1/0/1	Dynamic	Aging
Total: 1				

2.2 Using the CLI

2.2.1 Adding Static MAC Address Entries

Follow these steps to add static MAC address entries:

-
- Step 1 **configure**
- Enter global configuration mode.
-

Step 2 **mac address-table static** *mac-addr* **vid** *vid* **interface** { *fastEthernet port* | **gigabitEthernet port** | **ten-gigabitEthernet port** }

Bind the MAC address, VLAN and port together to add a static address to the VLAN.

mac-addr: Enter the MAC address, and packets with this destination address received in the specified VLAN are forwarded to the specified port. The format is xx:xx:xx:xx:xx:xx, for example, 00:00:00:00:00:01.

vid: Specify an existing VLAN in which packets with the specific MAC address are received.

port: Specify a port to which packets with the specific MAC address are forwarded. The port must belong to the specified VLAN.

Step 3 **end**

Return to privileged EXEC mode.

Step 4 **copy running-config startup-config**

Save the settings in the configuration file.

 **Note:**

- In the same VLAN, once an address is configured as a static address, it cannot be set as a filtering address, and vice versa.
- Multicast or broadcast addresses cannot be set as static addresses.
- Ports in LAGs (Link Aggregation Group) are not supported for static address configuration.

The following example shows how to add a static MAC address entry with MAC address 00:02:58:4f:6c:23, VLAN 10 and port 1. When a packet is received in VLAN 10 with this address as its destination, the packet will be forwarded only to port 1/0/1.

Switch#configure

Switch(config)# mac address-table static 00:02:58:4f:6c:23 vid 10 interface gigabitEthernet 1/0/1

Switch(config)#show mac address-table static

MAC Address Table

MAC	VLAN	Port	Type	Aging
00:02:58:4f:6c:23	10	Gi1/0/1	config static	no-aging

Total MAC Addresses for this criterion: 1

Switch(config)#end

Switch#copy running-config startup-config

2.2.2 Modifying the Aging Time of Dynamic Address Entries

Follow these steps to modify the aging time of dynamic address entries:

Step 1	configure Enter global configuration mode.
Step 2	mac address-table aging-time <i>aging-time</i> Set your desired length of address aging time for dynamic address entries. <i>aging-time</i> : Set the length of time that a dynamic entry remains in the MAC address table after the entry is used or updated. The valid values are from 10 to 630. Value 0 means the Auto Aging function is disabled. The default value is 300 and we recommend you keep the default value if you are unsure.
Step 3	end Return to privileged EXEC mode.
Step 4	copy running-config startup-config Save the settings in the configuration file.

The following example shows how to modify the aging time to 500 seconds. A dynamic entry remains in the MAC address table for 500 seconds after the entry is used or updated.

Switch#configure

Switch(config)# mac address-table aging-time 500

Switch(config)#show mac address-table aging-time

Aging time is 500 sec.

Switch(config)#end

Switch#copy running-config startup-config

2.2.3 Adding MAC Filtering Address Entries

Follow these steps to add MAC filtering address entries:

Step 1	configure Enter global configuration mode.
Step 2	mac address-table filtering <i>mac-addr vid vid</i> Add the filtering address to the VLAN. <i>mac-addr</i> : Specify a MAC address to be used by the switch to filter the received packets. The switch will drop packets of which the source address or destination address is the specified MAC address. The format is xx:xx:xx:xx:xx:xx, for example, 00:00:00:00:00:01. <i>vid</i> : Specify an existing VLAN in which packets with the specific MAC address will be dropped.

Step 3 **end**
Return to privileged EXEC mode.

Step 4 **copy running-config startup-config**
Save the settings in the configuration file.

 **Note:**

- In the same VLAN, once an address is configured as a filtering address, it cannot be set as a static address, and vice versa.
- Multicast or broadcast addresses cannot be set as filtering addresses.

The following example shows how to add the MAC filtering address 00:1e:4b:04:01:5d to VLAN 10. Then the switch will drop the packet that is received in VLAN 10 with this address as its source or destination.

Switch#configure

Switch(config)# mac address-table filtering 00:1e:4b:04:01:5d vid 10

Switch(config)#show mac address-table filtering

MAC Address Table

```
-----
MAC                VLAN  Port  Type    Aging
-----
00:1e:4b:04:01:5d  10           filter no-aging
```

Total MAC Addresses for this criterion: 1

Switch(config)#end

Switch#copy running-config startup-config

3 Security Configurations

 Note:

Security Configurations are only available on certain devices. To check whether your device supports this feature, refer to the actual web interface. If Security Configurations are available, there are **L2 FEATURES > Switching > MAC Address > MAC Notifications** and **L2 FEATURES > Switching > MAC Address > MAC VLAN Security** in the menu structure.

With security configurations of the MAC address table, you can:

- Configure MAC notification traps
- Limit the number of MAC addresses in VLANs

3.1 Using the GUI

3.1.1 Configuring MAC Notification Traps

Choose the menu **L2 FEATURES > Switching > MAC Address > MAC Notification** to load the following page.

Figure 3-1 Configuring MAC Notification Traps

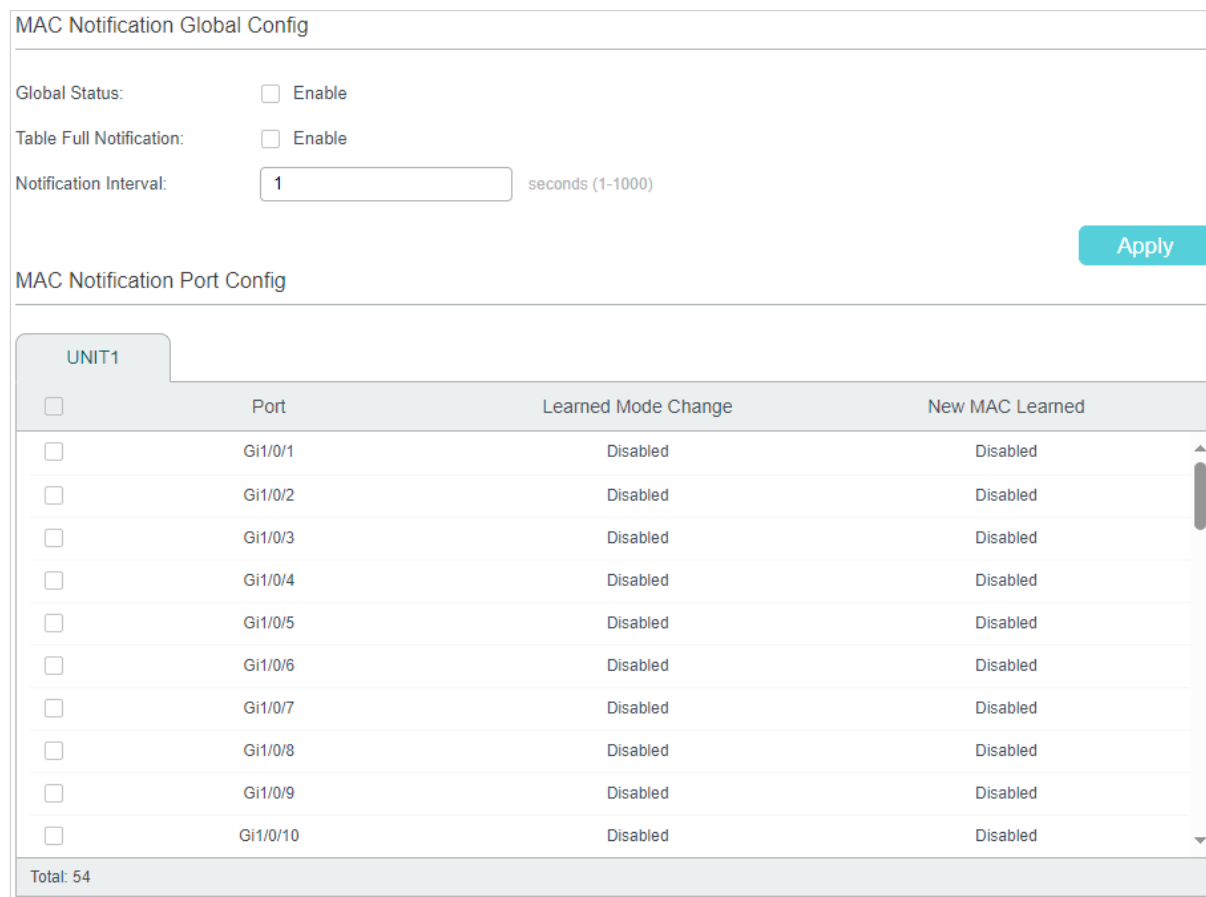

Follow these steps to configure MAC notification traps:

- 1) In the **MAC Notification Global Config** section, enable this feature, configure the relevant options, and click **Apply**.

Global Status	Enable or disable the MAC notification feature globally.
Table Full Notification	Enable or disable Table Full Notification. With this option enabled, a notification will be generated and sent to the management host when the MAC address table is full.
Notification Interval	Specify the time value of Notification Interval. Notification Interval is the interval at which the New MAC Learned notifications are continuously sent.

- 2) In the **MAC Notification Port Config** section, select one or more ports to configure the notification status. Click **Apply**.

Learned Mode Change	Enable or disable Learned Mode Change. With this option enabled, when the learned mode of the specified port is changed, a notification will be generated and sent to the management host.
New MAC Learned	Enable or disable New MAC Learned. With this option enabled, when the specified port learns a new MAC address, a notification will be generated and sent to the management host.

3) Configure SNMP and set a management host. For detailed SNMP configurations, please refer to [Configuring SNMP & RMON](#).

3.1.2 Limiting the Number of MAC Addresses Learned in VLANs

■ For Certain Devices

Choose the menu **L2 FEATURES > Switching > MAC Address > MAC VLAN Security** to load the following page.

Figure 3-2 Configuring the MAC VLAN Security Mode

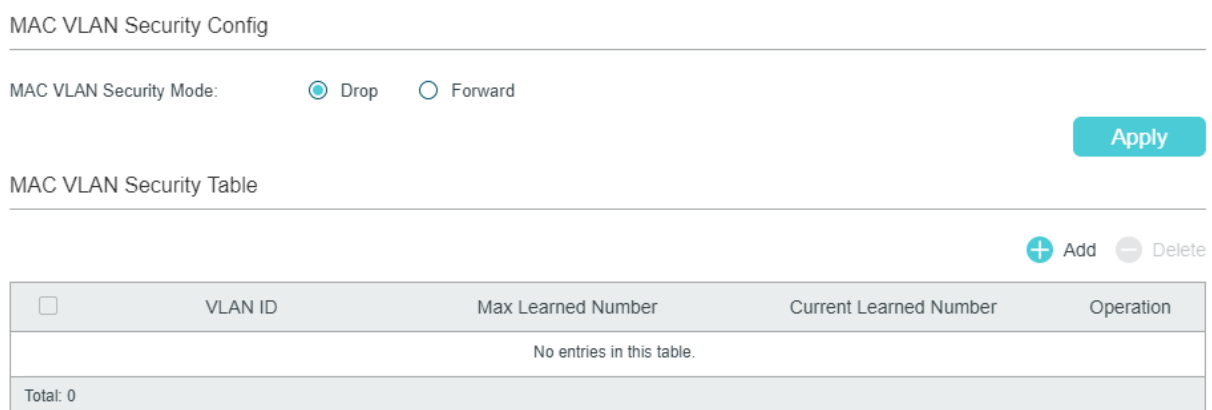

Follow these steps to limit the number of MAC addresses in VLANs:

1) In the **MAC VLAN Security Config** section, select the security mode for all VLANs.

Drop	Packets with new source MAC addresses in the VLAN will be dropped when the maximum number of MAC addresses is exceeded.
Forward	Packets of new source MAC addresses will be forwarded but the addresses will not be learned when the maximum number of MAC addresses is exceeded.

2) In the **MAC VLAN Security Table** section, click Add to load the following page. Enter the VLAN ID and the Max Learned Number to limit the number of MAC addresses that can be learned in the specified VLAN.

Figure 3-3 Limiting the Number of MAC Addresses in VLANs

VLAN ID	Specify an existing VLAN in which you want to limit the number of MAC addresses.
Max Learned Number	Set the maximum number of MAC addresses in the specific VLAN. It ranges from 0 to 16383. You can control the available address table space by setting maximum learned MAC number for VLANs. However, an improper maximum number can cause unnecessary floods in the network or a waste of address table space. Therefore, before you set the number limit, please be sure you are familiar with the network topology and the switch system configuration.

3) Click **Create**.

■ **For Certain Devices**

Choose the menu **L2 FEATURES > Switching > MAC Address > MAC VLAN Security** and click Add to load the following page.

Figure 3-4 Limiting the Number of MAC Addresses in VLANs

Follow these steps to limit the number of MAC addresses in VLANs:

1) Enter the VLAN ID to limit the number of MAC addresses that can be learned in the specified VLAN.

VLAN ID	Specify an existing VLAN in which you want to limit the number of MAC addresses.
----------------	--

2) Enter your desired value in **Max Learned Number** to set a threshold.

Max Learned Number	Set the maximum number of MAC addresses in the specific VLAN. It ranges from 0 to 16383.
---------------------------	--

You can control the available address table space by setting maximum learned MAC number for VLANs. However, an improper maximum number can cause unnecessary floods in the network or a waste of address table space. Therefore, before you set the number limit, please be sure you are familiar with the network topology and the switch system configuration.

- 3) Choose the mode that the switch adopts when the maximum number of MAC addresses in the specified VLAN is exceeded.

Drop	Packets with new source MAC addresses in the VLAN will be dropped when the maximum number of MAC addresses in the specified VLAN is exceeded.
-------------	---

Forward	Packets of new source MAC addresses will be forwarded but the addresses will not be learned when the maximum number of MAC addresses in the specified VLAN is exceeded.
----------------	---

- 4) Click **Create**.

3.2 Using the CLI

3.2.1 Configuring MAC Notification Traps

Follow these steps to configure MAC notification traps:

Step 1	configure Enter global configuration mode.
Step 2	mac address-table notification global-status {enable disable} Enable MAC Notification globally. enable disable: Enable or disable MAC Notification globally.
Step 3	mac address-table notification table-full-status [enable disable] (Optional) Enable Table Full Notification. enable disable: With Table Full Notification enabled, when address table is full, a notification will be generated and sent to the management host.
Step 4	mac address-table notification interval time Specify the time value of Notification Interval. Notification Interval is the interval at which the New MAC Learned notifications are continuously sent. time: Specify the Notification Interval in seconds between 1 to 1000. By default, it is 1 second.
Step 5	interface { fastEthernet port range fastEthernet port-list gigabitEthernet port range gigabitEthernet port-list ten-gigabitEthernet port range ten-gigabitEthernet port-list } Configure notification traps on the specified port. port/ port-list: The number or the list of the Ethernet port that you want to configure notification traps.

-
- Step 6 **mac address-table notification** {[**learn-mode-change** enable | disable] [**new-mac-learned** enable | disable]}
- Enable learn-mode-change, exceed-max-learned, or new-MAC-learned notification traps on the specified port.
- enable | disable:** Enable or disable learn-mode-change, exceed-max-learned, or new-MAC-learned notification traps on the specified port.
- learn-mode-change:** With learn-mode-change enabled, when the learned mode of the specified port is changed, a notification will be generated and sent to the management host.
- new-mac-learned:** With new-mac-learned enabled, when the specified port learns a new MAC address, a notification will be generated and sent to the management host.
-
- Step 7 **end**
- Return to privileged EXEC mode.
-
- Step 8 **copy running-config startup-config**
- Save the settings in the configuration file.
-

Now you have configured MAC notification traps. To receive notifications, you need to further enable SNMP and set a management host. For detailed SNMP configurations, please refer to [Configuring SNMP & RMON](#).

The following example shows how to enable new-MAC-learned trap on port 1, and set the interval time as 10 seconds. After you have further configured SNMP, the switch will bundle notifications of new addresses in every 10 seconds and send to the management host.

Switch#configure

```
Switch(config)#mac address-table notification global-status enable
```

```
Switch(config)#mac address-table notification interval 10
```

```
Switch(config)#interface gigabitEthernet 1/0/1
```

```
Switch(config-if)#mac address-table notification new-mac-learned enable
```

```
Switch(config-if)#show mac address-table notification interface gigabitEthernet 1/0/1
```

```
Mac Notification Global Config
```

```
Notification Global Status   : enable
```

```
Table Full Notification Status: disable
```

```
Notification Interval       : 10
```

```
Port      LrnMode Change          New Mac Learned
```

```
----      -
```

```
Gi1/0/1  disable          enable
```

```
Switch(config-if)#end
```

```
Switch#copy running-config startup-config
```

3.2.2 Limiting the Number of MAC Addresses in VLANs

■ For Certain Devices

Follow these steps to limit the number of MAC addresses in VLANs:

Step 1	configure Enter global configuration mode.
Step 2	mac address-table vlan-security mode {drop forward} Specify the VLAN security mode for all the VLANs. drop forward: The mode that the switch adopts when the maximum number of MAC addresses in the specified VLAN is exceeded. drop: Packets of new source MAC addresses in the VLAN will be dropped when the maximum number of MAC addresses in the specified VLAN is exceeded. forward: Packets of new source MAC addresses will be forwarded but the addresses not learned when the maximum number of MAC addresses in the specified VLAN is exceeded.
Step 3	mac address-table vlan-security vid vid max-learn num Configure the maximum number of MAC addresses in the specified VLAN and select a mode for the switch to adopt when the maximum number is exceeded. vid: Specify an existing VLAN in which you want to limit the number of MAC addresses. num: Set the maximum number of MAC addresses in the specific VLAN. It ranges from 0 to 16383.
Step 4	end Return to privileged EXEC mode.
Step 5	copy running-config startup-config Save the settings in the configuration file.

The following example shows how to limit the number of MAC addresses to 100 in VLAN 10, and configure the switch to drop packets of new source MAC addresses when the limit is exceeded.

```
Switch#configure
```

```
Switch(config)#mac address-table vlan-security mode drop
```

```
Switch(config)#mac address-table vlan-security vid 10 max-learn 100
```

```
Switch(config)#show mac address-table vlan-security vid 10
```

VlanId	Max-learn	Current-learn	Status
-----	-----	-----	-----
10	100	0	Drop

```
Switch(config)#end
```

```
Switch#copy running-config startup-config
```

■ For Certain Devices

Follow these steps to limit the number of MAC addresses in VLANs:

Step 1	<p>configure</p> <p>Enter global configuration mode.</p>
Step 2	<p>mac address-table security vid vid max-learn num {drop forward}</p> <p>Configure the maximum number of MAC addresses in the specified VLAN and select a mode for the switch to adopt when the maximum number is exceeded.</p> <p><i>vid</i>: Specify an existing VLAN in which you want to limit the number of MAC addresses.</p> <p><i>num</i>: Set the maximum number of MAC addresses in the specific VLAN. It ranges from 0 to 16383.</p> <p><i>drop forward</i>: The mode that the switch adopts when the maximum number of MAC addresses in the specified VLAN is exceeded.</p> <p><i>drop</i>: Packets of new source MAC addresses in the VLAN will be dropped when the maximum number of MAC addresses in the specified VLAN is exceeded.</p> <p><i>forward</i>: Packets of new source MAC addresses will be forwarded but the addresses not learned when the maximum number of MAC addresses in the specified VLAN is exceeded.</p>
Step 3	<p>end</p> <p>Return to privileged EXEC mode.</p>
Step 4	<p>copy running-config startup-config</p> <p>Save the settings in the configuration file.</p>

The following example shows how to limit the number of MAC addresses to 100 in VLAN 10, and configure the switch to drop packets of new source MAC addresses when the limit is exceeded.

Switch#configure

Switch(config)#mac address-table security vid 10 max-learn 100 drop

Switch(config)#show mac address-table security vid 10

VlanId	Max-learn	Current-learn	Status
-----	-----	-----	-----
10	100	0	Drop

Switch(config)#end

Switch#copy running-config startup-config

4 Example for Security Configurations

4.1 Network Requirements

Several departments are connected to the company network as shown in Figure 4-1. Now the Marketing Department that is in VLAN 10 has network requirements as follows:

- Free the network system from illegal accesses and MAC address attacks by limiting the number of access users in this department to 100.
- Assist the network manager supervising the network with notifications of any new access users.

Figure 4-1 The Network Topology

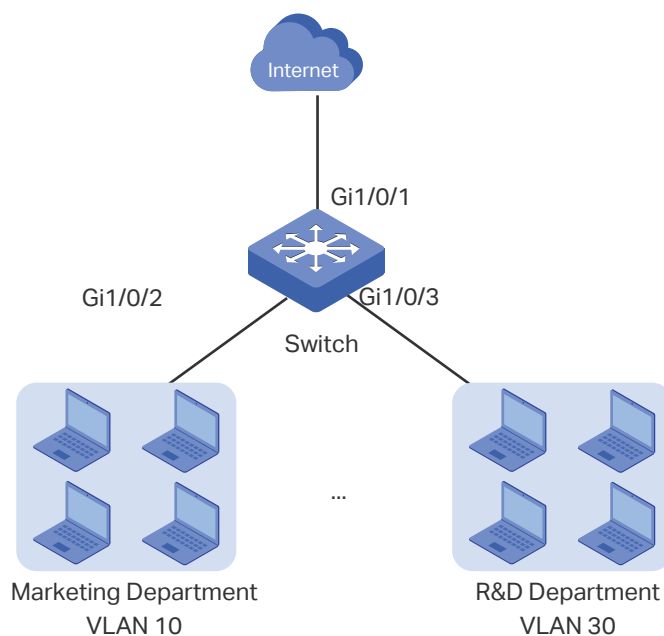

4.2 Configuration Scheme

VLAN Security can be configured to limit the number of access users and in this way to prevent illegal accesses and MAC address attacks.

MAC Notification and SNMP can be configured to monitor the interface which is used by the Marketing Department. Enable the new-MAC-learned notification and the SNMP, then the network manager can get notifications when new users access the network.

Demonstrated with T2600G-28TS, this chapter provides configuration procedures in two ways: using the GUI and using the CLI.

4.3 Using the GUI

- 1) Choose the menu **L2 FEATURES > Switching > MAC Address > MAC VLAN Security** and click **Add** to load the following page. Set the maximum number of MAC address in VLAN 10 as 100, choose drop mode and click **Create**.

Figure 4-2 Configuring VLAN Security

VLAN Security Config

VLAN ID: (1-4094)

Max Learned Number: (0-16383)

Mode:

- 2) Choose the menu **L2 FEATURES > Switching > MAC Address > MAC Notification** to load the following page. Enable Global Status, set notification interval as 10 seconds, and click **Apply**. Then, enable new-mac-learned trap on port 1/0/2 and click **Apply**.

Figure 4-3 Configuring New-MAC-learned Traps

MAC Notification Global Config

Global Status: Enable

Table Full Notification: Enable

Notification Interval: seconds (1-1000)

MAC Notification Port Config

UNIT1		Port	Learned Mode Change	New MAC Learned
<input type="checkbox"/>				Enable
<input type="checkbox"/>		Gi1/0/1	Disabled	Disabled
<input checked="" type="checkbox"/>		Gi1/0/2	Disabled	Enabled
<input type="checkbox"/>		Gi1/0/3	Disabled	Disabled
<input type="checkbox"/>		Gi1/0/4	Disabled	Disabled
<input type="checkbox"/>		Gi1/0/5	Disabled	Disabled
<input type="checkbox"/>		Gi1/0/6	Disabled	Disabled
<input type="checkbox"/>		Gi1/0/7	Disabled	Disabled
<input type="checkbox"/>		Gi1/0/8	Disabled	Disabled
<input type="checkbox"/>		Gi1/0/9	Disabled	Disabled
<input type="checkbox"/>		Gi1/0/10	Disabled	Disabled

Total: 54 1 entry selected.

- 3) Click **Save** to save the settings.
- 4) Enable SNMP and set a management host. For detailed SNMP configurations, please refer to [Configuring SNMP & RMON](#).

4.4 Using the CLI

- 1) Set the maximum number of MAC address in VLAN 10 as 100, and choose drop mode.

```
Switch#configure
```

```
Switch(config)#mac address-table security vid 10 max-learn 100 drop
```

- 2) Configure the new-MAC-learned trap on port 1/0/2 and set notification interval as 10 seconds.

```
Switch(config)#mac address-table notification global-status enable
```

```
Switch(config)#mac address-table notification interval 10
```

```
Switch(config)#interface gigabitEthernet 1/0/2
```

```
Switch(config-if)#mac address-table notification new-mac-learned enable
```

```
Switch(config-if)#end
```

```
Switch#copy running-config startup-config
```

- 3) Configure SNMP and set a management host. For detailed SNMP configurations, please refer to [Configuring SNMP & RMON](#).

Verify the Configurations

Verify the configuration of VLAN Security.

```
Switch#show mac address-table security vid 10
```

VlanId	Max-learn	Current-learn	Status
-----	-----	-----	-----
10	100	0	Drop

Verify the configuration of MAC Notification on port 1/0/2.

```
Switch#show mac address-table notification interface gigabitEthernet 1/0/2
```

Port	LrnMode Change	New Mac Learned
----	-----	-----
Gi1/0/2	disable	enable

5 Appendix: Default Parameters

Default settings of the MAC Address Table are listed in the following tables.

Table 5-1 Entries in the MAC Address Table

Parameter	Default Setting
Static Address Entries	None
Dynamic Address Entries	Auto-learning
Filtering Address Entries	None

Table 5-2 Default Settings of Dynamic Address Table

Parameter	Default Setting
Auto Aging	Enabled
Aging Time	300 seconds

Table 5-3 Default Settings of MAC Notification

Parameter	Default Setting
Global Status	Disabled
Table Full Notification	Disabled
Notification Interval	1 Second
Learned Mode Change Notification	Disabled
Exceed Max Learned Notification	Disabled
New MAC Learned Notification	Disabled

Part 8

Configuring 802.1Q VLAN

CHAPTERS

1. Overview
2. 802.1Q VLAN Configuration
3. Configuration Example
4. Appendix: Default Parameters

1 Overview

VLAN (Virtual Local Area Network) is a network technology that solves broadcasting issues in local area networks. It is usually used to restrict broadcast domain and enhance network security. 802.1Q VLAN is a technology to classify the VLANs based on IEEE 802.1Q protocol. The VLANs are distinguished by VLAN IDs. It is usually applied in the following occasions:

- To restrict broadcast domain: VLAN technique divides a big local area network into several VLANs, and all VLAN traffic remains within its VLAN. It reduces the influence of broadcast traffic in Layer 2 network to the whole network.
- To enhance network security: Devices from different VLANs cannot achieve Layer 2 communication, and thus users can group and isolate devices to enhance network security.
- For easier management: VLANs group devices logically instead of physically, so devices in the same VLAN need not be located in the same place. It eases the management of devices in the same work group but located in different places.

2 802.1Q VLAN Configuration

To complete 802.1Q VLAN configuration, follow these steps:

- 1) Configure the VLAN, including creating a VLAN and adding the desired ports to the VLAN.
- 2) Configure port parameters for 802.1Q VLAN.

2.1 Using the GUI

2.1.1 Configuring the VLAN

Choose the menu **L2 FEATURES > VLAN > 802.1Q VLAN > VLAN Config** and click  Add to load the following page.

Figure 2-1 Configuring VLAN

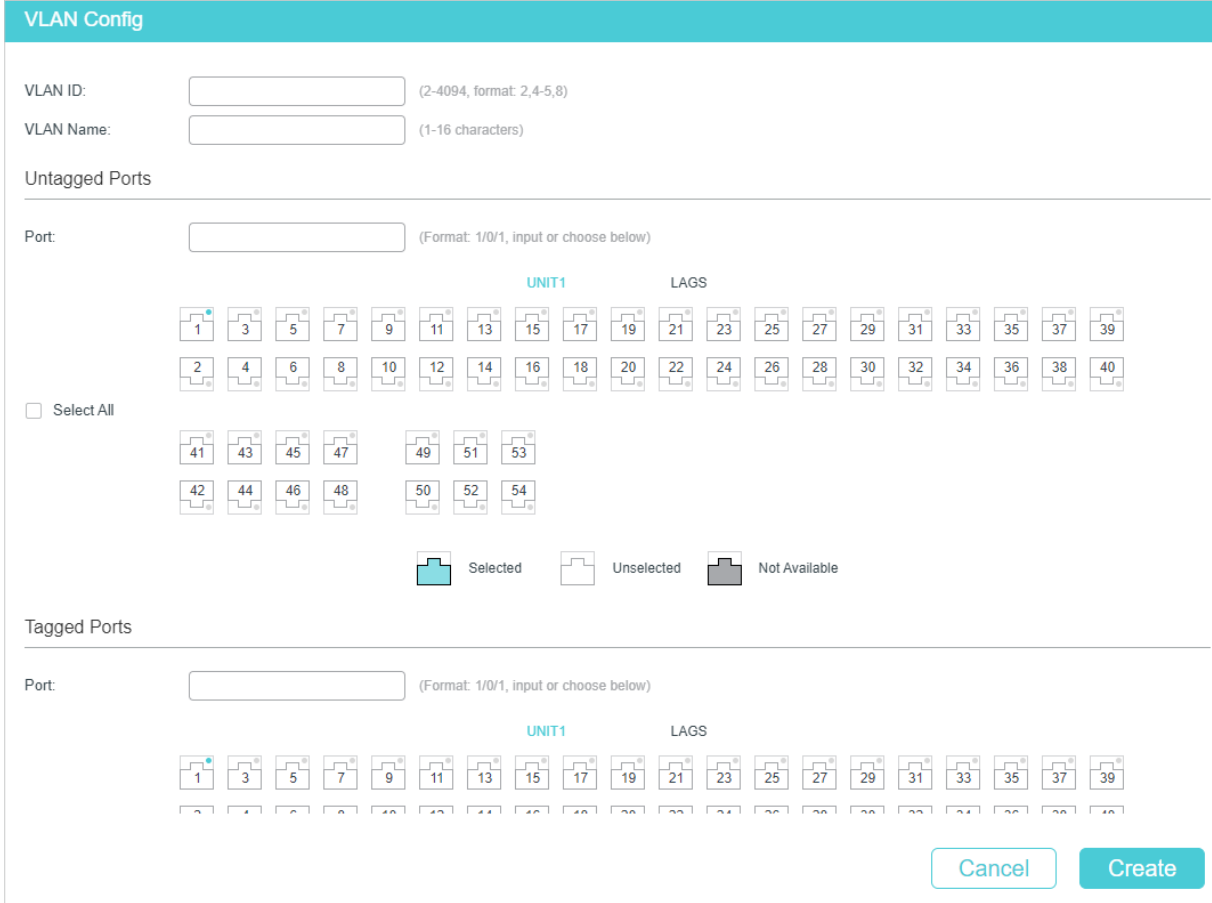

The screenshot shows the 'VLAN Config' interface. At the top, there are two input fields: 'VLAN ID' (with a note '(2-4094, format: 2,4-5,8)') and 'VLAN Name' (with a note '(1-16 characters)'). Below these is the 'Untagged Ports' section, which includes a 'Port:' input field (with a note '(Format: 1/0/1, input or choose below)') and a grid of port icons. The grid is divided into 'UNIT1' and 'LAGS' columns. Port 1 is selected. A 'Select All' checkbox is present. A legend at the bottom indicates 'Selected' (blue), 'Unselected' (white), and 'Not Available' (grey). The 'Tagged Ports' section is identical in layout but currently empty. At the bottom right, there are 'Cancel' and 'Create' buttons.

Follow these steps to configure VLAN:

- 1) Enter a VLAN ID and a description for identification to create a VLAN.

VLAN ID

Enter an ID number for the VLAN with the values between 2 and 4094.

VLAN Name	Specify a VLAN description for identification with up to 16 characters.
Members	Displays the port members in the VLAN.

2) Select the untagged port(s) and the tagged port(s) respectively to add to the created VLAN based on the network topology.

Untagged port	Select untagged ports to be added to the VLAN. The ports will take out the VLAN tags of the packets and forward them in the target VLAN.
Tagged port	Select tagged ports to be added to the VLAN. The ports will keep the VLAN tags of the packets and forward them in the target VLAN.

3) Click **Apply**.



Note:

- Deleting VLANs may affect some other related features, such as ACL, IP-MAC binding, Guest VLAN, MVR, Static Address and so on.

2.1.2 Configuring Port Parameters for 802.1Q VLAN

Choose the menu **L2 FEATURES > VLAN > 802.1Q VLAN > Port Config** to load the following page.

Figure 2-2 Configuring the Port

UNIT1		LAGS					
<input type="checkbox"/>	Port	PVID	Ingress Checking	Acceptable Frame Types	LAG	Details	
<input type="checkbox"/>	1/0/1	1	Enabled	Admit All	---	Details	
<input type="checkbox"/>	1/0/2	1	Enabled	Admit All	---	Details	
<input type="checkbox"/>	1/0/3	1	Enabled	Admit All	---	Details	
<input type="checkbox"/>	1/0/4	1	Enabled	Admit All	---	Details	
<input type="checkbox"/>	1/0/5	1	Enabled	Admit All	---	Details	
<input type="checkbox"/>	1/0/6	1	Enabled	Admit All	---	Details	
<input type="checkbox"/>	1/0/7	1	Enabled	Admit All	---	Details	
<input type="checkbox"/>	1/0/8	1	Enabled	Admit All	---	Details	
<input type="checkbox"/>	1/0/9	1	Enabled	Admit All	---	Details	
<input type="checkbox"/>	1/0/10	1	Enabled	Admit All	---	Details	
Total: 54							

Select a port and configure the parameters. Click **Apply**.

PVID	Enter the default VLAN ID for the port. It can be added to the untagged packets as VLAN ID, and then the port will forward the packets in the corresponding VLAN.
------	---

Ingress Checking	Enable or disable Ingress Checking. With this function enabled, the port will accept the packet of which the VLAN ID is in the port's VLAN list and discard others. With this function disabled, the port will forward the packet directly.
Acceptable Frame Types	Select the acceptable frame type for the port and the port will perform this operation before Ingress Checking. Admit All: The port will accept both the tagged packets and the untagged packets. Tagged Only: The port will accept the tagged packets only.
LAG	Displays the LAG that the port belongs to.
Details	Click the Detail button to view the VLANs to which the port belongs.

2.2 Using the CLI

2.2.1 Creating a VLAN

Follow these steps to create a VLAN:

Step 1	configure Enter global configuration mode.
Step 2	vlan <i>vlan-list</i> When you enter a new VLAN ID, the switch creates a new VLAN and enters VLAN configuration mode; when you enter an existing VLAN ID, the switch directly enters VLAN configuration mode. <i>vlan-list</i> : Specify the ID or the ID list of the VLAN(s) for configuration. Valid values are from 2 to 4094, for example, 2-3,5.
Step 3	name <i>descript</i> (Optional) Specify a VLAN description for identification. <i>descript</i> : The length of the description should be 1 to 16 characters.
Step 4	show vlan [id <i>vlan-list</i>] Show the global information of the specified VLAN(s). When no VLAN is specified, this command shows global information of all 802.1Q VLANs. <i>vlan-list</i> : Specify the ID or the ID list of the VLAN(s) to show information. Valid values are from 1 to 4094.
Step 5	end Return to privileged EXEC mode.
Step 6	copy running-config startup-config Save the settings in the configuration file.

The following example shows how to create VLAN 2 and name it as RD:

```
Switch#configure
```

```
Switch(config)#vlan 2
```

```
Switch(config-vlan)#name RD
```

```
Switch(config-vlan)#show vlan id 2
```

VLAN	Name	Status	Ports
-----	-----	-----	-----
2	RD	active	Gi1/0/1, Gi1/0/2

```
Switch(config-vlan)#end
```

```
Switch#copy running-config startup-config
```

2.2.2 Adding the Port to the Specified VLAN

Follow these steps to add the port to the specified VLAN:

Step 1	configure Enter global configuration mode.
Step 2	interface {fastEthernet port range fastEthernet port-list gigabitEthernet port range gigabitEthernet port-list ten-gigabitEthernet port range ten-gigabitEthernet port-list port-channel port-channel-id range port-channel port-channel-list} Enter interface configuration mode.
Step 3	switchport general allowed vlan vlan-list { tagged untagged } Add ports to the specified VLAN. <i>vlan-list</i> : Specify the ID or ID list of the VLAN(s) that the port will be added to. The ID ranges from 1 to 4094. <i>tagged untagged</i> : Select the egress rule for the port.
Step 4	show interface switchport [fastEthernet port gigabitEthernet port ten-gigabitEthernet port port-channel lag-id] Verify the information of the port.
Step 5	end Return to privileged EXEC mode.
Step 6	copy running-config startup-config Save the settings in the configuration file.

The following example shows how to add the port 1/0/5 to VLAN 2, and specify its egress rule as tagged:

```
Switch#configure
```

```
Switch(config)#interface gigabitEthernet 1/0/5
```

```
Switch(config-if)#switchport general allowed vlan 2 tagged
```

```
Switch(config-if)#show interface switchport gigabitEthernet 1/0/5
```

```
Port Gi1/0/5:
```

```
PVID: 2
```

```
Acceptable frame type: All
```

```
Ingress Checking: Enable
```

```
Member in LAG: N/A
```

```
Link Type: General
```

```
Member in VLAN:
```

Vlan	Name	Egress-rule
----	-----	-----
1	System-VLAN	Untagged
2	RD	Tagged

```
Switch(config-if)#end
```

```
Switch#copy running-config startup-config
```

2.2.3 Configuring the Port

Follow these steps to configure the port:

Step 1	configure Enter global configuration mode.
Step 2	interface {fastEthernet port range fastEthernet port-list gigabitEthernet port range gigabitEthernet port-list ten-gigabitEthernet port range ten-gigabitEthernet port-list port-channel port-channel-id range port-channel port-channel-list} Enter interface configuration mode.
Step 3	switchport pvid vlan-id Configure the PVID of the port(s). By default, it is 1. <i>vlan-id</i> : The default VLAN ID of the port with the values between 1 and 4094.
Step 4	switchport check ingress Enable or disable Ingress Checking. With this function enabled, the port will accept the packet of which the VLAN ID is in the port's VLAN list and discard others. With this function disabled, the port will forward the packet directly.

-
- Step 5 **switchport acceptable frame {all | tagged}**
- Select the acceptable frame type for the port and the port will perform this operation before Ingress Checking.
- all:** The port will accept both the tagged packets and the untagged packets.
- tagged:** The port will accept the tagged packets only.
-
- Step 6 **end**
- Return to privileged EXEC mode.
-
- Step 7 **copy running-config startup-config**
- Save the settings in the configuration file.
-

The following example shows how to configure the PVID of port 1/0/5 as 2, enable the ingress checking and set the acceptable frame type as all:

Switch#configure

Switch(config)#interface gigabitEthernet 1/0/5

Switch(config-if)#switchport pvid 2

Switch(config-if)#switchport check ingress

Switch(config-if)#switchport acceptable frame all

Switch(config-if)#show interface switchport gigabitEthernet 1/0/5

Port Gi1/0/5:

PVID: 2

Acceptable frame type: All

Ingress Checking: Enable

Member in LAG: N/A

Link Type: General

Member in VLAN:

Vlan	Name	Egress-rule
----	-----	-----
1	System-VLAN	Untagged

Switch(config-if)#end

Switch#copy running-config startup-config

3 Configuration Example

3.1 Network Requirements

- Offices of Department A and Department B in the company are located in different places, and some computers in different offices connect to the same switch.
- It is required that computers can communicate with each other in the same department but not with computers in the other department.

3.2 Configuration Scheme

- Divide computers in Department A and Department B into two VLANs respectively so that computers can communicate with each other in the same department but not with computers in the other department.
- Terminal devices like computers usually do not support VLAN tags. Add untagged ports to the corresponding VLANs and specify the PVID.
- The intermediate link between two switches carries traffic from two VLANs simultaneously. Add the tagged ports to both VLANs.

3.3 Network Topology

The figure below shows the network topology. Host A1 and Host A2 are in Department A, while Host B1 and Host B2 are in Department B. Switch 1 and Switch 2 are located in two different places. Host A1 and Host B1 are connected to port 1/0/2 and port 1/0/3 on Switch 1 respectively, while Host A2 and Host B2 are connected to port 1/0/6 and port 1/0/7 on Switch 2 respectively. Port 1/0/4 on Switch 1 is connected to port 1/0/8 on Switch 2.

Figure 3-1 Network Topology

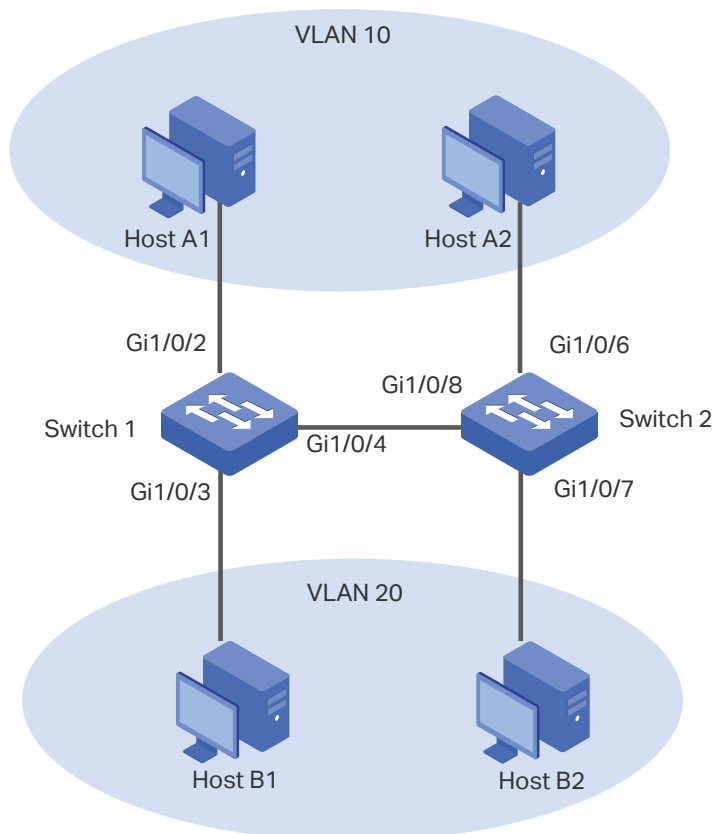

Demonstrated with SG6654XHP, the following sections provide configuration procedure in two ways: using the GUI and using the CLI.

3.4 Using the GUI

The configurations of Switch 1 and Switch 2 are similar. The following introductions take Switch 1 as an example.

- 1) Choose the menu **L2 FEATURES > VLAN > 802.1Q VLAN > VLAN Config** and click **+ Add** to load the following page. Create VLAN 10 with the description of Department_A. Add port 1/0/2 as an untagged port and port 1/0/5 as a tagged port to VLAN 10. Click **Create**.

Figure 3-2 Creating VLAN 10 for Department A

VLAN Config

VLAN ID: (2-4094, format: 2,4-5,8)

VLAN Name: (1-16 characters)

Untagged Ports

Port: (Format: 1/0/1, input or choose below)

UNIT1 LAGS

1 3 5 7 9 11 13 15 17 19 21 23 25 27 29 31 33 35 37 39
 2 4 6 8 10 12 14 16 18 20 22 24 26 28 30 32 34 36 38 40
 41 43 45 47 49 51 53
 42 44 46 48 50 52 54

Select All

Selected Unselected Not Available

Tagged Ports

Port: (Format: 1/0/1, input or choose below)

UNIT1 LAGS

1 3 5 7 9 11 13 15 17 19 21 23 25 27 29 31 33 35 37 39
 41 43 45 47 49 51 53
 42 44 46 48 50 52 54

- 2) Choose the menu **L2 FEATURES > VLAN > 802.1Q VLAN > VLAN Config** and click **+ Add** to load the following page. Create VLAN 20 with the description of Department_B. Add port 1/0/3 as an untagged port and port 1/0/5 as a tagged port to VLAN 20. Click **Create**.

Figure 3-3 Creating VLAN 20 for Department B

VLAN Config

VLAN ID: (2-4094, format: 2,4-5,8)

VLAN Name: (1-16 characters)

Untagged Ports

Port: (Format: 1/0/1, input or choose below)

UNIT1 LAGS

1 3 5 7 9 11 13 15 17 19 21 23 25 27 29 31 33 35 37 39

2 4 6 8 10 12 14 16 18 20 22 24 26 28 30 32 34 36 38 40

41 43 45 47 49 51 53

42 44 46 48 50 52 54

Select All

Selected Unselected Not Available

Tagged Ports

Port: (Format: 1/0/1, input or choose below)

UNIT1 LAGS

1 3 5 7 9 11 13 15 17 19 21 23 25 27 29 31 33 35 37 39

41 43 45 47 49 51 53

42 44 46 48 50 52 54

- 3) Choose the menu **L2 FEATURES > VLAN > 802.1Q VLAN > Port Config** to load the following page. Set the PVID of port 1/0/2 as 10 and click **Apply**. Set the PVID of port 1/0/3 as 20 and click **Apply**.

Figure 3-4 Specifying the PVID for the Ports

Port Config

UNIT1 LAGS

<input type="checkbox"/>	Port	PVID	Ingress Checking	Acceptable Frame Types	LAG	Details
<input type="checkbox"/>	1/0/1	1	Enabled	Admit All	---	Details
<input type="checkbox"/>	1/0/2	10	Enabled	Admit All	---	Details
<input checked="" type="checkbox"/>	1/0/3	20	Enabled	Admit All	---	Details
<input type="checkbox"/>	1/0/4	1	Enabled	Admit All	---	Details
<input type="checkbox"/>	1/0/5	1	Enabled	Admit All	---	Details
<input type="checkbox"/>	1/0/6	1	Enabled	Admit All	---	Details
<input type="checkbox"/>	1/0/7	1	Enabled	Admit All	---	Details
<input type="checkbox"/>	1/0/8	1	Enabled	Admit All	---	Details
<input type="checkbox"/>	1/0/9	1	Enabled	Admit All	---	Details
<input type="checkbox"/>	1/0/10	1	Enabled	Admit All	---	Details

Total: 54 1 entry selected.

- 4) Click  to save the settings.

3.5 Using the CLI

The configurations of Switch 1 and Switch 2 are similar. The following introductions take Switch 1 as an example.

- 1) Create VLAN 10 for Department A, and configure the description as Department-A. Similarly, create VLAN 20 for Department B, and configure the description as Department-B.

```
Switch_1#configure
```

```
Switch_1(config)#vlan 10
```

```
Switch_1(config-vlan)#name Department-A
```

```
Switch_1(config-vlan)#exit
```

```
Switch_1(config)#vlan 20
```

```
Switch_1(config-vlan)#name Department-B
```

```
Switch_1(config-vlan)#exit
```

- 2) Add untagged port 1/0/2 and tagged port 1/0/4 to VLAN 10. Add untagged port 1/0/3 and tagged port 1/0/4 to VLAN 20.

```
Switch_1(config)#interface gigabitEthernet 1/0/2
```

```
Switch_1(config-if)#switchport general allowed vlan 10 untagged
```

```
Switch_1(config-if)#exit
```

```
Switch_1(config)#interface gigabitEthernet 1/0/3
```

```
Switch_1(config-if)#switchport general allowed vlan 20 untagged
```

```
Switch_1(config-if)#exit
```

```
Switch_1(config)#interface gigabitEthernet 1/0/4
```

```
Switch_1(config-if)#switchport general allowed vlan 10 tagged
```

```
Switch_1(config-if)#switchport general allowed vlan 20 tagged
```

```
Switch_1(config-if)#exit
```

- 3) Set the PVID of port 1/0/2 as 10, and set the PVID of port 1/0/3 as 20.

```
Switch_1(config)#interface gigabitEthernet 1/0/2
```

```
Switch_1(config-if)#switchport pvid 10
```

```
Switch_1(config-if)#exit
```

```
Switch_1(config)#interface gigabitEthernet 1/0/3
```



```
Switch_1(config-if)#switchport pvid 20
Switch_1(config-if)#end
Switch_1#copy running-config startup-config
```

Verify the Configurations

Verify the VLAN configuration:

```
Switch_1#show vlan
```

VLAN	Name	Status	Ports
1	System-VLAN	active	Gi1/0/1, Gi1/0/2, Gi1/0/3, Gi1/0/4, Gi1/0/5, Gi1/0/6, Gi1/0/7, Gi1/0/8, Gi1/0/9, Gi1/0/10, Gi1/0/11, Gi1/0/12, Gi1/0/13, Gi1/0/14, Gi1/0/15, Gi1/0/16, Gi1/0/17, Gi1/0/18, Gi1/0/19, Gi1/0/20, Gi1/0/21, Gi1/0/22, Gi1/0/23, Gi1/0/24, Gi1/0/25, Gi1/0/26, Gi1/0/27, Gi1/0/28
10	Department-A	active	Gi1/0/2, Gi1/0/4
20	Department-B	active	Gi1/0/3, Gi1/0/4
Primary	Secondary	Type	Ports

Verify the VLAN configuration:

```
Switch_1(config)#show interface switchport
```

Port	LAG	Type	PVID	Acceptable frame type	Ingress Checking
Gi1/0/1	N/A	General	1	All	Enable
Gi1/0/2	N/A	General	10	All	Enable
Gi1/0/3	N/A	General	20	All	Enable
Gi1/0/4	N/A	General	1	All	Enable
Gi1/0/5	N/A	General	1	All	Enable
...					

4 Appendix: Default Parameters

Default settings of 802.1Q VLAN are listed in the following table.

Table 4-1 Default Settings of 802.1Q VLAN

Parameter	Default Setting
VLAN ID	1
PVID	1
Ingress Checking	Enabled
Acceptable Frame Types	Admit All

Part 9

Configuring MAC VLAN

CHAPTERS

1. Overview
2. MAC VLAN Configuration
3. Configuration Example
4. Appendix: Default Parameters

1 Overview

VLAN is generally divided by ports. It is a common way of division but isn't suitable for those networks that require frequent topology changes. With the popularity of mobile office, at different times a terminal device may access the network via different ports. For example, a terminal device that accessed the switch via port 1 last time may change to port 2 this time. If port 1 and port 2 belong to different VLANs, the user has to re-configure the switch to access the original VLAN. Using MAC VLAN can free the user from such a problem. It divides VLANs based on the MAC addresses of terminal devices. In this way, terminal devices always belong to their MAC VLANs even when their access ports change.

The figure below shows a common application scenario of MAC VLAN.

Figure 1-1 Common Application Scenario of MAC VLAN

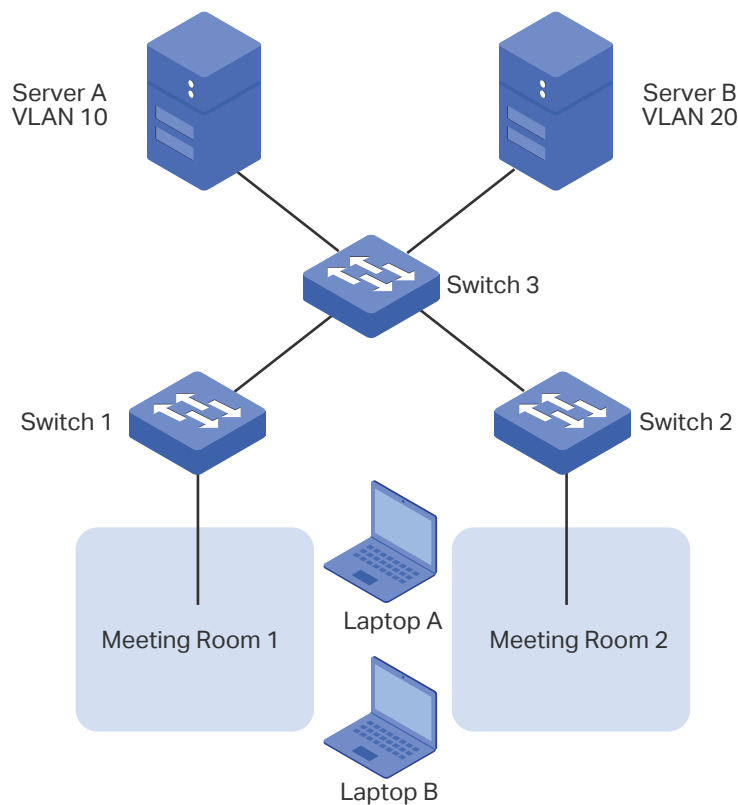

Two departments share all the meeting rooms in the company, but use different servers and laptops. Department A uses Server A and Laptop A, while Department B uses Server B and Laptop B. Server A is in VLAN 10 while Server B is in VLAN 20. It is required that Laptop A can only access Server A and Laptop B can only access Server B, no matter which meeting room the laptops are being used in. To meet this requirement, simply bind the MAC addresses of the laptops to the corresponding VLANs respectively. In this way, the MAC address determines the VLAN each laptop joins. Each laptop can access only the server in the VLAN it joins.

2 MAC VLAN Configuration

To complete MAC VLAN configuration, follow these steps:

- 1) Configure 802.1Q VLAN.
- 2) Bind the MAC address to the VLAN.
- 3) Enable MAC VLAN for the port.

Configuration Guidelines

When a port in a MAC VLAN receives an untagged data packet, the switch will first check whether the source MAC address of the data packet has been bound to the MAC VLAN. If yes, the switch will insert the corresponding tag to the data packet and forward it within the VLAN. If no, the switch will continue to match the data packet with the matching rules of other VLANs (such as the protocol VLAN). If there is a match, the switch will forward the data packet. Otherwise, the switch will process the data packet according to the processing rule of the 802.1 Q VLAN. When the port receives a tagged data packet, the switch will directly process the data packet according to the processing rule of the 802.1 Q VLAN.

2.1 Using the GUI

2.1.1 Configuring 802.1Q VLAN

Before configuring MAC VLAN, create an 802.1Q VLAN and set the port type according to network requirements. For details, refer to [Configuring 802.1Q VLAN](#).

2.1.2 Binding the MAC Address to the VLAN

Choose the menu **L2 FEATURES > VLAN > MAC VLAN** and click  **Add** to load the following page.

Figure 2-1 Creating MAC VLAN

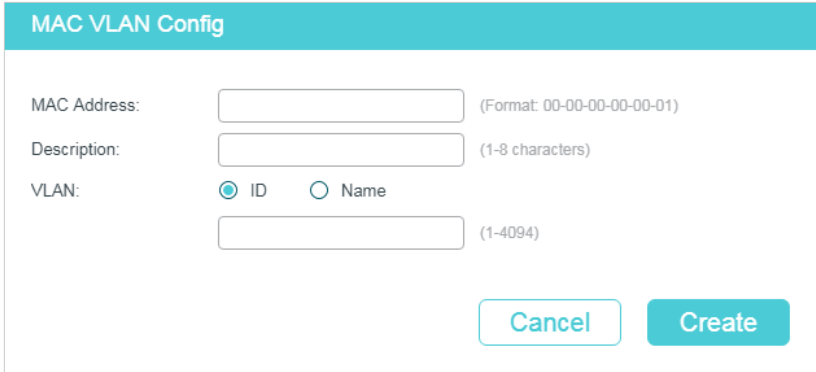

MAC VLAN Config

MAC Address: (Format: 00-00-00-00-00-01)

Description: (1-8 characters)

VLAN: ID Name (1-4094)

Follow these steps to bind the MAC address to the 802.1Q VLAN:

- 1) Enter the MAC address of the device, give it a description, and enter the VLAN ID to bind it to the VLAN.

MAC Address	Enter the MAC address of the device in the format of 00-00-00-00-00-01.
Description	Give a MAC address description for identification with up to 8 characters.
VLAN ID/Name	Enter the ID number or name of the 802.1Q VLAN that will be bound to the MAC VLAN..

- 2) Click **Create**.

 **Note:**

One MAC address can be bound to only one VLAN.

2.1.3 Enabling MAC VLAN for the Port

By default, MAC VLAN is disabled on all ports. You need to enable MAC VLAN for your desired ports manually.

Choose the menu **L2 FEATURES > VLAN > MAC VLAN** to load the following page.

Figure 2-2 Enabling MAC VLAN for the Port

Port Enable

UNIT1
LAGS

1

3

5

7

9

11

13

15

17

19

21

23

25

27

29

31

33

2

4

6

8

10

12

14

16

18

20

22

24

26

28

30

32

34

35

37

39

41

43

45

47

49

51

53

36

38

40

42

44

46

48

50

52

54

Select All

Selected
 Unselected
 Not Available

Apply

MAC VLAN Config

+ Add
 - Delete

<input type="checkbox"/>	Index	MAC Address	Description	VLAN ID	VLAN Name	Operation
No entries in this table.						
Total: 0						

In the **Port Enable** section, select the desired ports to enable MAC VLAN, and click **Apply**.

 **Note:**

The member ports of an LAG follow the configurations of the LAG and not their own. The individual configurations of the ports can take effect only after the ports leave the LAG.

2.2 Using the CLI

2.2.1 Configuring 802.1Q VLAN

Before configuring MAC VLAN, create an 802.1Q VLAN and set the port type according to network requirements. For details, refer to [Configuring 802.1Q VLAN](#).

2.2.2 Binding the MAC Address to the VLAN

Follow these steps to bind the MAC address to the VLAN:

Step 1	configure Enter global configuration mode.
Step 2	mac-vlan mac-address mac-addr vlan vlan-id [description descript] Bind the MAC address to the VLAN. <i>mac-addr</i> : Specify the MAC address of the device in the format of xx:xx:xx:xx:xx:xx. <i>vlan-id</i> : Enter the ID number of the 802.1Q VLAN that will be bound to the MAC VLAN. <i>descript</i> : Specify the MAC address description for identification, with up to 8 characters.
Step 3	show mac-vlan { all mac-address mac-addr vlan vlan-id } Verify the configuration of MAC VLAN. <i>vid</i> : Specify the MAC VLAN to be displayed.
Step 4	end Return to privileged EXEC mode.
Step 5	copy running-config startup-config Save the settings in the configuration file.

The following example shows how to bind the MAC address 00:19:56:8A:4C:71 to VLAN 10, with the address description as Dept.A.

Switch#configure

Switch(config)#mac-vlan mac-address 00:19:56:8a:4c:71 vlan 10 description Dept.A

Switch(config)#show mac-vlan vlan 10

MAC-Addr	Name	VLAN-ID
-----	-----	-----
00:19:56:8A:4C:71	Dept.A	10

Switch(config)#end

Switch#copy running-config startup-config

2.2.3 Enabling MAC VLAN for the Port

Follow these steps to enable MAC VLAN for the port:

Step 1	configure Enter global configuration mode.
Step 2	interface {fastEthernet port range fastEthernet port-list gigabitEthernet port range gigabitEthernet port-list ten-gigabitEthernet port range ten-gigabitEthernet port-list port-channel port-channel-id range port-channel port-channel-list} Enter interface configuration mode.
Step 3	mac-vlan Enable MAC VLAN for the port.
Step 4	show mac-vlan interface Verify the configuration of MAC VLAN on each interface.
Step 5	end Return to privileged EXEC mode.
Step 6	copy running-config startup-config Save the settings in the configuration file.

The following example shows how to enable MAC VLAN for port 1/0/1.

Switch#configure

Switch(config)#interface gigabitEthernet 1/0/1

Switch(config-if)#mac-vlan

Switch(config-if)#show mac-vlan interface

Port STATUS

Gi1/0/1 Enable

Gi1/0/2 Disable

...

Switch(config-if)#end

Switch#copy running-config startup-config

3 Configuration Example

3.1 Network Requirements

Two departments share all the meeting rooms in the company, but use different servers and laptops. Department A uses Server A and Laptop A, while Department B uses Server B and Laptop B. Server A is in VLAN 10 while Server B is in VLAN 20. It is required that Laptop A can only access Server A and Laptop B can only access Server B, no matter which meeting room the laptops are being used in. The figure below shows the network topology.

Figure 3-1 Network Topology

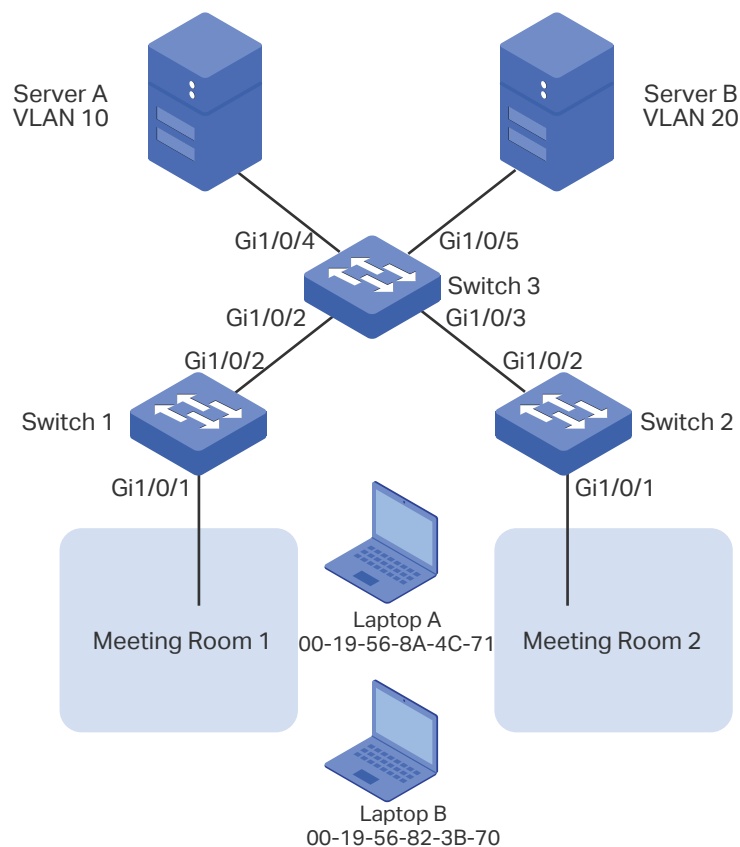

3.2 Configuration Scheme

You can configure MAC VLAN to meet this requirement. On Switch 1 and Switch 2, bind the MAC addresses of the laptops to the corresponding VLANs respectively. In this way, each laptop can access only the server in the VLAN it joins, no matter which meeting room the laptops are being used in. The overview of the configuration is as follows:

- 1) Create VLAN 10 and VLAN 20 on each of the three switches and add the ports to the VLANs based on the network topology. For the ports connecting the laptops, set the

egress rule as Untagged; for the ports connecting to other switch, set the egress rule as Tagged.

- 2) On Switch 1 and Switch 2, bind the MAC addresses of the laptops to their corresponding VLANs, and enable MAC VLAN for the ports.

Demonstrated with SG6654XHP, the following sections provide configuration procedure in two ways: using the GUI and using the CLI.

3.3 Using the GUI

■ Configurations for Switch 1 and Switch 2

The configurations of Switch 1 and Switch 2 are similar. The following introductions take Switch 1 as an example.

- 1) Choose the menu **L2 FEATURES > VLAN > 802.1Q VLAN > VLAN Config** and click  **Add** to load the following page. Create VLAN 10, and add untagged port 1/0/1 and tagged port 1/0/3 to VLAN 10. Click **Create**.

Figure 3-2 Creating VLAN 10



The screenshot shows the 'VLAN Config' interface. At the top, the 'VLAN ID' is set to 10 and the 'VLAN Name' is 'Department_A'. Below this, the 'Untagged Ports' section shows port 1/0/1 selected. A grid of ports is displayed, with port 1 highlighted in blue. The 'Tagged Ports' section shows port 1/0/3 selected. A legend at the bottom indicates that blue boxes represent 'Selected' ports, white boxes represent 'Unselected' ports, and grey boxes represent 'Not Available' ports. At the bottom right, there are 'Cancel' and 'Create' buttons, with the 'Create' button highlighted in red.

- 2) Choose the menu **L2 FEATURES > VLAN > 802.1Q VLAN > VLAN Config** and click  **Add** to load the following page. Create VLAN 20, and add untagged port 1/0/1 and tagged port 1/0/3 to VLAN 20. Click **Create**.

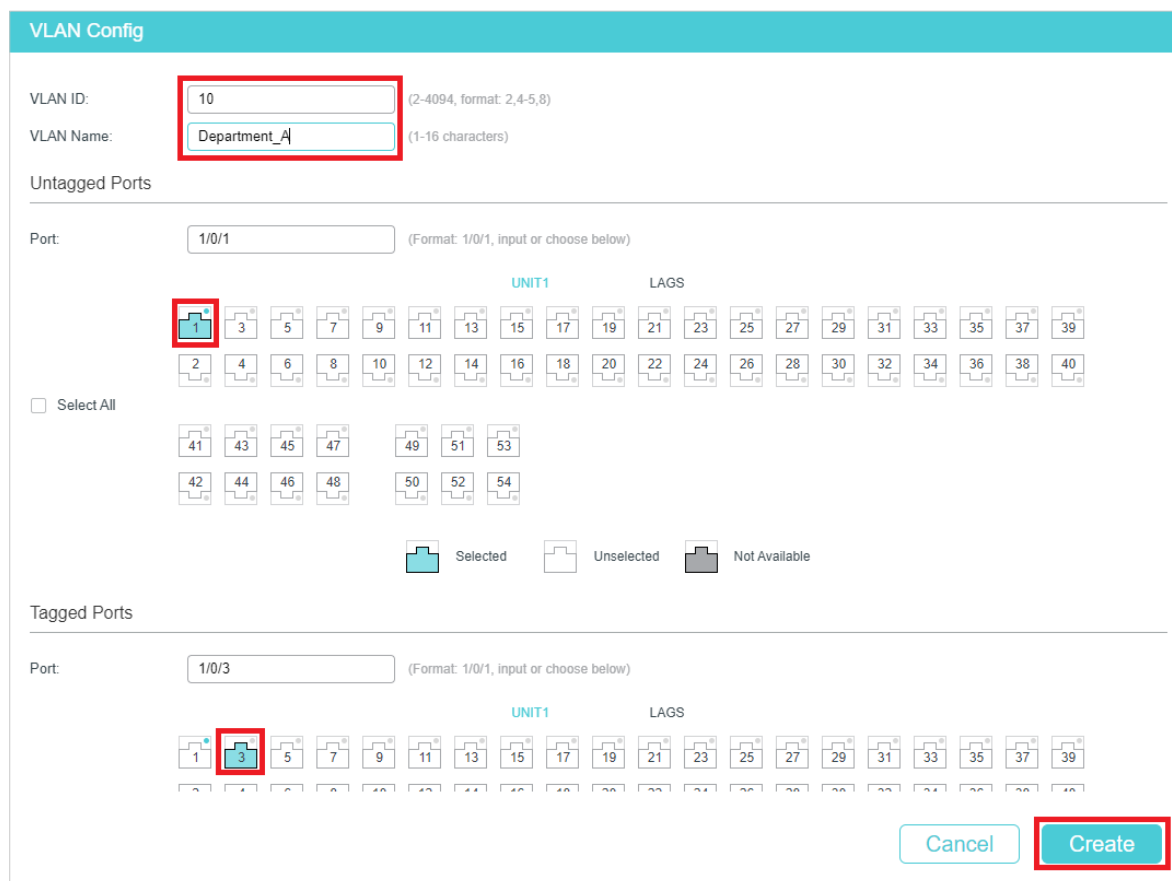
Figure 3-3 Creating VLAN 20

VLAN Config

VLAN ID: (2-4094, format: 2,4-5,8)

VLAN Name: (1-16 characters)

Untagged Ports

Port: (Format: 1/0/1, input or choose below)

1 3 5 7 9 11 13 15 17 19 21 23 25 27 29 31 33 35 37 39
 2 4 6 8 10 12 14 16 18 20 22 24 26 28 30 32 34 36 38 40
 41 43 45 47 49 51 53
 42 44 46 48 50 52 54

Select All

Selected Unselected Not Available

Tagged Ports

Port: (Format: 1/0/1, input or choose below)

1 3 5 7 9 11 13 15 17 19 21 23 25 27 29 31 33 35 37 39
 2 4 6 8 10 12 14 16 18 20 22 24 26 28 30 32 34 36 38 40
 41 43 45 47 49 51 53
 42 44 46 48 50 52 54

- 3) Choose the menu **L2 FEATURES > VLAN > MAC VLAN** and click **+ Add** to load the following page. Specify the corresponding parameters and click **Create** to bind the MAC address of Laptop A to VLAN 10 and bind the MAC address of Laptop B to VLAN 20.

Figure 3-4 Creating MAC VLAN

MAC VLAN Config

MAC Address: (Format: 00-00-00-00-00-01)

Description: (1-8 characters)

VLAN: ID Name

(1-4094)

- 4) Choose the menu **L2 FEATURES > VLAN > MAC VLAN** to load the following page. In the **Port Enable** section select port 1/0/1 and click **Apply** to enable MAC VLAN.

Figure 3-5 Enabling MAC VLAN for the Port

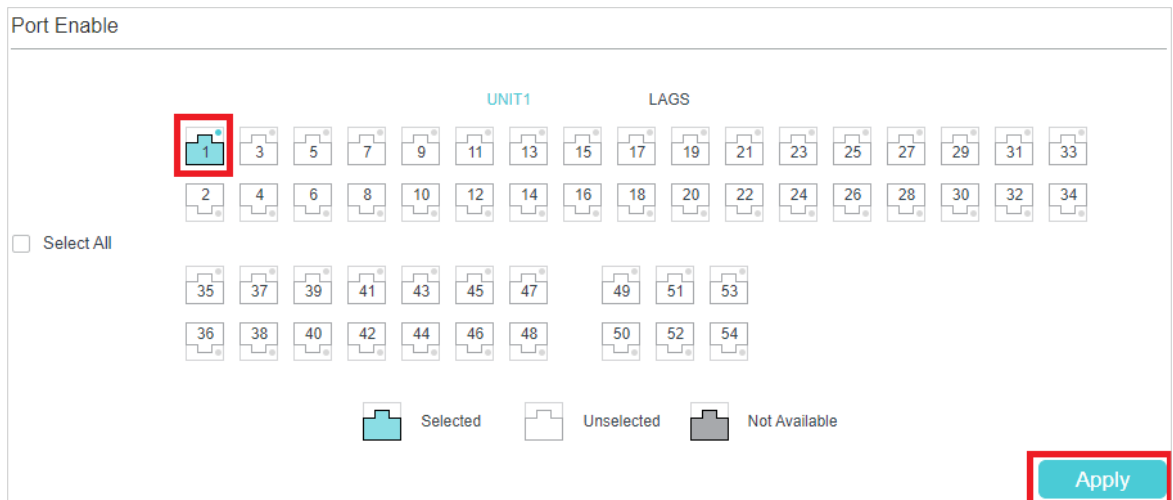

5) Click  to save the settings.

■ Configurations for Switch 3

- 1) Choose the menu **L2 FEATURES > VLAN > 802.1Q VLAN > VLAN Config** and click  **Add** to load the following page. Create VLAN 10, and add untagged port 1/0/4 and tagged ports 1/0/2-3 to VLAN 10. Click **Create**.

Figure 3-6 Creating VLAN 10



- 2) Click **Create** to load the following page. Create VLAN 20, and add untagged port 1/0/5 and tagged ports 1/0/2-3 to VLAN 20. Click **Create**.

Figure 3-7 Creating VLAN 20

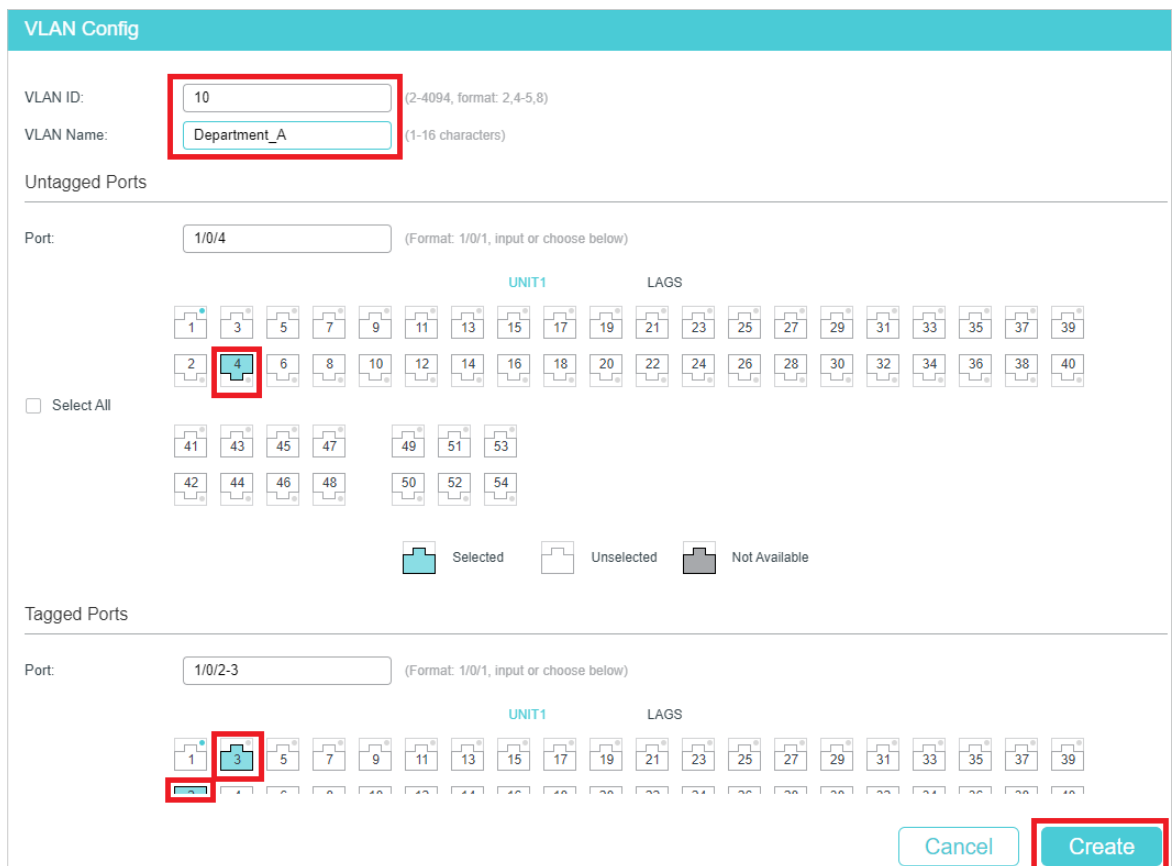
VLAN Config

VLAN ID: (2-4094, format: 2,4-5,8)

VLAN Name: (1-16 characters)

Untagged Ports

Port: (Format: 1/0/1, input or choose below)

UNIT1 LAGS

1 3 5 7 9 11 13 15 17 19 21 23 25 27 29 31 33 35 37 39

2 4 6 8 10 12 14 16 18 20 22 24 26 28 30 32 34 36 38 40

Select All

41 43 45 47 49 51 53

42 44 46 48 50 52 54

Selected Unselected Not Available

Tagged Ports

Port: (Format: 1/0/1, input or choose below)

UNIT1 LAGS

1 3 5 7 9 11 13 15 17 19 21 23 25 27 29 31 33 35 37 39

41 43 45 47 49 51 53

42 44 46 48 50 52 54

- 3) Click  Save to save the settings.

3.4 Using the CLI

■ Configurations for Switch 1 and Switch 2

The configurations of Switch 1 and Switch 2 are the same. The following introductions take Switch 1 as an example.

- 1) Create VLAN 10 for Department A and create VLAN 20 for Department B.

```
Switch_1#configure
Switch_1(config)#vlan 10
Switch_1(config-vlan)#name deptA
Switch_1(config-vlan)#exit
Switch_1(config)#vlan 20
Switch_1(config-vlan)#name deptB
Switch_1(config-vlan)#exit
```

- 2) Add tagged port 1/0/2 and untagged port 1/0/1 to both VLAN 10 and VLAN 20. Then enable MAC VLAN on port 1/0/1.

```
Switch_1(config)#interface gigabitEthernet 1/0/2
Switch_1(config-if)#switchport general allowed vlan 10,20 tagged
Switch_1(config-if)#exit
Switch_1(config)#interface gigabitEthernet 1/0/1
Switch_1(config-if)#switchport general allowed vlan 10,20 untagged
Switch_1(config-if)#mac-vlan
Switch_1(config-if)#exit
```

- 3) Bind the MAC address of Laptop A to VLAN 10 and bind the MAC address of Laptop B to VLAN 20.

```
Switch_1(config)#mac-vlan mac-address 00:19:56:8A:4C:71 vlan 10 description PCA
Switch_1(config)#mac-vlan mac-address 00:19:56:82:3B:70 vlan 20 description PCB
Switch_1(config)#end
Switch_1#copy running-config startup-config
```

■ Configurations for Switch 3

- 1) Create VLAN 10 for Department A and create VLAN 20 for Department B.

```
Switch_3#configure
Switch_3(config)#vlan 10
Switch_3(config-vlan)#name deptA
Switch_3(config-vlan)#exit
Switch_3(config)#vlan 20
Switch_3(config-vlan)#name deptB
Switch_3(config-vlan)#exit
```

- 2) Add tagged port 1/0/2 and port 1/0/3 to both VLAN 10 and VLAN 20.

```
Switch_3(config)#interface gigabitEthernet 1/0/2
Switch_3(config-if)#switchport general allowed vlan 10,20 tagged
Switch_3(config-if)#exit
Switch_3(config)#interface gigabitEthernet 1/0/3
Switch_3(config-if)#switchport general allowed vlan 10,20 tagged
Switch_3(config-if)#exit
```

- 3) Add untagged port 1/0/4 to VLAN 10 and untagged port 1/0/5 to VLAN 20.

```
Switch_3(config)#interface gigabitEthernet 1/0/4
```

```

Switch_3(config-if)#switchport general allowed vlan 10 untagged
Switch_3(config-if)#exit
Switch_3(config)#interface gigabitEthernet 1/0/5
Switch_3(config-if)#switchport general allowed vlan 20 untagged
Switch_3(config-if)#end
Switch_3#copy running-config startup-config

```

Verify the Configurations

■ Switch 1

```
Switch_1#show mac-vlan all
```

MAC Add	Name	VLAN-ID
00:19:56:8A:4C:71	PCA	10
00:19:56:82:3B:70	PCB	20

■ Switch 2

```
Switch_2#show mac-vlan all
```

MAC Address	Description	VLAN
00:19:56:8A:4C:71	PCA	10
00:19:56:82:3B:70	PCB	20

■ Switch 3

```
Switch_3#show vlan
```

VLAN	Name	Status	Ports
1	System-VLAN	active	Gi1/0/1, Gi1/0/2, Gi1/0/3, Gi1/0/4, Gi1/0/5, Gi1/0/6, Gi1/0/7, Gi1/0/8 ...
10	DeptA	active	Gi1/0/2, Gi1/0/3, Gi1/0/4
20	DeptB	active	Gi1/0/2, Gi1/0/3, Gi1/0/5

4 Appendix: Default Parameters

Default settings of MAC VLAN are listed in the following table.

Table 4-1 Default Settings of MAC VLAN

Parameter	Default Setting
MAC Address	None
Description	None
VLAN ID	None
Port Enable	Disabled

Part 10

Configuring Protocol VLAN

CHAPTERS

1. Overview
2. Protocol VLAN Configuration
3. Configuration Example
4. Appendix: Default Parameters

1 Overview

Protocol VLAN is a technology that divides VLANs based on the network layer protocol. With the protocol VLAN rule configured on the basis of the existing 802.1Q VLAN, the switch can analyze specific fields of received packets, encapsulate the packets in specific formats, and forward the packets with different protocols to the corresponding VLANs. Since different applications and services use different protocols, network administrators can use protocol VLAN to manage the network based on specific applications and services.

The figure below shows a common application scenario of protocol VLAN. With protocol VLAN configured, Switch 2 can forward IPv4 and IPv6 packets from different VLANs to the IPv4 and IPv6 networks respectively.

Figure 1-1 Common Application Scenario of Protocol VLAN

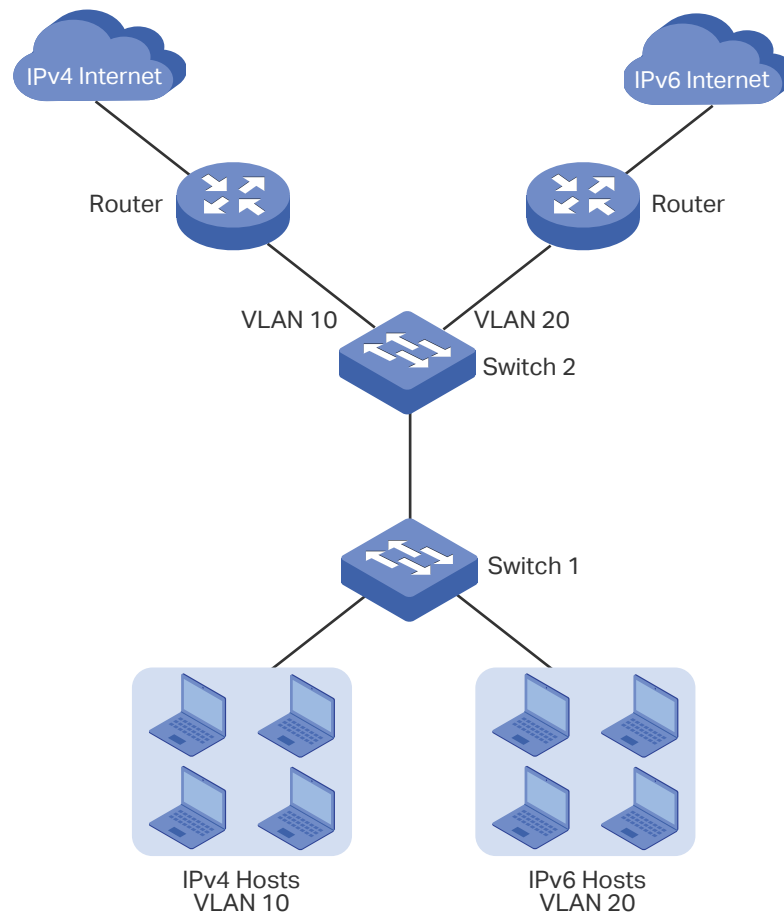

2 Protocol VLAN Configuration

To complete protocol VLAN configuration, follow these steps:

- 1) Configure 802.1Q VLAN.
- 2) Create protocol template.
- 3) Configure Protocol VLAN.

Configuration Guidelines

- You can use the IP, ARP, RARP, and other protocol templates provided by TP-Link switches, or create new protocol templates.
- In a protocol VLAN, when a port receives an untagged data packet, the switch will first search for the protocol VLAN matching the protocol type value of the packet. If there is a match, the switch will insert the corresponding VLAN tag to the data packet and forward it within the VLAN. Otherwise, the switch will forward the data packet to the default VLAN based on the PVID (Port VLAN ID) of the receiving port. (If MAC VLAN is also configured, the switch will first process Protocol VLAN, then MAC VLAN.) When the port receives a tagged data packet, the switch will directly process the data packet according to the processing rule of the 802.1 Q VLAN.

2.1 Using the GUI

2.1.1 Configuring 802.1Q VLAN

Before configuring protocol VLAN, create an 802.1Q VLAN and set the port type according to network requirements. For details, refer to [Configuring 802.1Q VLAN](#).

2.1.2 Creating Protocol Template

Choose the menu **L2 FEATURES > VLAN > Protocol VLAN > Protocol Template** to load the following page.

Figure 2-1 Check the Protocol Template

Protocol Template Config				
				+ Add - Delete
<input type="checkbox"/>	ID	Template Name	Protocol Type	
<input type="checkbox"/>	1	IP	Ethernet II 0800	
<input type="checkbox"/>	2	ARP	Ethernet II 0806	
<input type="checkbox"/>	3	RARP	Ethernet II 8035	
<input type="checkbox"/>	4	IPX	SNAP	
<input type="checkbox"/>	5	AT	SNAP	
Total: 5				

Follow these steps to create a protocol template:

- 1) Check whether your desired template already exists in the **Protocol Template Config** section. If not, click **+ Add** to create a new template.

Figure 2-2 Creating a Protocol Template

Protocol Template Config

Template Name: (1-8 characters)

Frame Type: Ethernet II SNAP LLC

Ether Type: (4 hexadecimal integers, 0600-FFFF)

Template Name	Give a template name to identify the protocol template.
Frame Type	<p>Select the frame type for the protocol template.</p> <p>Ethernet II: A common Ethernet frame format. Select to specify the Frame Type by entering the Ether Type.</p> <p>SNAP: An Ethernet 802.3 frame format based on IEEE 802.3 and IEEE 802.2 SNAP. Select to specify the Frame Type by entering the Ether Type.</p> <p>LLC: An Ethernet 802.3 frame format based on IEEE 802.3 and IEEE 802.2 LLC. Select to specify the Frame Type by entering the DSAP and SSAP.</p>
Ether Type	Enter the Ethernet protocol type value for the protocol template. It is available when Ethernet II and SNAP is selected. It is the Ether Type field in the frame and is used to identify the data type of the frame.

DSAP	Enter the DSAP value for the protocol template. It is available when LLC is selected. It is the DSAP field in the frame and is used to identify the data type of the frame.
SSAP	Enter the SSAP value for the protocol template. It is available when LLC is selected. It is the SSAP field in the frame and is used to identify the data type of the frame.

2) Click **Create**.

 **Note:**

A protocol template that is bound to a VLAN cannot be deleted.

2.1.3 Configuring Protocol VLAN

Choose the menu **L2 FEATURES > VLAN > Protocol VLAN > Protocol VLAN Group** and click  **Add** to load the following page.

Figure 2-3 Configure the Protocol VLAN Group

Follow these steps to configure the protocol group:

1) In the **Protocol Group Config** section, specify the following parameters.

Template Name	Select the previously defined protocol template.
VLAN	Specify the VLAN to be bound to the protocol template by entering the 802.1Q VLAN ID or 802.1Q VLAN Name.
VLAN ID/Name	Enter the ID number or name of the 802.1Q VLAN that will be bound to the Protocol VLAN.

802.1p Priority	Specify the 802.1p priority for the packets that belong to the protocol VLAN. The switch will determine the forwarding sequence according to this value. The packets with larger values for the 802.1p priority have the higher priority.
Members	Displays the port members in the protocol VLAN.

2) Select the desired ports. Click **Create**.

 **Note:**

The member ports of an LAG (Link Aggregation Group) follow the configurations of the LAG and not their own. The individual configurations of the ports can take effect only after the ports leave the LAG.

2.2 Using the CLI

2.2.1 Configuring 802.1Q VLAN

Before configuring protocol VLAN, create an 802.1Q VLAN and set the port type according to network requirements. For details, refer to [Configuring 802.1Q VLAN](#).

2.2.2 Creating a Protocol Template

Follow these steps to create a protocol template:

Step 1	configure Enter global configuration mode.
Step 2	protocol-vlan template name protocol-name frame { ether_2 ether-type type snap ether-type type llc dsap dsap_type ssap ssap_type } Create a protocol template. <i>protocol-name</i> : Specify the protocol name with 1 to 8 characters. <i>type</i> : Enter 4 hexadecimal numbers as the Ethernet protocol type for the protocol template. It is the Ether Type field in the frame and is used to identify the data type of the frame. <i>dsap_type</i> : Enter 2 hexadecimal numbers as the DSAP value for the protocol template. It is the DSAP field in the frame and is used to identify the data type of the frame. <i>ssap_type</i> : Enter 2 hexadecimal numbers as the SSAP value for the protocol template. It is the SSAP field in the frame and is used to identify the data type of the frame.
Step 3	show protocol-vlan template Verify the protocol templates.
Step 4	end Return to Privileged EXEC Mode.

Step 5 **copy running-config startup-config**
Save the settings in the configuration file.

The following example shows how to create an IPv6 protocol template:

Switch#configure

Switch(config)#protocol-vlan template name IPv6 frame ether_2 ether-type 86dd

Switch(config)#show protocol-vlan template

Index	Protocol Name	Protocol Type
1	IP	EthernetII ether-type 0800
2	ARP	EthernetII ether-type 0806
3	RARP	EthernetII ether-type 8035
4	IPX	SNAP ether-type 8137
5	AT	SNAP ether-type 809B
6	IPv6	EthernetII ether-type 86DD

Switch(config)#end

Switch#copy running-config startup-config

2.2.3 Configuring Protocol VLAN

Follow these steps to configure protocol VLAN:

Step 1 **configure**
Enter global configuration mode.

Step 2 **show protocol-vlan template**
Check the index of each protocol template.

Step 3 **protocol-vlan vlan vid priority priority template index**
Bind the protocol template to the VLAN.

vid : Enter the ID number of the 802.1Q VLAN that will be bound to the Protocol VLAN.

priority : Specify the 802.1p priority for the packets that belong to the protocol VLAN. The switch will determine the forwarding sequence according to this value. The packets with a larger value of 802.1p priority have the higher priority.

index : Specify the protocol template index.

Step 4	show protocol-vlan vlan	Check the protocol VLAN index (entry-id) of each protocol group.
Step 5	interface {fastEthernet port range fastEthernet port-list gigabitEthernet port range gigabitEthernet port-list ten-gigabitEthernet port range ten-gigabitEthernet port-list port-channel port-channel-id range port-channel port-channel-list}	Enter interface configuration mode.
Step 6	protocol-vlan group entry-id	Add the specified port to the protocol group. <i>entry-id</i> : Protocol VLAN index.
Step 7	end	Return to Privileged EXEC Mode.
Step 8	copy running-config startup-config	Save the settings in the configuration file.

The following example shows how to bind the IPv6 protocol template to VLAN 10 and add port 1/0/2 to protocol VLAN:

Switch#configure

Switch(config)#show protocol-vlan template

Index	Protocol Name	Protocol Type
1	IP	EthernetII ether-type 0800
2	ARP	EthernetII ether-type 0806
3	RARP	EthernetII ether-type 8035
4	IPX	SNAP ether-type 8137
5	AT	SNAP ether-type 809B
6	IPv6	EthernetII ether-type 86DD

Switch(config)#protocol-vlan vlan 10 priority 5 template 6

Switch(config)#show protocol-vlan vlan

Index	Protocol-Name	VID	Priority	Member
1	IPv6	10	0	

Switch(config)#interface gigabitEthernet 1/0/2

```
Switch(config-if)#protocol-vlan group 1
```

```
Switch(config-if)#show protocol-vlan vlan
```

Index	Protocol-Name	VID	Priority	Member
1	IPv6	10	5	Gi1/0/2

```
Switch(config-if)#end
```

```
Switch#copy running-config startup-config
```

3 Configuration Example

3.1 Network Requirements

A company uses both IPv4 and IPv6 hosts, and these hosts access the IPv4 network and IPv6 network respectively via different routers. It is required that IPv4 packets are forwarded to the IPv4 network, IPv6 packets are forwarded to the IPv6 network, and other packets are dropped.

The figure below shows the network topology. The IPv4 host belongs to VLAN 10, the IPv6 host belongs to VLAN 20, and these hosts access the network via Switch 1. Switch 2 is connected to two routers to access the IPv4 network and IPv6 network respectively. The routers belong to VLAN 10 and VLAN 20 respectively.

Figure 3-1 Network Topology

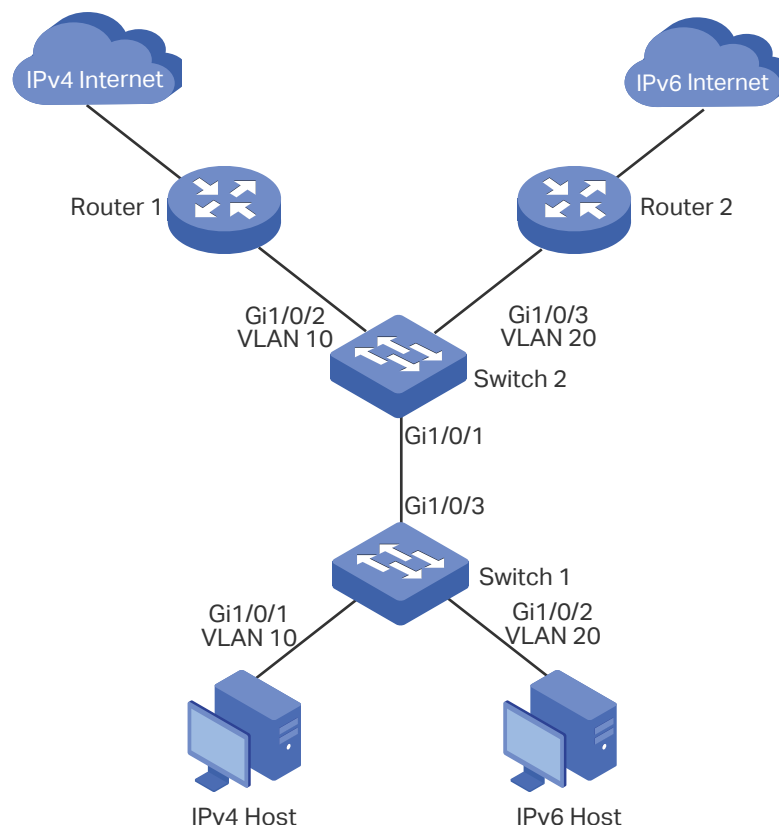

3.2 Configuration Scheme

You can configure protocol VLAN on port 1/0/1 of Switch 2 to meet this requirement. When this port receives packets, Switch 2 will forward them to the corresponding VLANs according to their protocol types. The overview of the configuration on Switch 2 is as follows:

- 1) Create VLAN 10 and VLAN 20 and add each port to the corresponding VLAN.
- 2) Use the IPv4 protocol template provided by the switch, and create the IPv6 protocol template.
- 3) Bind the protocol templates to the corresponding VLANs to form protocol groups, and add port 1/0/1 to the groups.

For Switch 1, configure 802.1Q VLAN according to the network topology.

Demonstrated with SG6654XHP, this chapter provides configuration procedures in two ways: using the GUI and using the CLI.

3.3 Using the GUI

■ Configurations for Switch 1

- 1) Choose the menu **L2 FEATURES > VLAN > 802.1Q VLAN > VLAN Config** and click  **Add** to load the following page. Create VLAN 10, and add untagged port 1/0/1 and untagged port 1/0/3 to VLAN 10. Click **Create**.

Figure 3-2 Create VLAN 10



VLAN Config

VLAN ID: (2-4094, format: 2,4-5,8)

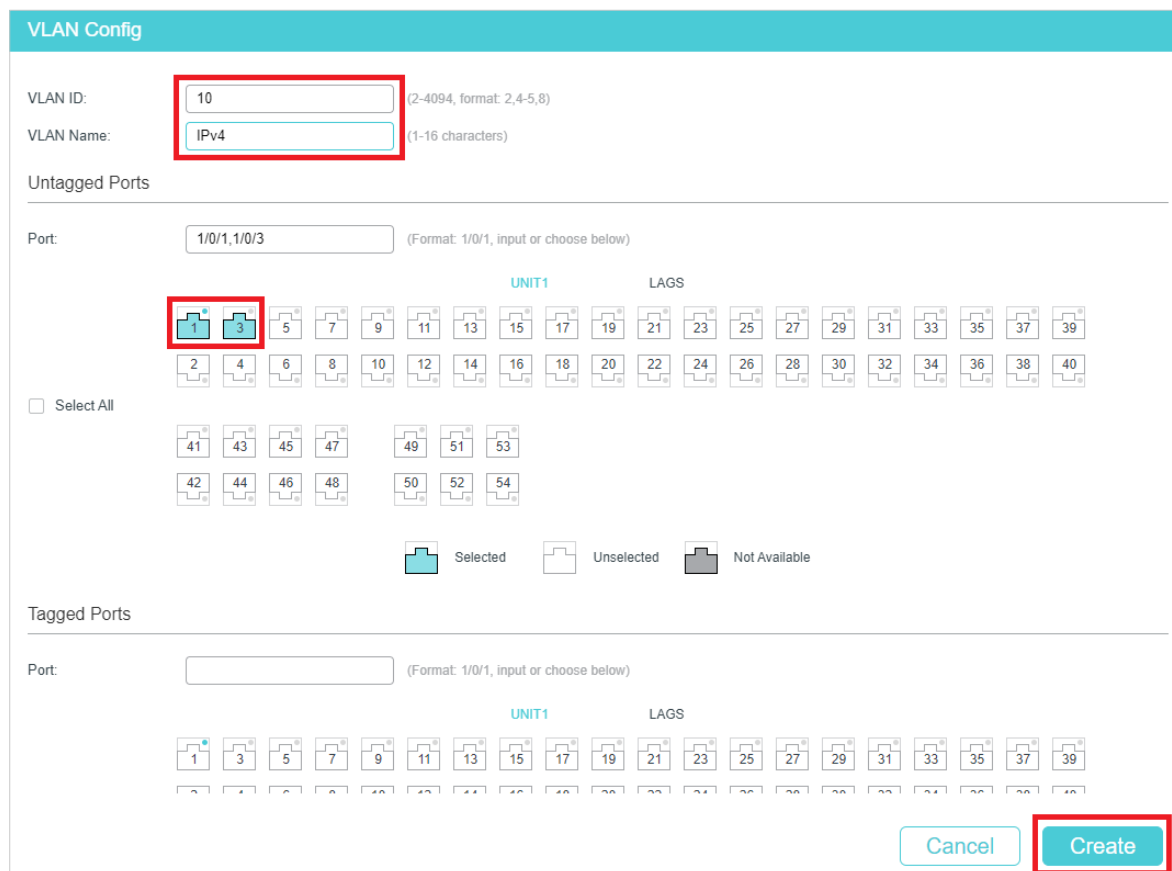
VLAN Name: (1-16 characters)

Untagged Ports

Port: (Format: 1/0/1, input or choose below)

1 3 5 7 9 11 13 15 17 19 21 23 25 27 29 31 33 35 37 39
 2 4 6 8 10 12 14 16 18 20 22 24 26 28 30 32 34 36 38 40
 41 43 45 47 49 51 53
 42 44 46 48 50 52 54

Select All

Selected Unselected Not Available

Tagged Ports

Port: (Format: 1/0/1, input or choose below)

1 3 5 7 9 11 13 15 17 19 21 23 25 27 29 31 33 35 37 39
 2 4 6 8 10 12 14 16 18 20 22 24 26 28 30 32 34 36 38 40

- 2) Click  **Add** to load the following page. Create VLAN 20, and add untagged ports 1/0/2-3 to VLAN 20. Click **Create**.

Figure 3-3 Create VLAN 20

VLAN Config

VLAN ID: (2-4094, format: 2,4-5,8)

VLAN Name: (1-16 characters)

Untagged Ports

Port: (Format: 1/0/1, input or choose below)

UNIT1
LAGS

1	3	5	7	9	11	13	15	17	19	21	23	25	27	29	31	33	35	37	39
2	4	6	8	10	12	14	16	18	20	22	24	26	28	30	32	34	36	38	40
41	43	45	47	49	51	53													
42	44	46	48	50	52	54													

Select All

Selected

Unselected

Not Available

Tagged Ports

Port: (Format: 1/0/1, input or choose below)

UNIT1
LAGS

1	3	5	7	9	11	13	15	17	19	21	23	25	27	29	31	33	35	37	39
41	43	45	47	49	51	53													
42	44	46	48	50	52	54													

- 3) Click  **Save** to save the settings.

■ Configurations for Switch 2

- 1) Choose the menu **L2 FEATURES > VLAN > 802.1Q VLAN > VLAN Config** and click **+ Add** to load the following page. Create VLAN 10, and add tagged port 1/0/1 and untagged port 1/0/2 to VLAN 10. Click **Create**.

Figure 3-4 Create VLAN 10

The screenshot shows the 'VLAN Config' interface. At the top, the title is 'VLAN Config'. Below this, there are two input fields: 'VLAN ID' with the value '10' and a note '(2-4094, format: 2,4-5,8)', and 'VLAN Name' with the value 'IPv4' and a note '(1-16 characters)'. Both fields are highlighted with a red box. Below these is the 'Untagged Ports' section. It has a 'Port:' input field with '1/0/2' and a note '(Format: 1/0/1, input or choose below)'. Underneath is a grid of port icons for 'UNIT1' (ports 1-40) and 'LAGS'. Port 2 in UNIT1 is highlighted with a red box. There is a 'Select All' checkbox which is unchecked. Below the grid are three icons: a blue one labeled 'Selected', a white one labeled 'Unselected', and a grey one labeled 'Not Available'. The 'Tagged Ports' section has a 'Port:' input field with '1/0/1' and a note '(Format: 1/0/1, input or choose below)'. Below this is another grid of port icons. Port 1 in UNIT1 is highlighted with a red box. At the bottom right, there are two buttons: 'Cancel' and 'Create'. The 'Create' button is highlighted with a red box.

- Click **+ Add** to load the following page. Create VLAN 20, and add tagged port 1/0/1 and untagged port 1/0/3 to VLAN 20. Click **Create**.

Figure 3-5 Create VLAN 20

VLAN Config

VLAN ID: (2-4094, format: 2,4-5,8)

VLAN Name: (1-16 characters)

Untagged Ports

Port: (Format: 1/0/1, input or choose below)

UNIT1

1	3	5	7	9	11	13	15	17	19	21	23	25	27	29	31	33	35	37	39
2	4	6	8	10	12	14	16	18	20	22	24	26	28	30	32	34	36	38	40

LAGS

41	43	45	47	49	51	53
42	44	46	48	50	52	54

Selected Unselected Not Available

Tagged Ports

Port: (Format: 1/0/1, input or choose below)

UNIT1

1	3	5	7	9	11	13	15	17	19	21	23	25	27	29	31	33	35	37	39
---	---	---	---	---	----	----	----	----	----	----	----	----	----	----	----	----	----	----	----

- Choose the menu **L2 FEATURES > VLAN > 802.1Q VLAN > Port Config** to load the following page. Set the PVID of port 1/0/2 and port 1/0/3 as 10 and 20 respectively. Click **Apply**.

Figure 3-6 Port Configuration

UNIT1		LAGS				
<input type="checkbox"/>	Port	PVID	Ingress Checking	Acceptable Frame Types	LAG	Details
<input type="checkbox"/>	1/0/1	1	Enabled	Admit All	---	Details
<input type="checkbox"/>	1/0/2	10	Enabled	Admit All	---	Details
<input checked="" type="checkbox"/>	1/0/3	20	Enabled	Admit All	---	Details
<input type="checkbox"/>	1/0/4	1	Enabled	Admit All	---	Details
<input type="checkbox"/>	1/0/5	1	Enabled	Admit All	---	Details
<input type="checkbox"/>	1/0/6	1	Enabled	Admit All	---	Details
<input type="checkbox"/>	1/0/7	1	Enabled	Admit All	---	Details
<input type="checkbox"/>	1/0/8	1	Enabled	Admit All	---	Details
<input type="checkbox"/>	1/0/9	1	Enabled	Admit All	---	Details
<input type="checkbox"/>	1/0/10	1	Enabled	Admit All	---	Details

Total: 54 1 entry selected.

- Choose the menu **L2 FEATURES > VLAN > Protocol VLAN > Protocol Template** and click **+ Add** to load the following page. Enter **IPv6** in the protocol name, select the **Ethernet II** frame type, enter **86DD** in the Ether Type field, and click **Create** to create the IPv6 protocol template.

Tips: The IPv4 protocol template is already provided by the switch. You only need to create the IPv6 protocol template.

Figure 3-7 Create the IPv6 Protocol Template

Protocol Template Config

Template Name: (1-8 characters)

Frame Type: Ethernet II SNAP LLC

Ether Type: (4 hexadecimal integers, 0600-FFFF)

- Choose the menu **L2 FEATURES > VLAN > Protocol VLAN > Protocol VLAN Group** and click **+ Add** to load the following page. Select the IP protocol name (that is the IPv4 protocol template), enter VLAN ID 10, select port 1, and click **Create**.

Figure 3-8 Configure the IPv4 Protocol Group

Protocol VLAN Group Config

Template Name: IP

VLAN: VLAN ID VLAN Name

VLAN ID: 10 (1-4094)

802.1p Priority: 0

Port: 1/0/1 (Format: 1/0/1, input or choose below)

UNIT1 LAGS

1 3 5 7 9 11 13 15 17 19 21 23 25 27 29 31 33 35 37 39

2 4 6 8 10 12 14 16 18 20 22 24 26 28 30 32 34 36 38 40

41 43 45 47 49 51 53

42 44 46 48 50 52 54

Select All

Selected Unselected Not Available

Cancel Create

- 6) Click  Save to save the settings.

3.4 Using the CLI

■ Configurations for Switch 1

- 1) Create VLAN 10 and VLAN 20.

```
Switch_1#configure
```

```
Switch_1(config)#vlan 10
```

```
Switch_1(config-vlan)#name IPv4
```

```
Switch_1(config-vlan)#exit
```

```
Switch_1(config)#vlan 20
```

```
Switch_1(config-vlan)#name IPv6
```

```
Switch_1(config-vlan)#exit
```

- 2) Add untagged port 1/0/1 to VLAN 10. Add untagged port 1/0/2 to VLAN 20. Add untagged port 1/0/3 to both VLAN10 and VLAN 20.

```
Switch_1(config)#interface gigabitEthernet 1/0/1
```

```
Switch_1(config-if)#switchport general allowed vlan 10 untagged
```

```
Switch_1(config-if)#exit
```



```
Switch_1(config)#interface gigabitEthernet 1/0/2
Switch_1(config-if)#switchport general allowed vlan 20 untagged
Switch_1(config-if)#exit
Switch_1(config)#interface gigabitEthernet 1/0/3
Switch_1(config-if)#switchport general allowed vlan 10,20 untagged
Switch_1(config-if)#end
Switch_1#copy running-config startup-config
```

■ Configurations for Switch 2

- 1) Create VLAN 10 and VLAN 20.

```
Switch_2#configure
Switch_2(config)#vlan 10
Switch_2(config-vlan)#name IPv4
Switch_2(config-vlan)#exit
Switch_2(config)#vlan 20
Switch_2(config-vlan)#name IPv6
Switch_2(config-vlan)#exit
```

- 2) Add tagged port 1/0/1 to both VLAN 10 and VLAN 20. Specify the PVID of untagged port 1/0/2 as 10 and add it to VLAN 10. Specify the PVID of untagged port 1/0/3 as 20 and add it to VLAN 20.

```
Switch_2(config)#interface gigabitEthernet 1/0/1
Switch_2(config-if)#switchport general allowed vlan 10,20 tagged
Switch_2(config-if)#exit
Switch_2(config)#interface gigabitEthernet 1/0/2
Switch_2(config-if)#switchport pvid 10
Switch_2(config-if)#switchport general allowed vlan 10 untagged
Switch_2(config-if)#exit
Switch_2(config)#interface gigabitEthernet 1/0/3
Switch_2(config-if)#switchport mode general
Switch_2(config-if)#switchport pvid 20
Switch_2(config-if)#switchport general allowed vlan 20 untagged
Switch_2(config-if)#exit
```

- 3) Create the IPv6 protocol template.

```
Switch_2(config)#protocol-vlan template name IPv6 frame ether_2 ether-type 86dd
```

```
Switch_2(config)#show protocol-vlan template
```

Index	Protocol Name	Protocol Type
1	IP	EthernetII ether-type 0800
2	ARP	EthernetII ether-type 0806
3	RARP	EthernetII ether-type 8035
4	IPX	SNAP ether-type 8137
5	AT	SNAP ether-type 809b
6	IPv6	Ethernet II ether-type 86dd

- 4) Configure the protocol groups.

```
Switch_2(config)#protocol-vlan vlan 10 priority 0 template 1
```

```
Switch_2(config)#protocol-vlan vlan 20 priority 0 template 6
```

- 5) Add port 1/0/1 to the protocol groups.

```
Switch_2(config)#show protocol-vlan vlan
```

Index	Protocol-Name	VID	Member
1	IP	10	
2	IPv6	20	

```
Switch_2(config)#interface gigabitEthernet 1/0/1
```

```
Switch_2(config-if)#protocol-vlan group 1
```

```
Switch_2(config-if)#protocol-vlan group 2
```

```
Switch_2(config-if)#exit
```

```
Switch_2(config)#end
```

```
Switch_2#copy running-config startup-config
```

Verify the Configurations

■ Switch 1

Verify 802.1Q VLAN configuration:

```
Switch_1#show vlan
```

VLAN	Name	Status	Ports
1	System-VLAN	active	Gi1/0/1, Gi1/0/2, Gi1/0/3, Gi1/0/4 ... Gi2/0/48, Te2/0/49, Te2/0/50, Te2/0/51, Te2/0/52, Te2/0/53, Te2/0/54
10	IPv4	active	Gi1/0/1, Gi1/0/3
20	IPv6	active	Gi1/0/2, Gi1/0/3

■ Switch 2

Verify 802.1Q VLAN configuration:

Switch_2#show vlan

VLAN	Name	Status	Ports
1	System-VLAN	active	Gi1/0/1, Gi1/0/2, Gi1/0/3, Gi1/0/4 ... Gi2/0/48, Te2/0/49, Te2/0/50, Te2/0/51, Te2/0/52, Te2/0/53, Te2/0/54
10	IPv4	active	Gi1/0/1, Gi1/0/2
20	IPv6	active	Gi1/0/1, Gi1/0/3

Verify protocol group configuration:

Switch_2#show protocol-vlan vlan

Index	Protocol-Name	VID	Priority	Member
1	IP	10	0	Gi1/0/1
2	IPv6	20	0	Gi1/0/1

4 Appendix: Default Parameters

Default settings of Protocol VLAN are listed in the following table.

Table 4-1 Default Settings of Protocol VLAN

Parameter	Default Setting		
Protocol Template Table	1	IP	Ethernet II ether-type 0800
	2	ARP	Ethernet II ether-type 0806
	3	RARP	Ethernet II ether-type 8035
	4	IPX	SNAP ether-type 8137
	5	AT	SNAP ether-type 809B

Part 11

Configuring VLAN-VPN

(Only for Certain Devices)

CHAPTERS

1. VLAN-VPN
2. Basic VLAN-VPN Configuration
3. Flexible VLAN-VPN Configuration
4. Configuration Examples
5. Appendix: Default Parameters

1 VLAN-VPN

1.1 Overview

 Note:

VLAN VPN is only available on certain devices. To check whether your device supports this feature, refer to the actual web interface. If VLAN VPN is available, there is **L2 FEATURES > VLAN > VLAN VPN** in the menu structure.

VLAN-VPN (Virtual Private Network) is an easy-to-implement layer 2 VLAN technology, and it is usually deployed at the edge of the ISP (Internet Service Provider) network.

With VLAN-VPN, when forwarding packets from the customer network to the ISP network, the switch adds an outer tag to the packets with outer VLAN ID. Thus, packets can be transmitted through ISP networks with double VLAN tags. In the ISP network, packets are forwarded according to the outer VLAN tag (VLAN tag of the ISP network), while the inner VLAN tag is treated as part of the payload. When forwarding packets from the ISP network to the customer network, the switch remove the outer VLAN tag of the packets. Thus, packets are forwarded according to the inner VLAN tag (VLAN tag of the customer network) in the customer network.

The following figure shows the typical application scenario of VLAN-VPN. To realize the communication between two customer VLANs across the ISP network, you can configure VLAN-VPN at the ISP edge switches to allow packets from customer VLAN 100 and VLAN 200 to be forwarded through the ISP network with the outer tag of VLAN 1050.

Figure 1-1 Application Scenario of VLAN-VPN

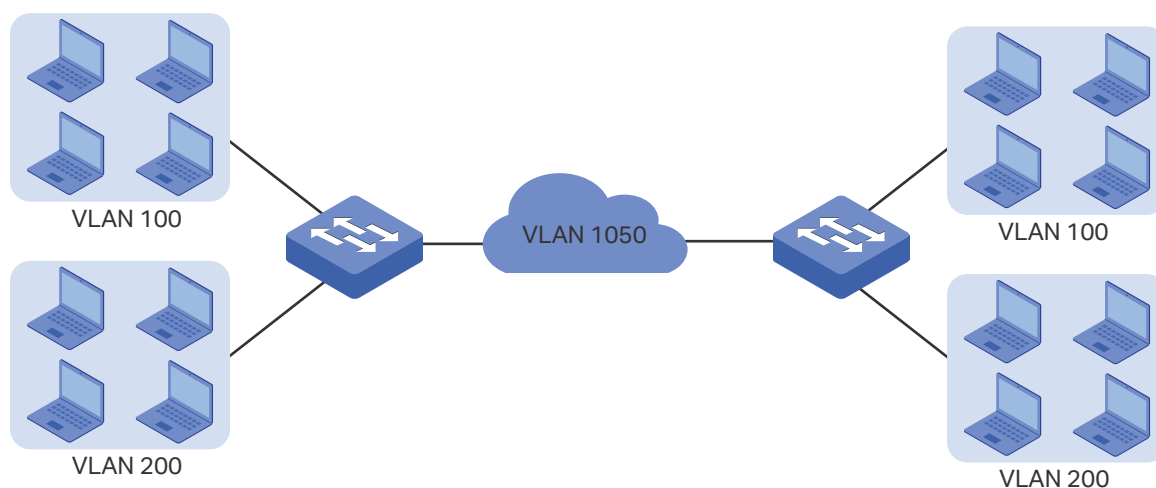

1.2 Supported Features

The VLAN-VPN function includes: basic VLAN-VPN and flexible VLAN-VPN (VLAN mapping).

Basic VLAN-VPN

All packets from customer VLANs are encapsulated with the same VLAN tag of the ISP network, and sent to the ISP network. Additionally, you can set the TPID (Tag Protocol Identifier) for compatibility with devices in the ISP network.

Flexible VLAN-VPN

You can configure different VLANs in the customer network to map to different VLANs in the ISP network.

When the switch receives a packet with the customer network tag, the switch will check the VLAN Mapping List. If a match is found, the switch encapsulates the packet with the corresponding VLAN tag of the ISP network, and forwards it to the corresponding port. If no match is found, the switch process the packet in rules of MAC VLAN, Protocol VLAN and 802.1Q VLAN. For untagged packets, the switch directly processes them in rules of MAC VLAN, Protocol VLAN and 802.1Q VLAN.

2 Basic VLAN-VPN Configuration

To complete the basic VLAN-VPN configuration, follow these steps:

- 1) Configure 802.1Q VLAN.
- 2) Configure NNI ports and UNI ports.
- 3) Enable VLAN-VPN globally.

Configuration Guidelines

- The TPID preset by the switch is 0x8100. If the devices in the ISP network do not support this value, you should change it to ensure VLAN-VPN packets sent to the ISP network can be recognized and forwarded by devices of other manufacturers.
- You can go to 802.1Q VLAN section to specify the Ingress Checking feature according to your needs. If the Ingress Checking is enabled, the port will perform this operation first then process the packets based on the VLAN-VPN configuration. If Ingress Checking is disabled, the port will process the packets directly based on the VLAN-VPN configuration.

2.1 Using the GUI

2.1.1 Configuring 802.1Q VLAN

Before configuring VLAN-VPN, create 802.1Q VLAN add ports to corresponding VLANs and configure Ingress Checking on ports according to your needs. For details, refer to [Configuring 802.1Q VLAN](#).

2.1.2 Configuring Basic VLAN-VPN

Choose the menu **L2 FEATURES > VLAN > VLAN VPN > VPN Config** to load the following page.

Figure 2-1 Basic VPN Configuration

Global Config

VLAN VPN: Enable Apply

Port Config

UNIT1

LAGS

<input type="checkbox"/>	Port	Port Role	TPID	Use Inner Priority
<input type="checkbox"/>	1/0/1	--	8100	Disabled
<input type="checkbox"/>	1/0/2	--	8100	Disabled
<input type="checkbox"/>	1/0/3	--	8100	Disabled
<input type="checkbox"/>	1/0/4	--	8100	Disabled
<input type="checkbox"/>	1/0/5	--	8100	Disabled
<input type="checkbox"/>	1/0/6	--	8100	Disabled
<input type="checkbox"/>	1/0/7	--	8100	Disabled
<input type="checkbox"/>	1/0/8	--	8100	Disabled
<input type="checkbox"/>	1/0/9	--	8100	Disabled
<input type="checkbox"/>	1/0/10	--	8100	Disabled

Total: 54

Follow these steps to configure the basic VLAN-VPN parameters:

- 1) In the **Global Config** section, enable VLAN VPN globally, and click **Apply**.

VLAN VPN Enable or disable VLAN VPN.

- 2) In the **Port Config** section, select on or more ports and configure the corresponding parameters. Click **Apply**.

Port Role Select the port role that will take effect in the VLAN-VPN function.

NNI: NNI ports are usually connected to the ISP network, and the packets forwarded by these port have double VLAN tags.

UNI: UNI ports are usually connected to the customer network. The outer VLAN tags will be added or removed when the packets are forwarded by the VPN port.

Note:

The direct shift between ports modes UNI and NNI is not supported. To switch from the current mode to another mode, you can change the port role to "--" first.

TPID Specify the value of TPID. TPID is a field of VLAN tag and is modified to make the double tagged packets identifiable to devices from different vendors.

Use Inner Priority

Enable this function and the switch will determine the forwarding sequence of the packets according to the 802.1p priority of the inner VLAN tag.

It is available only when the port role is UNI.

 **Note:**

- The PVID of the UNI port should be specified as the VLAN ID of the ISP VLAN.
- The member ports of an LAG follow the configurations of the LAG and not their own. The individual configurations of the ports can take effect only after the ports leave the LAG.

2.2 Using the CLI

2.2.1 Configuring 802.1Q VLAN

Before configuring VLAN-VPN, create 802.1Q VLAN, add ports to corresponding VLANs and configure Ingress Checking on ports according to your needs. For details, refer to [Configuring 802.1Q VLAN](#).

2.2.1 Configuring Basic VLAN-VPN

Follow these steps to configure basic VLAN-VPN:

Step 1	configure Enter global configuration mode.
Step 2	dot1q-tunnel Enable the VLAN-VPN feature globally.
Step 3	interface {fastEthernet port range fastEthernet port-list gigabitEthernet port range gigabitEthernet port-list ten-gigabitEthernet port range ten-gigabitEthernet port-list port-channel port-channel-id range port-channel port-channel-list} Enter interface configuration mode.
Step 4	switchport dot1q-tunnel mode { nni uni } Select the port role that will take effect in the VLAN-VPN function. <i>nni</i> : NNI ports are usually connected to the ISP network, and the packets forwarded by these port have outer VLAN tags. <i>uni</i> : UNI ports are usually connected to the customer network. The outer VLAN tags will be added or removed when the packets are forwarded by the UNI port. Note: The direct shift between ports modes uni and nni is not supported. To switch from the current mode to another mode, you can use no switchport dot1q-tunnel mode to disable the current mode.

Step 5	switchport dot1q-tunnel tpid <i>tpid</i> Specify the value of TPID. TPID is a field of VLAN tag and is modified to make the double tagged packets identifiable to devices from different vendors. <i>tpid</i> : Enter the IPID for the port. It must be 4 Hex integers. By default, it is 8100.
Step 6	switchport dot1q-tunnel missdrop Enable the Missdrop feature. This option only can take effect on tagged packets. With Missdrop enabled, the tagged packets that don't match the VLAN Mapping entries will be dropped. By default, it is disabled.
Step 7	switchport dot1q-tunnel use_inner_priority Enable this function and the switch will determine the forwarding sequence of the packets according to the 802.1p priority of the inner VLAN tag. By default, it is disabled. It is available only when the port mode is UNI.
Step 8	show dot1q-tunnel Verify the global configuration of VLAN-VPN.
Step 9	show dot1q-tunnel interface Verify the interface configuration of basic VLAN-VPN.
Step 10	end Return to privileged EXEC mode.
Step 11	copy running-config startup-config Save the settings in the configuration file.

The following example shows how to enable the VLAN-VPN feature globally, set port 1/0/1 of switch as the UNI port and 1/0/2 as the NNI port:

Switch#configure

Switch(config)#dot1q-tunnel

Switch(config)#interface gigabitEthernet 1/0/1

Switch(config-if)#switchport dot1q-tunnel mode uni

Switch(config-if)#exit

Switch(config)#interface gigabitEthernet 1/0/2

Switch(config-if)#switchport dot1q-tunnel mode nni

Switch(config-if)#show dot1q-tunnel

VLAN-VPN Mode: Enabled

Mapping Mode: Disabled

Switch(config-if)#show dot1q-tunnel interface

Port	Type	Tpid	Use Inner Priority	LAG
-----	-----	-----	-----	---
Gi1/0/1	UNI	0x8100	Disable	N/A
Gi1/0/2	NNI	0x8100	Enable	N/A

...

Switch(config-if)#end

Switch#copy running-config startup-config

3 Flexible VLAN-VPN Configuration

To complete the flexible VLAN-VPN configuration, follow these steps:

- 1) Configure 802.1Q VLAN and basic VLAN-VPN.
- 2) Configure VLAN mapping.

Configuration Guidelines

- Before you start, configure 802.1Q VLAN and the basic VLAN-VPN.
- You can specify the PVID of the UNI port according to your needs. The untagged packets and the tagged packets that don't the VLAN mapping entry may be added the outer VLAN tag with this PVID according to your configuration.

3.1 Using the GUI

Choose the menu **L2 FEATURES > VLAN > VLAN VPN > VLAN Mapping** to load the following page.

Figure 3-1 Enable Flexible VLAN-VPN

Global Config

VLAN Mapping: Enable Apply

VLAN Mapping Config

+ Add - Delete

	Index	Port	C VLAN ID	C VLAN Name	SP VLAN ID	SP VLAN Name	Description	Operation
No entries in this table.								
Total: 0								

Follow these steps to configure flexible VLAN-VPN:

- 1) In the **Global Config** section, enable VLAN mapping globally and click **Apply**.
- 2) In the **VLAN Mapping Config** section, click + **Add** to load the following page. Configure the following parameters.

Figure 3-2 Create VLAN Mapping Entry

Port	For some devices, choose a UNI port to enable VLAN mapping. Usually, ports that are connected to the customer network are set as UNI ports.
C VLAN	Specify the customer VLAN of the UNI port by entering the VLAN ID or VLAN Name.
C VLAN ID	Enter the VLAN ID of the customer network.
C VLAN Name	Enter the VLAN Name of the customer network.
SP VLAN	Specify the ISP VLAN of the UNI port by entering the VLAN ID or VLAN Name.
SP VLAN ID	Enter the VLAN ID of the ISP network.
SP VLAN Name	Enter the VLAN Name of the ISP network.
Description	Give a description to identify the VLAN Mapping.

3) Click **Create**.

3.2 Using the CLI

Follow these steps to configure flexible VLAN-VPN:

Step 1	configure Enter global configuration mode.
Step 2	dot1q-tunnel mapping Enable VLAN mapping globally.

-
- Step 3 **interface {fastEthernet port | range fastEthernet port-list | gigabitEthernet port | range gigabitEthernet port-list | ten-gigabitEthernet port | range ten-gigabitEthernet port-list | port-channel port-channel-id | range port-channel port-channel-list}**
 For some devices, choose a UNI port to enable VLAN mapping. For other devices, choose a NNI port to enable VLAN mapping.
-
- Step 4 **switchport dot1q-tunnel mapping c-vlan sp-vlan [descript]**
 Set VLAN mapping entries for the specified port.
c vlan: Enter VLAN ID of the customer network.
sp vlan: Enter VLAN ID of the ISP network.
descript: Give a description to identify the VLAN Mapping.
-
- Step 5 **end**
 Return to privileged EXEC mode.
-
- Step 6 **copy running-config startup-config**
 Save the settings in the configuration file.
-

The following example shows how to enable VLAN mapping and set a VLAN mapping entry named mapping1 on port 1/0/3 to map customer network VLAN 15 to ISP network VLAN 1040:

Switch#configure

Switch(config)#dot1q-tunnel mapping

Switch(config)#show dot1q-tunnel

VLAN-VPN Mode: Enabled

Mapping Mode: Enabled

Switch(config)#interface gigabitEthernet 1/0/3

Switch(config-if)#switchport dot1q-tunnel mapping 15 1040 mapping1

Switch(config-if)#show dot1q-tunnel mapping

Port	C-VLAN	SP-VLAN	Name
-----	-----	-----	-----
Gi1/0/3	15	1040	mapping1

Switch(config-if)#end

Switch#copy running-config startup-config

4 Configuration Examples

4.1 Example for Basic VLAN VPN

4.1.1 Network Requirements

A company has two stations, and the computers belong to VLAN 100 and VLAN 200 respectively. The ISP VLAN is VLAN 1050 and the TPID adopted by the ISP network is 0x9100.

The two stations need to communicate with each other through the ISP network. And it is required that the traffic from VLAN 100 and VLAN 200 should be transmitted in VLAN 1050.

Figure 4-1 Network Topology

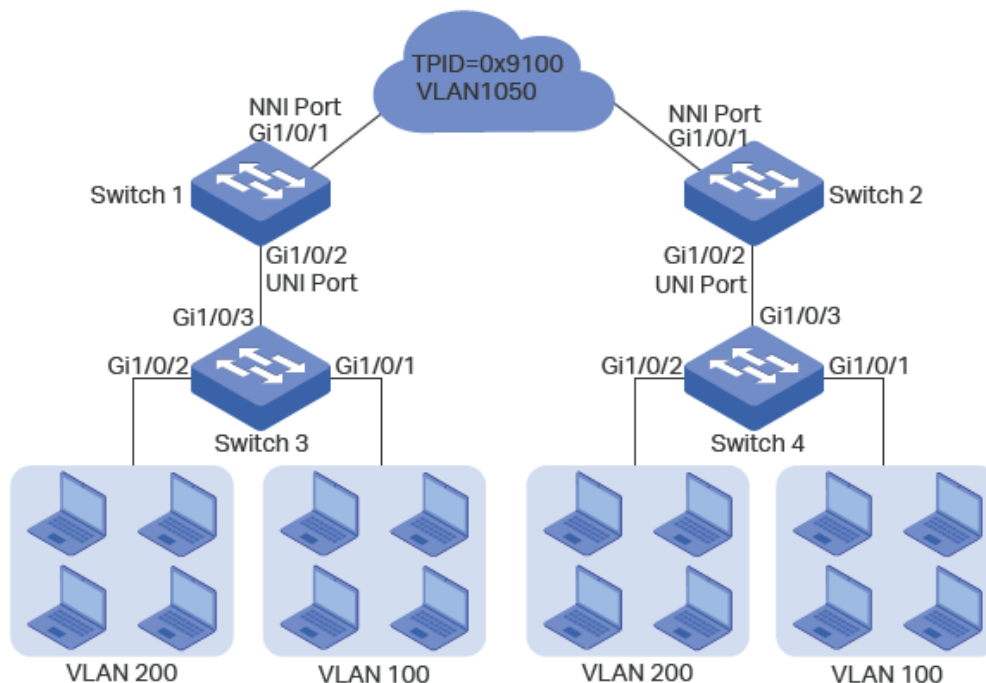

4.1.2 Configuration Scheme

To meet the requirement that all the traffic from VLAN 100 and VLAN 200 should be transmitted through VLAN 1050, users can configure basic VLAN VPN on Switch 1 and Switch 2 to allow packets sent with double VLAN tags, and thus ensure the communication between them. The general configuration procedure is as follows:

Here we only introduce the configuration schemes on switch 1 and switch 3, for the configurations on switch 2 are the same as those on switch 1, and the configurations on switch 4 are the same as those on switch 3.

- 1) Configure 802.1Q VLAN on switch 1. The parameters are shown below:

	VLAN 100	VLAN 200	VLAN 1050	PVID
Port 1/0/1	-	-	Tagged	Keep the default value
Port 1/0/2	Tagged	Tagged	Untagged	1050

- 2) Configure 802.1Q VLAN on switch 3. The parameters are shown below:

	VLAN 100	VLAN 200	PVID
Port 1/0/1	Untagged	-	100
Port 1/0/2	-	Untagged	200
Port 1/0/3	Tagged	Tagged	Keep the default value

- 3) Configure VLAN VPN on switch 1. Set port 1/0/1 as NNI port and port 1/0/2 as UNI port; configure the TPID as 0x9100.

Demonstrated with T2600G-28TS, this chapter provides configuration procedures in two ways: using the GUI and using the CLI.

4.1.3 Using the GUI

■ Configuring Switch 1:

- 1) Go to **L2 FEATURES > VLAN > 802.1Q VLAN** to create VLAN 100, VLAN 200 and VLAN 1050. Configure the egress rule of port 1/0/2 in VLAN 100 and VLAN 200 as Tagged, and in VLAN 1050 as Untagged; Configure the egress rule of port 1/0/1 in VLAN 1050 as Tagged.

Figure 4-2 Create VLAN 100

VLAN Config

VLAN ID: (2-4094, format: 2,4-5,8)

VLAN Name: (1-16 characters)

Untagged Ports



Port:

(Format: 1/0/1, input or choose below)

UNIT1 LAGS

1	3	5	7	9	11	13	15	17	19	21	23	25	27	29	31	33	35	37	39
2	4	6	8	10	12	14	16	18	20	22	24	26	28	30	32	34	36	38	40
41	43	45	47	49	51	53													
42	44	46	48	50	52	54													

Select All

 Selected  Unselected  Not Available

Tagged Ports

Port: (Format: 1/0/1, input or choose below)

UNIT1 LAGS

1	3	5	7	9	11	13	15	17	19	21	23	25	27	29	31	33	35	37	39
																			

Figure 4-3 Create VLAN 200

VLAN Config

VLAN ID: (2-4094, format: 2,4-5,8)

VLAN Name: (1-16 characters)

Untagged Ports



Port:

(Format: 1/0/1, input or choose below)

UNIT1 LAGS

1	3	5	7	9	11	13	15	17	19	21	23	25	27	29	31	33	35	37	39
2	4	6	8	10	12	14	16	18	20	22	24	26	28	30	32	34	36	38	40
41	43	45	47	49	51	53													
42	44	46	48	50	52	54													

Select All

 Selected  Unselected  Not Available

Tagged Ports

Port: (Format: 1/0/1, input or choose below)

UNIT1 LAGS

1	3	5	7	9	11	13	15	17	19	21	23	25	27	29	31	33	35	37	39
2	4	6	8	10	12	14	16	18	20	22	24	26	28	30	32	34	36	38	40
41	43	45	47	49	51	53													
42	44	46	48	50	52	54													

Figure 4-4 Create VLAN 1050

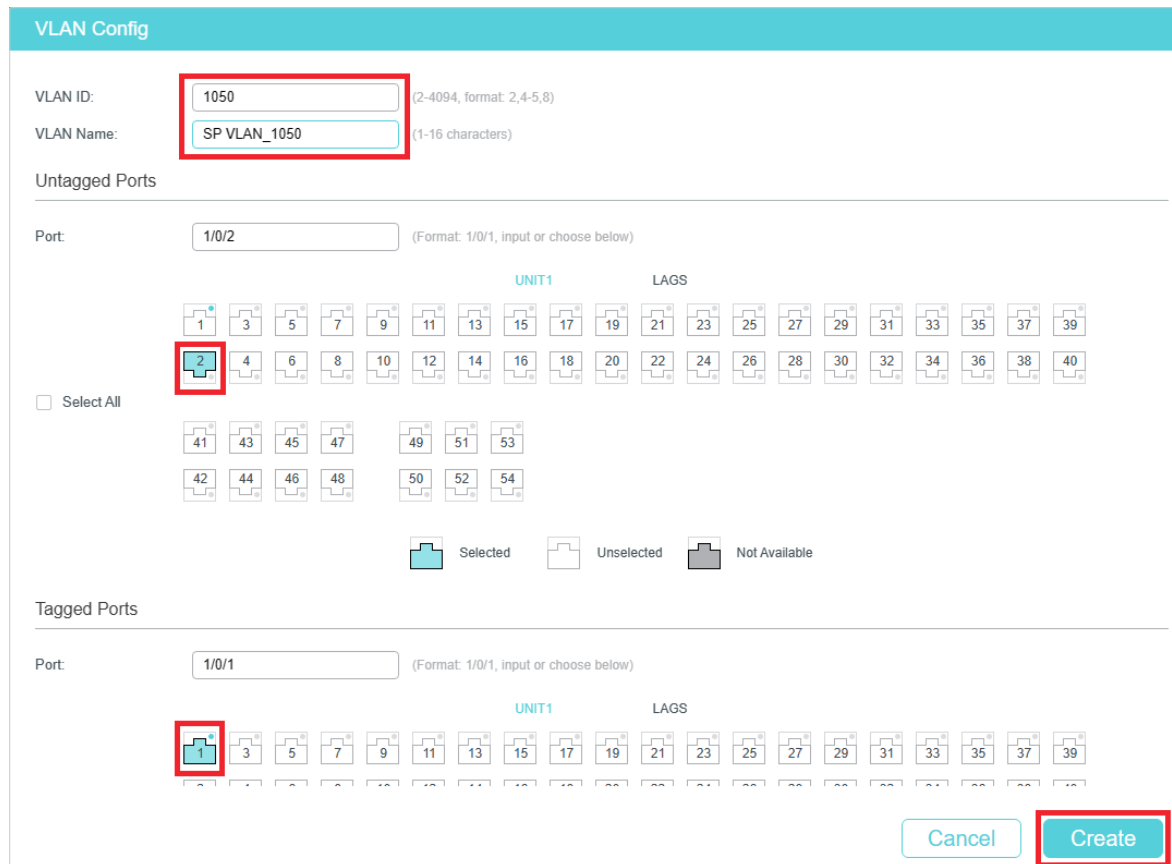

- 2) Go to **L2 FEATURES > VLAN > Port Config** to set the PVID as 1050 for port 1/0/2 and leave the default value 1 for port 1/0/1.

Figure 4-5 Configuring PVID

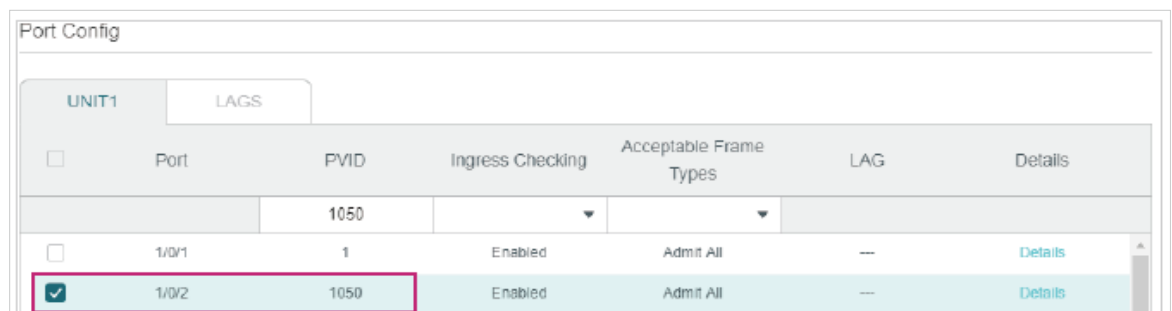

- 3) Go to **L2 FEATURES > VLAN > VLAN VPN > VPN Config**, enable VLAN VPN globally; set port 1/0/1 as NNI port and port 1/0/2 as UNI port. Specify the TPID of port 1/0/1 as 9100.

Figure 4-6 Enabling VLAN VPN Globally and Configuring the Ports

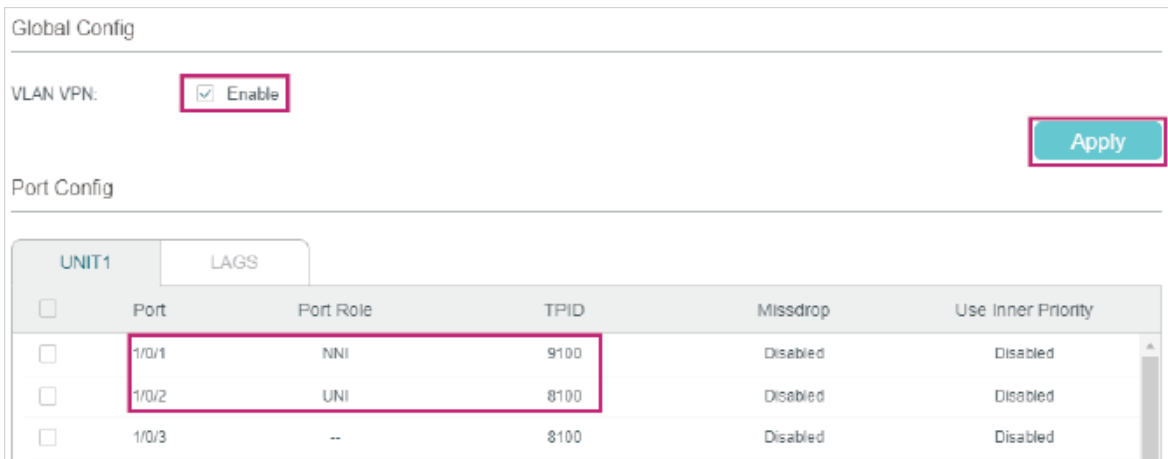

4) Click  Save to save the settings.

■ **Configuring Switch 3:**

- 1) Go to **L2 FEATURES > VLAN > 802.1Q VLAN** to create VLAN 100 and VLAN 200. Configure the egress rules of port 1/0/1 in VLAN 100 as Untagged; egress rules of port 1/0/2 in VLAN 200 as Untagged; egress rule of port 1/0/3 in VLAN 100 and VLAN 200 as Tagged.

Figure 4-7 Creating VLAN 100

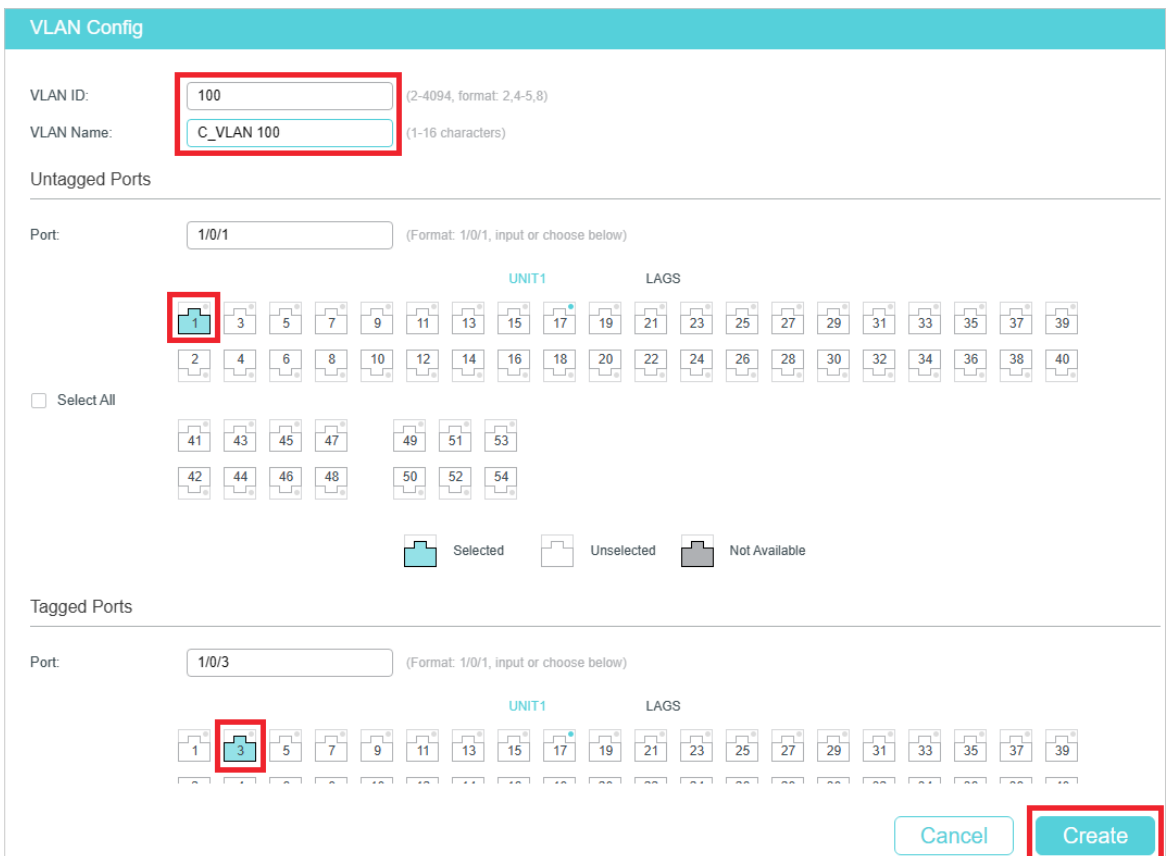
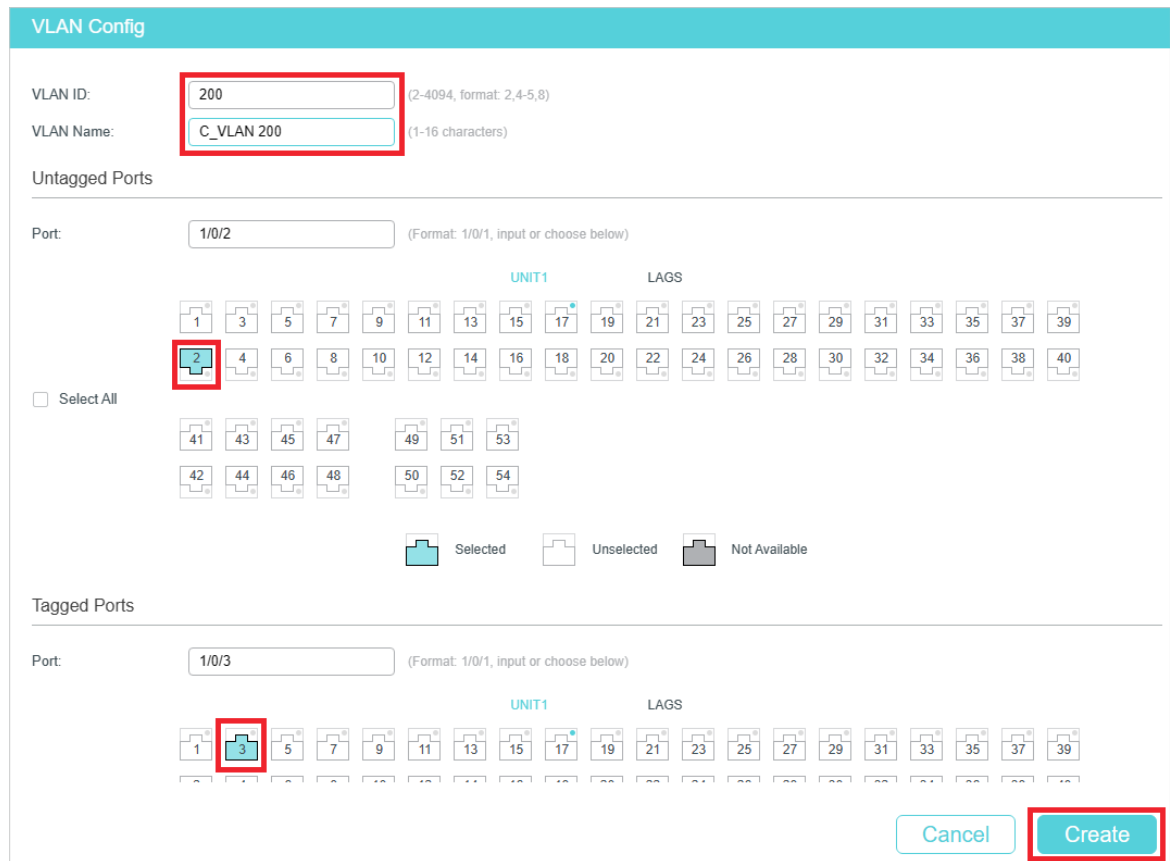

Figure 4-8 Creating VLAN 200



- 2) Go to **L2 FEATURES > VLAN > Port Config** to set the PVID as 100 for port 1/0/1 and 200 for port 1/0/2.

Figure 4-9 Configuring PVID

Port Config						
UNIT1		LAGS				
<input type="checkbox"/>	Port	PVID	Ingress Checking	Acceptable Frame Types	LAG	Details
<input type="checkbox"/>	1/0/1	100	Enabled	Admit All	---	Details
<input type="checkbox"/>	1/0/2	200	Enabled	Admit All	---	Details
<input type="checkbox"/>	1/0/3	1	Enabled	Admit All	---	Details

- 3) Click  Save to save the settings.

4.1.4 Using the CLI

The configurations of Switch 1 and Switch 2 are similar. The following introductions take Switch 1 as an example.

- 1) Create VLAN 1050, VLAN 100 and VLAN 200.

```
Switch_1#configure
Switch_1(config)#vlan 1050
Switch_1(config-vlan)#name SP_VLAN
```

```
Switch_1(config-vlan)#exit
Switch_1(config)#vlan 100
Switch_1(config-vlan)#name C_VLAN100
Switch_1(config-vlan)#exit
Switch_1(config)#vlan 200
Switch_1(config-vlan)#name C_VLAN200
Switch_1(config-vlan)#exit
```

- 2) Add port 1/0/1 to VLAN 1050 as tagged port, modify PVID as 1050, set the port as NNI port and specify the TPID as 9100.

```
Switch_1(config)#interface gigabitEthernet 1/0/1
Switch_1(config-if)#switchport general allowed vlan 1050 tagged
Switch_1(config-if)#switchport pvid1050
Switch_1(config-if)#switchport dot1q-tunnel mode nni
Switch_1(config-if)#switchport dot1q-tunnel tpid 9100
Switch_1(config-if)#exit
```

- 3) Add port 1/0/2 to VLAN 1050 as untagged port, and add it to VLAN 100 and VLAN 200 as tagged port. Modify PVID of the port as 1050. Set the port as the UNI port.

```
Switch_1(config)#interface gigabitEthernet 1/0/2
Switch_1(config-if)#switchport general allowed vlan 1050 untagged
Switch_1(config-if)#switchport general allowed vlan 100,200 tagged
Switch_1(config-if)#switchport pvid 1050
Switch_1(config-if)#switchport dot1q-tunnel mode uni
Switch_1(config-if)#exit
```

- 4) Enable VLAN VPN globally

```
Switch_1(config)#dot1q-tunnel
Switch_1(config)#end
Switch_1#copy running-config startup-config
```

■ Configuring Switch 3

- 1) Create VLAN 100 and VLAN 200.

```
Switch_3#configure
Switch_3(config)#vlan 100
```

```
Switch_3(config-vlan)#name C_VLAN100
```

```
Switch_3(config-vlan)#exit
```

```
Switch_3(config)#vlan 200
```

```
Switch_3(config-vlan)#name C_VLAN200
```

```
Switch_3(config-vlan)#exit
```

- 2) Add port 1/0/1 to VLAN 100 and port 1/0/2 to VLAN 200 as untagged ports; add port 1/0/3 to VLAN 100 and VLAN 200 as tagged ports. Configure the PVID as 100 for port 1/0/1 and 200 for port 1/0/2.

```
Switch_3(config)#interface gigabitEthernet 1/0/1
```

```
Switch_3(config-if)#switchport general allowed vlan 100 untagged
```

```
Switch_3(config-if)#switchport pvid 100
```

```
Switch_3(config-if)#exit
```

```
Switch_3(config)#interface gigabitEthernet 1/0/2
```

```
Switch_3(config-if)#switchport general allowed vlan 200 untagged
```

```
Switch_3(config-if)#switchport pvid 200
```

```
Switch_3(config-if)#exit
```

```
Switch_3(config)#interface gigabitEthernet 1/0/3
```

```
Switch_3(config-if)#switchport general allowed vlan 100,200 tagged
```

```
Switch_3(config-if)#end
```

```
Switch_3#copy running-config startup-config
```

Verify the VLAN VPN Configurations on Switch 1

Verify the configurations of global VLAN VPN:

```
Switch_3#show dot1q-tunnel
```

```
VLAN VPN Mode: Enabled
```

```
Mapping Mode: Disabled
```

Verify the configurations of VPN up-link port and VPN port:

```
Switch_3#show dot1q-tunnel interface
```

Port	Type	Tpid	Use Inner Priority	LAG
-----	-----	-----	-----	---
Gi1/0/1	NNI	0x9100	Disable	N/A

```

Gi1/0/2   UNI   0x8100   Enable   N/A
Gi1/0/3   NONE  0x8100   Disable  N/A
Gi1/0/4   NONE  0x8100   Disable  N/A
...

```

Verify the port configuration:

```
Switch_3#show interface switchport gigabitEthernet 1/0/1
```

Port Gi1/0/1:

PVID: 1050

Acceptable frame type: All

Ingress Checking: Enable

Member in LAG: N/A

Link Type: General

Member in VLAN:

Vlan	Name	Egress-rule
----	-----	-----
1	System-VLAN	Untagged
1050	SP_VLAN	Tagged

```
Switch_3#show interface switchport gigabitEthernet 1/0/2
```

Port Gi1/0/2:

PVID: 1050

Acceptable frame type: All

Ingress Checking: Enable

Member in LAG: N/A

Link Type: General

Member in VLAN:

Vlan	Name	Egress-rule
----	-----	-----
1	System-VLAN	Untagged
100	C_VLAN100	Tagged

200	C_VLAN200	Tagged
1050	SP_VLAN	Untagged

4.2 Example for Flexible VLAN VPN

4.2.1 Network Requirements

A company has two stations, and the computers belong to VLAN 100 and VLAN 200 respectively. The ISP VLAN is VLAN 1050 and VLAN 1060, and the TPID adopted by the ISP network is 0x9100.

The two stations need to communicate with each other through the ISP network. And it is required that the traffic from VLAN 100 should be transmitted in VLAN 1050, while the traffic from VLAN 200 should be transmitted in VLAN 1060.

Figure 4-10 Network Topology

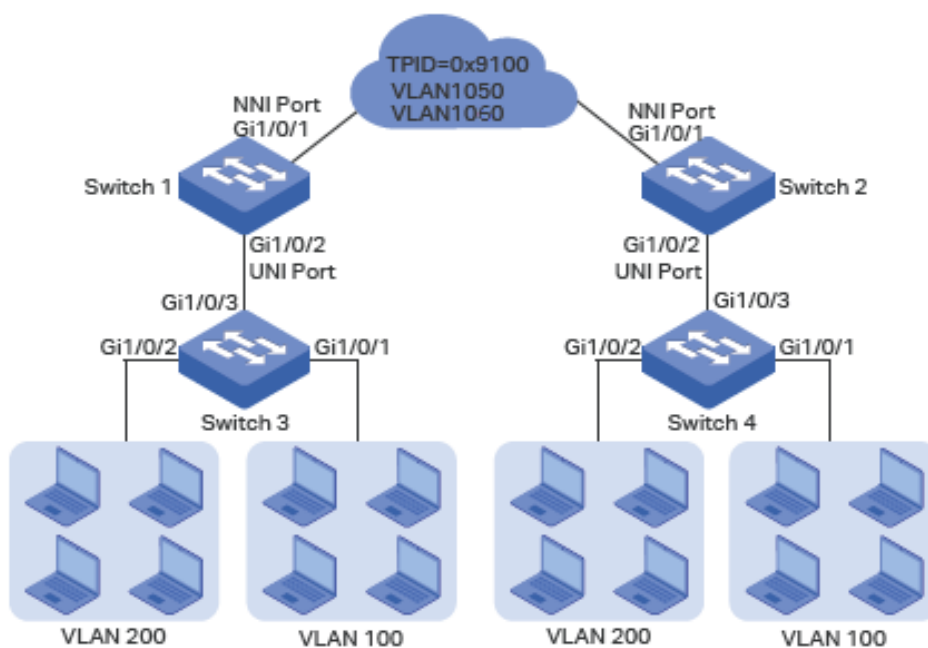

4.2.2 Configuration Scheme

To meet the requirement that all the traffic from VLAN 100 and VLAN 200 need to be transmitted through different ISP VLANs, users can configure flexible VLAN VPN on Switch 1 and Switch 2 to map VLAN 100 to VLAN 1050 and VLAN 200 to VLAN 1060, so packets from VLAN 100 and VLAN 200 will be transmitted through VLAN 1050 and VLAN 1060 respectively.

Here we only introduce the configuration scheme on Switch 1 and Switch 3, for the configurations on Switch 2 are the same as that on Switch 1, and the configurations on Switch 4 are the same as that on Switch 3.

- 1) Configure 802.1Q VLAN on Switch 1. The parameters are shown below:

	VLAN 100	VLAN 200	VLAN 1050	VLAN 1060
Port 1/0/1	-	-	Tagged	Tagged
Port 1/0/2	Tagged	Tagged	Untagged	Untagged

- 2) Configure 802.1Q VLAN on Switch 3. The parameters are shown below:

	VLAN 100	VLAN 200	PVID
Port 1/0/1	Untagged	-	100
Port 1/0/2	-	Untagged	200
Port 1/0/3	Tagged	Tagged	Keep the default value

- 3) Configure VLAN VPN on Switch 1. Set port 1/0/1 as NNI port and port 1/0/2 as UNI port; configure the TPID as 0x9100; map VLAN 100 to VLAN 1050 and VLAN 200 to VLAN 1060.

Demonstrated with T2600G-28TS, this chapter provides configuration procedures in two ways: using the GUI and using the CLI.

4.2.3 Using the GUI

■ Configuring Switch 1:

- 1) Go to **L2 FEATURES > VLAN > 802.1Q VLAN** to create VLAN 100, VLAN 200, VLAN 1050 and VLAN 1060. Configure the egress rule of port 1/0/2 in VLAN 100 and VLAN 200 as Tagged, and Untagged in VLAN 1050 and VLAN 1060; Configure the egress rule of port 1/0/1 in VLAN 1050 and VLAN 1060 as Tagged.

Figure 4-11 Create VLAN 100

VLAN Config

VLAN ID: (2-4094, format: 2,4-5,8)

VLAN Name: (1-16 characters)

Untagged Ports

Port: (Format: 1/0/1, input or choose below)

UNIT1
LAGS

1	3	5	7	9	11	13	15	17	19	21	23	25	27	29	31	33	35	37	39
2	4	6	8	10	12	14	16	18	20	22	24	26	28	30	32	34	36	38	40
41	43	45	47	49	51	53													
42	44	46	48	50	52	54													

Select All

Selected
 Unselected
 Not Available

Tagged Ports

Port: (Format: 1/0/1, input or choose below)

UNIT1
LAGS

1	3	5	7	9	11	13	15	17	19	21	23	25	27	29	31	33	35	37	39
2	4	6	8	10	12	14	16	18	20	22	24	26	28	30	32	34	36	38	40
41	43	45	47	49	51	53													
42	44	46	48	50	52	54													

Cancel
Create

Figure 4-12 Create VLAN 200

VLAN Config

VLAN ID: (2-4094, format: 2,4-5,8)

VLAN Name: (1-16 characters)



Untagged Ports

Port:

UNIT1 LAGS

1	3	5	7	9	11	13	15	17	19	21	23	25	27	29	31	33	35	37	39
2	4	6	8	10	12	14	16	18	20	22	24	26	28	30	32	34	36	38	40
41	43	45	47	49	51	53													
42	44	46	48	50	52	54													

Select All

 Selected  Unselected  Not Available

Tagged Ports

Port: (Format: 1/0/1, input or choose below)

UNIT1 LAGS

1	3	5	7	9	11	13	15	17	19	21	23	25	27	29	31	33	35	37	39
2	4	6	8	10	12	14	16	18	20	22	24	26	28	30	32	34	36	38	40
41	43	45	47	49	51	53													
42	44	46	48	50	52	54													

Figure 4-13 Create VLAN 1050

VLAN Config

VLAN ID: (2-4094, format: 2,4-5,8)

VLAN Name: (1-16 characters)



Untagged Ports

Port: (Format: 1/0/1, input or choose below)

UNIT1 **LAGS**

1	3	5	7	9	11	13	15	17	19	21	23	25	27	29	31	33	35	37	39
2	4	6	8	10	12	14	16	18	20	22	24	26	28	30	32	34	36	38	40
41	43	45	47	49	51	53													
42	44	46	48	50	52	54													

Select All

 Selected  Unselected  Not Available

Tagged Ports

Port: (Format: 1/0/1, input or choose below)

1	3	5	7	9	11	13	15	17	19	21	23	25	27	29	31	33	35	37	39
----------	---	---	---	---	----	----	----	----	----	----	----	----	----	----	----	----	----	----	----

Figure 4-14 Create VLAN 1060

VLAN Config

VLAN ID: (2-4094, format: 2,4-5,8)

VLAN Name: (1-16 characters)

Untagged Ports

Port: (Format: 1/0/1, input or choose below)

UNIT1 LAGS

Select All

Tagged Ports

Port: (Format: 1/0/1, input or choose below)

UNIT1 LAGS

- 2) Go to **L2 FEATURES > VLAN > VLAN VPN > VPN Config**, enable VLAN VPN globally; set port 1/0/1 as NNI port and port /1/0/2 as UNI port. Specify the TPID of port 1/0/1 as 9100.

Figure 4-15 Enabling VLAN VPN Globally and Configuring the Ports

Global Config

VLAN VPN: Enable

Port Config

UNIT1	LAGS	Port	Port Role	TPID	Missdrop	Use Inner Priority
<input type="checkbox"/>		1/0/1	NNI	9100	Disabled	Disabled
<input type="checkbox"/>		1/0/2	UNI	8100	Disabled	Disabled
<input type="checkbox"/>		1/0/3	--	8100	Disabled	Disabled

- 3) Go to **L2 FEATURES > VLAN > VLAN VPN > VLAN Mapping**, enable VLAN Mapping globally. Then configure VLAN mapping for the UNI port 1/0/2.

Figure 4-16 Mapping VLAN 100 to VLAN 1050

VLAN Mapping Config

Port: Choose (Format: 1/0/1)

UNIT1 **LAGS**

Select All

1 3 5 7 9 11 13 15 17 19 21 23 25 27
 2 4 6 8 10 12 14 16 18 20 22 24 26 28

C VLAN: ID Name
 (1-4094)

SP VLAN: ID Name
 (1-4094)

Description: (Optional. 1-16 characters)

Cancel Create

Figure 4-17 Mapping VLAN 200 to VLAN 1060

VLAN Mapping Config

Port: Choose (Format: 1/0/1)

UNIT1 **LAGS**

Select All

1 3 5 7 9 11 13 15 17 19 21 23 25 27
 2 4 6 8 10 12 14 16 18 20 22 24 26 28

C VLAN: ID Name
 (1-4094)

SP VLAN: ID Name
 (1-4094)

Description: (Optional. 1-16 characters)

Cancel Create

4) Click  Save to save the settings.

■ **Configuring Switch 3:**

- 1) Go to **L2 FEATURES > VLAN > 802.1Q VLAN** to create VLAN 100 and VLAN 200. Configure the egress rules of port 1/0/1 in VLAN 100 as Untagged; egress rules of port 1/0/2 in VLAN 200 as Untagged; egress rule of port 1/0/3 in VLAN 100 and VLAN 200 as Tagged.

Figure 4-18 Creating VLAN 100

VLAN Config

VLAN ID: (2-4094, format: 2,4-5,8)

VLAN Name: (1-16 characters)

Untagged Ports

Port: (Format: 1/0/1, input or choose below)

1 3 5 7 9 11 13 15 17 19 21 23 25 27 29 31 33 35 37 39

2 4 6 8 10 12 14 16 18 20 22 24 26 28 30 32 34 36 38 40

Select All

41 43 45 47 49 51 53

42 44 46 48 50 52 54

Selected Unselected Not Available

Tagged Ports

Port: (Format: 1/0/1, input or choose below)

1 3 5 7 9 11 13 15 17 19 21 23 25 27 29 31 33 35 37 39

2 4 6 8 10 12 14 16 18 20 22 24 26 28 30 32 34 36 38 40

41 43 45 47 49 51 53

42 44 46 48 50 52 54

Selected Unselected Not Available

Figure 4-19 Creating VLAN 200

VLAN Config

VLAN ID: (2-4094, format: 2,4-5,8)

VLAN Name: (1-16 characters)

Untagged Ports

Port: (Format: 1/0/1, input or choose below)

1 3 5 7 9 11 13 15 17 19 21 23 25 27 29 31 33 35 37 39

2 4 6 8 10 12 14 16 18 20 22 24 26 28 30 32 34 36 38 40

Select All

41 43 45 47 49 51 53

42 44 46 48 50 52 54

Selected Unselected Not Available

Tagged Ports

Port: (Format: 1/0/1, input or choose below)

1 3 5 7 9 11 13 15 17 19 21 23 25 27 29 31 33 35 37 39

2 4 6 8 10 12 14 16 18 20 22 24 26 28 30 32 34 36 38 40

41 43 45 47 49 51 53

42 44 46 48 50 52 54

Selected Unselected Not Available

- 2) Go to **L2 FEATURES > VLAN > Port Config** to set the PVID as 100 for port 1/0/1 and 200 for port 1/0/2.

Figure 4-20 Configuring PVID

Port Config						
UNIT1		LAGS				
<input type="checkbox"/>	Port	PVID	Ingress Checking	Acceptable Frame Types	LAG	Details
<input type="checkbox"/>	1/0/1	100	Enabled	Admit All	---	Details
<input type="checkbox"/>	1/0/2	200	Enabled	Admit All	---	Details
<input type="checkbox"/>	1/0/3	1	Enabled	Admit All	---	Details

- 3) Click  Save to save the settings.

4.2.4 Using the CLI

■ Configuring Switch 1

- 1) Create VLAN 100, VLAN 200, VLAN 1050 and VLAN 1060.

```
Switch_1#configure
```

```
Switch_1(config)#vlan 1050
```

```
Switch_1(config-vlan)#name SP_VLAN1050
```

```
Switch_1(config-vlan)#exit
```

```
Switch_1(config)#vlan 1060
```

```
Switch_1(config-vlan)#name SP_VLAN1060
```

```
Switch_1(config-vlan)#exit
```

```
Switch_1(config)#vlan 100
```

```
Switch_1(config-vlan)#name C_VLAN100
```

```
Switch_1(config-vlan)#exit
```

```
Switch_1(config)#vlan 200
```

```
Switch_1(config-vlan)#name C_VLAN200
```

```
Switch_1(config-vlan)#exit
```

- 2) Add port 1/0/1 to VLAN 1050 and VLAN 1060 as tagged port, set the port as NNI port and specify the TPID as 9100.

```
Switch_1(config)#interface gigabitEthernet 1/0/1
```

```
Switch_1(config-if)#switchport general allowed vlan 1050,1060 tagged
```

```
Switch_1(config-if)#switchport dot1q-tunnel mode nni
```

```
Switch_1(config-if)#switchport dot1q-tunnel tpid 9100
```

```
Switch_1(config-if)#exit
```

- 3) Add port 1/0/2 to VLAN 1050 and VLAN 1060 as untagged port, and add it to VLAN 100 and VLAN 200 as tagged port. Set the port as the UNI port.

```
Switch_1(config)#interface gigabitEthernet 1/0/2
```

```
Switch_1(config-if)#switchport general allowed vlan 1050,1060 untagged
```

```
Switch_1(config-if)#switchport general allowed vlan 100,200 tagged
```

```
Switch_1(config-if)#switchport dot1q-tunnel mode uni
```

```
Switch_1(config-if)#exit
```

- 4) Enable VLAN mapping. Map VLAN 100 to VLAN 1050 and VLAN 200 to VLAN 1060 for port 1/0/2.

```
Switch_1(config)#dot1q-tunnel mapping
```

```
Switch_1(config)#interface gigabitEthernet 1/0/2
```

```
Switch_1(config-if)#switchport dot1q-tunnel mapping 100 1050 mapping
```

```
Switch_1(config-if)#switchport dot1q-tunnel mapping 200 1060 mapping
```

```
Switch_1(config-if)#exit
```

- 5) Enable VLAN VPN globally

```
Switch_1(config)#dot1q-tunnel
```

```
Switch_1(config)#end
```

```
Switch_1#copy running-config startup-config
```

■ Configuring Switch 3

- 1) Create VLAN 100 and VLAN 200.

```
Switch_3#configure
```

```
Switch_3(config)#vlan 100
```

```
Switch_3(config-vlan)#name C_VLAN100
```

```
Switch_3(config-vlan)#exit
```

```
Switch_3(config)#vlan 200
```

```
Switch_3(config-vlan)#name C_VLAN200
```

```
Switch_3(config-vlan)#exit
```

- 2) Add port 1/0/1 to VLAN 100 and port 1/0/2 to VLAN 200 as untagged ports; add port 1/0/3 to VLAN 100 and VLAN 200 as tagged ports. Configure the PVID as 100 for port 1/0/1 and 200 for port 1/0/2.

```
Switch_3(config)#interface gigabitEthernet 1/0/1
Switch_3(config-if)#switchport general allowed vlan 100 untagged
Switch_3(config-if)#switchport pvid 100
Switch_3(config-if)#exit
Switch_3(config)#interface gigabitEthernet 1/0/2
Switch_3(config-if)#switchport general allowed vlan 200 untagged
Switch_3(config-if)#switchport pvid 200
Switch_3(config-if)#exit
Switch_3(config)#interface gigabitEthernet 1/0/3
Switch_3(config-if)#switchport general allowed vlan 100,200 tagged
Switch_3(config-if)#end
Switch_3#copy running-config startup-config
```

5 Appendix: Default Parameters

Default settings of VLAN VPN are listed in the following table.

Table 5-1 Default Settings of VLAN VPN

Parameter	Default Setting
Global VLAN VPN	Disabled
Port Role	None
Global TPID	0x8100
Missdrop	Disabled
Use Inner Priority	Disabled
VLAN Mapping	Disabled

Part 12

Configuring GVRP

CHAPTERS

1. Overview
2. GVRP Configuration
3. Configuration Example
4. Appendix: Default Parameters

1 Overview

GVRP (GARP VLAN Registration Protocol) is a GARP (Generic Attribute Registration Protocol) application that allows registration and deregistration of VLAN attribute values and dynamic VLAN creation.

Without GVRP operating, configuring the same VLAN on a network would require manual configuration on each device. As shown in Figure 1-1, Switch A, B and C are connected through trunk ports. VLAN 10 is configured on Switch A, and VLAN 1 is configured on Switch B and Switch C. Switch C can receive messages sent from Switch A in VLAN 10 only when the network administrator has manually created VLAN 10 on Switch B and Switch C.

Figure 1-1 VLAN Topology

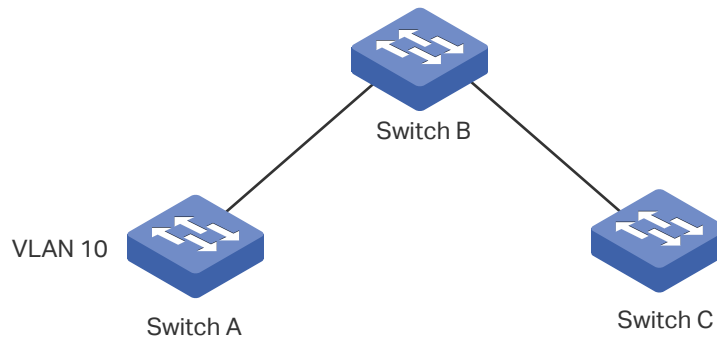

The configuration may seem easy in this situation. However, for a larger or more complex network, such manual configuration would be time-consuming and fallible. GVRP can be used to implement dynamic VLAN configuration. With GVRP, the switch can exchange VLAN configuration information with the adjacent GVRP switches and dynamically create and manage the VLANs. This reduces VLAN configuration workload and ensures correct VLAN configuration.

Figure 1-2 GVRP Topology

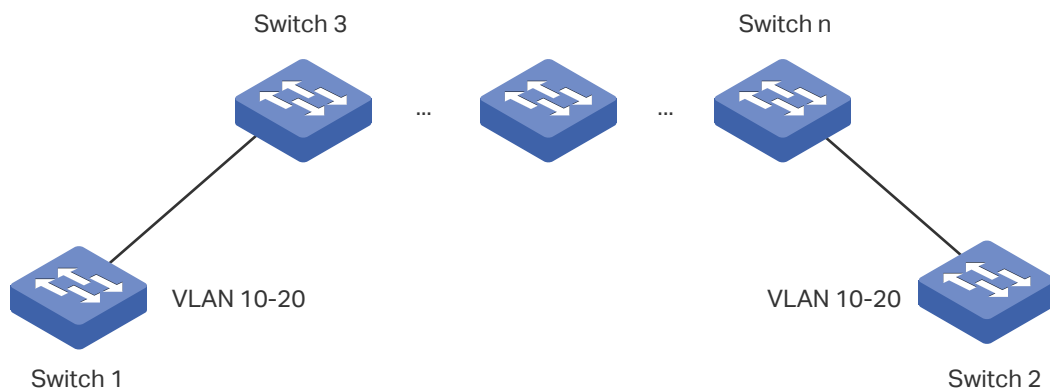

2 GVRP Configuration

To complete GVRP configuration, follow these steps:

- 1) Create a VLAN.
- 2) Enable GVRP globally.
- 3) Enable GVRP on each port and configure the corresponding parameters.

Configuration Guidelines

To dynamically create a VLAN on all ports in a network link, you must configure the same static VLAN on both ends of the link.

We call manually configured 802.1Q VLAN as static VLAN and VLAN created through GVRP as dynamic VLAN. Ports in a static VLAN can initiate the sending of GVRP registration message to other ports. And a port registers VLANs only when it receives GVRP messages. As the messages can only be sent from one GVRP participant to another, two-way registration is required to configure a VLAN on all ports in a link. To implement two-way registration, you need to manually configure the same static VLAN on both ends of the link.

As shown in the figure below, VLAN registration from Switch A to Switch C adds Port 2 to VLAN 2. And VLAN registration from Switch C to Switch A adds Port 3 to VLAN 2.

Figure 2-1

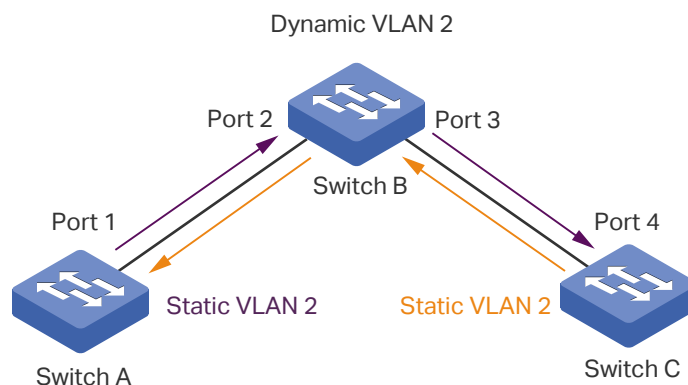

Similarly, if you want to delete a VLAN from the link, two-way deregistration is required. You need to manually delete the static VLAN on both ends of the link.

2.1 Using the GUI

Choose the menu **L2 FEATURES > VLAN > GVRP > GVRP** to load the following page.

Figure 2-1 GVRP Config

GVRP

GVRP: Enable Apply

Port Config

UNIT1

LAGS

<input type="checkbox"/>	Port	Status	Registration Mode	LeaveAll Timer (1000-30000 centiseconds)	Join Timer (20-1000 centiseconds)	Leave Timer (60-3000 centiseconds)	LAG
<input type="checkbox"/>	1/0/1	Disabled	Normal	1000	20	60	---
<input type="checkbox"/>	1/0/2	Disabled	Normal	1000	20	60	---
<input type="checkbox"/>	1/0/3	Disabled	Normal	1000	20	60	---
<input type="checkbox"/>	1/0/4	Disabled	Normal	1000	20	60	---
<input type="checkbox"/>	1/0/5	Disabled	Normal	1000	20	60	---
<input type="checkbox"/>	1/0/6	Disabled	Normal	1000	20	60	---
<input type="checkbox"/>	1/0/7	Disabled	Normal	1000	20	60	---
<input type="checkbox"/>	1/0/8	Disabled	Normal	1000	20	60	---
<input type="checkbox"/>	1/0/9	Disabled	Normal	1000	20	60	---
<input type="checkbox"/>	1/0/10	Disabled	Normal	1000	20	60	---

Total: 54

Follow these steps to configure GVRP:

- 1) In the **GVRP** section, enable GVRP globally, then click **Apply**.
- 2) In the **Port Config** section, select one or more ports, set the status as Enable and configure the related parameters according to your needs.

Port	Select the desired port for GVRP configuration. It is multi-optional.
Status	Enable or disable GVRP on the port. By default, it is disabled.
Registration Mode	<p>Select the GVRP registration mode for the port.</p> <p>Normal: In this mode, the port can dynamically register and deregister VLANs, and transmit both dynamic and static VLAN registration information.</p> <p>Fixed: In this mode, the port is unable to dynamically register and deregister VLANs, and can transmit only the information of VLAN 1.</p> <p>Forbidden: In this mode, the port is unable to dynamically register and deregister VLANs, and can transmit only the information of VLAN 1.</p>

LeaveAll Timer (centisecond)	When a GVRP participant is enabled, the LeaveAll timer will be started. When the LeaveAll timer expires, the GVRP participant will send LeaveAll messages to request other GVRP participants to re-register all its attributes. After that, the participant restarts the LeaveAll timer.
	The timer ranges from 1000 to 30000 centiseconds and should be an integral multiple of 5. The default value is 1000 centiseconds.
Join Timer (centisecond)	Join timer controls the sending of Join messages. A GVRP participant starts the Join timer after sending the first Join message. If the participant does not receive a response before the Join timer expires, it will send the second Join message to ensure that the Join message can be sent to other participants.
	The timer ranges from 20 to 1000 centiseconds and should be an integral multiple of 5. The default value is 20 centiseconds.
Leave Timer (centisecond)	The Leave timer controls attribute deregistration. A participant will send a Leave message if it wants other participants to deregister some of its attributes. The participant receiving the message starts the Leave timer. If the participant does not receive any Join message of the corresponding attribute before the Leave timer expires, the participant deregisters the attribute.
	The timer ranges from 60 to 3000 centiseconds and should be an integral multiple of 5. The default value is 60 centiseconds.
LAG	Displays the LAG that the port belongs to.

3) Click **Apply**.

Note:

- The member ports of an LAG follow the configurations of the LAG and not their own. The individual configurations of the ports can take effect only after the ports leave the LAG.
- The egress rule of the ports that are dynamically added to the VLAN is tagged.
- The egress rule of the fixed ports should be tagged.
- When setting the timer values, make sure that the values are within the required range. The configuration value for LeaveAll timer should be greater than or equal to ten times the Leave timer value. The value for Leave timer should be greater than or equal to two times the Join timer value.

2.2 Using the CLI

Step 1	configure
	Enter Global Configuration Mode.
Step 2	gvrp
	Enable GVRP globally.

Step 3	<p>interface {fastEthernet port range fastEthernet port-list gigabitEthernet port range gigabitEthernet port-list ten-gigabitEthernet port range ten-gigabitEthernet port-list port-channel port-channel-id range port-channel port-channel-list}</p> <p>Enter interface configuration mode.</p>
Step 4	<p>gvrp</p> <p>Enable GVRP on the port.</p>
Step 5	<p>gvrp registration { normal fixed forbidden }</p> <p>Configure the GVRP registration mode for the port. By default, it is normal.</p> <p>normal: In this mode, the port can dynamically register and deregister VLANs, and transmit both dynamic and static VLAN registration information.</p> <p>fixed: In this mode, the port is unable to dynamically register and deregister VLANs, and can transmit only the static VLAN registration information.</p> <p>forbidden: In this mode, the port is unable to dynamically register and deregister VLANs, and can transmit only information of VLAN 1.</p>
Step 6	<p>gvrp timer { leaveall join leave } value</p> <p>Set the GARP timers according to your needs.</p> <p>leaveall: When a GARP participant is enabled, the LeaveAll timer will be started. When the LeaveAll timer expires, the GARP participant will send LeaveAll messages to request other GARP participants to re-register all its attributes. After that, the participant restarts the LeaveAll timer.</p> <p>join: Join timer controls the sending of Join messages. A GVRP participant starts the Join timer after sending the first Join message. If the participant does not receive any response, it will send the second Join message when the Join timer expires to ensure that the Join message can be sent to other participants.</p> <p>leave: The Leave timer controls attribute deregistration. A participant will send a Leave message if it wants other participants to deregister some of its attributes. The participant receiving the message starts the Leave timer. If the participant does not receive any Join message of the corresponding attribute before the Leave timer expires, the participant deregisters the attribute.</p> <p>value: Set a value for the timer. It should be an integral multiple of 5. For LeaveAll timer, the valid values are from 1000 to 30000 centiseconds and the default value is 1000 centiseconds. For Join timer, the valid values are from 20 to 1000 centiseconds and the default value is 20 centiseconds. For Leave timer, the valid values are from 60 to 3000 centiseconds and the default value is 60 centiseconds.</p>
Step 7	<p>show gvrp global</p> <p>Verify the global configurations of GVRP.</p>
Step 8	<p>show gvrp interface [fastEthernet port gigabitEthernet port ten-gigabitEthernet port port-channel port-channel-id]</p> <p>Verify the GVRP configuration of the specified port or LAG.</p>

-
- Step 9 **end**
Return to privileged EXEC mode.
-
- Step 10 **copy running-config startup-config**
Save the settings in the configuration file.
-

 **Note:**

- The member ports of an LAG follow the configurations of the LAG and not their own. The individual configurations of the ports can take effect only after the ports leave the LAG.
 - The egress rule of the ports dynamically added to the VLAN is tagged.
 - The egress rule of the fixed port should be tagged.
 - When setting the timer values, make sure that the values are within the required range. The configuration value for LeaveAll timer should be greater than or equal to ten times the Leave timer value. The value for Leave timer should be greater than or equal to two times the Join timer value.
-

The following example shows how to enable GVRP globally and on port 1/0/1, configure the GVRP registration mode as fixed and keep the values of timers as default:

Switch#configure

Switch(config)#gvrp

Switch(config)#interface gigabitEthernet 1/0/1

Switch(config-if)#gvrp

Switch(config-if)#gvrp registration fixed

Switch(config-if)#show gvrp global

GVRP Global Status: Enable

Switch(config-if)# show gvrp interface gigabitEthernet 1/0/1

Port	Status	Reg-Mode	LeaveAll	JoinIn	Leave	LAG
----	-----	-----	-----	-----	-----	---
Gi1/0/1	Enabled	Fixed	1000	20	60	N/A

Switch(config-if)#end

Switch#copy running-config startup-config

3 Configuration Example

3.1 Network Requirements

Department A and Department B of a company are connected using switches. Offices of one department are distributed on different floors. As shown in Figure 3-1, the network topology is complicated. Configuration of the same VLAN on different switches is required so that computers in the same department can communicate with each other.

Figure 3-1 Network Topology

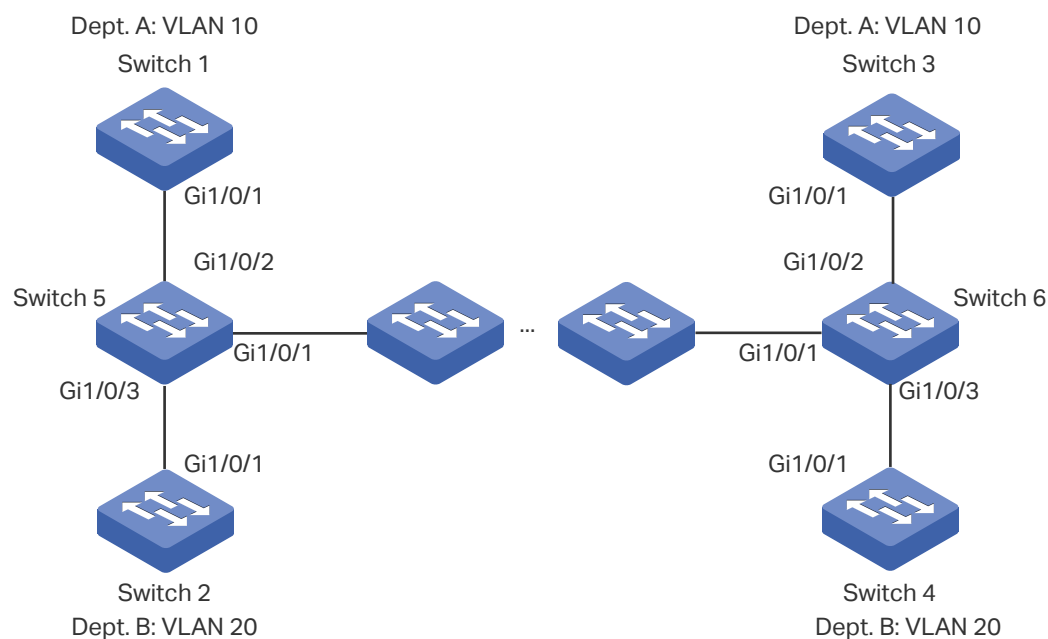

3.2 Configuration Scheme

To reduce manual configuration and maintenance workload, GVRP can be enabled to implement dynamic VLAN registration and update on the switches.

When configuring GVRP, please note the following:

- The two departments are in separate VLANs. To make sure the switches only dynamically create the VLAN of their own department, you need to set the registration mode for ports on Switch 1-4 as Fixed to prevent dynamic registration and deregistration of VLANs and allow the port to transmit only the static VLAN registration information.
- To configure dynamic VLAN creation on the other switches, set the registration mode of the corresponding ports as Normal to allow dynamic registration and deregistration of VLANs.

Demonstrated with SG6654XHP, the following sections provide configuration procedure in two ways: using the GUI and using the CLI.

3.3 Using the GUI

GVRP configurations for Switch 3 are the same as Switch 1, and Switch 4 are the same as Switch 2. Other switches share similar configurations.

The following configuration procedures take Switch 1, Switch 2 and Switch 5 as examples.

■ Configurations for Switch 1

- 1) Choose the menu **L2 FEATURES > VLAN > 802.1Q VLAN > VLAN Config** and click **+ Add** to load the following page. Create VLAN 10 and add tagged port 1/0/1 to it. Click **Create**.

Figure 3-2 Create VLAN 10

The screenshot shows the 'VLAN Config' interface. At the top, there's a teal header with 'VLAN Config'. Below it, there are two input fields: 'VLAN ID' with the value '10' and a note '(2-4094, format: 2,4-5,8)', and 'VLAN Name' with the value 'Department_A' and a note '(1-16 characters)'. Both fields are highlighted with a red box. Below these is the 'Untagged Ports' section, which has a 'Port:' input field and a grid of port icons (1-54) under 'UNIT1' and 'LAGS' headers. A 'Select All' checkbox is present. Below the grid are three icons: a teal one labeled 'Selected', a white one labeled 'Unselected', and a grey one labeled 'Not Available'. The 'Tagged Ports' section has a 'Port:' input field with '1/0/1' and the same port grid. Port 1 is highlighted with a red box. At the bottom right, there are two buttons: 'Cancel' and 'Create', with 'Create' highlighted by a red box.

- 2) Choose the menu **L2 FEATURES > VLAN > GVRP** to load the following page. Enable GVRP globally, then click **Apply**. Select port 1/0/1, set Status as Enable, and set Registration Mode as Fixed. Keep the values of the timers as default. Click **Apply**.

Figure 3-3 GVRP Configuration

GVRP

GVRP: Enable

Port Config

UNIT1		LAGS		LeaveAll Timer (1000-30000 centiseconds)	Join Timer (20- 1000 centiseconds)	Leave Timer (60- 3000 centiseconds)	LAG
<input type="checkbox"/>	Port	Status	Registration Mode				
<input checked="" type="checkbox"/>	1/0/1	Enabled	Fixed	1000	20	60	---
<input type="checkbox"/>	1/0/2	Disabled	Normal	1000	20	60	---
<input type="checkbox"/>	1/0/3	Disabled	Normal	1000	20	60	---
<input type="checkbox"/>	1/0/4	Disabled	Normal	1000	20	60	---
<input type="checkbox"/>	1/0/5	Disabled	Normal	1000	20	60	---
<input type="checkbox"/>	1/0/6	Disabled	Normal	1000	20	60	---
<input type="checkbox"/>	1/0/7	Disabled	Normal	1000	20	60	---
<input type="checkbox"/>	1/0/8	Disabled	Normal	1000	20	60	---
<input type="checkbox"/>	1/0/9	Disabled	Normal	1000	20	60	---
<input type="checkbox"/>	1/0/10	Disabled	Normal	1000	20	60	---

Total: 54 1 entry selected.

3) Click  Save to save the settings.

■ Configurations for Switch 2

1) Choose the menu **L2 FEATURES > VLAN > 802.1Q VLAN > VLAN Config** and click  Add to load the following page. Create VLAN 20 and add tagged port 1/0/1 to it. Click **Create**.

Figure 3-4 Create VLAN 20

VLAN Config

VLAN ID: (2-4094, format: 2,4-5,8)

VLAN Name: (1-16 characters)

Untagged Ports

Port:

UNIT1 LAGS

1	3	5	7	9	11	13	15	17	19	21	23	25	27	29	31	33	35	37	39
2	4	6	8	10	12	14	16	18	20	22	24	26	28	30	32	34	36	38	40
41	43	45	47	49	51	53													
42	44	46	48	50	52	54													

Select All

Selected Unselected Not Available

Tagged Ports

Port: (Format: 1/0/1, input or choose below)

UNIT1 LAGS

1	3	5	7	9	11	13	15	17	19	21	23	25	27	29	31	33	35	37	39
2	4	6	8	10	12	14	16	18	20	22	24	26	28	30	32	34	36	38	40
41	43	45	47	49	51	53													
42	44	46	48	50	52	54													

Cancel Create

- 2) Choose the menu **L2 FEATURES > VLAN > GVRP** to load the following page. Enable GVRP globally, then click **Apply**. Select port 1/0/1, set Status as Enable, and set Registration Mode as Fixed. Keep the values of the timers as default. Click **Apply**.

Figure 3-5 GVRP Configuration

GVRP

GVRP: Enable

Port Config

UNIT1		LAGS					
<input type="checkbox"/>	Port	Status	Registration Mode	LeaveAll Timer (1000-30000 centiseconds)	Join Timer (20-1000 centiseconds)	Leave Timer (60-3000 centiseconds)	LAG
<input checked="" type="checkbox"/>	1/0/1	Enabled	Fixed	1000	20	60	---
<input type="checkbox"/>	1/0/2	Disabled	Normal	1000	20	60	---
<input type="checkbox"/>	1/0/3	Disabled	Normal	1000	20	60	---
<input type="checkbox"/>	1/0/4	Disabled	Normal	1000	20	60	---
<input type="checkbox"/>	1/0/5	Disabled	Normal	1000	20	60	---
<input type="checkbox"/>	1/0/6	Disabled	Normal	1000	20	60	---
<input type="checkbox"/>	1/0/7	Disabled	Normal	1000	20	60	---
<input type="checkbox"/>	1/0/8	Disabled	Normal	1000	20	60	---
<input type="checkbox"/>	1/0/9	Disabled	Normal	1000	20	60	---
<input type="checkbox"/>	1/0/10	Disabled	Normal	1000	20	60	---

Total: 54 1 entry selected.

3) Click  Save to save the settings.

■ Configurations for Switch 5

- 1) Choose the menu **L2 FEATURES > VLAN > GVRP** to load the following page. Enable GVRP globally, then click **Apply**. Select ports 1/0/1-3, set Status as Enable, and keep the Registration Mode and the values of the timers as default. Click **Apply**.

Figure 3-6 GVRP Configuration

GVRP

GVRP: Enable Apply

Port Config

UNIT1 LAGS

<input type="checkbox"/>	Port	Status	Registration Mode	LeaveAll Timer (1000-30000 centiseconds)	Join Timer (20-1000 centiseconds)	Leave Timer (60-3000 centiseconds)	LAG
<input checked="" type="checkbox"/>	1/0/1	Enabled	Normal	1000	20	60	---
<input checked="" type="checkbox"/>	1/0/2	Enabled	Normal	1000	20	60	---
<input checked="" type="checkbox"/>	1/0/3	Enabled	Normal	1000	20	60	---
<input type="checkbox"/>	1/0/4	Disabled	Normal	1000	20	60	---
<input type="checkbox"/>	1/0/5	Disabled	Normal	1000	20	60	---
<input type="checkbox"/>	1/0/6	Disabled	Normal	1000	20	60	---
<input type="checkbox"/>	1/0/7	Disabled	Normal	1000	20	60	---
<input type="checkbox"/>	1/0/8	Disabled	Normal	1000	20	60	---
<input type="checkbox"/>	1/0/9	Disabled	Normal	1000	20	60	---
<input type="checkbox"/>	1/0/10	Disabled	Normal	1000	20	60	---

Total: 54 3 entries selected. Cancel Apply

- 2) Click  Save to save the settings.

3.4 Using the CLI

GVRP configuration for Switch 3 is the same as Switch 1, and Switch 4 is the same as Switch 2. Other switches share similar configurations.

The following configuration procedures take Switch 1, Switch 2 and Switch 5 as examples.

■ Configurations for Switch 1

- 1) Enable GVRP globally.

```
Switch_1#configure
```

```
Switch_1(config)#gvrp
```

- 2) Create VLAN 10.

```
Switch_1(config)#vlan 10
```

```
Switch_1(config-vlan)#name Department_A
```

```
Switch_1(config-vlan)#exit
```

- 3) Add tagged port 1/0/1 to VLAN 10. Enable GVRP on the port and set the registration mode as Fixed.

```
Switch_1(config)#interface gigabitEthernet 1/0/1
Switch_1(config-if)#switchport general allowed vlan 10 tagged
Switch_1(config-if)#gvrp
Switch_1(config-if)#gvrp registration fixed
Switch_1(config-if)#end
Switch_1#copy running-config startup-config
```

■ Configurations for Switch 2

- 1) Enable GVRP globally.

```
Switch_2#configure
Switch_2(config)#gvrp
```

- 2) Create VLAN 20.

```
Switch_2(config)#vlan 20
Switch_2(config-vlan)#name Department_B
Switch_2(config-vlan)#exit
```

- 3) Add tagged port 1/0/1 to VLAN 20. Enable GVRP on the port and set the registration mode as Fixed.

```
Switch_2(config)#interface gigabitEthernet 1/0/1
Switch_2(config-if)#switchport general allowed vlan 20 tagged
Switch_2(config-if)#gvrp
Switch_2(config-if)#gvrp registration fixed
Switch_2(config-if)#end
Switch_2#copy running-config startup-config
```

■ Configurations for Switch 5

- 1) Enable GVRP globally.

```
Switch_5#configure
Switch_5(config)#gvrp
```

- 2) Enable GVRP on ports 1/0/1-3.

```
Switch_5(config)#interface range gigabitEthernet 1/0/1-3
Switch_5(config-if-range)#gvrp
Switch_5(config-if-range)#end
```

```
Switch_5#copy running-config startup-config
```

Verify the Configuration

■ Switch 1

Verify the global GVRP configuration:

```
Switch_1#show gvrp global
```

```
GVRP Global Status
```

```
-----
```

```
Enabled
```

Verify GVRP configuration for port 1/0/1:

```
Switch_1#show gvrp interface
```

Port	Status	Reg-Mode	LeaveAll	JoinIn	Leave	LAG
----	-----	-----	-----	-----	-----	---
Gi1/0/1	Enabled	Fixed	1000	20	60	N/A
Gi1/0/2	Disabled	Normal	1000	20	60	N/A
...						

■ Switch 2

Verify the global GVRP configuration:

```
Switch_2#show gvrp global
```

```
GVRP Global Status
```

```
-----
```

```
Enabled
```

Verify GVRP configuration for port 1/0/1:

```
Switch_2#show gvrp interface
```

Port	Status	Reg-Mode	LeaveAll	JoinIn	Leave	LAG
----	-----	-----	-----	-----	-----	---
Gi1/0/1	Enabled	Fixed	1000	20	60	N/A

```

Gi1/0/2 Disabled Normal 1000 20 60 N/A
...

```

■ Switch 5

Verify global GVRP configuration:

GVRP Global Status

Enabled

Verify GVRP configuration for ports 1/0/1-3:

Switch_5#show gvrp interface

Port	Status	Reg-Mode	LeaveAll	JoinIn	Leave	LAG
----	-----	-----	-----	-----	-----	---
Gi1/0/1	Enabled	Normal	1000	20	60	N/A
Gi1/0/2	Enabled	Normal	1000	20	60	N/A
Gi1/0/3	Enabled	Normal	1000	20	60	N/A
Gi1/0/4	Disabled	Normal	1000	20	60	N/A
...						

4 Appendix: Default Parameters

Default settings of GVRP are listed in the following tables.

Table 4-1 Default Settings of GVRP

Parameter	Default Setting
Global Config	
GVRP	Disabled
Port Config	
Status	Disabled
Registration Mode	Normal
LeaveAll Timer	1000 centiseconds
Join Timer	20 centiseconds
Leave Timer	60 centiseconds

Part 13

Configuring Private VLAN

(Only for Certain Devices)

CHAPTERS

1. Overview
2. Private VLAN Configurations
3. Configuration Example
4. Appendix: Default Parameters

1 Overview

Note:

Private VLAN is only available on certain devices. To check whether your device supports this feature, refer to the actual web interface. If Private VLAN is available, there is **L2 FEATURES > VLAN > Private VLAN** in the menu structure.

Common large networks such as ISP networks generally isolate users by VLANs. However, with the increasing number of users, upper-layer devices have to create large amount of VLANs to manage all the users. According to IEEE 802.1Q protocol, each upper-layer device can create no more than 4094 VLANs, which means upper-layer devices in backbone networks will face shortage of VLANs. By creating primary VLAN and secondary VLAN, private VLAN is an effective solution to this problem.

Based on 802.1Q VLAN, private VLAN pairs a secondary VLAN with a primary VLAN. A primary VLAN can pair with more than one secondary VLANs to compose several private VLANs. In a private VLAN, Layer 2 isolation can be achieved between end users with secondary VLANs, while upper-layer devices only need to recognize primary VLANs, which solves the problem of VLAN shortage. Meanwhile, private VLAN resolves the conflicts triggered when users' need of VLANs is different from what the ISP can provide.

The network models of traditional VLAN and private VLAN are shown in Figure 1-1 and Figure 1-2 respectively. In the network model of traditional VLAN, isolation between users is achieved by creating VLAN2, VLAN3 and VLAN4. In this case, the upper-layer device, Switch A, needs to recognize 3 VLANs including VLAN2, VLAN3 and VLAN4.

Figure 1-1 Topology of Traditional VLAN

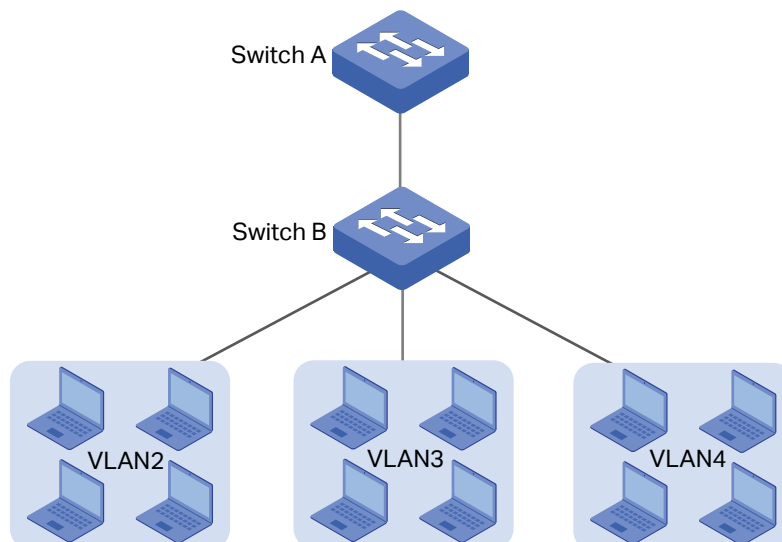

If private VLAN is configured on Switch B, Switch A only needs to recognize primary VLAN, VLAN5; and end users can be isolated by secondary VLANs, VLAN2, VLAN3 and VLAN4, saving VLAN resources for Switch A.

Figure 1-2 Topology of Private VLAN

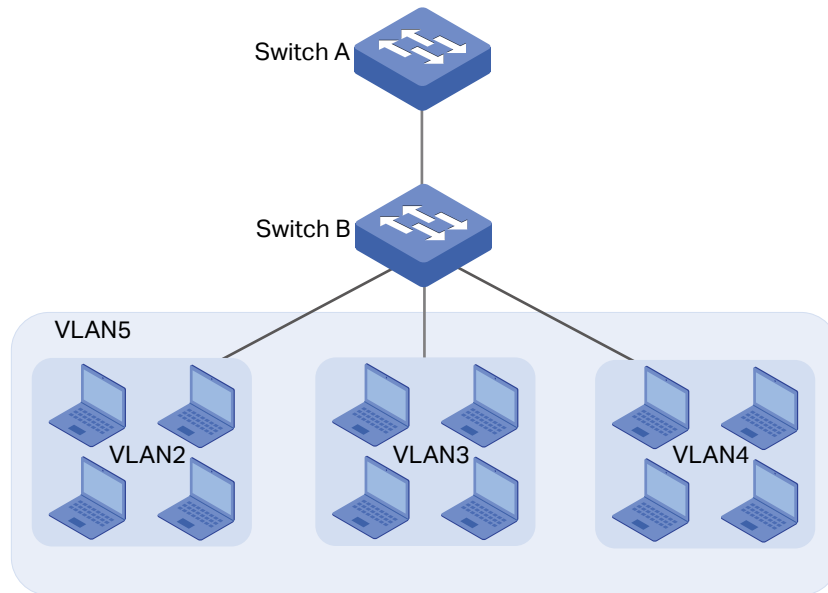

2 Private VLAN Configurations

2.1 Using the GUI

Note:

If you need to create a private VLAN with existing VLANs, delete all member ports of the existing VLANs before creating the private VLAN.

Choose the menu **L2 FEATURES > VLAN > Private VLAN** and click **+ Add** to load the following page.

Figure 2-1 Configuring Private VLAN

1) Enter the IDs of Primary VLAN and Secondary VLAN, and select Secondary VLAN Type.

Primary VLAN	Specify the primary VLAN ID. A primary VLAN can pair with more than one secondary VLAN to compose several private VLANs.
Primary VLAN ID	Displays the primary VLAN ID.

Secondary VLAN	Specify the secondary VLAN ID. A secondary VLAN can pair with only one primary VLAN to create one private VLAN. To avoid long response times from the switch, you are recommended to create less than 10 secondary VLANs at a time.
Secondary VLAN ID	Displays the secondary VLAN ID.
Secondary VLAN Type	Select the Secondary VLAN Type. Community: Select to allow users in the same community VLAN to communicate with each other. Isolated: Select to prevent users in the same isolated VLAN from communicating with each other.

2) Select promiscuous ports and host ports to be added to the private VLAN.

Promiscuous Port	Select promiscuous ports to be added to the VLAN. This type of port connects to the upper-layer devices or other switches. The PVID of this port is its primary VLAN ID.
Host Port	Select host ports to be added to the VLAN. This type of port connects to end users and shields information from upper-layer devices. The PVID of this port is its secondary VLAN ID.
Members	Displays the port members in the private VLAN.

3) Click **Create**.

 **Note:**

When configuring the up-link port, you only need to add the port to one private VLAN and set the port type as Promiscuous. The switch will automatically add the port to private VLANs with the same primary VLAN.

2.2 Using the CLI

2.2.1 Creating Private VLAN

 **Note:**

If you need to create a private VLAN with existing VLANs, delete all member ports of the existing VLANs before creating the private VLAN.

Follow these steps to create Private VLAN:

Step 1	configure Enter global configuration mode.
--------	--

Step 2	vlan <i>vlan-list</i> Specify Primary VLAN ID, and enter VLAN configuration mode. <i>vlan-list</i> : Specify the ID or the ID list of the VLAN(s) for configuration. The ID ranges from 2 to 4094, for example, 2-3,5.
Step 3	private-vlan primary Specify the VLAN to be the primary VLAN.
Step 4	exit Exit VLAN configuration mode.
Step 5	vlan <i>vlan-list</i> Specify Primary VLAN ID, and enter VLAN configuration mode. <i>vlan-list</i> : Specify the ID or the ID list of the VLAN(s) for configuration. The ID ranges from 2 to 4094, for example, 2-3,5.
Step 6	private-vlan { community isolated } Specify the VLAN to be the secondary VLAN, and configure the secondary VLAN type. <i>community</i> : Set the secondary VLAN type as Community. Users in the same isolated VLAN cannot communicate with each other. <i>isolated</i> : Set the secondary VLAN type as Isolated. Users in the same community VLAN can communicate with each other.
Step 7	exit Exit VLAN configuration mode.
Step 8	vlan <i>vlan-id</i> Specify the primary VLAN ID, and enter VLAN configuration mode.
Step 9	private-vlan association <i>vlan-list</i> Specify the ID or the ID list of the secondary VLAN(s) to pair with this primary VLAN. To avoid long response time of the switch, you are recommended to pair less than 10 secondary VLANs with the primary VLAN at a time. <i>vlan-list</i> : Specify the ID or the ID list of the secondary VLAN(s).
Step 10	show vlan private-vlan Verify configurations of private VLAN.
Step 11	end Return to Privileged EXEC Mode.
Step 12	copy running-config startup-config Save the settings in the configuration file.

The following example shows how to create primary VLAN 6 and secondary VLAN 5, set the secondary VLAN type as community, and pair primary VLAN 6 with secondary VLAN 5 as a private VLAN.

```
Switch#configure
```

```
Switch(config)#vlan 6
```

```
Switch(config-vlan)#private-vlan primary
```

```
Switch(config-vlan)#exit
```

```
Switch(config)#vlan 5
```

```
Switch(config-vlan)#private-vlan community
```

```
Switch(config-vlan)#exit
```

```
Switch(config)#vlan 6
```

```
Switch(config-vlan)#private-vlan association 5
```

```
Switch(config-vlan)#exit
```

```
Switch(config)#show vlan private-vlan
```

Primary	Secondary	Type	Ports
6	5	Community	

```
Switch(config)#end
```

```
Switch#copy running-config startup-config
```

2.2.2 Configuring the Up-link Port

Follow these steps to add up-link ports to Private VLAN:

Step 1	<p>configure</p> <p>Enter global configuration mode.</p>
Step 2	<p>interface {fastEthernet port range fastEthernet port-list gigabitEthernet port range gigabitEthernet port-list ten-gigabitEthernet port range ten-gigabitEthernet port-list port-channel port-channel-id range port-channel port-channel-list}</p> <p>Enter interface configuration mode.</p>
Step 3	<p>switchport private-vlan promiscuous</p> <p>Configure the port type as Promiscuous. The port type of up-link port in a primary VLAN must be Promiscuous. This type of port is used to connect upper-layer devices or connect the switch with other switches. The PVID of this port is its primary VLAN ID.</p>

-
- Step 4 **switchport private-vlan mapping** *primary-vlan-id secondary-vlan-id*
Add the specified port(s) to the private VLAN.
primary-vlan-id: Specify the ID of the primary VLAN. The ID ranges from 2 to 4094.
secondary-vlan-id: Specify the ID of the secondary VLAN. The ID ranges from 2 to 4094.
-
- Step 5 **show vlan private-vlan**
Verify configurations of private VLAN.
-
- Step 6 **show vlan private-vlan interface** [**fastEthernet** *port* | **gigabitEthernet** *port* | **ten-gigabitEthernet** *port* | **port-channel** *lag-id*]
Verify private VLAN configurations of ports.
port: Specify the ID of the port to show information.
lag-id: Specify the ID of the LAG to show information.
-
- Step 7 **end**
Return to Privileged EXEC Mode.
-
- Step 8 **copy running-config startup-config**
Save the settings in the configuration file.
-

 **Note:**

When configuring the up-link port, you only need to add the port to one private VLAN and set the port type as Promiscuous. The switch will automatically add the port to private VLANs with the same primary VLAN.

The following example shows how to configure the port type of port 1/0/2 as Promiscuous, and add it to the private VLAN composed of primary VLAN 6 and secondary VLAN 5.

Switch#configure

Switch(config)#interface gigabitEthernet 1/0/2

Switch(config-if)#switchport private-vlan promiscuous

Switch(config-if)#switchport private-vlan mapping 6 5

Switch(config-if)#exit

Switch(config)#show vlan private-vlan

Primary	Secondary	Type	Ports
6	5	Community	Gi1/0/2

Switch(config)#show vlan private-vlan interface gigabitEthernet 1/0/2

Port	type

Gi1/0/2 Promiscuous

Switch(config)#end

Switch#copy running-config startup-config

2.2.3 Configuring the Down-link Port

Follow these steps to add down-link ports to Private VLAN:

Step 1	configure Enter global configuration mode.
Step 2	interface {fastEthernet port range fastEthernet port-list gigabitEthernet port range gigabitEthernet port-list ten-gigabitEthernet port range ten-gigabitEthernet port-list port-channel port-channel-id range port-channel port-channel-list} Enter interface configuration mode.
Step 3	switchport private-vlan host Configure the port type as host. The port type of down-link port in a secondary VLAN must be Host. This type of port is used to connect to end users and shield information from upper-layer devices. The PVID of this port is its secondary VLAN ID.
Step 4	switchport private-vlan host-association primary-vlan-id secondary-vlan-id vlantype Add the specified port(s) to the private VLAN. <i>primary-vlan-id</i> : Specify the ID of the primary VLAN. The ID ranges from 2 to 4094. <i>secondary-vlan-id</i> : Specify the ID of the secondary VLAN. The ID ranges from 2 to 4094. <i>vlantype</i> : Specify the secondary VLAN type, either community or isolated.
Step 5	show vlan private-vlan Verify configurations of private VLAN.
Step 6	show vlan private-vlan interface [fastEthernet port gigabitEthernet port ten-gigabitEthernet port port-channel lag-id] Verify private VLAN configurations of ports. <i>port</i> : Specify the ID of the port to show information. <i>lag-id</i> : Specify the ID of the LAG to show information.
Step 7	end Return to Privileged EXEC Mode.
Step 8	copy running-config startup-config Save the settings in the configuration file.

The following example shows how to configure the port type of port 1/0/3 as Host, and add it to the private VLAN composed of primary VLAN 6 and secondary VLAN 5.

Switch#configure

```
Switch(config)#interface gigabitEthernet 1/0/3
```

```
Switch(config-if)#switchport private-vlan host
```

```
Switch(config-if)#switchport private-vlan host-association 6 5 community
```

```
Switch(config-if)#exit
```

```
Switch(config)#show vlan private-vlan
```

Primary	Secondary	Type	Ports
6	5	Community	Gi1/0/3

```
Switch(config)#show vlan private-vlan interface gigabitEthernet 1/0/3
```

Port	type
Gi1/0/3	Host

```
Switch(config)#end
```

```
Switch#copy running-config startup-config
```

3 Configuration Example

3.1 Network Requirements

Usually, an ISP divides its network into subnets to differentiate different areas by using VLAN. Company A belongs to Area VI which is marked as VLAN 6 by the ISP. It is required that departments in Company A can achieve Layer 2 isolation by using VLAN and users in the same department can communicate with each other.

3.2 Configuration Scheme

You can create primary VLAN and secondary VLAN and pair them into private VLAN. This allows upper-layer switch to recognize only the primary VLAN instead of all the secondary VLANs. Also, Company A can achieve Layer 2 isolation by using secondary VLAN.

Since it is required that users in the same department can communicate with each other, secondary VLAN type should be configured as Community.

3.3 Network Topology

As shown in the following figure, Switch C is the ISP's central switch, and Switch A is in Company A. To meet the requirement, configure private VLAN on Switch A. This chapter provides configuration procedures in two ways: using the GUI and using the CLI.

Demonstrated with SG6654XHP, this chapter provides configuration procedures in two ways: using the GUI and using the CLI.

Figure 3-1 Network Topology

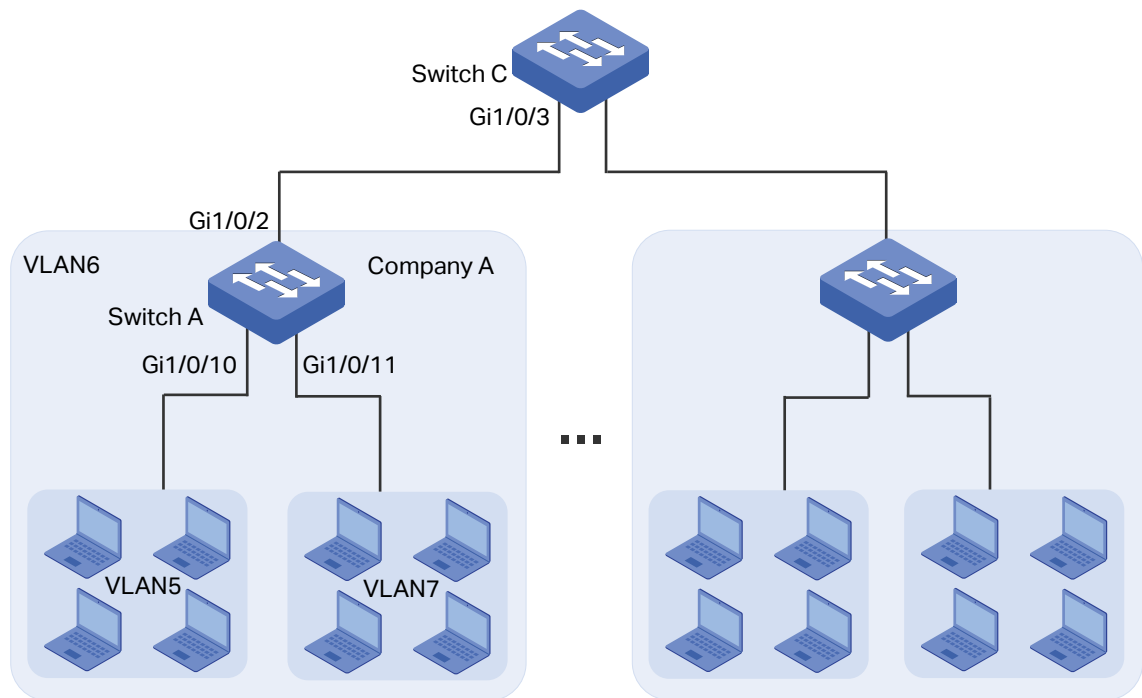

3.4 Using the GUI

■ Configurations for Switch A

- 1) Choose the menu **L2 FEATURES > VLAN > Private VLAN** and click **+ Add** to load the following page. Create primary VLAN 6 and secondary VLAN 5, select Community as the Secondary VLAN Type. Add promiscuous port 1/0/2 and host port 1/0/10 to private VLAN.

Figure 3-2 Creating Primary VLAN 6 and Secondary VLAN 5

The screenshot shows the 'Private VLAN Config' interface. At the top, the 'Primary VLAN' is set to 6 and the 'Secondary VLAN' is set to 5. The 'Secondary VLAN Type' is set to 'Community'. Under 'Promiscuous Ports', the 'Port' field is set to 1/0/2. Below this, a grid of port icons is shown, with port 2 selected. Under 'Host Ports', the 'Port' field is set to 1/0/10. At the bottom right, there are 'Cancel' and 'Create' buttons.

- 2) Choose the menu **L2 FEATURES > VLAN > Private VLAN** and click **+ Add** to load the following page. Create primary VLAN 6 and secondary VLAN 7, select Community as the Secondary VLAN Type. Add promiscuous port 1/0/2 and host port 1/0/11 to private VLAN.

Figure 3-3 Creating Primary VLAN 6 and Secondary VLAN 7

The screenshot shows the 'Private VLAN Config' interface. At the top, there are input fields for 'Primary VLAN:' (value: 6) and 'Secondary VLAN:' (value: 7), both highlighted with red boxes. Below these are radio buttons for 'Secondary VLAN Type:' with 'Community' selected. Under the 'Promiscuous Ports' section, the 'Port:' field contains '1/0/2'. A grid of port icons is displayed, with port 2 highlighted in blue and a red box around it. A 'Select All' checkbox is present. Below the grid are icons for 'Selected', 'Unselected', and 'Not Available'. The 'Host Ports' section has a 'Port:' field with '1/0/11'. A grid of port icons is shown below, with port 11 highlighted in blue and a red box around it. At the bottom right, there are 'Cancel' and 'Create' buttons, with the 'Create' button highlighted by a red box.

3) Click  Save to save the settings.

■ Configurations for Switch C

1) Choose the menu **L2 FEATURES > VLAN > 802.1Q VLAN > VLAN Config** and click  Add to load the following page. Create VLAN 6 and add untagged port 1/0/3 to VLAN 6. Click **Create**.

Figure 3-4 Creating VLAN 6

VLAN Config

VLAN ID: (2-4094, format: 2,4-5,8)

VLAN Name: (1-16 characters)

Untagged Ports

Port: (Format: 1/0/1, input or choose below)

UNIT1 LAGS

1 3 5 7 9 11 13 15 17 19 21 23 25 27 29 31 33 35 37 39

2 4 6 8 10 12 14 16 18 20 22 24 26 28 30 32 34 36 38 40

41 43 45 47 49 51 53

42 44 46 48 50 52 54

Select All

Selected Unselected Not Available

Tagged Ports

Port: (Format: 1/0/1, input or choose below)

UNIT1 LAGS

1 3 5 7 9 11 13 15 17 19 21 23 25 27 29 31 33 35 37 39

41 43 45 47 49 51 53

42 44 46 48 50 52 54

Cancel Create

- 2) Choose the menu **L2 FEATURES > VLAN > 802.1Q VLAN > Port Config** to load the following page. Set the PVID of port 1/0/3 as 6. Click **Apply**.

Figure 3-5 Specifying the PVID

Port Config

UNIT1 LAGS

<input type="checkbox"/>	Port	PVID	Ingress Checking	Acceptable Frame Types	LAG	Details
<input type="checkbox"/>	1/0/1	1	Enabled	Admit All	---	Details
<input type="checkbox"/>	1/0/2	1	Enabled	Admit All	---	Details
<input checked="" type="checkbox"/>	1/0/3	6	Enabled	Admit All	---	Details
<input type="checkbox"/>	1/0/4	1	Enabled	Admit All	---	Details
<input type="checkbox"/>	1/0/5	1	Enabled	Admit All	---	Details
<input type="checkbox"/>	1/0/6	1	Enabled	Admit All	---	Details
<input type="checkbox"/>	1/0/7	1	Enabled	Admit All	---	Details
<input type="checkbox"/>	1/0/8	1	Enabled	Admit All	---	Details
<input type="checkbox"/>	1/0/9	1	Enabled	Admit All	---	Details
<input type="checkbox"/>	1/0/10	1	Enabled	Admit All	---	Details

Total: 28 1 entry selected.

Cancel Apply

- 3) Click  Save to save the settings.

3.5 Using the CLI

■ Configurations for Switch A

- 1) Enter global configuration mode.

```
Switch_A>enable
```

```
Switch_A#configure
```

- 2) Create primary VLAN 6 and secondary VLAN 5, and pair them into a private VLAN.

```
Switch_A(config)#vlan 6
```

```
Switch_A(config-vlan)#private-vlan primary
```

```
Switch_A(config-vlan)#exit
```

```
Switch_A(config)#vlan 5
```

```
Switch_A(config-vlan)#private-vlan community
```

```
Switch_A(config-vlan)#exit
```

```
Switch_A(config)#vlan 6
```

```
Switch_A(config-vlan)#private-vlan association 5
```

```
Switch_A(config-vlan)#exit
```

- 3) Create secondary VLAN 7, and pair it with primary VLAN 6 into a private VLAN.

```
Switch_A(config)#vlan 7
```

```
Switch_A(config-vlan)#private-vlan community
```

```
Switch_A(config-vlan)#exit
```

```
Switch_A(config)#vlan 6
```

```
Switch_A(config-vlan)#private-vlan association 7
```

```
Switch_A(config-vlan)#exit
```

- 4) Add up-link port to the corresponding private VLAN and configure the port type as Promiscuous.

```
Switch_A(config)#interface gigabitEthernet 1/0/2
```

```
Switch_A(config-if)#switchport private-vlan promiscuous
```

```
Switch_A(config-if)#switchport private-vlan mapping 6 5
```

```
Switch_A(config-if)#exit
```

- 5) Add down-link port to the corresponding private VLAN and configure the port type as Host.

```
Switch_A(config)#interface gigabitEthernet 1/0/10
```

```

Switch_A(config-if)#switchport private-vlan host
Switch_A(config-if)#switchport private-vlan host-association 6 5 community
Switch_A(config-if)#exit
Switch_A(config)#interface gigabitEthernet 1/0/11
Switch_A(config-if)#switchport private-vlan host
Switch_A(config-if)#switchport private-vlan host-association 6 7 community
Switch_A(config-if)#end
Switch_A#copy running-config startup-config

```

■ Configurations for Switch C

- 1) Enter global configuration mode.

```
Switch_C>enable
```

```
Switch_C#configure
```

- 2) Create VLAN 6, add port 1/0/3 to VLAN 6 and set the PVID of port 1/0/3 as 6.

```
Switch_C(config)#vlan 6
```

```
Switch_C(config-vlan)#name vlan6
```

```
Switch_C(config-vlan)#exit
```

```
Switch_C(config)#interface gigabitEthernet 1/0/3
```

```
Switch_C(config-if)#switchport pvid 6
```

```
Switch_C(config-if)#switchport general allowed vlan 6 untagged
```

```
Switch_C(config-if)#end
```

```
Switch_C#copy running-config startup-config
```

Verify the Configurations

■ Switch A

Verify the configuration of private VLAN:

```
Switch_A#show vlan private-vlan
```

Primary	Secondary	Type	Ports
-----	-----	-----	-----
6	5	Community	Gi1/0/2,1/0/10
6	7	Community	Gi1/0/2,1/0/11

Verify the configuration of ports:

```
Switch_A#show vlan private-vlan interface
```

Port	type
-----	-----
Gi1/0/1	Normal
Gi1/0/2	Promiscuous
Gi1/0/3	Normal
Gi1/0/4	Normal
Gi1/0/5	Normal
Gi1/0/6	Normal
Gi1/0/7	Normal
Gi1/0/8	Normal
Gi1/0/9	Normal
Gi1/0/10	Host
Gi1/0/11	Host
Gi1/0/12	Normal
...	

■ Switch C

Verify the configuration of 802.1Q VLAN:

```
Switch_C#show vlan
```

VLAN	Name	Status	Ports
1	System-VLAN	active	Gi1/0/1, Gi1/0/2, Gi1/0/3, Gi1/0/4, Gi1/0/5, Gi1/0/6, Gi1/0/7, Gi1/0/8, Gi1/0/9, Gi1/0/10, Gi1/0/11, Gi1/0/12, Gi1/0/13, Gi1/0/14, Gi1/0/15, Gi1/0/16, Gi1/0/17, Gi1/0/18, Gi1/0/19, Gi1/0/20, Gi1/0/21, Gi1/0/22, Gi1/0/23, Gi1/0/24, Gi1/0/25, Gi1/0/26, Gi1/0/27, Gi1/0/28
6	vlan6	active	Gi1/0/3

Primary	Secondary	Type	Ports
-----	-----	-----	-----

4 Appendix: Default Parameters

Default settings of Private VLAN are listed in the following tables.

Table 4-1 Default Settings of Private VLAN

Parameter	Default Setting
Primary VLAN	None
Secondary VLAN	None
Secondary VLAN Type	Community

Part 14

Configuring Multicast

CHAPTERS

1. Layer 2 Multicast
2. IGMP Snooping Configuration
3. MLD Snooping Configuration
4. MVR Configuration
5. Multicast Filtering Configuration
6. Viewing Multicast Snooping Information
7. Configuration Examples
8. Layer 3 Multicast
9. Appendix: Default Parameters

1 Layer 2 Multicast

1.1 Overview

In a point-to-multipoint network, packets can be sent in three ways: unicast, broadcast and multicast. With unicast, many copies of the same information will be sent to all the receivers, occupying a large bandwidth.

With broadcast, information will be sent to all users in the network no matter they need it or not, wasting network resources and impacting information security.

Multicast, however, solves all the problems caused by unicast and broadcast. With multicast, the source only need to send one piece of information, and all and only the users who need the information will receive copies of the information. In a point-to-multipoint network, multicast technology not only transmits data with high efficiency, but also saves a large bandwidth and reduces network load.

In practical applications, Internet information provider can provide value-added services such as Online Live, IPTV, Distance Education, Telemedicine, Internet Radio and Real-time Video Conferences more conveniently using multicast.

Layer 2 Multicast allows Layer 2 switches to listen for IGMP (Internet Group Management Protocol) packets between IGMP Querier and user hosts to establish multicast forwarding table and to manage and control transmission of packets.

Take IGMP Snooping as an example. When IGMP Snooping is disabled on the Layer 2 device, multicast packets will be broadcast in the Layer 2 network; when IGMP Snooping is enabled on the Layer 2 device, multicast data from a known multicast group will be transmitted to the designated receivers instead of being broadcast in the Layer 2 network.

Layer 3 Multicast features, including PIM (Protocol Independent Multicast), static multicast-routing, and IGMP, are only supported on Layer 3 switches

Demonstrated as below:

Figure 1-1 IGMP Snooping

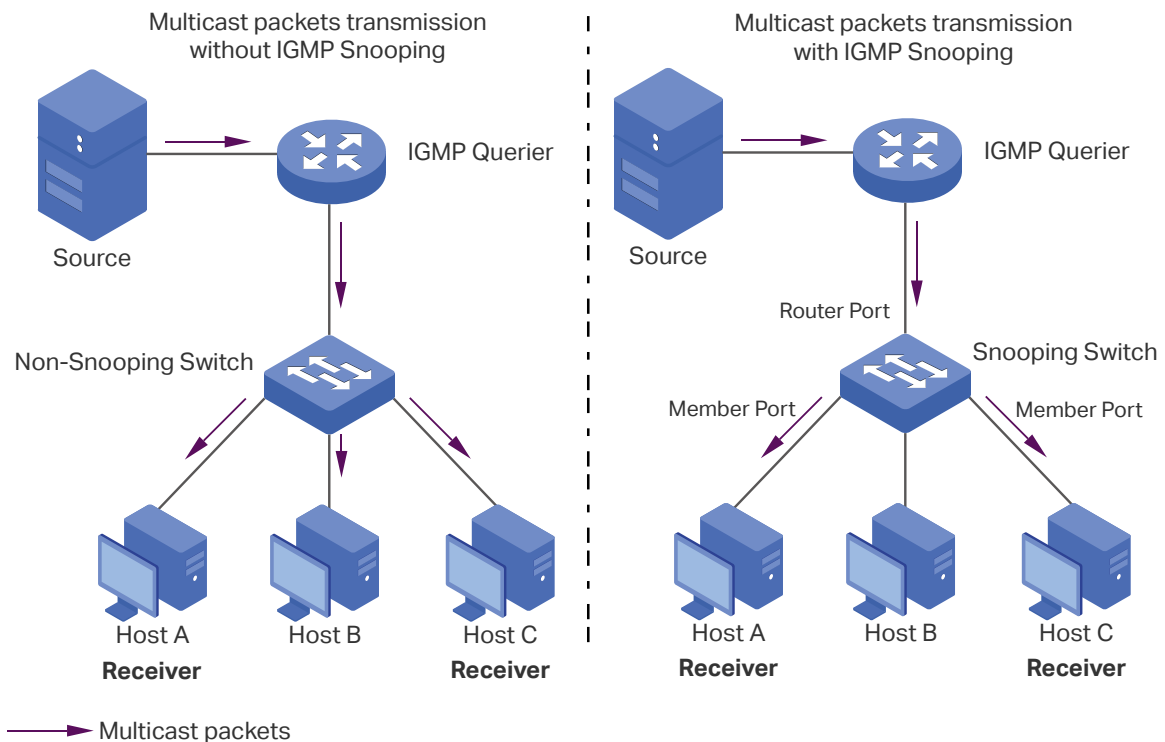

The following basic concepts of IGMP Snooping will be introduced: IGMP querier, snooping switch, router port and member port.

IGMP Querier

An IGMP querier is a multicast router (a router or a Layer 3 switch) that sends query messages to maintain a list of multicast group memberships for each attached network, and a timer for each membership.

Normally only one device acts as querier per physical network. If there are more than one multicast router in the network, a querier election process will be implemented to determine which one acts as the querier.

Snooping Switch

A snooping switch indicates a switch with IGMP Snooping enabled. The switch maintains a multicast forwarding table by snooping on the IGMP transmissions between the host and the querier. With the multicast forwarding table, the switch can forward multicast data only to the ports that are in the corresponding multicast group, so as to constrain the flooding of multicast data in the Layer 2 network.

Router Port

A router port is a port on snooping switch that is connecting to the IGMP querier.

Member Port

A member port is a port on snooping switch that is connecting to the host.

1.2 Supported Features

Layer 2 Multicast protocol for IPv4: IGMP Snooping

On the Layer 2 device, IGMP Snooping transmits data on demand on data link layer by analyzing IGMP packets between the IGMP querier and the users, to build and maintain Layer 2 multicast forwarding table.

Layer 2 Multicast protocol for IPv6: MLD Snooping

On the Layer 2 device, MLD Snooping (Multicast Listener Discovery Snooping) transmits data on demand on data link layer by analyzing MLD packets between the MLD querier and the users, to build and maintain Layer 2 multicast forwarding table.

Multicast VLAN Registration (MVR)

MVR allows a single multicast VLAN to be shared for multicast member ports in different VLANs in IPv4 network. In IGMP Snooping, if member ports are in different VLANs, a copy of the multicast streams is sent to each VLAN that has member ports. While MVR provides a dedicated multicast VLAN to forward multicast traffic over the Layer 2 network, to avoid duplication of multicast streams for clients in different VLANs. Clients can dynamically join or leave the multicast VLAN without interfering with their relationships in other VLANs.

There are two types of MVR modes:

- Compatible Mode

In compatible mode, the MVR switch does not forward report or leave messages from the hosts to the IGMP querier. So the IGMP querier cannot learn the multicast groups membership information from the MVR switch. You have to statically configure the IGMP querier to transmit all the required multicast streams to the MVR switch via the multicast VLAN.

- Dynamic Mode

In dynamic mode, after receiving report or leave messages from the hosts, the MVR switch will forward them to the IGMP querier via the multicast VLAN (with appropriate translation of the VLAN ID). So the IGMP querier can learn the multicast groups membership information through the report and leave messages, and transmit the multicast streams to the MVR switch via the multicast VLAN according to the multicast forwarding table.

Multicast Filtering

Multicast Filtering allows you to control the set of multicast groups to which a host can belong. You can filter multicast joins on a per-port basis by configuring IP multicast profiles (IGMP profiles or MLD profiles) and associating them with individual switch ports.

Protocol Independent Multicast

The Protocol Independent Multicast protocol, abbreviated as PIM, uses unicast routing information to provide multicast forwarding functions in a layer 3 network. PIM works in dense mode.

Static Multicast Routing

Multicast routing creates multicast routing table entries based on existing unicast routing information or multicast static routing. When creating multicast routing table entries, multicast routing protocols use the RPF (Reverse Path Forward) checking mechanism to ensure that multicast data can be forwarded along the correct path. Multicast static route entries are one of the important basis for RPF inspection and are mainly used to change or connect RPF routes.

IP IGMP

IP IGMP is used to enable the IGMP function on the specified interface, and the no command is used to disable the IGMP function on the specified interface.

2 IGMP Snooping Configuration

To complete IGMP Snooping configuration, follow these steps:

- 1) Enable IGMP Snooping globally and configure the global parameters.
- 2) Configure IGMP Snooping for VLANs.
- 3) Configure IGMP Snooping for ports.
- 4) (Optional) Configure hosts to statically join a group.

Note:

IGMP Snooping takes effect only when it is enabled globally, in the corresponding VLAN and port at the same time.

2.1 Using the GUI

2.1.1 Configuring IGMP Snooping Globally

Choose the menu **L2 FEATURES > Multicast > IGMP Snooping > Global Config** to load the following page.

Figure 2-1 Configure IGMP Snooping Globally

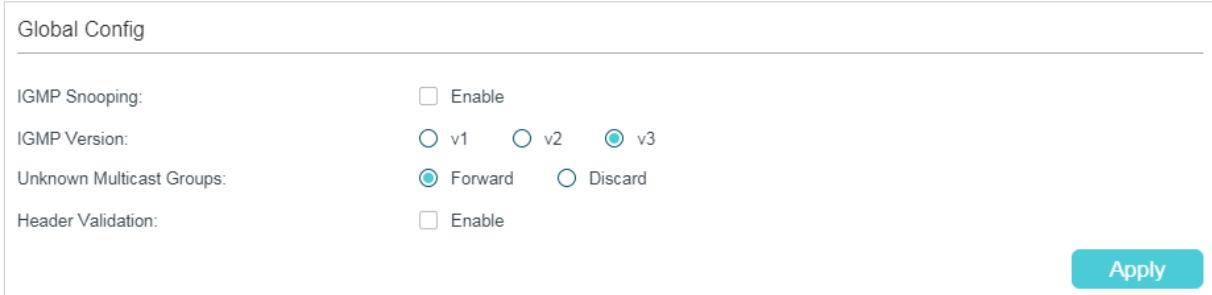

Global Config	
IGMP Snooping:	<input type="checkbox"/> Enable
IGMP Version:	<input type="radio"/> v1 <input type="radio"/> v2 <input checked="" type="radio"/> v3
Unknown Multicast Groups:	<input checked="" type="radio"/> Forward <input type="radio"/> Discard
Header Validation:	<input type="checkbox"/> Enable
Apply	

Follow these steps to configure IGMP Snooping globally:

- 1) In the **Global Config** section, enable IGMP Snooping globally and configure the global parameters.

IGMP Snooping	Enable or disable IGMP snooping globally.
---------------	---

IGMP Version	Specify the IGMP version. The switch supports IGMPv1, IGMPv2 and IGMPv3.
	v1: The switch works as an IGMPv1 Snooping switch. It can only process IGMPv1 messages from the host. Messages of other versions are ignored.
	v2: The switch works as an IGMPv2 Snooping switch. It can process both IGMPv1 and IGMPv2 messages from the host. IGMPv3 messages are ignored.
	v3: The switch works as an IGMPv3 Snooping switch. It can process IGMPv1, IGMPv2 and IGMPv3 messages from the host.
Unknown Multicast Groups	Set the way in which the switch processes packets that are sent to unknown multicast groups as either Forward or Discard. Unknown multicast groups are multicast groups whose destination multicast address is not in the multicast forwarding table of the switch.
	Note: IGMP Snooping and MLD Snooping share the setting of Unknown Multicast Groups..
Header Validation	Enable or disable Header Validation. By default, it is disabled.
	Generally, for IGMP packets, the TTL value should be 1, ToS field should be 0xC0, and Router Alert option should be 0x94040000. The fields to be validated depend on the IGMP version being used. IGMPv1 only checks the TTL field. IGMPv2 checks the TTL field and the Router Alert option. IGMPv3 checks the TTL field, ToS field and Router Alert option. Packets that fail the validation process will be dropped.

2) Click **Apply**.

2.1.2 Configuring IGMP Snooping for VLANs

Before configuring IGMP Snooping for VLANs, set up the VLANs that the router ports and the member ports are in. For details, please refer to [Configuring 802.1Q VLAN](#).

The switch supports configuring IGMP Snooping on a per-VLAN basis. After IGMP Snooping is enabled globally, you also need to enable IGMP Snooping and configure the corresponding parameters for the VLANs that the router ports and the member ports are in.

Choose the menu **L2 FEATURES > Multicast > IGMP Snooping > Global Config**, and click  in your desired VLAN entry in the **IGMP VLAN Config** section to load the following page.

Figure 2-2 Configure IGMP Snooping for VLAN

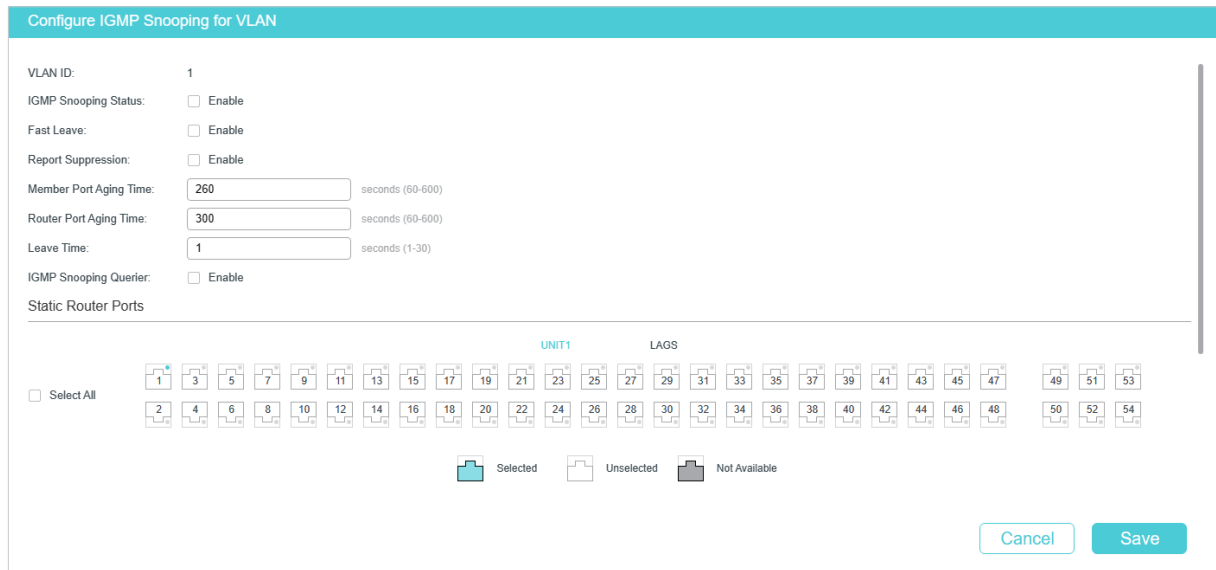

Follow these steps to configure IGMP Snooping for a specific VLAN:

- 1) Enable IGMP Snooping for the VLAN, and configure the corresponding parameters.

VLAN ID	Displays the VLAN ID.
IGMP Snooping Status	Enable or disable IGMP snooping for the VLAN.
Fast Leave	<p>Enable or disable Fast Leave for the VLAN. IGMPv1 does not support Fast Leave.</p> <p>Without Fast Leave, after a receiver sends an IGMP leave message to leave a multicast group, the switch will forward the leave message to the Layer 3 device (the querier).</p> <p>From the point of view of the querier, the port connecting to the switch is a member port of the corresponding multicast group. After receiving the leave message from the switch, the querier will send out a configured number (Last Member Query Count) of group-specific queries on that port with a configured interval (Last Member Query Interval), and wait for IGMP group membership reports. If there are other receivers connecting to the switch, they will response to the queries before the Last Member Query Interval expires. If no reports are received after the response time of the last query expires, the querier will remove the port from the forwarding list of the corresponding multicast group.</p> <p>That is, if there are other receivers connecting to the switch, the one sent leave message have to wait until the port ages out from the switch's forwarding list of the corresponding multicast group (the maximum waiting time is decided by the Member Port Aging Time).</p> <p>With Fast Leave enabled on a VLAN, the switch will remove the (Multicast Group, Port, VLAN) entry from the multicast forwarding table before forwarding the leave message to the querier. This helps to reduce bandwidth waste since the switch no longer sends the corresponding multicast streams to the VLAN of the port as soon as the port receives a leave message from the VLAN.</p>

Report Suppression	Enable or disable Report Suppression for the VLAN. When enabled, the switch will only forward the first IGMP report message for each multicast group to Layer 3 devices and suppress subsequent IGMP report messages for the same multicast group during one query interval. This feature prevents duplicate report messages from being sent to the Layer 3 devices.
Member Port Aging Time	Specify the aging time of the member ports in the VLAN. If the switch does not receive any IGMP membership report messages for a specific multicast group from a dynamic member port, it will no longer consider this port as a member port of this multicast group and delete it from the multicast forwarding table.
Router Port Aging Time	Specify the aging time of the router ports in the VLAN. If the switch does not receive any IGMP general query message from a dynamic router port within the router port aging time, the switch will no longer consider this port as a router port and delete it from the router port list.
Leave Time	<p>Specify the leave time for the VLAN. When the switch receives a leave message from a port to leave a multicast group, it will wait for a leave time before removing the port from the multicast group. During the period, if the switch receives any report messages from the port, the port will not be removed from the multicast group. Exceptions are as follows:</p> <ul style="list-style-type: none"> • If the member port ages out before the Leave Time ends and no report messages are received, the port will be removed from the multicast group once its Member Port Aging Time ends. • The Leave Time mechanism will not take effect when Fast Leave takes effect. <p>A proper leave time value can avoid other hosts connecting to the same port of the switch being mistakenly removed from the multicast group when only some of them want to leave.</p>
IGMP Snooping Querier	<p>Enable or disable the IGMP Snooping Querier for the VLAN.</p> <p>When enabled, the switch acts as an IGMP Snooping Querier for the hosts in this VLAN. A querier periodically sends a general query on the network to solicit membership information, and sends group-specific queries when it receives leave messages from hosts.</p>
Query Interval	With IGMP Snooping Querier enabled, specify the interval between general query messages sent by the querier.
Maximum Response Time	With IGMP Snooping Querier enabled, specify the host's maximum response time to general query messages.
Last Member Query Interval	With IGMP Snooping Querier enabled, when the switch receives an IGMP leave message, it obtains the address of the multicast group that the host wants to leave from the message. Then the switch sends out group-specific queries to this multicast group through the port receiving the leave message. This parameter determines the interval between group-specific queries.
Last Member Query Count	With IGMP Snooping Querier enabled, specify the number of group-specific queries to be sent. If specified count of group-specific queries are sent and no report message is received, the switch will delete the multicast address from the multicast forwarding table.

General Query Source IP	With IGMP Snooping Querier enabled, specify the source IP address of the general query messages sent by the querier. It should be a unicast address.
Dynamic Router Ports	Displays all the dynamic router ports in the multicast VLAN.
Static Router Ports	Select one or more ports to be the static router ports in the VLAN. All multicast data in this VLAN will be forwarded through the static router ports.
Forbidden Router Ports	Select ports to forbid them from being router ports in the VLAN.

2) Click **Save**.

2.1.3 Configuring IGMP Snooping for Ports

Choose the menu **L2 FEATURES > Multicast > IGMP Snooping > Port Config** to load the following page.

Figure 2-3 Configure IGMP Snooping for Ports

Port Config				
UNIT1		LAGS		
<input type="checkbox"/>	Port	IGMP Snooping	Fast Leave	LAG
<input type="checkbox"/>	Gi1/0/1	Enabled	Disabled	---
<input type="checkbox"/>	Gi1/0/2	Enabled	Disabled	---
<input type="checkbox"/>	Gi1/0/3	Enabled	Disabled	---
<input type="checkbox"/>	Gi1/0/4	Enabled	Disabled	---
<input type="checkbox"/>	Gi1/0/5	Enabled	Disabled	---
<input type="checkbox"/>	Gi1/0/6	Enabled	Disabled	---
<input type="checkbox"/>	Gi1/0/7	Enabled	Disabled	---
<input type="checkbox"/>	Gi1/0/8	Enabled	Disabled	---
<input type="checkbox"/>	Gi1/0/9	Enabled	Disabled	---
<input type="checkbox"/>	Gi1/0/10	Enabled	Disabled	---
Total: 54				

Follow these steps to configure IGMP Snooping for ports:

- 1) Enable IGMP Snooping for the port and enable Fast Leave if there is only one receiver connected to the port.

IGMP Snooping	Enable or disable IGMP Snooping on the port.
---------------	--

Fast Leave	<p>Enable or disable Fast Leave for the port. IGMPv1 does not support fast leave.</p> <p>Fast Leave can be enabled on a per-port basis or per-VLAN basis. When enabled, the switch will remove this port from the forwarding list of the corresponding multicast group once the port receives a leave message, without verifying if there are other members of this multicast group. You should only use this function when there is a single receiver present on the port.</p> <p>You should only use Fast Leave for a port when there is a single receiver connected to the port. For more details about Fast Leave, see 2.1.2 Configuring IGMP Snooping for VLANs.</p>
LAG	Displays the LAG that the port belongs to.

2) Click **Apply**.

2.1.4 Configuring Hosts to Statically Join a Group

Hosts or Layer 2 ports normally join multicast groups dynamically, but you can also configure hosts to statically join a group.

Choose the menu **L2 FEATURES > Multicast > IGMP Snooping > Static Group Config** and click **+ Add** to load the following page.

Figure 2-4 Configure Hosts to Statically Join a Group

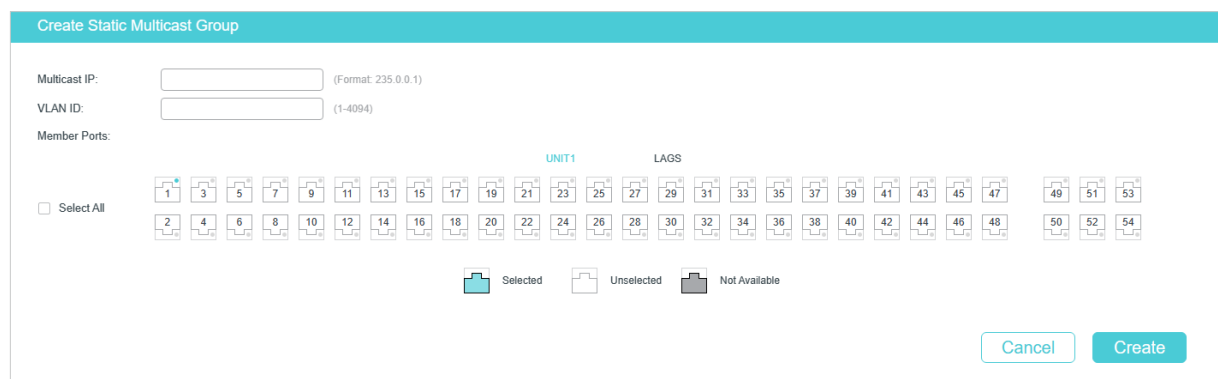

Follow these steps to configure hosts to statically join a group:

1) Specify the multicast IP address, VLAN ID. Select the ports to be the static member ports of the multicast group.

Multicast IP	Specify the multicast group that the static member is in.
VLAN ID	Specify the VLAN that the static member is in.
Member Ports	Specify one or more ports to be the static member ports in the multicast group. Without aging, the static member ports receive all multicast data sent to this multicast group.

2) Click **Create**.

2.1.5 Configuring IGMP Accounting and Authentication Features

Note:

IGMP Accounting and Authentication is only available on certain devices. To check whether your device supports this feature, refer to the actual web interface.

You can enable IGMP accounting and authentication according to your need. IGMP accounting is configured globally, and IGMP authentication can be enabled on a per-port basis.

To use these features, you should also set up a RADIUS server and go to **SECURITY > AAA > RADIUS Config** to configure RADIUS server for the switch.

Choose the menu **L2 FEATURES > Multicast > IGMP Snooping > IGMP Authentication** to load the following page.

Figure 2-5 Configure IGMP Accounting and Authentication

UNIT1	LAGS	ID	Port	IGMP Authentication	LAG
<input type="checkbox"/>		1	Gi1/0/1	Disabled	---
<input type="checkbox"/>		2	Gi1/0/2	Disabled	---
<input type="checkbox"/>		3	Gi1/0/3	Disabled	---
<input type="checkbox"/>		4	Gi1/0/4	Disabled	---
<input type="checkbox"/>		5	Gi1/0/5	Disabled	---
<input type="checkbox"/>		6	Gi1/0/6	Disabled	---
<input type="checkbox"/>		7	Gi1/0/7	Disabled	---
<input type="checkbox"/>		8	Gi1/0/8	Disabled	---
<input type="checkbox"/>		9	Gi1/0/9	Disabled	---
<input type="checkbox"/>		10	Gi1/0/10	Disabled	---

Total: 54

Follow these steps to enable IGMP accounting:

- 1) In the **Global Config** section, enable IGMP Accounting globally.

[Accounting](#) Enable or disable IGMP Accounting globally.

- 2) Click **Apply**.

Follow these steps to configure IGMP Authentication on ports:

- 1) In the **Port Config** section, select the ports and enable IGMP Authentication.

IGMP Authentication	Enable or disable IGMP Authentication for the port.
LAG	Displays the LAG that the port belongs to.

2) Click **Apply**.

2.2 Using the CLI

2.2.1 Configuring IGMP Snooping Globally

Follow these steps to configure IGMP Snooping globally:

Step 1	configure Enter global configuration mode.
Step 2	ip igmp snooping Enable IGMP Snooping Globally.
Step 3	ip igmp snooping version {v1 v2 v3} Configure the IGMP version. v1: The switch works as an IGMPv1 Snooping switch. It can only process IGMPv1 report messages from the host. Report messages of other versions are ignored. v2: The switch works as an IGMPv2 Snooping switch. It can process both IGMPv1 and IGMPv2 report messages from the host. IGMPv3 report messages are ignored. v3: The switch works as an IGMPv3 Snooping switch. It can process IGMPv1, IGMPv2 and IGMPv3 report messages from the host.
Step 4	ip igmp snooping drop-unknown (Optional) Configure the way how the switch processes multicast streams that are sent to unknown multicast groups as Discard. By default, it is Forward. Unknown multicast groups are multicast groups that do not match any of the groups announced in earlier IGMP membership reports, and thus cannot be found in the multicast forwarding table of the switch. Note: IGMP Snooping and MLD Snooping share the setting of Unknown Multicast Groups.
Step 5	ip igmp snooping header-validation (Optional) Enable header validation. Generally, for IGMP packets, the TTL value should be 1, ToS field should be 0xC0, and Router Alert option should be 0x94040000. The fields validated depend on the IGMP version being used. IGMPv1 only checks the TTL field. IGMPv2 checks the TTL field and the Router Alert option. IGMPv3 checks TTL field, ToS field and Router Alert option. Packets that fail the validation process will be dropped.
Step 6	show ip igmp snooping Show the basic IGMP Snooping configuration.

Step 7 **end**
Return to privileged EXEC mode.

Step 8 **copy running-config startup-config**
Save the settings in the configuration file.

The following example shows how to enable IGMP Snooping and header validation globally, and specify the IGMP Snooping version as IGMPv3, the way how the switch processes multicast streams that are sent to unknown multicast groups as discard.

Switch#configure

Switch(config)#ip igmp snooping

Switch(config)#ip igmp snooping version v3

Switch(config)#ipv6 mld snooping

Switch(config)#ip igmp snooping drop-unknown

Switch(config)#ip igmp snooping header-validation

Switch(config)#show ip igmp snooping

IGMP Snooping :Enable

IGMP Version :V3

Unknown Multicast :Discard

Header Validation :Enable

Global Authentication Accounting :Disable

...

Switch(config)#end

Switch#copy running-config startup-config

2.2.2 Configuring IGMP Snooping for VLANs

Before configuring IGMP Snooping for VLANs, set up the VLANs that the router ports and the member ports are in. For details, please refer to [Configuring 802.1Q VLAN](#).

The switch supports configuring IGMP Snooping on a per-VLAN basis. After IGMP Snooping is enabled globally, you also need to enable IGMP Snooping and configure the corresponding parameters for the VLANs that the router ports and the member ports are in.

Follow these steps to configure IGMP Snooping for VLANs:

Step 1 **configure**

Enter global configuration mode.

Step 2 **ip igmp snooping vlan-config vlan-id-list mtime member-time**

Enable IGMP Snooping for the specified VLANs, and specify the member port aging time for the VLANs.

vlan-id-list: Specify the ID or the ID list of the VLAN(s).

member-time: Specify the aging time of the member ports in the specified VLANs. Valid values are from 60 to 600 seconds. By default, it is 260 seconds.

Once the switch receives an IGMP membership report message from a port, the switch adds this port to the member port list of the corresponding multicast group. Member ports that are learned in this way are called dynamic member ports.

If the switch does not receive any IGMP membership report message for a specific multicast group from a dynamic member port, it will no longer consider this port as a member port of this multicast group and delete it from the multicast forwarding table.

Step 3 **ip igmp snooping vlan-config vlan-id-list rtime router-time**

Specify the router port aging time for the VLANs.

vlan-id-list: Specify the ID or the ID list of the VLAN(s).

router-time: Specify the aging time of the router ports in the specified VLANs. Valid values are from 60 to 600 seconds. By default, it is 300 seconds.

Once the switch receives an IGMP general query message from a port, the switch adds this port to the router port list. Router ports that are learned in this way are called dynamic router ports.

If the switch does not receive any IGMP general query message from a dynamic router port within the router port aging time, the switch will no longer consider this port as a router port and delete it from the router port list.

Step 4 **ip igmp snooping vlan-config vlan-id-list ltime leave-time**

Specify the router port aging time for the VLANs.

vlan-id-list: Specify the ID or the ID list of the VLAN(s).

leave-time: Specify the leave time for the VLAN(s). Valid values are from 1 to 30 in seconds, and the default value is 1 second.

When the switch receives a leave message from a port to leave a multicast group, it will wait for a leave time before removing the port from the multicast group. During the period, if the switch receives any report messages from the port, the port will not be removed from the multicast group. Exceptions are as follows:

- If the member port ages out before the Leave Time ends and no report messages are received, the port will be removed from the multicast group once its Member Port Aging Time ends.
- The Leave Time mechanism will not take effect when Fast Leave takes effect.

A proper leave time value can avoid other hosts connecting to the same port of the switch being mistakenly removed from the multicast group when only some of them want to leave.

Step 5 **ip igmp snooping vlan-config *vlan-id-list* report-suppression**

(Optional) Enable the Report Suppression for the VLANs. By default, it is disabled.

When enabled, the switch will only forward the first IGMP report message for each multicast group to the IGMP querier and suppress subsequent IGMP report messages for the same multicast group during one query interval. This feature prevents duplicate report messages from being sent to the IGMP querier.

vlan-id-list: Specify the ID or the ID list of the VLAN(s).

Step 6 **ip igmp snooping vlan-config *vlan-id-list* immediate-leave**

(Optional) Enable the Fast Leave for the VLANs. By default, it is disabled. IGMPv1 does not support fast leave.

Without Fast Leave, after a receiver sends an IGMP leave message to leave a multicast group, the switch will forward the leave message to the Layer 3 device (the querier).

From the point of view of the querier, the port connecting to the switch is a member port of the corresponding multicast group. After receiving the leave message from the switch, the querier will send out a configured number (Last Member Query Count) of group-specific queries on that port with a configured interval (Last Member Query Interval), and wait for IGMP group membership reports. If there are other receivers connecting to the switch, they will response to the queries before the Last Member Query Interval expires. If no reports are received after the response time of the last query expires, the querier will remove the port from the forwarding list of the corresponding multicast group.

That is, if there are other receivers connecting to the switch, the one sent leave message have to wait until the port ages out from the switch's forwarding list of the corresponding multicast group (the maximum waiting time is decided by the Member Port Aging Time).

With Fast Leave enabled on a VLAN, the switch will remove the (Multicast Group, Port, VLAN) entry from the multicast forwarding table before forwarding the leave message to the querier. This helps to reduce bandwidth waste since the switch no longer sends the corresponding multicast streams to the VLAN of the port as soon as the port receives a leave message from the VLAN.

You should only enable Fast Leave for a VLAN when there is a single receiver belongs to this VLAN on every port of the VLAN.

vlan-id-list: Specify the ID or the ID list of the VLAN(s).

Step 7 **ip igmp snooping vlan-config *vlan-id-list* rport interface { fastEthernet *port-list* | gigabitEthernet *port-list* | ten-gigabitEthernet *port-list*| port-channel *lag-list* }**

(Optional) Specify the static router ports for the VLANs. Static router ports do not age.

vlan-id-list: Specify the ID or the ID list of the VLAN(s).

port-list: The number or the list of the Ethernet port that need to be configured as static router ports.

lag-list: The ID or the list of the LAG that need to be configured as static router ports.

Step 8 **ip igmp snooping vlan-config *vlan-id-list* router-ports-forbidden interface { fastEthernet *port-list* | gigabitEthernet *port-list* | ten-gigabitEthernet *port-list* | port-channel *lag-list* }**

(Optional) Specify the ports to forbid them from being router ports in the VLANs.

vlan-id-list: Specify the ID or the ID list of the VLAN(s).

port-list: The number or the list of the Ethernet port that need to be forbidden from being router ports.

lag-list: The ID or the list of the LAG that need to be forbidden from being router ports.

Step 9 **ip igmp snooping vlan-config *vlan-id-list* querier**

(Optional) Enable the IGMP Snooping Querier for the VLAN. By default, it is disabled.

When enabled, the switch acts as an IGMP Snooping Querier for the hosts in this VLAN. A querier periodically sends a general query on the network to solicit membership information, and sends group-specific queries when it receives leave messages from hosts.

vlan-id-list: Specify the ID or the ID list of the VLAN(s).

After enabling IGMP Snooping Querier feature, you need to specify the corresponding parameters including the Last Member Query Count, Last Member Query Interval, Maximum Response Time, Query Interval and General Query Source IP. Use the command below in global configuration mode to configure the parameters:

ip igmp snooping vlan-config *vlan-id-list* querier { max-response-time *response-time* | query-interval *interval* | general-query source-ip *ip-addr* | last-member-query-count *num* | last-member-query-interval *interval* }

vlan-id-list: Specify the ID or the ID list of the VLAN(s).

response-time: Specify the host's maximum response time to general query messages. Valid values are from 1 to 25 seconds, and the default value is 10 seconds.

query-interval interval: Specify the interval between general query messages sent by the switch. Valid values are from 10 to 300 seconds, and the default value is 60 seconds.

ip-addr: Specify the source IP address of the general query messages sent by the switch. It should be a unicast address. By default, it is 0.0.0.0.

num: Specify the number of group-specific queries to be sent. With IGMP Snooping Querier enabled, when the switch receives an IGMP leave message, it obtains the address of the multicast group that the host wants to leave from the message. Then the switch sends out group-specific queries to this multicast group through the port receiving the leave message. If specified count of group-specific queries are sent and no report message is received, the switch will delete the multicast address from the multicast forwarding table. Valid values are from 1 to 5, and the default value is 2.

last-member-query-interval interval: Specify the interval between group-specific queries. Valid values are from 1 to 5 seconds, and the default value is 1 second.

Step 10 **show ip igmp snooping vlan *vlan-id***

Show the basic IGMP Snooping configuration in the specified VLAN.

Step 11 **end**

Return to privileged EXEC mode.

Step 12 **copy running-config startup-config**

Save the settings in the configuration file.

The following example shows how to enable IGMP Snooping for VLAN 1, and configure the member port aging time as 300 seconds, the router port aging time as 320 seconds, and then enable Fast Leave and Report Suppression for the VLAN:

```
Switch#configure
```

```
Switch(config)#ip igmp snooping vlan-config 1 mtime 300
```

```
Switch(config)#ip igmp snooping vlan-config 1 rtime 320
```

```
Switch(config)#ip igmp snooping vlan-config 1 immediate-leave
```

```
Switch(config)#ip igmp snooping vlan-config 1 report-suppression
```

```
Switch(config)#show ip igmp snooping vlan 1
```

```
Vlan Id: 1
```

```
  Vlan IGMP Snooping Status: Enable
```

```
  Fast Leave: Enable
```

```
  Report Suppression: Enable
```

```
  Router Time:320
```

```
  Member Time: 300
```

```
Querier: Disable
```

```
...
```

```
Switch(config)#end
```

```
Switch#copy running-config startup-config
```

The following example shows how to enable IGMP Snooping querier for VLAN 1, and configure the query interval as 100 seconds, the maximum response time as 15 seconds, the last member query interval as 2 seconds, the last member query count as 3, and the general query source IP as 192.168.0.5:

```
Switch#configure
```

```
Switch(config)#ip igmp snooping vlan-config 1 querier
```

```
Switch(config)#ip igmp snooping vlan-config 1 querier query-interval 100
```

```
Switch(config)#ip igmp snooping vlan-config 1 querier max-response-time 15
```

```
Switch(config)#ip igmp snooping vlan-config 1 querier last-member-query-interval 2
```

```
Switch(config)#ip igmp snooping vlan-config 1 querier last-member-query-count 3
```

```
Switch(config)#ip igmp snooping vlan-config 1 querier general-query source-ip192.168.0.5
```

```
Switch(config)#show ip igmp snooping vlan 1
```

Vlan Id: 1

...

Querier:

Maximum Response Time: 15
 Query Interval: 100
 Last Member Query Interval: 2
 Last Member Query Count: 3
 General Query Source IP: 192.168.0.5

...

Switch(config)#end

Switch#copy running-config startup-config

2.2.3 Configuring IGMP Snooping for Ports

Follow these steps to configure IGMP Snooping for ports:

Step 1	configure Enter global configuration mode.
Step 2	interface {fastEthernet port range fastEthernet port-list gigabitEthernet port range gigabitEthernet port-list ten-gigabitEthernet port range ten-gigabitEthernet port-list port-channel port-channel-id range port-channel port-channel-list} Enter interface configuration mode.
Step 3	ip igmp snooping Enable IGMP Snooping for the port. By default, it is enabled.
Step 4	ip igmp snooping immediate-leave (Optional) Enable Fast Leave on the specified port. Fast Leave can be enabled on a per-port basis or per-VLAN basis. When enabled on a per-port basis, the switch will remove the port from the corresponding multicast group of all VLANs before forwarding the leave message to the querier. You should only use Fast Leave for a port when there is a single receiver connected to the port. For more details about Fast Leave, see 2.2.2 Configuring IGMP Snooping for VLANs .
Step 5	show ip igmp snooping interface [fastEthernet [port-list]] gigabitEthernet [port-list] ten-gigabitEthernet [port-list] port-channel [port-channel-list]] basic-config Show the basic IGMP Snooping configuration on the specified port(s) or of all the ports.
Step 6	end Return to privileged EXEC mode.

-
- Step 7 **copy running-config startup-config**
Save the settings in the configuration file.
-

The following example shows how to enable IGMP Snooping and fast leave for port 1/0/1-3:

Switch#configure

Switch(config)#interface range gigabitEthernet 1/0/1-3

Switch(config-if-range)#ip igmp snooping

Switch(config-if-range)#ip igmp snooping immediate-leave

Switch(config-if-range)#show ip igmp snooping interface gigabitEthernet 1/0/1-3

Port	IGMP-Snooping	Fast-Leave
-----	-----	-----
Gi1/0/1	enable	enable
Gi1/0/2	enable	enable
Gi1/0/3	enable	enable

Switch(config-if-range)#end

Switch#copy running-config startup-config

2.2.4 Configuring Hosts to Statically Join a Group

Hosts or Layer 2 ports normally join multicast groups dynamically, but you can also configure hosts to statically join a group.

Follow these steps to configure hosts to statically join a group:

-
- Step 1 **configure**
Enter global configuration mode.
-
- Step 2 **ip igmp snooping vlan-config *vlan-id-list* static ip interface { fastEthernet *port-list* | gigabitEthernet *port-list* | ten-gigabitEthernet *port-list*| port-channel *lag-list* }**

vlan-id-list: Specify the ID or the ID list of the VLAN(s).

ip: Specify the IP address of the multicast group that the hosts want to join.

port-list / *lag-list*: Specify the ports that is connected to the hosts. These ports will become static member ports of the group.

-
- Step 3 **show ip igmp snooping groups static**
Show the static MLD Snooping configuration.
-

Step 4 **end**
Return to privileged EXEC mode.

Step 5 **copy running-config startup-config**
Save the settings in the configuration file.

The following example shows how to configure port 1/0/1-3 in VLAN 2 to statically join the multicast group 239.1.2.3:

Switch#configure

```
Switch(config)#ip igmp snooping vlan-config 2 static 239.1.2.3 interface
gigabitEthernet 1/0/1-3
```

Switch(config)#show ip igmp snooping groups static

Multicast-ip	VLAN-id	Addr-type	Switch-port	Expire
-----	-----	-----	-----	-----
239.1.2.3	2	static	Gi1/0/1-3	

```
Switch(config)#end
```

```
Switch#copy running-config startup-config
```

2.2.5 Configuring IGMP Accounting and Authentication Features

Note:

IGMP Accounting and Authentication is only available on certain devices. To check whether your device supports this feature, refer to the actual web interface.

You can enable IGMP accounting and authentication according to your need. IGMP accounting is configured globally, and IGMP authentication can be enabled on a per-port basis.

To use these features, you need to set up a RADIUS server and configure add the RADIUS server for the switch.

Follow these steps to add the RADIUS server and enable IGMP accounting globally:

Step 1 **configure**
Enter global configuration mode.

-
- Step 2 **radius-server host** *ip-address* [**auth-port** *port-id*] [**acct-port** *port-id*] [**timeout** *time*] [**retransmit** *number*] [**nas-id** *nas-id*] **key** { [0] *string* | 7 *encrypted-string* }
- Add the RADIUS server and configure the related parameters as needed.
- host** *ip-address*: Enter the IP address of the server running the RADIUS protocol.
- auth-port** *port-id*: Specify the UDP destination port on the RADIUS server for authentication requests. The default setting is 1812.
- acct-port** *port-id*: Specify the UDP destination port on the RADIUS server for accounting requests. The default setting is 1813. Usually, it is used in the 802.1X feature.
- timeout** *time*: Specify the time interval that the switch waits for the server to reply before resending. The valid values are from 1 to 9 seconds and the default setting is 5 seconds.
- retransmit** *number*: Specify the number of times a request is resent to the server if the server does not respond. The valid values are from 1 to 3 and the default setting is 2.
- nas-id** *nas-id*: Specify the name of the NAS (Network Access Server) to be contained in RADIUS packets for identification. It ranges from 1 to 31 characters. The default value is the MAC address of the switch. Generally, the NAS indicates the switch itself.
- key** { [0] *string* | 7 *encrypted-string* }: Specify the shared key. 0 and 7 represent the encryption type. 0 indicates that an unencrypted key will follow. 7 indicates that a symmetric encrypted key with a fixed length will follow. By default, the encryption type is 0. *string* is the shared key for the switch and the server, which contains 31 characters at most. *encrypted-string* is a symmetric encrypted key with a fixed length, which you can copy from the configuration file of another switch. The key or encrypted-key you configure here will be displayed in the encrypted form.
-
- Step 3 **ip igmp snooping accounting**
- Enable IGMP accounting globally.
-
- Step 4 **show ip igmp snooping**
- Show the basic IGMP Snooping configuration.
-
- Step 5 **end**
- Return to privileged EXEC mode.
-
- Step 6 **copy running-config startup-config**
- Save the settings in the configuration file.
-

Follow these steps to enable IGMP authentication for ports:

-
- Step 1 **configure**
- Enter global configuration mode.
-
- Step 2 **interface** {**fastEthernet** *port* | **range fastEthernet** *port-list* | **gigabitEthernet** *port* | **range gigabitEthernet** *port-list* | **ten-gigabitEthernet** *port* | **range ten-gigabitEthernet** *port-list* | **port-channel** *port-channel-id* | **range port-channel** *port-channel-list*}
- Enter interface configuration mode.
-

Step 3	ip igmp snooping authentication Enable IGMP Snooping authentication for the port. By default, it is enabled.
Step 4	show ip igmp snooping interface [fastEthernet [port-list] gigabitEthernet [port-list] ten-gigabitEthernet [port-list] port-channel [port-channel-list]] authentication Show the basic IGMP Snooping configuration on the specified port(s) or of all the ports.
Step 5	end Return to privileged EXEC mode.
Step 6	copy running-config startup-config Save the settings in the configuration file.

The following example shows how to enable IGMP accounting globally:

```
Switch#configure
Switch(config)#ip igmp snooping accounting
Switch(config)#show ip igmp snooping
...
Global Authentication Accounting: Enable
Enable Port: Gi1/0/1-28, Po1-14
Enable VLAN:
Switch(config)#end
Switch#copy running-config startup-config
```

The following example shows how to enable IGMP authentication on port 1/0/1-3:

```
Switch#configure
Switch(config)#interface range gigabitEthernet 1/0/1-3
Switch(config-if-range)#ip igmp snooping authentication
Switch(config-if-range)#show ip igmp snooping interface gigabitEthernet 1/0/1-3
authentication
```

Port	IGMP-Authentication
-----	-----
Gi1/0/1	enable
Gi1/0/2	enable
Gi1/0/3	enable

Switch(config)#end

Switch#copy running-config startup-config

3 MLD Snooping Configuration

To complete MLD Snooping configuration, follow these steps:

- 1) Enable MLD Snooping globally and configure the global parameters.
- 2) Configure MLD Snooping for VLANs.
- 3) Configure MLD Snooping for ports.
- 4) (Optional) Configure hosts to statically join a group.

Note:

MLD Snooping takes effect only when it is enabled globally, in the corresponding VLAN and port at the same time.

3.1 Using the GUI

3.1.1 Configuring MLD Snooping Globally

Choose the menu **L2 FEATURES > Multicast > MLD Snooping > Global Config** to load the following page.

Figure 3-1 Configure MLD Snooping Globally

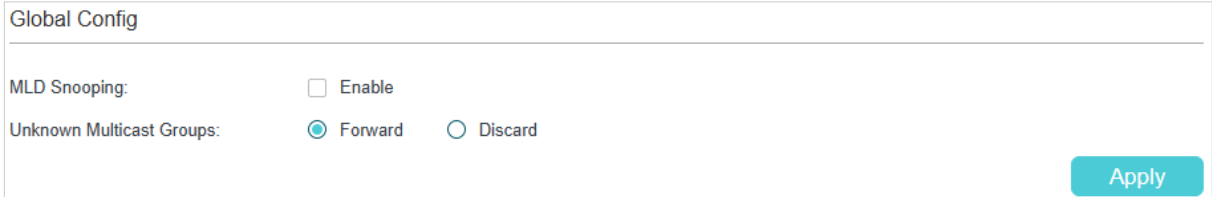

Global Config

MLD Snooping: Enable

Unknown Multicast Groups: Forward Discard

Apply

Follow these steps to configure MLD Snooping globally:

- 1) In the **Global Config** section, enable MLD Snooping and configure the Unknown Multicast Groups feature globally.

MLD Snooping	Enable or disable MLD snooping globally.
Unknown Multicast Groups	<p>Configure the way in which the switch processes data that are sent to unknown multicast groups as Forward or Discard. By default, it is Forward.</p> <p>Unknown multicast groups are multicast groups whose destination multicast address is not in the multicast forwarding table of the switch.</p> <p>Note: IGMP Snooping and MLD Snooping share the setting of Unknown Multicast Groups.</p>

- 2) Click **Apply**.

3.1.2 Configuring MLD Snooping for VLANs

Before configuring MLD Snooping for VLANs, set up the VLANs that the router ports and the member ports are in. For details, please refer to [Configuring 802.1Q VLAN](#).

The switch supports configuring MLD Snooping on a per-VLAN basis. After MLD Snooping is enabled globally, you also need to enable MLD Snooping and configure the corresponding parameters for the VLANs that the router ports and the member ports are in.

Choose the menu **L2 FEATURES > Multicast > MLD Snooping > Global Config**, and click  in your desired VLAN entry in the **MLD VLAN Config** section to load the following page.

Figure 3-2 Configure MLD Snooping for VLAN

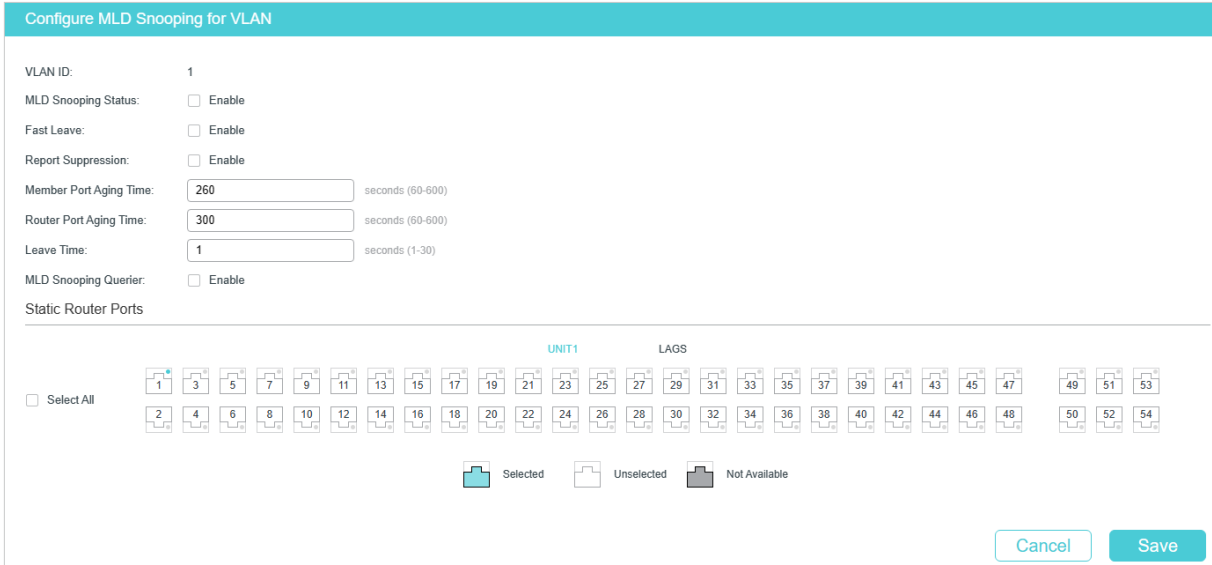

Configure MLD Snooping for VLAN

VLAN ID: 1

MLD Snooping Status: Enable

Fast Leave: Enable

Report Suppression: Enable

Member Port Aging Time: seconds (60-600)

Router Port Aging Time: seconds (60-600)

Leave Time: seconds (1-30)

MLD Snooping Querier: Enable



Static Router Ports

Select All

UNIT1 LAGS

1 3 5 7 9 11 13 15 17 19 21 23 25 27 29 31 33 35 37 39 41 43 45 47 49 51 53

2 4 6 8 10 12 14 16 18 20 22 24 26 28 30 32 34 36 38 40 42 44 46 48 50 52 54

 Selected  Unselected  Not Available

Follow these steps to configure MLD Snooping for a specific VLAN:

- 1) Enable MLD Snooping for the VLAN, and configure the corresponding parameters.

VLAN ID	Displays the VLAN ID.
MLD Snooping Status	Enable or disable MLD snooping for the VLAN.

Fast Leave	Enable or disable Fast Leave feature for the VLAN.
	<p>Without Fast Leave, after a receiver sends an MLD done message (equivalent to an IGMP leave message) to leave a multicast group, the switch will forward the done message to the Layer 3 device (the querier).</p>
	<p>From the point of view of the querier, the port connecting to the switch is a member port of the corresponding multicast group. After receiving the done message from the switch, the querier will send out a configured number (Last Listener Query Count) of Multicast-Address-Specific Queries (MASQs) on that port with a configured interval (Last Listener Query Interval), and wait for MLD reports. If there are other receivers connecting to the switch, they will response to the MASQs before the Last Listener Query Interval expires. If no reports are received after the response time of the last query expires, the querier will remove the port from the forwarding list of the corresponding multicast group.</p>
	<p>That is, if there are other receivers connecting to the switch, the one sent done message have to wait until the port ages out from the switch's forwarding list of the corresponding multicast group (the maximum waiting time is decided by the Member Port Aging Time).</p>
	<p>With Fast Leave enabled on a VLAN, the switch will remove the (Multicast Group, Port, VLAN) entry from the multicast forwarding table before forwarding the done message to the querier. This helps to reduce bandwidth waste since the switch no longer sends the corresponding multicast streams to the VLAN of the port as soon as the port receives a done message from the VLAN.</p>
Report Suppression	Enable or disable Report Suppression feature for the VLAN.
	<p>When enabled, the switch will only forward the first MLD report message to layer 3 devices and suppress subsequent MLD report messages from the same multicast group during one query interval. This feature prevents duplicate report messages from being sent to the layer 3 devices.</p>
Member Port Aging Time	Specify the aging time of the member ports in the VLAN.
	<p>Once the switch receives an MLD report message from a port, the switch adds this port to the member port list of the corresponding multicast group. Member ports that are learned in this way are called dynamic member ports.</p>
	<p>If the switch does not receive any MLD membership report message for a specific multicast group from a dynamic member port, it will no longer consider this port as a member port of this multicast group and delete it from the multicast forwarding table.</p>
Router Port Aging Time	Specify the aging time of the router ports in the VLAN.
	<p>Once the switch receives an MLD general query message from a port, the switch adds this port to the router port list. Router ports that are learned in this way are called dynamic router ports.</p>
	<p>If the switch does not receive any MLD general query message from a dynamic router port within the router port aging time, the switch will no longer consider this port as a router port and delete it from the router port list.</p>

Leave Time	<p>Specify the leave time for the VLAN. When the switch receives a leave message from a port to leave a multicast group, it will wait for a leave time before removing the port from the multicast group. During the period, if the switch receives any report messages from the port, the port will not be removed from the multicast group. Exceptions are as follows:</p> <ul style="list-style-type: none"> If the member port ages out before the Leave Time ends and no report messages are received, the port will be removed from the multicast group once its Member Port Aging Time ends. The Leave Time mechanism will not take effect when Fast Leave takes effect.
MLD Snooping Querier	<p>Enable or disable the MLD Snooping Querier feature for the VLAN. When enabled, the switch acts as an MLD Snooping Querier for the hosts in this VLAN. A querier periodically sends a general query on the network to solicit membership information, and sends MASQs when it receives done messages from hosts.</p>
Query Interval	<p>Specify the interval between general query messages sent by the querier.</p>
Maximum Response Time	<p>With MLD Snooping Querier enabled, specify the host's maximum response time to general query messages.</p>
Last Listener Query Interval	<p>With MLD Snooping Querier enabled, when the switch receives an MLD leave message, the switch obtains the address of the multicast group that the host wants to leave from the message. Then the switch sends out Multicast-Address-Specific Queries (MASQs) to this multicast group through the port receiving the leave message. This parameter determines the interval between MASQs.</p>
Last Listener Query Count	<p>With MLD Snooping Querier enabled, specify the number of MASQs to be sent. If specified count of MASQs are sent and no report message is received, the switch will delete the multicast address from the multicast forwarding table.</p>
General Query Source IP	<p>With MLD Snooping Querier enabled, specify the source IP address of the general query messages sent by the querier. It should be a unicast address.</p>
Dynamic Router Ports	<p>Displays all the dynamic router ports in the multicast VLAN.</p>
Static Router Ports	<p>Select one or more ports to be the static router ports in the VLAN. All multicast data in this VLAN will be forwarded through the static router ports.</p> <p>Multicast streams and MLD packets to all groups in this VLAN will be forwarded through the static router ports. Multicast streams and MLD packets to the groups that have dynamic router ports will be also forwarded through the corresponding dynamic router ports.</p>
Forbidden Router Ports	<p>Select the ports to forbid them from being router ports in the VLAN.</p>

2) Click **Save**.

3.1.3 Configuring MLD Snooping for Ports

Choose the menu **L2 FEATURES > Multicast > MLD Snooping > Port Config** to load the following page.

Figure 3-3 Configure MLD Snooping for Ports

Port Config				
UNIT1	LAGS			
<input type="checkbox"/>	Port	MLD Snooping	Fast Leave	LAG
<input type="checkbox"/>	Gi1/0/1	Enabled	Disabled	---
<input type="checkbox"/>	Gi1/0/2	Enabled	Disabled	---
<input type="checkbox"/>	Gi1/0/3	Enabled	Disabled	---
<input type="checkbox"/>	Gi1/0/4	Enabled	Disabled	---
<input type="checkbox"/>	Gi1/0/5	Enabled	Disabled	---
<input type="checkbox"/>	Gi1/0/6	Enabled	Disabled	---
<input type="checkbox"/>	Gi1/0/7	Enabled	Disabled	---
<input type="checkbox"/>	Gi1/0/8	Enabled	Disabled	---
<input type="checkbox"/>	Gi1/0/9	Enabled	Disabled	---
<input type="checkbox"/>	Gi1/0/10	Enabled	Disabled	---
Total: 54				

Follow these steps to configure MLD Snooping for ports:

- 1) Enable MLD Snooping for the port and enable Fast Leave if there is only one receiver connected to the port.

MLD Snooping	Enable or disable MLD Snooping on the port.
Fast Leave	<p>Enable or disable Fast Leave on the port.</p> <p>Fast Leave can be enabled on a per-port basis or per-VLAN basis. When enabled, the switch will remove this port from the forwarding list of the corresponding multicast group once the port receives a leave message, without verifying if there are other members of this multicast group</p> <p>You should only use this function when there is a single receiver present on the port. For more details about Fast Leave, see 3.1.2 Configuring MLD Snooping for VLANs.</p>
LAG	Displays the LAG that the port belongs to.

- 2) Click **Apply**.

3.1.4 Configuring Hosts to Statically Join a Group

Hosts or Layer 2 ports normally join multicast groups dynamically, but you can also configure hosts to statically join a group.

Choose the menu **L2 FEATURES > Multicast > MLD Snooping > Static Group Config** and click **+ Add** to load the following page.

Figure 3-4 Configure Hosts to Statically Join a Group

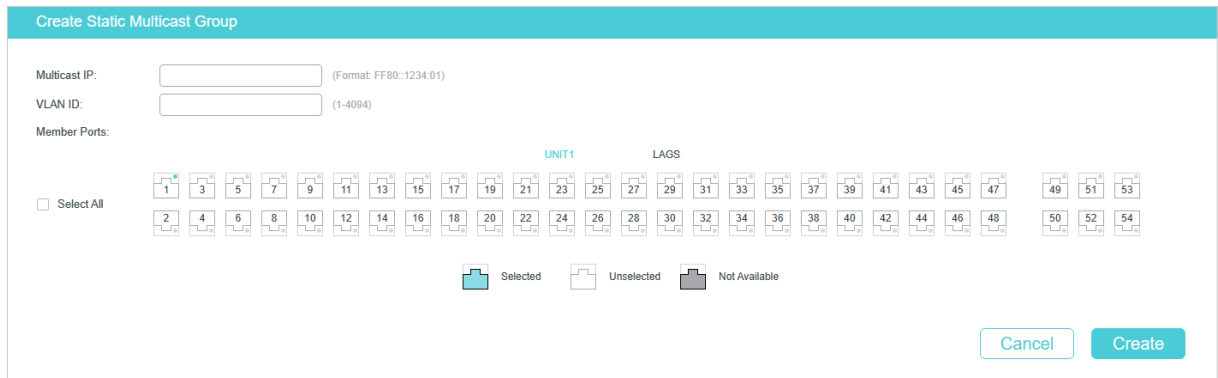

Follow these steps to configure hosts to statically join a group:

- 1) Specify the multicast IP address, VLAN ID. Select the ports to be the static member ports of the multicast group.

Multicast IP	Specify the multicast group that the static member is in.
VLAN ID	Specify the VLAN that the static member is in.
Member Ports	Specify one or more ports to be the static member ports in the multicast group. Without aging, the static member ports receive all multicast data sent to the multicast group.

- 2) Click **Create**.

3.2 Using the CLI

3.2.1 Configuring MLD Snooping Globally

Follow these steps to configure MLD Snooping globally:

Step 1	configure Enter global configuration mode.
Step 2	ipv6 mld snooping Enable MLD Snooping Globally.

-
- Step 3 **ipv6 mld snooping drop-unknown**
 (Optional) Configure the way how the switch processes multicast streams that are sent to unknown multicast groups as Discard. By default, it is Forward.
 Unknown multicast groups are multicast groups that do not match any of the groups announced in earlier IGMP membership reports, and thus cannot be found in the multicast forwarding table of the switch.
Note: IGMP Snooping and MLD Snooping share the setting of Unknown Multicast Groups.
-
- Step 4 **show ipv6 mld snooping**
 Show the basic IGMP Snooping configuration.
-
- Step 5 **end**
 Return to privileged EXEC mode.
-
- Step 6 **copy running-config startup-config**
 Save the settings in the configuration file.
-

The following example shows how to enable MLD Snooping globally, and the way how the switch processes multicast streams that are sent to unknown multicast groups as discard.

Switch#configure

Switch(config)#ipv6 mld snooping

Switch(config)#ipv6 mld snooping

Switch(config)#ipv6 mld snooping drop-unknown

Switch(config)#show ipv6 mld snooping

MLD Snooping :Enable

Unknown Multicast :Discard

...

Switch(config)#end

Switch#copy running-config startup-config

3.2.2 Configuring MLD Snooping for VLANs

Before configuring MLD Snooping for VLANs, set up the VLANs that the router ports and the member ports are in. For details, please refer to [Configuring 802.1Q VLAN](#).

The switch supports configuring MLD Snooping on a per-VLAN basis. After MLD Snooping is enabled globally, you also need to enable MLD Snooping and configure the corresponding parameters for the VLANs that the router ports and the member ports are in.

Follow these steps to configure MLD Snooping for VLANs:

-
- Step 1 **configure**
Enter global configuration mode.
-
- Step 2 **ipv6 mld snooping vlan-config vlan-id-list mtime member-time**
Enable MLD Snooping for the specified VLANs, and specify the member port aging time for the VLANs.
vlan-id-list: Specify the ID or the ID list of the VLAN(s).
member-time: Specify the aging time of the member ports in the specified VLANs. Valid values are from 60 to 600 seconds. By default, it is 260 seconds.
Once the switch receives an MLD report message from a port, the switch adds this port to the member port list of the corresponding multicast group. Member ports that are learned in this way are called dynamic member ports.

If the switch does not receive any MLD report message for a specific multicast group from a dynamic member port, it will no longer consider this port as a member port of this multicast group and delete it from the multicast forwarding table.
-
- Step 3 **ipv6 mld snooping vlan-config vlan-id-list rtime router-time**
Specify the router port aging time for the VLANs.
vlan-id-list: Specify the ID or the ID list of the VLAN(s).
router-time: Specify the aging time of the router ports in the specified VLANs. Valid values are from 60 to 600 seconds. By default, it is 300 seconds.
Once the switch receives an MLD general query message from a port, the switch adds this port to the router port list. Router ports that are learned in this way are called dynamic router ports.

If the switch does not receive any MLD general query message from a dynamic router port within the router port aging time, the switch will no longer consider this port as a router port and delete it from the router port list.
-
- Step 4 **ipv6 mld snooping vlan-config vlan-id-list ltime leave-time**
Specify the router port aging time for the VLANs.
vlan-id-list: Specify the ID or the ID list of the VLAN(s).
leave-time: Specify the leave time for the VLAN(s). Valid values are from 1 to 30 in seconds, and the default value is 1 second.
When the switch receives a leave message from a port to leave a multicast group, it will wait for a leave time before removing the port from the multicast group. During the period, if the switch receives any report messages from the port, the port will not be removed from the multicast group. Exceptions are as follows:
- If the member port ages out before the Leave Time ends and no report messages are received, the port will be removed from the multicast group once its Member Port Aging Time ends.
 - The Leave Time mechanism will not take effect when Fast Leave takes effect.
- A proper leave time value can avoid other hosts connecting to the same port of the switch being mistakenly removed from the multicast group when only some of them want to leave.
-

-
- Step 5 **ipv6 mld snooping vlan-config *vlan-id-list* report-suppression**
- (Optional) Enable Report Suppression for the VLANs. By default, it is disabled.
- When enabled, the switch will only forward the first MLD report message for each multicast group to the MLD querier and suppress subsequent MLD report messages for the same multicast group during one query interval. This feature prevents duplicate report messages from being sent to the MLD querier.
- vlan-id-list*: Specify the ID or the ID list of the VLAN(s).
-
- Step 6 **ipv6 mld snooping vlan-config *vlan-id-list* immediate-leave**
- (Optional) Enable Fast Leave for the VLANs. By default, it is disabled.
- Without Fast Leave, after a receiver sends an MLD done message (equivalent to an IGMP leave message) to leave a multicast group, the switch will forward the done message to the Layer 3 device (the querier).
- From the point of view of the querier, the port connecting to the switch is a member port of the corresponding multicast group. After receiving the done message from the switch, the querier will send out a configured number (Last Listener Query Count) of Multicast-Address-Specific Queries (MASQs) on that port with a configured interval (Last Listener Query Interval), and wait for MLD reports. If there are other receivers connecting to the switch, they will response to the MASQs before the Last Listener Query Interval expires. If no reports are received after the response time of the last query expires, the querier will remove the port from the forwarding list of the corresponding multicast group.
- That is, if there are other receivers connecting to the switch, the one sent done message have to wait until the port ages out from the switch's forwarding list of the corresponding multicast group (the maximum waiting time is decided by the Member Port Aging Time).
- With Fast Leave enabled on a VLAN, the switch will remove the (Multicast Group, Port, VLAN) entry from the multicast forwarding table before forwarding the done message to the querier. This helps to reduce bandwidth waste since the switch no longer sends the corresponding multicast streams to the VLAN of the port as soon as the port receives a done message from the VLAN.
- vlan-id-list*: Specify the ID or the ID list of the VLAN(s).
-
- Step 7 **ipv6 mld snooping vlan-config *vlan-id-list* rport interface { fastEthernet *port-list* | gigabitEthernet *port-list* | ten-gigabitEthernet *port-list* | port-channel *lag-list* }**
- (Optional) Specify the static router ports for the VLANs. Static router ports do not age.
- vlan-id-list*: Specify the ID or the ID list of the VLAN(s).
- port-list*: The number or the list of the Ethernet port that need to be configured as static router ports.
- lag-list*: The ID or the list of the LAG that need to be configured as static router ports.
-
- Step 8 **ipv6 mld snooping vlan-config *vlan-id-list* router-ports-forbidden interface { fastEthernet *port-list* | gigabitEthernet *port-list* | ten-gigabitEthernet *port-list* | port-channel *lag-list* }**
- (Optional) Specify the ports to forbid them from being router ports in the VLANs.
- vlan-id-list*: Specify the ID or the ID list of the VLAN(s).
- port-list*: The number or the list of the Ethernet port that need to be forbidden from being router ports.
- lag-list*: The ID or the list of the LAG that need to be forbidden from being router ports.
-

Step 9 `ipv6 mld snooping vlan-config vlan-id-list querier`

(Optional) Enable MLD Snooping Querier for the VLAN. By default, it is disabled.

When enabled, the switch acts as an MLD Snooping Querier for the hosts in this VLAN. A querier periodically sends a general query on the network to solicit membership information, and sends group-specific queries when it receives done messages from hosts.

vlan-id-list: Specify the ID or the ID list of the VLAN(s).

After enabling MLD Snooping Querier feature, you need to specify the corresponding parameters including the Last Member Query Count, Last Member Query Interval, Maximum Response Time, Query Interval and General Query Source IP. Use the command below in global configuration mode to configure the parameters:

```
ipv6 mld snooping vlan-config vlan-id-list querier { max-response-time response-time |
query-interval interval | general-query source-ip ip-addr | last-listener-query-count num |
last-listener-query-interval interval }
```

vlan-id-list: Specify the ID or the ID list of the VLAN(s).

response-time: Specify the host's maximum response time to general query messages.

query-interval interval: Specify the interval between general query messages sent by the switch.

ip-addr: Specify the source IP address of the general query messages sent by the switch. It should be a unicast address.

num: Specify the number of group-specific queries to be sent. With MLD Snooping Querier enabled, when the switch receives a done message, it obtains the address of the multicast group that the host wants to leave from the message. Then the switch sends out MASQs to this multicast group through the port receiving the done message. If specified count of MASQs are sent and no report message is received, the switch will delete the multicast address from the multicast forwarding table.

last-listener-query-interval interval: Specify the interval between MASQs.

Step 10 `show ipv6 mld snooping vlan vlan-id`

Show the basic MLD snooping configuration in the specified VLAN.

Step 11 `end`

Return to privileged EXEC mode.

Step 12 `copy running-config startup-config`

Save the settings in the configuration file.

The following example shows how to enable MLD Snooping for VLAN 1, and configure the member port aging time as 300 seconds, the router port aging time as 320 seconds, and then enable Fast Leave and Report Suppression for the VLAN:

```
Switch#configure
```

```
Switch(config)#ipv6 mld snooping vlan-config 1 mtime 300
```

```
Switch(config)#ipv6 mld snooping vlan-config 1 rtime 320
```

```
Switch(config)#ipv6 mld snooping vlan-config 1 immediate-leave
```

```
Switch(config)#ipv6 mld snooping vlan-config 1 report-suppression
```

Switch(config)#show ipv6 mld snooping vlan 1

Vlan Id: 1

Vlan MLD Snooping Status: Enable

Fast Leave: Enable

Report Suppression: Enable

Router Time: Enable

Member Time: Enable

Querier: Disable

...

Switch(config)#end**Switch#copy running-config startup-config**

The following example shows how to enable MLD Snooping querier for VLAN 1, and configure the query interval as 100 seconds, the maximum response time as 15 seconds, the last listener query interval as 2 seconds, the last listener query count as 3, and the general query source IP as 2000::1:2345:6789:ABCD:

Switch#configure**Switch(config)#ipv6 mld snooping vlan-config 1 querier****Switch(config)#ipv6 mld snooping vlan-config 1 querier query-interval 100****Switch(config)#ipv6 mld snooping vlan-config 1 querier max-response-time 15****Switch(config)#ipv6 mld snooping vlan-config 1 querier last-listener-query-interval 2****Switch(config)#ipv6 mld snooping vlan-config 1 querier last-listener-query-count 3****Switch(config)#ipv6 mld snooping vlan-config 1 querier general-query source-ip 2000::1:2345:6789:ABCD****Switch(config)#show ipv6 mld snooping vlan 1**

Vlan Id: 1

...

Querier: Enable

Maximum Response Time: 15

Query Interval: 100

Last Member Query Interval: 2

Last Member Query Count: 3

General Query Source IP: 2000::1:2345:6789:abcd

...

Switch(config)#end

Switch#copy running-config startup-config

3.2.3 Configuring MLD Snooping for Ports

Follow these steps to configure MLD Snooping for ports:

Step 1	configure Enter global configuration mode.
Step 2	interface {fastEthernet port range fastEthernet port-list gigabitEthernet port range gigabitEthernet port-list ten-gigabitEthernet port range ten-gigabitEthernet port-list port-channel port-channel-id range port-channel port-channel-list} Enter interface configuration mode.
Step 3	ipv6 mld snooping Enable MLD Snooping for the port. By default, it is enabled.
Step 4	ipv6 mld snooping immediate-leave (Optional) Enable Fast Leave on the specified port. Fast Leave can be enabled on a per-port basis or per-VLAN basis. When enabled on a per-port basis, the switch will remove the port from the corresponding multicast group of all VLANs before forwarding the done message to the querier. You should only use Fast Leave for a port when there is a single receiver connected to the port. For more details about Fast Leave, see 3.2.2 Configuring MLD Snooping for VLANs .
Step 5	show ipv6 mld snooping interface [fastEthernet [port-list] gigabitEthernet [port-list] ten-gigabitEthernet [port-list] port-channel [port-channel-list]] basic-config Show the basic MLD Snooping configuration on the specified port(s) or of all the ports.
Step 6	end Return to privileged EXEC mode.
Step 7	copy running-config startup-config Save the settings in the configuration file.

The following example shows how to enable MLD Snooping and fast leave for port 1/0/1-3:

Switch#configure

Switch(config)#interface range gigabitEthernet 1/0/1-3

Switch(config-if-range)#ipv6 mld snooping

Switch(config-if-range)#ipv6 mld snooping immediate-leave

Switch(config-if-range)#show ipv6 mld snooping interface gigabitEthernet 1/0/1-3

Port	MLD-Snooping	Fast-Leave
-----	-----	-----
Gi1/0/1	enable	enable
Gi1/0/2	enable	enable
Gi1/0/3	enable	enable

Switch(config-if-range)#end

Switch#copy running-config startup-config

3.2.4 Configuring Hosts to Statically Join a Group

Hosts or Layer 2 ports normally join multicast groups dynamically, but you can also configure hosts to statically join a group.

Follow these steps to configure hosts to statically join a group:

Step 1	configure Enter global configuration mode.
Step 2	ipv6 mld snooping vlan-config <i>vlan-id-list</i> static ip interface { fastEthernet <i>port-list</i> gigabitEthernet <i>port-list</i> ten-gigabitEthernet <i>port-list</i> port-channel <i>lag-list</i> } <i>vlan-id-list</i> : Specify the ID or the ID list of the VLAN(s). <i>ip</i> : Specify the IP address of the multicast group that the hosts want to join. <i>port-list</i> / <i>lag-list</i> : Specify the ports that is connected to the hosts. These ports will become static member ports of the group.
Step 3	show ipv6 mld snooping groups static Show the static MLD Snooping configuration.
Step 4	end Return to privileged EXEC mode.
Step 5	copy running-config startup-config Save the settings in the configuration file.

The following example shows how to configure port 1/0/1-3 in VLAN 2 to statically join the multicast group ff80::1234:1:

Switch#configure

Switch(config)#ipv6 mld snooping vlan-config 2 static ff80::1234:1 interface gigabitEthernet 1/0/1-3

Switch(config)#show ipv6 mld snooping groups static

Multicast-ip	VLAN-id	Addr-type	Switch-port
-----	-----	-----	-----
ff80::1234:1	2	static	Gi1/0/1-3

Switch(config)#end

Switch#copy running-config startup-config

4 MVR Configuration

To complete MVR configuration, follow these steps:

- 1) Configure 802.1Q VLANs.
- 2) Configure MVR globally.
- 3) Add multicast groups to MVR.
- 4) Configure MVR for the ports.
- 5) (Optional) Statically add ports to MVR groups.

Configuration Guidelines

- MVR does not support IGMPv3 messages.
- Do not configure MVR on private VLAN ports, otherwise MVR cannot take effect.
- MVR operates on the underlying mechanism of IGMP Snooping, but the two features operate independently of each other. Both protocols can be enabled on a port at the same time. When both are enabled, MVR listens to the report and leave messages only for the multicast groups configured in MVR. All other multicast groups are managed by IGMP Snooping.

4.1 Using the GUI

4.1.1 Configuring 802.1Q VLANs

Before configuring MVR, create an 802.1Q VLAN as the multicast VLAN. Add all source ports (uplink ports that receive multicast data from the router) to the multicast VLAN as tagged ports. Configure 802.1Q VLANs for the receiver ports (ports that are connecting to the hosts) according to network requirements. Note that receiver ports can only belong to one VLAN and cannot be added to the multicast VLAN. For details, refer to [Configuring 802.1Q VLAN](#).

4.1.2 Configuring MVR Globally

Choose the menu **L2 FEATURES > Multicast > MVR > MVR Config** to load the following page.

Figure 4-1 Configure MVR Globally

The screenshot shows the 'MVR Config' page with the following settings:

- MVR:** Enable
- MVR Mode:** Compatible Dynamic
- Multicast VLAN ID:** (1-4094)
- Query Response Time:** tenths of a second (1-100)
- Maximum Multicast Groups:** 4093
- Current Multicast Groups:** 0

An 'Apply' button is located in the bottom right corner.

Follow these steps to configure MVR globally:

- 1) Enable MVR globally and configure the global parameters.

MVR	Enable or disable MVR globally.
MVR Mode	Specify the MVR mode as compatible or dynamic. Compatible: In Compatible mode, the MVR switch does not forward IGMP reports from the hosts to the IGMP router. This means the IGMP router cannot learn the multicast groups' membership information from the MVR switch. The IGMP router must be statically configured to transmit all the required multicast streams to the MVR switch. Dynamic: In Dynamic mode, after receiving report or leave messages from the hosts, the MVR switch will forward them to the multicast router on the multicast VLAN (with appropriate translation of the VLAN ID). The multicast router can learn the multicast groups' membership information through the report and leave messages, and transmit the multicast streams according to the multicast forwarding table.
Multicast VLAN ID	Specify the VLAN on which the multicast data will be received.
Query Response Time	Specify the maximum time to wait for the IGMP membership report since the switch receives an IGMP leave message on a receiver port. After receiving an IGMP leave message from a receiver port, the switch will send out group-specific queries and wait for IGMP membership reports. If no IGMP membership reports are received before the Query Response Time expires, the switch will remove the port from the multicast group.
Maximum Multicast Groups	Displays the max number of multicast groups that MVR supports.
Current Multicast Groups	Displays the current number of the MVR groups.

- 2) Click **Apply**.

4.1.3 Adding Multicast Groups to MVR

You need to manually add multicast groups to the MVR. Choose the menu **L2 FEATURES > Multicast > MVR > MVR Group Config** and click **+ Add** to load the following page.

Figure 4-2 Add Multicast Groups to MVR

MVR Group IP

MVR Group IP: (Format: 235.0.0.1)

MVR Group Count: (1-256)

Cancel
Create

Follow these steps to add multicast groups to MVR:

- 1) Specify the IP address of the multicast groups.

MVR Group IP	Specify the start IP address of contiguous series of multicast groups to be added to the MVR. Multicast data sent to the address specified here will be sent to all source ports on the switch and all receiver ports that have requested to receive data from that multicast address.
MVR Group Count	Specify the number of contiguous multicast IP group addresses.

- 2) Click **Create**.

Then the added multicast groups will appear in the MVR group table, as the following figure shows:

Figure 4-3 MVR Group Table

MVR Group Table

+ Add - Delete

<input type="checkbox"/>	Index	MVR Group IP	Status	Members	Operation
<input type="checkbox"/>	1	239.1.2.3	Inactive		
<input type="checkbox"/>	2	239.1.2.4	Inactive		
Total: 2					

MVR Group IP	Displays the IP address of multicast group.
---------------------	---

Status	<p>Displays the status of the MVR group. In compatible mode, all the MVR groups are added manually, so the status is always active. In dynamic mode, there are two status:</p> <p>Inactive: The MVR group is added successfully, but the source port has not received any query messages from this multicast group.</p> <p>Active: The MVR group is added successfully and the source port has received query messages from this multicast group.</p>
Member	Displays the member ports in this MVR group.

4.1.4 Configuring MVR for the Port

Choose the menu **L2 FEATURES > Multicast > MVR > Port Config** to load the following page.

Figure 4-4 Configure MVR for the Port

Port Config

UNIT1

<input type="checkbox"/>	Port	Mode	Type	Status	Fast Leave
<input type="checkbox"/>	Gi1/0/1	Disable	None	Active/InVLAN	Disable
<input type="checkbox"/>	Gi1/0/2	Disable	None	Inactive/InVLAN	Disable
<input type="checkbox"/>	Gi1/0/3	Disable	None	Inactive/InVLAN	Disable
<input type="checkbox"/>	Gi1/0/4	Disable	None	Inactive/InVLAN	Disable
<input type="checkbox"/>	Gi1/0/5	Disable	None	Inactive/InVLAN	Disable
<input type="checkbox"/>	Gi1/0/6	Disable	None	Inactive/InVLAN	Disable
<input type="checkbox"/>	Gi1/0/7	Disable	None	Inactive/InVLAN	Disable
<input type="checkbox"/>	Gi1/0/8	Disable	None	Inactive/InVLAN	Disable
<input type="checkbox"/>	Gi1/0/9	Disable	None	Inactive/InVLAN	Disable
<input type="checkbox"/>	Gi1/0/10	Disable	None	Inactive/InVLAN	Disable

Total: 54

Follow these steps to add multicast groups to MVR:

- 1) Select one or more ports to configure.
- 2) Enable MVR, and configure the port type and Fast Leave feature for the port.

Mode	Enable or disable MVR for the selected ports.
-------------	---

Type	<p>Configure the port type.</p> <p>None: The port is a non-MVR port. If you attempt to configure a non-MVR port with MVR characteristics, the operation will be unsuccessful.</p> <p>Source: Configure the uplink ports that receive and send multicast data on the multicast VLAN as source ports. Source ports should belong to the multicast VLAN. In compatible mode, source ports will be automatically added to all multicast groups, while in dynamic mode, you need to manually add them to the corresponding multicast groups.</p> <p>Receiver: Configure the ports that are connecting to the hosts as receiver ports. A receiver port can only belong to one VLAN, and cannot belong to the multicast VLAN. In both modes, the switch will add or remove the receiver ports to the corresponding multicast groups by snooping the report and leave messages from the hosts.</p>
Status	<p>Displays the port's status.</p> <p>Active/InVLAN: The port is physically up and in one or more VLANs.</p> <p>Active/NotInVLAN: The port is physically up and not in any VLAN.</p> <p>Inactive/InVLAN: The port is physically down and in one or more VLANs.</p> <p>Inactive/NotInVLAN: The port is physically down and not in any VLAN.</p>
Fast Leave	<p>Enable or disable Fast Leave on this port. When enabled, the receiver port will be removed from the multicast group when an IGMP leave message is received on this port, without verifying if there are other members of this multicast group.</p> <p>This function should only be enabled on receiver ports to which a single receiver device is connected.</p>

3) Click **Apply**.

4.1.5 (Optional) Adding Ports to MVR Groups Statically

You can add only receiver ports to MVR groups statically. The switch adds or removes receiver ports to the corresponding multicast groups by snooping the report and leave messages from the hosts. You can also statically add a receiver port to an MVR group.

Choose the menu **L2 FEATURES > Multicast > MVR > Static Group Members**, and click  in your desired MVR group entry to load the following page.

Figure 4-5 Configure Hosts to Statically Join an MVR group

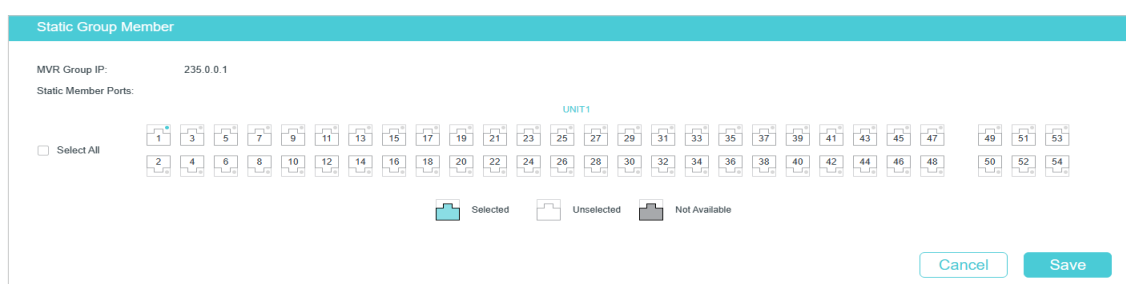

Follow these steps to statically add ports to an MVR group:

- 1) Select the ports to add them to the MVR group.
- 2) Click **Save**.

4.2 Using the CLI

4.2.1 Configuring 802.1Q VLANs

Before configuring MVR, create an 802.1Q VLAN as the multicast VLAN. Add the all source ports to the multicast VLAN as tagged ports. Configure 802.1Q VLANs for the receiver ports according to network requirements. Note that receiver ports can only belong to one VLAN and cannot be added to the multicast VLAN. For details, refer to [Configuring 802.1Q VLAN](#).

4.2.2 Configuring MVR Globally

Follow these steps to configure MVR globally:

Step 1	configure Enter global configuration mode.
Step 2	mvr Enable MVR Globally.
Step 3	mvr mode { compatible dynamic } Configure the MVR mode as compatible or dynamic. compatible: In this mode, the switch does not forward report or leave messages from the hosts to the IGMP querier. So the IGMP querier cannot learn the multicast groups membership information from the switch. You have to statically configure the IGMP querier to transmit all the required multicast streams to the switch via the multicast VLAN. dynamic: In this mode, after receiving report or leave messages from the hosts, the switch will forward them to the IGMP querier via the multicast VLAN (with appropriate translation of the VLAN ID). So the IGMP querier can learn the multicast groups membership information through the report and leave messages, and transmit the multicast streams to the switch via the multicast VLAN according to the multicast forwarding table.
Step 4	mvr vlan <i>vlan-id</i> Specify the multicast VLAN. vlan-id: Specify the ID of the multicast VLAN. Valid values are from 1 to 4094.
Step 5	mvr querytime <i>time</i> Specify the maximum time to wait for IGMP report on a receiver port before removing the port from multicast group membership. time: Specify the maximum response time. Valid values are from 1 to 100 tenths of a second, and the default value is 5 tenths of a second.

Step 6 `mvr group ip-addr count`

Add multicast groups to the MVR.

ip-addr: Specify the start IP address of the contiguous series of multicast groups.

count: Specify the number of the multicast groups to be added to the MVR. The range is 1 to 256.

Step 7 `show mvr`

Show the global MVR configuration.

`show mvr members`

Show the existing MVR groups.

Step 8 `end`

Return to privileged EXEC mode.

Step 9 `copy running-config startup-config`

Save the settings in the configuration file.

The following example shows how to enable MVR globally, and configure the MVR mode as compatible, the multicast VLAN as VLAN 2 and the query response time as 5 tenths of a second. Then add 239.1.2.3-239.1.2.5 to MVR group.

Switch#configure

Switch(config)#mvr mode compatible

Switch(config)#mvr vlan 2

Switch(config)#mvr querytime 5

Switch(config)#mvr group 239.1.2.3 3

Switch(config)#show mvr

```
MVR                                     :Enable
MVR Multicast Vlan                       :2
MVR Max Multicast Groups                 :4093
MVR Current Multicast Groups             :3
MVR Global Query Response Time           :5 (tenths of sec)
MVR Mode Type                            :Compatible
```

Switch(config)#show mvr members

```

MVR Group IP      status      Members
-----
239.1.2.3         active
239.1.2.4         active
239.1.2.5         active

Switch(config)#end

Switch#copy running-config startup-config

```

4.2.3 Configuring MVR for the Ports

Follow these steps to configure MVR for the ports:

Step 1	configure Enter global configuration mode.
Step 2	interface {fastEthernet port range fastEthernet port-list gigabitEthernet port range gigabitEthernet port-list ten-gigabitEthernet port range ten-gigabitEthernet port-list } Enter interface configuration mode.
Step 3	mvr Enable MVR for the port.
Step 4	mvr type { source receiver } Configure the MVR port type as receiver or source. By default, the port is a non-MVR port. If you attempt to configure a non-MVR port with MVR characteristics, the operation fails. source: Configure the uplink ports that receive and send multicast data on the multicast VLAN as source ports. Source ports should belong to the multicast VLAN. receiver: Configure the ports that are connecting to the hosts as receiver ports. A receiver port can only belong to one VLAN, and cannot belong to the multicast VLAN.
Step 5	mvr immediate (Optional) Enable the Fast Leave feature of MVR for the port. Only receiver ports support Fast Leave. Before enabling Fast Leave for a port, make sure there is only a single receiver device connecting to the port.
Step 6	mvr vlan vlan-id group ip-addr (Optional) Statically add the port to an MVR group. Then the port can receive multicast traffic sent to the IP multicast address via the multicast VLAN. This command applies to only receiver ports. The switch adds or removes the receiver ports to the corresponding multicast groups by snooping the report and leave messages from the hosts. You can also statically add a receiver port to an MVR group. vlan-id: Enter the multicast VLAN ID. ip-addr: Specify the IP address of the multicast group.

Step 7 **show mvr interface {fastEthernet [port-list] | gigabitEthernet [port-list] | ten-gigabitEthernet [port-list] }**

Show the MVR configuration of the specified interface(s).

show mvr members

Show the membership information of all MVR groups.

Step 8 **end**

Return to privileged EXEC mode.

Step 9 **copy running-config startup-config**

Save the settings in the configuration file.

The following example shows how to configure port 1/0/7 as source port, and port 1/0/1-3 as receiver ports. Then statically add port 1/0/1-3 to group 239.1.2.3 and enable MVR Fast Leave for these ports. The multicast VLAN is VLAN 2.

Switch#configure

Switch(config)#interface gigabitEthernet 1/0/7

Switch(config-if)#mvr

Switch(config-if)#mvr type source

Switch(config-if)#exit

Switch(config)#interface range gigabitEthernet 1/0/1-3

Switch(config-if-range)#mvr

Switch(config-if-range)#mvr type receiver

Switch(config-if-range)#mvr immediate

Switch(config-if-range)#mvr vlan 2 group 239.1.2.3

Switch(config-if-range)#show mvr interface gigabitEthernet 1/0/1-3,1/0/7

Port	Mode	Type	Status	Immediate Leave
-----	-----	-----	-----	-----
Gi1/0/1	Enable	Receiver	INACTIVE/InVLAN	Enable
Gi1/0/2	Enable	Receiver	INACTIVE/InVLAN	Enable
Gi1/0/3	Enable	Receiver	INACTIVE/InVLAN	Enable
Gi1/0/7	Enable	Source	INACTIVE/InVLAN	Disable

Switch(config-if-range)#show mvr members

MVR Group IP	status	Members
-----	-----	-----
239.1.2.3	active	Gi1/0/1-3, 1/0/7

Switch(config)#end

Switch#copy running-config startup-config

5 Multicast Filtering Configuration

To complete multicast filtering configuration, follow these steps:

- 1) Create the IGMP profile or MLD profile.
- 2) Configure multicast groups a port can join and the overflow action.

5.1 Using the GUI

5.1.1 Creating the Multicast Profile

You can create multicast profiles for both IPv4 and IPv6 network. With multicast profile, the switch can define a blacklist or whitelist of multicast groups so as to filter multicast sources.

The process for creating multicast profiles for IPv4 and IPv6 are similar. The following introductions take creating an IPv4 profile as an example.

Choose the menu **L2 FEATURES > Multicast > Multicast Filtering > IPv4 Profile**, and click

 Add to load the following page.

 **Note:**

To create a multicast profile for IPv6, choose the menu **L2 FEATURES > Multicast > Multicast Filtering > IPv6 Profile**.

Figure 5-1 Create IPv4 Profile

General Config

Profile ID: (1-999)

Mode: Permit Deny

IP-Range

+ Add - Delete

<input type="checkbox"/>	Index	Start IP Address	End IP Address	Operation
No entries in this table.				
Total: 0				

Bind Ports

UNIT1
LAGS

1 3 5 7 9 11 13 15 17 19 21 23 25 27 29 31 33 35

2 4 6 8 10 12 14 16 18 20 22 24 26 28 30 32 34 36

37 39 41 43 45 47 49 51 53

38 40 42 44 46 48 50 52 54

Selected
 Unselected
 Not Available

Discard
Save

Follow these steps to create a profile.

- 1) In the **General Config** section, specify the Profile ID and Mode.

Profile ID	Enter a profile ID between 1 and 999.
Mode	Configure the filtering mode. There are two filtering modes: Permit: Acts as a whitelist and only allows specific member ports to join specified multicast groups. Deny: Acts as a blacklist and prevents specific member ports from joining specific multicast groups.

- 2) In the **IP-Range** section, click + Add to load the following page. Configure the start IP address and end IP address of the multicast groups to be filtered, and click **Create**.

Figure 5-2 Configure Multicast Groups to Be Filtered

IP-Range

Start IP Address: (Format: 235.0.0.1)

End IP Address: (Format: 235.0.0.1)

Cancel
Create

- 3) In the **Bind Ports** section, select your desired ports to be bound with the profile.
- 4) Click **Save**.

5.1.2 Configure Multicast Filtering for Ports

You can modify the mapping relation between ports and profiles in batches, and configure the number of multicast groups a port can join and the overflow action.

The process for configuring multicast filtering for ports in IPv4 and IPv6 are similar. The following introductions take configuring multicast filtering for ports in IPv4 as an example.

Choose the menu **L2 FEATURES > Multicast > Multicast Filtering > IPv4 Port Config** to load the following page.

Note:

For IPv6, choose the menu **L2 FEATURES > Multicast > Multicast Filtering > IPv6 Port Config**.

Figure 5-3 Configure Multicast Filtering for Ports

Port Config						
UNIT1	LAGS					
<input type="checkbox"/>	Port	Profile ID	Maximum Groups	Overflow Action	LAG	Operation
<input type="checkbox"/>	Gi1/0/1		4093	Drop	---	Clear Profile
<input type="checkbox"/>	Gi1/0/2		4093	Drop	---	Clear Profile
<input type="checkbox"/>	Gi1/0/3		4093	Drop	---	Clear Profile
<input type="checkbox"/>	Gi1/0/4		4093	Drop	---	Clear Profile
<input type="checkbox"/>	Gi1/0/5		4093	Drop	---	Clear Profile
<input type="checkbox"/>	Gi1/0/6		4093	Drop	---	Clear Profile
<input type="checkbox"/>	Gi1/0/7		4093	Drop	---	Clear Profile
<input type="checkbox"/>	Gi1/0/8		4093	Drop	---	Clear Profile
<input type="checkbox"/>	Gi1/0/9		4093	Drop	---	Clear Profile
<input type="checkbox"/>	Gi1/0/10		4093	Drop	---	Clear Profile
Total: 54						

Follow these steps to bind the profile to ports and configure the corresponding parameters for the ports:

- 1) Select one or more ports to configure.
- 2) Specify the profile to be bound, and configure the maximum groups the port can join and the overflow action.

Profile ID	Specify the ID of an existing profile to bind the profile to the selected ports. One port can only be bound to one profile.
Maximum Groups	Enter the number of multicast groups the port can join. Valid values are from 0 to 4093.
Overflow Action	Select the action the switch will take with the new multicast member groups when the number of multicast groups the port has joined exceeds the maximum. Drop: Drop all subsequent membership report messages to prevent the port joining a new multicast group. Replace: Replace the existing multicast group that has the lowest multicast MAC address with the new multicast group.
LAG	Displays the LAG that the port belongs to.

- 3) Click **Apply**.

5.2 Using the CLI

5.2.1 Creating the Multicast Profile

You can create multicast profiles for both IPv4 and IPv6 network. With multicast profile, the switch can define a blacklist or whitelist of multicast groups so as to filter multicast sources.

Creating IGMP Profile (Multicast Profile for IPv4)

Step 1	configure Enter global configuration mode.
Step 2	ip igmp profile id Create a new profile and enter profile configuration mode.

-
- Step 3 **Permit**
- Configure the profile's filtering mode as permit. Then the profile acts as a whitelist and only allows specific member ports to join specified multicast groups.
- deny**
- Configure the profile's filtering mode as deny. Then the profile acts as a blacklist and prevents specific member ports from joining specific multicast groups.
-
- Step 4 **range start-ip end-ip**
- Configure the range of multicast IP addresses to be filtered.
- start-ip / end-ip*: Specify the start IP address and end IP address of the IP range.
-
- Step 5 **show ip igmp profile [id]**
- Show the detailed IGMP profile configuration.
-
- Step 6 **end**
- Return to privileged EXEC mode.
-
- Step 7 **copy running-config startup-config**
- Save the settings in the configuration file.
-

The following example shows how to configure Profile 1 so that the switch filters multicast streams sent to 226.0.0.5-226.0.0.10:

```
Switch#configure
```

```
Switch(config)#ip igmp snooping
```

```
Switch(config)#ip igmp profile 1
```

```
Switch(config-igmp-profile)#deny
```

```
Switch(config-igmp-profile)#range 226.0.0.5 226.0.0.10
```

```
Switch(config-igmp-profile)#show ip igmp profile
```

```
IGMP Profile 1
```

```
deny
```

```
range 226.0.0.5 226.0.0.10
```

```
Switch(config)#end
```

```
Switch#copy running-config startup-config
```

Creating MLD Profile (Multicast Profile for IPv6)

- Step 1 **configure**
- Enter global configuration mode.
-

-
- Step 2 **ipv6 mld profile id**
Create a new profile and enter profile configuration mode.
-
- Step 3 **Permit**
Configure the profile's filtering mode as permit. It is similar to a whitelist, indicating that the switch only allow specific member ports to join specific multicast groups.
- deny**
Configure the profile's filtering mode as deny. It is similar to a blacklist, indicating that the switch disallow specific member ports to join specific multicast groups.
-
- Step 4 **range start-ip end-ip**
Configure the range of multicast IP addresses to be filtered.
start-ip / end-ip: Specify the start IP address and end IP address of the IP range.
-
- Step 5 **show ipv6 mld profile [id]**
Show the detailed MLD profile configuration.
-
- Step 6 **end**
Return to privileged EXEC mode.
-
- Step 7 **copy running-config startup-config**
Save the settings in the configuration file.
-

The following example shows how to configure Profile 1 so that the switch filters multicast streams sent to ff01::1234:5-ff01::1234:8:

```
Switch#configure
```

```
Switch(config)#ipv6 mld snooping
```

```
Switch(config)#ipv6 mld profile 1
```

```
Switch(config-mld-profile)#deny
```

```
Switch(config-mld-profile)#range ff01::1234:5 ff01::1234:8
```

```
Switch(config-mld-profile)#show ipv6 mld profile
```

```
MLD Profile 1
```

```
    deny
```

```
    range ff01::1234:5 ff01::1234:8
```

```
Switch(config)#end
```

```
Switch#copy running-config startup-config
```

5.2.2 Binding the Profile to Ports

You can bind the created IGMP profile or MLD profile to ports, and configure the number of multicast groups a port can join and the overflow action.

Binding the IGMP Profile to Ports

Step 1	<p>configure</p> <p>Enter global configuration mode.</p>
Step 2	<p>interface {fastEthernet port range fastEthernet port-list gigabitEthernet port range gigabitEthernet port-list ten-gigabitEthernet port range ten-gigabitEthernet port-list port-channel port-channel-id range port-channel port-channel-list}</p> <p>Enter interface configuration mode.</p>
Step 3	<p>ip igmp filter profile-id</p> <p>Bind the IGMP profile to the specified ports.</p> <p><i>profile-id</i>: Specify the ID of the profile to be bound. It should be an existing profile.</p>
Step 4	<p>ip igmp snooping max-groups maxgroup</p> <p>Configure the maximum number of multicast groups the port can join.</p> <p><i>maxgroup</i>: Specify the maximum number of multicast groups the port can join. The range is 0 to 4093.</p>
Step 5	<p>ip igmp snooping max-groups action {drop replace}</p> <p>Specify the action towards the new multicast group when the number of multicast groups the port joined exceeds the limit.</p> <p><i>drop</i>: Drop all subsequent membership report messages, and the port join no more new multicast groups.</p> <p><i>replace</i>: Replace the existing multicast group owning the lowest multicast MAC address with the new multicast group.</p>
Step 6	<p>show ip igmp profile [id]</p> <p>Show the detailed IGMP profile configurations.</p> <p>show ip igmp snooping interface [fastEthernet [port-list] gigabitEthernet [port-list] ten-gigabitEthernet [port-list] port-channel [port-channel-list]] max-groups</p> <p>Show the multicast group limitation on the specified port(s) or of all the ports.</p>
Step 7	<p>end</p> <p>Return to privileged EXEC mode.</p>
Step 8	<p>copy running-config startup-config</p> <p>Save the settings in the configuration file.</p>

The following example shows how to bind the existing Profile 1 to port 1/0/2, and specify the maximum number of multicast groups that port 1/0/2 can join as 50 and the Overflow Action as Drop:

```
Switch#configure
```

```
Switch(config)#interface gigabitEthernet 1/0/2
```

```
Switch(config-if)#ip igmp snooping
```

```
Switch(config-if)#ip igmp filter 1
```

```
Switch(config-if)#ip igmp snooping max-groups 50
```

```
Switch(config-if)#ip igmp snooping max-groups action drop
```

```
Switch(config-if)#show ip igmp profile
```

```
IGMP Profile 1
```

```
...
```

```
Binding Port(s)
```

```
Gi1/0/2
```

```
Switch(config-if)#show ip igmp snooping interface gigabitEthernet 1/0/2 max-groups
```

Port	Max-Groups	Overflow-Action
-----	-----	-----
Gi1/0/2	50	Drops

```
Switch(config)#end
```

```
Switch#copy running-config startup-config
```

Binding the MLD Profile to Ports

Step 1 **configure**

Enter global configuration mode.

Step 2 **interface {fastEthernet port | range fastEthernet port-list | gigabitEthernet port | range gigabitEthernet port-list | ten-gigabitEthernet port | range ten-gigabitEthernet port-list | port-channel port-channel-id | range port-channel port-channel-list}**

Enter interface configuration mode.

Step 3 **ipv6 mld filter profile-id**

Bind the MLD profile to the specified ports.

profile-id: Specify the ID of the profile to be bound. It should be an existing profile.

Step 4 `ipv6 mld snooping max-groups maxgroup`

Configure the maximum number of multicast groups the port can join.

maxgroup: Specify the maximum number of multicast groups the port can join. The range is 0 to 4093.

Step 5 `ipv6 mld snooping max-groups action {drop | replace}`

Specify the action towards the new multicast group when the number of multicast groups the port joined exceeds max group.

drop: Drop all subsequent membership report messages, and the port join no more new multicast groups.

replace: Replace the existing multicast group owning the lowest multicast MAC address with the new multicast group.

Step 6 `show ipv6 mld profile [id]`

Show the detailed MLD profile configuration.

`show ipv6 mld snooping interface [fastEthernet [port-list] | gigabitEthernet [port-list] | ten-gigabitEthernet [port-list] | port-channel [port-channel-list]] max-groups`

Show the multicast group limitation on the specified port(s) or of all the ports.

Step 7 `end`

Return to privileged EXEC mode.

Step 8 `copy running-config startup-config`

Save the settings in the configuration file.

The following example shows how to bind the existing Profile 1 to port 1/0/2, and specify the maximum number of multicast groups that port 1/0/2 can join as 50 and the Overflow Action as Drop:

Switch#configure

Switch(config)#interface gigabitEthernet 1/0/2

Switch(config-if)#ipv6 mld snooping

Switch(config-if)#ipv6 mld filter 1

Switch(config-if)#ipv6 mld snooping max-groups 50

Switch(config-if)#ipv6 mld snooping max-groups action drop

Switch(config-if)#show ipv6 mld profile

MLD Profile 1

...

Binding Port(s)

Gi1/0/2

```
Switch(config-if)#show ipv6 mld snooping interface gigabitEthernet 1/0/2 max-groups
```

Port	Max-Groups	Overflow-Action
-----	-----	-----
Gi1/0/2	50	Drops

```
Switch(config)#end
```

```
Switch#copy running-config startup-config
```

6 Viewing Multicast Snooping Information

You can view the following multicast snooping information:

- View IPv4 multicast table.
- View IPv4 multicast statistics on each port.
- View IPv6 multicast table.
- View IPv6 multicast statistics on each port.

6.1 Using the GUI

6.1.1 Viewing IPv4 Multicast Table

Choose the menu **L2 FEATURES > Multicast > Multicast Info > IPv4 Multicast Table** to load the following page:

Figure 6-1 IPv4 Multicast Table

Multicast IP Address Table						
<input type="text"/> <input type="button" value="Q"/> All <input type="button" value="v"/>						<input type="button" value="Refresh"/>
Index	Multicast IP	VLAN ID	Source	Type	Forward Ports	
1	235.0.0.1	1	MVR	Dynamic		
2	235.0.0.2	1	MVR	Dynamic		

The multicast IP address table shows all valid Multicast IP-VLAN-Port entries:

Multicast IP	Displays the multicast IP address.
VLAN ID	Displays the ID of the VLAN the multicast group belongs to.
Source	Displays the source of the multicast entry. IGMP Snooping: The multicast entry is learned by IGMP Snooping. MVR: The multicast entry is learned by MVR.

Type	<p>Displays how the multicast entry is generated.</p> <p>Dynamic: The entry is dynamically learned. All the member ports are dynamically added to the multicast group.</p> <p>Static: The entry is manually added. All the member ports are manually added to the multicast group.</p> <p>Mix: The entry is dynamically learned (manually learned), and some of the member ports are manually added (dynamically added) to the multicast group.</p>
Forward Ports	Displays all ports in the multicast group, including router ports and member ports.

6.1.2 Viewing IPv4 Multicast Statistics on Each Port

Choose the menu **L2 FEATURES > Multicast > Multicast Info > IPv4 Multicast Statistics** to load the following page:

Figure 6-2 IPv4 Multicast Statistics

Auto Refresh

Auto Refresh:

Refresh Interval: seconds (3-300)

[Apply](#)

Port Statistics

UNIT1 | **LAGS**

[↻](#) Refresh

ID	Port	Query Packets	Report Packets (v1)	Report Packets (v2)	Report Packets (v3)	Leave Packets	Error Packets
1	Gi1/0/1	0	0	0	0	0	0
2	Gi1/0/2	0	0	0	0	0	0
3	Gi1/0/3	0	0	0	0	0	0
4	Gi1/0/4	0	0	0	0	0	0
5	Gi1/0/5	0	0	0	0	0	0
6	Gi1/0/6	0	0	0	0	0	0
7	Gi1/0/7	0	0	0	0	0	0
8	Gi1/0/8	0	0	0	0	0	0
9	Gi1/0/9	0	0	0	0	0	0
10	Gi1/0/10	0	0	0	0	0	0
Total: 54							

Follow these steps to view IPv4 multicast statistics on each port:

- 1) To get the real-time multicast statistics, enable **Auto Refresh**, or click **Refresh**.

Auto Refresh	With this option enabled, the switch will automatically refresh the traffic summary.
---------------------	--

Refresh Interval	After Auto Refresh is enabled, specify the time interval for the switch to refresh the traffic summary.
-------------------------	--

2) In the **Port Statistics** section, view IPv4 multicast statistics on each port.

Query Packets	Displays the number of query packets received by the port.
Report Packets (v1)	Displays the number of IGMPv1 report packets received by the port.
Report Packets (v2)	Displays the number of IGMPv2 report packets received by the port.
Report Packets (v3)	Displays the number of IGMPv3 report packets received by the port.
Leave Packets	Displays the number of leave packets received by the port.
Error Packets	Displays the number of error packets received by the port.

6.1.3 Viewing IPv6 Multicast Table

Choose the menu **L2 FEATURES > Multicast > Multicast Info > IPv6 Multicast Table** to load the following page:

Figure 6-3 IPv6 Multicast Table

Multicast IP Address Table						
<input type="text" value=""/>						Refresh
<input type="text" value=""/>						All
Index	Multicast IP	VLAN ID	Source	Type	Forward Ports	
No entries in this table.						
Total: 0						

The multicast IP address table shows all valid Multicast IP-VLAN-Port entries:

Multicast IP	Displays the multicast IP address.
VLAN ID	Displays the ID of the VLAN the multicast group belongs to.
Source	Displays the source of the multicast entry.
MLD Snooping: The multicast entry is learned by MLD Snooping.	

Type	<p>Displays how the multicast entry is generated.</p> <p>Dynamic: The entry is dynamically learned. All the member ports are dynamically added to the multicast group.</p> <p>Static: The entry is manually added. All the member ports are manually added to the multicast group.</p> <p>Mix: The entry is dynamically learned (manually learned), and some of the member ports are manually added (dynamically added) to the multicast group.</p>
Forward Port	All ports in the multicast group, including router ports and member ports.

6.1.4 Viewing IPv6 Multicast Statistics on Each Port

Choose the menu **L2 FEATURES > Multicast > Multicast Info > IPv6 Multicast Statistics** to load the following page:

Figure 6-4 IPv6 Multicast Statistics

Auto Refresh

Auto Refresh:

Refresh Interval: seconds (3-300)

[Apply](#)

Port Statistics

[Refresh](#)

UNIT1		LAGS				
ID	Port	Query Packets	Report Packets (v1)	Report Packets (v2)	Done Packets	Error Packets
1	Gi1/0/1	0	0	0	0	0
2	Gi1/0/2	0	0	0	0	0
3	Gi1/0/3	0	0	0	0	0
4	Gi1/0/4	0	0	0	0	0
5	Gi1/0/5	0	0	0	0	0
6	Gi1/0/6	0	0	0	0	0
7	Gi1/0/7	0	0	0	0	0
8	Gi1/0/8	0	0	0	0	0
9	Gi1/0/9	0	0	0	0	0
10	Gi1/0/10	0	0	0	0	0
Total: 54						

Follow these steps to view IPv6 multicast statistics on each port:

- 1) To get the real-time IPv6 multicast statistics, enable **Auto Refresh**, or click **Refresh**.

Auto Refresh	With this option enabled, the switch will automatically refresh the traffic summary.
---------------------	--

Refresh Interval	After Auto Refresh is enabled, specify the time interval for the switch to refresh the traffic summary.
------------------	--

2) In the **Port Statistics** section, view IPv6 multicast statistics on each port.

Query Packets	Displays the number of query packets received by the port.
Report Packets (v1)	Displays the number of MLDv1 packets received by the port.
Report Packets (v2)	Displays the number of MLDv2 packets received by the port.
Done Packets	Displays the number of done packets received by the port.
Error Packets	Displays the number of error packets received by the port.

6.2 Using the CLI

6.2.1 Viewing IPv4 Multicast Snooping Information

show ip igmp snooping groups [vlan *vlan-id*] [count | dynamic | dynamic count | static | static count]

Displays information of specific multicast group in all VLANs or in the specific VLAN.

count: Displays the number of multicast groups.

dynamic: Displays information of all dynamic multicast groups.

dynamic count: Displays the number of dynamic multicast groups.

static: Displays information of all static multicast groups.

static count: Displays the number of static multicast groups.

show ip igmp snooping interface [fastEthernet [*port-list*] | gigabitEthernet [*port-list*] | ten-gigabitEthernet [*port-list*]] packet-stat

Displays the packet statistics on specified ports or all ports.

clear ip igmp snooping statistics

Clear all statistics of all IGMP packets.

6.2.2 Viewing IPv6 Multicast Snooping Configurations

show ipv6 mld snooping groups [vlan *vlan-id*] [count | dynamic | dynamic count | static | static count]

Displays information of specific multicast group in all VLANs or in the specific VLAN.

count displays the number of multicast groups.

dynamic displays information of all dynamic multicast groups.

dynamic count displays the number of dynamic multicast groups.

static displays information of all static multicast groups.

static count displays the number of static multicast groups.

show ipv6 mld snooping interface [fastEthernet [*port-list*] | gigabitEthernet [*port-list*] | ten-gigabitEthernet [*port-list*]] packet-stat

Displays the packet statistics on specified ports or all ports.

clear ipv6 mld snooping statistics

Clear all statistics of all MLD packets.

7 PIM Configuration

7.1 Using the CLI

7.1.1 Configuring IP Multicast-routing Globally

Follow these steps to configure IP multicast-routing globally:

-
- | | | |
|--------|------------------|----------------------------------|
| Step 1 | configure | Enter global configuration mode. |
|--------|------------------|----------------------------------|
-
- | | | |
|--------|---|---|
| Step 2 | ip multicast-routing
no ip multicast-routing | Enable/Disable IP multicast-routing Globally. |
|--------|---|---|
-
- | | | |
|--------|------------|---------------------------------|
| Step 3 | end | Return to privileged EXEC mode. |
|--------|------------|---------------------------------|
-
- | | | |
|--------|---|--|
| Step 4 | copy running-config startup-config | Save the settings in the configuration file. |
|--------|---|--|
-

The following example shows how to enable ip multicast-routing globally.

```
Switch#configure
Switch(config)#ip multicast-routing
Switch(config)#end
Switch#copy running-config startup-config
```

7.1.2 Configuring IP PIM Globally

Follow these steps to configure IP PIM globally:

-
- | | | |
|--------|------------------|----------------------------------|
| Step 1 | configure | Enter global configuration mode. |
|--------|------------------|----------------------------------|
-
- | | | |
|--------|---|---------------------------------|
| Step 2 | ip pim dense-mode
no ip pim dense-mode | Enable/Disable IP PIM Globally. |
|--------|---|---------------------------------|
- dense-mode*: Enable PIM DM globally
-

Step 3 **end**
Return to privileged EXEC mode.

Step 4 **copy running-config startup-config**
Save the settings in the configuration file.

The following example shows how to enable PIM DM globally.

```
Switch#configure
Switch(config)#ip pim dense-mode
Switch(config)#end
Switch#copy running-config startup-config
```

7.1.3 Configuring IP PIM On Specified Port

Follow these steps to configure IP PIM on a specified port:

Step 1 **configure**
Enter global configuration mode.

Step 2 **interface {vlan vid | fastEthernet port | gigabitEthernet port | ten-gigabitEthernet port |
port-channel port-channel | range port-channel port-channel-id }**
Enter interface configuration mode.

Step 3 **ip pim**
 no ip pim
Enable/Disable IP PIM on the specified port.

Step 4 **end**
Return to privileged EXEC mode.

Step 5 **copy running-config startup-config**
Save the settings in the configuration file.

The following example shows how to enable PIM DM on port 2.

```
Switch#configure
Switch(config)# interface vlan 2
Switch(config-if)# ip pim
Switch(config)#end
Switch#copy running-config startup-config
```

7.1.4 Configuring IP PIM Hello-Interval

Follow these steps to configure the time interval for sending Hello messages on the interface:

Step 1	configure Enter global configuration mode.
Step 2	interface {vlan vid fastEthernet port gigabitEthernet port ten-gigabitEthernet port port-channel port-channel range port-channel port-channel-id } Enter interface configuration mode.
Step 3	ip pim hello-interval interval no ip pim hello-interval Configure the time interval for sending Hello messages on the interface. <i>interval:</i> The time interval for sending Hello messages, ranging from 1 to 18725 seconds. The default value is 30 seconds.
Step 4	end Return to privileged EXEC mode.
Step 5	copy running-config startup-config Save the settings in the configuration file.

The following example shows how to configure the interval for VLAN interface 2 to send Hello messages to 100 seconds.

```
Switch#configure
Switch(config)# interface vlan 2
Switch(config-if)# ip pim hello-interval 100
Switch(config)#end
Switch#copy running-config startup-config
```

7.1.5 Viewing IP Multicast Info

Follow these steps to view the global configuration information of IP multicast:

Step 1	configure Enter global configuration mode.
Step 2	show ip multicast view the global configuration information of IP multicast.
Step 3	end Return to privileged EXEC mode.

The following example shows how to view the global configuration information of IP multicast.

Switch#configure

Switch(config)# show ip multicast

```
Admin Mode..... Enabled
Protocol State..... Operational
Table Max Size..... 1024
Protocol..... No protocol enabled.
Multicast forwarding cache entry count..... 0
```

7.1.6 Viewing IP Mroute

Follow these steps to view the multicast routing table:

Step 1	configure Enter global configuration mode.
Step 2	show ip mroute { group ip-addr source ip-addr detail static [source source-ip] summary } group ip-addr: Multicast group IP address source ip-addr: Multicast source IP address detail: Displays detailed multicast routing table static [source source-ip]: Displays all static multicast routing entries or static multicast routing entries with a specified source IP address summary: Displays summary information of multicast routing entries
Step 3	end Return to privileged EXEC mode.

The following example shows how to view all multicast routing entries.

Switch#configure

Switch(config)# show ip mroute

7.1.7 Viewing IP PIM Interface Info

Follow these steps to view the IP PIM interface information:

Step 1	configure Enter global configuration mode.
--------	--

Step 2 **show ip pim interface { fastEthernet | gigabitEthernet | ten-gigabitEthernet port | port-channel [port-channel-list] | vlanid vlan-id }**

Displays the IP PIM interface information.

fastEthernet | gigabitEthernet | ten-gigabitEthernet: interface type

port: Port number

port-channel-list: Port channel list

vlan-id: VLAN interface ID, ranging from 1 to 4094.

Step 3 **end**

Return to privileged EXEC mode.

The following example shows how to view the information on PIM VLAN 2.

Switch#configure

Switch(config)# show ip pim interface vlan 2

Interface..... VLAN2

Mode..... None

Hello Interval (secs)..... 30

Join Prune Interval (secs)..... 60

DR Priority..... 1

BSR Border..... Disabled

7.1.8 Viewing IP PIM Neighbor Info

Follow these steps to view the IP PIM neighbor information:

Step 1 **configure**

Enter global configuration mode.

Step 2 **show ip pim neighbor { fastEthernet | gigabitEthernet | ten-gigabitEthernet port | vlanid vlan-id }**

Displays the IP PIM neighbor information.

fastEthernet | gigabitEthernet | ten-gigabitEthernet: interface type

port: Port number

vlan-id: VLAN interface ID, ranging from 1 to 4094.

Step 3 **end**

Return to privileged EXEC mode.

The following example shows how to view all PIM neighbor information.

```
Switch#configure
```

```
Switch(config)# show ip pim neighbor
```

7.1.9 Viewing IP PIM Statistic

Follow these steps to view the IP PIM statistic:

Step 1 **configure**

Enter global configuration mode.

Step 2 **show ip pim statistic { fastEthernet | gigabitEthernet | ten-gigabitEthernet port | vlanid
vlan-id }**

Displays the IP PIM statistic information.

fastEthernet | gigabitEthernet | ten-gigabitEthernet: interface type

port: Port number

vlan-id: VLAN interface ID, ranging from 1 to 4094.

Step 3 **end**

Return to privileged EXEC mode.

The following example shows how to view packet count information of all PIM interfaces.

```
Switch#configure
```

```
Switch(config)# show ip pim statistic
```

Rx - Packet Received in Protocol.

Tx - Packet Sent from Protocol.

8 Static Multicast-Routing Configuration

8.1 Using the CLI

8.1.1 Configuring Static Multicast-routing Entries

Follow these steps to add or modify static multicast routing entries globally:

Step 1 **configure**

Enter global configuration mode.

Step 2 **ip mroute { source-address } { mask } { rpf-address } { distance }**

no ip mroute { source-address } { mask }

Add/Modify static multicast routing entries globally or delete the specified static multicast routing entry.

source-address: IP address of the multicast source, in the format 192.168.0.1

mask: Subnet mask for the multicast source IP address

rpf-address: Specify the ingress interface of the RPF entry

distance: Management parameters of static multicast routing entries, ranging from 0 to 255. The smaller the value, the higher the priority. If the value of the static multicast route is smaller than the value of other RPF entries, the static multicast route takes effect. The default value is 1.

Step 3 **end**

Return to privileged EXEC mode.

Step 4 **copy running-config startup-config**

Save the settings in the configuration file.

The following example shows how to add a static multicast routing entry with the source address 192.168.0.1, the subnet mask 255.255.255.255, the incoming interface of the RPF entry 192/168.1.1, and the management parameter 1.

Switch#configure

Switch(config)#ip mroute 192.168.0.1 255.255.255.255 192.168.1.1 1

Switch(config)#end

Switch#copy running-config startup-config

8.1.2 Viewing IP Mroute Static Info

Follow these steps to view the IP mroute static information:

Step 1 **configure**
Enter global configuration mode.

Step 2 **show ip mroute static { source source-ip }**
View all static multicast routing entries.

The following example shows how to display all static multicast routing entries.

Switch#configure

Switch(config)#show ip mroute static

9 Layer 3 IGMP Configuration

9.1 Using the CLI

9.1.1 Configuring IP IGMP Globally

Follow these steps to configure IP IGMP globally:

Step 1	configure Enter global configuration mode.
Step 2	ip igmp Enable IGMP globally.
Step 3	ip igmp header-validation Enable IGMP header-validation globally.
Step 4	end Return to privileged EXEC mode.
Step 5	copy running-config startup-config Save the settings in the configuration file.

The following example shows how to configure IP IGMP globally.

```
Switch#configure
Switch(config)#ip igmp
Switch(config)#ip igmp header-validation
Switch(config)#end
Switch#copy running-config startup-config
```

9.1.2 Configuring IP IGMP On Ports

Follow these steps to configure IP IGMP on specified ports:

Step 1	configure Enter global configuration mode.
Step 2	interface {vlan vid fastEthernet port range fastEthernet port-list gigabitEthernet port range gigabitEthernet port-list ten-gigabitEthernet port range ten-gigabitEthernet port-list port-channel port-channel range port-channel port-channel-list } Enter interface configuration mode.

Step 3 **ip igmp version { 1 | 2 | 3 }**

Specify the IGMP version. The switch supports IGMPv1, IGMPv2 and IGMPv3.

1: The switch works as an IGMPv1 Snooping switch. It can only process IGMPv1 messages from the host. Messages of other versions are ignored.

2: The switch works as an IGMPv2 Snooping switch. It can process both IGMPv1 and IGMPv2 messages from the host. IGMPv3 messages are ignored.

3: The switch works as an IGMPv3 Snooping switch. It can process IGMPv1, IGMPv2 and IGMPv3 messages from the host.

Step 4 **ip igmp last-member-query-count count**

Configure the number of times special group query messages sent on the specified interface. The no command is used to restore the default value.

count: The number of times IGMP group-specific query messages are sent, ranging from 1-20. The default value is 2.

Step 5 **ip igmp last-member-query-interval interval**

Configure the time interval for sending special group query messages on the specified interface. The no command is used to restore the default value.

interval: The interval for sending IGMP group-specific query messages. The value range is 10-255 (1/10 second). The default value is 10 (1/10 second).

Step 6 **ip igmp query-interval interval**

Configure the IGMP general query interval on a specified interface. The no command is used to restore the default value.

interval: The time interval for sending IGMP general query messages on the specified interface. The value range is 1-3600 seconds. The default value is 125 seconds.

Step 7 **ip igmp query-max-response-time time**

Configure the maximum response time to IGMP general query messages on the specified interface. The no command is used to restore the default value.

time: The maximum response time for general group query messages on the specified interface, the value range is 10-255 (1/10 seconds), the default value is 100 (1/10 seconds)

Step 8 **ip igmp robustness robustness**

Configure the robustness coefficient on the specified interface. The no command is used to restore the default value.

robustness: Specify the IGMP robustness coefficient, the value range is 1-255, and the default value is 2.

Step 9 **ip igmp startup-query-interval interval**

Configure the time interval for sending initial query packets on the specified interface. The no command is used to restore the default value.

interval: The interval for sending IGMP initial query messages. The value range is 1-300 seconds. The default value is 31 seconds.

-
- Step 10 **ip igmp last-member-query-count count**
- Configure the number of initial query packets sent on the specified interface. The no command is used to restore the default value.
- interval*: The number of times IGMP initial query message is sent, the value range is 1-20, the default value is 2
-
- Step 11 **show ip igmp**
- Display basic IGMP information.
-
- Step 12 **show ip igmp groups {group-address } [detail]**
- Display information of all dynamic multicast groups or specified multicast groups
- group-address*: Multicast group address
- detail*: Detailed information of dynamic multicast group
-
- Step 13 **show ip igmp groups interface { fastEthernet | gigabitEthernet | ten-gigabitEthernet port | port-channel [port-channel-list] | detail }**
- Display all dynamic multicast group information on the specified port.
- fastEthernet | gigabitEthernet | ten-gigabitEthernet*: interface type
- port*: Port number
- port-channel-list*: Port channel list
- detail* : Detailed information of dynamic multicast group
-
- Step 14 **show ip igmp groups interface vlan vlan-id { detail }**
- Display all dynamic multicast group information on the specified VLAN interface.
- fastEthernet | gigabitEthernet | ten-gigabitEthernet*: interface type
- vlan-id*: VLAN port ID
- detail* : Detailed information of dynamic multicast group
-
- Step 15 **show ip igmp interface { fastEthernet | gigabitEthernet | ten-gigabitEthernet port | port-channel [port-channel-list] | statistic }**
- Display IGMP configuration information on a specified port.
- fastEthernet | gigabitEthernet | ten-gigabitEthernet*: interface type
- port*: Port number
- port-channel-list*: Port channel list
- statistic* : Statistics of IGMP packets received on the specified port
-
- Step 16 **show ip igmp interface vlan vlan-id { statistic }**
- Display IGMP configuration information on the specified VLAN interface.
- vlan-id*: VLAN port ID
- statistic* : Statistics of IGMP packets received on the specified port
-

Step 17 **end**
Return to privileged EXEC mode.

Step 18 **copy running-config startup-config**
Save the settings in the configuration file.

The following example shows how to enable IGMP on a specified port.

Switch#configure

Switch(config)#interface vlan 2

Switch(config-if)#ip igmp

Switch(config-if)#ip igmp version 3

Switch(config-if)#ip igmp last-member-query-count 3

Switch(config-if)#ip igmp last-member-query-interval 20

Switch(config-if)#ip igmp query-interval 50

Switch(config-if)#ip igmp query-max-response-time 50

Switch(config-if)#ip igmp robustness 3

Switch(config-if)#ip igmp query-interval 10

Switch(config-if)#ip igmp last-member-query-count 3

Switch(config-if)#ip igmp last-member-query-count 3

Switch(config-if)#show ip igmp

IGMP admin mode..... Disabled

IGMP header validation..... Disabled

IGMP INTERFACE STATUS

Interface Interface-Mode Operational-Status

VLAN1 Disabled Non-Operational

VLAN2 Enabled Non-Operational

Switch(config-if)#show ip igmp

Switch(config-if)#show ip igmp groups 224.0.2.40

Switch(config-if)#show ip igmp groups interface gigabitEthernet 1/0/1 detail

Switch(config-if)#show ip igmp groups interface vlan 1

IP Address..... 192.168.0.1
Subnet Mask..... 255.255.255.0
Interface Mode..... Disabled

Switch(config-if)#show ip igmp interface gigabitEthernet 1/0/1 statistic**Switch(config-if)#show ip igmp interface vlan 2**

Interface..... VLAN2
IP address..... 0.0.0.0
Subnet mask..... 0.0.0.0
IGMP admin mode..... Disabled
Interface Mode..... Enabled
IGMP Version..... 3
Query Interval (secs)..... 10
Query Max Response Time(1/10 th of a sec) 50
Robustness..... 3
Startup Query Interval (secs)..... 31
Startup Query Count..... 2
Last Member Query Interval (1/10 of a second)... 10
Last Member Query Count..... 3

Switch(config-if)#end**Switch#copy running-config startup-config**

10 Configuration Examples

10.1 Example for Configuring Basic IGMP Snooping

10.1.1 Network Requirements

Host B, Host C and Host D are in the same VLAN of the switch. All of them want to receive multicast streams sent to multicast group 225.1.1.1.

As shown in the following topology, Host B, Host C and Host D are connected to port 1/0/1, port 1/0/2 and port 1/0/3 respectively. Port 1/0/4 is the router port connected to the multicast querier.

Figure 10-1 Network Topology for Basic IGMP Snooping

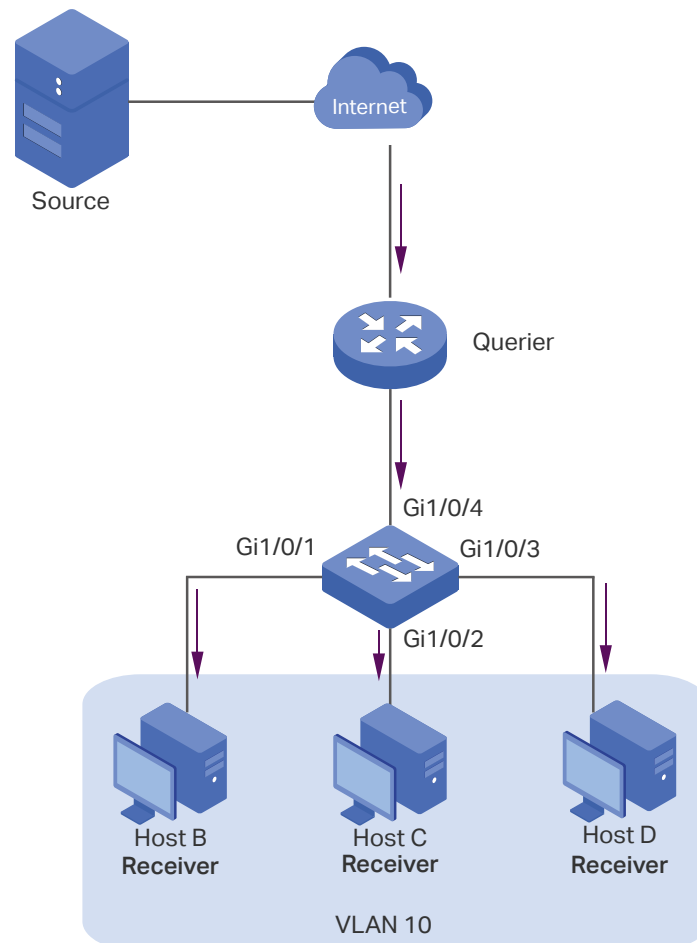

10.1.2 Configuration Scheme

- Add the three member ports and the router port to a VLAN and configure their PVIDs.
- Enable IGMP Snooping globally and in the VLAN.

- Enable IGMP Snooping on the ports.

Demonstrated with SG6654XHP, this section provides configuration procedures in two ways: using the GUI and using the CLI.

10.1.3 Using the GUI

- 1) Choose the menu **L2 FEATURES > VLAN > 802.1Q VLAN > VLAN Config** and click  Add to load the following page. Create VLAN 10 and add Untagged port 1/0/1-3 and Tagged port 1/0/4 to VLAN 10.

Figure 10-2 Create VLAN 10



The screenshot shows the 'VLAN Config' interface. At the top, the title is 'VLAN Config'. Below it, there are two input fields: 'VLAN ID' with the value '10' and a note '(2-4094, format: 2,4-5,8)', and 'VLAN Name' with the value 'VLAN 10' and a note '(1-16 characters)'. Both fields are highlighted with a red box. Below these is the 'Untagged Ports' section. A 'Port:' input field contains '1/0/1-3'. Below it is a grid of port icons for 'UNIT1' and 'LAGS'. Ports 1, 2, and 3 are highlighted with a red box and a blue 'Selected' icon. A 'Select All' checkbox is present. Below the grid are icons for 'Selected', 'Unselected', and 'Not Available'. The 'Tagged Ports' section has a 'Port:' input field containing '1/0/4'. Below it is another grid of port icons, with port 4 highlighted with a red box. At the bottom right, there are two buttons: 'Cancel' and 'Create', with the 'Create' button highlighted with a red box.

- 2) Choose the menu **L2 FEATURES > VLAN > 802.1Q VLAN > Port Config** to load the following page. Configure the PVID of port 1/0/1-4 as 10.

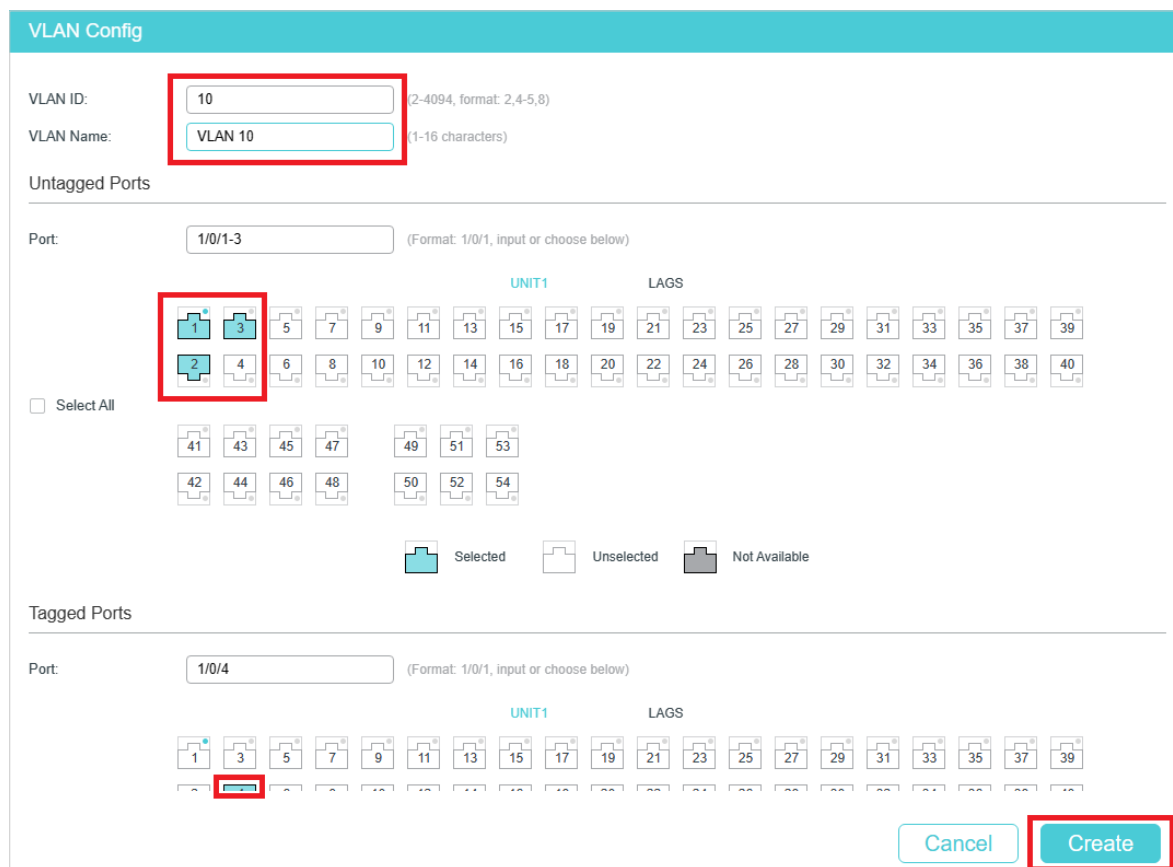
Figure 10-3 Configure PVID for the Ports

Port Config

UNIT1 LAGS

<input type="checkbox"/>	Port	PVID	Ingress Checking	Acceptable Frame Types	LAG	Details
<input checked="" type="checkbox"/>	1/0/1	10	Enabled	Admit All	---	Details
<input checked="" type="checkbox"/>	1/0/2	10	Enabled	Admit All	---	Details
<input checked="" type="checkbox"/>	1/0/3	10	Enabled	Admit All	---	Details
<input checked="" type="checkbox"/>	1/0/4	10	Enabled	Admit All	---	Details
<input type="checkbox"/>	1/0/5	1	Enabled	Admit All	---	Details
<input type="checkbox"/>	1/0/6	1	Enabled	Admit All	---	Details
<input type="checkbox"/>	1/0/7	1	Enabled	Admit All	---	Details
<input type="checkbox"/>	1/0/8	1	Enabled	Admit All	---	Details
<input type="checkbox"/>	1/0/9	1	Enabled	Admit All	---	Details
<input type="checkbox"/>	1/0/10	1	Enabled	Admit All	---	Details

Total: 54 4 entries selected. Cancel Apply

- Choose the menu **L2 FEATURES > Multicast > IGMP Snooping > Global Config** to load the following page. In the **Global Config** section, enable IGMP Snooping globally. Configure the IGMP version as v3 so that the switch can process IGMP messages of all versions. Then click **Apply**.

Figure 10-4 Configure IGMP Snooping Globally

Global Config

IGMP Snooping: Enable

IGMP Version: v1 v2 v3

Unknown Multicast Groups: Forward Discard

Header Validation: Enable

Apply

IGMP VLAN Config

VLAN ID	IGMP Snooping Status	Fast Leave	Report Suppression	IGMP Snooping Querier	Dynamic Router Ports	Static Router Ports	Forbidden Router Ports	Operation
1	Disabled	Disabled	Disabled	Disabled				
10	Disabled	Disabled	Disabled	Disabled				

Total: 2

- In the **IGMP VLAN Config** section, click in VLAN 10 to load the following page. Enable IGMP Snooping for VLAN 10.

Figure 10-5 Enable IGMP Snooping for VLAN 10

- 5) Choose the menu **L2 FEATURES > Multicast > IGMP Snooping > Port Config** to load the following page. Enable IGMP Snooping for ports 1/0/1-4.

Figure 10-6 Enable IGMP Snooping for the Ports

UNIT1	LAGS	Port	IGMP Snooping	Fast Leave	LAG
<input checked="" type="checkbox"/>		Gi1/0/1	Enabled	Disabled	---
<input checked="" type="checkbox"/>		Gi1/0/2	Enabled	Enabled	---
<input checked="" type="checkbox"/>		Gi1/0/3	Enabled	Disabled	---
<input checked="" type="checkbox"/>		Gi1/0/4	Enabled	Disabled	---
<input type="checkbox"/>		Gi1/0/5	Enabled	Disabled	---
<input type="checkbox"/>		Gi1/0/6	Enabled	Disabled	---
<input type="checkbox"/>		Gi1/0/7	Enabled	Disabled	---
<input type="checkbox"/>		Gi1/0/8	Enabled	Disabled	---
<input type="checkbox"/>		Gi1/0/9	Enabled	Disabled	---
<input type="checkbox"/>		Gi1/0/10	Enabled	Disabled	---

- 6) Click Save to save the settings.

10.1.4 Using the CLI

- 1) Create VLAN 10.

```
Switch#configure
```

```
Switch(config)#vlan 10
```

```
Switch(config-vlan)#name vlan10
```

```
Switch(config-vlan)#exit
```

- 2) Add port 1/0/1-3 to VLAN 10 and set the link type as untagged. Add port 1/0/4 to VLAN 10 and set the link type as tagged.

```
Switch(config)#interface range gigabitEthernet 1/0/1-3
```

```
Switch(config-if-range)#switchport general allowed vlan 10 untagged
```

```
Switch(config-if-range)#exit
```

```
Switch(config)#interface gigabitEthernet 1/0/4
```

```
Switch(config-if)#switchport general allowed vlan 10 tagged
```

```
Switch(config-if)#exit
```

- 3) Set the PVID of port 1/0/1-4 as 10.

```
Switch(config)#interface range gigabitEthernet 1/0/1-4
```

```
Switch(config-if-range)#switchport pvid 10
```

```
Switch(config-if-range)#exit
```

- 4) Enable IGMP Snooping globally.

```
Switch(config)#ip igmp snooping
```

- 5) Enable IGMP Snooping in VLAN 10.

```
Switch(config)#ip igmp snooping vlan-config 10
```

- 6) Enable IGMP Snooping on port 1/0/1-4.

```
Switch(config)#interface range gigabitEthernet 1/0/1-4
```

```
Switch(config-if-range)#ip igmp snooping
```

```
Switch(config-if-range)#exit
```

- 7) Save the settings.

```
Switch(config)#end
```

```
Switch#copy running-config startup-config
```

Verify the Configurations

Show members in the VLAN:

```
Switch(config)#show vlan brief
```

VLAN	Name	Status	Ports
1	System-VLAN	active	Gi1/0/1, Gi1/0/2, Gi1/0/3, Gi1/0/4, Gi1/0/5, Gi1/0/6, Gi1/0/7, Gi1/0/8, ...

```
10      vlan10      active      Gi1/0/1, Gi1/0/2, Gi1/0/3, Gi1/0/4
```

Show status of IGMP Snooping globally, on the ports and in the VLAN:

```
Switch(config)#show ip igmp snooping
```

```
IGMP Snooping      :Enable
```

```
IGMP Version      :V3
```

```
Header Validation  :Disable
```

```
Global Authentication Accounting :Disable
```

```
Enable Port : Gi1/0/1-4
```

```
Enable VLAN:10
```

10.2 Example for Configuring MVR

10.2.1 Network Requirements

Host B, Host C and Host D are in three different VLANs of the switch. All of them want to receive multicast streams sent to multicast group 225.1.1.1.

10.2.2 Network Topology

As shown in the following network topology, Host B, Host C and Host D are connected to port 1/0/1, port 1/0/2 and port 1/0/3 respectively. Port 1/0/1, port 1/0/2 and port 1/0/3 belong to VLAN 10, VLAN 20 and VLAN 30 respectively. Port 1/0/4 is connected to the multicast network in the upper layer network.

Figure 10-7 Network Topology for Multicast VLAN

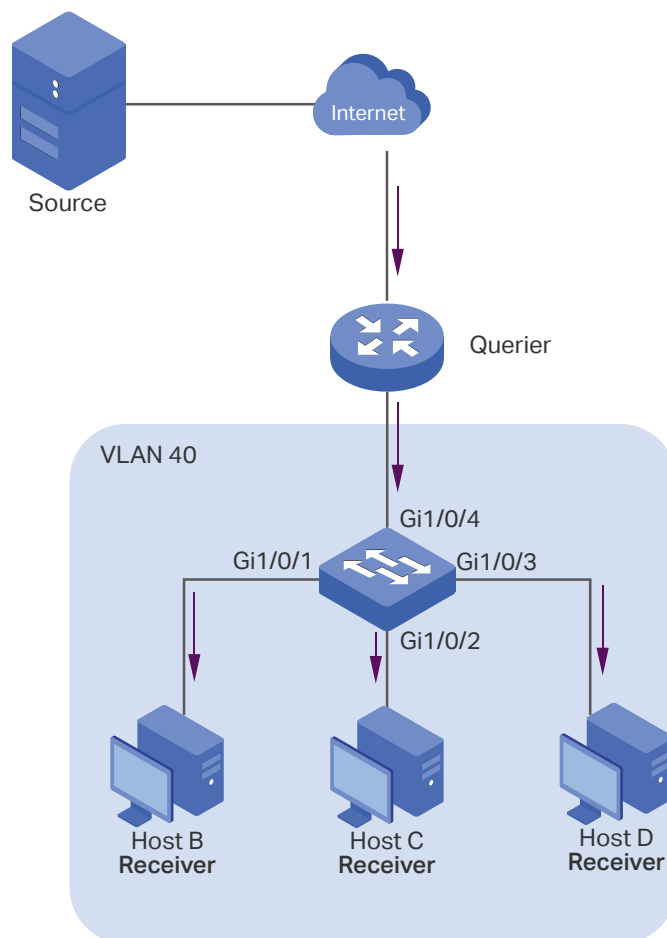

10.2.3 Configuration Scheme

As the hosts are in different VLANs, in IGMP Snooping, the Querier need to duplicate multicast streams for hosts in each VLAN. To avoid duplication of multicast streams being sent between Querier and the switch, you can configure MVR on the switch.

The switch can work in either MVR compatible mode or MVR dynamic mode. When in compatible mode, remember to statically configure the Querier to transmit the streams of multicast group 225.1.1.1 to the switch via the multicast VLAN. Here we take the MVR dynamic mode as an example.

Demonstrated with SG6654XHP, this section provides configuration procedures in two ways: using the GUI and using the CLI.

10.2.4 Using the GUI

- 1) Add port 1/0/1-3 to VLAN 10, VLAN 20 and VLAN 30 as Untagged ports respectively, and configure the PVID of port 1/0/1 as 10, port 1/0/2 as 20, port 1/0/3 as 30. Make sure port 1/0/1-3 only belong to VLAN 10, VLAN 20 and VLAN 30 respectively. For details, refer to [Configuring 802.1Q VLAN](#).

Figure 10-8 VLAN Configurations for Port 1/0/1-3

VLAN Config

VLAN ID

<input type="checkbox"/>	VLAN ID	VLAN Name	Members	Operation
<input type="checkbox"/>	1	System-VLAN	1/0/4-28	<input type="button" value="Edit"/> <input type="button" value="Delete"/>
<input type="checkbox"/>	10	VLAN10	1/0/1	<input type="button" value="Edit"/> <input type="button" value="Delete"/>
<input type="checkbox"/>	20	VLAN20	1/0/2	<input type="button" value="Edit"/> <input type="button" value="Delete"/>
<input type="checkbox"/>	30	VLAN30	1/0/3	<input type="button" value="Edit"/> <input type="button" value="Delete"/>

Total: 4

Figure 10-9 PVID for Port 1/0/1-3

Port Config

<input type="checkbox"/>	Port	PVID	Ingress Checking	Acceptable Frame Types	LAG	Detail
<input type="checkbox"/>	1/0/1	10	Enabled	Admit All	---	Detail
<input type="checkbox"/>	1/0/2	20	Enabled	Admit All	---	Detail
<input type="checkbox"/>	1/0/3	30	Enabled	Admit All	---	Detail
<input type="checkbox"/>	1/0/4	1	Enabled	Admit All	---	Detail
<input type="checkbox"/>	1/0/5	1	Enabled	Admit All	---	Detail
<input type="checkbox"/>	1/0/6	1	Enabled	Admit All	---	Detail
<input type="checkbox"/>	1/0/7	1	Enabled	Admit All	---	Detail
<input type="checkbox"/>	1/0/8	1	Enabled	Admit All	---	Detail
<input type="checkbox"/>	1/0/9	1	Enabled	Admit All	---	Detail
<input type="checkbox"/>	1/0/10	1	Enabled	Admit All	---	Detail

Total: 28

- Choose the menu **L2 FEATURES > VLAN > 802.1Q VLAN > VLAN Config** and click  **Add** to load the following page. Create VLAN 40 and add port 1/0/4 to the VLAN as Tagged port.

Figure 10-10 Create Multicast VLAN

VLAN Config

VLAN ID: (2-4094, format: 2,4-5,8)

VLAN Name: (1-16 characters)

Untagged Ports

Port: (Format: 1/0/1, input or choose below)

UNIT1 LAGS

1 3 5 7 9 11 13 15 17 19 21 23 25 27 29 31 33 35 37 39

2 4 6 8 10 12 14 16 18 20 22 24 26 28 30 32 34 36 38 40

Select All

41 43 45 47 49 51 53

42 44 46 48 50 52 54

Selected Unselected Not Available

Tagged Ports

Port: (Format: 1/0/1, input or choose below)

UNIT1 LAGS

1 3 5 7 9 11 13 15 17 19 21 23 25 27 29 31 33 35 37 39

41 43 45 47 49 51 53

42 44 46 48 50 52 54

- 3) Choose the menu **L2 FEATURES > Multicast > MVR > MVR Config** to load the following page. Enable MVR globally, and configure the MVR mode as **Dynamic**, multicast VLAN ID as **40**.

Figure 10-11 Configure MVR Globally

MVR Config

MVR: Enable

MVR Mode: Compatible Dynamic

Multicast VLAN ID: (1-4094)

Query Response Time: tenths of a second (1-100)

Maximum Multicast Groups: 4093

Current Multicast Groups: 0

- 4) Choose the menu **L2 FEATURES > Multicast > MVR > MVR Group Config** and click **+ Add** to load the following page. Add multicast group 225.1.1.1 to MVR.

Figure 10-12 Add Multicast Group to MVR

- 5) Choose the menu **L2 FEATURES > Multicast > MVR > Port Config** to load the following page. Enable MVR for port 1/0/1-4. Configure port 1/0/1-3 as **Receiver** ports and port 1/0/4 as **Source** port.

Figure 10-13 Configure MVR for the Ports

Port	Mode	Type	Status	Fast Leave
Gi1/0/1	Enable	Receiver	Active/InVLAN	Disable
Gi1/0/2	Enable	Receiver	Inactive/InVLAN	Disable
Gi1/0/3	Enable	Receiver	Inactive/InVLAN	Disable
Gi1/0/4	Enable	Source	Inactive/InVLAN	Disable
Gi1/0/5	Disable	None	Inactive/InVLAN	Disable
Gi1/0/6	Disable	None	Inactive/InVLAN	Disable
Gi1/0/7	Disable	None	Inactive/InVLAN	Disable
Gi1/0/8	Disable	None	Inactive/InVLAN	Disable
Gi1/0/9	Disable	None	Inactive/InVLAN	Disable
Gi1/0/10	Disable	None	Inactive/InVLAN	Disable

- 6) Click  Save to save the settings.

10.2.5 Using the CLI

- 1) Create VLAN 10, VLAN 20, VLAN 30 and VLAN 40.

```
Switch#configure
```

```
Switch(config)#vlan 10,20,30,40
```

```
Switch(config-vlan)#exit
```

- 2) Add port 1/0/1-3 to VLAN 10, VLAN 20 and VLAN 30 as untagged ports respectively, and configure the PVID of port 1/0/1 as 10, port 1/0/2 as 20, port 1/0/3 as 30. Add port 1/0/4 to VLAN 40 as tagged port and configure the PVID as of port 1/0/4 as 40.

```
Switch(config)#interface gigabitEthernet 1/0/1
```

```
Switch(config-if)#switchport general allowed vlan 10 untagged
```

```

Switch(config-if)#switchport pvid 10
Switch(config-if)#exit
Switch(config)#interface gigabitEthernet 1/0/2
Switch(config-if)#switchport general allowed vlan 20 untagged
Switch(config-if)#switchport pvid 20
Switch(config-if)#exit
Switch(config)#interface gigabitEthernet 1/0/3
Switch(config-if)#switchport general allowed vlan 30 untagged
Switch(config-if)#switchport pvid 30
Switch(config-if)#exit
Switch(config)#interface gigabitEthernet 1/0/4
Switch(config-if)#switchport general allowed vlan 40 tagged
Switch(config-if)#switchport pvid 40
Switch(config-if)#exit

```

- 3) Check whether port1/0/1-3 only belong to VLAN 10, VLAN 20 and VLAN 30 respectively. If not, delete them from the other VLANs. By default, all ports are in VLAN 1, so you need to delete them from VLAN 1.

```
Switch(config)#show vlan brief
```

VLAN	Name	Status	Ports
-----	-----	-----	-----
1	System-VLAN	active	Gi1/0/1, Gi1/0/2, Gi1/0/3, Gi1/0/4, Gi1/0/5, Gi1/0/6, Gi1/0/7, Gi1/0/8, ...
10	VLAN10	active	Gi1/0/1
20	VLAN20	active	Gi1/0/2
30	VLAN30	active	Gi1/0/3
40	VLAN40	active	Gi1/0/4

```

Switch(config)#interface range gigabitEthernet 1/0/1-3
Switch(config-if-range)#no switchport general allowed vlan 1
Switch(config-if-range)#exit

```

- 4) Enable MVR globally, and configure the MVR mode as **Dynamic**, multicast VLAN ID as **40**. Add multicast group 225.1.1.1 to MVR.

```
Switch(config)#mvr
Switch(config)#mvr mode dynamic
Switch(config)#mvr vlan 40
Switch(config)#mvr group 225.1.1.1 1
```

- 5) Enable MVR for port 1/0/1-4. Configure port 1/0/1-3 as **Receiver** ports and port 1/0/4 as **Source** port.

```
Switch(config)#interface range gigabitEthernet 1/0/1-3
Switch(config-if-range)#mvr
Switch(config-if-range)#mvr type receiver
Switch(config-if-range)#exit
Switch(config)#interface gigabitEthernet 1/0/4
Switch(config-if)#mvr
Switch(config-if)#mvr type source
Switch(config-if)#exit
```

- 6) Save the settings.

```
Switch(config)#end
Switch#copy running-config startup-config
```

Verify the Configurations

Show the brief information of all VLANs:

```
Switch(config)#show vlan brief
```

VLAN	Name	Status	Ports
1	System-VLAN	active	Gi1/0/4, Gi1/0/5, Gi1/0/6, Gi1/0/7, ...
10	VLAN10	active	Gi1/0/1
20	VLAN20	active	Gi1/0/2
30	VLAN30	active	Gi1/0/3
40	VLAN40	active	Gi1/0/4

Show the brief information of MVR:

```
Switch(config)#show mvr
```

```
MVR :Enable
```

```

MVR Multicast Vlan           :40
MVR Max Multicast Groups     :511
MVR Current Multicast Groups :1
MVR Global Query Response Time :5 (tenths of sec)
MVR Mode Type                :Dynamic

```

Show the membership of MVR groups:

```
Switch(config)#show mvr members
```

MVR Group IP	Status	Members
-----	-----	-----
225.1.1.1	active	Gi1/0/4

10.3 Example for Configuring Unknown Multicast and Fast Leave

10.3.1 Network Requirement

A user experiences lag when he is changing channel on his IPTV. He wants solutions to this problem. As shown in the following network topology, port 1/0/4 on the switch is connected to the upper layer network, and port 1/0/2 is connected to Host B.

Figure 10-14 Network Topology for Unknow Multicast and Fast Leave

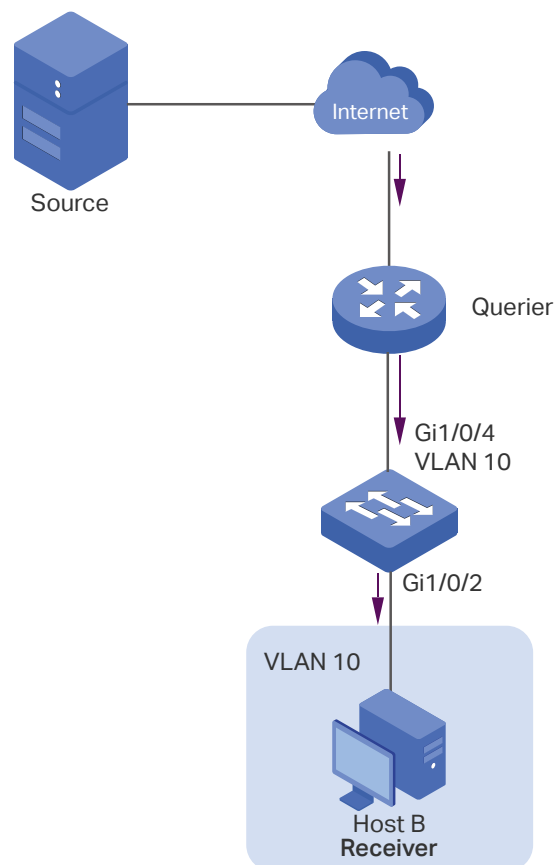

10.3.2 Configuration Scheme

After the channel is changed, the client (Host B) still receives irrelevant multicast data, the data from the previous channel and possibly other unknown multicast data, which increases the network load and results in network congestion.

To avoid Host B from receiving irrelevant multicast data, you can enable Fast Leave on port 1/0/2 and configure the switch to discard unknown multicast data. To change channel, Host B sends a leave message about leaving the previous channel. With Fast Leave enabled on port 1/0/2, the switch will then drop multicast data from the previous channel, which ensures that Host B only receives multicast data from the new channel and that the multicast network is unimpeded.

Demonstrated with SG6654XHP, this section provides configuration procedures in two ways: using the GUI and using the CLI.

10.3.3 Using the GUI

- 1) Create VLAN 10. Add port 1/0/4 to the VLAN as untagged port and port 1/0/5 as tagged port. Configure the PVID of the two ports as 10. For details, refer to [Configuring 802.1Q VLAN](#).
- 2) Choose the menu **L2 FEATURES > Multicast > IGMP Snooping > Global Config** to load the following page. In the **Global Config** section, enable IGMP Snooping globally and configure Unknown Multicast Groups as **Discard**.

Figure 10-15 Configure IGMP Snooping Globally

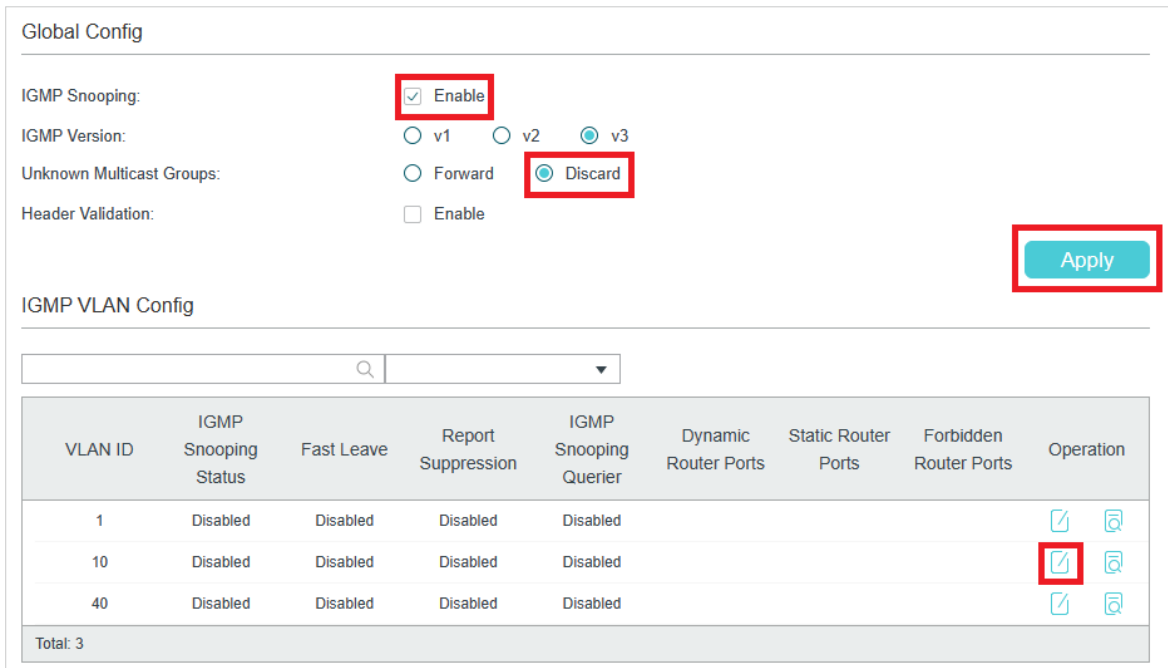

- 3) In the **IGMP VLAN Config** section, click in VLAN 10 to load the following page. Enable IGMP Snooping for VLAN 10 and click **Save**.

Figure 10-16 Enable IGMP Snooping for VLAN 10

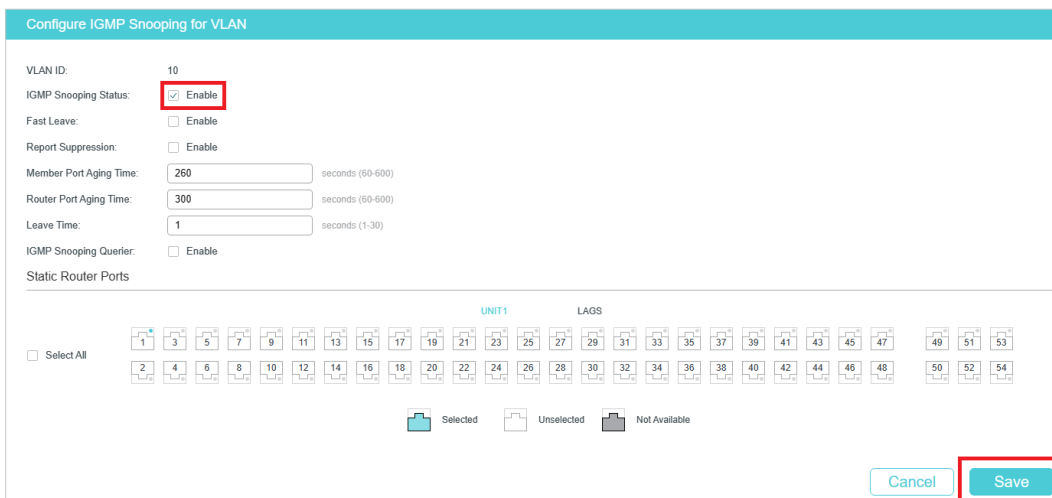

- 4) Choose the menu **L2 FEATURES > Multicast > IGMP Snooping > Port Config** to load the following page. Enable IGMP Snooping on port 1/0/2 and port 1/0/4 and enable Fast Leave on port 1/0/2.

Figure 10-17 Configure IGMP Snooping on Ports

Port Config				
UNIT1		LAGS		
<input type="checkbox"/>	Port	IGMP Snooping	Fast Leave	LAG
<input type="checkbox"/>	Gi1/0/1	Enabled	Disabled	---
<input type="checkbox"/>	Gi1/0/2	Enabled	Enabled	---
<input type="checkbox"/>	Gi1/0/3	Enabled	Disabled	---
<input type="checkbox"/>	Gi1/0/4	Enabled	Disabled	---
<input type="checkbox"/>	Gi1/0/5	Enabled	Disabled	---
<input type="checkbox"/>	Gi1/0/6	Enabled	Disabled	---
<input type="checkbox"/>	Gi1/0/7	Enabled	Disabled	---
<input type="checkbox"/>	Gi1/0/8	Enabled	Disabled	---
<input type="checkbox"/>	Gi1/0/9	Enabled	Disabled	---
<input type="checkbox"/>	Gi1/0/10	Enabled	Disabled	---
Total: 54				

- 5) Click  Save to save the settings.

10.3.4 Using the CLI

- 1) Enable IGMP Snooping and MLD Snooping globally.

```
Switch#configure
```

```
Switch(config)#ip igmp snooping
```

```
Switch(config)#ipv6 mld snooping
```

- 2) Configure Unknown Multicast Groups as Discard globally.

```
Switch(config)#ip igmp snooping drop-unknown
```

- 3) Enable IGMP Snooping on port 1/0/2 and enable Fast Leave. On port 1/0/4, enable IGMP Snooping.

```
Switch(config)#interface gigabitEthernet 1/0/2
```

```
Switch(config-if)#ip igmp snooping
```

```
Switch(config-if)#ip igmp snooping immediate-leave
```

```
Switch(config-if)#exit
```

```
Switch(config)#interface gigabitEthernet 1/0/4
```

```
Switch(config-if)#ip igmp snooping
```

```
Switch(config-if)#exit
```

- 4) Enable IGMP Snooping in VLAN 10.

```
Switch(config)#ip igmp snooping vlan-config 10
```

- 5) Save the settings.

```
Switch(config)#end
Switch#copy running-config startup-config
```

Verify the Configurations

Show global settings of IGMP Snooping:

```
Switch(config)#show ip igmp snooping
```

```
IGMP Snooping           :Enable
```

```
IGMP Version             :V3
```

```
Unknown Multicast       :Discard
```

...

```
Enable Port: Gi1/0/1-28
```

```
Enable VLAN:10
```

Show settings of IGMP Snooping on port 1/0/2:

```
Switch(config)#show ip igmp snooping interface gigabitEthernet 1/0/2 basic-config
```

```
Port      IGMP-Snooping      Fast-Leave
```

```
-----
```

```
Gi1/0/2  enable          enable
```

10.4 Example for Configuring Multicast Filtering

10.4.1 Network Requirements

Host B, Host C and Host D are in the same subnet. Host C and Host D only receive multicast data sent to 225.0.0.1, while Host B receives all multicast data except the one sent from 225.0.0.2.

10.4.2 Configuration Scheme

With the functions for managing multicast groups, whitelist and blacklist mechanism (profile binding), the switch can only allow specific member ports to join specific multicast groups or disallow specific member ports to join specific multicast groups. You can achieve this filtering function by creating a profile and binding it to the corresponding member port.

10.4.3 Network Topology

As shown in the following network topology, Host B is connected to port 1/0/1, Host C is connected to port 1/0/2 and Host D is connected to port 1/0/3. They are all in VLAN 10.

Figure 10-18 Network Topology for Multicast Filtering

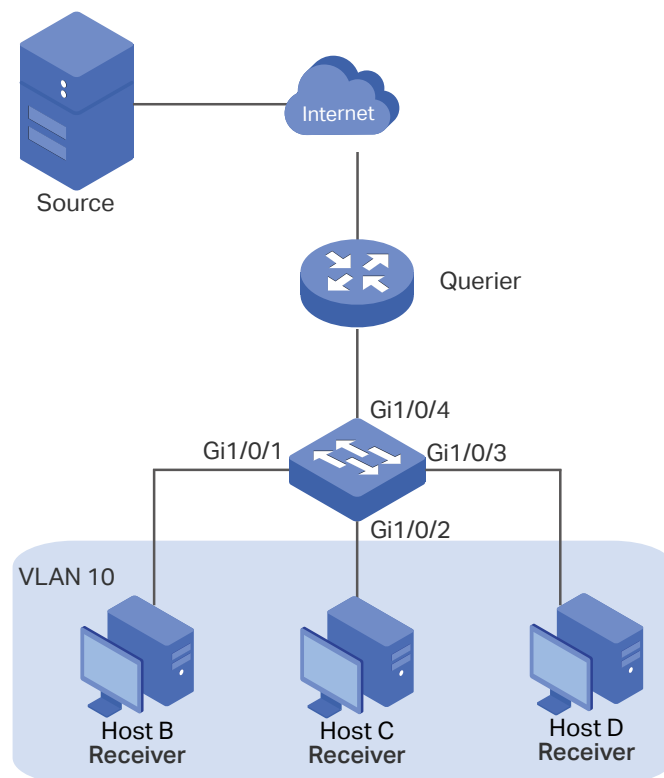

Demonstrated with SG6654XHP, this section provides configuration procedures in two ways: using the GUI and using the CLI.

10.4.4 Using the GUI

- 1) Create VLAN 10. Add port 1/0/1-3 to the VLAN as untagged port and port 1/0/4 as tagged port. Configure the PVID of the four ports as 10. For details, refer to [Configuring 802.1Q VLAN](#).
- 2) Choose the menu **L2 FEATURES > Multicast > IGMP Snooping > Global Config** to load the following page. In the **Global Config** section, enable IGMP Snooping globally.

Figure 10-19 Enable IGMP Snooping Globally

Global Config

IGMP Snooping: Enable

IGMP Version: v1 v2 v3

Unknown Multicast Groups: Forward Discard

Header Validation: Enable

Apply

IGMP VLAN Config

VLAN ID	IGMP Snooping Status	Fast Leave	Report Suppression	IGMP Snooping Querier	Dynamic Router Ports	Static Router Ports	Forbidden Router Ports	Operation
1	Disabled	Disabled	Disabled	Disabled				
10	Disabled	Disabled	Disabled	Disabled				
Total: 2								

- 3) In the **IGMP VLAN Config** section, click in VLAN 10 to load the following page. Enable IGMP Snooping for VLAN 10.

Figure 10-20 Enable IGMP Snooping for VLAN 10

Configure IGMP Snooping for VLAN

VLAN ID: 10

IGMP Snooping Status: Enable

Fast Leave: Enable

Report Suppression: Enable

Member Port Aging Time: seconds (60-600)

Router Port Aging Time: seconds (60-600)

Leave Time: seconds (1-30)

IGMP Snooping Querier: Enable

Static Router Ports

Select All

UNIT1
LAGS

1
2

3
4

5
6

7
8

9
10

11
12

13
14

15
16

17
18

19
20

21
22

23
24

25
26

27
28

29
30

31
32

33
34

35
36

37
38

39
40

41
42

43
44

45
46

47
48

49
50

51
52

53
54

Selected
 Unselected
 Not Available

Cancel
Save

- 4) Choose the menu **L2 FEATURES > Multicast > IGMP Snooping > Port Config** to load the following page.

Figure 10-21 Enable IGMP Snooping on the Port

Port Config

UNIT1 LAGS

<input type="checkbox"/>	Port	IGMP Snooping	Fast Leave	LAG
<input checked="" type="checkbox"/>	Gi1/0/1	Enabled	Disabled	---
<input checked="" type="checkbox"/>	Gi1/0/2	Enabled	Enabled	---
<input checked="" type="checkbox"/>	Gi1/0/3	Enabled	Disabled	---
<input checked="" type="checkbox"/>	Gi1/0/4	Enabled	Disabled	---
<input type="checkbox"/>	Gi1/0/5	Enabled	Disabled	---
<input type="checkbox"/>	Gi1/0/6	Enabled	Disabled	---
<input type="checkbox"/>	Gi1/0/7	Enabled	Disabled	---
<input type="checkbox"/>	Gi1/0/8	Enabled	Disabled	---
<input type="checkbox"/>	Gi1/0/9	Enabled	Disabled	---
<input type="checkbox"/>	Gi1/0/10	Enabled	Disabled	---

Total: 54 4 entries selected. Cancel Apply

- 5) Choose the menu **L2 FEATURES > Multicast > Multicast Filtering > IPv4 Profile** and click **+ Add** to load the following page. Create Profile 1, specify the mode as **Permit**, bind the profile to port 1/0/2-3, and specify the filtering multicast IP address as 225.0.0.1. Then click **Back** to return to the **IPv4 Profile Table** page.

Figure 10-22 Configure Filtering Profile for Host C and Host D

General Config

Profile ID: (1-999)

Mode: Permit Deny

IP-Range

+ Add - Delete

<input type="checkbox"/>	Index	Start IP Address	End IP Address	Operation
<input type="checkbox"/>	0	225.0.0.1	225.0.0.1	

Total: 0

Bind Ports

UNIT1

LAGS

Selected
 Unselected
 Not Available

- 6) Click Add again to load the following page. Create Profile 2, specify the mode as **Deny**, bind the profile to port 1/0/1, and specify the filtering multicast IP address as 225.0.0.2.

Figure 10-23 Configure Filtering Profile for Host B

General Config

Profile ID: (1-999)

Mode: Permit Deny

IP-Range

+ Add - Delete

<input type="checkbox"/>	Index	Start IP Address	End IP Address	Operation
<input type="checkbox"/>	0	225.0.0.2	225.0.0.2	

Total: 0

Bind Ports

UNIT1 LAGS

1

3

5

7

9

11

13

15

17

19

21

23

25

27

29

31

33

35

2

4

6

8

10

12

14

16

18

20

22

24

26

28

30

32

34

36

37

39

41

43

45

47

49

51

53

38

40

42

44

46

48

50

52

54

Selected
 Unselected
 Not Available

- 7) Click Save to save the settings.

10.4.5 Using the CLI

- 1) Create VLAN 10.

```
Switch#configure
```

```
Switch(config)#vlan 10
```

```
Switch(config-vlan)#name vlan10
```

```
Switch(config-vlan)#exit
```

- 2) Add port 1/0/1-3 to VLAN 10 and set the link type as untagged. Add port 1/0/4 to VLAN 10 and set the link type as tagged.

```
Switch(config)#interface range gigabitEthernet 1/0/1-3
```

```
Switch(config-if-range)#switchport general allowed vlan 10 untagged
```

```
Switch(config-if-range)#exit
```

```
Switch(config)#interface gigabitEthernet 1/0/4
```

```
Switch(config-if)#switchport general allowed vlan 10 tagged
```

```
Switch(config-if)#exit
```

- 3) Set the PVID of port 1/0/1-4 as 10.

```
Switch(config)#interface range gigabitEthernet 1/0/1-4
```

```
Switch(config-if-range)#switchport pvid 10
```

```
Switch(config-if-range)#exit
```

- 4) Enable IGMP Snooping Globally.

```
Switch(config)#ip igmp snooping
```

- 5) Enable IGMP Snooping in VLAN 10.

```
Switch(config)#ip igmp snooping vlan-config 10
```

- 6) Enable IGMP Snooping on port 1/0/1-4.

```
Switch(config)#interface range gigabitEthernet 1/0/1-4
```

```
Switch(config-if-range)#ip igmp snooping
```

```
Switch(config-if-range)#exit
```

- 7) Create Profile 1, configure the mode as permit, and add an IP range with both start IP and end IP being 225.0.0.1.

```
Switch(config)#ip igmp profile 1
```

```
Switch(config-igmp-profile)#permit
```

```
Switch(config-igmp-profile)#range 225.0.0.1 225.0.0.1
```

```
Switch(config-igmp-profile)#exit
```

- 8) Bind Profile 1 to Port 1/0/2 and Port 1/10/3.

```
Switch(config)#interface range gigabitEthernet 1/0/2-3
```

```
Switch(config-if-range)#ip igmp filter 1
```

```
Switch(config-if-range)#exit
```

- 9) Create Profile 2, configure the mode as deny, and add an IP range with both start IP and end IP being 225.0.0.2.

```
Switch(config)#ip igmp profile 2
```

```
Switch(config-igmp-profile)#deny
```

```
Switch(config-igmp-profile)#range 225.0.0.2 225.0.0.2
```

```
Switch(config-igmp-profile)#exit
```

- 10) Bind Profile 2 to Port 1/0/1.

```
Switch(config)#interface gigabitEthernet 1/0/1
```

```
Switch(config-if)#ip igmp filter 2
```

```
Switch(config-if)#exit
```

11) Save the settings.

```
Switch(config)#end
```

```
Switch#copy running-config startup-config
```

Verify the Configurations

Show global settings of IGMP Snooping:

```
Switch(config)#show ip igmp snooping
```

```
IGMP Snooping           :Enable
```

```
IGMP Version             :V3
```

```
...
```

```
Enable Port:Gi1/0/1-4
```

```
Enable VLAN:10
```

Show all profile bindings:

```
Switch(config)#show ip igmp profile
```

```
IGMP Profile 1
```

```
  permit
```

```
  range 225.0.0.1 225.0.0.1
```

```
  Binding Port(s)
```

```
    Gi1/0/2-3
```

```
IGMP Profile 2
```

```
  deny
```

```
  range 225.0.0.2 225.0.0.2
```

```
  Binding Port(s)
```

```
    Gi1/0/1
```

11 Appendix: Default Parameters

11.1 Default Parameters for IGMP Snooping

Table 11-1 Default Parameters of IGMP Snooping

Function	Parameter	Default Setting
Global Settings of IGMP Snooping	IGMP Snooping	Disabled
	IGMP Version	v3
	Unknown Multicast Groups	Forward
	Header Validation	Disabled
IGMP Snooping Settings in the VLAN	IGMP Snooping	Disabled
	Fast Leave	Disabled
	Report Suppression	Disabled
	Member Port Aging Time	260 seconds
	Router Port Aging Time	300 seconds
	Leave Time	1 second
	IGMP Snooping Querier	Disabled
	Query Interval	60 seconds
	Maximum Response Time	10 seconds
	Last Member Query Interval	1 second
	Last Member Query Count	2
	General Query Source IP	0.0.0.0
	Static Router Ports	None
	Forbidden Router Ports	None
IGMP Snooping Settings on the Port and LAG	IGMP Snooping	Enabled
	Fast Leave	Disabled
Static Multicast Group Settings	Static Multicast Group Entries	None

Function	Parameter	Default Setting
IGMP Accounting and Authentication	IGMP Accounting	Disabled
	IGMP Authentication	Disabled

11.2 Default Parameters for MLD Snooping

Table 11-2 Default Parameters of MLD Snooping

Function	Parameter	Default Setting
Global Settings of IGMP Snooping	MLD Snooping	Disabled
	Unknown Multicast Groups	Forward
MLD Snooping Settings in the VLAN	MLD Snooping	Disabled
	Fast Leave	Disabled
	Report Suppression	Disabled
	Member Port Aging Time	260 seconds
	Router Port Aging Time	300 seconds
	Leave Time	1 second
	MLD Snooping Querier	Disabled
	Query Interval	60 seconds
	Maximum Response Time	10 seconds
	Last Listener Query Interval	1 second
	Last Listener Query Count	2
	General Query Source IP	::
	Static Router Ports	None
Forbidden Router Ports	None	
MLD Snooping Settings on the Port and LAG	MLD Snooping	Enabled
	Fast Leave	Disabled
Static Multicast Group Settings	Static Multicast Group Entries	None

11.3 Default Parameters for MVR

Table 11-3 Default Parameters of MVR

Function	Parameter	Default Setting
Global Settings of MVR	MVR	Disabled
	MVR Mode	Compatible
	Multicast VLAN ID	1
	Query Response Time	5 tenths of a second
	Maximum Multicast Groups	511
MVR Group Settings	MVR Group Entries	None
MVR Settings on the Port	MVR Mode	Disabled
	MVR Port Type	None
	Fast Leave	Disabled
MVR Static Group Members	MVR Static Group Member Entries	None

11.4 Default Parameters for Multicast Filtering

Table 11-4 Default Parameters of Multicast Filtering

Function	Parameter	Default Setting
Profile Settings	IPv4 Profile and IPv6 Profile Entries	None
Multicast Filtering Settings on the Port and LAG	Bound Profile	None
	Maximum Groups	4093
	Overflow Action	Drop

11.5 Default Parameters for PIM

Table 11-5 Default Parameters of PIM

Function	Parameter	Default Setting
IP PIM DR-Priority	Pri	1
IP PIM Join-Prune-Interval	Interval	60

Function	Parameter	Default Setting
IP PIM Hello-Interval	Interval	30

11.6 Default Parameters for Static Multicast-Routing

Table 11-6 Default Parameters of Static Multicast-Routing

Function	Parameter	Default Setting
IP Mroute	distance	0

11.7 Default Parameters for Layer 3 IGMP

Table 11-7 Default Parameters of Layer 3 IGMP

Function	Parameter	Default Setting
ip igmp version	1 2 3	3
ip igmp last-member-query-count count	count	2
ip igmp last-member-query-interval	interval	10
ip igmp query-interval	interval	125
ip igmp query-max-response-time	time	100
ip igmp robustness	robustness	2
ip igmp startup-query-interval	interval	31
ip igmp last-member-query-count	count	2

Part 15

Configuring Spanning Tree

CHAPTERS

1. Spanning Tree
2. STP/RSTP Configurations
3. MSTP Configurations
4. STP Security Configurations
5. Configuration Example for MSTP
6. Appendix: Default Parameters

1 Spanning Tree

1.1 Overview

STP

STP (Spanning Tree Protocol) is a layer 2 Protocol that prevents loops in the network. As is shown in Figure 1-1, STP helps to:

- Block specific ports of the switches to build a loop-free topology.
- Detect topology changes and automatically generate a new loop-free topology.

Figure 1-1 STP Function

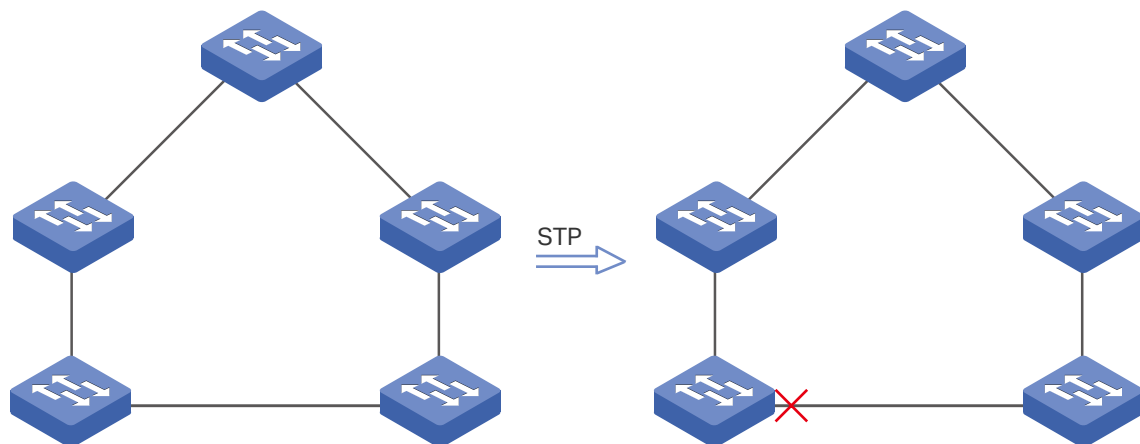

RSTP

RSTP (Rapid Spanning Tree Protocol) provides the same features as STP. Besides, RSTP can provide much faster spanning tree convergence.

MSTP

MSTP (Multiple Spanning Tree Protocol) also provides the fast spanning tree convergence as RSTP. In addition, MSTP enables VLANs to be mapped to different spanning trees (MST instances), and traffic in different VLANs will be transmitted along their respective paths, implementing load balancing.

1.2 Basic Concepts

1.2.1 STP/RSTP Concepts

Based on the networking topology below, this section will introduce some basic concepts in STP/RSTP.

Figure 1-2 STP/RSTP Topology

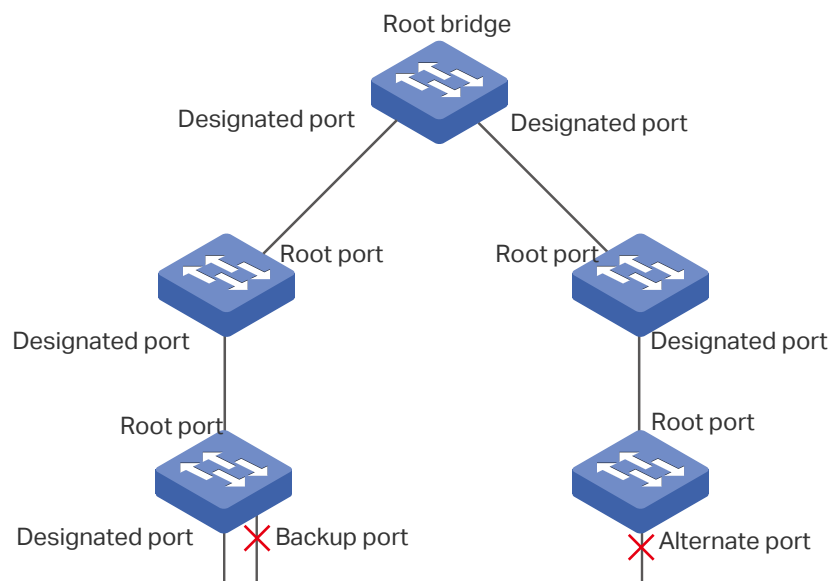

Root Bridge

The root bridge is the root of a spanning tree. The switch with the lowest bridge ID will be the root bridge, and there is only one root bridge in a spanning tree.

Bridge ID

Bridge ID is used to select the root bridge. It is composed of a 2-byte priority and a 6-byte MAC address. The priority is allowed to be configured manually on the switch, and the switch with the lowest priority value will be elected as the root bridge. If the priority of the switches are the same, the switch with the smallest MAC address will be selected as the root bridge.

Port Role

■ Root Port

The root port is selected on non-root bridge that can provide the lowest root path cost. There is only one root port in each non-root bridge.

■ Designated Port

The designated port is selected in each LAN segment that can provide the lowest root path cost from that LAN segment to the root bridge.

■ Alternate Port

If a port is not selected as the designated port for it receives better BPDUs from another switch, it will become an alternate port.

In RSTP/MSTP, the alternate port is the backup for the root port. It is blocked when the root port works normally. Once the root port fails, the alternate port will become the new root port.

In STP, the alternate port is always blocked.

■ Backup Port

If a port is not selected as the designated port for it receives better BPDUs from the switch it belongs to, it will become an backup port.

In RSTP/MSTP, the backup port is the backup for the designated port. It is blocked when the designated port works normally. Once the root port fails, the backup port will become the new designated port.

In STP, the backup port is always blocked.

■ Disable Port

The disconnected port with spanning tree function enabled .

Port Status

Generally, in STP, the port status includes: Blocking, Listening, Learning, Forwarding and Disabled.

■ Blocking

In this status, the port receives and sends BPDUs. The other packets are dropped.

■ Listening

In this status, the port receives and sends BPDUs. The other packets are dropped.

■ Learning

In this status, the port receives and sends BPDUs. It also receives the other user packets to update its MAC address table, but doesn't forward them.

■ Forwarding

In this status, the port receives and sends BPDUs. It also receives the other user packets to update its MAC address table, and forwards them.

■ Disabled

In this status, the port is not participating in the spanning tree, and drops all the packets it receives.

In RSTP/MSTP, the port status includes: Discarding, Learning and Forwarding. The Discarding status is the grouping of STP's Blocking, Listening and Disabled, and the

Learning and Forwarding status correspond exactly to the Learning and Forwarding status specified in STP.

In TP-Link switches, the port status includes: Blocking, Learning, Forwarding and Disconnected.

- **Blocking**

In this status, the port receives and sends BPDUs. The other packets are dropped.

- **Learning**

In this status, the port receives and sends BPDUs. It also receives the other user packets to update its MAC address table, but doesn't forward them.

- **Forwarding**

In this status, the port receives and sends BPDUs. It also receives the other user packets to update its MAC address table, and forwards them.

- **Disconnected**

In this status, the port is enabled with spanning tree function but not connected to any device.

Path Cost

The path cost reflects the link speed of the port. The smaller the value, the higher link speed the port has.

The path cost can be manually configured on each port. If not, the path cost values are automatically calculated according to the link speed as shown below:

Table 1-1 The Default Path Cost Value

Link Speed	Path Cost Value
10Mb/s	2,000,000
100Mb/s	200,000
1Gb/s	20,000
10Gb/s	2,000

Root Path Cost

The root path cost is the accumulated path costs from the root bridge to the other switches. When root bridge sends its BPDU, the root path cost value is 0. When a switch receives this BPDU, the root path cost will be increased according to the path cost of the receive port. Then it create a new BPDU with the new root file cost and forwards it to the

downstream switch. The value of the accumulated root path cost increases as the BPDU spreads further.

BPDU

BPDU is a kind of packet that is used to generate and maintain the spanning tree. The BPDUs (Bridge Protocol Data Unit) contain a lot of information, like bridge ID, root path cost, port priority and so on. Switches share these information to help determine the spanning tree topology.

1.2.2 MSTP Concepts

MSTP, compatible with STP and RSTP, has the same basic elements used in STP and RSTP. Based on the networking topology, this section will introduce some concepts only used in MSTP.

Figure 1-3 MSTP Topology

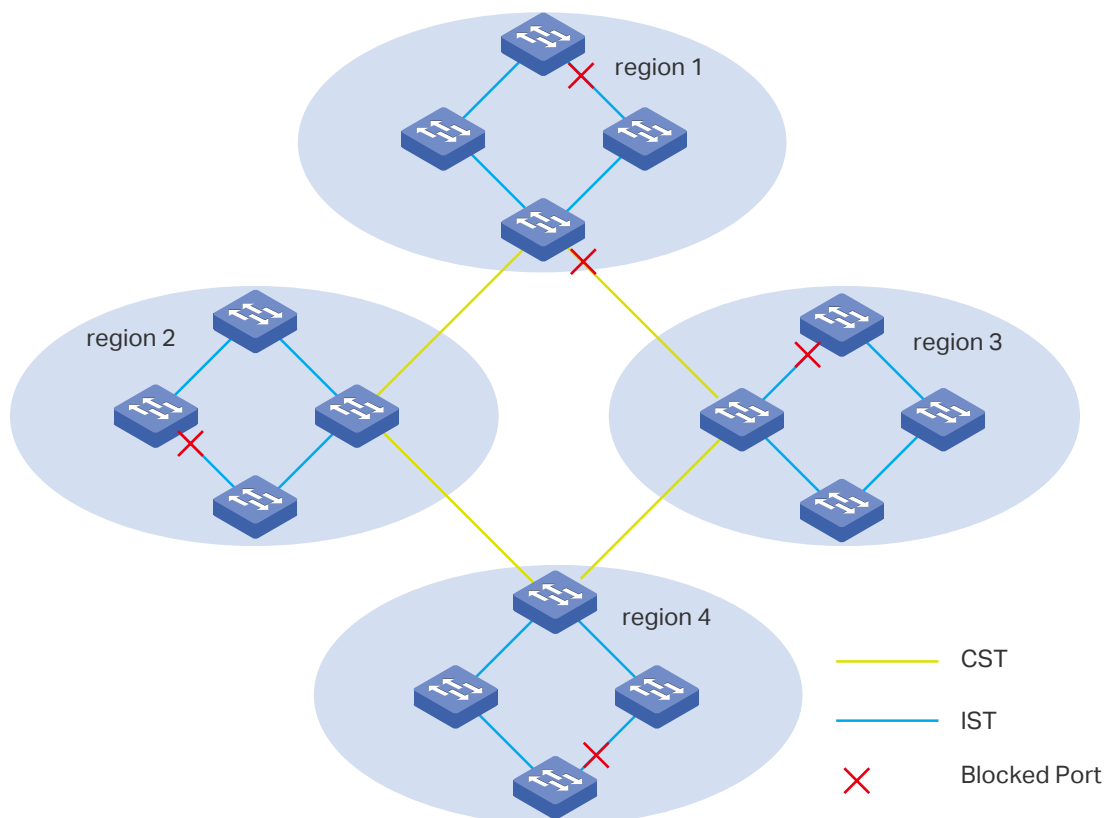

MST Region

An MST region consists of multiple interconnected switches. The switches with the same following characteristics are considered as in the same region:

- Same region name
- Same revision level
- Same VLAN-Instance mapping

MST Instance

The MST instance is a spanning tree running in the MST region. Multiple MST instances can be established in one MST region and they are independent of each other. As is shown in Figure 1-4, there are three instances in a region, and each instance has its own root bridge.

Figure 1-4 MST Region

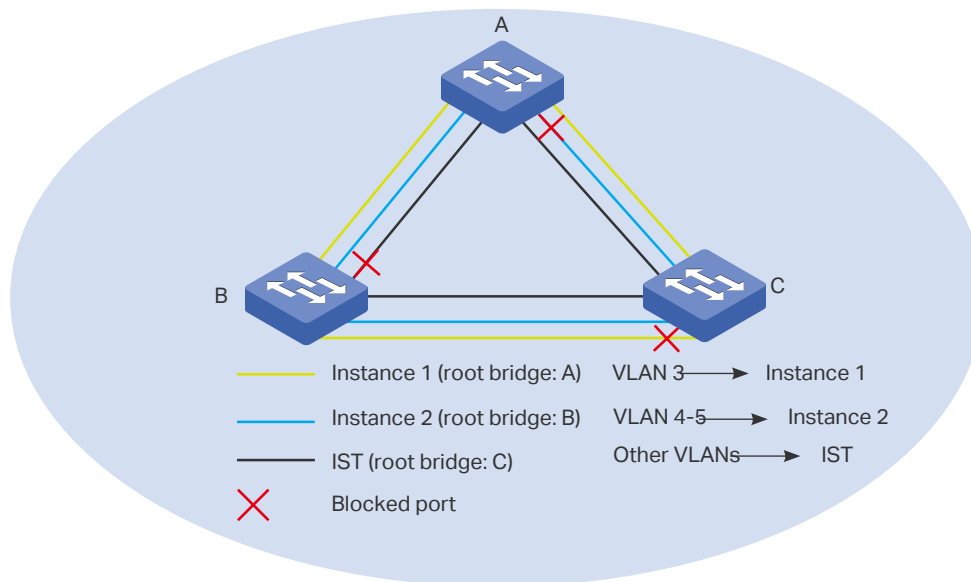

VLAN-Instance Mapping

VLAN-Instance Mapping describes the mapping relationship between VLANs and instances. Multiple VLANs can be mapped to a same instance, but one VLAN can be mapped to only one instance. As Figure 1-4 shows, VLAN 3 is mapped to instance 1, VLAN 4 and VLAN 5 are mapped to instance 2, the other VLANs are mapped to the IST.

IST

The Internal Spanning Tree (IST), which is a special MST instance with an instance ID 0. By default, all the VLANs are mapped to IST.

CST

The Common Spanning Tree (CST), that is the spanning tree connecting all MST regions. As is shown in Figure 1-3, region1-region 4 are connected by the CST.

CIST

The Common and Internal Spanning Tree (CIST), comprising IST and CST. CIST is the spanning tree that connects all the switches in the network.

1.3 STP Security

STP Security prevents the loops caused by wrong configurations or BPDU attacks. It contains Loop Protect, Root Protect, BPDU Protect, BPDU Filter and TC Protect functions.

» Loop Protect

Loop Protect function is used to prevent loops caused by link congestions or link failures. It is recommended to enable this function on root ports and alternate ports.

If the switch cannot receive BPDUs because of link congestions or link failures, the root port will become a designated port and the alternate port will transit to forwarding status, so loops will occur.

With Loop Protect function enabled, the port will temporarily transit to blocking state when the port does not receive BPDUs. After the link restores to normal, the port will transit to its normal state, so loops can be prevented.

» Root Protect

Root Protect function is used to ensure that the desired root bridge will not lose its position. It is recommended to enable this function on the designated ports of the root bridge.

Generally, the root bridge will lose its position once receiving higher-priority BPDUs caused by wrong configurations or malicious attacks. In this case, the spanning tree will be regenerated, and traffic needed to be forwarded along high-speed links may be lead to low-speed links.

With root protect function enabled, when the port receives higher-priority BPDUs, it will temporarily transit to blocking state. After two times of forward delay, if the port does not receive any higher-priority BPDUs, it will transit to its normal state.

» BPDU Protect

BPDU Protect function is used to prevent the port from receiving BPDUs. It is recommended to enable this function on edge ports.

Normally edge ports do not receive BPDUs, but if a user maliciously attacks the switch by sending BPDUs, the system automatically configures these ports as non-edge ports and regenerates the spanning tree.

With BPDU protect function enabled, the edge port will be shutdown when it receives BPDUs, and reports these cases to the administrator. Only the administrator can restore it.

» BPDU Filter

BPDU filter function is to prevent BPDU flooding in the network. It is recommended to enable this function on edge ports.

If a switch receives malicious BPDUs, it forwards these BPDUs to the other switches in the network, and the spanning tree will be continuously regenerated. In this case, the switch occupies too much CPU or the protocol status of BPDUs is wrong.

With the BPDU Filter function enabled, the port does not forward BPDUs from the other switches.

» TC Protect

TC Protect function is used to prevent the switch from frequently removing MAC address entries. It is recommended to enable this function on the ports of non-root switches.

A switch removes MAC address entries upon receiving TC-BPDUs (the packets used to announce changes in the network topology). If a user maliciously sends a large number of TC-BPDUs to a switch in a short period, the switch will be busy with removing MAC address entries, which may decrease the performance and stability of the network.

With TC protect function enabled, if the number of the received TC-BPDUs exceeds the maximum number you set in the TC threshold, the switch will not remove MAC address entries in the TC protect cycle.

2 STP/RSTP Configurations

To complete the STP/RSTP configuration, follow these steps:

- 1) Configure STP/RSTP parameters on ports.
- 2) Configure STP/RSTP globally.
- 3) Verify the STP/RSTP configurations.

Configuration Guidelines

- Before configuring the spanning tree, it's necessary to make clear the role that each switch plays in a spanning tree.
- To avoid any possible network flapping caused by STP/RSTP parameter changes, it is recommended to enable STP/RSTP function globally after configuring the relevant parameters.

2.1 Using the GUI

2.1.1 Configuring STP/RSTP Parameters on Ports

Choose the menu **L2 FEATURES > Spanning Tree > Port Config** to load the following page.

Figure 2-1 Configuring STP/RSTP Parameters on Ports

UNIT1		LAGS								
<input type="checkbox"/>	Port	Status	Priority	Ext-Path Cost	Int-Path Cost	Edge Port	P2P Link	MCheck	Port Mode	Port I
<input type="checkbox"/>	1/0/1	Disabled	128	Auto	Auto	Disabled	Auto	--	--	
<input type="checkbox"/>	1/0/2	Disabled	128	Auto	Auto	Disabled	Auto	--	--	
<input type="checkbox"/>	1/0/3	Disabled	128	Auto	Auto	Disabled	Auto	--	--	
<input type="checkbox"/>	1/0/4	Disabled	128	Auto	Auto	Disabled	Auto	--	--	
<input type="checkbox"/>	1/0/5	Disabled	128	Auto	Auto	Disabled	Auto	--	--	
<input type="checkbox"/>	1/0/6	Disabled	128	Auto	Auto	Disabled	Auto	--	--	
<input type="checkbox"/>	1/0/7	Disabled	128	Auto	Auto	Disabled	Auto	--	--	
<input type="checkbox"/>	1/0/8	Disabled	128	Auto	Auto	Disabled	Auto	--	--	
<input type="checkbox"/>	1/0/9	Disabled	128	Auto	Auto	Disabled	Auto	--	--	
<input type="checkbox"/>	1/0/10	Disabled	128	Auto	Auto	Disabled	Auto	--	--	

Total: 54

Follow these steps to configure STP/RSTP parameters on ports:

- 1) In the **Port Config** section, configure STP/RSTP parameters on ports.

Port	Select the desired ports to configure.
Status	Enable or disable spanning tree function on the desired port.
Priority	Specify the Priority for the desired port. The value should be an integral multiple of 16, ranging from 0 to 240. Ports with lower values have higher priority. When the root path of the port is the same as other ports', the switch will compare the port priorities and select a root port with the highest priority.
Ext-Path Cost	<p>Enter the value of the external path cost. The valid values are from 0 to 2000000. The default setting is Auto, which means the port calculates the external path cost automatically according to the port's link speed.</p> <p>For STP/RSTP, external path cost indicates the path cost of the port in spanning tree. The Port with the lowest root path cost will be elected as the root port of the switch.</p> <p>For MSTP, external path cost indicates the path cost of the port in CST.</p>
Int-Path Cost	<p>Enter the value of the internal path cost. The valid values are from 0 to 2000000. The default setting is Auto, which means the port calculates the internal path cost automatically according to the port's link speed. This parameter is only used in MSTP.</p> <p>For MSTP, internal path cost is used to calculate the path cost in IST. The port with the lowest root path cost will be elected as the root port of the switch in IST.</p>
Edge Port	Select Enable to set the port as an edge port. When the topology is changed, the edge port can transit its state from blocking to forwarding directly. For the quick generation of the spanning tree, it is recommended to set the ports that are connected to the end devices as edge ports.
P2P Link	<p>Select the status of the P2P (Point-to-Point) link to which the ports are connected. During the regeneration of the spanning tree, if the port of P2P link is elected as the root port or the designated port, it can transit its state to forwarding directly.</p> <p>Three options are supported: Auto, Open(Force) and Closed(Force). By default, it is Auto.</p> <p>Auto: The switch automatically checks if the port is connected to a P2P link, then sets the status as Open or Closed.</p> <p>Open(Force): A port is set as the one that is connected to a P2P link. You should check the link first.</p> <p>Close(Force): A port is set as the one that is not connected to a P2P link. You should check the link first.</p>
MCheck	Perform MCheck operations on the port. If a port on an RSTP-enabled/ MSTP-enabled device is connected to an STP-enabled device, the port will switch to STP compatible mode and send packets in STP format. MCheck is used to switch the mode of the port back to RSTP/MSTP after the port is disconnected from the STP-enabled device. The MCheck function will take effect immediately after clicking Apply. Every time the situation above happens, you need to do the MCheck action manually.

Port Mode	<p>Displays the spanning tree mode of the port.</p> <p>STP: The spanning tree mode of the port is STP.</p> <p>RSTP: The spanning tree mode of the port is RSTP.</p> <p>MSTP: The spanning tree mode of the port is MSTP.</p>
Port Role	<p>Displays the role that the port plays in the spanning tree.</p> <p>Root Port: Indicates that the port is the root port in the spanning tree. It has the lowest path cost from the root bridge to this switch and is used to communicate with the root bridge.</p> <p>Designated Port: Indicates that the port is the designated port in the spanning tree. It has the lowest path cost from the root bridge to this physical network segment and is used to forward data for the corresponding network segment.</p> <p>Alternate Port: Indicates that the port is the alternate port in the spanning tree. It is the backup of the root port or master port.</p> <p>Backup Port: Indicates that the port is the backup port in the spanning tree. It is the backup of the designated port.</p> <p>Master Port: Indicates the port provides the lowest root path cost from the region to the root bridge in CIST. In CIST, each region is regarded as a switch, and the master port is the root port of the corresponding region.</p> <p>Disabled: Indicates that the port is not participating in the spanning tree.</p>
Port Status	<p>Displays the port status.</p> <p>Forwarding: The port receives and sends BPDUs, and forwards user traffic.</p> <p>Learning: The port receives and sends BPDUs. It also receives user traffic, but doesn't forward the traffic.</p> <p>Blocking: The port only receives and sends BPDUs.</p> <p>Disconnected: The port is enabled with spanning tree function but not connected to any device.</p>
LAG	<p>Displays the LAG the port belongs to.</p>

2) Click **Apply**.

2.1.2 Configuring STP/RSTP Globally

Choose the menu **L2 FEATURES > Spanning Tree > STP Config > STP Config** to load the following page.

Figure 2-2 Configuring STP/RSTP Globally

Global Config

Spanning Tree: Enable

Mode:

[Apply](#)

Parameters Config

CIST Priority: (0-61440, in increments of 4096)

Hello Time: seconds (1-10)

Max Age: seconds (6-40)

Forward Delay: seconds (4-30)

Tx Hold Count: pps (1-20)

Max Hops: hop (1-40)

[Apply](#)

Follow these steps to configure STP/RSTP globally:

- 1) In the **Parameters Config** section, configure the global parameters of STP/RSTP and click **Apply**.

CIST Priority	<p>Specify the CIST priority for the switch. CIST priority is a parameter used to determine the root bridge for spanning tree. The switch with the lower value has the higher priority.</p> <p>In STP/RSTP, CIST priority is the priority of the switch in spanning tree. The switch with the highest priority will be elected as the root bridge.</p> <p>In MSTP, CISP priority is the priority of the switch in CIST. The switch with the higher priority will be elected as the root bridge in CIST.</p>
Hello Time	Specify the interval between BPDUs' sending. The default value is 2. The root bridge sends configuration BPDUs at an interval of Hello Time. It works with the MAX Age to test the link failures and maintain the spanning tree.
Max Age	Specify the maximum time that the switch can wait without receiving a BPDU before attempting to regenerate a new spanning tree. The default value is 2.
Forward Delay	Specify the interval between the port state transition from listening to learning. The default value is 15. It is used to prevent the network from causing temporary loops during the regeneration of spanning tree. The interval between the port state transition from learning to forwarding is also the Forward Delay.
Tx Hold Count	Specify the maximum number of BPDU that can be sent in a second. The default value is 5.

Max Hops

Specify the maximum BPDU counts that can be forwarded in a MST region. The default value is 20. A switch receives BPDU, then decrements the hop count by one and generates BPDUs with the new value. When the hop reaches zero, the switch will discard the BPDU. This value can control the scale of the spanning tree in the MST region.

Note: Max Hops is a parameter configured in MSTP. You need not configure it if the spanning tree mode is STP/RSTP.

 **Note:**

To prevent frequent network flapping, make sure that Hello Time, Forward Delay, and Max Age conform to the following formulas:

- $2 * (\text{Hello Time} + 1) \leq \text{Max Age}$
- $2 * (\text{Forward Delay} - 1) \geq \text{Max Age}$

2) In the **Global Config** section, enable spanning tree function, choose the STP mode as STP/RSTP, and click **Apply**.

Spanning Tree

Enable or disable the spanning tree function globally.

Mode

Select the desired spanning tree mode as STP/RSTP on the switch. By default, it's STP.

STP: Set the spanning tree mode as STP. It is the basic spanning tree protocol based on IEEE 802.1d.

RSTP: Set the spanning tree mode as RSTP. RSTP has the same function as STP, but it can speed up the spanning tree convergence.

MSTP: Set the spanning tree mode as MSTP. MSTP can work with VLANs and implement load balancing.

2.1.3 Verifying the STP/RSTP Configurations

Verify the STP/RSTP information of your switch after all the configurations are finished.

Choose the menu **L2 FEATURES > Spanning Tree > STP Config > STP Summary** to load the following page.

Figure 2-3 Verifying the STP/RSTP Configurations

STP Summary	
Spanning Tree:	Enable
Spanning Tree Mode:	STP
Local Bridge:	32768---5c-e9-31-50-a6-34
Root Bridge:	32768---5c-e9-31-50-a6-34
External Path Cost:	0
Regional Root Bridge:	---
Internal Path Cost:	---
Designated Bridge:	32768---5c-e9-31-50-a6-34
Root Port:	---
Latest TC Time:	2006-01-01 08:01:46
TC Count:	0
MSTP Instance Summary	
Instance ID:	<input type="text" value="1"/>
Instance Status:	Disable
Local Bridge:	---
Regional Root Bridge:	---
Internal Path Cost:	---
Designated Bridge:	---
Root Port:	---
Latest TC Time:	---
TC Count:	---

The **STP Summary** section shows the summary information of spanning tree :

Spanning Tree	Displays the status of the spanning tree function.
Spanning Tree Mode	Displays the spanning tree mode.
Local Bridge	Displays the bridge ID of the local bridge. The local bridge is the current switch.
Root Bridge	Displays the bridge ID of the root bridge.
External Path Cost	Displays the root path cost from the switch to the root bridge.
Regional Root Bridge	It is the root bridge of IST. It is not displayed when you choose the spanning tree mode as STP/RSTP.
Internal Path Cost	The internal path cost is the root path cost from the switch to the root bridge of IST. It is not displayed when you choose the spanning tree mode as STP/RSTP.
Designated Bridge	Displays the bridge ID of the designated bridge. The designated bridge is the switch that has designated ports.
Root Port	Displays the root port of the current switch.
Latest TC Time	Displays the latest time when the topology is changed.
TC Count	Displays how many times the topology has changed.

2.2 Using the CLI

2.2.1 Configuring STP/RSTP Parameters on Ports

Follow these steps to configure STP/RSTP parameters on ports:

Step 1	<p>configure</p> <p>Enter global configuration mode.</p>
Step 2	<p>interface {fastEthernet port range fastEthernet port-list gigabitEthernet port range gigabitEthernet port-list ten-gigabitEthernet port range ten-gigabitEthernet port-list port-channel port-channel-id range port-channel port-channel-list}</p> <p>Enter interface configuration mode.</p>
Step 3	<p>spanning-tree</p> <p>Enable spanning tree function for desired ports.</p>
Step 4	<p>spanning-tree common-config [port-priority pri] [ext-cost ext-cost] [portfast { enable disable }] [point-to-point { auto open close }]</p> <p>Configure STP/RSTP parameters on the desired port .</p> <p>pri: Specify the Priority for the desired port. The value should be an integral multiple of 16, ranging from 0 to 240. The default value is 128. Ports with lower values have higher priority. When the root path of the port is the same as other ports', the switch will compare the port priorities and select a root port with the highest priority.</p> <p>ext-cost: Specify the value of the external path cost. The valid values are from 0 to 2000000 and the default setting is Auto, which means the port calculates the external path cost automatically according to the port's link speed.</p> <p>For STP/RSTP, external path cost indicates the path cost of the port in spanning tree. The Port with the lowest root path cost will be elected as the root port of the switch.</p> <p>For MSTP, external path cost indicates the path cost of the port in CST.</p> <p>portfast { enable disable }: Enable to set the port as an edge port. By default, it is disabled. When the topology is changed, the edge port can transit its state from blocking to forwarding directly. For the quick generation of the spanning tree, it is recommended to set the ports that are connected to the end devices as edge ports.</p> <p>point-to-point { auto open close }: Select the status of the P2P (Point-to-Point) link to which the ports are connected. During the regeneration of the spanning tree, if the port of P2P link is elected as the root port or the designated port, it can transit its state to forwarding directly. Auto indicates that the switch automatically checks if the port is connected to a P2P link, then sets the status as Open or Closed. Open is used to set the port as the one that is connected to a P2P link. Close is used to set the port as the one that is not connected to a P2P link.</p>

Step 5 **spanning-tree mcheck**

(Optional) Perform MCheck operations on the port.

If a port on an RSTP-enabled/MSTP-enabled device is connected to an STP-enabled device, the port will switch to STP compatible mode and send packets in STP format. MCheck is used to switch the mode of the port back to RSTP/MSTP after the port is disconnected from the STP-enabled device. The MCheck configuration can take effect only once, after that the MCheck status of the port will switch to Disabled.

Step 6 **show spanning-tree interface [fastEthernet port | gigabitEthernet port | ten-gigabitEthernet port | port-channel lagid] [edge | ext-cost | int-cost | mode | p2p | priority | role | state | status]**

(Optional) View the information of all ports or a specified port.

port: Specify the port number.

lagid: Specify the ID of the LAG.

ext-cost | int-cost | mode | p2p | priority | role | state | status: Display the specified information.

Step 7 **end**

Return to privileged EXEC mode.

Step 8 **copy running-config startup-config**

Save the settings in the configuration file.

The following example shows how to enable spanning tree function on port 1/0/3 and configure the port priority as 32 :

Switch#configure

Switch(config)#interface gigabitEthernet 1/0/3

Switch(config-if)#spanning-tree

Switch(config-if)#spanning-tree common-config port-priority 32

Switch(config-if)#show spanning-tree interface gigabitEthernet 1/0/3

Interface	State	Prio	Ext-Cost	Int-Cost	Edge	P2p	Mode
-----	-----	----	-----	-----	----	-----	-----
Gi1/0/3	Enable	32	Auto	Auto	No	No(auto)	N/A

Role	Status	LAG
-----	-----	-----
N/A	LnkDwn	N/A

Switch(config-if)#end

Switch#copy running-config startup-config

2.2.2 Configuring Global STP/RSTP Parameters

Follow these steps to configure global STP/RSTP parameters of the switch:

Step 1	configure Enter global configuration mode.
Step 2	spanning-tree priority <i>pri</i> Configure the priority of the switch. <i>pri</i> : Specify the priority for the switch. The valid value is from 0 to 61440, which are divisible by 4096. The priority is a parameter used to determine the root bridge for spanning tree. The switch with the lower value has the higher priority. In STP/RSTP, the value is the priority of the switch in spanning tree. The switch with the highest priority will be elected as the root bridge. In MSTP, the value is the priority of the switch in CIST. The switch with the higher priority will be elected as the root bridge in CIST.
Step 3	spanning-tree timer [[<i>forward-time forward-time</i>] [<i>hello-time hello-time</i>] [<i>max-age max-age</i>]] (Optional) Configure the Forward Delay, Hello Time and Max Age. <i>forward-time</i> : Specify the value of Forward Delay. It is the interval between the port state transition from listening to learning. The valid values are from 4 to 30 in seconds, and the default value is 15. Forward Delay is used to prevent the network from causing temporary loops during the regeneration of spanning tree. The interval between the port state transition from learning to forwarding is also the Forward Delay. <i>hello-time</i> : Specify the value of Hello Time. It is the interval between BPDUs' sending. The valid values are from 1 to 10 in seconds, and the default value is 2. The root bridge sends configuration BPDUs at an interval of Hello Time. It works with the MAX Age to test the link failures and maintain the spanning tree. <i>max-age</i> : Specify the value of Max Age. It is the maximum time that the switch can wait without receiving a BPDU before attempting to regenerate a new spanning tree. The valid values are from 6 to 40 in seconds, and the default value is 20.
Step 4	spanning-tree hold-count <i>value</i> Specify the maximum number of BPDU that can be sent in a second. <i>value</i> : Specify the maximum number of BPDU packets that can be sent in a second. The valid values are from 1 to 20 pps, and the default value is 5.
Step 5	show spanning-tree bridge (Optional) View the global STP/RSTP parameters of the switch.
Step 6	end Return to privileged EXEC mode.
Step 7	copy running-config startup-config Save the settings in the configuration file.

 **Note:**

To prevent frequent network flapping, make sure that Hello Time, Forward Delay, and Max Age conform to the following formulas:

- $2 * (\text{Hello Time} + 1) \leq \text{Max Age}$
- $2 * (\text{Forward Delay} - 1) \geq \text{Max Age}$

This example shows how to configure the priority of the switch as 36864, the Forward Delay as 12 seconds:

Switch#configure

```
Switch(config)#spanning-tree priority 36864
```

```
Switch(config)#spanning-tree timer forward-time 12
```

Switch(config)#show spanning-tree bridge

State	Mode	Priority	Hello-Time	Fwd-Time	Max-Age	Hold-Count	Max-Hops
-----	-----	-----	-----	-----	-----	-----	-----
Enable	Rstp	36864	2	12	20	5	20

Switch(config)#end

```
Switch#copy running-config startup-config
```

2.2.3 Enabling STP/RSTP Globally

Follow these steps to configure the spanning tree mode as STP/RSTP, and enable spanning tree function globally:

Step 1	configure Enter global configuration mode.
Step 2	spanning-tree mode { stp rstp } Configure the spanning tree mode as STP/RSTP. stp: Specify the spanning tree mode as STP . rstp: Specify the spanning tree mode as RSTP .
Step 3	spanning-tree Enable spanning tree function globally.
Step 4	show spanning-tree active (Optional) View the active information of STP/RSTP.
Step 5	end Return to privileged EXEC mode.

Step 6 **copy running-config startup-config**

Save the settings in the configuration file.

This example shows how to enable spanning tree function, configure the spanning tree mode as RSTP and verify the configurations:

Switch#configure

Switch(config)#spanning-tree mode rstp

Switch(config)#spanning-tree

Switch(config)#show spanning-tree active

Spanning tree is enabled

Spanning-tree's mode: RSTP (802.1w Rapid Spanning Tree Protocol)

Latest topology change time: 2006-01-02 10:04:02

Root Bridge

Priority : 32768

Address : 00-0a-eb-13-12-ba

Local bridge is the root bridge

Designated Bridge

Priority : 32768

Address : 00-0a-eb-13-12-ba

Local Bridge

Priority : 32768

Address : 00-0a-eb-13-12-ba

Interface	State	Prio	Ext-Cost	Int-Cost	Edge	P2p	Mode
-----	-----	----	-----	-----	----	-----	-----
Gi1/0/16	Enable	128	200000	200000	No	Yes(auto)	Rstp
Gi1/0/18	Enable	128	200000	200000	No	Yes(auto)	Rstp
Gi1/0/20	Enable	128	200000	200000	No	Yes(auto)	Rstp

Role Status LAG

Desg Fwd N/A

Desg Fwd N/A

Desg Fwd N/A

Switch(config)#end

Switch#copy running-config startup-config

3 MSTP Configurations

To complete the MSTP configuration, follow these steps:

- 1) Configure parameters on ports in CIST.
- 2) Configure the MSTP region.
- 3) Configure the MSTP globally.
- 4) Verify the MSTP configurations.

Configuration Guidelines

- Before configuring the spanning tree, it's necessary to make clear the role that each switch plays in a spanning tree.
- To avoid any possible network flapping caused by MSTP parameter changes, it is recommended to enable MSTP function globally after configuring the relevant parameter.

3.1 Using the GUI

3.1.1 Configuring Parameters on Ports in CIST

Choose the menu **L2 FEATURES > Spanning Tree > Port Config** to load the following page.

Figure 3-1 Configuring the Parameters of the Ports

UNIT1		LAGS								
<input type="checkbox"/>	Port	Status	Priority	Ext-Path Cost	Int-Path Cost	Edge Port	P2P Link	MCheck	Port Mode	Port I
<input type="checkbox"/>	1/0/1	Disabled	128	Auto	Auto	Disabled	Auto	--	--	
<input type="checkbox"/>	1/0/2	Disabled	128	Auto	Auto	Disabled	Auto	--	--	
<input type="checkbox"/>	1/0/3	Disabled	128	Auto	Auto	Disabled	Auto	--	--	
<input type="checkbox"/>	1/0/4	Disabled	128	Auto	Auto	Disabled	Auto	--	--	
<input type="checkbox"/>	1/0/5	Disabled	128	Auto	Auto	Disabled	Auto	--	--	
<input type="checkbox"/>	1/0/6	Disabled	128	Auto	Auto	Disabled	Auto	--	--	
<input type="checkbox"/>	1/0/7	Disabled	128	Auto	Auto	Disabled	Auto	--	--	
<input type="checkbox"/>	1/0/8	Disabled	128	Auto	Auto	Disabled	Auto	--	--	
<input type="checkbox"/>	1/0/9	Disabled	128	Auto	Auto	Disabled	Auto	--	--	
<input type="checkbox"/>	1/0/10	Disabled	128	Auto	Auto	Disabled	Auto	--	--	

Total: 54

Follow these steps to configure parameters on ports in CIST:

- 1) In the **Port Config** section, configure the parameters on ports.

Port	Select the desired ports to configure.
Status	Enable or disable spanning tree function on the desired port.
Priority	Specify the Priority for the desired port. The value should be an integral multiple of 16, ranging from 0 to 240. Ports with lower values have higher priority. When the root path of the port is the same as other ports', the switch will compare the port priorities and select a root port with the highest priority.
Ext-Path Cost	<p>Enter the value of the external path cost. The default setting is Auto, which means the port calculates the external path cost automatically according to the port's link speed.</p> <p>For STP/RSTP, external path cost indicates the path cost of the port in spanning tree. The port with the lowest root path cost will be elected as the root port of the switch.</p> <p>For MSTP, external path cost indicates the path cost of the port in CST.</p>
Int-Path Cost	<p>Enter the value of the internal path cost. The valid values are from 0 to 2000000. The default setting is Auto, which means the port calculates the internal path cost automatically according to the port's link speed. This parameter is only used in MSTP and you need not to configure it if the spanning tree mode is STP/RSTP.</p> <p>For MSTP, internal path cost is used to calculate the path cost in IST. The port with the lowest root path cost will be elected as the root port of the switch in IST.</p>
Edge Port	Select Enable to set the port as an edge port. When the topology is changed, the edge port can transit its state from blocking to forwarding directly. For the quick generation of the spanning tree, it is recommended to set the ports that are connected to the end devices as edge ports.
P2P Link	<p>Select the status of the P2P (Point-to-Point) link to which the ports are connected. During the regeneration of the spanning tree, if the port of P2P link is elected as the root port or the designated port, it can transit its state to forwarding directly.</p> <p>Three options are supported: Auto, Open(Force) and Closed(Force). By default, it is Auto.</p> <p>Auto: The switch automatically checks if the port is connected to a P2P link, then sets the status as Open or Closed.</p> <p>Open(Force): A port is set as the one that is connected to a P2P link. You should check the link first.</p> <p>Close(Force): A port is set as the one that is not connected to a P2P link. You should check the link first.</p>

MCheck	<p>Perform MCheck operations on the port. If a port on an RSTP-enabled/MSTP-enabled device is connected to an STP-enabled device, the port will switch to STP compatible mode and send packets in STP format. MCheck is used to switch the mode of the port back to RSTP/MSTP after the port is disconnected from the STP-enabled device. The MCheck function will take effect immediately after clicking Apply. Every time the situation above happens, you need to do the MCheck action manually.</p>
Port Mode	<p>Displays the spanning tree mode of the port.</p> <p>STP: The spanning tree mode of the port is STP.</p> <p>RSTP: The spanning tree mode of the port is RSTP.</p> <p>MSTP: The spanning tree mode of the port is MSTP.</p>
Port Role	<p>Displays the role that the port plays in the spanning tree.</p> <p>Root Port: Indicates that the port is the root port in the spanning tree. It has the lowest path cost from the root bridge to this switch and is used to communicate with the root bridge.</p> <p>Designated Port: Indicates that the port is the designated port in the spanning tree. It has the lowest path cost from the root bridge to this physical network segment and is used to forward data for the corresponding network segment.</p> <p>Alternate Port: Indicates that the port is the alternate port in the spanning tree. It is the backup of the root port or master port.</p> <p>Backup Port: Indicates that the port is the backup port in the spanning tree. It is the backup of the designated port.</p> <p>Master Port: Indicates the port provides the lowest root path cost from the region to the root bridge in CIST. In CIST, each region is regarded as a switch, and the master port is the root port of the corresponding region.</p> <p>Disabled: Indicates that the port is not participating in the spanning tree.</p>
Port Status	<p>Displays the port status.</p> <p>Forwarding: The port receives and sends BPDUs, and forwards user traffic.</p> <p>Learning: The port receives and sends BPDUs. It also receives user traffic, but doesn't forward the traffic.</p> <p>Blocking: The port only receives and sends BPDUs.</p> <p>Disconnected: The port has the spanning tree function enabled but is not connected to any device.</p>
LAG	<p>Displays the LAG that the port belongs to.</p>

2) Click **Apply**.

3.1.2 Configuring the MSTP Region

Configure the region name, revision level, VLAN-Instance mapping of the switch. The switches with the same region name, the same revision level and the same VLAN-Instance mapping are considered as in the same region.

Besides, configure the priority of the switch, the priority and path cost of ports in the desired instance.

■ Configuring the Region Name and Revision Level

Choose the menu **L2 FEATURES > Spanning Tree > MSTP Instance > Region Config** to load the following page.

Figure 3-2 Configuring the Region

The screenshot shows a web interface titled "Region Config". It contains two input fields: "Region Name" with the value "5c-e9-31-50-a6-34" and "Revision" with the value "0". To the right of the Revision field is a range indicator "(0-65535)". A blue "Apply" button is located in the bottom right corner of the form.

Follow these steps to create an MST region:

- 1) In the **Region Config** section, set the name and revision level to specify an MSTP region.

Region Name	Specify the name for an MST region. It contains 32 characters at most. By default, it is the MAC address of the switch.
Revision	Enter the revision level number. By default, it is 0.

- 2) Click **Apply**.

■ Configuring the VLAN-Instance Mapping and Switch Priority

Choose the menu **L2 FEATURES > Spanning Tree > MSTP Instance > Instance Config** to load the following page.

Figure 3-3 Configuring the VLAN-Instance Mapping

The screenshot shows a web interface titled "Instance Config". At the top right, there are "+ Add" and "- Delete" buttons. Below is a table with the following data:

<input type="checkbox"/>	Instance ID	Priority	VLAN ID	Operation
<input type="checkbox"/>	CIST	36864	1-4094,	<input type="checkbox"/> <input type="checkbox"/>
Total: 1				

Follow these steps to map VLANs to the corresponding instance, and configure the priority of the switch in the desired instance:

- 1) In the **Instance Config** section, click **Add** and enter the instance ID, Priority and corresponding VLAN ID.

Figure 3-4 Configuring the Instance

Instance Config

Instance ID: (1-8)

Priority: (0-61440, in increments of 4096)

VLAN ID: Add Delete

(1-4094, format: 1,3,4-7,11-30)

Instance ID	Enter the ID number for the instance.
Priority	Specify the priority for the switch in the corresponding instance. The value should be an integral multiple of 4096, ranging from 0 to 61440. It is used to determine the root bridge for the instance. Switches with a lower value have higher priority, and the switch with the highest priority will be elected as the root bridge in the corresponding instance.
VLAN ID	Enter the VLAN ID to map the VLAN to the desired instance or unbind the VLAN-instance mapping.

- 2) Click **Create**.

■ **Configuring Parameters on Ports in the Instance**

Choose the menu **L2 FEATURES > Spanning Tree > MSTP Instance > Instance Port Config** to load the following page.

Figure 3-5 Configuring Port Parameters in the Instance

Instance Port Config						
Instance ID: <input type="text" value="1"/>						
UNIT1		LAGS				
<input type="checkbox"/>	Port	Priority	Path Cost	Port Role	Port Status	LAG
<input type="checkbox"/>	Gi1/0/1	128	Auto	--	--	--
<input type="checkbox"/>	Gi1/0/2	128	Auto	--	--	--
<input type="checkbox"/>	Gi1/0/3	128	Auto	--	--	--
<input type="checkbox"/>	Gi1/0/4	128	Auto	--	--	--
<input type="checkbox"/>	Gi1/0/5	128	Auto	--	--	--
<input type="checkbox"/>	Gi1/0/6	128	Auto	--	--	--
<input type="checkbox"/>	Gi1/0/7	128	Auto	--	--	--
<input type="checkbox"/>	Gi1/0/8	128	Auto	--	--	--
<input type="checkbox"/>	Gi1/0/9	128	Auto	--	--	--
<input type="checkbox"/>	Gi1/0/10	128	Auto	--	--	--
Total: 54						

Follow these steps to configure port parameters in the instance:

- 1) In the **Instance Port Config** section, select the desired instance ID.

Instance ID	Select the ID number of the instance that you want to configure.
--------------------	--

- 2) Configure port parameters in the desired instance.

Port	Select one or more ports to configure.
-------------	--

Priority	Specify the Priority for the port in the corresponding instance. The value should be an integral multiple of 16, ranging from 0 to 240. The port with lower value has the higher priority. When the root path of the port is the same as other ports', the switch will compare the port priorities between these ports and select a root port with the highest priority.
-----------------	--

Path Cost	Enter the value of the path cost in the corresponding instance. The valid values are from 0 to 2000000. The default setting is Auto, which means the port calculates the path cost automatically according to the port's link speed. The port with the lowest root path cost will be elected as the root port of the switch in desired instance.
------------------	--

Port Role	<p>Displays the role that the port plays in the desired instance.</p> <p>Root Port: Indicates that the port is the root port in the desired instance. It has the lowest path cost from the root bridge to this switch and is used to communicate with the root bridge.</p> <p>Designated Port: Indicates that the port is the designated port in the desired instance. It has the lowest path cost from the root bridge to this physical network segment and is used to forward data for the corresponding network segment.</p> <p>Alternate Port: Indicates that the port is the alternate port in the desired instance. It is the backup of the root port or master port.</p> <p>Backup Port: Indicates that the port is the backup port in the desired instance. It is the backup of the designated port.</p> <p>Master Port: Indicates the port provides the lowest root path cost from the region to the root bridge in CIST. In CIST, each region is regarded as a switch, and the master port is the root port of the corresponding region.</p> <p>Disabled: Indicates that the port is not participating in the spanning tree.</p>
Port Status	<p>Displays the port status.</p> <p>Forwarding: The port receives and sends BPDUs, and forwards user traffic.</p> <p>Learning: The port receives and sends BPDUs. It also receives user traffic, but doesn't forward the traffic.</p> <p>Blocking: The port only receives and sends BPDUs.</p> <p>Disconnected: The port has the spanning tree function enabled but is not connected to any device.</p>
LAG	<p>Displays the LAG that the port belongs to.</p>

3.1.3 Configuring MSTP Globally

Choose the menu **L2 FEATURES > Spanning Tree > STP Config > STP Config** to load the following page.

Figure 3-6 Configure MSTP Function Globally

Global Config

Spanning Tree: Enable

Mode: MSTP

Apply

Parameters Config

CIST Priority: 36864 (0-61440, in increments of 4096)

Hello Time: 2 seconds (1-10)

Max Age: 20 seconds (6-40)

Forward Delay: 12 seconds (4-30)

Tx Hold Count: 5 pps (1-20)

Max Hops: 20 hop (1-40)

Apply

Follow these steps to configure MSTP globally:

- 1) In the **Parameters Config** section, Configure the global parameters of MSTP and click **Apply**.

CIST Priority	<p>Specify the CIST priority for the switch. CIST priority is a parameter used to determine the root bridge for spanning tree. The switch with the lower value has the higher priority.</p> <p>In STP/RSTP, CIST priority is the priority of the switch in spanning tree. The switch with the highest priority will be elected as the root bridge.</p> <p>In MSTP, CISP priority is the priority of the switch in CIST. The switch with the higher priority will be elected as the root bridge in CIST.</p>
Hello Time	<p>Specify the interval between BPDUs' sending. The default value is 2. The root bridge sends configuration BPDUs at an interval of Hello Time. It works with the MAX Age to test the link failures and maintain the spanning tree.</p>
Max Age	<p>Specify the maximum time that the switch can wait without receiving a BPDU before attempting to regenerate a new spanning tree. The default value is 20.</p>

Forward Delay	Specify the interval between the port state transition from listening to learning. The default value is 15. It is used to prevent the network from causing temporary loops during the regeneration of spanning tree. The interval between the port state transition from learning to forwarding is also the Forward Delay.
Tx Hold Count	Specify the maximum number of BPDU that can be sent in a second. The default value is 5.
Max Hops	Specify the maximum BPDU hop counts that can be forwarded in a MST region. The default value is 20. A switch receives BPDU, then decrements the hop count by one and generates BPDUs with the new value. When the hop reaches zero, the switch will discard the BPDU. This value can control the scale of the spanning tree in the MST region. Note: Max Hops is a parameter configured in MSTP. You need not configure it if the spanning tree mode is STP/RSTP.

 **Note:**

To prevent frequent network flapping, make sure that Hello Time, Forward Delay, and Max Age conform to the following formulas:

- $2 * (\text{Hello Time} + 1) \leq \text{Max Age}$
- $2 * (\text{Forward Delay} - 1) \geq \text{Max Age}$

2) In the **Global Config** section, enable Spanning-Tree function and choose the STP mode as MSTP and click **Apply**.

Spanning-Tree	Enable or disable the spanning tree function globally.
Mode	Select the desired spanning tree mode as STP/RSTP on the switch. By default, it's STP. STP: Specify the spanning tree mode as STP. RSTP: Specify the spanning tree mode as RSTP. MSTP: Specify the spanning tree mode as MSTP.

3.1.4 Verifying the MSTP Configurations

Choose the menu **Spanning Tree > STP Config > STP Summary** to load the following page.

Figure 3-7 Verifying the MSTP Configurations

STP Summary

Spanning Tree:	Enable
Spanning Tree Mode:	MSTP
Local Bridge:	36864---00-0a-eb-13-a2-02
Root Bridge:	36864---00-0a-eb-13-a2-02
External Path Cost:	0
Regional Root Bridge:	36864---00-0a-eb-13-a2-02
Internal Path Cost:	0
Designated Bridge:	36864---00-0a-eb-13-a2-02
Root Port:	---
Latest TC Time:	2006-01-01 08:00:45
TC Count:	0

MSTP Instance Summary

Instance ID:	<input type="text" value=""/>
Instance Status:	Disable
Local Bridge:	---
Regional Root Bridge:	---
Internal Path Cost:	---
Designated Bridge:	---
Root Port:	---
Latest TC Time:	---
TC Count:	---

Refresh

The **STP Summary** section shows the summary information of CIST:

Spanning Tree	Displays the status of the spanning tree function.
Spanning-Tree Mode	Displays the spanning tree mode.
Local Bridge	Displays the bridge ID of the local switch. The local bridge is the current switch.
Root Bridge	Displays the bridge ID of the root bridge in CIST.
External Path Cost	Displays the external path cost. It is the root path cost from the switch to the root bridge in CIST.

Regional Root Bridge	Displays the bridge ID of the root bridge in IST.
Internal Path Cost	Displays the internal path cost. It is the root path cost from the current switch to the root bridge in IST.
Designated Bridge	Displays the bridge ID of the designated bridge in CIST.
Root Port	Displays the root port of in CIST.
Latest TC Time	Displays the latest time when the topology is changed.
TC Count	Displays how many times the topology has changed.

The **MSTP Instance Summary** section shows the information in MST instances:

Instance ID	Select the desired instance.
Instance Status	Displays the status of the desired instance.
Local Bridge	Displays the bridge ID of the local switch. The local bridge is the current switch.
Regional Root Bridge	Displays the bridge ID of the root bridge in the desired instance.
Internal Path Cost	Displays the internal path cost. It is the root path cost from the current switch to the regional root bridge.
Designated Bridge	Displays the bridge ID of the designated bridge in the desired instance.
Root Port	Displays the root port of the desired instance.
Latest TC Time	Displays the latest time when the topology is changed.
TC Count	Displays how many times the topology has changed.

3.2 Using the CLI

3.2.1 Configuring Parameters on Ports in CIST

Follow these steps to configure the parameters of the port in CIST:

Step 1	configure Enter global configuration mode.
Step 2	interface {fastEthernet port range fastEthernet port-list gigabitEthernet port range gigabitEthernet port-list ten-gigabitEthernet port range ten-gigabitEthernet port-list port-channel port-channel-id range port-channel port-channel-list} Enter interface configuration mode.

Step 3 **spanning-tree**

Enable spanning tree function for the desired port.

Step 4 **spanning-tree common-config [port-priority pri] [ext-cost ext-cost] [int-cost int-cost] [portfast { enable | disable }] [point-to-point { auto | open | close }]**

Configure the parameters on ports in CIST.

pri: Specify the Priority for the desired port. The value should be an integral multiple of 16, ranging from 0 to 240. The default value is 128. Ports with lower values have higher priority. When the root path of the port is the same as other ports', the switch will compare the port priorities and select a root port with the highest priority.

ext-cost: Specify the value of the external path cost. The valid values are from 0 to 2000000 and the default setting is Auto, which means the port calculates the external path cost automatically according to the port's link speed.

For STP/RSTP, external path cost indicates the path cost of the port in spanning tree. The Port with the lowest root path cost will be elected as the root port of the switch.

For MSTP, external path cost indicates the path cost of the port in CST.

int-cost: Specify the value of the internal path cost. The valid values are from 0 to 2000000. The default setting is Auto, which means the port calculates the internal path cost automatically according to the port's link speed. This parameter is only used in MSTP.

For MSTP, internal path cost is used to calculate the path cost in IST. The port with the lowest root path cost will be elected as the root port of the switch in IST.

portfast { enable | disable }: Enable to set the port as an edge port. By default, it is disabled. When the topology is changed, the edge port can transit its state from blocking to forwarding directly. For the quick generation of the spanning tree, it is recommended to set the ports that are connected to the end devices as edge ports.

point-to-point { auto | open | close }: Select the status of the P2P (Point-to-Point) link to which the ports are connected. During the regeneration of the spanning tree, if the port of P2P link is elected as the root port or the designated port, it can transit its state to forwarding directly. Auto indicates that the switch automatically checks if the port is connected to a P2P link, then sets the status as Open or Closed. Open is used to set the port as the one that is connected to a P2P link. Close is used to set the port as the one that is not connected to a P2P link.

Step 5 **spanning-tree mcheck**

(Optional) Perform MCheck operations on the port.

If a port on an RSTP-enabled/MSTP-enabled device is connected to an STP-enabled device, the port will switch to STP compatible mode and send packets in STP format. MCheck is used to switch the mode of the port back to RSTP/MSTP after the port is disconnected from the STP-enabled device. The MCheck configuration can take effect only once, after that the MCheck status of the port will switch to Disabled.

-
- Step 6 **show spanning-tree interface [fastEthernet port | gigabitEthernet port | ten-gigabitEthernet port | port-channel lagid] [edge | ext-cost | int-cost | mode | p2p | priority | role | state | status]**
 (Optional) View the information of all ports or a specified port.
port: Specify the port number.
lagid: Specify the ID of the LAG.
ext-cost | int-cost | mode | p2p | priority | role | state | status: Display the specified information.
-
- Step 7 **end**
 Return to privileged EXEC mode.
-
- Step 8 **copy running-config startup-config**
 Save the settings in the configuration file.
-

This example shows how to enable spanning tree function for port 1/0/3 and configure the port priority as 32 :

Switch#configure

Switch(config)#interface gigabitEthernet 1/0/3

Switch(config-if)#spanning-tree

Switch(config-if)#spanning-tree common-config port-priority 32

Switch(config-if)#show spanning-tree interface gigabitEthernet 1/0/3

MST-Instance 0 (CIST)

Interface	State	Prio	Ext-Cost	Int-Cost	Edge	P2p	Mode	Role	Status
Gi1/0/3	Enable	32	Auto	Auto	No	No(auto)	N/A	N/A	LnkDwn

MST-Instance 5

Interface	Prio	Cost	Role	Status
Gi1/0/3	144	200	N/A	LnkDwn

Switch(config-if)#end

Switch#copy running-config startup-config

3.2.2 Configuring the MSTP Region

■ Configuring the MST Region

Follow these steps to configure the MST region and the priority of the switch in the instance:

Step 1	configure Enter global configuration mode.
Step 2	spanning-tree mst instance <i>instance-id</i> priority <i>pri</i> Configure the priority of the switch in the instance. <i>instance-id</i> : Specify the instance ID, the valid values ranges from 1 to 8. <i>pri</i> : Specify the priority for the switch in the corresponding instance. The value should be an integral multiple of 4096, ranging from 0 to 61440. The default value is 32768. It is used to determine the root bridge for the instance. Switches with a lower value have higher priority, and the switch with the highest priority will be elected as the root bridge in the corresponding instance.
Step 3	spanning-tree mst configuration Enter MST configuration mode, as to configure the VLAN-Instance mapping, region name and revision level.
Step 4	name <i>name</i> Configure the region name of the region. <i>name</i> : Specify the region name, used to identify an MST region. The valid values are from 1 to 32 characters.
Step 5	revision <i>revision</i> Configure the revision level of the region. <i>revision</i> : Specify the revision level of the region. The valid values are from 0 to 65535.
Step 6	instance <i>instance-id</i> vlan <i>vlan-id</i> Configure the VLAN-Instance mapping. <i>instance-id</i> : Specify the Instance ID. The valid values are from 1 to 8. <i>vlan-id</i> : Specify the VLAN mapped to the corresponding instance.
Step 7	show spanning-tree mst { configuration [<i>digest</i>] instance <i>instance-id</i> [interface [fastEthernet <i>port</i> gigabitEthernet <i>port</i> port-channel <i>lagid</i> ten-gigabitEthernet <i>port</i>]] } (Optional) View the related information of MSTP Instance. <i>digest</i> : Specify to display the digest calculated by instance-vlan map. <i>instance-id</i> : Specify the Instance ID desired to view, ranging from 1 to 8. <i>port</i> : Specify the port number. <i>lagid</i> : Specify the ID of the LAG.

Step 8 **end**
Return to privileged EXEC mode.

Step 9 **copy running-config startup-config**
Save the settings in the configuration file.

This example shows how to create an MST region, of which the region name is R1, the revision level is 100 and VLAN 2-VLAN 6 are mapped to instance 5:

Switch#configure

Switch(config)#spanning-tree mst configuration

Switch(config-mst)#name R1

Switch(config-mst)#revision 100

Switch(config-mst)#instance 5 vlan 2-6

Switch(config-mst)#show spanning-tree mst configuration

Region-Name : R1

Revision : 100

MST-Instance	Vlans-Mapped
-----	-----
0	1,7-4094
5	2-6,
-----	-----

Switch(config-mst)#end

Switch#copy running-config startup-config

■ Configuring the Parameters on Ports in Instance

Follow these steps to configure the priority and path cost of ports in the specified instance:

Step 1 **configure**
Enter global configuration mode.

Step 2 **interface {fastEthernet port | range fastEthernet port-list | gigabitEthernet port | range gigabitEthernet port-list | ten-gigabitEthernet port | range ten-gigabitEthernet port-list | port-channel port-channel-id | range port-channel port-channel-list}**
Enter interface configuration mode.

Step 3 **spanning-tree mst instance** *instance-id* **[[port-priority *pri*] | [cost *cost*]]**

Configure the priority and path cost of ports in the specified instance.

instance-id: Specify the instance ID, the valid values ranges from 1 to 8.

pri: Specify the Priority for the port in the corresponding instance. The value should be an integral multiple of 16, ranging from 0 to 240. The default value is 128. The port with lower value has the higher priority. When the root path of the port is the same as other ports', the switch will compare the port priorities between these ports and select a root port with the highest priority.

cost: Enter the value of the path cost in the corresponding instance. The valid values are from 0 to 2000000. The default setting is Auto, which means the port calculates the external path cost automatically according to the port's link speed. The port with the lowest root path cost will be elected as the root port of the switch.

Step 4 **show spanning-tree mst** **{ configuration [digest] | instance** *instance-id* **[interface [fastEthernet** *port* **| gigabitEthernet** *port* **| port-channel** *lagid* **| ten-gigabitEthernet** *port* **]]}**

(Optional) View the related information of MSTP Instance.

digest: Specify to display the digest calculated by instance-vlan map.

instance-id: Specify the Instance ID desired to view, ranging from 1 to 8.

port: Specify the port number.

lagid: Specify the ID of the LAG.

Step 5 **end**
Return to privileged EXEC mode.

Step 6 **copy running-config startup-config**
Save the settings in the configuration file.

This example shows how to configure the priority as 144, the path cost as 200 of port 1/0/3 in instance 5:

Switch#configure

Switch(config)#interface gigabitEthernet 1/0/3

Switch(config-if)#spanning-tree mst instance 5 port-priority 144 cost 200

Switch(config-if)#show spanning-tree interface gigabitEthernet 1/0/3

MST-Instance 0 (CIST)

Interface	State	Prio	Ext-Cost	Int-Cost	Edge	P2p	Mode	Role	Status	LAG
-----	-----	----	-----	-----	----	-----	-----	----	-----	---
Gi1/0/3	Enable	32	Auto	Auto	No	No(auto)	N/A	N/A	LnkDwn	N/A

MST-Instance 5

Interface	Prio	Cost	Role	Status	LAG
-----	-----	-----	-----	-----	-----
Gi1/0/3	144	200	N/A	LnkDwn	N/A

```
Switch(config-if)#end
```

```
Switch#copy running-config startup-config
```

3.2.3 Configuring Global MSTP Parameters

Follow these steps to configure the global MSTP parameters of the switch:

Step 1 **configure**

Enter global configuration mode.

Step 2 **spanning-tree priority *pri***

Configure the priority of the switch for comparison in CIST.

pri: Specify the priority for the switch. The valid value is from 0 to 61440, which are divisible by 4096. The priority is a parameter used to determine the root bridge for spanning tree. The switch with the lower value has the higher priority.

In STP/RSTP, the value is the priority of the switch in spanning tree. The switch with the highest priority will be elected as the root bridge.

In MSTP, the value is the priority of the switch in CIST. The switch with the higher priority will be elected as the root bridge in CIST.

Step 3 **spanning-tree timer { [*forward-time* *forward-time*] [*hello-time* *hello-time*] [*max-age* *max-age*] }**

(Optional) Configure the Forward Delay, Hello Time and Max Age.

forward-time: Specify the value of Forward Delay. It is the interval between the port state transition from listening to learning. The valid values are from 4 to 30 in seconds, and the default value is 15. Forward Delay is used to prevent the network from causing temporary loops during the regeneration of spanning tree. The interval between the port state transition from learning to forwarding is also the Forward Delay.

hello-time: Specify the value of Hello Time. It is the interval between BPDUs' sending. The valid values are from 1 to 10 in seconds, and the default value is 2. The root bridge sends configuration BPDUs at an interval of Hello Time. It works with the MAX Age to test the link failures and maintain the spanning tree.

max-age: Specify the value of Max Age. It is the maximum time that the switch can wait without receiving a BPDU before attempting to regenerate a new spanning tree. The valid values are from 6 to 40 in seconds, and the default value is 20.

Step 4 **spanning-tree hold-count *value***

(Optional) Specify the maximum number of BPDU that can be sent in a second.

value: Specify the maximum number of BPDU packets that can be sent in a second. The valid values are from 1 to 20 pps, and the default value is 5.

Step 5 `spanning-tree max-hops value`

(Optional) Specify the maximum BPDU hop counts that can be forwarded in a MST region. A switch receives BPDU, then decrements the hop count by one and generates BPDUs with the new value. When the hop reaches zero, the switch will discard the BPDU. This value can control the scale of the spanning tree in the MST region.

value: Specify the maximum number of hops that occur in a specific region before the BPDU is discarded. The valid values are from 1 to 40 in hop, and the default value is 20.

Step 6 `show spanning-tree bridge`

(Optional) View the global parameters of the switch.

Step 7 `end`

Return to privileged EXEC mode.

Step 8 `copy running-config startup-config`

Save the settings in the configuration file.

 **Note:**

To prevent frequent network flapping, make sure that Hello Time, Forward Delay, and Max Age conform to the following formulas:

- $2 * (\text{Hello Time} + 1) \leq \text{Max Age}$
- $2 * (\text{Forward Delay} - 1) \geq \text{Max Age}$

This example shows how to configure the CIST priority as 36864, the Forward Delay as 12 seconds, the Hold Count as 8 and the Max Hop as 25:

```
Switch#configure
```

```
Switch(config)#spanning-tree priority 36864
```

```
Switch(config-if)#spanning-tree timer forward-time 12
```

```
Switch(config-if)#spanning-tree hold-count 8
```

```
Switch(config-if)#spanning-tree max-hops 25
```

```
Switch(config-if)#show spanning-tree bridge
```

State	Mode	Priority	Hello-Time	Fwd-Time	Max-Age	Hold-Count	Max-Hops
-----	-----	-----	-----	-----	-----	-----	-----
Enable	Mstp	36864	2	12	20	8	25

```
Switch(config-if)#end
```

```
Switch#copy running-config startup-config
```

3.2.4 Enabling Spanning Tree Globally

Follow these steps to configure the spanning tree mode as MSTP and enable spanning tree function globally:

Step 1	configure Enter global configuration mode.
Step 2	spanning-tree mode mstp Configure the spanning tree mode as MSTP. <i>mstp</i> : Specify the spanning tree mode as MSTP.
Step 3	spanning-tree Enable spanning tree function globally.
Step 4	show spanning-tree active (Optional) View the active information of MSTP.
Step 5	end Return to privileged EXEC mode.
Step 6	copy running-config startup-config Save the settings in the configuration file.

This example shows how to configure the spanning tree mode as MSTP and enable spanning tree function globally :

Switch#configure

Switch(config)#spanning-tree mode mstp

Switch(config)#spanning-tree

Switch(config)#show spanning-tree active

Spanning tree is enabled

Spanning-tree's mode: MSTP (802.1s Multiple Spanning Tree Protocol)

Latest topology change time: 2006-01-04 10:47:42

MST-Instance 0 (CIST)

Root Bridge

Priority : 32768

Address : 00-0a-eb-13-23-97

External Cost : 200000

Root Port : Gi/0/20

Designated Bridge

Priority : 32768

Address : 00-0a-eb-13-23-97

Regional Root Bridge

Priority : 36864

Address : 00-0a-eb-13-12-ba

Local bridge is the regional root bridge

Local Bridge

Priority : 36864

Address : 00-0a-eb-13-12-ba

Interface	State	Prio	Ext-Cost	Int-Cost	Edge	P2p	Mode	Role	Status
Gi/0/16	Enable	128	200000	200000	No	Yes(auto)	Mstp	Altn	Blk
Gi/0/20	Enable	128	200000	200000	No	Yes(auto)	Mstp	Root	Fwd

MST-Instance 1

Root Bridge

Priority : 32768

Address : 00-0a-eb-13-12-ba

Local bridge is the root bridge

Designated Bridge

Priority : 32768

Address : 00-0a-eb-13-12-ba

Local Bridge

Priority : 32768

Address : 00-0a-eb-13-12-ba

Interface	Prio	Cost	Role	Status
Gi/0/16	128	200000	Altn	Blk
Gi/0/20	128	200000	Mstr	Fwd

Switch(config)#end

Switch#copy running-config startup-config

4 STP Security Configurations

4.1 Using the GUI

Choose the menu **L2 FEATURES > Spanning Tree > STP Security** to load the following page.

Figure 4-1 Configuring the Port Protect

Port Protect									
UNIT1		LAGS							
<input type="checkbox"/>	Port	Loop Protect	Root Protect	TC Guard	BPDU Protect	BPDU Filter	BPDU Forward	LAG	
<input type="checkbox"/>	Gi1/0/1	Disabled	Disabled	Disabled	Disabled	Disabled	Enabled	--	
<input type="checkbox"/>	Gi1/0/2	Disabled	Disabled	Disabled	Disabled	Disabled	Enabled	--	
<input type="checkbox"/>	Gi1/0/3	Disabled	Disabled	Disabled	Disabled	Disabled	Enabled	--	
<input type="checkbox"/>	Gi1/0/4	Disabled	Disabled	Disabled	Disabled	Disabled	Enabled	--	
<input type="checkbox"/>	Gi1/0/5	Disabled	Disabled	Disabled	Disabled	Disabled	Enabled	--	
<input type="checkbox"/>	Gi1/0/6	Disabled	Disabled	Disabled	Disabled	Disabled	Enabled	--	
<input type="checkbox"/>	Gi1/0/7	Disabled	Disabled	Disabled	Disabled	Disabled	Enabled	--	
<input type="checkbox"/>	Gi1/0/8	Disabled	Disabled	Disabled	Disabled	Disabled	Enabled	--	
<input type="checkbox"/>	Gi1/0/9	Disabled	Disabled	Disabled	Disabled	Disabled	Enabled	--	
<input type="checkbox"/>	Gi1/0/10	Disabled	Disabled	Disabled	Disabled	Disabled	Enabled	--	
Total: 54									

Configure the Port Protect features for the selected ports, and click **Apply**.

UNIT	Select the desired ports to configure.
Loop Protect	<p>Enable or disable Loop Protect. It is recommended to enable this function on root ports and alternate ports.</p> <p>When there are link congestions or link failures in the network, the switch will not receive BPDUs from the upstream device in time. Loop Protect is used to avoid loop caused by the recalculation in this situation. With Loop Protect function enabled, the port will temporarily transit to a blocking state after it does not receive BPDUs in time.</p>

Root Protect	<p>Enable or disable Root Protect. It is recommended to enable this function on the designated ports of the root bridge.</p> <p>Switches with faulty configurations may produce a higher-priority BPDUs than the root bridge's, and this situation will cause recalculation of the spanning tree. Root Protect is used to ensure that the desired root bridge will not lose its position in the scenario above. With root protect enabled, the port will temporarily transit to blocking state when it receives higher-priority BPDUs. After two forward delays, if the port does not receive any other higher-priority BPDUs, it will transit to its normal state.</p>
TC Guard	<p>Enable or disable the TC Guard function. It is recommended to enable this function on the ports of non-root switches.</p> <p>TC Guard function is used to prevent the switch from frequently changing the MAC address table. With TC Guard function enabled, when the switch receives TC-BPDUs, it will not process the TC-BPDUs at once. The switch will wait for a fixed time and process the TC-BPDUs together after receiving the first TC-BPDU, then it will restart timing.</p>
BPDU Protect	<p>Enable or disable the BPDU Protect function. It is recommended to enable this function on edge ports.</p> <p>Edge ports in spanning tree are used to connect to the end devices and it doesn't receive BPDUs in the normal situation. If edge ports receive BPDUs, it may be an attack. BPDU Protect is used to protect the switch from the attack talked above. With BPDU protect function enabled, the edge ports will be shutdown when they receives BPDUs, and will report these cases to the administrator. Only the administrator can restore the state of the ports.</p>
BPDU Filter	<p>Enable or disable BPDU Filter. It is recommended to enable this function on edge ports.</p> <p>With the BPDU Filter function enabled, the port does not forward BPDUs from the other switches.</p>
BPDU Forward	<p>Enable or disable BPDU Forward. This function only takes effect when the spanning tree function is disabled globally.</p> <p>With BPDU forward enabled, the port can still forward spanning tree BPDUs when the spanning tree function is disabled.</p>

4.2 Using the CLI

4.2.1 Configuring the STP Security

Follow these steps to configure the Root protect feature, BPDU protect feature and BPDU filter feature for ports:

-
- | | |
|--------|--|
| Step 1 | configure
Enter global configuration mode. |
|--------|--|
-

Step 2	<p>interface {fastEthernet port range fastEthernet port-list gigabitEthernet port range gigabitEthernet port-list ten-gigabitEthernet port range ten-gigabitEthernet port-list port-channel port-channel-id range port-channel port-channel-list}</p> <p>Enter interface configuration mode.</p>
Step 3	<p>spanning-tree guard loop</p> <p>(Optional) Enable Loop Protect. It is recommended to enable this function on root ports and alternate ports.</p> <p>When there are link congestions or link failures in the network, the switch will not receive BPDUs from the upstream device in time. Loop Protect is used to avoid loop caused by the recalculation in this situation. With Loop Protect function enabled, the port will temporarily transit to a blocking state after it does not receive BPDUs in time.</p>
Step 4	<p>spanning-tree guard root</p> <p>(Optional) Enable Root Protect. It is recommended to enable this function on the designated ports of the root bridge.</p> <p>Switches with faulty configurations may produce a higher-priority BPDUs than the root bridge's, and this situation will cause recalculation of the spanning tree. Root Protect is used to ensure that the desired root bridge will not lose its position in the scenario above. With root protect enabled, the port will temporarily transit to blocking state when it receives higher-priority BPDUs. After two forward delays, if the port does not receive any other higher-priority BPDUs, it will transit to its normal state.</p>
Step 5	<p>spanning-tree guard tc</p> <p>(Optional) Enable the TC Guard function. It is recommended to enable this function on the ports of non-root switches.</p> <p>TC Guard function is used to prevent the switch from frequently changing the MAC address table. With TC Guard function enabled, when the switch receives TC-BPDUs, it will not process the TC-BPDUs at once. The switch will wait for a fixed time and process the TC-BPDUs together after receiving the first TC-BPDU, then it will restart timing.</p>
Step 6	<p>spanning-tree bpduguard</p> <p>(Optional) Enable the BPDU Protect function. It is recommended to enable this function on edge ports.</p> <p>Edge ports in spanning tree are used to connect to the end devices and it doesn't receive BPDUs in the normal situation. If edge ports receive BPDUs, it may be an attack. BPDU Protect is used to protect the switch from the attack talked above. With BPDU protect function enabled, the edge ports will be shutdown when they receives BPDUs, and will report these cases to the administrator. Only the administrator can restore the state of the ports.</p>
Step 7	<p>spanning-tree bpdufilter</p> <p>(Optional) Enable or disable BPDU Filter. It is recommended to enable this function on edge ports.</p> <p>With the BPDU Filter function enabled, the port does not forward BPDUs from the other switches.</p>

Step 8 spanning-tree bpdulflood

(Optional) Enable BPDU Forward. This function only takes effect when the spanning tree function is disabled globally. By default, it is enabled.

With BPDU forward enabled, the port can still forward spanning tree BPDUs when the spanning tree function is disabled.

Step 9 show spanning-tree interface-security [fastEthernet port | gigabitEthernet port | ten-gigabitEthernet port | port-channel port-channel-id] [bpdufilter | bpduguard | bpdulflood | loop | root | tc]

(Optional) View the protect information of ports.

port: Specify the port number.

lagid: Specify the ID of the LAG.

Step 10 end

Return to privileged EXEC mode.

Step 11 copy running-config startup-config

Save the settings in the configuration file.

This example shows how to enable Loop Protect, Root Protect, BPDU Filter and BPDU Protect functions on port 1/0/3:

Switch#configure

Switch(config)#interface gigabitEthernet 1/0/3

Switch(config-if)#spanning-tree guard loop

Switch(config-if)#spanning-tree guard root

Switch(config-if)#spanning-tree bpdufilter

Switch(config-if)#spanning-tree bpduguard

Switch(config-if)#show spanning-tree interface-security gigabitEthernet 1/0/3

Interface	BPDU-Filter	BPDU-Guard	Loop-Protect	Root-Protect	TC-Protect	BPDU-Flood
Gi1/0/3	Enable	Enable	Enable	Enable	Disable	Enable

Switch(config-if)#end

Switch#copy running-config startup-config

5 Configuration Example for MSTP

MSTP, backwards-compatible with STP and RSTP, can map VLANs to instances to implement load-balancing, thus providing a more flexible method in network management. Here we take the MSTP configuration as an example.

5.1 Network Requirements

As shown in figure 5-1, the network consists of three switches. Traffic in VLAN 101-VLAN 106 is transmitted in this network. The link speed between the switches is 100Mb/s (the default path cost of the port is 200000).

It is required that traffic in VLAN 101 - VLAN 103 and traffic in VLAN 104 - VLAN 106 should be transmitted along different paths.

Figure 5-1 Network Topology

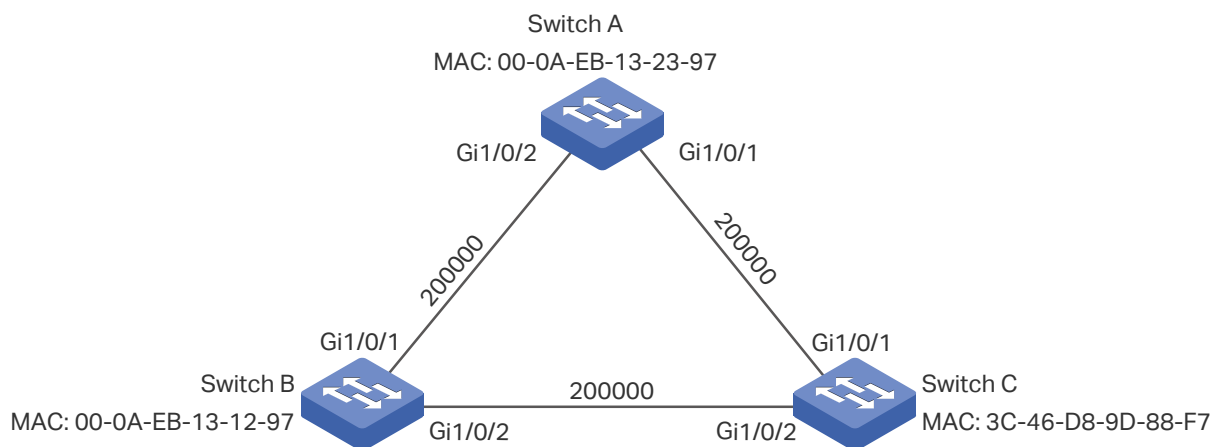

5.2 Configuration Scheme

To meet this requirement, you are suggested to configure MSTP function on the switches. Map the VLANs to different instances to ensure traffic can be transmitted along the respective instance.

Here we configure two instances to meet the requirement, as is shown below:

Figure 5-2 VLAN-Instance Mapping

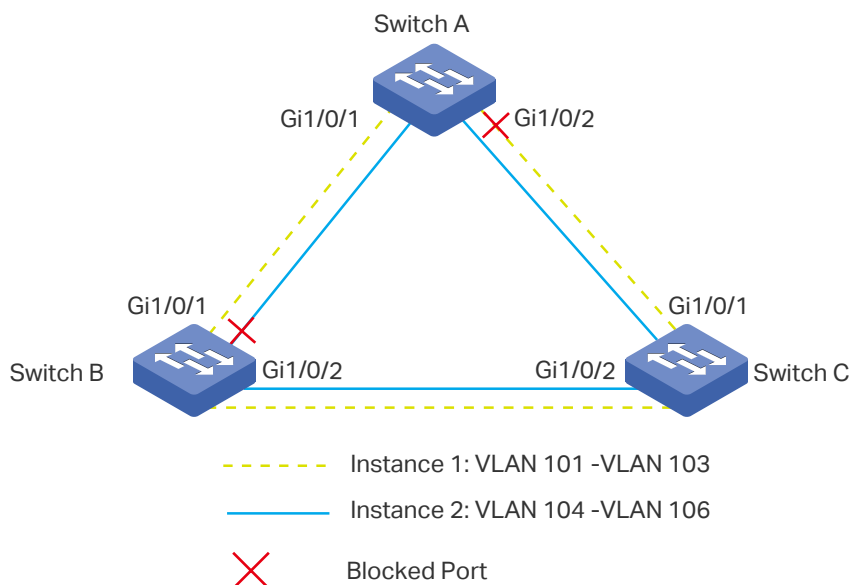

The overview of configuration is as follows:

- 1) Enable MSTP function globally in all the switches.
- 2) Enable Spanning Tree function on the ports in each switch.
- 3) Configure Switch A, Switch B and Switch C in the same region. Configure the region name as 1, and the revision level as 100. Map VLAN 101 - VLAN 103 to instance 1 and VLAN 104 - VLAN 106 to instance 2.
- 4) Configure the priority of Switch B as 0 to set it as the root bridge in instance 1; configure the priority of Switch C as 0 to set it as the root bridge in instance 2.
- 5) Configure the path cost to block the specified ports. For instance 1, set the path cost of port 1/0/1 of Switch A to be greater than the default path cost (200000); for instance 2, set the path cost of port 1/0/2 of Switch B to be greater than the default path cost (200000). After this configuration, port 1/0/2 of Switch A in instance 1 and port 1/0/1 of Switch B in instance 2 will be blocked for they cannot be neither root port nor designated port.

Note:

Please configure MSTP for each switch first and then connect them together to avoid broadcast storm.

5.3 Using the GUI

■ Configurations for Switch A

- 1) Choose the menu **L2 FEATURES > Spanning Tree > STP Config > STP Config** to load the following page. Enable MSTP function globally, here we leave the values of the other global parameters as default settings. **Click Apply.**

Figure 5-3 Configure the Global MSTP Parameters of the Switch

Global Config

Spanning Tree: Enable

Mode: MSTP

Apply

Parameters Config

CIST Priority: (0-61440, in increments of 4096)

Hello Time: seconds (1-10)

Max Age: seconds (6-40)

Forward Delay: seconds (4-30)

Tx Hold Count: pps (1-20)

Max Hops: (1-40)

Apply

- 2) Choose the menu **L2 FEATURES > Spanning Tree > STP Config > Port Config** to load the following page. Enable spanning tree function on port 1/0/1 and port 1/0/2. Here we leave the values of the other parameters as default settings. Click **Apply**.

Figure 5-4 Enable Spanning Tree Function on Ports

Port Config

UNIT1
LAGS

<input type="checkbox"/>	Port	Status	Priority	Ext-Path Cost	Int-Path Cost	Edge Port	P2P Link	MCheck	Port Mode	Port I
<input checked="" type="checkbox"/>	1/0/1	Enabled	128	Auto	Auto	Disabled	Auto	--	--	
<input checked="" type="checkbox"/>	1/0/2	Enabled	128	Auto	Auto	Disabled	Auto	--	--	
<input type="checkbox"/>	1/0/3	Disabled	128	Auto	Auto	Disabled	Auto	--	--	
<input type="checkbox"/>	1/0/4	Disabled	128	Auto	Auto	Disabled	Auto	--	--	
<input type="checkbox"/>	1/0/5	Disabled	128	Auto	Auto	Disabled	Auto	--	--	
<input type="checkbox"/>	1/0/6	Disabled	128	Auto	Auto	Disabled	Auto	--	--	
<input type="checkbox"/>	1/0/7	Disabled	128	Auto	Auto	Disabled	Auto	--	--	
<input type="checkbox"/>	1/0/8	Disabled	128	Auto	Auto	Disabled	Auto	--	--	
<input type="checkbox"/>	1/0/9	Disabled	128	Auto	Auto	Disabled	Auto	--	--	
<input type="checkbox"/>	1/0/10	Disabled	128	Auto	Auto	Disabled	Auto	--	--	

Total: 54
2 entries selected.

Cancel
Apply

- 3) Choose the menu **L2 FEATURES > Spanning Tree > MSTP Instance > Region Config** to load the following page. Set the region name as 1 and the revision level as 100. Click **Apply**.

Figure 5-5 Configuring the MST Region

Region Config

Region Name:

Revision: (0-65535)

- Choose the menu **L2 FEATURES > Spanning Tree > MSTP Instance > Instance Config**. Click Add, map VLAN101-VLAN103 to instance 1 and set the priority as 32768; map VLAN104-VLAN106 to instance 2 and set the priority as 32768. Click **Create**.

Figure 5-6 Configuring the VLAN-Instance Mapping

Instance Config

+ Add - Delete

<input type="checkbox"/>	Instance ID	Priority	VLAN ID	Operation
<input type="checkbox"/>	CIST	32768	1-100,107-4094,	<input type="checkbox"/> <input type="checkbox"/>
<input type="checkbox"/>	1	32768	101-103,	<input type="checkbox"/> <input type="checkbox"/>
<input type="checkbox"/>	2	32768	104-106,	<input type="checkbox"/> <input type="checkbox"/>

Total: 3

- Choose the menu **L2 FEATURES > Spanning Tree > MSTP Instance > Instance Port Config** to load the following page. Set the path cost of port 1/0/1 in instance 1 as **300000** so that port 1/0/1 of switch C can be selected as the designated port.

Figure 5-7 Configure the Path Cost of Port 1/0/1 In Instance 1

Instance Port Config

Instance ID:

UNIT1 | LAGS

<input type="checkbox"/>	Port	Priority	Path Cost	Port Role	Port Status	LAG
<input checked="" type="checkbox"/>	Gi1/0/1	128	<input type="text" value="300000"/>	Designated	Forwarding	---
<input type="checkbox"/>	Gi1/0/2	128	Auto	Disable	Disconnected	---
<input type="checkbox"/>	Gi1/0/3	128	Auto	--	--	---
<input type="checkbox"/>	Gi1/0/4	128	Auto	--	--	---
<input type="checkbox"/>	Gi1/0/5	128	Auto	--	--	---
<input type="checkbox"/>	Gi1/0/6	128	Auto	--	--	---
<input type="checkbox"/>	Gi1/0/7	128	Auto	--	--	---
<input type="checkbox"/>	Gi1/0/8	128	Auto	--	--	---
<input type="checkbox"/>	Gi1/0/9	128	Auto	--	--	---
<input type="checkbox"/>	Gi1/0/10	128	Auto	--	--	---

Total: 54 | 1 entry selected. |

- Click  Save to save the settings.

■ Configurations for Switch B

- 1) Choose the menu **L2 FEATURES > Spanning Tree > STP Config > STP Config** to load the following page. Enable MSTP function globally, here we leave the values of the other global parameters as default settings. **Click Apply.**

Figure 5-8 Configure the Global MSTP Parameters of the Switch

Global Config

Spanning Tree: Enable

Mode: MSTP

Apply

Parameters Config

CIST Priority: 32768 (0-61440, in increments of 4096)

Hello Time: 2 seconds (1-10)

Max Age: 20 seconds (6-40)

Forward Delay: 15 seconds (4-30)

Tx Hold Count: 5 pps (1-20)

Max Hops: 20 (1-40)

Apply

- 2) Choose the menu **L2 FEATURES > Spanning Tree > STP Config > Port Config** to load the following page. Enable the spanning tree function on port 1/0/1 and port 1/0/2. Here we leave the values of the other parameters as default settings. **Click Apply.**

Figure 5-9 Enable Spanning Tree Function on Ports

Port Config

UNIT1 LAGS

<input type="checkbox"/>	Port	Status	Priority	Ext-Path Cost	Int-Path Cost	Edge Port	P2P Link	MCheck	Port Mode	Port t
<input checked="" type="checkbox"/>	1/0/1	Enabled	128	Auto	Auto	Disabled	Auto	--	--	
<input checked="" type="checkbox"/>	1/0/2	Enabled	128	Auto	Auto	Disabled	Auto	--	--	
<input type="checkbox"/>	1/0/3	Disabled	128	Auto	Auto	Disabled	Auto	--	--	
<input type="checkbox"/>	1/0/4	Disabled	128	Auto	Auto	Disabled	Auto	--	--	
<input type="checkbox"/>	1/0/5	Disabled	128	Auto	Auto	Disabled	Auto	--	--	
<input type="checkbox"/>	1/0/6	Disabled	128	Auto	Auto	Disabled	Auto	--	--	
<input type="checkbox"/>	1/0/7	Disabled	128	Auto	Auto	Disabled	Auto	--	--	
<input type="checkbox"/>	1/0/8	Disabled	128	Auto	Auto	Disabled	Auto	--	--	
<input type="checkbox"/>	1/0/9	Disabled	128	Auto	Auto	Disabled	Auto	--	--	
<input type="checkbox"/>	1/0/10	Disabled	128	Auto	Auto	Disabled	Auto	--	--	

Total: 54 2 entries selected. Cancel Apply

- 3) Choose the menu **L2 FEATURES > Spanning Tree > MSTP Instance > Region Config** to load the following page. Set the region name as 1 and the revision level as 100. **Click Apply.**

Figure 5-10 Configuring the Region

Region Config

Region Name:

Revision: (0-65535)

- 4) Choose the menu **L2 FEATURES > Spanning Tree > MSTP Instance > Instance Config**. Map VLAN101-VLAN103 to instance 1 and set the Priority as 0; map VLAN104-VLAN106 to instance 2 and set the priority as 32768. Click **Create**.

Figure 5-11 Configuring the VLAN-Instance Mapping

Instance Config

+ Add - Delete

<input type="checkbox"/>	Instance ID	Priority	VLAN ID	Operation
<input type="checkbox"/>	CIST	32768	1-100,107-4094,	<input type="checkbox"/> <input type="checkbox"/>
<input type="checkbox"/>	1	0	101-103,	<input type="checkbox"/> <input type="checkbox"/>
<input type="checkbox"/>	2	32768	104-106,	<input type="checkbox"/> <input type="checkbox"/>

Total: 3

- 5) Choose the menu **L2 FEATURES > Spanning Tree > MSTP Instance > Instance Port Config** to load the following page. Set the path cost of port 1/0/2 in instance 2 as 300000 so that port 1/0/1 of switch A can be selected as the designated port.

Figure 5-12 Configure the Path Cost of Port 1/0/2 in Instance 2

Instance Port Config

Instance ID:

<input type="checkbox"/>	Port	Priority	Path Cost	Port Role	Port Status	LAG
<input type="checkbox"/>			300000			
<input checked="" type="checkbox"/>	Gi1/0/1	128	Auto	--	--	--
<input checked="" type="checkbox"/>	Gi1/0/2	128	300000	--	--	--
<input type="checkbox"/>	Gi1/0/3	128	Auto	--	--	--
<input type="checkbox"/>	Gi1/0/4	128	Auto	--	--	--
<input type="checkbox"/>	Gi1/0/5	128	Auto	--	--	--
<input type="checkbox"/>	Gi1/0/6	128	Auto	--	--	--
<input type="checkbox"/>	Gi1/0/7	128	Auto	--	--	--
<input type="checkbox"/>	Gi1/0/8	128	Auto	--	--	--
<input type="checkbox"/>	Gi1/0/9	128	Auto	--	--	--
<input type="checkbox"/>	Gi1/0/10	128	Auto	--	--	--

Total: 54 1 entry selected.

- 6) Click  Save to save the settings.

■ Configurations for Switch C

- 1) Choose the menu **L2 FEATURES > Spanning Tree > STP Config > STP Config** to load the following page. Enable MSTP function globally, here we leave the values of the other global parameters as default settings. **Click Apply.**

Figure 5-13 Configure the Global MSTP Parameters of the Switch

Global Config

Spanning Tree: Enable

Mode: MSTP

Apply

Parameters Config

CIST Priority: 32768 (0-61440, in increments of 4096)

Hello Time: 2 seconds (1-10)

Max Age: 20 seconds (6-40)

Forward Delay: 15 seconds (4-30)

Tx Hold Count: 5 pps (1-20)

Max Hops: 20 (1-40)

Apply

- 2) Choose the menu **L2 FEATURES > Spanning Tree > STP Config > Port Config** to load the following page. Enable the spanning tree function on port 1/0/1 and port 1/0/2. Here we leave the values of the other parameters as default settings. **Click Apply.**

Figure 5-14 Enable Spanning Tree Function on Ports

Port Config

UNIT1 LAGS

<input type="checkbox"/>	Port	Status	Priority	Ext-Path Cost	Int-Path Cost	Edge Port	P2P Link	MCheck	Port Mode	Port t
<input checked="" type="checkbox"/>	1/0/1	Enabled	128	Auto	Auto	Disabled	Auto	--	--	
<input checked="" type="checkbox"/>	1/0/2	Enabled	128	Auto	Auto	Disabled	Auto	--	--	
<input type="checkbox"/>	1/0/3	Disabled	128	Auto	Auto	Disabled	Auto	--	--	
<input type="checkbox"/>	1/0/4	Disabled	128	Auto	Auto	Disabled	Auto	--	--	
<input type="checkbox"/>	1/0/5	Disabled	128	Auto	Auto	Disabled	Auto	--	--	
<input type="checkbox"/>	1/0/6	Disabled	128	Auto	Auto	Disabled	Auto	--	--	
<input type="checkbox"/>	1/0/7	Disabled	128	Auto	Auto	Disabled	Auto	--	--	
<input type="checkbox"/>	1/0/8	Disabled	128	Auto	Auto	Disabled	Auto	--	--	
<input type="checkbox"/>	1/0/9	Disabled	128	Auto	Auto	Disabled	Auto	--	--	
<input type="checkbox"/>	1/0/10	Disabled	128	Auto	Auto	Disabled	Auto	--	--	

Total: 54 2 entries selected. Cancel Apply

- 3) Choose the menu **Spanning Tree > MSTP Instance > Region Config** to load the following page. Set the region name as 1 and the revision level as 100. **Click Apply.**

Figure 5-15 Configuring the Region

Region Config

Region Name:

Revision: (0-65535)

- 4) Choose the menu **L2 FEATURES > Spanning Tree > MSTP Instance > Instance Config**. Click Add, map VLAN101-VLAN103 to instance 1 and set the priority as 32768; map VLAN104-VLAN106 to instance 2 and set the priority as 0. Click **Create**.

Figure 5-16 Configuring the VLAN-Instance Mapping

Instance Config

+ Add - Delete

<input type="checkbox"/>	Instance ID	Priority	VLAN ID	Operation
<input type="checkbox"/>	CIST	32768	1-100,107-4094,	<input type="checkbox"/> <input type="checkbox"/>
<input type="checkbox"/>	1	32768	101-103,	<input type="checkbox"/> <input type="checkbox"/>
<input type="checkbox"/>	2	0	104-106,	<input type="checkbox"/> <input type="checkbox"/>

Total: 3

- 5) Click  Save to save the settings.

5.4 Using the CLI

■ Configurations for Switch A

- 1) Configure the spanning tree mode as MSTP, then enable spanning tree function globally.

```
Switch#configure
```

```
Switch(config)#spanning-tree mode mstp
```

```
Switch(config)#spanning-tree
```

- 2) Enable the spanning tree function on port 1/0/1 and port 1/0/2, and specify the path cost of port 1/0/1 in instance 1 as 300000.

```
Switch(config)#interface gigabitEthernet 1/0/1
```

```
Switch(config-if)#spanning-tree
```

```
Switch(config-if)#spanning-tree mst instance 1 cost 300000
```

```
Switch(config-if)#exit
```

```
Switch(config)#interface gigabitEthernet 1/0/2
```

```
Switch(config-if)#spanning-tree
```

```
Switch(config-if)#exit
```

- 3) Configure the region name as 1, the revision number as 100; map VLAN101-VLAN103 to instance 1; map VLAN104-VLAN106 to instance 2:

```
Switch(config)#spanning-tree mst configuration
```

```
Switch(config-mst)#name 1
```

```
Switch(config-mst)#revision 100
```

```
Switch(config-mst)#instance 1 vlan 101-103
```

```
Switch(config-mst)#instance 2 vlan 104-106
```

```
Switch(config-mst)#end
```

```
Switch#copy running-config startup-config
```

■ Configurations for Switch B

- 1) Configure the spanning tree mode as MSTP, then enable spanning tree function globally.

```
Switch#configure
```

```
Switch(config)#spanning-tree mode mstp
```

```
Switch(config)#spanning-tree
```

- 2) Enable the spanning tree function on port 1/0/1 and port 1/0/2, and specify the path cost of port 1/0/2 in instance 2 as 300000.

```
Switch(config)#interface gigabitEthernet 1/0/2
```

```
Switch(config-if)#spanning-tree
```

```
Switch(config-if)#spanning-tree mst instance 2 cost 300000
```

```
Switch(config-if)#exit
```

```
Switch(config)#interface gigabitEthernet 1/0/1
```

```
Switch(config-if)#spanning-tree
```

```
Switch(config-if)#exit
```

- 3) Configure the region name as 1, the revision number as 100; map VLAN101-VLAN103 to instance 1; map VLAN104-VLAN106 to instance 2; configure the priority of Switch B in instance 1 as 0 to set it as the root bridge in instance 1:

```
Switch(config)#spanning-tree mst configuration
```

```
Switch(config-mst)#name 1
```

```
Switch(config-mst)#revision 100
```

```
Switch(config-mst)#instance 1 vlan 101-103
```

```
Switch(config-mst)#instance 2 vlan 104-106
```

```
Switch(config-mst)#exit
Switch(config)#spanning-tree mst instance 1 priority 0
Switch(config)#end
Switch#copy running-config startup-config
```

■ Configurations for Switch C

- 1) Configure the spanning tree mode as MSTP, then enable spanning tree function globally.

```
Switch#configure
Switch(config)#spanning-tree mode mstp
Switch(config)#spanning-tree
```

- 2) Enable the spanning tree function on port 1/0/1 and port 1/0/2.

```
Switch(config)#interface range gigabitEthernet 1/0/1-2
Switch(config-if-range)#spanning-tree
Switch(config-if-range)#exit
```

- 3) Configure the region name as 1, the revision number as 100; map VLAN101-VLAN103 to instance 1; map VLAN104-VLAN106 to instance 2; configure the priority of Switch C in instance 2 as 0 to set it as the root bridge in instance 2:

```
Switch(config)#spanning-tree mst configuration
Switch(config-mst)#name 1
Switch(config-mst)#revision 100
Switch(config-mst)#instance 1 vlan 101-103
Switch(config-mst)#instance 2 vlan 104-106
Switch(config-mst)#exit
Switch(config)#spanning-tree mst instance 2 priority 0
Switch(config)#end
Switch#copy running-config startup-config
```

Verify the Configurations

■ Switch A

Verify the configurations of Switch A in instance 1:

```
Switch(config)#show spanning-tree mst instance 1
MST-Instance 1
```

```

Root Bridge
Priority   :0
Address   :00-0a-eb-13-12-ba
Internal Cost : 400000
Root Port : 1
Designated Bridge
Priority   :0
Address   :00-0a-eb-13-12-ba
Local Bridge
Priority   :32768
Address   :00-0a-eb-13-23-97

```

Interface	Prio	Cost	Role	Status	LAG
-----	----	-----	-----	-----	----
Gi1/0/1	128	300000	Root	Fwd	N/A
Gi1/0/2	128	200000	Altn	Blk	N/A

Verify the configurations of Switch A in instance 2:

```
Switch(config)#show spanning-tree mst instance 2
```

```
MST-Instance 2
```

```

Root Bridge
Priority   :0
Address   :3c-46-d8-9d-88-f7
Internal Cost : 200000
Root Port : 2
Designated Bridge
Priority   :0
Address   :3c-46-d8-9d-88-f7
Local Bridge

```

```

Priority   : 32768
Address   : 00-0a-eb-13-23-97
Interface Prio  Cost    Role   Status  LAG
-----
Gi1/0/1   128    200000 Desg   Fwd     N/A
Gi1/0/2   128    200000 Root   Fwd     N/A

```

■ Switch B

Verify the configurations of Switch B in instance 1:

```
Switch(config)#show spanning-tree mst instance 1
```

```
MST-Instance 1
```

```
Root Bridge
```

```
Priority   : 0
```

```
Address   : 00-0a-eb-13-12-ba
```

```
Local bridge is the root bridge
```

```
Designated Bridge
```

```
Priority   : 0
```

```
Address   : 00-0a-eb-13-12-ba
```

```
Local Bridge
```

```
Priority   : 0
```

```
Address   : 00-0a-eb-13-12-ba
```

```
Interface Prio  Cost    Role   Status
```

```
-----
```

```
Gi1/0/1   128    200000 Desg   Fwd
```

```
Gi1/0/2   128    200000 Desg   Fwd
```

Verify the configurations of Switch B in instance 2:

```
Switch(config)#show spanning-tree mst instance 2
```

```
MST-Instance 2
```

```
Root Bridge
```

```
Priority   : 0
```

```

Address    : 3c-46-d8-9d-88-f7
Internal Cost : 400000
Root Port  : 2
Designated Bridge
Priority    : 0
Address    : 3c-46-d8-9d-88-f7
Local Bridge
Priority    : 32768
Address    : 00-0a-eb-13-12-ba
Interface  Prio  Cost    Role    Status
-----  ----  -
Gi1/0/1   128   200000  Altn    Blk
Gi1/0/2   128   300000  Root    Fwd

```

■ Switch C

Verify the configurations of Switch C in instance 1:

```
Switch(config)#show spanning-tree mst instance 1
```

```
MST-Instance 1
```

```
Root Bridge
```

```
Priority    : 0
```

```
Address    : 00-0a-eb-13-12-ba
```

```
Internal Cost : 200000
```

```
Root Port  : 2
```

```
Designated Bridge
```

```
Priority    : 0
```

```
Address    : 00-0a-eb-13-12-ba
```

```
Local Bridge
```

```
Priority    : 32768
```

```
Address    : 3c-46-d8-9d-88-f7
```

```
Interface  Prio  Cost    Role    Status
-----  ----  -

```

```

Gi1/0/1    128    200000  Desg   Fwd
Gi1/0/2    128    200000  Root   Fwd

```

Verify the configurations of Switch C in instance 2:

```
Switch(config)#show spanning-tree mst instance 2
```

```
MST-Instance 2
```

```
Root Bridge
```

```
Priority   :0
```

```
Address    :3c-46-d8-9d-88-f7
```

```
Local bridge is the root bridge
```

```
Designated Bridge
```

```
Priority   :0
```

```
Address    :3c-46-d8-9d-88-f7
```

```
Local Bridge
```

```
Priority   :0
```

```
Address    :3c-46-d8-9d-88-f7
```

```

Interface  Prio   Cost     Role    Status
-----
Gi1/0/1    128    200000   Desg    Fwd
Gi1/0/2    128    200000   Desg    Fwd

```

6 Appendix: Default Parameters

Default settings of the Spanning Tree feature are listed in the following table.

Table 6-1 Default Settings of the Global Parameters

Parameter	Default Setting
Spanning-tree	Disabled
Mode	STP
CIST Priority	32768
Hello Time	2 seconds
Max Age	20 seconds
Forward Delay	15 seconds
Tx Hold Count	5 pps
Max Hops	20 hops

Table 6-2 Default Settings of the Port Parameters

Parameter	Default Setting
Status	Disabled
Priority	128
Ext-Path Cost	Auto
In-Path Cost	Auto
Edge Port	Disabled
P2P Link	Auto
MCheck	-----

Table 6-3 Default Settings of the MSTP Instance

Parameter	Default Setting
Status	Disabled
Revision Level	0

Parameter	Default Setting
Priority	32768
Port Priority	128
Path Cost	Auto

Table 6-4 Default Settings of the STP Security

Parameter	Default Setting
Loop Protect	Disabled
Root Protect	Disabled
TC Guard	Disabled
BPDU Protect	Disabled
BPDU Filter	Disabled
BPDU Forward	Enabled

Part 16

Configuring LLDP

CHAPTERS

1. LLDP
2. LLDP Configurations
3. LLDP-MED Configurations
4. Viewing LLDP Settings
5. Viewing LLDP-MED Settings
6. Configuration Example
7. Appendix: Default Parameters

1 LLDP

1.1 Overview

LLDP (Link Layer Discovery Protocol) is a neighbor discovery protocol that is used for network devices to advertise information about themselves to other devices on the network. This protocol is a standard IEEE 802.1ab defined protocol and runs over the Layer 2 (the data-link layer) , which allows for interoperability between network devices of different vendors.

With LLDP enabled, the switch can get its neighbors' information, and network administrators can use the NMS (Network Management System) to gather these information, helping them to know about the network topology, examine the network connectivity and troubleshoot the network faults.

LLDP-MED (LLDP for Media Endpoint Discovery) is an extension of LLDP and is used to advertise information between network devices and media endpoints. It is specially used together with Auto VoIP (Voice over Internet Protocol) to allow VoIP device to access the network. VoIP devices can use LLDP-MED for auto-configuration to minimize the configuration effort.

1.2 Supported Features

The switch supports LLDP and LLDP-MED.

LLDP allows the local device to encapsulate its management address, device ID, interface ID and other information into a LLDPDU (Link Layer Discovery Protocol Data Unit) and periodically advertise this LLDPDU to its neighbor devices. The neighbors store the received LLDPDU in a standard MIB (Management Information Base), making it possible for the information to be accessed by a NMS (Network Management System) using a management protocol such as the SNMP (Simple Network Management Protocol).

LLDP-MED allows the network device to send its information including Auto VoIP information, PoE (Power over Ethernet) capacity and more to the media endpoint devices (for example, IP phones) for auto-configuration. The media endpoint devices receive the Auto VoIP information and finish the auto-configuration, then send the voice traffic with the desired configuration, which can provide preferential treatment to the voice traffic.

2 LLDP Configurations

To configure LLDP function, follow the steps:

- 1) Configure the LLDP feature globally.
- 2) Configure the LLDP feature for the port.

2.1 Using the GUI

2.1.1 Configuring LLDP Globally

Choose the **L2 FEATURES > LLDP > LLDP Config > Global Config** to load the following page.

Figure 2-1 Global Config

Global Config		
LLDP:	<input type="checkbox"/>	Enable
LLDP Forwarding:	<input type="checkbox"/>	Enable
Apply		
Parameter Config		
Transmit Interval:	<input type="text" value="30"/>	seconds (5-32768)
Hold Multiplier:	<input type="text" value="4"/>	(2-10)
Transmit Delay:	<input type="text" value="2"/>	seconds (1-8192)
Reinitialization Delay:	<input type="text" value="2"/>	seconds (1-10)
Notification Interval:	<input type="text" value="5"/>	seconds (5-3600)
Fast Start Repeat Count:	<input type="text" value="3"/>	(1-10)
Apply		

Follow these steps to configure the LLDP feature globally.

- 1) In the **Global Config** section, enable LLDP. You can also enable the switch to forward LLDP messages when LLDP function is disabled. Click **Apply**.

LLDP	Enable or disable LLDP globally.
LLDP Forwarding	(Optional) Enable or disable LLDP forwarding when LLDP is disabled. When LLDP is disabled, this option can be enabled and the switch can forward LLDP packets.

- 3) In the **Parameter Config** section, configure the LLDP parameters. Click **Apply**.

Transmit Interval	Enter the interval between successive LLDP packets that are periodically sent from the local device to its neighbors. The default is 30 seconds.
Hold Multiplier	This parameter is a multiplier on the Transmit Interval that determines the actual TTL (Time To Live) value used in an LLDP packet. TTL is the duration that the neighbor device should hold the received LLDP packet before discarding it. The default value is 4. TTL= Hold Multiplier * Transmit Interval.
Transmit Delay	Specify the amount of time that the local device waits before sending another LLDP packet to its neighbors. When the local information changes, the local device will send LLDP packets to inform its neighbors. If frequent changes occur to the local device, LLDP packets will flood. After specifying a transmit delay time, the local device will wait for a delay time to send LLDP packets when changes occur to avoid frequent LLDP packet forwarding. The default is 2 seconds.
Reinitialization Delay	Specify the amount of delay from when Admin Status of ports becomes 'Disable' until reinitialization will be attempted. The default value is 2 seconds.
Notification Interval	Enter the interval between successive Trap messages that are periodically sent from the local device to the NMS. The default is 5 seconds.
Fast Start Repeat Count	Specify the number of LLDP packets that the local port sends when its Admin status is changed from Disable (or Rx_Only) to Tx&RX (or Tx_Only). The default is 3. In this case, the local device will shorten the Transmit Interval of LLDP packets to 1 second so it is quickly discovered by its neighbors. After the specified number of LLDP packets are sent, the Transmit Interval will be restored to the specified value.

2.1.2 Configuring LLDP For the Port

Choose the menu **L2 FEATURES > LLDP > LLDP Config > Port Config** to load the following page.

Figure 2-2 Port Config

Port Config

UNIT1		Admin Status	Notification Mode	Management Address	Included TLVs											
<input type="checkbox"/>	Port				PD	SC	SD	SN	SA	PV	VP	VA	LA	PS	FS	PW
<input type="checkbox"/>	1/0/1	Tx & Rx	Disabled		PD	SC	SD	SN	SA	PV	VP	VA	LA	PS	FS	PW
<input type="checkbox"/>	1/0/2	Tx & Rx	Disabled		PD	SC	SD	SN	SA	PV	VP	VA	LA	PS	FS	PW
<input type="checkbox"/>	1/0/3	Tx & Rx	Disabled		PD	SC	SD	SN	SA	PV	VP	VA	LA	PS	FS	PW
<input type="checkbox"/>	1/0/4	Tx & Rx	Disabled		PD	SC	SD	SN	SA	PV	VP	VA	LA	PS	FS	PW
<input type="checkbox"/>	1/0/5	Tx & Rx	Disabled		PD	SC	SD	SN	SA	PV	VP	VA	LA	PS	FS	PW
<input type="checkbox"/>	1/0/6	Tx & Rx	Disabled		PD	SC	SD	SN	SA	PV	VP	VA	LA	PS	FS	PW
<input type="checkbox"/>	1/0/7	Tx & Rx	Disabled		PD	SC	SD	SN	SA	PV	VP	VA	LA	PS	FS	PW
<input type="checkbox"/>	1/0/8	Tx & Rx	Disabled		PD	SC	SD	SN	SA	PV	VP	VA	LA	PS	FS	PW
<input type="checkbox"/>	1/0/9	Tx & Rx	Disabled		PD	SC	SD	SN	SA	PV	VP	VA	LA	PS	FS	PW
<input type="checkbox"/>	1/0/10	Tx & Rx	Disabled		PD	SC	SD	SN	SA	PV	VP	VA	LA	PS	FS	PW
Total: 54																

Follow these steps to configure the LLDP feature for the interface.

- 1) Select one or more ports to configure.
- 2) Configure the Admin Status and Notification Mode for the port.

Admin Status	<p>Specify the Admin Status for the port to deal with LLDP packets.</p> <p>Disabled: The port will not transmit LLDP packets or process the received LLDP packets.</p> <p>Tx_Only: The port will only transmit LLDP packets but not process the received LLDP packets.</p> <p>Rx_Only: The port will only process the received LLDP packets but not transmit LLDP packets.</p> <p>Tx & Rx: The port will transmit LLDP packets and process the received LLDP packets.</p>
Notification Mode	<p>Enable or disable the Notification mode for the port. With this option enabled, the local device will send Trap messages to inform the NMS when the information of the neighbor device connected to this port changes.</p>
Management Address	<p>Specify the Management IP address of the port to be notified to the neighbor. Value 0.0.0.0 means the port will notify its default management address to the neighbor.</p>

- 3) Select the TLVs (Type/Length/Value) included in the LLDP packets according to your needs.

Included TLVs

Configure the TLVs included in the outgoing LLDP packets.

The switch supports the following TLVs:

PD: Used to advertise the port description defined by the IEEE 802 LAN station.

SC: Used to advertise the supported functions and whether or not these functions are enabled.

SD: Used to advertise the system's description including the full name and version identification of the system's hardware type, software operating system, and networking software.

SN: Used to advertise the system name.

SA: Used to advertise the local device's management address to make it possible to be managed by SNMP.

PV: Used to advertise the 802.1Q VLAN ID of the port.

VP: Used to advertise the protocol VLAN ID of the port.

VA: Used to advertise the name of the VLAN which the port is in.

LA: Used to advertise whether the link is capable of being aggregated, whether the link is currently in an aggregation, and the port ID when it is in an aggregation.

PS: Used to advertise the port's attributes including the duplex and bit-rate capability of the sending IEEE 802.3 LAN node that is connected to the physical medium, the current duplex and bit-rate settings of the sending IEEE 802.3 LAN node and whether these settings are the result of auto-negotiation during link initiation or of manual set override action.

FS: Used to advertise the maximum frame size capability of the implemented MAC and PHY.

PW: Used to advertise the port's PoE (Power over Ethernet) support capabilities.

- 4) Click **Apply**.

2.2 Using the CLI

2.2.1 Global Config

Enable the LLDP feature on the switch and configure the LLDP parameters.

Step 1

configure

Enter global configuration mode.

Step 2	lldp Enable the LLDP feature on the switch.
Step 3	lldp forward_message (Optional) Enable the switch to forward LLDP messages when LLDP function is disabled.
Step 4	lldp hold-multiplier multiplier (Optional) Specify the amount of time the neighbor device should hold the received information before discarding it. This parameter is a multiplier on the Transmit Interval that determines the actual TTL (Time To Live) value used in an LLDP packet. TTL is the duration that the neighbor device should hold the received LLDP packet before discarding it. TTL= Hold Multiplier * Transmit Interval. <i>multiplier</i> : Specify the hold-multiplier. The valid value ranges from 2 to 10, and the default value is 4.
Step 5	lldp timer { tx-interval tx-interval tx-delay tx-delay reinit-delay reinit-delay notify-interval notify-interval fast-count fast-count } (Optional) Configure the timers for LLDP packet forwarding. <i>tx-interval</i> : Enter the interval between successive LLDP packets that are periodically sent from the local device to its neighbors. <i>tx-delay</i> : Specify the amount of time that the local device waits before sending another LLDP packet to its neighbors. The default is 2 seconds. <i>reinit-delay</i> : Specify the amount of time that the local device waits before sending another LLDP packet to its neighbors. The default is 2 seconds. <i>notify-interval</i> : Enter the interval between successive Trap messages that are periodically sent from the local device to the NMS. The default is 5 seconds. <i>fast-count</i> : Specify the number of packets that the local port sends when its Admin Status changes. The default is 3.
Step 6	show lldp Display the LLDP information.
Step 7	end Return to Privileged EXEC Mode.
Step 8	copy running-config startup-config Save the settings in the configuration file.

The following example shows how to configure the following parameters, lldp timer=4, tx-interval=30 seconds, tx-delay=2 seconds, reinit-delay=3 seconds, notify-interval=5 seconds, fast-count=3.

Switch#configure

Switch(config)#lldp

```
Switch(config)#lldp hold-multiplier 4
```

```
Switch(config)#lldp timer tx-interval 30 tx-delay 2 reinit-delay 3 notify-interval 5 fast-count 3
```

```
Switch(config)#show lldp
```

```
LLDP Status:          Enabled
```

```
LLDP Forward Message: Disabled
```

```
Tx Interval:         30 seconds
```

```
TTL Multiplier:      4
```

```
Tx Delay:            2 seconds
```

```
Initialization Delay: 2 seconds
```

```
Trap Notification Interval: 5 seconds
```

```
Fast-packet Count:   3
```

```
LLDP-MED Fast Start Repeat Count: 4
```

```
Switch(config)#end
```

```
Switch#copy running-config startup-config
```

2.2.2 Port Config

Select the desired port and set its Admin Status, Notification Mode and the TLVs included in the LLDP packets.

Step 1	configure Enter global configuration mode.
Step 2	interface {fastEthernet port range fastEthernet port-list gigabitEthernet port range gigabitEthernet port-list ten-gigabitEthernet port range ten-gigabitEthernet port-list } Enter interface configuration mode.
Step 3	lldp receive (Optional) Set the mode for the port to receive LLDP packets. It is enabled by default.
Step 4	lldp transmit (Optional) Set the mode for the port to send LLDP packets. It is enabled by default.
Step 5	lldp snmp-trap (Optional) Enable the Notification Mode feature on the port. If it is enabled, the local device will send trap messages to the NMS when neighbor information changed. It is disabled by default.

Step 6	lldp tlv-select (Optional) Configure the TLVs included in the outgoing LLDP packets. By default, the outgoing LLDP packets include all TLVs.
Step 7	show lldp interface { fastEthernet port gigabitEthernet port ten-gigabitEthernet port } Display LLDP configuration of the corresponding port.
Step 8	end Return to Privileged EXEC Mode.
Step 9	copy running-config startup-config Save the settings in the configuration file.

The following example shows how to configure the port 1/0/1. The port can receive and transmit LLDP packets, its notification mode is enabled and the outgoing LLDP packets include all TLVs.

Switch#configure

Switch(config)#lldp

Switch(config)#interface gigabitEthernet 1/0/1

Switch(config-if)#lldp receive

Switch(config-if)#lldp transmit

Switch(config-if)#lldp snmp-trap

Switch(config-if)#lldp tlv-select all

Switch(config-if)#show lldp interface gigabitEthernet 1/0/1

LLDP interface config:

gigabitEthernet 1/0/1:

Admin Status: TxRx

SNMP Trap: Enabled

TLV Status

--- -----

Port-Description Yes

System-Capability Yes

System-Description Yes

System-Name Yes

Management-Address Yes

Port-VLAN-ID	Yes
Protocol-VLAN-ID	Yes
VLAN-Name	Yes
Link-Aggregation	Yes
MAC-Physic	Yes
Max-Frame-Size	Yes
Power	Yes

Switch(config-if)#end

Switch#copy running-config startup-config

3 LLDP-MED Configurations

To configure LLDP-MED function, follow the steps:

- 1) Enable LLDP feature globally and configure the LLDP parameters for the ports.
- 2) Configuring LLDP-MED fast repeat count globally.
- 3) Enable and configure the LLDP-MED feature on the port.

Configuration Guidelines

LLDP-MED is used together with Auto VoIP to implement VoIP access. Besides the configuration of LLDP-MED feature, you also need configure the Auto VoIP feature. Refer to [Configuring QoS](#) for detailed instructions.

3.1 Using the GUI

3.1.1 Configuring LLDP Globally

Enable LLDP globally and configure the LLDP parameters for the ports. For the details of LLDP configuration, refer to [LLDP Configuration](#).

3.1.1 Configuring LLDP-MED Globally

Choose the menu **L2 FEATURES > LLDP > LLDP-MED Config > Global Config** to load the following page.

Figure 3-1 LLDP-MED Parameters Config

LLDP-MED Parameters Config

Fast Start Repeat Count: (1-10)

Device Class: Network Connectivity

Apply

Configure the Fast Start Count and view the current device class. Click **Apply**.

Fast Start Repeat Count

Specify the number of successive LLDP-MED frames that the local device sends when fast start mechanism is activated. The default is 4.

If the LLDP-MED status on the port is changed from Disable to Enable, the fast start mechanism will be activated, and the local device will send the specified number of LLDP packets carrying LLDP-MED information to the endpoints. After that, the Transmit Interval will be restored to the specified value.

Device Class	Displays the current device class. LLDP-MED defines two device classes: Network Connectivity Device and Endpoint Device. The switch is a Network Connectivity device.
---------------------	--

3.1.2 Configuring LLDP-MED for Ports

Choose the menu **L2 FEATURES > LLDP > LLDP-MED Config > Port Config** to load the following page.

Figure 3-2 LLDP-MED Port Config

Port Config			
UNIT1			
<input type="checkbox"/>	Port	LLDP-MED Status	Included TLVs
<input type="checkbox"/>	1/0/1	Disabled	Detail
<input type="checkbox"/>	1/0/2	Disabled	Detail
<input type="checkbox"/>	1/0/3	Disabled	Detail
<input type="checkbox"/>	1/0/4	Disabled	Detail
<input type="checkbox"/>	1/0/5	Disabled	Detail
<input type="checkbox"/>	1/0/6	Disabled	Detail
<input type="checkbox"/>	1/0/7	Disabled	Detail
<input type="checkbox"/>	1/0/8	Disabled	Detail
<input type="checkbox"/>	1/0/9	Disabled	Detail
<input type="checkbox"/>	1/0/10	Disabled	Detail
Total: 54			

Follow these steps to enable LLDP-MED:

- 1) Select the desired port and enable LLDP-MED. Click **Apply**.
- 2) Click **Detail** to enter the following page. Configure the TLVs included in the outgoing LLDP packets. If **Location Identification** is selected, you need configure the Emergency Number or select Civic Address to configure the details. Click **Apply**.

Figure 3-3 LLDP-MED Port Config-Detail

Included TLVs Detail(Port:1/0/1)

Included TLVs

All
 Network Policy
 Location Identification
 Extended Power-Via-MDI
 Inventory

Location Identification Parameters

Emergency Number
 Civic Address (Parameters in total should not exceed 230 characters in length)

What:

Country Code:

Language:

Province/State:

City/Township:

County/Parish/District:

Street:

House Number:

Name:

Postal/Zip Code:

Room Number:

Network Policy	Used to advertise VLAN configuration and the associated Layer 2 and Layer 3 attributes of the port to the Endpoint devices.
Location Identification	Used to assign the location identifier information to the Endpoint devices. If this option is selected, you can configure the emergency number or the detailed address of the Endpoint device in the Location Identification Parameters section.
Extended Power-Via-MDI	Used to advertise the detailed PoE information including power supply priority and supply status between LLDP-MED Endpoint devices and Network Connectivity devices.
Inventory	Used to advertise the inventory information. The Inventory TLV set contains seven basic Inventory management TLVs, that is, Hardware Revision TLV, Firmware Revision TLV, Software Revision TLV, Serial Number TLV, Manufacturer Name TLV, Model Name TLV and Asset ID TLV.
Emergency Number	Emergency number is Emergency Call Service ELIN identifier, which is used during emergency call setup to a traditional CAMA or ISDN trunk-based PSAP.

Civic Address	<p>The Civic address is defined to reuse the relevant sub-fields of the DHCP option for Civic Address based Location Configuration Information as specified by IETF.</p> <p>What: Specify the role type of the local device, DHCP Server, Switch or LLDP-MED Endpoint.</p> <p>Country Code: Enter the country code defined by ISO 3166 , for example, CN, US.</p> <p>Language, Province/State etc.: Enter the regular details.</p>
----------------------	---

3.2 Using the CLI

3.2.1 Global Config

Step 1	<p>configure</p> <p>Enter global configuration mode.</p>
Step 2	<p>lldp</p> <p>Enable the LLDP feature on the switch.</p>
Step 3	<p>lldp med-fast-count count</p> <p>(Optional) Specify the number of successive LLDP-MED frames that the local device sends when fast start mechanism is activated. When the fast start mechanism is activated, the local device will send the specified number of LLDP packets carrying LLDP-MED information.</p> <p><i>count:</i> The valid value are from 1 to 10. The default is 4.</p>
Step 4	<p>show lldp</p> <p>Display the LLDP information.</p>
Step 5	<p>end</p> <p>Return to Privileged EXEC Mode.</p>
Step 6	<p>copy running-config startup-config</p> <p>Save the settings in the configuration file.</p>

The following example shows how to configure LLDP-MED fast count as 4:

```
Switch#configure
```

```
Switch(config)#lldp
```

```
Switch(config)#lldp med-fast-count 4
```

```
Switch(config)#show lldp
```

```
LLDP Status:                Enabled
```

LLDP Forward Message:	Disabled
Tx Interval:	30 seconds
TTL Multiplier:	4
Tx Delay:	2 seconds
Initialization Delay:	2 seconds
Trap Notification Interval:	5 seconds
Fast-packet Count:	3
LLDP-MED Fast Start Repeat Count:	4

Switch(config)#end

Switch#copy running-config startup-config

3.2.2 Port Config

Select the desired port, enable LLDP-MED and select the TLVs (Type/Length/Value) included in the outgoing LLDP packets according to your needs.

Step 1	<p>configure</p> <p>Enter global configuration mode.</p>
Step 2	<p>interface {fastEthernet port range fastEthernet port-list gigabitEthernet port range gigabitEthernet port-list ten-gigabitEthernet port range ten-gigabitEthernet port-list }</p> <p>Enter interface configuration mode.</p>
Step 3	<p>lldp med-status</p> <p>(Optional) Enable the LLDP-MED on the port. It is disabled by default.</p>
Step 4	<p>lldp med-tlv-select { [inventory-management] [location] [network-policy] [power-management] [all] }</p> <p>(Optional) Configure the LLDP-MED TLVs included in the outgoing LLDP packets. By default, the outgoing LLDP packets include all TLVs.</p> <p>If LLDP-MED Location TLV is selected, configure the parameters as follows:</p> <p>lldp med-location {emergency-number identifier civic-address [language language province-state province-state lci-county-name county lci-city city street street house-number house-number name name postal-zipcode postal-zipcode room-number room-number post-office-box post-office-box additional additional country-code country-code what { dhcp-server endpoint switch }] }</p> <p>Configure the LLDP-MED Location TLV included in the outgoing LLDP packets. Used to assign the location identifier information to the Endpoint devices.</p> <p><i>identifier</i>: Configure the emergency number to call CAMA or PSAP. The number should contain 10-25 characters.</p> <p><i>language, province-state, county.etc</i>: Configure the address in the IETF defined address format.</p>

Step 5	show lldp interface { fastEthernet port gigabitEthernet port ten-gigabitEthernet port } Display LLDP configuration of the corresponding port.
Step 6	end Return to Privileged EXEC Mode.
Step 7	copy running-config startup-config Save the settings in the configuration file.

The following example shows how to enable LLDP-MED on port 1/0/1, configure the LLDP-MED TLVs included in the outgoing LLDP packets.

```
Switch(config)#lldp
```

```
Switch(config)#lldp med-fast-count 4
```

```
Switch(config)#interface gigabitEthernet 1/0/1
```

```
Switch(config-if)#lldp med-status
```

```
Switch(config-if)#lldp med-tlv-select all
```

```
Switch(config-if)#show lldp interface gigabitEthernet 1/0/1
```

```
LLDP interface config:
```

```
gigabitEthernet 1/0/1:
```

```
Admin Status: TxRx
```

```
SNMP Trap: Enabled
```

```
TLV Status
```

```
--- -----
```

```
Port-Description          Yes
```

```
System-Capability        Yes
```

```
System-Description       Yes
```

```
System-Name              Yes
```

```
Management-Address Yes
```

```
Port-VLAN-ID Yes
```

```
Protocol-VLAN-ID Yes
```

```
VLAN-Name Yes
```

```
Link-Aggregation Yes
```

```
MAC-Physic Yes
```



```
Max-Frame-Size      Yes
Power                Yes
LLDP-MED Status:    Enabled
TLV Status
```

```
--- -----
```

```
Network Policy      Yes
Location Identification  Yes
Extended Power Via MDI  Yes
Inventory Management  Yes
```

```
Switch(config)#end
```

```
Switch#copy running-config startup-config
```

4 Viewing LLDP Settings

This chapter introduces how to view the LLDP settings on the local device.

4.1 Using GUI

4.1.1 Viewing LLDP Device Info

■ Viewing the Local Info

Choose the menu **L2 FEATURES > LLDP > LLDP Config > Local Info** to load the following page.

Figure 4-1 Local Info

Auto Refresh

Auto Refresh: Enable Apply

Local Info

UNIT1

1

3

5

7

9

11

13

15

17

19

21

23

25

27

29

31

33

35

2

4

6

8

10

12

14

16

18

20

22

24

26

28

30

32

34

36

37

39

41

43

45

47

49

51

53

Selected

Unselected

Not Available

Port 1/0/1	
Local Interface:	1/0/1
Chassis ID Subtype:	MAC address
Chassis ID:	5C-E9-31-50-A6-34
Port ID Subtype:	Interface name
Port ID:	gigabitEthernet 1/0/1
TTL:	120
Port Description:	gigabitEthernet 1/0/1
System Name:	SG6654XHP
System Description:	Omada 48-Port Gigabit Stackable L3 Managed PoE+ Switch with 6 10G Slots

Follow these steps to view the local information:

- 1) In the **Auto Refresh** section, enable the Auto Refresh feature and set the Refresh Rate according to your needs. Click **Apply**.
- 2) In the **Local Info** section, select the desired port and view its associated local device information.

Local Interface	Displays the local port ID.
Chassis ID Subtype	Displays the Chassis ID type.
Chassis ID	Displays the value of the Chassis ID.
Port ID Subtype	Displays the Port ID type.
Port ID	Displays the value of the Port ID.
TTL	Specify the amount of time in seconds the neighbor device should hold the received information before discarding it.
Port Description	Displays the description of the local port.
System Name	Displays the system name of the local device.
System Description	Displays the system description of the local device.
System Capabilities Supported	Displays the supported capabilities of the local system.
System Capabilities Enabled	Displays the primary functions of the local device.
Management Address Type	Displays the management IP address type of the local device.
Management Address	Displays the management IP address of the local device.
Management Address Interface Type	Displays the interface numbering type that is used to define the interface ID.
Management Address Interface ID	Displays the interface ID that is used to identify the specific interface associated with the MAC address of the local device.
Management Address OID	Displays the OID (Object Identifier) of the local device. A value of 0 means that the OID is not provided.
Port VLAN ID(PVID)	Displays the PVID of the local port.
Port And Protocol VLAN ID(PPVID)	Displays the PPVID of the local port.

Port And Protocol Supported	Displays whether the local device supports port and protocol VLAN feature.
Port And Protocol VLAN Enabled	Displays the status of the port and protocol VLAN feature.
VLAN Name of VLAN 1	Displays the VLAN name of VLAN 1 for the local device.
Protocol Identify	Displays the particular protocol that the local device wants to advise.
Auto-negotiation Supported	Displays whether the local device supports auto-negotiation.
Auto-Negotiation Enable	Displays the status of auto-negotiation for the local device.
OperMau	Displays the OperMau (Optional Mau) field of the TLV configured by the local device.
Link Aggregation Supported	Displays whether the local device supports link aggregation.
Link Aggregation Enabled	Displays the status of link aggregation for the local device.
Aggregation Port ID	Displays the aggregation port ID of the local device.
Power Port Class	Displays the power port class of the local device.
PSE Power Supported	Displays whether the local device supports PSE power.
PSE Power Enabled	Displays the status of PSE power for the local device.
PSE Pairs Control Ability	Displays whether the PSE pairs can be controlled for the local device.
Maximum Frame Size	Displays the maximum frame size supported by the local device.

■ Viewing the Neighbor Info

Choose the menu **L2 FEATURES > LLDP > LLDP Config > Neighbor Info** to load the following page.

Figure 4-2 Neighbor Info

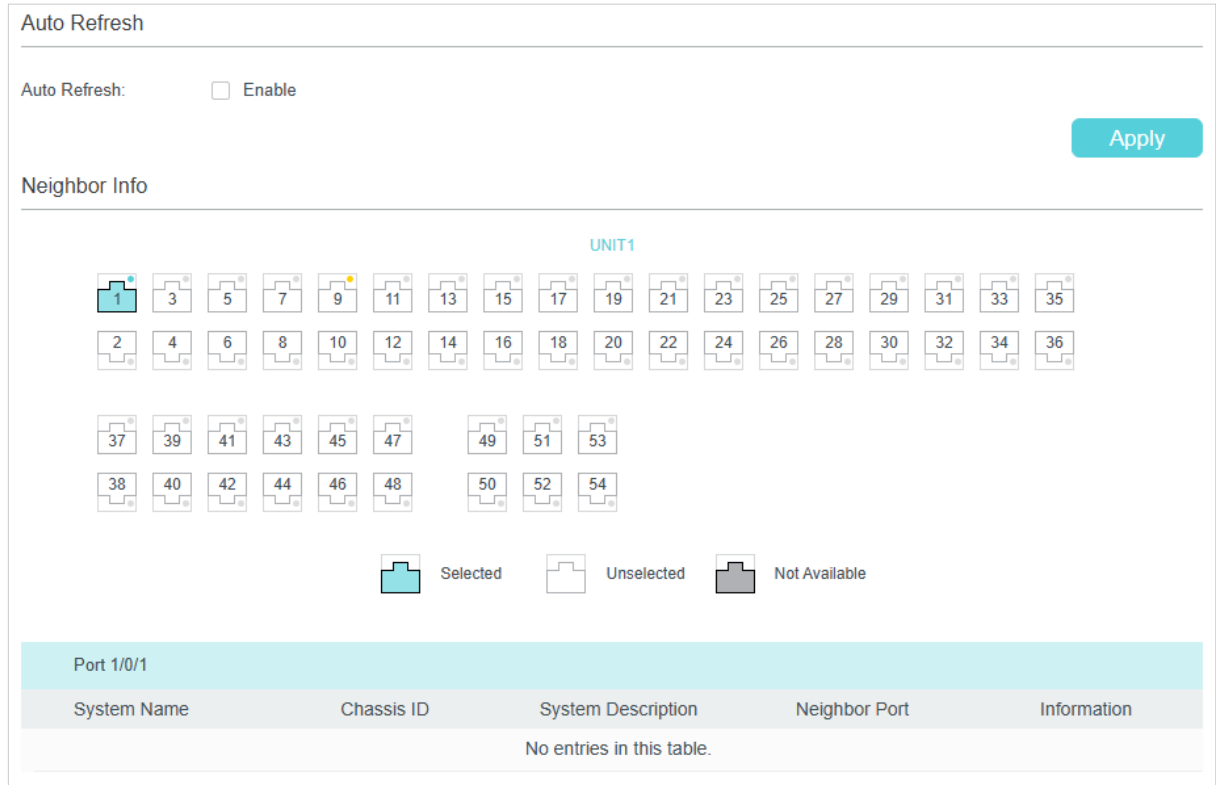

Follow these steps to view the neighbor information:

- 1) In the **Auto Refresh** section, enable the Auto Refresh feature and set the Refresh Rate according to your needs. Click **Apply**.
- 2) In the **Neighbor Info** section, select the desired port and view its associated neighbor device information.

System Name	Displays the system name of the neighbor device.
Chassis ID	Displays the Chassis ID of the neighbor device.
System Description	Displays the system description of the neighbor device.
Neighbor Port	Displays the port ID of the neighbor device which is connected to the local port.
Information	Click to view the details of the neighbor device.

4.1.2 Viewing LLDP Statistics

Choose the menu **L2 FEATURES > LLDP > LLDP Config > Statistics Info** to load the following page.

Figure 4-3 Static Info

Auto Refresh

Auto Refresh: Enable Apply

Global Statistics

Last Update	Total Inserts	Total Deletes	Total Drops	Total Age-outs
0 days 00h:19m:16s	0	0	0	0

Neighbor Statistics

UNIT1

↻ Refresh
 ✕ Clear

Port	Transmit Total	Receive Total	Discards	Errors	Age-outs	Discarded TLVs	Unknown TLVs
1/0/1	17	0	0	0	0	0	0
1/0/2	0	0	0	0	0	0	0
1/0/3	0	0	0	0	0	0	0
1/0/4	0	0	0	0	0	0	0
1/0/5	0	0	0	0	0	0	0
1/0/6	0	0	0	0	0	0	0
1/0/7	0	0	0	0	0	0	0
1/0/8	0	0	0	0	0	0	0
1/0/9	17	0	0	0	0	0	0
1/0/10	0	0	0	0	0	0	0
Total: 54							

Follow these steps to view LLDP statistics:

- 1) In the **Auto Refresh** section, enable the Auto Refresh feature and set the Refresh Rate according to your needs. Click **Apply**.
- 2) In the **Global Statistics** section, view the global statistics of the local device.

Last Update	Displays the latest update time of the statistics.
Total Inserts	Displays the total number of neighbors during latest update time.
Total Deletes	Displays the number of neighbors deleted by the local device. The port will delete neighbors when the port is disabled or the TTL of the LLDP packets sent by the neighbor is 0.
Total Drops	Displays the number of neighbors dropped by the local device. Each port can learn a maximum of 80 neighbor device, and the subsequent neighbors will be dropped when the limit is exceeded.

Total Age-outs	Displays the number of neighbors that have aged out on the local device.
----------------	--

3) In the **Neighbors Statistics** section, view the statistics of the corresponding port.

Transmit Total	Displays the number of LLDP packets sent by this port.
----------------	--

Receive Total	Displays the number of LLDP packets received by this port.
---------------	--

Discards	Displays the number of LLDP packets discarded by this port.
----------	---

Errors	Displays the number of error LLDP packets received by this port.
--------	--

Age-outs	Displays the number of the aged out neighbors that are connected to the port.
----------	---

Discarded TLVs	Displays the number of discarded TLVs.
----------------	--

Unknown TLVs	Displays the number of unknown TLVs received by this port.
--------------	--

4.2 Using CLI

■ Viewing the Local Info

```
show lldp local-information interface { fastEthernet port | gigabitEthernet port | ten-gigabitEthernet port }
```

View the LLDP details of a specific port or all the ports on the local device.

■ Viewing the Neighbor Info

```
show lldp neighbor-information interface { fastEthernet port | gigabitEthernet port | ten-gigabitEthernet port }
```

Display the information of the neighbor device which is connected to the port.

■ Viewing LLDP Statistics

```
show lldp traffic interface { fastEthernet port | gigabitEthernet port | ten-gigabitEthernet port }
```

View the statistics of the corresponding port on the local device.

5 Viewing LLDP-MED Settings

5.1 Using GUI

Choose the menu **L2 FEATURES > LLDP > LLDP-MED Config > Local Info** to load the following page.

■ Viewing the Local Info

Figure 5-1 LLDP-MED Local Info

Auto Refresh

Auto Refresh: Enable Apply

Local Info

UNIT1

1 3 5 7 9 11 13 15 17 19 21 23 25 27 29 31 33 35
 2 4 6 8 10 12 14 16 18 20 22 24 26 28 30 32 34 36
 37 39 41 43 45 47 49 51 53
 38 40 42 44 46 48 50 52 54

Selected
 Unselected
 Not Available

Port 1/0/1	
Local Interface:	1/0/1
Device Type:	Network Connectivity
Application Type:	Reserved
Unknown Policy Flag:	Yes
VLAN tagged:	0
Media Policy VLAN ID:	0
Media Policy Layer 2 Priority:	0
Media Policy DSCP:	0
Location Data Format:	Civic Address LCI

Follow these steps to view LLDP-MED local information:

- 1) In the **Auto Refresh** section, enable the Auto Refresh feature and set the Refresh Rate according to your needs. Click **Apply**.
- 2) In the **LLDP-MED Local Info** section, select the desired port and view the LLDP-MED settings.

Local Interface	Displays the local port ID.
Device Type	Displays the local device type defined by LLDP-MED.LLDP-MED.
Application Type	Displays the supported applications of the local device.
Unknown Policy Flag	Displays the unknown location settings included in the network policy TLV.
VLAN tagged	Displays the VLAN Tag type of the applications, tagged or untagged.
Media Policy VLAN ID	Displays the 802.1Q VLAN ID of the port.
Media Policy Layer 2 Priority	Displays the Layer 2 priority used in the specific application.
Media Policy DSCP	Displays the DSCP value used in the specific application.
Location Data Format	Displays the Location ID data format of the local device.
What	Displays the type of the local device.
Country Code	Displays the country code of the local device.
Power Type	Displays the whether the local device is a PSE device or PD device.
Power Source	Displays the power source of the local device.
Power Priority	Displays the power priority of the local device, which represents the priority of power that is received by the PD devices, or the priority of power that the PSE devices supply.
Power Value	Displays the power required by the PD device or supplied by the PSE device.
Hardware Revision	Displays the hardware revision of the local device.
Firmware Revision	Displays the firmware revision of the local device.
Software Revision	Displays the software revision of the local device.
Serial Number	Displays the serial number of the local device.
Manufacturer Name	Displays the manufacturer name of the local device.
Model Name	Displays the model name of the local device.

Asset ID	Displays the asset ID of the local device.
----------	--

■ Viewing the Neighbor Info

Choose the menu **L2 FEATURES > LLDP > LLDP-MED Config > Neighbor Info** to load the following page.

Figure 5-2 LLDP-MED Neighbor Info

Auto Refresh

Auto Refresh: Enable Apply

Neighbor Info

UNIT1

246810121416182022242628

13579111315171921232527

Selected
 Unselected
 Not Available

Port 1/0/1

Device Type	Application Type	Location Data Format	Power Type	Information
No Entries in this table.				

Follow these steps to view LLDP-MED neighbor information:

- 1) In the **Auto Refresh** section, enable the Auto Refresh feature and set the Refresh Rate according to your needs. Click **Apply**.
- 2) In the **Neighbor Info** section, select the desired port and view the LLDP-MED settings.

Device Type	Displays the LLDP-MED device type of the neighbor device.
Application Type	Displays the application type of the neighbor device.
Location Data Format	Displays the location type of the neighbor device.
Power Type	Displays the power type of the neighbor device.
Information	View more LLDP-MED details of the neighbor device.

5.2 Using CLI

■ Viewing the Local Info

```
show lldp local-information interface { fastEthernet port | gigabitEthernet port | ten-gigabitEthernet port }
```

View the LLDP details of a specific port or all the ports on the local device.

■ Viewing the Neighbor Info

```
show lldp neighbor-information interface { fastEthernet port | gigabitEthernet port | ten-gigabitEthernet port }
```

Display the information of the neighbor device which is connected to the port.

■ Viewing LLDP Statistics

```
show lldp traffic interface { fastEthernet port | gigabitEthernet port | tengigabitEthernet port }
```

View the statistics of the corresponding port.

6 Configuration Example

6.1 Configuration Example for LLDP

6.1.1 Network Requirements

The network administrator needs view the information of the devices in the company network to know about the link situation and network topology so that he can troubleshoot the potential network faults in advance.

6.1.2 Network Topology

Exemplified with the following situation:

Port Gi1/0/1 on Switch A is directly connected to port Gi1/0/2 on Switch B. Switch B is directly connected to the PC. The administrator can view the device information using the NMS.

Figure 6-1 LLDP Network Topology

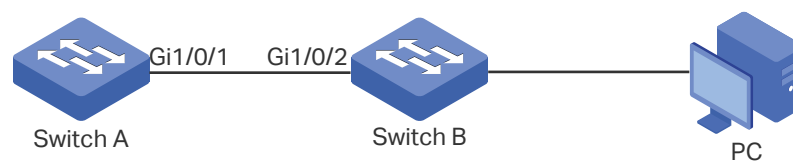

6.1.3 Configuration Scheme

LLDP can meet the network requirements. Enable the LLDP feature globally on Switch A and Switch B. Configure the related LLDP parameters on the corresponding ports.

Configuring Switch A and Switch B:

The configurations of Switch A and Switch B are similar. The following introductions take Switch A as an example. Demonstrated with SG6654XHP, this chapter provides configuration procedures in two ways: using the GUI and using the CLI.

6.1.4 Using the GUI

- 1) Choose the menu **L2 FEATURES > LLDP > LLDP Config > Global Config** to load the following page. Enable LLDP globally and configure the related parameters. Here we take the default settings as an example.

Figure 6-2 LLDP Global Config

Global Config

LLDP: **Enable**

LLDP Forwarding: Enable

Parameter Config

Transmit Interval: seconds (5-32768)

Hold Multiplier: (2-10)

Transmit Delay: seconds (1-8192)

Reinitialization Delay: seconds (1-10)

Notification Interval: seconds (5-3600)

Fast Start Repeat Count: (1-10)

- Choose the menu **L2 FEATURES > LLDP > LLDP Config > Port Config** to load the following page. Set the Admin Status of port Gi1/0/1 as Tx&Rx, enable Notification Mode and configure all the TLVs included in the outgoing LLDP packets.

Figure 6-3 LLDP Port Config

Port Config

UNIT1

<input type="checkbox"/>	Port	Admin Status	Notification Mode	Management Address	Included TLVs													
<input checked="" type="checkbox"/>	1/0/1	Tx & Rx	Enabled		<input checked="" type="checkbox"/>	<input checked="" type="checkbox"/>	<input checked="" type="checkbox"/>	<input checked="" type="checkbox"/>	<input checked="" type="checkbox"/>	<input checked="" type="checkbox"/>	<input checked="" type="checkbox"/>	<input checked="" type="checkbox"/>	<input checked="" type="checkbox"/>	<input checked="" type="checkbox"/>	<input checked="" type="checkbox"/>	<input checked="" type="checkbox"/>	<input checked="" type="checkbox"/>	<input checked="" type="checkbox"/>
<input type="checkbox"/>	1/0/2	Tx & Rx	Disabled		<input type="checkbox"/>	<input type="checkbox"/>	<input type="checkbox"/>	<input type="checkbox"/>	<input type="checkbox"/>	<input type="checkbox"/>	<input type="checkbox"/>	<input type="checkbox"/>	<input type="checkbox"/>	<input type="checkbox"/>	<input type="checkbox"/>	<input type="checkbox"/>	<input type="checkbox"/>	<input type="checkbox"/>
<input type="checkbox"/>	1/0/3	Tx & Rx	Disabled		<input type="checkbox"/>	<input type="checkbox"/>	<input type="checkbox"/>	<input type="checkbox"/>	<input type="checkbox"/>	<input type="checkbox"/>	<input type="checkbox"/>	<input type="checkbox"/>	<input type="checkbox"/>	<input type="checkbox"/>	<input type="checkbox"/>	<input type="checkbox"/>	<input type="checkbox"/>	<input type="checkbox"/>
<input type="checkbox"/>	1/0/4	Tx & Rx	Disabled		<input type="checkbox"/>	<input type="checkbox"/>	<input type="checkbox"/>	<input type="checkbox"/>	<input type="checkbox"/>	<input type="checkbox"/>	<input type="checkbox"/>	<input type="checkbox"/>	<input type="checkbox"/>	<input type="checkbox"/>	<input type="checkbox"/>	<input type="checkbox"/>	<input type="checkbox"/>	<input type="checkbox"/>
<input type="checkbox"/>	1/0/5	Tx & Rx	Disabled		<input type="checkbox"/>	<input type="checkbox"/>	<input type="checkbox"/>	<input type="checkbox"/>	<input type="checkbox"/>	<input type="checkbox"/>	<input type="checkbox"/>	<input type="checkbox"/>	<input type="checkbox"/>	<input type="checkbox"/>	<input type="checkbox"/>	<input type="checkbox"/>	<input type="checkbox"/>	<input type="checkbox"/>
<input type="checkbox"/>	1/0/6	Tx & Rx	Disabled		<input type="checkbox"/>	<input type="checkbox"/>	<input type="checkbox"/>	<input type="checkbox"/>	<input type="checkbox"/>	<input type="checkbox"/>	<input type="checkbox"/>	<input type="checkbox"/>	<input type="checkbox"/>	<input type="checkbox"/>	<input type="checkbox"/>	<input type="checkbox"/>	<input type="checkbox"/>	<input type="checkbox"/>
<input type="checkbox"/>	1/0/7	Tx & Rx	Disabled		<input type="checkbox"/>	<input type="checkbox"/>	<input type="checkbox"/>	<input type="checkbox"/>	<input type="checkbox"/>	<input type="checkbox"/>	<input type="checkbox"/>	<input type="checkbox"/>	<input type="checkbox"/>	<input type="checkbox"/>	<input type="checkbox"/>	<input type="checkbox"/>	<input type="checkbox"/>	<input type="checkbox"/>
<input type="checkbox"/>	1/0/8	Tx & Rx	Disabled		<input type="checkbox"/>	<input type="checkbox"/>	<input type="checkbox"/>	<input type="checkbox"/>	<input type="checkbox"/>	<input type="checkbox"/>	<input type="checkbox"/>	<input type="checkbox"/>	<input type="checkbox"/>	<input type="checkbox"/>	<input type="checkbox"/>	<input type="checkbox"/>	<input type="checkbox"/>	<input type="checkbox"/>
<input type="checkbox"/>	1/0/9	Tx & Rx	Disabled		<input type="checkbox"/>	<input type="checkbox"/>	<input type="checkbox"/>	<input type="checkbox"/>	<input type="checkbox"/>	<input type="checkbox"/>	<input type="checkbox"/>	<input type="checkbox"/>	<input type="checkbox"/>	<input type="checkbox"/>	<input type="checkbox"/>	<input type="checkbox"/>	<input type="checkbox"/>	<input type="checkbox"/>
<input type="checkbox"/>	1/0/10	Tx & Rx	Disabled		<input type="checkbox"/>	<input type="checkbox"/>	<input type="checkbox"/>	<input type="checkbox"/>	<input type="checkbox"/>	<input type="checkbox"/>	<input type="checkbox"/>	<input type="checkbox"/>	<input type="checkbox"/>	<input type="checkbox"/>	<input type="checkbox"/>	<input type="checkbox"/>	<input type="checkbox"/>	<input type="checkbox"/>

Total: 54 1 entry selected.

6.1.5 Using CLI

- Enable LLDP globally and configure the corresponding parameters.

Switch_A#configure

Switch_A(config)#lldp

```
Switch_A(config)#lldp hold-multiplier 4
```

```
Switch_A(config)#lldp timer tx-interval 30 tx-delay 2 reinit-delay 3 notify-interval 5 fast-
count 3
```

- 2) Set the Admin Status of port Gi1/0/1 to Tx&Rx, enable Notification Mode and configure all the TLVs included in the outgoing LLDP packets.

```
Switch_A#configure
```

```
Switch_A(config)#interface gigabitEthernet 1/0/1
```

```
Switch_A(config-if)#lldp receive
```

```
Switch_A(config-if)#lldp transmit
```

```
Switch_A(config-if)#lldp snmp-trap
```

```
Switch_A(config-if)#lldp tlv-select all
```

```
Switch_A(config-if)#end
```

```
Switch_A#copy running-config startup-config
```

Verify the Configurations

View LLDP settings globally

```
Switch_A#show lldp
```

```
LLDP Status:                Enabled
LLDP Forward Message:       Disabled
Tx Interval:                 30 seconds
TTL Multiplier:              4
Tx Delay:                    2 seconds
Initialization Delay:       2 seconds
Trap Notification Interval:  5 seconds
Fast-packet Count:          3
LLDP-MED Fast Start Repeat Count: 4
```

View LLDP settings on each port

```
Switch_A#show lldp interface gigabitEthernet 1/0/1
```

```
LLDP interface config:
```

```
gigabitEthernet 1/0/1:
```

```
Admin Status:                TxRx
SNMP Trap:                   Enabled
```

TLV	Status
---	-----
Port-Description	Yes
System-Capability	Yes
System-Description	Yes
System-Name	Yes
Management-Address	Yes
Port-VLAN-ID	Yes
Protocol-VLAN-ID	Yes
VLAN-Name	Yes
Link-Aggregation	Yes
MAC-Physic	Yes
Max-Frame-Size	Yes
Power	Yes
LLDP-MED Status:	Disabled
TLV	Status
---	-----
Network Policy	Yes
Location Identification	Yes
Extended Power Via MDI	Yes
Inventory Management	Yes

View the Local Info

```
Switch_A#show lldp local-information interface gigabitEthernet 1/0/1
```

```
LLDP local Information:
```

```
gigabitEthernet 1/0/1:
```

Chassis type:	MAC address
Chassis ID:	00:0A:EB:13:23:97
Port ID type:	Interface name
Port ID:	GigabitEthernet1/0/1
Port description:	GigabitEthernet1/0/1 Interface

TTL:	120
System name:	SG6654XHP
System description:	Omada 48-Port Gigabit Stackable L3 Managed PoE+ Switch with 6 10G Slots
System capabilities supported:	Bridge Router
System capabilities enabled:	Bridge Router
Management address type:	ipv4
Management address:	192.168.0.226
Management address interface type:	IfIndex
Management address interface ID:	1
Management address OID:	0
Port VLAN ID(PVID):	1
Port and protocol VLAN ID(PPVID):	0
Port and protocol VLAN supported:	Yes
Port and protocol VLAN enabled:	No
VLAN name of VLAN 1:	System-VLAN
Protocol identity:	
Auto-negotiation supported:	Yes
Auto-negotiation enabled:	Yes
OperMau:	speed(1000)/duplex(Full)
Link aggregation supported:	Yes
Link aggregation enabled:	No
Aggregation port ID:	0
Power port class:	PD
PSE power supported:	No
PSE power enabled:	No
PSE pairs control ability:	No
Maximum frame size:	1518
LLDP-MED Capabilities:	Capabilities Network Policy

Location Identification

Inventory

Device Type:	Network Connectivity
Application type:	Reserved
Unknown policy:	Yes
Tagged:	No
VLAN ID:	0
Layer 2 Priority:	0
DSCP:	0
Location Data Format:	Civic Address LCI
- What:	Switch
- Country Code:	CN
Hardware Revision:	T1600G-52TS 3.0
Firmware Revision:	Reserved
Software Revision:	3.0.0 Build 20170918 Rel.71414(s)
Serial Number:	Reserved
Manufacturer Name:	TP-Link
Model Name:	T1600G-52TS 3.0
Asset ID:	unknown

View the Neighbor Info

```
Switch_A#show lldp neighbor-information interface gigabitEthernet 1/0/1
```

```
LLDP Neighbor Information:
```

```
gigabitEthernet 1/0/1:
```

```
Neighbor index 1:
```

Chassis type:	MAC address
Chassis ID:	00:0A:EB:13:18:2D
Port ID type:	Interface name
Port ID:	GigabitEthernet1/0/2
Port description:	GigabitEthernet1/0/2 Interface
TTL:	120

System name:	SG6654X
System description:	Omada 48-Port Gigabit Stackable L3 Managed Switch with 6 10G Slots
System capabilities supported:	Bridge Router
System capabilities enabled:	Bridge Router
Management address type:	ipv4
Management address:	192.168.0.1
Management address interface type:	IfIndex
Management address interface ID:	1
Management address OID:	0
Port VLAN ID(PVID):	1
Port and protocol VLAN ID(PPVID):	0
Port and protocol VLAN supported:	Yes
Port and protocol VLAN enabled:	No
VLAN name of VLAN 1:	System-VLAN
Protocol identity:	
Auto-negotiation supported:	Yes
Auto-negotiation enabled:	Yes
OperMau:	speed(1000)/duplex(Full)
Link aggregation supported:	Yes
Link aggregation enabled:	No
Aggregation port ID:	0
Power port class:	PSE
PSE power supported:	Yes
PSE power enabled:	Yes
PSE pairs control ability:	No

6.2 Example for LLDP-MED

6.2.1 Network Requirements

As the following figure shows, an IP phone and a PC are both connected to port 1/0/1 of the switch. It is required that the voice data stream is sent to VLAN2 and other untagged data stream is sent to the default VLAN1.

Figure 6-1 LLDP-MED Network Topology



6.2.2 Configuration Scheme

LLDP-MED allows the switch to send its Auto VoIP information to the IP phones for auto-configuration. In this example, you can configure Auto VoIP and LLDP-MED to meet the network requirements.

The configuration overview is as follows:

- 1) Create VLAN2 for the voice data and keep the PVID of port 1/0/1 as the default value 1. In this way, all the untagged packets from the PC are sent to VLAN1; all the packets with VLAN Tag 2 from the IP phone are sent to VLAN2.
- 2) Configure Auto VoIP on port 1/0/1.
- 3) Enable LLDP globally.
- 4) Configure LLDP-MED on port 1/0/1.

Demonstrated with T1600G-28TS, this chapter provides configuration procedures in two ways: using the GUI and using the CLI.

6.2.3 Using the GUI

- 1) Choose the menu **L2 FEATURES > VLAN > 802.1Q VLAN > VLAN Config** and click **+ Add** to load the following page. Specify VLAN ID as 2, give a VLAN name, and select port 1/0/1 as untagged member port. Click **Create**.

Figure 6-2 VLAN Config

The screenshot displays the 'VLAN Config' interface. At the top, the 'VLAN ID' is set to 2 and the 'VLAN Name' is 'voice_vlan'. Below this, the 'Untagged Ports' section shows port 1/0/1 selected. A grid of port icons is visible, with port 1 highlighted in blue. The 'Tagged Ports' section is currently empty. At the bottom right, there are 'Cancel' and 'Create' buttons.

VLAN Config

VLAN ID: 2 (2-4094, format: 2,4-5,8)

VLAN Name: voice_vlan (1-16 characters)

Untagged Ports

Port: 1/0/1 (Format: 1/0/1, input or choose below)

UNIT1 LAGS

1 3 5 7 9 11 13 15 17 19 21 23 25 27 29 31 33 35 37 39

2 4 6 8 10 12 14 16 18 20 22 24 26 28 30 32 34 36 38 40

Select All

41 43 45 47 49 51 53

42 44 46 48 50 52 54

Selected Unselected Not Available

Tagged Ports

Port: (Format: 1/0/1, input or choose below)

UNIT1 LAGS

1 3 5 7 9 11 13 15 17 19 21 23 25 27 29 31 33 35 37 39

Cancel Create

- 2) Choose the menu **QoS > Auto VoIP** to load the following page. Select port 1/0/1, configure the interface mode as VLAN ID and set the VLAN ID value as 2. Click **Apply**.

Figure 6-3 Auto VoIP Config

Global Config

Auto VoIP: Enable

Port Config

UNIT1

<input type="checkbox"/>	Port	Interface Mode	Value	CoS Override Mode	Operational Status	DSCP Value
<input checked="" type="checkbox"/>	1/0/1	VLAN ID	2	Disabled	Disabled	0
<input type="checkbox"/>	1/0/2	Disable	0	Disabled	Disabled	0
<input type="checkbox"/>	1/0/3	Disable	0	Disabled	Disabled	0
<input type="checkbox"/>	1/0/4	Disable	0	Disabled	Disabled	0
<input type="checkbox"/>	1/0/5	Disable	0	Disabled	Disabled	0
<input type="checkbox"/>	1/0/6	Disable	0	Disabled	Disabled	0
<input type="checkbox"/>	1/0/7	Disable	0	Disabled	Disabled	0
<input type="checkbox"/>	1/0/8	Disable	0	Disabled	Disabled	0
<input type="checkbox"/>	1/0/9	Disable	0	Disabled	Disabled	0
<input type="checkbox"/>	1/0/10	Disable	0	Disabled	Disabled	0

Total: 54 1 entry selected.

- 3) Choose the menu **L2 FEATURES > LLDP > LLDP Config > Global Config** to load the following page. Enable LLDP globally and click **Apply**.

Figure 6-4 LLDP Global Config

Global Config

LLDP: Enable

LLDP Forwarding: Enable

- 4) Choose the menu **L2 FEATURES > LLDP > LLDP-MED Config > Port Config** to load the following page. Enable LLDP-MED on port 1/0/1 and click **Apply**.

Figure 6-5 LLDP-MED Config

Port Config

UNIT1

<input type="checkbox"/>	Port	LLDP-MED Status	Included TLVs
<input checked="" type="checkbox"/>	1/0/1	Enabled	Detail
<input type="checkbox"/>	1/0/2	Disabled	Detail
<input type="checkbox"/>	1/0/3	Disabled	Detail
<input type="checkbox"/>	1/0/4	Disabled	Detail
<input type="checkbox"/>	1/0/5	Disabled	Detail
<input type="checkbox"/>	1/0/6	Disabled	Detail
<input type="checkbox"/>	1/0/7	Disabled	Detail
<input type="checkbox"/>	1/0/8	Disabled	Detail
<input type="checkbox"/>	1/0/9	Disabled	Detail
<input type="checkbox"/>	1/0/10	Disabled	Detail

Total: 54 1 entry selected.

Cancel Apply

- 5) Click  Save to save the settings.

6.2.4 Using CLI

- 1) Create VLAN2 and add untagged port 1/0/1 to VLAN2.

```
Switch#configure
```

```
Switch(config)#vlan 2
```

```
Switch(config-vlan)#name voice_vlan
```

```
Switch(config-vlan)#exit
```

```
Switch(config)#interface gigabitEthernet 1/0/1
```

```
Switch(config-if)#switch general allowed vlan 2 untagged
```

```
Switch(config-if)#exit
```

- 2) Enable Auto VoIP globally.

```
Switch(config)#auto-voip
```

- 3) Configure Auto VoIP. On port 1/0/1, configure the interface mode as VLAN ID and set the VLAN ID value as 2.

```
Switch(config)#interface gigabitEthernet 1/0/1
```

```
Switch(config-if)#auto-voip 2
```

```
Switch(config-if)#exit
```

- 4) Enable LLDP globally.

```
Switch(config)#lldp
```

- 5) Enable LLDP-MED on port 1/0/1.

```
Switch(config)#interface gigabitEthernet 1/0/1
```

```
Switch(config-if)#lldp med-status
```

```
Switch(config-if)#end
```

```
Switch#copy running-config startup-config
```

Verify the Configurations

View VLAN settings:

```
Switch#show vlan
```

VLAN Name	Status	Ports
1	active	Gi1/0/1, Gi1/0/2, Gi1/0/3, Gi1/0/4, Gi1/0/5, Gi1/0/6, Gi1/0/7, Gi1/0/8, Gi1/0/9, Gi1/0/10, Gi1/0/11, Gi1/0/12, Gi1/0/13, Gi1/0/14, Gi1/0/15, Gi1/0/16, Gi1/0/17, Gi1/0/18, Gi1/0/19, Gi1/0/20, Gi1/0/21, Gi1/0/22, Gi1/0/23, Gi1/0/24, Gi1/0/25, Gi1/0/26, Gi1/0/27, Gi1/0/28
2	active	Gi1/0/1

View VoIP settings:

```
Switch#show auto-voip interface
```

```
Interface.Gi1/0/1
```

```
Auto-VoIP Interface Mode.      Enabled
```

```
Auto-VoIP VLAN ID.            2
```

```
Auto-VoIP COS Override.       False
```

```
Auto-VoIP DSCP Value.         0
```

```
Auto-VoIP Port Status.        Enabled
```

```
...
```

View global LLDP settings:

```
Switch_A#show lldp
```

```
LLDP Status:          Enabled
```

```
LLDP Forward Message: Disabled
```

```
...
```

View LLDP-MED settings on port 1/0/1:

```
Switch_A#show lldp interface gigabitEthernet 1/0/1
```

```
LLDP interface config:
```

```
gigabitEthernet 1/0/1:
```

```
...
```

```
LLDP-MED Status:      Enabled
```

```
TLV                   Status
```

```
---                   -----
```

```
Network Policy        Yes
```

```
Location Identification Yes
```

```
Extended Power Via MDI Yes
```

```
Inventory Management  Yes
```

7 Appendix: Default Parameters

Default settings of LLDP are listed in the following tables.

Default LLDP Settings

Table 7-1 Default LLDP Settings

Parameter	Default Setting
LLDP	Disabled
LLDP Forward Message	Disabled
Transmit Interval	30 seconds
Hold Multiplier	4
Transmit Delay	2 seconds
Reinitialization Delay	2 seconds
Notification Interval	5 seconds
Fast Start Repeat Count	3

Table 7-2 Default LLDP Settings on the Port

Parameter	Default Setting
Admin Status	Tx&Rx
Notification Mode	Disabled
Included TLVs	All

Default LLDP-MED Settings

Table 7-3 Default LLDP-MED Settings

Parameter	Default Setting
Fast Start Repeat Count	4
LLDP-MED Status (port)	Disabled
Included TLVs	All

Part 17

Configuring L2PT

(Only for Certain Devices)

CHAPTERS

1. Overview
2. L2PT Configuration
3. Configuration Example
4. Appendix: Default Parameters

1 Overview

Note:

L2PT is only available on certain devices. To check whether your device supports this feature, refer to the actual web interface. If L2PT is available, there is **L2 FEATURES > L2PT** in the menu structure.

L2PT (Layer 2 Protocol Tunneling) is used to transparently transmit layer 2 protocol data units (PDUs) between customer networks at different locations through a public ISP network. Upon receiving a PDU from the customer network, the switch replaces the destination MAC address of the PDU with a special multicast MAC address (01:00:0C:CD:CD:D0) and sends it to the ISP network. This PDU can then be identified and sent directly on the ISP network. Some terminology that is used in this section is defined as follows:

- **Edge Switch:** The switch that is connected to the customer network and placed on the boundary of the ISP network.
- **UNI:** User Network Interface, a port configured on the edge switch which is connected to the customer network.
- **NNI:** Network Network Interface, a port configured on the edge switch which is connected to the ISP network.

As shown in Figure 1-1, a customer has two local networks which are connected through the ISP network. When the two customer networks run the same Layer 2 protocol, the Layer 2 PDUs between them must be transmitted through the ISP network to perform Layer 2 protocol calculation (for example, calculating a spanning tree). Generally, the PDUs of the same Layer 2 protocol use the same destination MAC address. Therefore, when a Layer 2 PDU from a customer network reaches a edge switch in the ISP network, the switch cannot identify whether the PDU comes from a customer network or the ISP network and then the PDU will be discarded. As a result, the Layer 2 PDUs cannot be transmitted through the ISP network to the other side.

Figure 1-1 L2PT Application

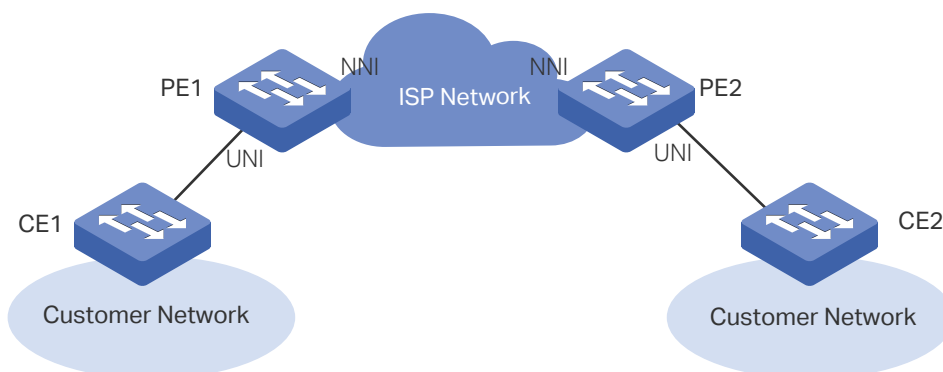

To resolve this problem, the ISP network should transparently transmit the Layer 2 PDUs between the two customer networks. In this case, L2PT feature can be configured on the edge switches (PE1 and PE2) to allow the Layer 2 PDUs to be tunneled through the network.

The following describes the PDUs transmission procedure through the ISP network from one customer network to the other side:

- 1) Upon receiving a Layer 2 PDU from CE1 via the UNI port, PE1 replaces the destination MAC address of the PDU with a special multicast MAC address (01:00:0c:cd:cd: d0) and then sends the PDU to the ISP network via the NNI port.
- 2) The ISP network identifies the PDU and directly forwards it to the other end.
- 3) PE2 receives the PDU via its NNI port and restores the destination MAC address of the PDU to its original destination MAC address.

With L2PT feature configured accordingly, the switch can transparently transmit the PDUs of the following Layer 2 protocols: STP (Spanning Tree Protocol), GVRP (GARP VLAN Registration Protocol), LACP (Link Aggregation Control Protocol), CDP (Cisco Discovery Protocol), VTP (VLAN Trunking Protocol), PAgP (Port Aggregation Protocol), UDLD (UniDirectional Link Detection) and PVST+(Per VLAN Spanning Tree Plus).

2 L2PT Configuration

2.1 Using the GUI

Choose the menu **L2 FEATURES > L2PT** to load the following page.

Figure 2-1 Configuring L2PT

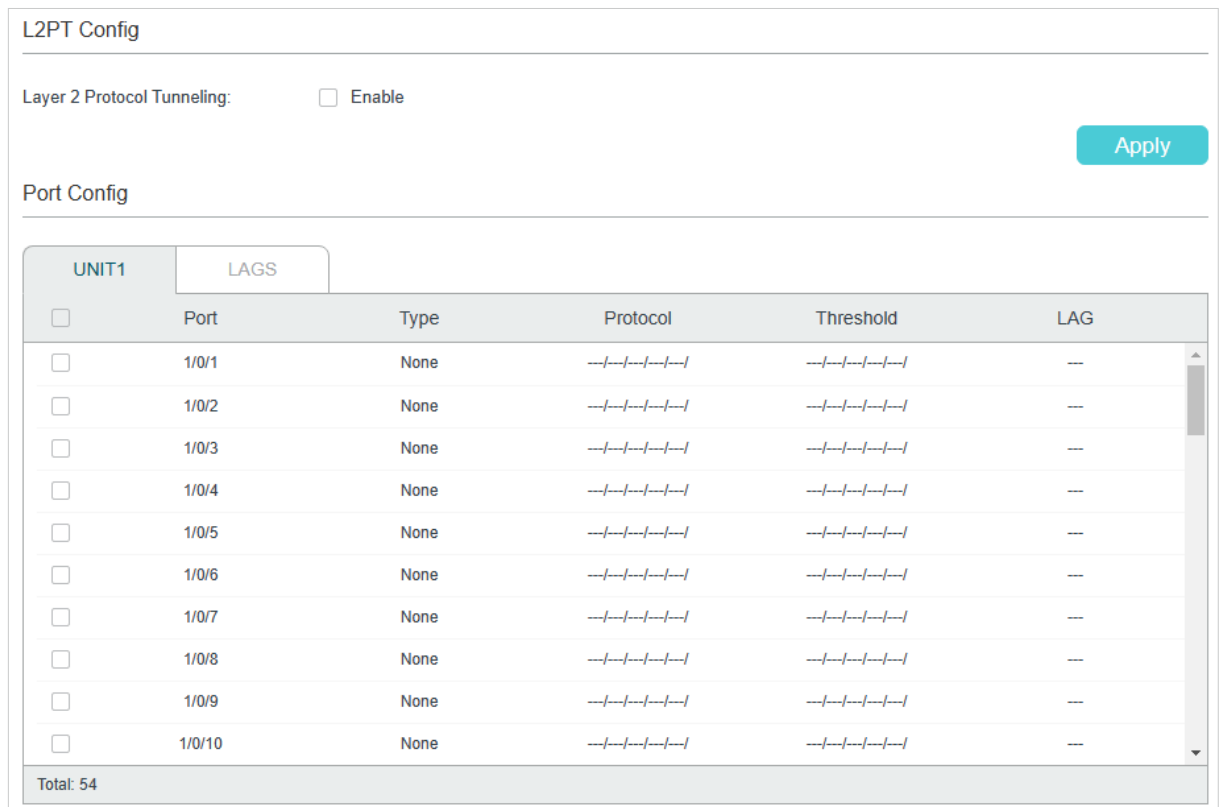

Follow these steps to configure L2PT:

- 1) In the **L2PT Config** section, enable L2PT globally and click **Apply**.
- 2) In the **Port Config** section, configure the port that is connected to the customer network as a UNI port and specify your desired protocols on the port. In addition, you can also set the threshold for packets-per-second to be processed on the UNI port.

Port	Select one or more ports to configure.
Type	Configure the port connected to the customer network as an UNI port, and connected to the ISP network as an NNI port. NONE means that L2PT is disabled on this port.

Protocol	<p>Specify the layer 2 protocol types of the packets that can be transparently transmitted on the UNI port.</p> <p>STP: Enable protocol tunneling for the GVRP packets.</p> <p>GVRP: Enable protocol tunneling for the GVRP packets.</p> <p>01000CCCCCCC: Enable protocol tunneling for the packets with the destination MAC address 01:00:0C:CC:CC:CC, which includes CDP, VTP, PAgP and UDLD.</p> <p>01000CCCCCD: Enable protocol tunneling for the PVST+ packets with the destination MAC address 01:00:0C:CC:CC:CD.</p> <p>LACP: Enable protocol tunneling for the LACP packets.</p> <p>All: All the above layer 2 protocols are supported for tunneling.</p>
Threshold	<p>Specify the maximum number of packets that can be processed for the specified protocol on the UNI port each second. When the threshold is exceeded, the port drops the specified layer 2 protocol packets.</p> <p>This value ranges from 1 to 1000 (packets per second). 0 indicates that the threshold feature is disabled.</p>
LAG	Displays the LAG that the port belongs to.

- 3) In the **Port Config** section, configure the port that is connected to the ISP network as an NNI port. Note that the protocols and threshold cannot be configured on the NNI port.

Port	Select one or more ports to configure.
Type	Configure the port connected to the customer network as an UNI port, and connected to the ISP network as an NNI port. NONE means that L2PT is disabled on this port.
LAG	Displays the LAG that the port belongs to.

- 4) Click **Apply**.

 **Note:**

If the port is a member port of an LAG, it will follow the L2PT configuration of the LAG and not its own.

2.2 Using the CLI

Follow these steps to configure L2PT feature.

Step 1	configure Enter global configuration mode.
Step 2	l2protocol-tunnel Enable the L2PT feature globally.

Step 3	<p>interface { fastEthernet port range fastEthernet port-list gigabitEthernet port range gigabitEthernet port-list ten-gigabitEthernet port range ten-gigabitEthernet port-list port-channel port-channel-id range port-channel port-channel-id-list }</p> <p>Enter interface configuration mode.</p>
Step 4	<p>I2protocol-tunnel type uni { 01000ccccccc 01000cccccd gvrp stp lacp all } [threshold threshold]</p> <p>Configure the port as a UNI port, specify the Layer 2 protocol types of the packets that can be transparently transmitted on the port, and set the threshold for packets-per-second accepted for encapsulation on the UNI port.</p> <p>01000ccccccc: Enable protocol tunneling for the packets with their destination MAC address as 01000CCCCCCC, which includes CDP, VTP, PAgP and UDLD.</p> <p>01000cccccd: Enable protocol tunneling for the PVST+ packets with the destination MAC address as 01000CCCCCD.</p> <p>gvrp: Enable protocol tunneling for the GVRP packets.</p> <p>stp: Enable protocol tunneling for the STP packets.</p> <p>lacp: Enable protocol tunneling for the LACP packets.</p> <p>all: All the above Layer 2 protocols are supported for tunneling.</p> <p>threshold: Set a threshold which determines the maximum number of packets to be processed for the specified protocol on the port in one second. When the threshold is exceeded, the port drops the specified Layer 2 protocol packets. The valid values are from 1 to 1000 (packets/second). 0 indicates that the threshold feature is disabled.</p>
Step 5	<p>exit</p> <p>Return to global configuration mode.</p>
Step 6	<p>interface { fastEthernet port range fastEthernet port-list gigabitEthernet port range gigabitEthernet port-list ten-gigabitEthernet port range ten-gigabitEthernet port-list port-channel port-channel-id range port-channel port-channel-id-list }</p> <p>Enter interface configuration mode.</p>
Step 7	<p>I2protocol-tunnel type nni</p> <p>Configure the port as an NNI port.</p>
Step 8	<p>show I2protocol-tunnel global</p> <p>Verify the global L2PT configuration.</p>
Step 9	<p>show I2protocol-tunnel interface [fastEthernet port gigabitEthernet port ten-gigabitEthernet port port-channel port-channel-id]</p> <p>Verify the L2PT configuration of the port or LAG.</p>
Step 10	<p>end</p> <p>Return to privileged EXEC mode.</p>
Step 11	<p>copy running-config startup-config</p> <p>Save the settings in the configuration file.</p>

 **Note:**

The member port of an LAG (Link Aggregation Group) follows the configuration of the LAG and not its own. The configurations of the port can take effect only after it leaves the LAG.

This example shows how to enable L2PT globally:

Switch#configure

Switch(config)#l2protocol-tunnel

Switch(config)#show l2protocol-tunnel global

l2protocol-tunnel State: Enable

Switch(config)#end

Switch#copy running-config startup-config

This example shows how to configure port 1/0/1 as a UNI port for the Layer 2 protocol GVRP and set the threshold as 1000:

Switch#configure

Switch(config)#interface gigabitEthernet 1/0/1

Switch(config-if)#l2protocol-tunnel type uni gvrp threshold 1000

Switch(config-if)#show l2protocol-tunnel interface gigabitEthernet 1/0/1

Interface	Type	Protocol	Threshold	LAG
-----	----	-----	-----	----
Gi1/0/1	uni	gvrp,--,--,--,--	1000,--,--,--,--	N/A

Switch(config-if)#end

Switch#copy running-config startup-config

This example shows how to configure port 1/0/5 as an NNI port.

Switch#configure

Switch(config)#interface gigabitEthernet 1/0/5

Switch(config-if)#l2protocol-tunnel type nni

Switch(config-if)#show l2protocol-tunnel interface gigabitEthernet 1/0/5

Interface	Type	Protocol	Threshold	LAG
-----	----	-----	-----	----

```
Gi1/0/5    nni    -----    -----    N/A
```

```
Switch(config-if)#end
```

```
Switch#copy running-config startup-config
```

3 Configuration Example

3.1 Network Requirements

As shown below, the two branches of a company are connected through the ISP network, and they want to achieve spanning tree calculation by exchanging Layer 2 STP packets with each other. To meet this requirement, the ISP network needs to transparently transmit the STP packets between the two customer networks.

Figure 3-1 Network Topology

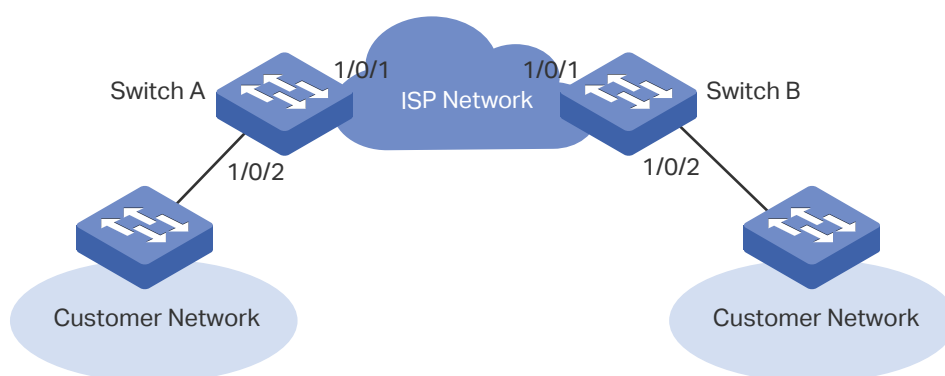

3.2 Configuration Scheme

The service provider can configure L2PT on the two edge switches (Switch A and Switch B). With the L2PT feature, the STP packets can be encapsulated as normal data packets and sent to the other side without being processed by the devices in the ISP network.

The overview of configuration is as follows:

- 1) Enable the L2PT feature globally.
- 2) Specify port 1/0/1 which is connected to the ISP network as an NNI port.
- 3) Specify port 1/0/2 which is connected to the customer network as a UNI port for the STP. In addition, configure the threshold as 1000 to limit the number of packets to be processed on the port in one second.

Demonstrated with T2600G-28TS, the following sections provide configuration procedure in two ways: using the GUI and using the CLI.

3.3 Using the GUI

The configurations of Switch A and Switch B are similar. The following introductions take Switch A as an example.

- 1) Choose the menu **L2 FEATURES > L2PT** to load the following page. Enable the L2PT feature globally and click **Apply**.
- 2) Specify port 1/0/1 as an NNI port and click **Apply**. Specify port 1/0/2 as a UNI port for the STP and set the threshold as 1000. Then click **Apply**. The configuration result is as follows:

Figure 3-2 Global Config

The screenshot shows the 'L2PT Config' interface. At the top, 'Layer 2 Protocol Tunneling' is set to 'Enable' (checked). A red box highlights the 'Apply' button in the top right. Below is the 'Port Config' section with tabs for 'UNIT1' and 'LAGS'. A table lists ports 1/0/1 through 1/0/10. The row for port 1/0/2 is highlighted in light blue and has a red box around it. In this row, the 'Type' is 'UNI', the 'Protocol' is 'STP', and the 'Threshold' is '1000'. At the bottom, there is a 'Total: 54' indicator, '1 entry selected.', and 'Cancel' and 'Apply' buttons. The 'Apply' button at the bottom right is also highlighted with a red box.

Port	Type	Protocol	Threshold	LAG
1/0/1	NNI	---	---	---
1/0/2	UNI	STP	1000	---
1/0/3	None	---	---	---
1/0/4	None	---	---	---
1/0/5	None	---	---	---
1/0/6	None	---	---	---
1/0/7	None	---	---	---
1/0/8	None	---	---	---
1/0/9	None	---	---	---
1/0/10	None	---	---	---

- 3) Click  **Save** to save the settings.

3.4 Using the CLI

The configurations of Switch A and Switch B are similar. The following introductions take Switch A as an example.

```
Switch_A#configure
```

```
Switch_A(config)#l2protocol-tunnel
```

```
Switch_A(config)#interface gigabitEthernet 1/0/1
```

```
Switch_A(config-if)#l2protocol-tunnel type nni
```

```
Switch_A(config-if)#exit
```

```
Switch_A(config)#interface gigabitEthernet 1/0/2
```

```
Switch_A(config-if)#l2protocol-tunnel type uni stp 1000
```

```
Switch_A(config-if)#end
```

```
Switch_A#copy running-config startup-config
```

Verify the Configuration

Verify the global configuration:

```
Switch_A#show l2protocol-tunnel global
```

```
l2protocol-tunnel State:    Enable
```

Verify the configuration on port 1/0/1:

```
Switch_A#show l2protocol-tunnel interface gigabitEthernet 1/0/1
```

Interface	Type	Protocol	Threshold	LAG
-----	----	-----	-----	----
Gi1/0/1	nni	--,--,--,--	--,--,--,--	N/A

Verify the configuration on port 1/0/2:

```
Switch_A#show l2protocol-tunnel interface gigabitEthernet 1/0/2
```

Interface	Type	Protocol	Threshold	LAG
-----	----	-----	-----	----
Gi1/0/2	uni	stp,--,--,--,--	1000,--,--,--,--	N/A

4 Appendix: Default Parameters

Default settings of L2PT are listed in the following table.

Table 4-1 Default Settings of L2PT

Parameter	Default Setting
L2PT Config	
Layer 2 Protocol Tunneling	Disable
Port Config	
Type	None
Protocol	None
Threshold	None

Part 18

Configuring PPPoE ID Insertion

(Only for Certain Devices)

CHAPTERS

1. Overview
2. PPPoE ID Insertion Configuration
3. Appendix: Default Parameters

1 Overview

Note:

PPPoE ID Insertion is only available on certain devices. To check whether your device supports this feature, refer to the actual web interface. If PPPoE ID Insertion is available, there is **L2 FEATURES > PPPoE** in the menu structure.

In common PPPoE (Point to Point Protocol over Ethernet) dialup mode, when users dial up through PPPoE, they can access the network as long as their accounts are authenticated successfully on the RADIUS server. As a result, illegal users can authenticate their accounts to access the internet. PPPoE ID Insertion resolves this problem by attaching a tag to the PPPoE Active Discovery packets. The tag records the client information, such as the connected port number and the MAC address of the client. If the client's tag information is different from the configured one, the authentication will fail. In this way, the illegal users cannot embezzle the accounts of legal users to access the Internet.

Additionally, after receiving the PPPoE Active Discovery Offer packet or Session-confirmation packet from the BRAS, the switch will remove the tag in the packet and send it to the client.

Figure 1-1 Network Topology of PPPoE ID-Insertion

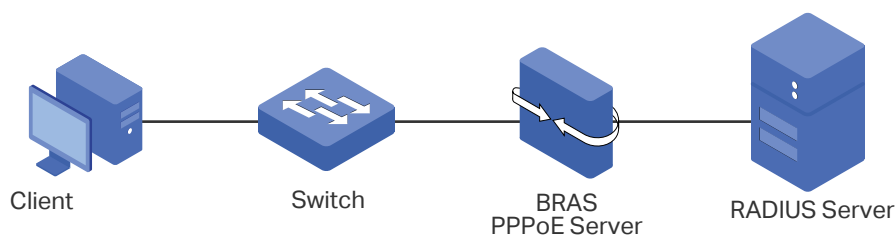

2 PPPoE ID Insertion Configuration

2.1 Using the GUI

Choose the menu **L2 FEATURES > PPPoE** to load the following page.

Figure 2-1 Configuring PPPoE ID Insertion

PPPoE ID Insertion

PPPoE ID Insertion: Enable Apply

Port Config

UNIT1

<input type="checkbox"/>	Port	Circuit-ID	Circuit-ID Type	UDF Value	Remote-ID	Remote-ID Value
<input type="checkbox"/>	1/0/1	Disabled	IP	---	Disabled	---
<input type="checkbox"/>	1/0/2	Disabled	IP	---	Disabled	---
<input type="checkbox"/>	1/0/3	Disabled	IP	---	Disabled	---
<input type="checkbox"/>	1/0/4	Disabled	IP	---	Disabled	---
<input type="checkbox"/>	1/0/5	Disabled	IP	---	Disabled	---
<input type="checkbox"/>	1/0/6	Disabled	IP	---	Disabled	---
<input type="checkbox"/>	1/0/7	Disabled	IP	---	Disabled	---
<input type="checkbox"/>	1/0/8	Disabled	IP	---	Disabled	---
<input type="checkbox"/>	1/0/9	Disabled	IP	---	Disabled	---
<input type="checkbox"/>	1/0/10	Disabled	IP	---	Disabled	---

Total: 54

Follow these steps to configure PPPoE ID-Insertion:

- 1) In the **PPPoE ID Insertion** section, enable PPPoE ID Insertion and click **Apply**.
- 2) In the **Port Config** section, select one or more ports, and configure the relevant parameters. Then click **Apply**.

Circuit-ID	Choose whether to insert a Circuit-ID into the received PPPoE Discovery packet on this port.
Circuit-ID Type	<p>Select the Circute-ID type. The following options are provided:</p> <p>IP: The circuit ID includes the following three parts: the source MAC address of the packet, the IP address of the switch and the port number. This is the default value.</p> <p>MAC: The circuit ID includes the following three parts: the source MAC address of the packet, the MAC address of the switch and the port number.</p> <p>UDF: The circuit ID includes the following three parts: the source MAC address of the packet, the user-specified string and the port number.</p> <p>UDF Only: Only the user specified string will be used to encode the Circuit-ID option.</p>
UDF Value	If UDF or UDF ONLY is selected, specify a string with a maximum of 40 characters to encode the Circuit-ID option.
Remote-ID	Enable or disable the switch to insert a Remote ID to the received PPPoE Discovery packet on this port.
Remote-ID Value	Specify a string to encode the Remote-ID option.

2.2 Using the CLI

Follow these steps to configure PPPoE ID Insertion:

Step 1	<p>configure</p> <p>Enter global configuration mode.</p>
Step 2	<p>pppoe id-insertion</p> <p>Globally enable the PPPoE ID Insertion feature.</p>
Step 3	<p>interface { fastEthernet port range fastEthernet port-list gigabitEthernet port range gigabitEthernet port-list ten-gigabitEthernet port range ten-gigabitEthernet port-list }</p> <p>Enter interface configuration mode.</p>
Step 4	<p>pppoe circuit-id</p> <p>Enable Circuit-ID Insertion feature, and the switch will insert a Circuit ID to the received PPPoE Discovery packet on this port.</p>

Step 5	<p>pppoe circuit-id type { mac ip udf [Value] udf-only [Value] }</p> <p>Specify the type of the Circuit ID. The following options are provided:</p> <p>mac: The source MAC address of the packet, the MAC address of the switch and the port number will be used to encode the Circuit-ID option.</p> <p>ip: The circuit ID includes the following three parts: the source MAC address of the received packet, the IP address of the switch and the port number. This is the default value.</p> <p>udf [Value]: Specify a string with at most 40 characters. The circuit ID includes the following three parts: the source MAC address of the packet, the user-specified string and the port number.</p> <p>udf-only [Value]: Specify a string with at most of 40 characters. Only the specified string will be used to encode the Circuit-ID option.</p>
Step 6	<p>pppoe remote-id [Value]</p> <p>Enable Remote-ID Insertion feature and specify the Remote ID.</p> <p>Value: Specify a string with at most 40 characters. The source MAC address of the packet and the specified string will be used to encode the Remote-ID option.</p>
Step 7	<p>show pppoe global</p> <p>Verify the global configuration of PPPoE ID Insertion.</p>
Step 8	<p>show pppoe interface { fastEthernet port gigabitEthernet port ten-gigabitEthernet port }</p> <p>Verify the configuration of PPPoE ID Insertion on the port.</p>
Step 9	<p>end</p> <p>Return to privileged EXEC mode.</p>
Step 10	<p>copy running-config startup-config</p> <p>Save the settings in the configuration file.</p>

The following example shows how to enable PPPoE ID Insertion globally and on port 1/0/1, and configure the Circuit-ID as 123 without other information and Remote-ID as host1.

Switch#configure

Switch(config)#pppoe id-insertion

Switch(config)#interface gigabitEthernet 1/0/1

Switch(config-if)#pppoe circuit-id

Switch(config-if)#pppoe circuit-id type udf-only 123

Switch(config-if)#pppoe remote-id host1

Switch(config-if)#show pppoe global

PPPoE ID Insertion State: Enable

Switch(config-if)#show pppoe port

SG6654X(config-if)#show pppoe port

Port	Circuit-ID	C-ID Type	C-ID Value(UDF)	Remote-ID	R-ID Value
Gi1/0/1	Enable	UDF-ONLY	123	Enable	host1
Gi1/0/2	Disable	IP	---	Disable	---
Gi1/0/3	Disable	IP	---	Disable	---
...					

Switch(config-if)#end

Switch#copy running-config startup-config

3 Appendix: Default Parameters

Default settings of L2PT are listed in the following table.

Table 3-1 PPPoE ID Insertion

Parameter	Default Setting
Global Config	
PPPoE ID Insertion	Disabled
Port Config	
Circuit-ID	Disabled
Circuit-ID Type	IP
UDF Value	None
Remote-ID	Disabled
Remote-ID Value	None

Part 19

Configuring Layer 3 Interfaces

CHAPTERS

1. Overview
2. Layer 3 Interface Configurations
3. Configuration Example
4. Appendix: Default Parameters

1 Overview

Interfaces are used to exchange data and interact with interfaces of other network devices. Interfaces are classified into Layer 2 interfaces and Layer 3 interfaces.

- Layer 2 interfaces are the physical ports on the switch panel. They forward packets based on MAC address table.
- Layer 3 interfaces are used to forward IPv4 and IPv6 packets using static or dynamic routing protocols. You can use Layer 3 interfaces for IP routing and inter-VLAN routing.

This chapter introduces the configurations for Layer 3 interfaces. The supported types of Layer 3 interfaces are shown as below:

Table 1-1 Supported Types of Layer 3 interfaces

Type	Description
VLAN Interface	A Layer 3 interface with which acts as the default gateway of all the hosts in the corresponding VLAN.
Loopback Interface	An interface of which the status is always up.
Routed Port	A physical port configured as an Layer 3 port.
Port-channel Interface	Several routed ports are bound together and configured as an Layer 3 interface.

2 Layer 3 Interface Configurations

To complete IPv4 interface configuration, follow these steps:

- 1) Create an Layer 3 interface
- 2) Configure IPv4 parameters of the created interface
- 3) View detailed information of the created interface

To complete IPv6 interface configuration, follow these steps:

- 1) Create an Layer 3 interface
- 2) Configure IPv6 parameters of the created interface
- 3) View detailed information of the created interface

2.1 Using the GUI

2.1.1 Creating an Layer 3 Interface

Choose the menu **L3 FEATURES> Interface** to load the following page.

Figure 2-1 Creating an Layer 3 Interface

Routing Config

IPv4 Routing: Enable

IPv6 Routing: Enable

[Apply](#)

Interface Config

[+](#) Add [-](#) Delete

	Interface ID	IP Address Mode	IP Address	Subnet Mask	Interface Name	Status	Operation
<input type="checkbox"/>	VLAN1	DHCP	192.168.0.1	255.255.255.0		Up	Edit IPv4 Edit IPv6 Detail
Total: 1							

Follow these steps to create an Layer 3 interface.

- 1) In the **Routing Config** section, enable IPv4 routing or IPv6 routing. Then click **Apply**.

IPv4 Routing	Enable IPv4 routing function globally for all Layer 3 interfaces. It is enabled by default.
IPv6 Routing	(Optional) Enable IPv6 routing function globally for all Layer 3 interfaces. It is disabled by default.

- 2) In the **Interface Config** section, click  **Add** to load the following page, and configure the corresponding parameters for the Layer 3 interface. Then click **Create**.

Interface

Interface ID: VLAN ▼ (1-4094)

IP Address Mode: None Static DHCP BOOTP

Admin Status: Enable

Interface Name: (Optional. 1-16 characters)

Cancel
Create

Interface ID	Select an interface type and enter the ID of the interface.
IP Address Mode	Specify the IP address assignment mode of the interface. None: No IP address will be assigned. Static: Assign an IP address manually. DHCP: Assign an IP address through DHCP. BOOTP: Assign an IP address through BOOTP.
DHCP Option 12	If you select DHCP as the IP Address Mode, configure the Option 12 here. DHCP Option 12 is used to specify the client's name.
IP Address	Specify the IP address of the interface if you choose "Static" as the IP address assignment mode.
Subnet Mask	Specify the subnet mask of the interface if you choose "Static" as the IP address assignment mode.
Admin Status	Enable or disable the interface's Layer 3 capabilities.
Interface Name	(Optional) Enter a name for the interface.

 **Note:**

The created interface is an IPv4 interface. To configure the IPv6 features, please click "Edit IPv6" after the interface is created.

2.1.2 Configuring IPv4 Parameters of the Interface

In **Figure 2-1** you can view the corresponding interface you have created in the **Interface List** section. On the corresponding interface entry, click **Edit IPv4** to load the following page and edit the IPv4 parameters of the interface.

Figure 2-2 Configuring the IPv4 Parameters

Modify IPv4 Interface

Interface ID: VLAN1

Admin Status: Enable

Interface Name: (Optional. 1-16 characters)

IP Address Mode: None Static DHCP BOOTP

IP Address: (Format: 192.168.0.1)

Subnet Mask: (Format: 255.255.255.0)

[Apply](#)

Secondary IP List

[+](#) Add [-](#) Delete

	ID	IP Address	Subnet Mask
No Entries in this table.			
Total: 0			

- 1) In the **Modify IPv4 Interface** section, configure relevant parameters for the interface according to your actual needs. Then click **Apply**.

Interface ID Displays the interface ID.

Admin Status Enable the Layer 3 capabilities for the interface.

Interface Name (Optional) Enter a name for the interface.

IP Address Mode Specify the IP address assignment mode of the interface.

None: No IP address will be assigned.

Static: Assign an IP address manually.

DHCP: Obtain an IP address through DHCP.

BOOTP: Obtain an IP address through BOOTP.

IP Address Specify the IP address of the interface if you choose "Static" as the IP address assignment mode.

Subnet Mask Specify the subnet mask of the interface if you choose "Static" as the IP address assignment mode.

DHCP Option 12 If you select DHCP as the IP Address Mode, configure the Option 12 here.

DHCP Option 12 is used to specify the client's name.

- 2) In the **Secondary IP List** section, click **+ Add** to add a secondary IP for the specified interface which allows you to have two logical subnets. Then click **Create**.

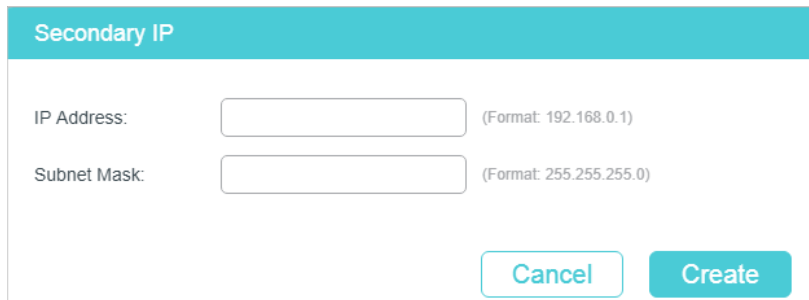

The screenshot shows a dialog box titled "Secondary IP" with a teal header. It contains two input fields: "IP Address:" and "Subnet Mask:". The "IP Address:" field has a placeholder "(Format: 192.168.0.1)" and the "Subnet Mask:" field has a placeholder "(Format: 255.255.255.0)". At the bottom right, there are two buttons: "Cancel" and "Create".

IP Address Specify the secondary IP address of the interface.

Subnet Mask Specify the subnet mask of the secondary IP address.

- 3) (Optional) In the **Secondary IP List** section, you can view the corresponding secondary IP entry you have created.

2.1.3 Configuring IPv6 Parameters of the Interface

In **Figure 2-1**, you can view the corresponding interface entry you have created in the **Interface List** section. On the corresponding interface entry, click **Edit IPv6** to load the following page and configure the IPv6 parameters of the interface.

Figure 2-3 Configuring the IPv6 Parameters

Modify IPv6 Interface

Interface ID: VLAN1

Admin Status: Enable

IPv6 Enable: Enable

Link-local Address Mode: Manual Auto

Link-local Address: (Format:3001::1)

Status: Normal

Enable global address auto configuration via RA message

Enable global address auto configuration via DHCPv6 Server

[Apply](#)

Global Address Table

[+](#) Add [-](#) Delete

	ID	Global Address	Prefix Length	Type	Preferred Lifetime	Valid Lifetime	Status
No Entries in this table.							
Total: 0							

1) In the **Modify IPv6 Interface** section, enable IPv6 feature for the interface and configure the corresponding parameters . Then click **Apply**.

Interface ID	Displays the interface ID.
Admin Status	Enable or disable the interface’s Layer 3 capabilities.
IPv6 Enable	Enable or disable IPv6 function on the interface of switch.
Link-local Address Mode	Select the link-local address configuration mode. Manual: With this option selected, you can assign a link-local address manually. Auto: With this option selected, the switch generates a link-local address automatically.
Link-local Address	Enter a link-local address if you choose “Manual” as the link-local address configuration mode.

Status	<p>Displays the status of the link-local address. An IPv6 address cannot be used before pass the DAD (Duplicate Address Detection), which is used to detect the address conflicts. In the DAD process, the IPv6 address may in three different status:</p> <p>Normal: Indicates that the link-local address is normal.</p> <p>Try: Indicates that the link-local address is newly configured and is in the progress of DAD (Duplicate Address Detection).</p> <p>Repeat: Indicates that the link-local address is duplicate. It is illegal to access the switch using the IPv6 address (including link-local and global address).</p>
---------------	--

2) Configure IPv6 global address of the interface via following three ways:

Via RA Message:

<p>Enable global address auto configuration via RA message</p>	<p>With this option enabled, the interface automatically generates a global address and other information according to the address prefix and other configuration parameters from the received RA (Router Advertisement) message.</p>
--	---

Via DHCPv6 Server:

<p>Enable global address auto configuration via DHCPv6 Server</p>	<p>With this option enabled, the switch will try to obtain the global address from the DHCPv6 Server.</p>
---	---

Manually:

In the **Global Address Config** section, click  **Add** to manually assign an IPv6 global address to the interface.

Global Address

Address Format: EUI-64 Not EUI-64

Global Address: (Format: 3001::1)

Prefix Length: (1-128)

Address Format	<p>Select the global address format according to your needs.</p> <p>EUI-64: Indicates that you only need to specify an address prefix, then the system will create a global address automatically.</p> <p>Not EUI-64: Indicates that you have to specify an intact global address.</p>
Global Address	<p>When EUI-64 is selected, please input the address prefix here, otherwise, please input an intact IPv6 address here.</p>
Prefix Length	<p>Configure the prefix length of the global address.</p>

3) View the global address entry in the Global Address Table.

Global Address	Displays the global address.
Prefix Length	Displays the prefix length of the global address.
Type	<p>Displays the configuration mode of the global address.</p> <p>Manual: Indicates the global IPv6 address is manually configured.</p> <p>Auto: Indicates the global IPv6 address is automatically created by using the RA message or assigned by the DHCpv6 server.</p>
Preferred Lifetime	<p>Displays the preferred lifetime of the global address.</p> <p>Preferred lifetime is the length of time that a valid IPv6 address is preferred. When the preferred time expires, the address becomes deprecated but still can be used, and you need to switch to another address.</p>
Valid Lifetime	<p>Displays the valid lifetime of the global address.</p> <p>Valid lifetime is the length of time that an IPv6 address is in the valid state. When the valid lifetime expires, the address become invalid and can be no longer usable.</p>
Status	<p>Displays the status of the global address. An IPv6 address cannot be used before pass the DAD (Duplicate Address Detection), which is used to detect the address conflicts. In the DAD process, the IPv6 address may in three different status:</p> <p>Normal: Indicates that the link-local address can be normally used by the interface.</p> <p>Try: Indicates that the link-local address is newly configured and is in the progress of DAD (Duplicate Address Detection).</p> <p>Repeat: Indicates that the link-local address is duplicated. It is illegal to access the switch using the IPv6 address (including link-local and global address).</p>

2.1.4 Viewing Detail Information of the Interface

In **Figure 2-1** you can view the corresponding interface entry you have created in the **Interface List** section. On the corresponding interface entry, click **Detail** to load the following page and view the detail information of the interface.

Figure 2-4 Viewing the detail information of the interface

Interface Detail		
Interface ID:VLAN1		
Detail Information		Interface Setting Detail Information
Interface ID:	1	MTU is 1500 byte
IP Address Mode:	Static	Directed broadcast forwarding is Disabled
IP Address:	192.168.0.1	ICMP redirects are never sent
Subnet Mask:	255.255.255.0	ICMP unreachable are never sent
Admin Status:	Enabled	ICMP mask replies are never sent
Interface Status:	Up	
Line Protocol Status:	Up	
Secondary IP:		
IPv6 Address Mode:	Enabled	MTU is 1500 byte
Link-Local Address:	fe80::20a:ebff:fe13:a23a	ND DAD is Enabled
Admin Status:	Enabled	ND retrans timer is 1000 ms
IPv6 Interface Status:	Up	ND reachable time is 30000 ms
Line Protocol Status:	Up	Global address auto configuration via RA message is Enabled
IPv6 Address:		Global address auto configuration via DHCPv6 Server is Disabled

2.2 Using the CLI

2.2.1 Creating an Layer 3 Interface

Follow these steps to create an Layer 3 interface. You can create a VLAN interface, a loopback interface, a routed port or a port-channel interface according to your needs.

-
- Step 1 **configure**
 Enter global configuration mode.
-

-
- Step 2 Create a VLAN interface:
- interface vlan *vlan-id***
vlan-id: Specify an IEEE 802.1Q VLAN ID that already exists, ranging from 1 to 4094.
- Create a loopback interface:
- interface loopback { *id* }**
id: Specify the ID of the loopback interface, ranging from 1 to 64.
- Create a routed port:
- interface { fastEthernet *port* | range fastEthernet *port-list* | gigabitEthernet *port* | range gigabitEthernet *port-list* | ten-gigabitEthernet *port* | range ten-gigabitEthernet *port-list* }**
- Enter interface configuration mode.
- port*: Specify the Ethernet port number, for example 1/0/1.
port-list: Specify the list of Ethernet ports, for example 1/0/1-3, 1/0/5.
- no switchport**
- Switch the Layer 2 port into the Layer 3 routed port.
- Create a port-channel interface:
- interface { port-channel *port-channel* | range port-channel *port-channel-list* }**
- Enter interface configuration mode.
- port-channel*: Specify the port channel, the valid value ranges from 1 to 14.
port-channel-list: Specify the list of the port-channel interface, for example 1-3, 5.
- no switchport**
- Switch the port channel to an Layer 3 port channel interface.
-
- Step 3 **description *string***
- Specify a description for the Layer 3 interface.
- string*: The description of the Layer 3 interface, ranging from 1 to 32 characters.
-
- Step 4 **end**
- Return to privileged EXEC mode.
-
- Step 5 **copy running-config startup-config**
- Save the settings in the configuration file.
-

The following example shows how to create a VLAN interface with a description of VLAN-2.

Switch#configure

Switch(config)#interface vlan 2

Switch(config-if)#description VLAN-2

Switch(config-if)#end

Switch#copy running-config startup-config

2.2.2 Configuring IPv4 Parameters of the Interface

Follow these steps to configure the IPv4 parameters of the interface.

Step 1	configure Enter global configuration mode.
Step 2	interface { interface-type } { interface-id} Enter Layer 3 interface configuration mode. <i>interface-type</i> : Type of the Layer 3 interface, including fastEthernet, gigabitEthernet, ten-gigabitEthernet, loopback and VLAN. <i>interface-id</i> : The interface ID.
Step 3	Automatically assign an IP Address for the interface via DHCP or BOOTP: ip address-alloc { dhcp bootp } Specify the IP Address assignment mode of the interface. <i>dhcp</i> : Specify the Layer 3 interface to obtain an IPv4 address from the DHCP Server. <i>bootp</i> : Specify the Layer 3 interface to obtain an IPv4 address from the BOOTP Server. Manually assign an IP Address for the interface: ip address { ip-addr } { mask } [secondary] Configure the IP address and subnet mask for the specified interface manually. <i>ip-addr</i> : Specify the IP address of the Layer 3 interface. <i>mask</i> : Specify the subnet mask of the Layer 3 interface. secondary : Specify the interface's secondary IP address which allows you to have two logical subnets. If this parameter is omitted here, the configured IP address is the interface's primary address.
Step 4	show ip interface brief Verify the summary information of the Layer 3 interfaces.
Step 5	end Return to privileged EXEC mode.
Step 6	copy running-config startup-config Save the settings in the configuration file.

The following example shows how to configure the IPv4 parameters of a routed port, including setting a static IP address for the port and enabling the Layer 3 capabilities:

Switch#configure

Switch(config)#interface gigabitEthernet 1/0/1

Switch(config-if)#no switchport

Switch(config-if)#ip address 192.168.0.100 255.255.255.0

Switch(config-if)#show ip interface brief

Interface	IP-Address	Method	Status	Protocol	Shutdown
-----	-----	-----	-----	-----	-----
Gi1/0/1	192.168.0.100/24	Static	Up	Up	no

Switch(config-if)#end**Switch#copy running-config startup-config**

2.2.3 Configuring IPv6 Parameters of the Interface

Follow these steps to configure the IPv6 parameters of the interface.

Step 1 **configure**

Enter global configuration mode.

Step 2 **interface { interface-type } { interface-id }**

Enter Layer 3 interface configuration mode.

interface-type: Type of the Layer 3 interface, including fastEthernet, gigabitEthernet, ten-gigabitEthernet, loopback and VLAN.

interface-id: The interface ID.

Step 3 **ipv6 enable**

Enable the IPv6 feature on the specified Layer 3 interface. By default, it is enabled on VLAN interface 1. IPv6 function can only be enabled on one Layer 3 interface at a time.

Step 4 Configure the IPv6 link-local address for the specified interface:

Manually configure the ipv6 link-local address for the specified interface:

ipv6 address ipv6-addr link-local

ipv6-addr: Specify the link-local address of the interface. It should be a standardized IPv6 address with the prefix fe80::/10, otherwise this command will be invalid.

Automatically configure the ipv6 link-local address for the specified interface:

ipv6 address autoconfig

Step 5	Configure the IPv6 global address for the specified interface:
	<p>Automatically configure the interface's global IPv6 address via RA message: ipv6 address ra Configure the interface's global IPv6 address according to the address prefix and other configuration parameters from its received RA (Router Advertisement) message.</p> <p>Automatically configure the interface's global IPv6 address via DHCPv6 server: ipv6 address dhcp Enable the DHCPv6 Client function. When this function is enabled, the Layer 3 interface will try to obtain the IPv6 address from DHCPv6 server.</p> <p>Manually configure the interface's global IPv6 address: ipv6 address ipv6-addr <i>ipv6-addr</i>: The Global IPv6 address with network prefix, for example 3ffe::1/64. ipv6 address ipv6-addr eui-64 Specify a global IPv6 address with an extended unique identifier (EUI) in the low-order 64 bits of the IPv6 address. Specify only the network prefix; the last 64 bits are automatically computed from the switch MAC address. This enables IPv6 processing on the interface.</p>
Step 6	show ipv6 interface Verify the configured ipv6 information of the interface.
Step 7	end Return to privileged EXEC mode.
Step 8	copy running-config startup-config Save the settings in the configuration file.

The following example shows how to enable the IPv6 function and configure the IPv6 parameters of a VLAN interface:

Switch#configure

Switch(config)#interface vlan 2

Switch(config-if)#ipv6 enable

Switch(config-if)#ipv6 address autoconfig

Switch(config-if)#ipv6 address dhcp

Switch(config-if)#show ipv6 interface

Vlan2 is up, line protocol is up

IPv6 is enable, Link-Local Address: fe80::20a:ebff:fe13:237b[NOR]

Global Address RA: Disable

Global Address DHCPv6: Enable

Global unicast address(es): ff02::1:ff13:237b

Joined group address(es): ff02::1

ICMP error messages limited to one every 1000 milliseconds

ICMP redirects are enable

MTU is 1500 bytes

ND DAD is enable, number of DAD attempts: 1

ND retrans timer is 1000 milliseconds

ND reachable time is 30000 milliseconds

Switch(config-if)#end

Switch#copy running-config startup-config

3 Configuration Example

3.1 Network Requirement

The administrator need to allow the hosts in VLANs can access the internet. The topology is shown as below.

Figure 3-1 Network Topology

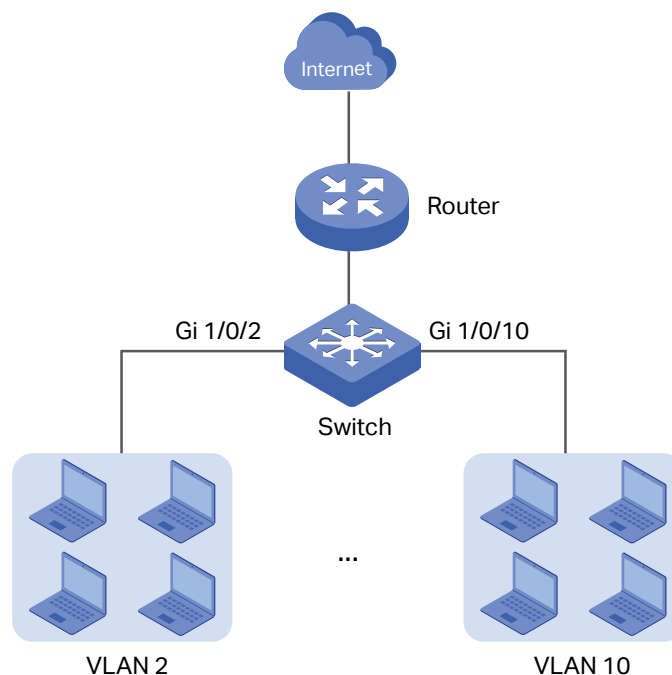

3.2 Configuration Scheme

For the hosts in VLANs are separated at layer 2. To make it possible for these host to access the internet, we need to configure a VLAN interface on the switch for each VLAN. The VLAN interface can be considered as the default gateway for the hosts in the VLAN. All the requests to internet are sent to the VLAN interface first, then the VLAN interface will forward the packets to the internet according to the routing table.

Demonstrated with SG6654XHP, this chapter provides configuration procedures in two ways: using the GUI and using the CLI.

3.3 Using the GUI

For the configurations for all the VLANs are similiar, here we only take the configuration of VLAN interface for VLAN 2 as an example.

- 1) Go to **L2 FEATURES > VLAN > 802.1Q VLAN** to create VLAN 2. Add port 1/0/2 to VLAN 2 with its egress rule as Untagged.

Table 3-2 Create VLAN 2

The screenshot shows the 'VLAN Config' window. At the top, 'VLAN ID' is set to 2 and 'VLAN Name' is set to VLAN 2. Below this, the 'Untagged Ports' section shows a grid of ports under 'UNIT1'. Port 1/0/2 is highlighted with a red box. At the bottom right, the 'Create' button is highlighted with a red box.

- 2) Go to **L3 FEATURES > Interface** to enable IPv4 routing (enabled by default), then click **+ Add** to create VLAN interface 2. Here we choose the IP address mode as **Static** and manually assign an IP address 192.168.2.1 to the interface.

Table 3-3 Create VLAN Interface 2

The screenshot shows the 'Interface Config' window. 'Interface ID' is set to VLAN 2. 'IP Address Mode' is set to Static, with IP Address 192.168.2.1 and Subnet Mask 255.255.255.0. 'Admin Status' is checked as 'Enable'. At the bottom right, the 'Create' button is highlighted with a red box.

- 3) Click **Save** to save the settings.

3.4 Using the CLI

- 1) Create VLAN 2 and add port 1/0/2 to VLAN 2 with its egress rule as Untagged.

Switch#configure

Switch(config)#vlan 2

```
Switch(config-vlan)#exit
```

```
Switch(config)#interface gigabitEthernet 1/0/2
```

```
Switch(config-if)#switchport general allowed vlan 2 untagged
```

```
Switch(config-if)#exit
```

- 2) Create VLAN interface 2 for VLAN 2. Configure the IP address of VLAN interface 2 as 192.168.2.1.

```
Switch(config)#interface vlan 2
```

```
Switch(config-if)#ip address 192.168.2.1 255.255.255.0
```

```
Switch(config-if)#end
```

```
Switch#copy running-config startup-config
```

Verify the VLAN Interface Configurations

Verify the configurations of VLAN interface 2.

```
Switch#show interface vlan 2
```

```
VLAN2 is down, line protocol is down
```

```
Hardware is CPU Interface, address is 00:0a:eb:13:a2:98
```

```
ip is 192.168.2.1/24
```

4 Appendix: Default Parameters

Default settings of interface are listed in the following tables.

Table 4-1 Default Settings of Routing Config

Parameter	Default Setting
IPv4 Routing	Enabled
IPv6 Routing	Disabled

Table 4-2 Configuring the IPv4 Parameters of the Interface

Parameter	Default Setting
Interface ID	VLAN
IP Address Mode	None
Admin Status	Enabled

Table 4-3 Configuring the IPv6 Parameters of the Interface

Parameter	Default Setting
Admin Status	Enabled
IPv6 Enable	Enabled
Link-local Address Mode	Auto
Enable global address auto configuration via RA message	Enabled
Enable global address auto configuration via DHCPv6 Server	Disabled

Part 20

Configuring Routing

CHAPTERS

1. Overview
2. IPv4 Static Routing Configuration
3. IPv6 Static Routing Configuration
4. Viewing Routing Table
5. RIP Configuration
6. RIPng Configuration
7. OSPF Configuration
8. OSPFv3 Configuration
9. Example for Static Routing

1 Overview

Routing table is used for a Layer 3 device (in this configuration guide, it means the switch) to forward packets to the correct destination. When the switch receives packets of which the source IP address and destination IP address are in different subnets, it will check the routing table, find the correct outgoing interface then forward the packets.

The routing table mainly contains two types of routing entries: dynamic routing entries and static routing entries.

Dynamic routing entries are automatically generated by the switch. The switch use dynamic routing protocols to automatically calculate the best route to forward packets. Dynamic routing protocols, such as OSPF (Open Shortest Path First) running in the network layer, would apply different working mechanism according to the features of different data link layers.

Static routing entries are manually added none-aging routing entries. In a simple network with a small number of devices, you only need to configure static routes to ensure that the devices from different subnets can communicate with each other. On a complex large-scale network, static routes ensure stable connectivity for important applications because the static routes remain unchanged even when the topology changes.

The switch supports IPv4 static routing and IPv6 static routing configuration.

2 IPv4 Static Routing Configuration

2.1 Using the GUI

Choose the menu **L3 FEATURES > Static Routing > IPv4 Static Routing** and click  **Add** to load the following page.

Figure 2-1 Configuring the IPv4 Static Routing

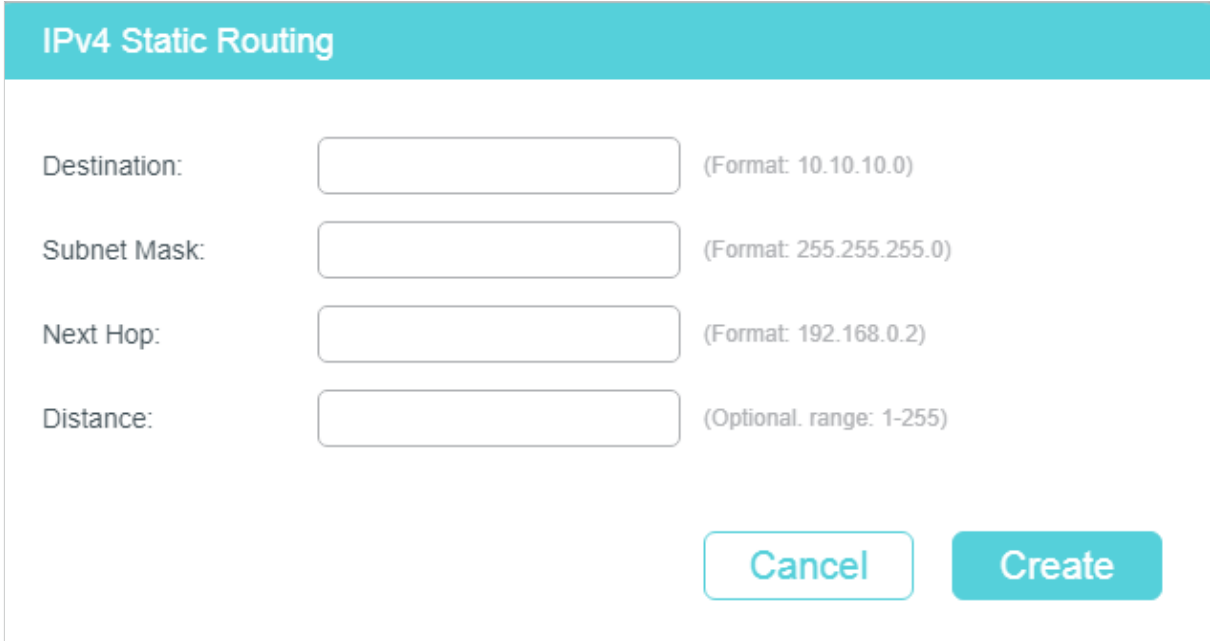

IPv4 Static Routing

Destination: (Format: 10.10.10.0)

Subnet Mask: (Format: 255.255.255.0)

Next Hop: (Format: 192.168.0.2)

Distance: (Optional, range: 1-255)

Configure the corresponding parameters to add an IPv4 static routing entry. Then click **Create**.

Destination	Specify the destination IPv4 address of the packets.
Subnet Mask	Specify the subnet mask of the destination IPv4 address.
Next Hop	Specify the IPv4 gateway address to which the packet should be sent next.
Distance	Specify the administrative distance. The distance is the trust rating of a routing entry. A higher value means a lower trust rating. Among routes to the same destination, the route with the lowest distance value will be recorded in the routing table. The valid value ranges from 1 to 255 and the default value is 1.

2.2 Using the CLI

Follow these steps to create an IPv4 static route.

Step 1	configure	Enter global configuration mode.
Step 2	ip route { dest-address } { mask } { next-hop-address } [distance]	<p>Add an IPv4 static route.</p> <p><i>dest-address</i>: Specify the destination IPv4 address of the packets. <i>mask</i>: Specify the subnet mask of the destination IPv4 address. <i>next-hop-address</i>: Specify the IPv4 gateway address to which the packet should be sent next.</p> <p><i>distance</i>: Specify the administrative distance, which is a rating of the trustworthiness of the routing information. A higher value means a lower trust rating. When more than one routing protocols have routes to the same destination, only the route that has the shortest distance will be recorded in the IP routing table. The valid values are from 1 to 255 and the default value is 1.</p>
Step 3	show ip route [static connected]	Verify the IPv4 route entries of the specified type.
Step 4	end	Return to privileged EXEC mode.
Step 5	copy running-config startup-config	Save the settings in the configuration file.

The following example shows how to create an IPv4 static route with the destination IP address as 192.168.2.0, the subnet mask as 255.255.255.0 and the next-hop address as 192.168.0.2:

Switch#configure

Switch(config)#ip route 192.168.2.0 255.255.255.0 192.168.0.2

Switch(config)#show ip route

Codes: C - connected, S - static

* - candidate default

C 192.168.0.0/24 is directly connected, Vlan1

S 192.168.2.0/24 [1/0] via 192.168.0.2, Vlan1

Switch(config)#end

Switch#copy running-config startup-config

3 IPv6 Static Routing Configuration

3.1 Using the GUI

Choose the menu **L3 FEATURES > Static Routing > IPv6 Static Routing > IPv6 Static Routing Table** and click **+ Add** to load the following page.

Figure 3-1 Configuring the IPv6 Static Routing

The screenshot shows a configuration window titled "IPv6 Static Routing". It contains the following fields and instructions:

- IPv6 Address:** (Format: 2001::)
- Prefix Length:** (Format: 64, range: 0-128)
- Next Hop:** (Format: 3001::2)
- Distance:** (Optional, range: 1-255)

At the bottom right, there are two buttons: "Cancel" and "Create".

Configure the corresponding parameters to add an IPv6 static routing entry. Then click **Create**.

IPv6 Address	Specify the destination IPv6 address of the packets.
Prefix Length	Specify the prefix length of the IPv6 address.
Next Hop	Specify the IPv6 gateway address to which the packet should be sent next.
Distance	Specify the administrative distance. The distance is the trust rating of a routing entry. A higher value means a lower trust rating. Among routes to the same destination, the route with the lowest distance value will be recorded in the routing table. The valid value ranges from 1 to 255 and the default value is 1

3.2 Using the CLI

Follow these steps to enable IPv6 routing function and create an IPv6 static route.

Step 1	configure Enter global configuration mode.
Step 2	ipv6 routing Enable the IPv6 routing function on the specified Layer 3 interface.
Step 3	ipv6 route { ipv6-dest-address } { next-hop-address } [distance] Add an IPv6 static route. <i>ipv6-dest-address</i> : Specify the destination IPv6 address of the packets, in the format of X:X:X::X/<0-128>. <i>next-hop-address</i> : Specify the IPv6 gateway address to which the packet should be sent next. <i>distance</i> : Specify the administrative distance, which is a rating of the trustworthiness of the routing information. A higher value means a lower trust rating. When more than one routing protocols have routes to the same destination, only the route that has the shortest distance will be recorded in the IP routing table. The valid values are from 1 to 255 and the default value is 1.
Step 4	show ipv6 route [static connected] Verify the IPv6 route entries of the specified type.
Step 5	end Return to privileged EXEC mode.
Step 6	copy running-config startup-config Save the settings in the configuration file.

The following example shows how to create an IPv6 static route with the destination IP address as 3200::/64 and the next-hop address as 3100::1234:

Switch#configure

Switch(config)#ipv6 route 3200::/64 3100::1234

Switch(config)#show ipv6 route static

Codes: C - connected, S - static

* - candidate default

C 3000::/64 is directly connected, Vlan1

S 3200::/64 [1/0] via 3100::1234, Vlan2

Switch(config)#end

Switch#copy running-config startup-config

4 Viewing Routing Table

You can view the routing tables to learn about the network topology. The switch supports IPv4 routing table and IPv6 routing table.

4.1 Using the GUI

4.1.1 Viewing IPv4 Routing Table

Choose the menu **L3 FEATURES > Routing Table > IPv4 Routing Table > IPv4 Routing Table** to load the following page.

Figure 4-1 Viewing IPv4 Routing Table

Protocol	Destination Network	Next Hop	Distance	Metric	Interface Name
Connected	192.168.0.0/24	192.168.0.26	0	1	
Static	192.168.30.0/24	192.168.0.36	5	0	
Total: 2					

View the IPv4 routing entries.

Protocol	Displays the type of the routing entry. Connected: The destination network is directed connected to the switch. Static: The routing entry is a manually added static routing entry.
Destination Network	Displays the destination network and subnet mask.
Next Hop	Displays the IP address of the next hop to which the packet is to be sent on the way to its final destination.
Distance	Displays the administrative distance, which is the trust rating of a routing entry. A higher value means a lower trust rating. When more than one routing protocol have routes to the same destination, only the route which has the smallest distance will be recorded in the IP routing table.
Metric	Displays the metric to reach the destination IP address.
Interface Name	Displays the gateway interface name.

4.1.2 Viewing IPv6 Routing Table

Choose the menu **L3 FEATURES > Routing Table > IPv6 Routing Table > IPv6 Routing Table** to load the following page.

Figure 4-2 Viewing IPv6 Routing Table

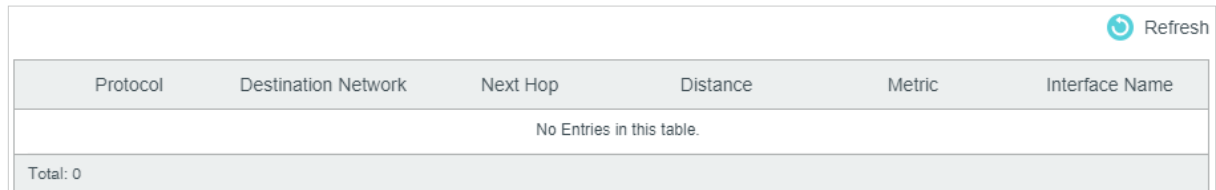

Protocol	Destination Network	Next Hop	Distance	Metric	Interface Name
No Entries in this table.					
Total: 0					

View the IPv6 routing entries.

Protocol	Displays the type of the routing entry. Connected: The destination network is directly connected to the switch. Static: The routing entry is a manually added static routing entry.
Destination Network	Displays the destination IPv6 network address and subnet mask.
Next Hop	Displays the IPv6 address of the next station to which the packet is to be sent on the way to its final destination.
Distance	Displays the administrative distance, which is the trust rating of a routing entry. A higher value means a lower trust rating. When more than one routing protocol has routes to the same destination, only the route which has the smallest distance will be recorded in the IP routing table.
Metric	Displays the metric to reach the destination IPv6 address.
Interface Name	Displays the gateway interface name.

4.2 Using the CLI

4.2.1 Viewing IPv4 Routing Table

On privileged EXEC mode or any other configuration mode, you can use the following command to view IPv4 routing table:

```
show ip route [ static | connected ]
```

View the IPv4 route entries of the specified type. If not specified, all types of route entries will be displayed.

static: View the static routes.

connected: View the connected routes.

4.2.2 Viewing IPv6 Routing Table

On privileged EXEC mode or any other configuration mode, you can use the following command to view IPv6 routing table:

show ipv6 route [static | connected]

View the IPv6 route entries of the specified type. If not specified, all types of route entries will be displayed.

static: View the static IPv6 routes.

connected: View the connected IPv6 routes.

5 RIP Configurations

RIP (Routing Information Protocol) is a routing protocol suitable for small networks and has lower requirements in terms of bandwidth, configuration, and management. As a routing protocol based on distance vector algorithm, RIP uses hop count as the measurement standard.

5.1 Using the CLI

5.1.1 Enabling RIP Function

Follow these steps to enable the RIP function on the switch.

Step 1	configure Enter global configuration mode.
Step 2	router rip Enable the RIP function. Only when the RIP function is enabled can the global configuration of the RIP function be performed. When the RIP function is disabled, the global configuration of the RIP function will be cleared. To disable this function, use the no router rip command.
Step 3	end Return to privileged EXEC mode.
Step 4	copy running-config startup-config Save the settings in the configuration file.

The following example shows how to enable the RIP function on the switch:

```
Switch#configure
Switch(config)#router rip
Switch(config-rtr)#end
Switch#copy running-config startup-config
```

5.1.2 Enabling RIP Function for Specific Network Segment

Follow these steps to enable the RIP function for specific network segment.

Step 1	configure Enter global configuration mode.
--------	--

Step 2	router rip
	Enable the RIP function. Only when the RIP function is enabled can the global configuration of the RIP function be performed. When the RIP function is disabled, the global configuration of the RIP function will be cleared. To disable this function, use the no router rip command.
Step 3	network network number
	Enable the RIP function on the corresponding interface of the configured network segment. To disable this function, use the no network command.
	<i>network number</i> : Network number, the format is 192.168.0.0. If you enter an IP address, the network number will be automatically obtained based on the mask length of the natural network segment. Entering 0.0.0.0 means enabling the RIP function on all interfaces.
Step 4	end
	Return to privileged EXEC mode.
Step 5	copy running-config startup-config
	Save the settings in the configuration file.

The following example shows how to enable the RIP function on the switch:

```
Switch#configure
Switch(config)#router rip
Switch(config-rtr)#192.168.0.0
Switch(config-rtr)#end
Switch#copy running-config startup-config
```

5.1.3 Configuring RIP Message Version

Follow these steps to configure the version of packets sent and received by RIP.

Step 1	configure
	Enter global configuration mode.
Step 2	router rip
	Enable the RIP function. Only when the RIP function is enabled can the global configuration of the RIP function be performed. When the RIP function is disabled, the global configuration of the RIP function will be cleared. To disable this function, use the no router rip command.
Step 3	version {1 2}
	Configure the version of packets sent and received by RIP. By default, the switch sends RIPv2 packets and receives RIPv1 and RIPv2 packets. To restore the default message version settings, use the no version command.
	1: Send and receive RIPv1 messages.
	2: Send and receive RIPv2 messages.

-
- | | |
|--------|---|
| Step 4 | end
Return to privileged EXEC mode. |
|--------|---|
-
- | | |
|--------|---|
| Step 5 | copy running-config startup-config
Save the settings in the configuration file. |
|--------|---|
-

The following example shows how to configure the RIP message version as RIPv1:

```
Switch#configure
```

```
Switch(config)#router rip
```

```
Switch(config-rtr)#version 1
```

```
Switch(config-rtr)#end
```

```
Switch#copy running-config startup-config
```

5.1.4 Configuring RIP Timer

Follow these steps to configure the RIP timer.

-
- | | |
|--------|--|
| Step 1 | configure
Enter global configuration mode. |
|--------|--|
-
- | | |
|--------|--|
| Step 2 | router rip
Enable the RIP function. Only when the RIP function is enabled can the global configuration of the RIP function be performed. When the RIP function is disabled, the global configuration of the RIP function will be cleared. To disable this function, use the no router rip command. |
|--------|--|
-
- | | |
|--------|--|
| Step 3 | timer basic <i>update-value timeout-value garbage-collect-value</i>
Configure the RIP timer. To restore the timer configuration to its default, use the no timer basic command.

<i>update-value</i> : Routing table update time, ranging from 5 to 86400 seconds. The default value is 30.

<i>timeout-value</i> : Routing table aging time, ranging from 5 to 86400 seconds. The default value is 180.

<i>garbage-collect-value</i> : The expiration time after the routing entry is unreachable. When the entry is unreachable, the routing entry is removed from the routing table after the expiration time. The range is 5~86400 seconds, and the default value is 120. |
|--------|--|
-
- | | |
|--------|---|
| Step 4 | end
Return to privileged EXEC mode. |
|--------|---|
-
- | | |
|--------|---|
| Step 5 | copy running-config startup-config
Save the settings in the configuration file. |
|--------|---|
-

The following example shows how to set the routing table update time to 50 seconds, the routing table aging time to 100 seconds, and the routing entry expiration time to 100 seconds:

```
Switch#configure
Switch(config)#router rip
Switch(config-rtr)#timer basic 50 100 100
Switch(config-rtr)#end
Switch#copy running-config startup-config
```

5.1.5 Configuring Management Distance

Follow these steps to configure the management distance of RIP routing.

Step 1	configure Enter global configuration mode.
Step 2	router rip Enable the RIP function. Only when the RIP function is enabled can the global configuration of the RIP function be performed. When the RIP function is disabled, the global configuration of the RIP function will be cleared. To disable this function, use the no router rip command.
Step 3	distance distance Configure the management distance of RIP routing. To restore the default configuration, use the no distance command. <i>distance</i> : Management distance of RIP routing, ranging from 1 to 255. The default value is 120.
Step 4	end Return to privileged EXEC mode.
Step 5	copy running-config startup-config Save the settings in the configuration file.

The following example shows how to configure the management distance of RIP routing to 100:

```
Switch#configure
Switch(config)#router rip
Switch(config-rtr)#distance 110
Switch(config-rtr)#end
Switch#copy running-config startup-config
```

5.1.6 Enabling Auto-summary Function

Follow these steps to enable the automatic summary function of RIP.

Step 1	configure	Enter global configuration mode.
Step 2	router rip	Enable the RIP function. Only when the RIP function is enabled can the global configuration of the RIP function be performed. When the RIP function is disabled, the global configuration of the RIP function will be cleared. To disable this function, use the no router rip command.
Step 3	auto-summary	Enable the automatic summary function of RIP. After this function is enabled, routing entries will be automatically summarized into natural network segments, which can reduce the number of routing entries issued for each update. To disable this function, use the no auto-summary command.
Step 4	end	Return to privileged EXEC mode.
Step 5	copy running-config startup-config	Save the settings in the configuration file.

The following example shows how to enable the automatic summary function of RIP:

```
Switch#configure
Switch(config)#router rip
Switch(config-rtr)#auto-summary
Switch(config-rtr)#end
Switch#copy running-config startup-config
```

5.1.7 Setting Default Metric

Follow these steps to set the default metric for redirection routes.

Step 1	configure	Enter global configuration mode.
Step 2	router rip	Enable the RIP function. Only when the RIP function is enabled can the global configuration of the RIP function be performed. When the RIP function is disabled, the global configuration of the RIP function will be cleared. To disable this function, use the no router rip command.

Step 3	<p>default-metric <i>metric</i></p> <p>Set the default metric for redirection routes. To restore the default configuration, use the no default-metric command.</p> <p><i>metric</i>: The default metric of the redirect route, ranging from 1 to 15, and the default value is 1.</p>
Step 4	<p>end</p> <p>Return to privileged EXEC mode.</p>
Step 5	<p>copy running-config startup-config</p> <p>Save the settings in the configuration file.</p>

The following example shows how to set the default metric for redirection routes to 5:

Switch#configure

Switch(config)#router rip

Switch(config-rtr)#default-metric 5

Switch(config-rtr)#end

Switch#copy running-config startup-config

5.1.8 Configuring RIP Redirection

Follow these steps to set RIP to redirect external routes.

Step 1	<p>configure</p> <p>Enter global configuration mode.</p>
Step 2	<p>router rip</p> <p>Enable the RIP function. Only when the RIP function is enabled can the global configuration of the RIP function be performed. When the RIP function is disabled, the global configuration of the RIP function will be cleared. To disable this function, use the no router rip command.</p>
Step 3	<p>redistribute { <i>ospf process-id</i> <i>connected</i> <i>static</i> } [<i>metric metric-value</i>]</p> <p>Set RIP to redirect external routes. Its no command has two forms: if it does not contain the metric parameter, it is used to disable the redirection function of the corresponding external route. If it contains the metric parameter, it is used to restore the metric used for redirect routes to the default value.</p> <p><i>ospf</i>: Enable RIP redirection OSPF routing function.</p> <p><i>process-id</i>: Redirected OSPF process number.</p> <p><i>connected</i>: Enable RIP redirection direct routing function.</p> <p><i>static</i>: Enable RIP redirection static routing function.</p> <p><i>metric-value</i>: The metric of the redirection route.</p>

-
- | | |
|--------|---------------------------------|
| Step 4 | end |
| | Return to privileged EXEC mode. |
-
- | | |
|--------|--|
| Step 5 | copy running-config startup-config |
| | Save the settings in the configuration file. |
-

The following example shows how to set RIP to redirect ospf process 1, and set metric to 3:

```
Switch#configure
Switch(config)#router rip
Switch(config-rtr)#redistribute ospf 1 metric 3
Switch(config-rtr)#end
Switch#copy running-config startup-config
```

5.1.9 Enabling ECMP Funtion

Follow these steps to enable the ECMP (Equal-cost multi-path routing) function of RIP.

-
- | | |
|--------|----------------------------------|
| Step 1 | configure |
| | Enter global configuration mode. |
-
- | | |
|--------|---|
| Step 2 | router rip |
| | Enable the RIP function. Only when the RIP function is enabled can the global configuration of the RIP function be performed. When the RIP function is disabled, the global configuration of the RIP function will be cleared. To disable this function, use the no router rip command. |
-
- | | |
|--------|--|
| Step 3 | allow-ecmp |
| | Enable the ECMP function. To disable this function, use the no allow-ecmp command. |
-
- | | |
|--------|---------------------------------|
| Step 4 | end |
| | Return to privileged EXEC mode. |
-
- | | |
|--------|--|
| Step 5 | copy running-config startup-config |
| | Save the settings in the configuration file. |
-

The following example shows how to enable the ECMP function of RIP:

```
Switch#configure
Switch(config)#router rip
Switch(config-rtr)#allow-ecmp
Switch(config-rtr)#end
Switch#copy running-config startup-config
```

5.1.10 Introducing Default Route

Follow these steps to introduce a default route into RIP.

Step 1	configure	Enter global configuration mode.
Step 2	router rip	Enable the RIP function. Only when the RIP function is enabled can the global configuration of the RIP function be performed. When the RIP function is disabled, the global configuration of the RIP function will be cleared. To disable this function, use the no router rip command.
Step 3	default-information originate	Introduce a default route into RIP. To disable this function, use the no default-information originate command.
Step 4	end	Return to privileged EXEC mode.
Step 5	copy running-config startup-config	Save the settings in the configuration file.

The following example shows how to introduce a default route into RIP:

Switch#configure

Switch(config)#router rip

Switch(config-rtr)#default-information originate

Switch(config-rtr)#end

Switch#copy running-config startup-config

5.1.11 Configuring RIP Neighbor

Follow these steps to configure the neighbor of RIP.

Step 1	configure	Enter global configuration mode.
Step 2	router rip	Enable the RIP function. Only when the RIP function is enabled can the global configuration of the RIP function be performed. When the RIP function is disabled, the global configuration of the RIP function will be cleared. To disable this function, use the no router rip command.

Step 3	neighbor ip-address
	Configure the neighbor of RIP. After configuring the neighbor, RIP will send RIP packets to the neighbor through unicast packets. To clear the neighbor configuration, use the no neighbor command.
	<i>ip-address</i> : IP address of RIP's neighbor.

Step 4	end
	Return to privileged EXEC mode.

Step 5	copy running-config startup-config
	Save the settings in the configuration file.

The following example shows how to specify 192.168.0.100 as the RIP neighbor:

```
Switch#configure
Switch(config)#router rip
Switch(config-rtr)#neighbor 192.168.0.100
Switch(config-rtr)#end
Switch#copy running-config startup-config
```

5.1.12 Configuring Passive-Interface

Follow these steps to configure the interface not to send RIP packets but only to receive RIP packets.

Step 1	configure
	Enter global configuration mode.

Step 2	router rip
	Enable the RIP function. Only when the RIP function is enabled can the global configuration of the RIP function be performed. When the RIP function is disabled, the global configuration of the RIP function will be cleared. To disable this function, use the no router rip command.

Step 3	passive-interface interface { fastEthernet gigabitEthernet hundred-gigabitEthernet loopback port-channel ten-gigabitEthernet twentyFive-gigabitEthernet two-gigabitEthernet vlan } <i>interface-value</i>
	Configure the interface not to send RIP packets but only to receive RIP packets. A unicast response will be sent out when a neighbor is configured at the same time. To disable this function, use the no passive-interface interface command.
	<i>interface-value</i> : Specify the interface to be configured as passive-interface.

Step 4	end
	Return to privileged EXEC mode.

-
- Step 5 **copy running-config startup-config**
Save the settings in the configuration file.
-

The following example shows how to configure VLAN 2 as passive-interface:

```
Switch#configure
Switch(config)#router rip
Switch(config-rtr)#passive-interface interface vlan 2
Switch(config-rtr)#end
Switch#copy running-config startup-config
```

5.1.13 Configuring Authentication Mode

Follow these steps to configure the authentication mode of RIP packets.

-
- Step 1 **configure**
Enter global configuration mode.
-
- Step 2 **interface {vlan vid | fastEthernet port | range fastEthernet port-list | gigabitEthernet port | range gigabitEthernet port-list | ten-gigabitEthernet port | range ten-gigabitEthernet port-list | port-channel port-channel | range port-channel port-channel-list }**
Enter interface configuration mode.
-
- Step 3 **ip rip authentication mode { md5 | simple }**
Configure the authentication mode of RIP packets. The authentication function only takes effect after the authentication mode and authentication password are configured. To clear the authentication mode configuration, use the no ip rip authentication mode command.

md5: Configure the authentication mode of RIP to md5 authentication.
simple: Configure the authentication mode of RIP to plain text authentication.
-
- Step 4 **end**
Return to privileged EXEC mode.
-
- Step 5 **copy running-config startup-config**
Save the settings in the configuration file.
-

The following example shows how to set the RIP authentication mode of VLAN 2 to md5 authentication:

```
Switch#configure
Switch(config)#interface vlan 2
Switch(config-if)#ip rip authentication mode md5
Switch(config-if)#end
```

Switch#copy running-config startup-config

5.1.14 Configuring Authentication String

Follow these steps to configure the password and key ID for RIP authentication.

Step 1	configure Enter global configuration mode.
Step 2	interface {vlan vid fastEthernet port range fastEthernet port-list gigabitEthernet port range gigabitEthernet port-list ten-gigabitEthernet port range ten-gigabitEthernet port-list port-channel port-channel range port-channel port-channel-list } Enter interface configuration mode.
Step 3	ip rip authentication string password [key-id key-id-value] Configure the password and key ID for RIP authentication. The key ID is only used for md5 authentication. This command cannot be configured at the same time as the IP RIP authentication key-chain command. To clear the password and key ID of RIP authentication, use the no ip rip authentication string command. <i>password:</i> RIP authentication password, 16 characters at most. <i>key-id-value:</i> Key ID for RIP authentication, ranging from 1 to 255. The default value is 1.
Step 4	end Return to privileged EXEC mode.
Step 5	copy running-config startup-config Save the settings in the configuration file.

The following example shows how to configure the rip authentication password of interface VLAN 2 as tmlink and the key ID as 2:

Switch#configure

Switch(config)#interface vlan 2

Switch(config-if)#ip rip authentication string tmlink key-id 2

Switch(config-if)#end

Switch#copy running-config startup-config

5.1.15 Configuring Authentication Key-chain

Follow these steps to configure the password and key ID for RIP authentication by binding key-chain.

Step 1	configure Enter global configuration mode.
--------	--

Step 2	<p>interface {vlan vid fastEthernet port range fastEthernet port-list gigabitEthernet port range gigabitEthernet port-list ten-gigabitEthernet port range ten-gigabitEthernet port-list port-channel port-channel range port-channel port-channel-list }</p> <p>Enter interface configuration mode.</p>
Step 3	<p>ip rip authentication key-chain key-chain-name</p> <p>Configure the password and key ID for RIP authentication by binding key-chain. This command cannot be configured at the same time as the IP RIP authentication string command. To clear key-chain binding, use the no ip rip authentication key-chain command.</p> <p><i>key-chain-name</i>: The name of the key-chain to be bound.</p>
Step 4	<p>end</p> <p>Return to privileged EXEC mode.</p>
Step 5	<p>copy running-config startup-config</p> <p>Save the settings in the configuration file.</p>

The following example shows how to configure key chain as 1, set key as 0, the corresponding password as tplink, and bind the RIP authentication of VLAN 2 to key chain 1:

Switch#configure

Switch(config)#key chain 1

Switch(config-keychain)#key 0 key-string tplink

Switch(config-keychain)#exit

Switch(config)#interface vlan 1

Switch(config-if)#ip rip authentication key-chain 1

Switch(config-if)#end

Switch#copy running-config startup-config

5.1.16 Configuring Receive Version

Follow these steps to configure the version of RIP packets received by the interface.

Step 1	<p>configure</p> <p>Enter global configuration mode.</p>
Step 2	<p>interface {vlan vid fastEthernet port range fastEthernet port-list gigabitEthernet port range gigabitEthernet port-list ten-gigabitEthernet port range ten-gigabitEthernet port-list port-channel port-channel range port-channel port-channel-list }</p> <p>Enter interface configuration mode.</p>

Step 3	<p>ip rip receive version { 1 2 }</p> <p>Configure the version of RIP packets received by the interface. If the receive version of an interface is not configured, it will be determined by the global configuration. To restore the default configuration, use the no ip rip receive version command.</p> <p>1: Configure the receive version of the interface to RIPv1.</p> <p>2: Configure the receive version of the interface to RIPv2.</p>
Step 4	<p>end</p> <p>Return to privileged EXEC mode.</p>
Step 5	<p>copy running-config startup-config</p> <p>Save the settings in the configuration file.</p>

The following example shows how to set the receive version of VLAN 1 to RIPv1:

Switch#configure

Switch(config)#interface vlan 1

Switch(config-if)#ip rip receive version 1

Switch(config-if)#end

Switch#copy running-config startup-config

5.1.17 Configuring Send Version

Follow these steps to configure the version of RIP packets sent by the interface.

Step 1	<p>configure</p> <p>Enter global configuration mode.</p>
Step 2	<p>interface {vlan vid fastEthernet port range fastEthernet port-list gigabitEthernet port range gigabitEthernet port-list ten-gigabitEthernet port range ten-gigabitEthernet port-list port-channel port-channel range port-channel port-channel-list }</p> <p>Enter interface configuration mode.</p>
Step 3	<p>ip rip send version { 1 2 }</p> <p>Configure the version of RIP packets sent by the interface. If the send version of an interface is not configured, it will be determined by the global configuration. To restore the default configuration, use the no ip rip send version command.</p> <p>1: Configure the send version of the interface to RIPv1.</p> <p>2: Configure the send version of the interface to RIPv2.</p>
Step 4	<p>end</p> <p>Return to privileged EXEC mode.</p>

-
- Step 5 **copy running-config startup-config**
Save the settings in the configuration file.
-

The following example shows how to set the send version of VLAN 1 to RIPv1:

```
Switch#configure
Switch(config)#interface vlan 1
Switch(config-if)#ip rip send version 1
Switch(config-if)#end
Switch#copy running-config startup-config
```

5.1.18 Configuring Split Horizon

Follow these steps to configure the split horizon function of the interface.

-
- Step 1 **configure**
Enter global configuration mode.
-
- Step 2 **interface {vlan vid | fastEthernet port | range fastEthernet port-list | gigabitEthernet port | range gigabitEthernet port-list | ten-gigabitEthernet port | range ten-gigabitEthernet port-list | port-channel port-channel | range port-channel port-channel-list }**
Enter interface configuration mode.
-
- Step 3 **ip rip split-horizon [poison-reverse]**
Configure the split horizon function of the interface. This function is enabled by default. When this function is enabled, RIP will not send routing entries learned from this interface out of this interface. When this function is disabled, RIP will only send routing entries according to the routing table. To disable this function, use the `no ip rip split-horizon` function.

poison-reverse: Enable the poison-reverse function of the interface. After this function is enabled, the entries learned from the interface will have the metric set to 16 before being sent out. Disable the poison reversal function by configuring the `ip rip split-horizon` command.
-
- Step 4 **end**
Return to privileged EXEC mode.
-
- Step 5 **copy running-config startup-config**
Save the settings in the configuration file.
-

The following example shows how to configure the poison-reverse function of VLAN 1:

```
Switch#configure
Switch(config)#interface vlan 1
Switch(config-if)#ip rip split-horizon poison-reverse
```

```
Switch(config-if)#end
```

```
Switch#copy running-config startup-config
```

5.1.19 Enabling RIPv2 Packet Broadcast

Follow these steps to enable the RIPv2 packet broadcast function of the interface.

Step 1	configure Enter global configuration mode.
Step 2	interface {vlan vid fastEthernet port range fastEthernet port-list gigabitEthernet port range gigabitEthernet port-list ten-gigabitEthernet port range ten-gigabitEthernet port-list port-channel port-channel range port-channel port-channel-list } Enter interface configuration mode.
Step 3	ip rip v2-broadcast Enable the RIPv2 packet broadcast function of the interface. By default, RIPv2 messages are sent through multicast. After this function is enabled on an interface, RIPv2 messages on the interface are sent through broadcast. To disable this function, use the no ip rip v2-broadcast function.
Step 4	end Return to privileged EXEC mode.
Step 5	copy running-config startup-config Save the settings in the configuration file.

The following example shows how to enable the RIPv2 packet broadcast function of VLAN 1:

```
Switch#configure
```

```
Switch(config)#interface vlan 1
```

```
Switch(config-if)#ip rip v2-broadcast
```

```
Switch(config-if)#end
```

```
Switch#copy running-config startup-config
```

5.1.20 Viewing RIP Routing Table

Follow these steps to view the RIP routing table.

Step 1	show ip rip Display RIP routing table.
--------	--

The following example shows how to view the RIP routing table:

```
Switch#show ip rip
```

Codes: R - RIP, C - connected, S - Static, O - OSPF, B - BGP

Sub-codes:

(n) - normal, (s) - static, (d) - default, (r) - redistribute,

(i) - interface

Network	Next Hop	Metric From	Tag	Time
---------	----------	-------------	-----	------

5.1.21 Viewing IP Status

Follow these steps to view the RIP status.

Step 1	show ip rip status
	Display RIP status.

The following example shows how to view the RIP status:

Switch#show ip rip status

Routing Protocol is "rip"

Sending updates every 30 seconds with +/-25%, next due in 0 seconds

Timeout after 180 seconds, garbage collect after 120 seconds

Outgoing update filter list for all interface is not set

Incoming update filter list for all interface is not set

Default redistribution metric is 1

Redistributing:

Default version control: send version 2, receive any version

Interface	Send	Recv	Key-chain
-----------	------	------	-----------

Routing for Networks:

Routing Information Sources:

Gateway	BadPackets	BadRoutes	Last Update
---------	------------	-----------	-------------

Distance: 120 (default is 120)

5.1.22 Clearing IP RIP

Follow these steps to clear the routing entries for RIP learning and re-request routing information from other devices.

Step 1

clear ip rip

Clear the routing entries for RIP learning and re-request routing information from other devices.

The following example shows how to clear the routing entries for RIP learning and re-request routing information from other devices:

Switch#clear ip rip

6 RIPng Configurations

RIPng (RIP next generation) is a routing protocol that improves the RIP protocol in order to solve the compatibility problem between the RIP protocol and IPv6.

6.1 Using the CLI

6.1.1 Enabling RIPng Funtion

Follow these steps to enable the RIPng function on the switch.

Step 1	configure
	Enter global configuration mode.

Step 2	router ripng
	Enable the RIPng function. Only when the RIPng function is enabled can the global configuration of the RIPng function be performed. When the RIPng function is disabled, the global configuration of the RIPng function will be cleared. To disable this function, use the no router ripng command.

Step 3	end
	Return to privileged EXEC mode.

Step 4	copy running-config startup-config
	Save the settings in the configuration file.

The following example shows how to enable the RIPng function on the switch:

```
Switch#configure
Switch(config)#router ripng
Switch(config-rtr)#end
Switch#copy running-config startup-config
Switch#copy running-config startup-config
```

6.1.2 Enabling RIP Funtion on Specific Port

Follow these steps to enable the RIPng function on a specific port.

Step 1	configure
	Enter global configuration mode.

Step 2	interface { <i>vlan vid</i> <i>fastEthernet port</i> <i>range fastEthernet port-list</i> <i>gigabitEthernet port</i> <i>range gigabitEthernet port-list</i> <i>ten-gigabitEthernet port</i> <i>range ten-gigabitEthernet port-list</i> <i>port-channel port-channel</i> <i>range port-channel port-channel-list</i> } Enter interface configuration mode.
Step 3	ipv6 rip enable Enable the ripng function of the interface. This command only takes effect after the global switch of RIPng is enabled. To disable this function, use the no ipv6 rip enable command.
Step 4	end Return to privileged EXEC mode.
Step 5	copy running-config startup-config Save the settings in the configuration file.

The following example shows how to enable the RIPng function of VLAN 1:

Switch#configure

Switch(config)#interface vlan 1

Switch(config-if)#ipv6 rip enable

Switch(config-if)#end

Switch#copy running-config startup-config

6.1.3 Configuring RIPng Timer

Follow these steps to configure the RIPng timer.

Step 1	configure Enter global configuration mode.
Step 2	router ripng Enable the RIPng function. Only when the RIPng function is enabled can the global configuration of the RIPng function be performed. When the RIPng function is disabled, the global configuration of the RIPng function will be cleared. To disable this function, use the no router ripng command.

-
- Step 3 **timer basic** *update-value timeout-value garbage-collect-value*
- Configure the RIPng timer. To restore the timer configuration to its default, use the no timer basic command.
- update-value*: Routing table update time, ranging from 1 to 65535 seconds. The default value is 30.
- timeout-value*: Routing table aging time, ranging from 1 to 65535 seconds. The default value is 180.
- garbage-collect-value*: The expiration time after the routing entry is unreachable. When the entry is unreachable, the routing entry is removed from the routing table after the expiration time. The range is 1 to 65535 seconds, and the default value is 120.
-
- Step 4 **end**
- Return to privileged EXEC mode.
-
- Step 5 **copy running-config startup-config**
- Save the settings in the configuration file.
-

The following example shows how to set the routing table update time to 50 seconds, the routing table aging time to 100 seconds, and the routing entry expiration time to 100 seconds:

Switch#configure

Switch(config)#router ripng

Switch(config-rtr)#timer basic 50 100 100

Switch(config-rtr)#end

Switch#copy running-config startup-config

6.1.4 Setting Default Metric

Follow these steps to set the default metric for redirection routes.

-
- Step 1 **configure**
- Enter global configuration mode.
-
- Step 2 **router ripng**
- Enable the RIPng function. Only when the RIPng function is enabled can the global configuration of the RIPng function be performed. When the RIPng function is disabled, the global configuration of the RIPng function will be cleared. To disable this function, use the no router ripng command.
-

Step 3	default-metric <i>metric</i>
	Set the default metric for redirection routes. To restore the default configuration, use the no default-metric command.
	<i>metric</i> : The default metric of the redirect route, ranging from 1 to 15, and the default value is 1.

Step 4	end
	Return to privileged EXEC mode.

Step 5	copy running-config startup-config
	Save the settings in the configuration file.

The following example shows how to set the default metric for redirection routes to 5:

```
Switch#configure
```

```
Switch(config)#router ripng
```

```
Switch(config-rtr)#default-metric 5
```

```
Switch(config-rtr)#end
```

```
Switch#copy running-config startup-config
```

6.1.5 Configuring RIPng Redirection

Follow these steps to set RIPng to redirect external routes.

Step 1	configure
	Enter global configuration mode.

Step 2	router ripng
	Enable the RIPng function. Only when the RIPng function is enabled can the global configuration of the RIPng function be performed. When the RIPng function is disabled, the global configuration of the RIPng function will be cleared. To disable this function, use the no router ripng command.

Step 3	redistribute { <i>ospf6</i> <i>static</i> } [<i>metric</i> <i>metric-value</i>]
	Configure RIPng to redirect external routes. No metric means disabling the redirection function of the corresponding external route. Metric is used to restore the metric used for redirect routes to the default value.
	<i>ospf6</i> : Enable RIPng redirection OSPF V3 routing function.
	<i>static</i> : Enable RIPng redirect static routing function.
	<i>metric-value</i> : The metric of the redirect route.

Step 4	end
	Return to privileged EXEC mode.

-
- Step 5 **copy running-config startup-config**
Save the settings in the configuration file.
-

The following example shows how to set RIPng to redirect ospf process 6, and set metric to 3:

```
Switch#configure
Switch(config)#router ripng
Switch(config-rtr)#redistribute ospf 6 metric 3
Switch(config-rtr)#end
Switch#copy running-config startup-config
```

6.1.6 Enabling ECMP Funtion

Follow these steps to enable the ECMP (Equal-cost multi-path routing) function of RIP.

-
- Step 1 **configure**
Enter global configuration mode.
-
- Step 2 **router ripng**
Enable the RIPng function. Only when the RIPng function is enabled can the global configuration of the RIPng function be performed. When the RIPng function is disabled, the global configuration of the RIPng function will be cleared. To disable this function, use the no router ripng command.
-
- Step 3 **allow-ecmp**
Enable the ECMP function. To disable this function, use the no allow-ecmp command.
-
- Step 4 **end**
Return to privileged EXEC mode.
-
- Step 5 **copy running-config startup-config**
Save the settings in the configuration file.
-

The following example shows how to enable the ECMP function of RIPng:

```
Switch#configure
Switch(config)#router ripng
Switch(config-rtr)#allow-ecmp
Switch(config-rtr)#end
Switch#copy running-config startup-config
```

6.1.7 Introducing Default Route

Follow these steps to introduce a default route into RIPng.

Step 1	configure	Enter global configuration mode.
Step 2	router ripng	Enable the RIPng function. Only when the RIPng function is enabled can the global configuration of the RIPng function be performed. When the RIPng function is disabled, the global configuration of the RIPng function will be cleared. To disable this function, use the no router ripng command.
Step 3	default-information originate	Introduce a default route into RIPng. To disable this function, use the no default-information originate command.
Step 4	end	Return to privileged EXEC mode.
Step 5	copy running-config startup-config	Save the settings in the configuration file.

The following example shows how to introduce a default route into RIPng:

Switch#configure

Switch(config)#router ripng

Switch(config-rtr)#default-information originate

Switch(config-rtr)#end

Switch#copy running-config startup-config

6.1.8 Configuring Passive-Interface

Follow these steps to configure the interface not to send RIPng packets but only to receive RIPng packets.

Step 1	configure	Enter global configuration mode.
Step 2	router ripng	Enable the RIPng function. Only when the RIPng function is enabled can the global configuration of the RIPng function be performed. When the RIPng function is disabled, the global configuration of the RIPng function will be cleared. To disable this function, use the no router ripng command.

Step 3	<p>passive-interface interface { fastEthernet gigabitEthernet hundred-gigabitEthernet loopback port-channel ten-gigabitEthernet twentyFive-gigabitEthernet two-gigabitEthernet vlan } <i>interface-value</i></p> <p>Configure the interface not to send RIPng packets but only to receive RIPng packets. To disable this function, use the no passive-interface interface command.</p> <p><i>interface-value</i>: Specify the interface to be configured as passive-interface.</p>
Step 4	<p>end</p> <p>Return to privileged EXEC mode.</p>
Step 5	<p>copy running-config startup-config</p> <p>Save the settings in the configuration file.</p>

The following example shows how to configure VLAN 2 as passive-interface:

Switch#configure

Switch(config)#router ripng

Switch(config-rtr)#passive-interface interface vlan 2

Switch(config-rtr)#end

Switch#copy running-config startup-config

6.1.9 Configuring Split Horizon

Follow these steps to configure the split horizon function of the interface.

Step 1	<p>configure</p> <p>Enter global configuration mode.</p>
Step 2	<p>interface {vlan vid fastEthernet port range fastEthernet port-list gigabitEthernet port range gigabitEthernet port-list ten-gigabitEthernet port range ten-gigabitEthernet port-list port-channel port-channel range port-channel port-channel-list }</p> <p>Enter interface configuration mode.</p>
Step 3	<p>ip ripv6 split-horizon [poison-reverse]</p> <p>Configure the split horizon function of the interface. This function is enabled by default. When this function is enabled, RIP will not send routing entries learned from this interface out of this interface. When this function is disabled, RIP will only send routing entries according to the routing table. To disable this function, use the no ip rip split-horizon function.</p> <p><i>poison-reverse</i>: Enable the poison-reverse function of the interface. After this function is enabled, the entries learned from the interface will have the metric set to 16 before being sent out. Disable the poison reversal function by configuring the ip ripv6 split-horizon command.</p>
Step 4	<p>end</p> <p>Return to privileged EXEC mode.</p>

Step 5 **copy running-config startup-config**
Save the settings in the configuration file.

The following example shows how to configure the poison-reverse function of VLAN 1:

```
Switch#configure
Switch(config)#interface vlan 1
Switch(config-if)#ipv6 rip split-horizon poison-reverse
Switch(config-if)#end
Switch#copy running-config startup-config
```

6.1.10 Viewing RIPng Routing Table

Follow these steps to view the RIPng routing table.

Step 1 **show ipv6 rip**
Display RIPng routing table.

The following example shows how to view the RIPng routing table:

```
Switch#show ipv6 rip
```

Codes: R - RIPng, C - connected, S - Static, O - OSPF, B - BGP

Sub-codes:

(n) - normal, (s) - static, (d) - default, (r) - redistribute,

(i) - interface, (a/S) - aggregated/Suppressed

Network	Next Hop	Via	Metric	Tag	Time
---------	----------	-----	--------	-----	------

6.1.11 Viewing IPv6 Status

Follow these steps to view the RIPng status.

Step 1 **show ipv6 rip status**
Display RIP status.

The following example shows how to view the RIPng status:

```
Switch#show ipv6 rip status
```

Routing Protocol is "RIPng"

Sending updates every 30 seconds with +/-25%, next due in 9 seconds

Timeout after 180 seconds, garbage collect after 120 seconds

Outgoing update filter list for all interface is not set

Incoming update filter list for all interface is not set

Default redistribution metric is 1

Redistributing:

Default version control: send version 1, receive version 1

Interface Send Recv

Routing for Networks:

Routing Information Sources:

Gateway BadPackets BadRoutes Last Update)

6.1.12 Clearing IPv6 RIP

Follow these steps to clear the routing entries for RIPng learning and re-request routing information from other devices.

Step 1 **clear ipv6 rip**

Clear routes learned by RIPng and request routing information.

The following example shows how to clear the routing entries for RIPng learning and re-request routing information from other devices:

Switch#clear ipv6 rip

7 OSPF Configurations

OSPF is an Interior Gateway Protocol (IGP) designed expressly for IP networks, supporting IP subnetting and tagging of externally derived routing information. OSPF also allows packet authentication and uses IP multicast when sending and receiving packets.

Currently, OSPF Version 2 (RFC2328) is used for the IPv4 protocol; Use OSPF Version 3 (RFC2740) for IPv6 protocol. Unless otherwise specified, the OSPF referred to in this chapter is OSPF Version 2.

7.1 Using the CLI

7.1.1 Configuring Router OSPF

Follow these steps to create an OSPF routing process and enter the router configuration mode.

Step 1	configure Enter global configuration mode.
Step 2	router ospf process-id Create an OSPF routing process and enter the router configuration mode. Each OSPF routing process is an independent instance running the OSPF protocol, and they works separately. To delete the specified OSPF routing process, please use the no router ospf command. <i>process-id</i> : Process ID, ranging from 1 to 65535. Sixteen processes can be created at most.
Step 3	end Return to privileged EXEC mode.
Step 4	copy running-config startup-config Save the settings in the configuration file.

The following example shows how to create an OSPF routing process with the process ID as 1:

```
Switch#configure
```

```
Switch(config)#router ospf 1
```

```
Switch(config)#end
```

```
Switch#copy running-config startup-config
```

7.1.2 Configuring Router ID

Follow these steps to configure the router ID.

Step 1	configure Enter global configuration mode.
Step 2	router ospf process-id Create an OSPF routing process and enter the router configuration mode. Each OSPF routing process is an independent instance running the OSPF protocol, and they works separately. To delete the specified OSPF routing process, please use the no router ospf command. <i>process-id</i> : Process ID, ranging from 1 to 65535. Sixteen processes can be created at most.
Step 3	router-id router-id Configure the router ID. The no router-id command is used to delete the configured router ID. <i>router-id</i> : The route ID in the format of dotted decimal notation. 0.0.0.0 is illegal.
Step 4	end Return to privileged EXEC mode.
Step 5	copy running-config startup-config Save the settings in the configuration file.

The following example shows how to configure the router ID of OSPF routing process 1 as 1.1.1.1:

```
Switch#configure
Switch(config)#router ospf 1
Switch(config-router)#router-id 1.1.1.1
Switch(config)#end
Switch#copy running-config startup-config
```

7.1.3 Configuring Network

Follow these steps to configure the network of a specified area.

Step 1	configure Enter global configuration mode.
--------	--

Step 2 **router ospf process-id**

Create an OSPF routing process and enter the router configuration mode. Each OSPF routing process is an independent instance running the OSPF protocol, and they works separately. To delete the specified OSPF routing process, please use the no router ospf command.

process-id: Process ID, ranging from 1 to 65535. Sixteen processes can be created at most.

Step 3 **network ip-address wildcard-mask area area-id**

Configure the network of a specified area. All the interfaces fallen into the configured network will belong to this area. To delete the specified network and its corresponding interfaces from this area, please use the no network command.

ip-address: The IP address of the network.

wildcard-mask: The wildcard mask of the network (such as 0.0.0.255). The subnet mask is also compatible (such as 255.0.0.0).

area-id: The area ID, in the format of an IP address in dotted decimal notation or decimal value ranging from 0 to 4294967295.

Step 4 **end**

Return to privileged EXEC mode.

Step 5 **copy running-config startup-config**

Save the settings in the configuration file.

The following example shows how to configure the network 192.168.0.0/24 in the area 0.0.0.0:

```
Switch#configure
```

```
Switch(config)#router ospf 1
```

```
Switch(config-router)#network 192.168.0.0 255.255.255.0 area 0.0.0.0
```

```
Switch(config)#end
```

```
Switch#copy running-config startup-config
```

7.1.4 Configuring Max-Paths

Follow these steps to configure the maximum number of the equal-cost multipath routings.

Step 1 **configure**

Enter global configuration mode.

Step 2	router ospf process-id
	Create an OSPF routing process and enter the router configuration mode. Each OSPF routing process is an independent instance running the OSPF protocol, and they works separately. To delete the specified OSPF routing process, please use the no router ospf command. <i>process-id</i> : Process ID, ranging from 1 to 65535. Sixteen processes can be created at most.
Step 3	maximum-paths number
	Configure the maximum number of the equal-cost multipath routings. To restore to default value, please use the no maximum-paths command. <i>number</i> : The maximum number of the equal-cost multipath routings, ranging from 1 to 32. The default value is 32.
Step 4	end
	Return to privileged EXEC mode.
Step 5	copy running-config startup-config
	Save the settings in the configuration file.

The following example shows how to configure the maximum number of the equal-cost multipath routings as 2:

Switch#configure

Switch(config)#router ospf 1

Switch(config-router)#maximum-paths 2

Switch(config)#end

Switch#copy running-config startup-config

7.1.5 Configuring ASBR

Follow these steps to configure the ASBR to redistribute the external routes from other routing protocols to the OSPF domain in type-5 LSAs.

Step 1	configure
	Enter global configuration mode.
Step 2	router ospf process-id
	Create an OSPF routing process and enter the router configuration mode. Each OSPF routing process is an independent instance running the OSPF protocol, and they works separately. To delete the specified OSPF routing process, please use the no router ospf command. <i>process-id</i> : Process ID, ranging from 1 to 65535. Sixteen processes can be created at most.

Step 3 **redistribute { connected | static | rip | ospf process-id } [metric cost] [metric-type type]**

Configure the ASBR to redistribute the external routes from other routing protocols to the OSPF domain in type-5 LSAs. To restore the certain optional parameters to default values, please use the no redistribute command with corresponding parameters.

connected: Specify the external route type as connected.

static: Specify the external route type as static.

rip: Specify the external route type as RIP.

ospf: Specify the external route type as OSPF.

process-id: The OSPF routing process ID, ranging from 1 to 65535. It's not allowed to redirect to the own process, for example, OSPF process 1 cannot redirect itself.

cost: The cost of the external routes, ranging from 1 to 16777214. Its default value is defined in the command default-metric.

type: The type of the external routes, either 1 or 2. The default value is 2.

Step 4 **end**

Return to privileged EXEC mode.

Step 5 **copy running-config startup-config**

Save the settings in the configuration file.

The following example shows how to redistribute the RIP routes from the external and advertise them as type 1 external routes in the OSPF domain:

Switch#configure

Switch(config)#router ospf 1

Switch(config-router)#redistribute rip metric-type 1

Switch(config)#end

Switch#copy running-config startup-config

7.1.6 Configuring Default-Metric

Follow these steps to configure the default cost of the redistributing external route.

Step 1 **configure**

Enter global configuration mode.

-
- Step 2 **router ospf process-id**
- Create an OSPF routing process and enter the router configuration mode. Each OSPF routing process is an independent instance running the OSPF protocol, and they works separately. To delete the specified OSPF routing process, please use the no router ospf command.
- process-id*: Process ID, ranging from 1 to 65535. Sixteen processes can be created at most.
-
- Step 3 **default-metric cost**
- Configure the default cost of the redistributing external route. To restore to the default value, please use the no default-metric command.
- cost*: The default cost of the redistributing external route, ranging form 1 to 16777214.
-
- Step 4 **end**
- Return to privileged EXEC mode.
-
- Step 5 **copy running-config startup-config**
- Save the settings in the configuration file.
-

The following example shows how to configure the default cost of the redistributing external route as 12:

Switch#configure

Switch(config)#router ospf 1

Switch(config-router)#default-metric 12

Switch(config)#end

Switch#copy running-config startup-config

7.1.7 Configuring Default-Information Originate

Follow these steps to advertise the default route as AS-External LSA.

-
- Step 1 **configure**
- Enter global configuration mode.
-
- Step 2 **router ospf process-id**
- Create an OSPF routing process and enter the router configuration mode. Each OSPF routing process is an independent instance running the OSPF protocol, and they works separately. To delete the specified OSPF routing process, please use the no router ospf command.
- process-id*: Process ID, ranging from 1 to 65535. Sixteen processes can be created at most.
-

Step 3	default-information originate [always] [metric cost] [metric-type type] Advertise the default route as AS-External LSA. To cancel the advertisement of the default route, please use the no default-information originate command without any optional parameters. To restore the certain parameters to default values, please use the no default-information originate command with corresponding parameters. always: OSPF will advertise the default route whether there is default route is the IP routing table or not. If the parameter is not configured, OSPF will advertise the default route only when there is default route in the IP routing table. cost: The default cost of the default route, ranging form 1 to 16777214. Its default value is 1. type: The type of the external routes, either 1 or 2. The default value is 2.
Step 4	end Return to privileged EXEC mode.
Step 5	copy running-config startup-config Save the settings in the configuration file.

The following example shows how to configure OSPF to advertise the default route whether there is default route in the IP routing table or not:

Switch#configure

Switch(config)#router ospf 1

Switch(config-router)#default-information originate always

Switch(config)#end

Switch#copy running-config startup-config

7.1.8 Configuring Auto-Cost

Follow these steps to enable the auto computing function of the interface cost and configure the reference bandwidth.

Step 1	configure Enter global configuration mode.
Step 2	router ospf process-id Create an OSPF routing process and enter the router configuration mode. Each OSPF routing process is an independent instance running the OSPF protocol, and they works separately. To delete the specified OSPF routing process, please use the no router ospf command. process-id: Process ID, ranging from 1 to 65535. Sixteen processes can be created at most.

Step 3	auto-cost reference-bandwidth <i>bandwidth</i>
	Enable the auto computing function of the interface cost and configure the reference bandwidth. The interface cost is the ratio of the reference bandwidth to the interface bandwidth. To restore the reference bandwidth to default value, please use the no auto-cost reference-bandwidth command.
	<i>bandwidth</i> : The reference bandwidth, ranging from 1 to 4294967 Mbps. Its default value is 100Mbps.

Step 4	end
	Return to privileged EXEC mode.

Step 5	copy running-config startup-config
	Save the settings in the configuration file.

The following example shows how to configure OSPF to enable the auto computing function of the interface cost and configure the reference bandwidth as 10000 Mbps:

```
Switch#configure
```

```
Switch(config)#router ospf 1
```

```
Switch(config-router)#auto-cost reference-bandwidth 10000
```

```
Switch(config)#end
```

```
Switch#copy running-config startup-config
```

7.1.9 Configuring OSPF Administrative Distance

Follow these steps to configure the OSPF administrative distance.

Step 1	configure
	Enter global configuration mode.

Step 2	router ospf <i>process-id</i>
	Create an OSPF routing process and enter the router configuration mode. Each OSPF routing process is an independent instance running the OSPF protocol, and they works separately. To delete the specified OSPF routing process, please use the no router ospf command.
	<i>process-id</i> : Process ID, ranging from 1 to 65535. Sixteen processes can be created at most.

-
- Step 3 **distance** *administrative-distance*
- Configure the OSPF administrative distance. To restore to the default distance, please use the no distance command. The administrative distance represents the priority of the routes. The smaller administrative distance corresponds to higher priority. When different routing protocols possess the same route to the same destination, the route with the highest priority will be selected to add to the IP routing table according to the administrative distance.
- administrative-distance*: Routing administrative distance, ranging from 1 to 255. Its default value is 110. When this value is set to 255, it indicates that the source of routing information is unreliable and all related routes are ignored.
-
- Step 4 **end**
- Return to privileged EXEC mode.
-
- Step 5 **copy running-config startup-config**
- Save the settings in the configuration file.
-

The following example shows how to configure the OSPF routing administrative distance as 100:

```
Switch#configure
```

```
Switch(config)#router ospf 1
```

```
Switch(config-router)#distance 100
```

```
Switch(config)#end
```

```
Switch#copy running-config startup-config
```

7.1.10 Configuring Computing Delay and Interval

Follow these steps to configure the computing delay and interval of the SPF.

-
- Step 1 **configure**
- Enter global configuration mode.
-
- Step 2 **router ospf** *process-id*
- Create an OSPF routing process and enter the router configuration mode. Each OSPF routing process is an independent instance running the OSPF protocol, and they works separately. To delete the specified OSPF routing process, please use the no router ospf command.
- process-id*: Process ID, ranging from 1 to 65535. Sixteen processes can be created at most.
-

-
- Step 3 **timers throttle spf** *spf-delay spf-holdtime spf-max-holdtime*
- Configure the computing delay and interval of the SPF, thus preventing the consumption of the CPU and memory caused by frequent SPF computing. To restore to the default value, please use the `no timers throttle spf` command.
- spf-delay*: The delay time of the SPF computing, ranging from 1 to 600000 milliseconds. The default value is 0 milliseconds.
- spf-holdtime*: The minimum interval between two SPF computings, ranging from 1 to 600000 milliseconds. The default value is 50 milliseconds.
- spf-max-holdtime*: The Maximum interval between two SPF computings, ranging from 1 to 600000 milliseconds. The default value is 5000 milliseconds.
-
- Step 4 **end**
- Return to privileged EXEC mode.
-
- Step 5 **copy running-config startup-config**
- Save the settings in the configuration file.
-

The following example shows how to configure the SPF computing delay as 10 seconds and the interval between 10 and 50 seconds:

```
Switch#configure
```

```
Switch(config)#router ospf 1
```

```
Switch(config-router)#timers throttle spf 10000 10000 50000
```

```
Switch(config)#end
```

```
Switch#copy running-config startup-config
```

7.1.11 Configuring RFC 1583

Follow these steps to configure the OSPF's compatibility for the routing rules in the RFC 1583.

-
- Step 1 **configure**
- Enter global configuration mode.
-
- Step 2 **router ospf** *process-id*
- Create an OSPF routing process and enter the router configuration mode. Each OSPF routing process is an independent instance running the OSPF protocol, and they works separately. To delete the specified OSPF routing process, please use the `no router ospf` command.
- process-id*: Process ID, ranging from 1 to 65535. Sixteen processes can be created at most.
-

Step 3	compatible rfc1583 Configure the OSPF's compatibility for the routing rules in the RFC 1583. To cancel the compatibility, please use the no compatible rfc1583 command. It is compatible by default.
Step 4	end Return to privileged EXEC mode.
Step 5	copy running-config startup-config Save the settings in the configuration file.

The following example shows how to configure the OSPF's compatibility for the routing rules in RFC 1583:

Switch#configure

Switch(config)#router ospf 1

Switch(config-router)#compatible rfc1583

Switch(config)#end

Switch#copy running-config startup-config

7.1.12 Defining Stub Area

Follow these steps to define an area as a stub area.

Step 1	configure Enter global configuration mode.
Step 2	router ospf process-id Create an OSPF routing process and enter the router configuration mode. Each OSPF routing process is an independent instance running the OSPF protocol, and they works separately. To delete the specified OSPF routing process, please use the no router ospf command. <i>process-id</i> : Process ID, ranging from 1 to 65535. Sixteen processes can be created at most.
Step 3	area area-id stub [no-summary] Define an area as a stub area. To restore the stub area to a normal one, please use the no area stub command without any optional parameters. To restore the certain parameters to default values, please use the no area stub command with corresponding parameters. <i>area-id</i> : The area ID, in the format of an IP address in dotted decimal notation or decimal value ranging from 1 to 4294967295. no-summary : Configure the stub area as a totally stub area, where the ABR advertises neither the destinations in other areas nor the external routes. The stub area is not a totally stub area by default.

Step 4 **end**
Return to privileged EXEC mode.

Step 5 **copy running-config startup-config**
Save the settings in the configuration file.

The following example shows how to configure the area 1 as a totally stub area:

Switch#configure

Switch(config)#router ospf 1

Switch(config-router)#area 1 stub no-summary

Switch(config)#end

Switch#copy running-config startup-config

7.1.13 Defining NSSA Area

Follow these steps to define an area as a NSSA area.

Step 1 **configure**
Enter global configuration mode.

Step 2 **router ospf process-id**
Create an OSPF routing process and enter the router configuration mode. Each OSPF routing process is an independent instance running the OSPF protocol, and they works separately. To delete the specified OSPF routing process, please use the no router ospf command.

process-id: Process ID, ranging from 1 to 65535. Sixteen processes can be created at most.

-
- Step 3 **area *area-id* nssa [no summary | default-information-originate [metric cost] [metric-type type]]**
- Define an area as a nssa area. To restore the NSSA area to a normal one, please use the no area NSSA command without any optional parameters. To restore the certain parameters to default values, please use the no area NSSA command with corresponding parameters.
- area-id:** The area ID, in the format of an IP address in dotted decimal notation or decimal value ranging from 1 to 4294967295.
- no-summary:** Configure the NSSA area as a totally NSSA area, where the ABR advertises neither the destinations in other areas nor the external routes. The NSSA area is not a totally NSSA area by default.
- default-information-originate:** Enable or disable advertising default route into NSSA area by sending a NSSA-External LSA. OSPF will not advertise default route if this parameter is not specified
- cost:** The default cost of the default route, ranging form 1 to 16777214. Its default value is 1.
- type:** The type of the external routes, either 1 or 2. The default value is 2.
-
- Step 4 **end**
- Return to privileged EXEC mode.
-
- Step 5 **copy running-config startup-config**
- Save the settings in the configuration file.
-

The following example shows how to configure the Area 1 as a totally NSSA area:

Switch#configure

Switch(config)#router ospf 1

Switch(config-router)#area 1 nssa no-summary

Switch(config)#end

Switch#copy running-config startup-config

7.1.14 Configuring Area Default-Cost

Follow these steps to configure the cost of default route sent from ABR to stub or NSSA area.

-
- Step 1 **configure**
- Enter global configuration mode.
-

-
- Step 2 **router ospf process-id**
- Create an OSPF routing process and enter the router configuration mode. Each OSPF routing process is an independent instance running the OSPF protocol, and they works separately. To delete the specified OSPF routing process, please use the no router ospf command.
- process-id*: Process ID, ranging from 1 to 65535. Sixteen processes can be created at most.
-
- Step 3 **area area-id nssa**
- Define an area as a NSSA area. To restore the NSSA area to a normal one, please use the no area NSSA command without any optional parameters. To restore the certain parameters to default values, please use the no area NSSA command with corresponding parameters.
- area-id*: The area ID, in the format of an IP address in dotted decimal notation or decimal value ranging from 1 to 4294967295.
-
- Step 4 **area area-id default-cost cost**
- Configure the cost of default route sent from ABR to stub or NSSA area.
- area-id*: The area ID, in the format of an IP address in dotted decimal notation or decimal value ranging from 1 to 4294967295.
- cost*: The cost value. It ranges from 1 to 16777214 and the default value is 1.
-
- Step 5 **end**
- Return to privileged EXEC mode.
-
- Step 6 **copy running-config startup-config**
- Save the settings in the configuration file.
-

The following example shows how to configure the cost of default route sent to Area 1 as 10:

```
Switch#configure
Switch(config)#router ospf 1
Switch(config-router)#area 1 nssa
Switch(config-router)#area 1 default-cost 10
Switch(config)#end
Switch#copy running-config startup-config
```

7.1.15 Configuring Summary Route

Follow these steps to configure a summary route

-
- Step 1 **configure**
- Enter global configuration mode.
-

-
- Step 2 **router ospf process-id**
- Create an OSPF routing process and enter the router configuration mode. Each OSPF routing process is an independent instance running the OSPF protocol, and they works separately. To delete the specified OSPF routing process, please use the no router ospf command.
- process-id*: Process ID, ranging from 1 to 65535. Sixteen processes can be created at most.
-
- Step 3 **area area-id range ip-address mask [advertise] [cost cost] [not-advertise]**
- Configure a summary route. To delete this route, please use the no area range command. By default no route is summarized.
- This command is only used with the ABR to summarize the route information of a certain area. The ABR only sends one summarized route of the routes in the aggregated segment to the other areas. An area can be configured with multiple summary segments, which can be aggregated by OSPF.
- If the no area range command is configured, the formally summarized routes will be redistributed.
- area-id*: The area ID, in the format of an IP address in dotted decimal notation or decimal value ranging from 0 to 4294967295.
- ip-address*: The destination of the aggregated route.
- mask*: The network mask of the aggregated route, in the format of dotted decimal notation.
- advertise**: Allow route aggregation of ABR broadcast.
- not-advertise**: Suppress route aggregation of ABR broadcast.
- cost*: The cost of the aggregated route, ranging from 1 to 16777214. The default value is the maximum one of all the aggregated routes. The cost parameter can be configured only when the advtise parameter is enabled. When configured as not-advtise, the cost parameter will be restored to the default value.
-
- Step 4 **end**
- Return to privileged EXEC mode.
-
- Step 5 **copy running-config startup-config**
- Save the settings in the configuration file.
-

The following example shows how to configure one aggregated route 100.100.0.0/16 with the cost 10 in the Area 0:

```
Switch#configure
```

```
Switch(config)#router ospf 1
```

```
Switch(config-router)#area 0 range 100.100.0.0 255.255.0.0 cost 10
```

```
Switch(config)#end
```

```
Switch#copy running-config startup-config
```

7.1.16 Configuring Area Authentication

Follow these steps to configure the authentication type of the ospf process.

Step 1	configure Enter global configuration mode.
Step 2	router ospf process-id Create an OSPF routing process and enter the router configuration mode. Each OSPF routing process is an independent instance running the OSPF protocol, and they works separately. To delete the specified OSPF routing process, please use the no router ospf command. <i>process-id</i> : Process ID, ranging from 1 to 65535. Sixteen processes can be created at most.
Step 3	area area-id authentication [message-digest] Configure the authentication type of the ospf process. The process is not authenticated by default. To restore to default value, please use the no area authentication command. <i>area-id</i> : The area ID, in the format of an IP address in dotted decimal notation or decimal value ranging from 0 to 4294967295. message-digest : Configure the configuration type as MD5. If no authentication mode is specified here, the default mode will be simple authentication.
Step 4	end Return to privileged EXEC mode.
Step 5	copy running-config startup-config Save the settings in the configuration file.

The following example shows how to configure the authentication method to MD5 in the Area 0:

```
Switch#configure
```

```
Switch(config)#router ospf 1
```

```
Switch(config-router)#area 0 authentication message-digest
```

```
Switch(config)#end
```

```
Switch#copy running-config startup-config
```

7.1.17 Configuring Virtual-Link

Follow these steps to configure the virtual-link.

Step 1	configure Enter global configuration mode.
--------	--

Step 2	<p>router ospf process-id</p> <p>Create an OSPF routing process and enter the router configuration mode. Each OSPF routing process is an independent instance running the OSPF protocol, and they works separately. To delete the specified OSPF routing process, please use the no router ospf command.</p> <p><i>process-id</i>: Process ID, ranging from 1 to 65535. Sixteen processes can be created at most.</p>
Step 3	<p>area transit-area virtual-link router-id [dead-interval dead-interval] [hello-interval hello-interval] [retransmit-interval rtx-interval] [transmit-delay trans-delay]</p> <p>Configure the virtual-link. To delete the configured virtual-link, please use the no area virtual-link without any optional parameters.</p> <p><i>transit-area</i>: The area ID, in the format of an IP address in dotted decimal notation or decimal value ranging from 1 to 4294967295.</p> <p><i>router-id</i>: The ID of the neighboring router on the opposite end of the virtual link, in the format of dotted decimal notation.</p> <p><i>hello-interval</i>: The interval of the hello packets, ranging from 1 to 65535 seconds and the default value is 10 seconds.</p> <p><i>dead-interval</i>: The time after which the neighbor becomes invalid. It ranges from 1 to 65535 seconds and the default value is 4 times as the hello-interval.</p> <p><i>rtx-interval</i>: The retransmission interval of the LSA, DD and LSR packets. It ranges from 1 to 65535 seconds and the default value is 5 seconds.</p> <p><i>trans-delay</i>: The LSA transmission delay. It ranges from 1 to 65535 seconds and the default value is 1 seconds.</p>
Step 4	<p>end</p> <p>Return to privileged EXEC mode.</p>
Step 5	<p>copy running-config startup-config</p> <p>Save the settings in the configuration file.</p>

The following example shows how to configure a virtual-link with the transmission area as Area 1 and the ID of the neighboring router on the other endpoint as 1.1.1.1:

```
Switch#configure
```

```
Switch(config)#router ospf 1
```

```
Switch(config-router)#area 1 virtual-link 1.1.1.1
```

```
Switch(config)#end
```

```
Switch#copy running-config startup-config
```

7.1.18 Configuring Virtual-Link Authentication

Follow these steps to configure the authentication type of the virtual link.

Step 1	configure Enter global configuration mode.
Step 2	router ospf process-id Create an OSPF routing process and enter the router configuration mode. Each OSPF routing process is an independent instance running the OSPF protocol, and they works separately. To delete the specified OSPF routing process, please use the no router ospf command. <i>process-id</i> : Process ID, ranging from 1 to 65535. Sixteen processes can be created at most.
Step 3	area transit-area virtual-link router-id authentication [message-digest null] Configure the authentication type of the virtual link. The virtual link is not authenticated by default. To restore to default value, please use the no area virtual-link authentication command. <i>transit-area</i> : The transition area ID in the format of an IP address in dotted decimal notation or decimal value ranging from 1 to 4294967295. <i>router-id</i> : The ID of the neighboring router on the other endpoint of the virtual link, in the format of dotted decimal notation. message-digest : Configure the configuration type as MD5. null : No authentication. By default it is no authentication. If no authentication mode is specified here, the default mode will be simple authentication.
Step 4	end Return to privileged EXEC mode.
Step 5	copy running-config startup-config Save the settings in the configuration file.

The following example shows how to configure simple authentication as the authentication mode of a virtual-link with the transmission area as Area 2 and the ID of the neighboring router on the other endpoint as 3.3.3.3:

```
Switch#configure
```

```
Switch(config)#router ospf 1
```

```
Switch(config-router)#area 2 virtual-link 3.3.3.3 authentication
```

```
Switch(config)#end
```

```
Switch#copy running-config startup-config
```

7.1.19 Configuring Area Virtual-Link Simple Authentication Key

Follow these steps to configure the simple authentication key of virtual-link.

Step 1	configure Enter global configuration mode.
Step 2	router ospf process-id Create an OSPF routing process and enter the router configuration mode. Each OSPF routing process is an independent instance running the OSPF protocol, and they works separately. To delete the specified OSPF routing process, please use the no router ospf command. <i>process-id</i> : Process ID, ranging from 1 to 65535. Sixteen processes can be created at most.
Step 3	area transit-area virtual-link router-id authentication-key [0 7] password Configure the simple authentication key. To delete the key, please use the no area virtual-link authentication-key command. <i>transit-area</i> : The transition area ID in the format of an IP address in dotted decimal notation or decimal value ranging from 1 to 4294967295. <i>router-id</i> : The ID of the neighboring router on the other endpoint of the virtual link, in the format of dotted decimal notation. [0 7] : Key form, 0 represents plaintext, 7 represents ciphertext. <i>password</i> : A string from 1 to 8 alphanumeric characters or symbols. The password is case sensitive, and cannot contain question marks. By default, it is empty.
Step 4	end Return to privileged EXEC mode.
Step 5	copy running-config startup-config Save the settings in the configuration file.

The following example shows how to configure the authentication mode of a virtual-link as simple authentication, with the transmission area as Area 2 and the ID of the neighboring router on the other endpoint as 3.3.3.3, and the authentication key as 123456:

```
Switch#configure
```

```
Switch(config)#router ospf 1
```

```
Switch(config-router)#area 2 virtual-link 3.3.3.3 authentication-key 123456
```

```
Switch(config)#end
```

```
Switch#copy running-config startup-config
```

7.1.20 Configuring Area Virtual-Link Message-Digest-Key

Follow these steps to configure the MD5 authentication ID and key of the virtual-link.

Step 1	configure Enter global configuration mode.
Step 2	router ospf process-id Create an OSPF routing process and enter the router configuration mode. Each OSPF routing process is an independent instance running the OSPF protocol, and they works separately. To delete the specified OSPF routing process, please use the no router ospf command. <i>process-id</i> : Process ID, ranging from 1 to 65535. Sixteen processes can be created at most.
Step 3	area transit-area virtual-link router-id message-digest-key id md5 [0 7] password Configure the MD5 authentication ID and key of the virtual-link. To delete the specified configuration, please use the no area virtual-link message-digest- key command. <i>transit-area</i> : The transition area ID in the format of an IP address in dotted decimal notation or decimal value ranging from 1 to 4294967295. <i>router-id</i> : The ID of the neighboring router on the other endpoint of the virtual link, in the format of dotted decimal notation. <i>id</i> : The key ID of the MD5, ranging from 1 to 255. [0 7] : Key form, 0 represents plaintext, 7 represents ciphertext. <i>password</i> : A string from 1 to 16 alphanumeric characters or symbols. The password is case sensitive, and cannot contain question marks.
Step 4	end Return to privileged EXEC mode.
Step 5	copy running-config startup-config Save the settings in the configuration file.

The following example shows how to configure the authentication mode of a virtual-link as md5 authentication, with the transmission area as Area 2 and the ID of the neighboring router on the other endpoint as 3.3.3.3, with the authentication ID as 2 and the authentication key as 123456:

```
Switch#configure
```

```
Switch(config)#router ospf 1
```

```
Switch(config-router)#area 2 virtual-link 3.3.3.3 message-digest- key 2 md5 123456
```

```
Switch(config)#end
```

```
Switch#copy running-config startup-config
```

7.1.21 Configuring Interface Cost

Follow these steps to configure the interface cost.

Step 1	configure Enter global configuration mode.
Step 2	interface {vlan vid fastEthernet port range fastEthernet port-list gigabitEthernet port range gigabitEthernet port-list ten-gigabitEthernet port range ten-gigabitEthernet port-list port-channel port-channel range port-channel port-channel-list hundred-gigabitEthernet port range hundred-gigabitEthernet port-list twentyFive-gigabitEthernet port range twentyFive-gigabitEthernet port-list two-gigabitEthernet port range two-gigabitEthernet port-list} Enter interface configuration mode.
Step 3	ip ospf cost cost Configure the interface cost. To restore to the default value, please use the no ip ospf cost command. <i>cost</i> : The interface cost, ranging from 1 to 65535. The default value is calculated according to the bandwidth.
Step 4	end Return to privileged EXEC mode.
Step 5	copy running-config startup-config Save the settings in the configuration file.

The following example shows how to configure the cost of interface VLAN 2 as 10:

```
Switch#configure
Switch(config)#interface vlan 2
Switch(config-if)# ip ospf cost 10
Switch(config)#end
Switch#copy running-config startup-config
```

7.1.22 Configuring IP OSPF Retransmit-Interval

Follow these steps to configure the interval to retransmit the LSA, DD and LSR packets on the specified interface.

Step 1	configure Enter global configuration mode.
Step 2	interface {vlan vid fastEthernet port range fastEthernet port-list gigabitEthernet port range gigabitEthernet port-list ten-gigabitEthernet port range ten-gigabitEthernet port-list port-channel port-channel range port-channel port-channel-list hundred-gigabitEthernet port range hundred-gigabitEthernet port-list twentyFive-gigabitEthernet port range twentyFive-gigabitEthernet port-list two-gigabitEthernet port range two-gigabitEthernet port-list} Enter interface configuration mode.

Step 3	<p>ip ospf retransmit-interval <i>interval</i></p> <p>Configure the interval to retransmit the LSA, DD and LSR packets on the specified interface. To restore to default value, please use the no ip ospf retransmit-interval command.</p> <p><i>interval</i>: The retransmit interval, ranging from 1 to 65535 seconds. The default value is 5 seconds.</p>
Step 4	<p>end</p> <p>Return to privileged EXEC mode.</p>
Step 5	<p>copy running-config startup-config</p> <p>Save the settings in the configuration file.</p>

The following example shows how to configure the retransmission interval of interface VLAN 2 as 10 seconds:

Switch#configure

Switch(config)#interface vlan 2

Switch(config-if)#ip ospf retransmit-interval 10

Switch(config)#end

Switch#copy running-config startup-config

7.1.23 Configuring IP OSPF Transmit-Delay

Follow these steps to configure the interval to retransmit the transmission delay of LSA on the specified interface.

Step 1	<p>configure</p> <p>Enter global configuration mode.</p>
Step 2	<p>interface {<i>vlan vid</i> <i>fastEthernet port</i> range fastEthernet <i>port-list</i> gigabitEthernet <i>port</i> range gigabitEthernet <i>port-list</i> ten-gigabitEthernet <i>port</i> range ten-gigabitEthernet <i>port-list</i> port-channel <i>port-channel</i> range port-channel <i>port-channel-list</i> hundred-gigabitEthernet <i>port</i> range hundred-gigabitEthernet <i>port-list</i> twentyFive-gigabitEthernet <i>port</i> range twentyFive-gigabitEthernet <i>port-list</i> two-gigabitEthernet <i>port</i> range two-gigabitEthernet <i>port-list</i>}</p> <p>Enter interface configuration mode.</p>
Step 3	<p>ip ospf transmit-delay <i>delay</i></p> <p>Configure the transmission delay of LSA on the specified interface. To restore to default value, please use the no ip ospf transmit-delay.</p> <p><i>delay</i>: The LSA transmission delay, ranging from 1 to 65535 seconds. The default value is 1 second.</p>
Step 4	<p>end</p> <p>Return to privileged EXEC mode.</p>

Step 5 **copy running-config startup-config**
Save the settings in the configuration file.

The following example shows how to configure LSA transmission delay of interface VLAN 2 as 2 seconds

```
Switch#configure
Switch(config)#interface vlan 2
Switch(config-if)# ip ospf transmit-delay 2
Switch(config)#end
Switch#copy running-config startup-config
```

7.1.24 Configuring IP OSPF Priority

Follow these steps to configure the priority of the specified interface.

Step 1 **configure**
Enter global configuration mode.

Step 2 **interface {vlan vid | fastEthernet port | range fastEthernet port-list | gigabitEthernet port | range gigabitEthernet port-list | ten-gigabitEthernet port | range ten-gigabitEthernet port-list | port-channel port-channel | range port-channel port-channel-list | hundred-gigabitEthernet port | range hundred-gigabitEthernet port-list | twentyFive-gigabitEthernet port | range twentyFive-gigabitEthernet port-list | two-gigabitEthernet port | range two-gigabitEthernet port-list}**
Enter interface configuration mode.

Step 3 **ip ospf priority priority**
Configure the priority of the specified interface. To restore to the default value, please use the no ip ospf priority command.

priority: The priority of the interface, ranging from 0 to 255 and the default value is 1. Interface with the priority 0 cannot be elected as DR or BDR.

Step 4 **end**
Return to privileged EXEC mode.

Step 5 **copy running-config startup-config**
Save the settings in the configuration file.

The following example shows how to configure the priority of the interface VLAN 2 as 1:

```
Switch#configure
Switch(config)#interface vlan 2
Switch(config-if)#ip ospf priority 1
Switch(config)#end
```

Switch#copy running-config startup-config

7.1.25 Configuring IP OSPF Hello-Interval

Follow these steps to configure the hello intervals on the specified interface.

Step 1	configure Enter global configuration mode.
Step 2	interface {vlan vid fastEthernet port range fastEthernet port-list gigabitEthernet port range gigabitEthernet port-list ten-gigabitEthernet port range ten-gigabitEthernet port-list port-channel port-channel range port-channel port-channel-list hundred-gigabitEthernet port range hundred-gigabitEthernet port-list twentyFive-gigabitEthernet port range twentyFive-gigabitEthernet port-list two-gigabitEthernet port range two-gigabitEthernet port-list} Enter interface configuration mode.
Step 3	ip ospf hello-interval interval Configure the hello intervals on the specified interface. To restore to the default value, please use the no ip ospf hello-interval command. <i>interval</i> : The interval of the hello packets, ranging from 1 to 65535 seconds and the default value is 10 seconds. When hello-interval is set, dead-interval will be set to 4 times it by default, but no more than 65535.
Step 4	end Return to privileged EXEC mode.
Step 5	copy running-config startup-config Save the settings in the configuration file.

The following example shows how to configure the interval of the hello packets sent on interface VLAN 2 as 20 seconds:

Switch#configure

Switch(config)#interface vlan 2

Switch(config-if)#ip ospf hello-interval 20

Switch(config)#end

Switch#copy running-config startup-config

7.1.26 Configuring IP OSPF Dead-Interval

Follow these steps to set the number of seconds after the last device hello packet was seen before its neighbors declare the OSPF router to be down.

Step 1	configure Enter global configuration mode.
--------	--

Step 2	<p>interface {vlan vid fastEthernet port range fastEthernet port-list gigabitEthernet port range gigabitEthernet port-list ten-gigabitEthernet port range ten-gigabitEthernet port-list port-channel port-channel range port-channel port-channel-list hundred-gigabitEthernet port range hundred-gigabitEthernet port-list twentyFive-gigabitEthernet port range twentyFive-gigabitEthernet port-list two-gigabitEthernet port range two-gigabitEthernet port-list}</p> <p>Enter interface configuration mode.</p>
Step 3	<p>ip ospf dead-interval interval</p> <p>Set the number of seconds after the last device hello packet was seen before its neighbors declare the OSPF router to be down. To restore to default value, please use the no ip ospf dead-interval command.</p> <p><i>interval</i>: The neighbor's dead- interval, ranging from 1 to 65535 seconds and the default is 4 times the hello interval.</p>
Step 4	<p>end</p> <p>Return to privileged EXEC mode.</p>
Step 5	<p>copy running-config startup-config</p> <p>Save the settings in the configuration file.</p>

The following example shows how to configure the neighbor's dead-interval on interface VLAN 2 as 50 seconds:

Switch#configure

Switch(config)#interface vlan 2

Switch(config-if)#ip ospf dead-interval 50

Switch(config)#end

Switch#copy running-config startup-config

7.1.27 Configuring IP OSPF Authentication

Follow these steps to configure the authentication mode of the specified interface.

Step 1	<p>configure</p> <p>Enter global configuration mode.</p>
Step 2	<p>interface {vlan vid fastEthernet port range fastEthernet port-list gigabitEthernet port range gigabitEthernet port-list ten-gigabitEthernet port range ten-gigabitEthernet port-list port-channel port-channel range port-channel port-channel-list hundred-gigabitEthernet port range hundred-gigabitEthernet port-list twentyFive-gigabitEthernet port range twentyFive-gigabitEthernet port-list two-gigabitEthernet port range two-gigabitEthernet port-list}</p> <p>Enter interface configuration mode.</p>

Step 3	<p>ip ospf authentication [message-digest null]</p> <p>Configure the authentication mode of the specified interface. To restore to default value, please use the no ip ospf authentication command.</p> <p>message-digest: Specify the authentication type as MD5.</p> <p>null: No authentication. By default it is no authentication.</p> <p>If no authentication mode is specified here, the default mode will be simple authentication.</p>
Step 4	<p>end</p> <p>Return to privileged EXEC mode.</p>
Step 5	<p>copy running-config startup-config</p> <p>Save the settings in the configuration file.</p>

The following example shows how to configure the authentication type of interface VLAN 2 as MD5:

Switch#configure

Switch(config)#interface vlan 2

Switch(config-if)#ip ospf authentication message-digest

Switch(config)#end

Switch#copy running-config startup-config

7.1.28 Configuring IP OSPF Authentication-Key

Follow these steps to configure the key of the simple authentication.

Step 1	<p>configure</p> <p>Enter global configuration mode.</p>
Step 2	<p>interface {vlan vid fastEthernet port range fastEthernet port-list gigabitEthernet port range gigabitEthernet port-list ten-gigabitEthernet port range ten-gigabitEthernet port-list port-channel port-channel range port-channel port-channel-list hundred-gigabitEthernet port range hundred-gigabitEthernet port-list twentyFive-gigabitEthernet port range twentyFive-gigabitEthernet port-list two-gigabitEthernet port range two-gigabitEthernet port-list}</p> <p>Enter interface configuration mode.</p>
Step 3	<p>ip ospf authentication-key [0 7] password</p> <p>Configure the key of the simple authentication. To cancel this configuration, please use the no ip ospf authentication-key command.</p> <p>[0 7]: Key form, 0 represents plaintext, 7 represents ciphertext.</p> <p>password: Super password, a string from 1 to 8 alphanumeric characters or symbols. The password is case sensitive, and cannot contain question marks. By default, it is empty.</p>

Step 4 **end**
Return to privileged EXEC mode.

Step 5 **copy running-config startup-config**
Save the settings in the configuration file.

The following example shows how to configure the authentication mode of interface VLAN 2 as simple authentication, and the password as 123:

Switch#configure

Switch(config)#interface vlan 2

Switch(config-if)#ip ospf authentication-key 123

Switch(config)#end

Switch#copy running-config startup-config

7.1.29 Configuring IP OSPF Message-Digest-Key

Follow these steps to configure the ID and password of the md5 authentication on the specified interface.

Step 1 **configure**
Enter global configuration mode.

Step 2 **interface {vlan vid | fastEthernet port | range fastEthernet port-list | gigabitEthernet port | range gigabitEthernet port-list | ten-gigabitEthernet port | range ten-gigabitEthernet port-list | port-channel port-channel | range port-channel port-channel-list | hundred-gigabitEthernet port | range hundred-gigabitEthernet port-list | twentyFive-gigabitEthernet port | range twentyFive-gigabitEthernet port-list | two-gigabitEthernet port | range two-gigabitEthernet port-list}**
Enter interface configuration mode.

Step 3 **ip ospf message-digest-key id md5 [0|7] password**
Configure the ID and password of the md5 authentication on the specified interface. To cancel the configuration, please use no ip ospf message-digest-key command.

id: The ID of the md5 authentication key, ranging from 1 to 255.

[0|7]: Key form, 0 represents plaintext, 7 represents ciphertext.

password: A string from 1 to 16 alphanumeric characters or symbols. The password is case sensitive, and cannot contain question marks. Key configuration is required to take effect.

Step 4 **end**
Return to privileged EXEC mode.

Step 5 **copy running-config startup-config**
Save the settings in the configuration file.

The following example shows how to configure md5 authentication key ID as 1 and password as abc on interface VLAN 2:

```
Switch#configure
```

```
Switch(config)#interface vlan 2
```

```
Switch(config-if)#ip ospf message-digest-key 1 md5 abc
```

```
Switch(config)#end
```

```
Switch#copy running-config startup-config
```

7.1.30 Configuring IP OSPF Network Type

Follow these steps to configure the network type on the specified interface.

Step 1	configure Enter global configuration mode.
Step 2	interface {vlan vid fastEthernet port range fastEthernet port-list gigabitEthernet port range gigabitEthernet port-list ten-gigabitEthernet port range ten-gigabitEthernet port-list port-channel port-channel range port-channel port-channel-list hundred-gigabitEthernet port range hundred-gigabitEthernet port-list twentyFive-gigabitEthernet port range twentyFive-gigabitEthernet port-list two-gigabitEthernet port range two-gigabitEthernet port-list} Enter interface configuration mode.
Step 3	ip ospf network { broadcast non-broadcast point-to-multipoint point-to-point } Configure the network type on the specified interface. To restore to default, please use the no ip ospf network command. broadcast: The broadcast network type. It is the default value. non-broadcast: The NBMA network type. point-to-multipoint: The point-to-multipoint network type. point-to-point: The point-to-point network type.
Step 4	end Return to privileged EXEC mode.
Step 5	copy running-config startup-config Save the settings in the configuration file.

The following example shows how to configure the network type on interface VLAN 2 as broadcast:

```
Switch#configure
```

```
Switch(config)#interface vlan 2
```

```
Switch(config-if)#ip ospf network broadcast
```

```
Switch(config)#end
```

```
Switch#copy running-config startup-config
```

7.1.31 Ignoring MTU Check

Follow these steps to ignore the MTU check in the DD exchanging process.

Step 1	configure Enter global configuration mode.
Step 2	interface {vlan vid fastEthernet port range fastEthernet port-list gigabitEthernet port range gigabitEthernet port-list ten-gigabitEthernet port range ten-gigabitEthernet port-list port-channel port-channel range port-channel port-channel-list hundred-gigabitEthernet port range hundred-gigabitEthernet port-list twentyFive-gigabitEthernet port range twentyFive-gigabitEthernet port-list two-gigabitEthernet port range two-gigabitEthernet port-list} Enter interface configuration mode.
Step 3	ip ospf mtu-ignore Ignore the MTU check in the DD exchanging process. This check is scheduled by default and the adjacency relationship will not establish if the MTUs are not matched. To restore to the default value, please use the no ip ospf mtu-ignore command.
Step 4	end Return to privileged EXEC mode.
Step 5	copy running-config startup-config Save the settings in the configuration file.

The following example shows how to configure tinterface VLAN 2 to ignore the MTU field check in the DD exchange process:

```
Switch#configure
```

```
Switch(config)#interface vlan 2
```

```
Switch(config-if)#ip ospf mtu-ignore
```

```
Switch(config)#end
```

```
Switch#copy running-config startup-config
```

7.1.32 Preventing OSPF Packets

Follow these steps to prevent an interface from sending OSPF packets.

Step 1	configure Enter global configuration mode.
--------	--

Step 2	<p>interface {vlan vid fastEthernet port range fastEthernet port-list gigabitEthernet port range gigabitEthernet port-list ten-gigabitEthernet port range ten-gigabitEthernet port-list port-channel port-channel range port-channel port-channel-list hundred-gigabitEthernet port range hundred-gigabitEthernet port-list twentyFive-gigabitEthernet port range twentyFive-gigabitEthernet port-list two-gigabitEthernet port range two-gigabitEthernet port-list}</p> <p>Enter interface configuration mode.</p>
Step 3	<p>ip ospf passive</p> <p>Prevent an interface from sending OSPF packets. To restore to the default settings, please use no ip ospf passive command. The interface is allowed to send OSPF packets by default.</p>
Step 4	<p>end</p> <p>Return to privileged EXEC mode.</p>
Step 5	<p>copy running-config startup-config</p> <p>Save the settings in the configuration file.</p>

The following example shows how to prevent interface VLAN 2 from sending OSPF packets:

```
Switch#configure
Switch(config)#interface vlan 2
Switch(config-if)#ip ospf passive
Switch(config)#end
Switch#copy running-config startup-config
```

7.1.33 Reseting OSPF Process

Follow these steps to reset the OSPF process, which will clear all the dynamic information.

Step 1	<p>clear ip ospf {process process-id}</p> <p>Reset the OSPF process, which will clear all the dynamic information. The clear ip ospf process command will reset all the OSPF processes.</p> <p>process: Clear all the OSPF processes.</p> <p>process-id: The process ID, ranging from 1 to 65535.</p>
--------	--

The following example shows how to reset all the OSPF processes:

```
Switch#clear ip ospf process
Switch#Reset selected OSPF processes? (Y/N):n
```

7.1.34 Viewing OSPF Configuration Info

Follow these steps to view the OSPF configuration information.

-
- Step 1 **show ip ospf [process-id]**
- Display the global information of the OSPF process.
- process-id*: The process ID, ranging from 1 to 65535. The global information of all the OSPF processes will be displayed if no process-id is specified.
-
- Step 2 **show ip ospf [process-id] database**
- Display the LSDB summary information.
- process-id*: The process ID, ranging from 1 to 65535. The global information of all the OSPF processes will be displayed if no process-id is specified.
-
- Step 3 **show ip ospf [process-id] interface [interface-name interface-number]**
- Display the interface information.
- process-id*: The process ID, ranging from 1 to 65535. The global information of all the OSPF processes will be displayed if no process-id is specified.
- interface-name interface-number*: Specify the interface name and number to display the interface's detailed information.
-
- Step 4 **show ip ospf [process-id] neighbor [detail | interface-name interface-number]**
- Display information of the OSPF neighbor.
- process-id*: The process ID, ranging from 1 to 65535. The global information of all the OSPF processes will be displayed if no process-id is specified.
- detail*: The detailed information of the neighbor
- interface-name interface-number*: Specify the interface name and number to display the interface's detailed information.
-
- Step 5 **show ip ospf [process-id] route**
- Display the OSPF routing table.
- process-id*: The process ID, ranging from 1 to 65535. The ABR/ASBR routing tables of all processes will be displayed if no process ID is specified.
-
- Step 6 **show ip ospf [process-id] border-routers**
- Display the routing table of the ABR/ASBR.
-

8 OSPFv3 Configurations

OSPF is an Interior Gateway Protocol (IGP) designed expressly for IP networks, supporting IP subnetting and tagging of externally derived routing information. OSPF also allows packet authentication and uses IP multicast when sending and receiving packets.

Currently, OSPF Version 2 (RFC2328) is used for the IPv4 protocol; Use OSPF Version 3 (RFC2740) for IPv6 protocol. OSPFv3 is short for OSPF Version 3 and is the OSPF routing protocol running on IPv6 (RFC5340, same as RFC2740).

8.1 Using the CLI

8.1.1 Enabling OSPFv3 Routing

Follow these steps to enable an OSPFv3 routing process and enter the router configuration mode

Step 1	configure	Enter global configuration mode.
Step 2	ipv6 router ospf	Enable an OSPFv3 routing process and enter the router configuration mode. To delete the specified OSPFv3 routing process, please use the no ipv6 router ospf command.
Step 3	end	Return to privileged EXEC mode.
Step 4	copy running-config startup-config	Save the settings in the configuration file.

The following example shows how to enable an OSPFv3 routing process:

```
Switch#configure
Switch(config)#ipv6 router ospf
Switch(config)#end
Switch#copy running-config startup-config
```

8.1.2 Configuring Router ID

Follow these steps to configure the router ID.

Step 1	configure	Enter global configuration mode.
--------	------------------	----------------------------------

Step 2	ipv6 router ospf
	Enable an OSPFv3 routing process and enter the router configuration mode. To delete the specified OSPFv3 routing process, please use the no ipv6 router ospf command.
Step 3	router-id <i>router-id</i>
	Configure the router ID. The no router-id command is used to delete the configured router ID.
	<i>router-id</i> : The router ID in the format of dotted decimal notation. 0.0.0.0 is illegal.
Step 4	end
	Return to privileged EXEC mode.
Step 5	copy running-config startup-config
	Save the settings in the configuration file.

The following example shows how to configure the router ID of OSPFv3 routing process as 1.1.1.1:

```
Switch#configure
```

```
Switch(config)#ipv6 router ospf
```

```
Switch(config-rtr)#router-id 1.1.1.1
```

```
Switch(config)#end
```

```
Switch#copy running-config startup-config
```

8.1.3 Configuring Max-Paths

Follow these steps to configure the maximum number of the equal-cost multipath routings.

Step 1	configure
	Enter global configuration mode.
Step 2	ipv6 router ospf
	Enable an OSPFv3 routing process and enter the router configuration mode. To delete the specified OSPFv3 routing process, please use the no ipv6 router ospf command.
Step 3	maximum-paths <i>number</i>
	Configure the maximum number of the equal-cost multipath routings. To restore to default value, please use the no maximum-paths command.
	<i>number</i> : The maximum number of the equal-cost multipath routings, ranging from 1 to 32. The default value is 32.
Step 4	end
	Return to privileged EXEC mode.

-
- Step 5 **copy running-config startup-config**
Save the settings in the configuration file.
-

The following example shows how to configure the maximum number of the equal-cost multipath routings as 2:

```
Switch#configure
Switch(config)#ipv6 router ospf
Switch(config-rtr)#maximum-paths 2
Switch(config)#end
Switch#copy running-config startup-config
```

8.1.4 Configuring ASBR

Follow these steps to configure the ASBR to redistribute the external routes from other routing protocols to the OSPFv3 domain in type-5 LSAs.

-
- Step 1 **configure**
Enter global configuration mode.
-
- Step 2 **ipv6 router ospf**
Enable an OSPFv3 routing process and enter the router configuration mode. To delete the specified OSPFv3 routing process, please use the no ipv6 router ospf command.
-
- Step 3 **redistribute { connected | static | rip }**
Configure the ASBR to redistribute the external routes from other routing protocols to the OSPFv3 domain in type-5 LSAs. To restore the certain optional parameters to default values, please use the no redistribute command with corresponding parameters.

connected: Specify the external route type as connected.

static: Specify the external route type as static.

rip: Specify the external route type as RIPNG.
-
- Step 4 **end**
Return to privileged EXEC mode.
-
- Step 5 **copy running-config startup-config**
Save the settings in the configuration file.
-

The following example shows how to redistribute the RIPNG routes from the external in the OSPFv3 domain:

```
Switch#configure
Switch(config)#ipv6 router ospf
```

```
Switch(config-rtr)#redistribute rip
```

```
Switch(config)#end
```

```
Switch#copy running-config startup-config
```

8.1.5 Configuring Default-Information Originate

Follow these steps to advertise the default route as AS-External LSA.

Step 1	configure Enter global configuration mode.
Step 2	ipv6 router ospf Enable an OSPFv3 routing process and enter the router configuration mode. To delete the specified OSPFv3 routing process, please use the no ipv6 router ospf command.
Step 3	default-information originate [always] [metric cost] [metric-type type] Advertise the default route as AS-External LSA. To cancel the advertisement of the default route, please use the no default-information originate command without any optional parameters. To restore the certain parameters to default values, please use the no default-information originate command with corresponding parameters. always: OSPFv3 will advertise the default route whether there is default route in the IPV6 routing table or not. If the parameter is not configured, OSPFv3 will advertise the default route only when there is default route in the IPV6 routing table. cost: The default cost of the default route, ranging form 1 to 16777214. Its default value is 1. type: The type of the external routes, either 1 or 2. The default value is 2.
Step 4	end Return to privileged EXEC mode.
Step 5	copy running-config startup-config Save the settings in the configuration file.

The following example shows how to configure OSPFv3 to advertise the default route regardless of ipv6 routing table having default route or not:

```
Switch#configure
```

```
Switch(config)#ipv6 router ospf
```

```
Switch(config-rtr)#default-information originate always
```

```
Switch(config)#end
```

```
Switch#copy running-config startup-config
```

8.1.6 Configuring Auto-Cost

Follow these steps to enable the auto computing function of the interface cost and configure the reference bandwidth.

Step 1	configure Enter global configuration mode.
Step 2	ipv6 router ospf Enable an OSPFv3 routing process and enter the router configuration mode. To delete the specified OSPFv3 routing process, please use the no ipv6 router ospf command.
Step 3	auto-cost reference-bandwidth <i>bandwidth</i> Enable the auto computing function of the interface cost and configure the reference bandwidth. The interface cost is the ratio of the reference bandwidth to the interface bandwidth. To restore the reference bandwidth to default value, please use the no auto-cost reference-bandwidth command. <i>bandwidth</i> : The reference bandwidth, ranging from 1 to 4294967 Mbps. Its default value is 100Mbps.
Step 4	end Return to privileged EXEC mode.
Step 5	copy running-config startup-config Save the settings in the configuration file.

The following example shows how to enable the auto computing function of the interface cost and configure the reference bandwidth as 10000 Mbps:

```
Switch#configure
```

```
Switch(config)#ipv6 router ospf
```

```
Switch(config-rtr)#auto-cost reference-bandwidth 10000
```

```
Switch(config)#end
```

```
Switch#copy running-config startup-config
```

8.1.7 Configuring OSPFv3 Administrative Distance

Follow these steps to configure the OSPFv3 administrative distance.

Step 1	configure Enter global configuration mode.
Step 2	ipv6 router ospf Enable an OSPFv3 routing process and enter the router configuration mode. To delete the specified OSPFv3 routing process, please use the no ipv6 router ospf command.

Step 3	distance administrative-distance Configure the OSPFv3 administrative distance. To restore to the default distance, please use the no distance command. The administrative distance represents the priority of the routes. The smaller administrative distance corresponds to higher priority. When different routing protocols possess the same route to the same destination, the route with the highest priority will be selected to add to the IPv6 routing table according to the administrative distance. <i>administrative-distance</i> : Routing administrative distance, ranging from 1 to 254. Its default value is 110.
Step 4	end Return to privileged EXEC mode.
Step 5	copy running-config startup-config Save the settings in the configuration file.

The following example shows how to configure the OSPFV3 routing administrative distance as 100:

```
Switch#configure
Switch(config)#ipv6 router ospf
Switch(config-rtr)#distance 100
Switch(config)#end
Switch#copy running-config startup-config
```

8.1.8 Configuring OSPFv3 Distance

Follow these steps to configure the OSPFv3 distance for different types of routes.

Step 1	configure Enter global configuration mode.
Step 2	ipv6 router ospf Enable an OSPFv3 routing process and enter the router configuration mode. To delete the specified OSPFv3 routing process, please use the no ipv6 router ospf command.
Step 3	distance ospf { external distance inter-area distance intra-area distance } Configure the OSPFv3 distance for different types of routes. To restore to the default distance, please use the no distance command. external : External type 5 and type 7 routes. inter-area : Inter-area routes. intra-area : Intra-area routes. <i>distance</i> : Distance for different types of routes, ranging from 1 to 254. Its default value is 110.

-
- | | |
|--------|---|
| Step 4 | end
Return to privileged EXEC mode. |
|--------|---|
-
- | | |
|--------|---|
| Step 5 | copy running-config startup-config
Save the settings in the configuration file. |
|--------|---|
-

The following example shows how to configure the OSPFV3 routing distance of the external routers as 100:

Switch#configure

Switch(config)#ipv6 router ospf

Switch(config-rtr)#distance ospf external 100

Switch(config)#end

Switch#copy running-config startup-config

8.1.9 Configuring Computing Delay and Interval

Follow these steps to configure the computing delay and interval of the SPF.

-
- | | |
|--------|--|
| Step 1 | configure
Enter global configuration mode. |
|--------|--|
-
- | | |
|--------|--|
| Step 2 | ipv6 router ospf
Enable an OSPFv3 routing process and enter the router configuration mode. To delete the specified OSPFv3 routing process, please use the no ipv6 router ospf command. |
|--------|--|
-
- | | |
|--------|---|
| Step 3 | timers throttle spf spf-delay spf-holdtime spf-max-holdtime
Configure the computing delay and interval of the SPF, thus preventing the consumption of the CPU and memory caused by frequent SPF computing. To restore to the default value, please use the no timers throttle spf command.

<i>spf-delay</i> : The delay time of the SPF computing, ranging from 1 to 600000 milliseconds. The default value is 0 milliseconds.

<i>spf-holdtime</i> : The minimum interval between two SPF computings, ranging from 1 to 600000 milliseconds. The default value is 50 milliseconds.

<i>spf-max-holdtime</i> : The maximum interval between two SPF computings, ranging from 1 to 600000 milliseconds. The default value is 5000 milliseconds. |
|--------|---|
-
- | | |
|--------|---|
| Step 4 | end
Return to privileged EXEC mode. |
|--------|---|
-
- | | |
|--------|---|
| Step 5 | copy running-config startup-config
Save the settings in the configuration file. |
|--------|---|
-

The following example shows how to configure the SPF computing delay as 10 seconds and the interval between 10 and 50 seconds:

```
Switch#configure
Switch(config)#ipv6 router ospf
Switch(config-rtr)#timers throttle spf 10000 10000 50000
Switch(config)#end
Switch#copy running-config startup-config
```

8.1.10 Configuring OSPFv3 LSA Reception Interval

Follow these steps to configure the time interval for OSPFv3 LSA reception

Step 1	configure Enter global configuration mode.
Step 2	ipv6 router ospf Enable an OSPFv3 routing process and enter the router configuration mode. To delete the specified OSPFv3 routing process, please use the no ipv6 router ospf command.
Step 3	timers lsa arrival <i>delay-time</i> Configure the time interval for OSPFv3 LSA reception. To restore to the default value, please use the no timers lsa arrival command. <i>delay-time</i> : The time interval for OSPFv3 LSA reception, ranging from 0 to 600000 milliseconds. The default value is 1000 milliseconds.
Step 4	end Return to privileged EXEC mode.
Step 5	copy running-config startup-config Save the settings in the configuration file.

The following example shows how to configure the time interval for OSPFv3 LSA reception as 10 seconds:

```
Switch#configure
Switch(config)#ipv6 router ospf
Switch(config-rtr)# timers lsa arrival 10000
Switch(config)#end
Switch#copy running-config startup-config
```

8.1.11 Defining Stub Area

Follow these steps to define an area as a stub area.

Step 1	configure Enter global configuration mode.
Step 2	ipv6 router ospf Enable an OSPFv3 routing process and enter the router configuration mode. To delete the specified OSPFv3 routing process, please use the no ipv6 router ospf command.
Step 3	area area-id stub [no-summary] Define an area as a stub area. To restore the stub area to a normal one, please use the no area stub command. To restore the certain parameters to default values, please use the no area stub command with corresponding parameters. <i>area-id</i> : The area ID, in the format of an IP address in dotted decimal notation or decimal value ranging from 1 to 4294967295. no-summary : Configure the stub area as a totally stub area, where the ABR advertises neither the destinations in other areas nor the external routes. The stub area is not a totally stub area by default.
Step 4	end Return to privileged EXEC mode.
Step 5	copy running-config startup-config Save the settings in the configuration file.

The following example shows how to configure the area 1 as a totally stub area:

```
Switch#configure
Switch(config)#ipv6 router ospf
Switch(config-rtr)#area 1 stub no-summary
Switch(config)#end
Switch#copy running-config startup-config
```

8.1.12 Defining NSSA Area

Follow these steps to define an area as a NSSA area.

Step 1	configure Enter global configuration mode.
Step 2	ipv6 router ospf Enable an OSPFv3 routing process and enter the router configuration mode. To delete the specified OSPFv3 routing process, please use the no ipv6 router ospf command.

-
- Step 3 **area area-id nssa [no-summary]**
- Define an area as a NSSA area. To restore the NSSA area to a normal one, please use the no area NSSA command without any optional parameters. To restore the certain parameters to default values, please use the no area NSSA command with corresponding parameters.
- area-id*: The area ID, in the format of an IP address in dotted decimal notation or decimal value ranging from 1 to 4294967295.
- no-summary**: Configure the NSSA area as a totally NSSA area, where the ABR advertises neither the destinations in other areas nor the external routes. The NSSA area is not a totally NSSA area by default.
-
- Step 4 **end**
- Return to privileged EXEC mode.
-
- Step 5 **copy running-config startup-config**
- Save the settings in the configuration file.
-

The following example shows how to configure Area 1 as a totally NSSA area:

Switch#configure

Switch(config)#ipv6 router ospf

Switch(config-rtr)#area 1 nssa no-summary

Switch(config)#end

Switch#copy running-config startup-config

8.1.13 Configuring Summary Route

Follow these steps to configure a summary route

-
- Step 1 **configure**
- Enter global configuration mode.
-
- Step 2 **ipv6 router ospf**
- Enable an OSPFv3 routing process and enter the router configuration mode. To delete the specified OSPFv3 routing process, please use the no ipv6 router ospf command.
-

Step 3	<p>area area-id range ipv6-address/mask-num [advertise cost cost not-advertise]</p> <p>Configure a summary route. To delete this route, please use the no area range command. By default no route is summarized.</p> <p>This command is only used with the ABR to summarize the route information of a certain area. The ABR only sends one summarized route of the routes in the aggregated segment to the other areas. An area can be configured with multiple summary segments, which can be aggregated by OSPFv3.</p> <p>If the no area range command is configured, the formally summarized routes will be redistributed.</p> <p>area-id: The area ID, in the format of an IP address in dotted decimal notation or decimal value ranging from 0 to 4294967295.</p> <p>ipv6-address: The destination of the aggregated route.</p> <p>mask-num: The network mask for aggregated route, in the format of mask bits.</p> <p>advertise: Allow route aggregation of ABR broadcast.</p> <p>not-dvertise: Suppress route aggregation of ABR broadcast.</p> <p>cost: The cost of the aggregated route, ranging from 1 to 16777214. The default value is the maximum one of all the aggregated routes. The cost parameter can be configured only when the advtise parameter is enabled. When configured as not-advtise, the cost parameter will be restored to the default value.</p>
--------	--

Step 4	<p>end</p> <p>Return to privileged EXEC mode.</p>
--------	--

Step 5	<p>copy running-config startup-config</p> <p>Save the settings in the configuration file.</p>
--------	--

The following example shows how to configure one aggregated route 2001::1/64 with the cost 10 in the Area 0:

Switch#configure

Switch(config)#ipv6 router ospf

Switch(config-rtr)#area 0 range 2001::1/64 cost 10

Switch(config)#end

Switch#copy running-config startup-config

8.1.14 Assigning Interfaces

Follow these steps to assign the interface to different regions.

Step 1	<p>configure</p> <p>Enter global configuration mode.</p>
--------	---

Step 2	<p>interface {vlan <i>vid</i> fastEthernet <i>port</i> range fastEthernet <i>port-list</i> gigabitEthernet <i>port</i> range gigabitEthernet <i>port-list</i> ten-gigabitEthernet <i>port</i> range ten-gigabitEthernet <i>port-list</i> port-channel <i>port-channel</i> range port-channel <i>port-channel-list</i> hundred-gigabitEthernet <i>port</i> range hundred-gigabitEthernet <i>port-list</i> twentyFive-gigabitEthernet <i>port</i> range twentyFive-gigabitEthernet <i>port-list</i> two-gigabitEthernet <i>port</i> range two-gigabitEthernet <i>port-list</i>}</p> <p>Enter interface configuration mode.</p>
Step 3	<p>ipv6 ospf area <i>area-id</i> [instance-id <i>instance-id</i>]</p> <p>Assign the interface to different regions. By default, the interface does not belong to any area. Only the interface attached to a certain area can receive OSPFv3 packets normally. To restore to the default value, please use the no ipv6 ospf area command.</p> <p><i>area-id</i>: The area ID, in the format of an IP address in dotted decimal notation or decimal value ranging from 0 to 4294967295.</p> <p><i>instance-id</i>: The instance ID, ranging from 0 to 255. OSPFv3 supports running multiple instances on a single link, using the optional parameter instance-id as the instance identifier. The instance number only affects the reception of OSPFv3 messages. By default, this parameter value is 0. To restore the default value, use the no ipv6 ospf area area-id instance-id command.</p>
Step 4	<p>end</p> <p>Return to privileged EXEC mode.</p>
Step 5	<p>copy running-config startup-config</p> <p>Save the settings in the configuration file.</p>

The following example shows how to assign interface VLAN 2 to area 10:

```

Switch#configure
Switch(config)#interface vlan 2
Switch(config-if)#ipv6 ospf area 10
Switch(config)#end
Switch#copy running-config startup-config

```

8.1.15 Configuring Interface Cost

Follow these steps to configure the interface cost.

Step 1	<p>configure</p> <p>Enter global configuration mode.</p>
--------	---

Step 2	<p>interface {vlan vid fastEthernet port range fastEthernet port-list gigabitEthernet port range gigabitEthernet port-list ten-gigabitEthernet port range ten-gigabitEthernet port-list port-channel port-channel range port-channel port-channel-list hundred-gigabitEthernet port range hundred-gigabitEthernet port-list twentyFive-gigabitEthernet port range twentyFive-gigabitEthernet port-list two-gigabitEthernet port range two-gigabitEthernet port-list}</p> <p>Enter interface configuration mode.</p>
Step 3	<p>ipv6 ospf cost cost</p> <p>Configure the interface cost. To restore to the default value, please use the no ipv6 ospf cost command.</p> <p><i>cost</i>: The interface cost, ranging from 1 to 65535. The default value is calculated according to the bandwidth.</p>
Step 4	<p>end</p> <p>Return to privileged EXEC mode.</p>
Step 5	<p>copy running-config startup-config</p> <p>Save the settings in the configuration file.</p>

The following example shows how to configure the cost of interface VLAN 2 as 10:

```
Switch#configure
Switch(config)#interface vlan 2
Switch(config-if)#ipv6 ospf cost 10
Switch(config)#end
Switch#copy running-config startup-config
```

8.1.16 Configuring IPv6 OSPF Retransmit-Interval

Follow these steps to configure the interval to retransmit the LSA, DD and LSR packets on the specified interface.

Step 1	<p>configure</p> <p>Enter global configuration mode.</p>
Step 2	<p>interface {vlan vid fastEthernet port range fastEthernet port-list gigabitEthernet port range gigabitEthernet port-list ten-gigabitEthernet port range ten-gigabitEthernet port-list port-channel port-channel range port-channel port-channel-list hundred-gigabitEthernet port range hundred-gigabitEthernet port-list twentyFive-gigabitEthernet port range twentyFive-gigabitEthernet port-list two-gigabitEthernet port range two-gigabitEthernet port-list}</p> <p>Enter interface configuration mode.</p>

Step 3	ipv6 ospf retransmit-interval interval
	Configure the interval to retransmit the LSA, DD and LSR packets on the specified interface. To restore to default value, please use the no ipv6 ospf retransmit-interval command.
	<i>interval</i> : The retransmit interval, ranging from 1 to 65535 seconds. The default value is 5 seconds.
Step 4	end
	Return to privileged EXEC mode.
Step 5	copy running-config startup-config
	Save the settings in the configuration file.

The following example shows how to configure the retransmission interval of interface VLAN 2 as 10 seconds:

Switch#configure

Switch(config)#interface vlan 2

Switch(config-if)#ipv6 ospf retransmit-interval 10

Switch(config)#end

Switch#copy running-config startup-config

8.1.17 Configuring IPv6 OSPF Transmit-Delay

Follow these steps to configure the interval to retransmit the transmission delay of LSA on the specified interface.

Step 1	configure
	Enter global configuration mode.
Step 2	interface {vlan vid fastEthernet port range fastEthernet port-list gigabitEthernet port range gigabitEthernet port-list ten-gigabitEthernet port range ten-gigabitEthernet port-list port-channel port-channel range port-channel port-channel-list hundred-gigabitEthernet port range hundred-gigabitEthernet port-list twentyFive-gigabitEthernet port range twentyFive-gigabitEthernet port-list two-gigabitEthernet port range two-gigabitEthernet port-list}
	Enter interface configuration mode.
Step 3	ipv6 ospf transmit-delay delay
	Configure the transmission delay of LSA on the specified interface. To restore to default value, please use the no ipv6 ospf transmit-delay.
	<i>delay</i> : The LSA transmission delay, ranging from 1 to 3600 seconds. The default value is 1 second.
Step 4	end
	Return to privileged EXEC mode.

Step 5 **copy running-config startup-config**
Save the settings in the configuration file.

The following example shows how to configure LSA transmission delay of interface VLAN 2 as 2 seconds.

```
Switch#configure
Switch(config)#interface vlan 2
Switch(config-if)# ipv6 ospf transmit-delay 2
Switch(config)#end
Switch#copy running-config startup-config
```

8.1.18 Configuring IPv6 OSPF Priority

Follow these steps to configure the priority of the specified interface.

Step 1 **configure**
Enter global configuration mode.

Step 2 **interface {vlan vid | fastEthernet port | range fastEthernet port-list | gigabitEthernet port | range gigabitEthernet port-list | ten-gigabitEthernet port | range ten-gigabitEthernet port-list | port-channel port-channel | range port-channel port-channel-list | hundred-gigabitEthernet port | range hundred-gigabitEthernet port-list | twentyFive-gigabitEthernet port | range twentyFive-gigabitEthernet port-list | two-gigabitEthernet port | range two-gigabitEthernet port-list}**
Enter interface configuration mode.

Step 3 **ipv6 ospf priority priority**
Configure the priority of the specified interface. To restore to the default value, please use the no ipv6 ospf priority command.

priority: The priority of the interface, ranging from 0 to 255 and the default value is 1. Interface with the priority 0 cannot be elected as DR or BDR.

Step 4 **end**
Return to privileged EXEC mode.

Step 5 **copy running-config startup-config**
Save the settings in the configuration file.

The following example shows how to configure the priority of the interface VLAN 2 as 10:

```
Switch#configure
Switch(config)#interface vlan 2
Switch(config-if)#ipv6 ospf priority 10
Switch(config)#end
```

Switch#copy running-config startup-config

8.1.19 Configuring IPv6 OSPF Hello-Interval

Follow these steps to configure the hello intervals on the specified interface.

Step 1	configure Enter global configuration mode.
Step 2	interface {vlan vid fastEthernet port range fastEthernet port-list gigabitEthernet port range gigabitEthernet port-list ten-gigabitEthernet port range ten-gigabitEthernet port-list port-channel port-channel range port-channel port-channel-list hundred-gigabitEthernet port range hundred-gigabitEthernet port-list twentyFive-gigabitEthernet port range twentyFive-gigabitEthernet port-list two-gigabitEthernet port range two-gigabitEthernet port-list} Enter interface configuration mode.
Step 3	ipv6 ospf hello-interval interval Configure the hello intervals on the specified interface. To restore to the default value, please use the no ipv6 ospf hello-interval command. <i>interval:</i> The interval of the hello packets, ranging from 1 to 65535 seconds and the default value is 10 seconds. When hello-interval is set, dead-interval will be set to 4 times it by default, but no more than 65535.
Step 4	end Return to privileged EXEC mode.
Step 5	copy running-config startup-config Save the settings in the configuration file.

The following example shows how to configure the interval of the hello packets sent on interface VLAN 2 as 20 seconds:

Switch#configure

Switch(config)#interface vlan 2

Switch(config-if)#ipv6 ospf hello-interval 20

Switch(config)#end

Switch#copy running-config startup-config

8.1.20 Configuring IPv6 OSPF Dead-Interval

Follow these steps to set the number of seconds after the last device hello packet was seen before its neighbors declare the OSPFv3 router to be down.

Step 1	configure Enter global configuration mode.
--------	--

Step 2	<p>interface {vlan vid fastEthernet port range fastEthernet port-list gigabitEthernet port range gigabitEthernet port-list ten-gigabitEthernet port range ten-gigabitEthernet port-list port-channel port-channel range port-channel port-channel-list hundred-gigabitEthernet port range hundred-gigabitEthernet port-list twentyFive-gigabitEthernet port range twentyFive-gigabitEthernet port-list two-gigabitEthernet port range two-gigabitEthernet port-list}</p> <p>Enter interface configuration mode.</p>
Step 3	<p>ipv6 ospf dead-interval interval</p> <p>Set the number of seconds after the last device hello packet was seen before its neighbors declare the OSPFv3 router to be down. To restore to default value, please use the no ipv6 ospf dead-interval command.</p> <p><i>interval</i>: The neighbor's dead-interval, ranging from 1 to 65535 seconds and the default is 4 times the hello interval.</p>
Step 4	<p>end</p> <p>Return to privileged EXEC mode.</p>
Step 5	<p>copy running-config startup-config</p> <p>Save the settings in the configuration file.</p>

The following example shows how to configure the neighbor's dead-interval on interface VLAN 2 as 50 seconds:

Switch#configure

Switch(config)#interface vlan 2

Switch(config-if)#ipv6 ospf dead-interval 50

Switch(config)#end

Switch#copy running-config startup-config

8.1.21 Configuring IPv6 OSPF Network Type

Follow these steps to configure the network type on the specified interface.

Step 1	<p>configure</p> <p>Enter global configuration mode.</p>
Step 2	<p>interface {vlan vid fastEthernet port range fastEthernet port-list gigabitEthernet port range gigabitEthernet port-list ten-gigabitEthernet port range ten-gigabitEthernet port-list port-channel port-channel range port-channel port-channel-list hundred-gigabitEthernet port range hundred-gigabitEthernet port-list twentyFive-gigabitEthernet port range twentyFive-gigabitEthernet port-list two-gigabitEthernet port range two-gigabitEthernet port-list}</p> <p>Enter interface configuration mode.</p>

Step 3	ipv6 ospf network { broadcast point-to-point } Configure the network type on the specified interface. To restore to default, please use the no ipv6 ospf network command. broadcast: The broadcast network type. It is the default value. point-to-point: The point-to-point network type.
Step 4	end Return to privileged EXEC mode.
Step 5	copy running-config startup-config Save the settings in the configuration file.

The following example shows how to configure the network type on interface VLAN 2 as broadcast:

Switch#configure

Switch(config)#interface vlan 2

Switch(config-if)#ipv6 ospf network broadcast

Switch(config)#end

Switch#copy running-config startup-config

8.1.22 Ignoring MTU Check

Follow these steps to ignore the MTU check in the DD exchanging process.

Step 1	configure Enter global configuration mode.
Step 2	interface {vlan vid fastEthernet port range fastEthernet port-list gigabitEthernet port range gigabitEthernet port-list ten-gigabitEthernet port range ten-gigabitEthernet port-list port-channel port-channel range port-channel port-channel-list hundred-gigabitEthernet port range hundred-gigabitEthernet port-list twentyFive-gigabitEthernet port range twentyFive-gigabitEthernet port-list two-gigabitEthernet port range two-gigabitEthernet port-list} Enter interface configuration mode.
Step 3	ipv6 ospf mtu-ignore Ignore the MTU check in the DD exchanging process. This check is scheduled by default and the adjacency relationship will not establish if the MTUs are not matched. To restore to the default value, please use the no ipv6 ospf mtu-ignore command.
Step 4	end Return to privileged EXEC mode.

-
- Step 5 **copy running-config startup-config**
Save the settings in the configuration file.
-

The following example shows how to configure tinterface VLAN 2 to ignore the MTU field check in the DD exchange process:

```
Switch#configure
Switch(config)#interface vlan 2
Switch(config-if)#ipv6 ospf mtu-ignore
Switch(config)#end
Switch#copy running-config startup-config
```

8.1.23 Preventing OSPFv3 Packets

Follow these steps to prevent an interface from sending OSPFv3 packets.

-
- Step 1 **configure**
Enter global configuration mode.
-
- Step 2 **interface {vlan vid | fastEthernet port | range fastEthernet port-list | gigabitEthernet port | range gigabitEthernet port-list | ten-gigabitEthernet port | range ten-gigabitEthernet port-list | port-channel port-channel | range port-channel port-channel-list | hundred-gigabitEthernet port | range hundred-gigabitEthernet port-list | twentyFive-gigabitEthernet port | range twentyFive-gigabitEthernet port-list | two-gigabitEthernet port | range two-gigabitEthernet port-list}**
Enter interface configuration mode.
-
- Step 3 **ipv6 ospf passive**
Prevent an interface from sending OSPFv3 packets. To restore to the default settings, please use no ipv6 ospf passive command. The interface is allowed to send OSPFv3 packets by default.
-
- Step 4 **end**
Return to privileged EXEC mode.
-
- Step 5 **copy running-config startup-config**
Save the settings in the configuration file.
-

The following example shows how to prevent interface VLAN 2 from sending OSPFv3 packets:

```
Switch#configure
Switch(config)#interface vlan 2
Switch(config-if)#ipv6 ospf passive
Switch(config)#end
```

```
Switch#copy running-config startup-config
```

8.1.24 Reseting OSPFv3 Process

Follow these steps to reset the OSPFv3 process, which will clear all the dynamic information.

Step 1	clear ipv6 ospf { process interface } Reset the OSPFv3 process, which will clear all the dynamic information. The clear ipv6 ospf process command will reset the OSPFv3 process. The clear ipv6 ospf interface command will reset the configuration of the interface in the OSPFv3 process.
Step 2	copy running-config startup-config Save the settings in the configuration file.

The following example shows how to reset the OSPFv3 process:

```
Switch#clear ipv6 ospf process
```

```
Switch#Reset OSPFv3 process? (Y/N):y
```

```
Switch#copy running-config startup-config
```

8.1.25 Viewing OSPFv3 Configuration Info

Follow these steps to view the OSPFv3 configuration information.

Step 1	show ipv6 ospf Display the global information of the OSPFv3 process.
Step 2	show ipv6 ospf database Display the LSDB in OSPFv3 process.
Step 3	show ipv6 ospf interface Display the interface information.
Step 4	show ipv6 ospf neighbor Display information of the OSPFv3 neighbor.
Step 5	show ipv6 ospf border-routers Display the routing tables of the ABR/ASBR.
Step 6	show ipv6 ospf rib Display the OSPFv3 routing table.

9 Example for Static Routing

9.1 Network Requirements

As shown below, Host A and Host B are on different network segments. To meet business needs, Host A and Host B need to establish a connection without using dynamic routing protocols to ensure stable connectivity.

Figure 9-1 Network Topology

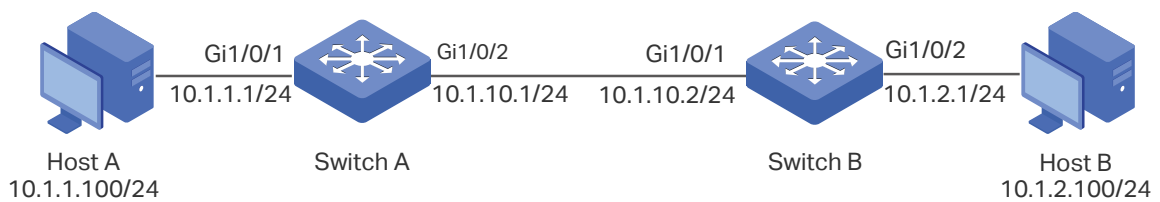

9.2 Configuration Scheme

To implement this requirement, you can configure the default gateway of host A as 10.1.1.1/24, the default gateway of host B as 10.1.2.1/24, and configure IPv4 static routes on Switch A and Switch B so that hosts on different network segments can communicate with each other.

Demonstrated with SG6654XHP, the following sections provide configuration procedure in two ways: using the GUI and using the CLI.

9.3 Using the GUI

The configurations of Switch A and Switch B are similar. The following introductions take Switch A as an example.

- 1) Choose the menu **L3 FEATURES > Interface** to create a routed port Gi1/0/1 with the mode as static, the IP address as 10.1.1.1, the mask as 255.255.255.0 and the admin status as Enable. Create a routed port Gi1/0/2 with the mode as static, the IP address as 10.1.10.1, the mask as 255.255.255.0 and the admin status as Enable.

Figure 9-2 Create a Routed Port Gi1/0/1 for Switch A

Interface

Interface ID: Routed Port 1/0/1 (Format: 1/0/1)

UNIT1

2 4 6 8 10 12 14 16 18 20 22 24 26 28
1 3 5 7 9 11 13 15 17 19 21 23 25 27

IP Address Mode: None Static DHCP BOOTP

IP Address: 10.1.1.1 (Format: 192.168.0.1)

Subnet Mask: 255.255.255.0 (Format: 255.255.255.0)

Admin Status: Enable

Interface Name: (Optional. 1-16 characters)

Cancel
Create

Figure 9-3 Create a Routed Port Gi1/0/2 for Switch A

Interface

Interface ID: Routed Port 1/0/2 (Format: 1/0/1)

UNIT1

2 4 6 8 10 12 14 16 18 20 22 24 26 28
 1 3 5 7 9 11 13 15 17 19 21 23 25 27

IP Address Mode: None Static DHCP BOOTP

IP Address: 10.1.10.1 (Format: 192.168.0.1)

Subnet Mask: 255.255.255.0 (Format: 255.255.255.0)

Admin Status: Enable

Interface Name: (Optional. 1-16 characters)

Cancel
Create

- 2) Choose the menu **L3 FEATURES > Static Routing > IPv4 Static Routing** to load the following page. Add a static routing entry with the destination as 10.1.2.0, the subnet

mask as 255.255.255.0 and the next hop as 10.1.10.2. For switch B, add a static route entry with the destination as 10.1.1.0, the subnet mask as 255.255.255.0 and the next hop as 10.1.10.1.

Figure 9-4 Add a Static Route for Switch A

9.4 Using the CLI

The configurations of Switch A and Switch B are similar. The following introductions take Switch A as an example.

- 1) Create a routed port Gi1/0/1 with the mode as static, the IP address as 10.1.1.1, the mask as 255.255.255.0 and the admin status as Enable. Create a routed port Gi1/0/2 with the mode as static, the IP address as 10.1.10.1, the mask as 255.255.255.0 and the admin status as Enable.

```
Switch_A#configure
```

```
Switch_A(config)#interface gigabitEthernet 1/0/1
```

```
Switch_A(config-if)#no switchport
```

```
Switch_A(config-if)#ip address 10.1.1.1 255.255.255.0
```

```
Switch_A(config-if)#exit
```

```
Switch_A(config)#interface gigabitEthernet 1/0/2
```

```
Switch_A(config-if)#no switchport
```

```
Switch_A(config-if)#ip address 10.1.10.1 255.255.255.0
```

- 2) Add a static route entry with the destination as 10.1.2.0, the subnet mask as 255.255.255.0 and the next hop as 10.1.10.2. For switch B, add a static route entry with the destination as 10.1.1.0, the subnet mask as 255.255.255.0 and the next hop as 10.1.10.1.

```
Switch_A#configure
Switch_A(config)#ip route 10.1.2.0 255.255.255.0 10.1.10.2
Switch_A(config)#end
Switch_A#copy running-config startup-config
```

Verify the Configurations

■ Switch A

Verify the static routing configuration:

```
Switch_A#show ip route
```

Codes: C - connected, S - static

* - candidate default

```
C 10.1.1.0/24 is directly connected, Vlan10
C 10.1.10.0/24 is directly connected, Vlan20
S 10.1.2.0/24 [1/0] via 10.1.10.2, Vlan20
```

■ Switch B

Verify the static routing configuration:

```
Switch_B#show ip route
```

Codes: C - connected, S - static

* - candidate default

```
C 10.1.2.0/24 is directly connected, Vlan30
C 10.1.10.0/24 is directly connected, Vlan20
S 10.1.1.0/24 [1/0] via 10.1.10.1, Vlan20
```

■ Connectivity Between Switch A and Switch B

Run the ping command on switch A to verify the connectivity:

```
Switch_A#ping 10.1.2.1
```

Pinging 10.1.2.1 with 64 bytes of data :

Reply from 10.1.2.1 : bytes=64 time<16ms TTL=64

Reply from 10.1.2.1 : bytes=64 time<16ms TTL=64

Reply from 10.1.2.1 : bytes=64 time<16ms TTL=64

Reply from 10.1.2.1 : bytes=64 time<16ms TTL=64

Ping statistics for 10.1.2.1:

Packets: Sent = 4 , Received = 4 , Lost = 0 (0% loss)

Approximate round trip times in milli-seconds:

Minimum = 1ms , Maximum = 3ms , Average = 1ms

Part 21

Configuring DHCP Service

CHAPTERS

1. DHCP
2. DHCP Server Configuration
3. DHCP Relay Configuration
4. DHCP L2 Relay Configuration
5. Configuration Examples
6. Appendix: Default Parameters

1 DHCP

1.1 Overview

DHCP (Dynamic Host Configuration Protocol) is widely used to dynamically assign IP addresses and other parameters to clients in the LAN, enhancing the utilization of IP address.

1.2 Supported Features

The supported DHCP features of the switch include DHCP Server, DHCP Relay and DHCP L2 Relay.

DHCP Server

DHCP Server is used to dynamically assign IP addresses, default gateway and other parameters to DHCP clients. As the following figure shows, the switch acts as a DHCP server and assigns IP addresses to the clients.

Figure 1-1 Application Scenario of DHCP Server

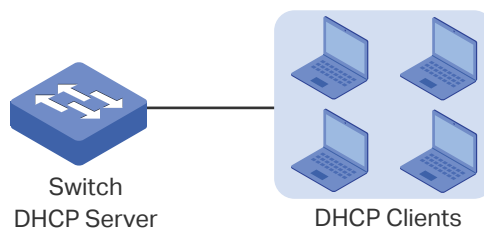

DHCP Relay

DHCP Relay is used to process and forward DHCP packets between different subnets or VLANs.

DHCP clients broadcast DHCP request packets to require for IP addresses. Without this function, clients cannot obtain IP addresses from a DHCP server in the different LAN because the broadcast packets can be transmitted only in the same LAN. To equip each LAN with a DHCP server can solve this problem, but the costs of network construction will be increased and the management of central network will become inconvenient.

A device with DHCP Relay function is a better choice. It acts as a relay agent and can forward DHCP packets between DHCP clients and DHCP servers in different LANs. Therefore, DHCP clients in different LANs can share one DHCP server.

DHCP Relay includes three features: Option 82, DHCP Interface Relay and DHCP VLAN Relay.

■ Option 82

Option 82 is called the DHCP Relay Agent Information Option. It provides additional security and a more flexible way to allocate network addresses compared with the traditional DHCP.

When enabled, the DHCP relay agent can inform the DHCP server of some specified information of clients by inserting an Option 82 payload to DHCP request packets before forwarding them to the DHCP server, so that the DHCP server can distribute the IP addresses or other parameters to clients based on the payload. In this way, Option 82 prevents DHCP client requests from untrusted sources. Besides, it allows the DHCP server to assign IP addresses of different address pools to clients in different groups.

An Option 82 has two sub-options, namely, the Agent Circuit ID and Agent Remote ID. The information that the two sub-options carry depends on the settings of the DHCP relay agent, and are different among devices from different vendors. To allocate network addresses using Option 82, you need to define the two sub-options on the DHCP relay agent, and create a DHCP class on the DHCP server to identify the Option 82 payload.

TP-Link switches preset a default circuit ID and remote ID in TLV (Type, Length, and Value) format. You can also configure the format to include Value only and customize the Value.

[Table 1-1](#) and [Table 1-2](#) show the packet formats of the Agent Circuit ID and Agent Remote ID, respectively.

Table 1-1 Packet Formats of the Agent Circuit ID with Different Option 82 Settings

Option 82 Settings		*Type (Hex)	*Length (Hex)	*Value
*Format	Circuit ID Customization			
Normal (TLV)	Disabled	00	04	Default circuit ID
	Enabled	01	Length of the customized circuit ID	Customized circuit ID
Private (Only the value)	Disabled	-	-	Default circuit ID
	Enabled	-	-	Customized circuit ID

Table 1-2 Packet Formats of the Agent Remote ID with Different Option 82 Settings

Option 82 Settings		*Type (Hex)	*Length (Hex)	*Value
*Format	Remote ID Customization			
Normal (TLV)	Disabled	00	06	Default remote ID
	Enabled	01	Length of the customized remote ID	Customized remote ID
Private (Only the value)	Disabled	-	-	Default remote ID
	Enabled	-	-	Customized remote ID

***Format**

Indicates the packet format of the sub-option field. Two options are available:

- Normal: Indicates the field consists of three parts: Type, Length, and Value (TLV).
- Private: Indicates the field consists of the value only.

***Type**

A one-byte field indicating whether the Value field is customized or not. **00** in hexadecimal means the Value field is not customized (uses the default circuit/remote ID) while **01** in hexadecimal means it is customized.

***Length**

A one-byte field indicating the length of the Value field. The length of the default circuit ID is 4 bytes and that of default remote ID is 6 bytes. For the customized circuit ID and remote ID, the length is variable, ranging from 1 to 64 bytes.

***Value**

Indicates the value of the sub-option. The switch has preset a default circuit ID and remoter ID. You can also customize them with Circuit ID Customization and Remote ID Customization enabled.

- Default circuit ID: A 4-byte value which consists of 2-byte VLAN ID and 2-byte Port ID. The VLAN ID indicates which VLAN the DHCP client belongs to, and the Port ID indicates which port the DHCP client is connected to.

For example, if the DHCP client is connected to port 1/0/1 in VLAN 2, this field is **00:02:00:01** in hexadecimal.

- Default remote ID: A 6-byte value which indicates the MAC address of the DHCP relay agent.
- Customized circuit/remote ID: You can configure a string using up to 64 characters. The switch encodes the string using ASCII. When configuring your DHCP server to identify the string, use the correct notation that is used by your DHCP server to represent ASCII strings, or convert it into hexadecimal format if necessary.

Tips:

As shown in [Table 1-1](#) and [Table 1-2](#), by default, the circuit ID records the ports of the DHCP relay agent that are connected to the clients and the VLANs that the clients belong to, and the remote ID records the MAC address of the DHCP relay agent. That is, the two sub-options together record the location of the clients. To record the accurate location of clients, configure Option 82 on the switch which is closest to the clients.

■ DHCP Interface Relay

DHCP Interface Relay allows clients to obtain IP addresses from a DHCP server in a different LAN. In DHCP Interface Relay, you can specify a DHCP server for the Layer 3 interface that the clients are connected to. When receiving DHCP packets from clients, the switch fills the corresponding interface's IP address in the Relay Agent IP Address field of the DHCP packets, and forwards the packets to the DHCP server. Then the DHCP server

can assign IP addresses that are in the same subnet with the Relay Agent IP Address to the clients.

The switch supports specifying a DHCP server for multiple Layer 3 interfaces, which makes it possible to assign IP addresses to clients in different subnets from the same DHCP server.

As the following figure shows, the IP address of VLAN 20 is 192.168.2.1/24 and that of the routed port Gi1/0/1 is 192.168.3.1/24. With DHCP Interface VLAN configured, the switch fills in the Relay Agent IP Address field of the DHCP packets with the IP address of VLAN 20 (192.168.2.1/24) when applying for IP addresses for clients in VLAN 20, and fills with the IP address of Gi1/0/1 (192.168.3.1/24) when applying for an IP address for PC 1. As a result, the DHCP server will assign IP addresses in Pool A (the same subnet with the IP address of VLAN 20) to clients in VLAN 20, and assign an IP address in Pool B (the same subnet with the Gi1/0/1) to PC 1.

Figure 1-2 Application Scenario of DHCP Interface Relay

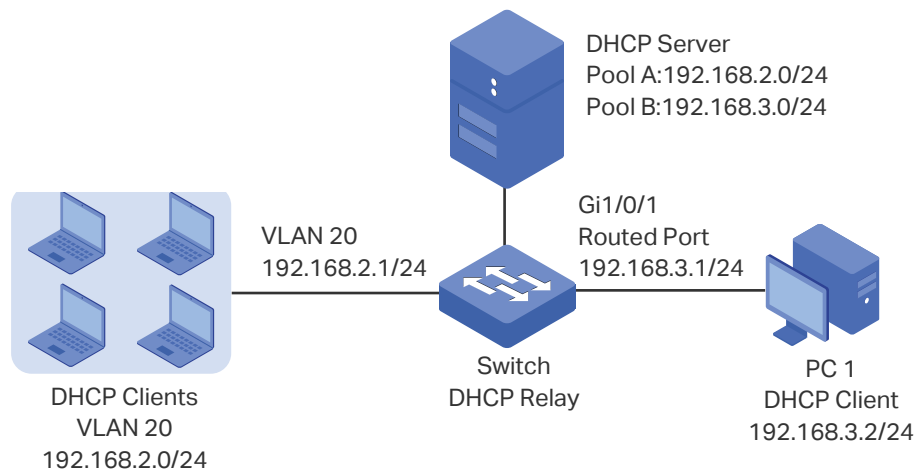

■ DHCP VLAN Relay

DHCP VLAN Relay allows clients in different VLANs to obtain IP addresses from the DHCP server using the IP address of a single agent interface.

In DHCP Interface Relay, to achieve this goal, you need to create a Layer 3 interface for each VLAN to ensure the reachability.

In DHCP VLAN Relay, you can simply specify a Layer 3 interface as the default agent interface for all VLANs. The switch fills this default agent interface's IP address in the Relay Agent IP Address field of the DHCP packets from all VLANs.

As the following figure shows, no IP addresses are assigned to VLAN 10 and VLAN 20, but a default relay agent interface is configured with the IP address 192.168.2.1/24. The switch fills in the Relay Agent IP Address field of the DHCP packets with the IP address of the default agent interface (192.168.2.1/24) when applying for IP addresses for clients in both VLAN 10 and VLAN 20. As a result, the DHCP server will assign IP addresses on 192.168.2.0/24 (the same subnet with the IP address of the default agent interface) to clients in both VLAN 10 and VLAN 20.

Figure 1-3 Application Scenario of DHCP VLAN Relay

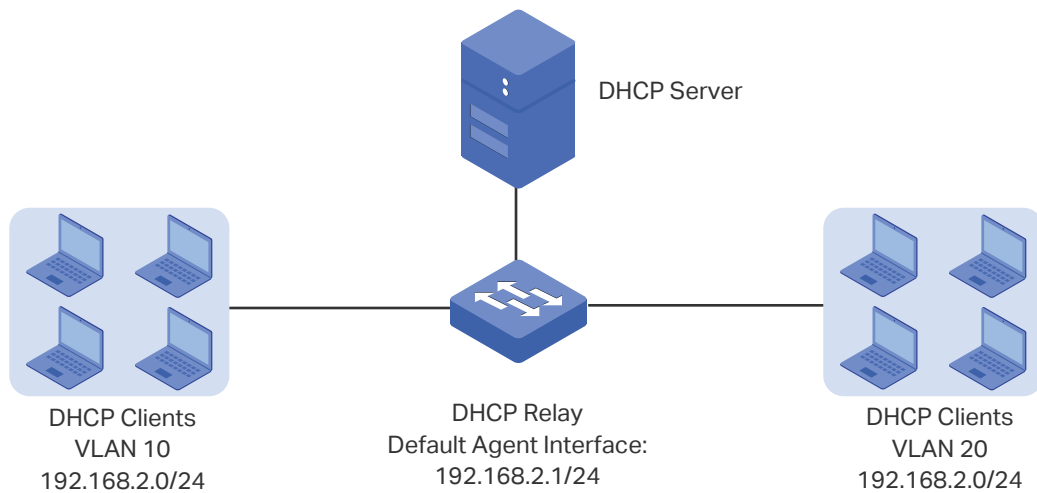

Note:

- If the VLAN already has an IP address, the switch will use the IP address of the VLAN as the relay agent IP address. The default relay agent IP address will not take effect.
- DHCP VLAN Relay will not work on routed ports or port channel interfaces, because they are not associated with any particular VLAN.

DHCP L2 Relay

Unlike DHCP relay, DHCP L2 Relay is used in the situation that the DHCP server and clients are in the same VLAN. In DHCP L2 Relay, in addition to normally assigning IP addresses to clients from the DHCP server, the switch can inform the DHCP server of some specified information, such as the location information, of clients by inserting an Option 82 payload to DHCP request packets before forwarding them to the DHCP server. This allows the DHCP server which supports Option 82 can set the distribution policy of IP addresses and other parameters, providing a more flexible way to distribute IP addresses.

Figure 1-4 Application Scenario of DHCP L2 Relay

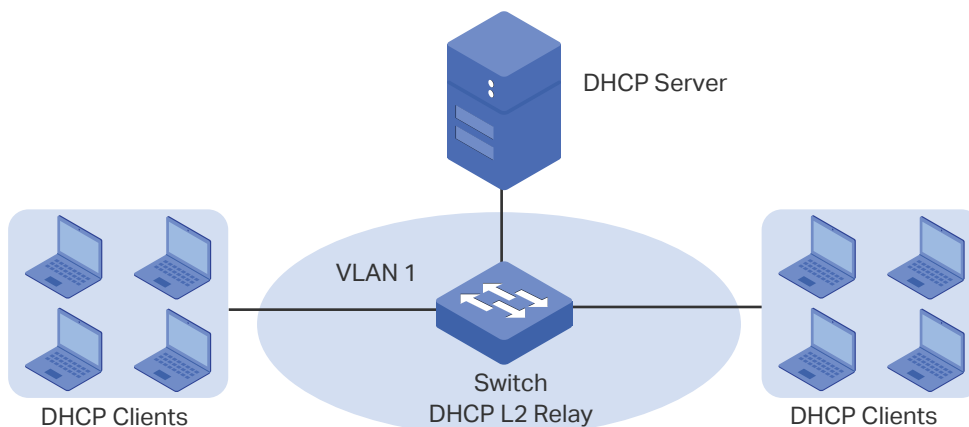

2 DHCP Server Configuration

To complete DHCP server configuration, follow these steps:

- 1) Enable DHCP Server globally on the switch.
- 2) Configure DHCP Server Pool.
- 3) (Optional) Manually assign static IP addresses for some clients.

2.1 Using the GUI

2.1.1 Enabling DHCP Server

Choose the menu **L3 FEATURES > DHCP Service > DHCP Server > DHCP Server** to load the following page.

Figure 2-1 Configure DHCP Server

The screenshot shows the DHCP Server configuration page. At the top, there are five tabs: "DHCP Server" (selected), "Pool Setting", "Manual Binding", "DHCP Client List", and "Packet Statistics". Below the tabs, the page is divided into three main sections:

- Global Config:** Contains a "DHCP Server" checkbox (unchecked) with an "Enable" label. Below it are two input fields: "Option 60" (with a note "(Optional. 1-64 characters)") and "Option 138" (with a note "(Optional. Format: 192.168.0.1)"). An "Apply" button is on the right.
- Ping Time Config:** Contains two input fields: "Ping Packets" (with value "1" and note "(0-10 packets, 0 for disabling ping)") and "Ping Timeout" (with value "100" and note "(100-10000 milliseconds)"). An "Apply" button is on the right.
- Excluded IP Address Config:** Features a table with columns "Index", "Starting IP Address", and "Ending IP Address". The table is currently empty, showing "No entries in this table." and "Total: 0". There are "+ Add" and "- Delete" buttons to the right of the table.

Follow these steps to configure DHCP Server:

- 1) In the **Global Config** section, enable DHCP Server. Click **Apply**.

DHCP Server	Enable or disable DHCP Server. By default, it is disabled.
-------------	--

Option 60 (Optional) Configure Option 60 for device identification. Mostly it is used under the scenario where the APs (Access Points) apply for different IP addresses from different servers according to their needs.

If an AP requests option 60, the server will respond by sending a packet containing the Option 60 configured here. The AP will compare the received Option 60 with its own. If they are the same, the AP will accept the IP address assigned by the server, otherwise the assigned IP address will not be accepted.

Option 138 (Optional) Specify Option 138, which can be configured as the management IP address of an AC (Access Control) device. If the APs in the local network request this option, the server will respond by sending a packet containing this option to inform the APs of the AC's IP address.

- 2) In the **Ping Time Config** section, configure Ping Packets and Ping Timeout for ping tests. Click **Apply**.

Ping Packets Specify the number of ping packets the server can broadcast to test whether the IP address is occupied. The valid values are from 1 to 10, and the default is 1.

When the switch is configured as a DHCP server to dynamically assign IP addresses to clients, the switch will ping test to avoid IP address conflict resulting from assigning IP addresses repeatedly.

Ping Timeout Specify the ping timeout period in milliseconds. It ranges from 100 to 10000 ms and the default is 100 ms.

The DHCP server broadcasts an ICMP Echo Request (ping packet) to test whether an IP address is occupied or not. If there is no response within the ping timeout period, the server will broadcast the ping packet again. If the number of ping packets reaches the specified number and there is still no response, the server will assign the IP address. Otherwise, the server will record the IP address as a conflicted IP address and assign another IP address to the client.

- 3) In the **Excluded IP Address Config** section, click **+ Add** to load the following page to specify the IP addresses that should not be assigned to the clients.

Figure 2-2 Configure Excluded IP Address

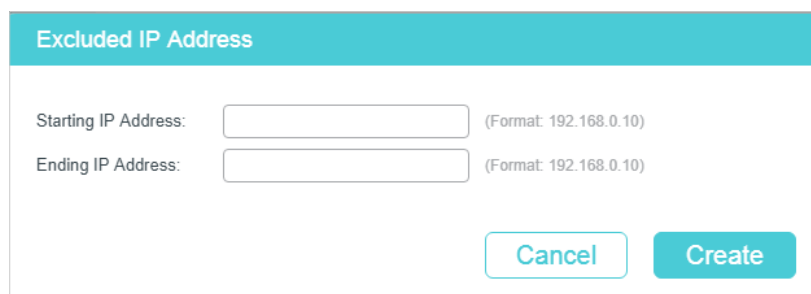

Enter the Starting IP Address and Ending IP Address to specify the range of reserved IP addresses. Click **Create**.

Starting IP Address/ Ending IP Address Specify the starting IP address and ending IP address of the excluded IP address range. If the starting IP address and the ending IP address are the same, the server excludes only one IP address.

When configuring DHCP Server, you need to reserve certain IP addresses for each subnet, such as default gateway address, broadcast address and DNS server address



2.1.2 Configuring DHCP Server Pool

DHCP Server Pool defines the parameters that will be assigned to DHCP clients.

Choose the menu **L3 FEATURES > DHCP Service > DHCP Server > Pool Setting** and click  **Add** to load the following page.

Figure 2-3 Pool Setting

DHCP Server Pool

Pool Name:	<input type="text"/>	(8 characters maximum)
Network Address:	<input type="text"/>	(Format: 192.168.0.0)
Subnet Mask:	<input type="text"/>	(Format: 255.255.255.0)
Lease Time:	<input type="text"/>	(Optional. 1-2880 min, Default: 120)
 Default Gateway:	<input type="text"/>	(Optional. Format: 192.168.0.1)
 DNS Server:	<input type="text"/>	(Optional. Format: 192.168.0.1)
 NetBIOS Server:	<input type="text"/>	(Optional. Format: 192.168.0.1)
NetBIOS Node Type:	<input style="border-bottom: 1px solid #ccc;" type="text"/>	(Optional, b/p/m/h/none)
Next Server Address:	<input type="text"/>	(Optional. Format: 192.168.0.1)
Domain Name:	<input type="text"/>	(0 to 200 characters)
Bootfile:	<input type="text"/>	(0 to 128 characters)

Configure the parameters for DHCP Server Pool. Then click **Create**.

Pool Name	Specify a name for the pool.
Network Address / Subnet Mask	Configure the network address and subnet mask of the IP pool. The network address and subnet mask decide the range of the pool. In the same subnet, all the addresses can be assigned except the excluded addresses.
Lease Time	Specify how long the client can use the assigned IP address. The value ranges from 1 to 2880 minutes and the default value is 120 minutes.

Default Gateway	<p>Configure the default gateway of the DHCP server pool. You can create up to 8 default gateways for each DHCP server pool.</p> <p>Generally, you can configure the IP address of the VLAN interface as the default gateway address.</p>
DNS Server	<p>Specify the DNS server of the DHCP server pool. You can specify up to 8 DNS servers for each DHCP server pool.</p> <p>Generally, you can configure the IP address of the VLAN interface as the DNS server address.</p>
NetBIOS Server	<p>Specify the NetBIOS name server. You can specify up to 8 NetBIOS servers for each DHCP server pool.</p> <p>When a DHCP client uses the Network NetBIOS (Basic Input Output System) protocol for communication, the host name must be mapped to IP address. NetBIOS name server can resolve host names to IP addresses.</p>
NetBIOS Node Type	<p>Specify the Netbios type for the clients, which is the way of inquiring IP address resolution. The following options are provided:</p> <p>b-node Broadcast: The client sends query message via broadcast.</p> <p>p-node Peer-to-Peer: The client sends query message via unicast.</p> <p>m-node Mixed: The client sends query message via broadcast first. If it fails, the client will try again via unicast.</p> <p>h-node Hybrid: The client sends query message via unicast first. If it fails, the client will try again via broadcast.</p>
Next Server Address	<p>Specify the IP address of a TFTP server for the clients. If needed, the clients can get the configuration file from the TFTP server for auto installation.</p>
Domain Name	<p>Specify the domain name that the clients should use when resolving host names via DNS.</p>
Bootfile	<p>Specify the name of the bootfile. If needed, the clients can get the bootfile from the TFTP server for auto installation.</p>

2.1.3 Configuring Manual Binding

Some devices like web servers require static IP addresses. To meet this requirement, you can bind an IP address in the pool with a specified client. The server will then assign the bound IP address to the client on receiving the client's request.

Choose the menu **L3 FEATURES > DHCP Service > DHCP Server > Manual Binding** and click **+ Add** to load the following page.

Figure 2-4 Manual Binding

Select a pool name and enter the IP address to be bound. Select a binding mode and finish the configuration accordingly. Click **Create**.

Pool Name	Select an IP pool from the drop-down box.
IP Address	Enter the IP address to be bound to the client.
Binding Mode	Select a binding mode: Client ID: Bind the IP address to the client ID. Client ID in ASCII: Bind the IP address to the client ID in ASCII format. Hardware Address: Bind the IP address to the MAC address of the client.
Client ID	If you select Client ID or Client ID in ASCII as the binding mode, enter the client ID in this field.
Hardware Address	If you select Hardware Address as the binding mode, enter the MAC address in this field.
Hardware Type	If you select Hardware Address as the binding mode, select a hardware type. The hardware type includes Ethernet and IEEE 802.

2.2 Using the CLI

2.2.1 Enabling DHCP Server

Follow these steps to enable DHCP Server and to configure ping packets and ping timeout.

Step 1	configure Enter Global Configuration Mode.
--------	--

Step 2	service dhcp server Enable DHCP Server.
Step 3	ip dhcp server extend-option vendor-class-id vendor (Optional) Specify the Option 60 for server identification. If a client requests Option 60, the server will respond a packet containing the Option 60 configured here. And then the client will compare the received Option 60 with its own. If they are the same, the client will accept the IP address assigned by the server. Otherwise, the assigned IP address will not be accepted. <i>vendor</i> : Specify the Option 60 with 1 to 64 characters.
Step 4	ip dhcp server extend-option capwap-ac-ip ip-address (Optional) Specify the Option 138, which should be configured as the management IP address of an AC (Access Control) device. If the APs (Access Points) in the local network request this option, the server will respond a packet containing this option to inform the APs of the AC's IP address. <i>ip-address</i> : Specify the IP address of the AC device that controls the APs.
Step 5	ip dhcp server ping timeout value Specify the timeout period for ping tests. The DHCP server broadcasts an ICMP Echo Request (ping packet) to test whether an IP address is occupied or not. If there is no response within the timeout period, the server will broadcast the ping packet again. If the number of ping packets reaches the specified number without response, the server will assign the IP address. Otherwise, the server will record the IP address as a conflicted IP address and assign another IP address to the client. <i>value</i> : Specify the timeout period for ping tests in milliseconds. It ranges from 100 to 10000 ms, and the default is 100 ms.
Step 6	ip dhcp server ping packets num Specify the number of ping packets the server can broadcast to test whether the IP address is occupied. When the switch is configured as a DHCP server to dynamically assign IP addresses to clients, the switch will deploy ping tests to avoid IP address conflicts resulted from assigning IP addresses repeatedly. <i>num</i> : Enter the number of ping packets. The valid values are from 1 to 10, and the default is 1.
Step 7	ip dhcp server exclude-address start-ip-address end-ip-address Specify the starting IP address and ending IP address of the excluded IP address range. If the starting IP address and the ending IP address are the same, the server excludes only one IP address. When configuring DHCP Server, you need to reserve certain IP addresses for each subnet, such as default gateway address, broadcast address and DNS server address. <i>start-ip-address/end-ip-address</i> : Specify the starting IP address and ending IP address.
Step 8	show ip dhcp server status Verify the DHCP status, including whether it is enabled and the configuration of ping packet number and ping packet timeout.

Step 9	show ip dhcp server extend-option Verify the configuration of the extended options.
Step 10	show ip dhcp server excluded-address Verify the configuration of the excluded IP address.
Step 11	end Return to Privileged EXEC Mode.
Step 12	copy running-config startup-config Save the settings in the configuration file.

The following example shows how to enable DHCP Server globally on the switch, configure the number of ping packets as **2** and configure the timeout period for ping tests as **200** ms:

Switch#configure

Switch(config)#service dhcp server

Switch(config)#ip dhcp server ping packets 2

Switch(config)#ip dhcp server ping timeout 200

Switch(config)#show ip dhcp server status

DHCP server is enable.

Ping packet number: 2.

Ping packet timeout: 200 milliseconds.

Switch(config)#end

Switch#copy running-config startup-config

The following example shows how to configure the Option 60 as **abc** and Option 138 as **192.168.0.155**:

Switch#configure

Switch(config)#ip dhcp server extend-option vendor-class-id abc

Switch(config)#ip dhcp server extend-option capwap-ac-ip 192.168.0.155

Switch(config)#show ip dhcp server extend-option

Option 60: abc

Option 138: 192.168.0.155

Switch(config)#end

Switch#copy running-config startup-config

The following example shows how to configure the 192.168.1.1 as the default gateway address and excluded IP address:

Switch#configure

Switch(config)#ip dhcp server excluded-address 192.168.1.1 192.168.1.1

Switch(config)#show ip dhcp server excluded-address

No.	Start IP Address	End IP Address
---	-----	-----
1	192.168.1.1	192.168.1.1

Switch(config)#end

Switch#copy running-config startup-config

2.2.2 Configuring DHCP Server Pool

Follow these steps to configure DHCP server pool:

Step 1	configure Enter Global Configuration Mode.
Step 2	ip dhcp server pool <i>pool-name</i> Configure a name for the DHCP server pool for identification. <i>pool-name</i> : Specify a pool name with 1 to 8 characters.
Step 3	network <i>network-address subnet-mask</i> Configure the network address and subnet mask of the DHCP server pool. The network address and subnet mask decide the range of the DHCP server pool. On the same subnet, all addresses can be assigned except the excluded addresses and addresses for special uses. <i>network-address</i> : Configure the network address of the DHCP server pool. <i>subnet-mask</i> : Configure the subnet mask of the DHCP server pool.
Step 4	lease <i>lease-time</i> Specify how long the client can use the IP address assigned from this address pool. <i>lease-time</i> : Enter the value of lease-time. It ranges from 1 to 2880 minutes, and the default is 120 minutes.
Step 5	default-gateway <i>gateway-list</i> (Optional) Configure the default gateway of the DHCP server pool. In general, you can configure the IP address of the VLAN interface as the default gateway address. <i>gateway-list</i> : Specify the IP address of the default gateway. You can create up to 8 default gateways for each DHCP server pool.

Step 6	dns-server <i>dns-server-list</i> (Optional) Specify the DNS server of the DHCP server pool. In general, you can configure the IP address of the VLAN interface as the DNS server address. <i>dns-server-list</i> : Specify the IP address of the DNS server. You can specify up to 8 DNS servers for each DHCP server pool.
Step 7	netbios-name-server <i>NBNS-list</i> (Optional) Specify the NetBIOS name server. You can specify up to 8 NetBIOS servers for each DHCP server pool. When a DHCP client uses the Network NetBIOS (Basic Input Output System) protocol for communication, the host name must be mapped to IP address. NetBIOS name server can resolve host names to IP addresses. <i>NBNS-list</i> : Specify the IP address of the NetBIOS server. You can specify up to 8 NetBIOS servers for each DHCP server pool.
Step 8	netbios-node-type <i>type</i> (Optional) Specify the NetBIOS type for the clients, which is the way of inquiring IP address resolution. <i>type</i> : Specify the NetBIOS type. The following options are provided: b-node : The client sends query messages via broadcast. p-node : The client sends query messages via unicast. m-node : The client sends query messages via broadcast first. If it fails, the client will try again via unicast. h-node : The client sends query messages via unicast first. If it fails, the client will try again via broadcast.
Step 9	next-server <i>ip-address</i> (Optional) Specify the IP address of a TFTP server for the clients. If needed, the clients can get the configuration file from the TFTP server for auto installation. <i>ip-address</i> : Specify the IP address of the TFTP server.
Step 10	domain-name <i>domainname</i> (Optional) Specify the domain name that the clients should use when resolving host names via DNS. <i>domainname</i> : Specify the domain name with up to 200 characters.
Step 11	bootfile <i>file-name</i> (Optional) Specify the name of the bootfile. If needed, the clients can get the bootfile from the TFTP server for auto installation. <i>file-name</i> : Specify the bootfile name with up to 128 characters.
Step 12	show ip dhcp server pool Verify the configuration of the DHCP server pool.
Step 13	end Return to Privileged EXEC Mode.

Step 14 **copy running-config startup-config**
Save the settings in the configuration file.

The following example shows how to create a DHCP server pool with the parameters shown in [Table 2-1](#).

Table 2-1 Parameters for the DHCP Server Pool

Parameter	Value
Pool Name	pool 1
Network Address	192.168.1.0
Subnet Mask	255.255.255.0
Lease Time	180 minutes
Default Gateway	192.168.1.1
DNS Server	192.168.1.4
NetBIOS Server	192.168.1.19
NetBIOS Node Type	B-node (Broadcast)
TFTP server	192.168.1.30
Domain Name	com
Bootfile	bootfile

Switch#configure

```
Switch(config)#ip dhcp server pool pool1
```

```
Switch(dhcp-config)#network 192.168.1.0 255.255.255.0
```

```
Switch(dhcp-config)#lease 180
```

```
Switch(dhcp-config)#default-gateway 192.168.1.1
```

```
Switch(dhcp-config)#dns-server 192.168.1.4
```

```
Switch(dhcp-config)#netbios-name-server 192.168.1.19
```

```
Switch(dhcp-config)#netbios-node-type b-node
```

```
Switch(dhcp-config)#next server 192.168.1.30
```

```
Switch(dhcp-config)#domain-name com
```

```
Switch(dhcp-config)#bootfile bootfile
```

Switch(dhcp-config)#show ip dhcp server pool

Pool Name: pool1
Network Address: 192.168.1.0
Subnet Mask: 255.255.255.0
Lease Time: 180
Default Gateway: 192.168.1.1
DNS Server: 192.168.1.4
Netbios Server: 192.168.1.19
Netbios Node Type: b-node
Next Server Address: 192.168.1.30
Domain Name: com
Bootfile Name: bootfile

Switch(dhcp-config)#end**Switch#copy running-config startup-config**

2.2.3 Configuring Manual Binding

Some hosts, WWW server for example, requires a static IP address. To satisfy this requirement, you can manually bind the MAC address or client ID of the host to an IP address, and the DHCP server will reserve the bound IP address to this host at all times.

Follow these steps to configure Manual Binding:

Step 1 `configure`

Enter Global Configuration Mode.

Step 2 `ip dhcp server pool name`

Create a DHCP server pool and enter DHCP Configuration Mode.

Step 3 Bind an IP address to a client:

address *ip-address* **client-identifier** *client-id*

Bind the specified IP address to the client with a specific hexadecimal client ID.

ip-address: Specify the IP address to be bound.

client-id: Specify the client ID in hexadecimal format.

address *ip-address* **client-identifier** *client-id* **ascii**

Bind the specified IP address to the client with a specific ASCII client ID.

ip-address: Specify the IP address to be bound.

client-id: Specify the client ID with ASCII characters.

address *ip-address* **hardware-address** *hardware-address* **hardware-type** { ethernet | ieee802 }

Bind the specified IP address to the client with a specific MAC address.

ip-address: Specify the IP address to be bound.

hardware-address: Enter the MAC address of the client.

ethernet | ieee802: Specify a hardware type for the client, either Ethernet or IEEE802.

Step 4 **show ip dhcp server manual-binding**

Verify the manual binding configuration.

Step 5 **end**

Return to Privileged EXEC Mode.

Step 6 **copy running-config startup-config**

Save the settings in the configuration file.

The following example shows how to bind the IP address 192.168.1.33 in pool1 (on the subnet of 192.168.1.0) to the host with the MAC address 74:D4:68:22:3F:34:

Switch#configure

Switch(config)#ip dhcp server pool pool1

Switch(dhcp-config)#address 192.168.1.33 hardware-address 74:d4:68:22:3f:34 hardware-type ethernet

Switch(dhcp-config)#show ip dhcp server manual-binding

Pool Name	Client Id/Hardware Address	IP Address	Hardware Type	Bind Mode
-----	-----	-----	-----	-----
pool1	74:d4:68:22:3f:34	192.168.1.33	Ethernet	MAC Address

```
Switch(dhcp-config)#end
```

```
Switch#copy running-config startup-config
```

3 DHCP Relay Configuration

To complete DHCP Relay configuration, follow these steps:

- 1) Enable DHCP Relay. Configure Option 82 if needed.
- 2) Specify DHCP server for the Interface or VLAN.

3.1 Using the GUI

3.1.1 Enabling DHCP Relay and Configuring Option 82

Choose the menu **L3 FEATURES > DHCP Service > DHCP Relay > DHCP Relay Config** to load the following page.

Figure 3-1 Enable DHCP Relay and Configure Option 82

Global Config

DHCP Relay: Enable

DHCP Relay Hops: (1-16)

DHCP Relay Time Threshold: seconds (0-65535)

Apply

Option 82 Config

UNIT1

LAGS

<input type="checkbox"/>	Port	Option 82 Support	Option 82 Policy	Format	Circuit ID Customization	Circuit ID	Remote ID Customization	Remote ID	LAG
<input type="checkbox"/>	1/0/1	Disabled	Keep	Normal	Disabled		Disabled		---
<input type="checkbox"/>	1/0/2	Disabled	Keep	Normal	Disabled		Disabled		---
<input type="checkbox"/>	1/0/3	Disabled	Keep	Normal	Disabled		Disabled		---
<input type="checkbox"/>	1/0/4	Disabled	Keep	Normal	Disabled		Disabled		---
<input type="checkbox"/>	1/0/5	Disabled	Keep	Normal	Disabled		Disabled		---
<input type="checkbox"/>	1/0/6	Disabled	Keep	Normal	Disabled		Disabled		---
<input type="checkbox"/>	1/0/7	Disabled	Keep	Normal	Disabled		Disabled		---
<input type="checkbox"/>	1/0/8	Disabled	Keep	Normal	Disabled		Disabled		---
<input type="checkbox"/>	1/0/9	Disabled	Keep	Normal	Disabled		Disabled		---
<input type="checkbox"/>	1/0/10	Disabled	Keep	Normal	Disabled		Disabled		---

Total: 54

Follow these steps to enable DHCP Relay and configure Option 82:

- 1) In the **Global Config** section, enable DHCP Relay globally and configure the relay hops and time threshold. Click **Apply**.

DHCP Relay	Enable or disable DHCP relay globally.
DHCP Relay Hops	Specify the DHCP relay hops. The value ranges from 1 to 16, and the default value is 4. DHCP Relay Hops defines the maximum number of hops (DHCP Relay agent) that the DHCP packets can be relayed. If a packet's hop count is more than the value you set here, the packet will be dropped.
DHCP Relay Time Threshold	Specify the DHCP relay time threshold. The value ranges from 0 to 65535 seconds. DHCP relay time is the time elapsed since client began address acquisition or renewal process. When the time is greater than the value set here, the DHCP packet will be dropped by the switch. Value 0 means the switch will not examine this field of the DHCP packets.

2) (Optional) In the **Option 82 Config** section, configure Option 82.

Option 82 Support	Enable or disable the Option 82 feature for the port. Enable it if you want to prevent DHCP client requests from untrusted sources, or assign different IP addresses to clients in different groups from the same DHCP server.
Option 82 Policy	Select the operation for the Option 82 field of the DHCP request packets. Keep: The switch will not change the Option 82 field of the packets. Replace: The switch will replace the Option 82 field of the packets with the manually defined content. By default, the Circuit ID is filled with the VLAN ID and the the port number which receives the DHCP Request packets. The Remote ID is filled with the MAC address of the switch which receives the DHCP Request packets. Drop: Indicates discarding the packets that include the Option 82 field.
Format	Select the format of option 82 sub-option value field. Normal: The format of sub-option value field is TLV (type-length-value). Private: The format of sub-option value field is just value.
Circuit ID Customization	Enable or disable the switch to define the Option 82 sub-option Circuit ID field. If it is enabled, you can manually configure the circuit ID; if it is disabled, the switch will automatically configure the VLAN ID and the port number of the port that received the DHCP packets as the circuit ID.
Circuit ID	With Circuit ID Customization enabled, you can manually configure the circuit ID here.
Remote ID Customization	Enable or disable the switch to define the Option 82 sub-option Remote ID field. If it is enabled, you can manually configure the remote ID; if it is disabled, the switch will automatically configure the switch's MAC address as the remote ID.

Remote ID	With Remote ID Customization enabled, you can manually configure the remote ID here.
------------------	---

3) Click **Apply**.

3.1.2 Configuring DHCP Interface Relay

DHCP Interface Relay allows clients to obtain IP addresses from a DHCP server in a different subnet.

Choose the menu **L3 FEATURES > DHCP Service > DHCP Relay > DHCP Interface Relay** and click **+ Add** to load the following page.

Figure 3-2 Configuring DHCP Interface Relay

Select the interface type and enter the interface ID, then enter the IP address of the DHCP server. Click **Create**.

Interface ID	Select the L3 interface, which is the interface that the clients are connected to. VLAN: Enter the VLAN ID to specify the VLAN interface. Routed Port: Enter the port number or click the port icon to specify the routed port. Port Channel: Enter the port channel ID to specify the port channel.
Server Address	Enter the IP address of the DHCP server.

3.1.3 Configuring DHCP VLAN Relay

DHCP VLAN Relay allows clients in different VLANs to obtain IP addresses from a DHCP server using the IP address of a single agent interface. It is often used when the relay switch does not support configuring multiple Layer 3 interfaces.

Choose the menu **L3 FEATURES > DHCP Service > DHCP Relay > DHCP VLAN Relay** to load the following page.

Figure 3-3 Configure DHCP VLAN Relay

Follow these steps to specify DHCP Server for the specific VLAN:

- 1) In the **Default Relay Agent Interface** section, specify a Layer 3 interface as the default relay agent interface. Then click **Apply**.

Interface ID	Select a L3 interface as the default relay agent interface. VLAN: Enter the VLAN ID to specify the VLAN interface. Routed Port: Enter the port number or click the port icon to specify the routed port. Port Channel: Enter the port channel ID to specify the port channel.
IP Address	Displays the IP address of the interface.



Note:

- If the VLAN the clients belong to already has an IP address, the switch will use the client's own VLAN interface as the relay-agent interface. The manually specified default relay agent will not take effect.
- DHCP VLAN Relay will not work on routed ports or port channel interfaces, because they are not associated with any particular VLAN.

- 2) In the **DHCP VLAN Relay Config** section, click **+ Add** to load the configuration page.

Figure 3-4 Specify a DHCP server for the VLAN

Specify the VLAN the clients belong to and the server address. Click **Create**.

VLAN ID	Specify the VLAN, in which the hosts can get IP addresses from the DHCP server.
Server Address	Enter the IP address of the DHCP server.

3.2 Using the CLI

3.2.1 Enabling DHCP Relay

Follow these steps to enable DHCP Relay and configure the corresponding parameters:

Step 1	configure Enter Global Configuration Mode.
Step 2	service dhcp relay Enable DHCP Relay.
Step 3	ip dhcp relay hops hops Specify the maximum hops (DHCP relay agent) that the DHCP packets can be relayed. If a packet's hop count is more than the value you set here, the packet will be dropped. <i>hops</i> : Specify the maximum hops for DHCP packets. Valid values are from the 1 to 16, and the default value is 4.
Step 4	ip dhcp relay time time Specify the threshold for the DHCP relay time. DHCP relay time is the time elapsed since the client began address acquisition or renewal process. There is a field in DHCP packets which specially records this time, and the switch will drop the packets if the value of this field is greater than the threshold. Value 0 means the switch will not examine this field of the DHCP packets. <i>time</i> : Specify the threshold for the DHCP relay time. Valid values are from 1 to 65535. By default, the value is 0, which means the switch will not examine this field of the DHCP packets.
Step 5	show ip dhcp relay Verify the configuration of DHCP Relay.
Step 6	end Return to Privileged EXEC Mode.
Step 7	copy running-config startup-config Save the settings in the configuration file.

The following example shows how to enable DHCP Relay, configure the relay hops as 5 and configure the relay time as 10 seconds :

Switch#configure

```
Switch(config)#service dhcp relay
```

```
Switch(config)#show ip dhcp relay
```

```
Switch(config)#ip dhcp relay hops 5
```

```
Switch(config)#ip dhcp relay time 10
```

```
DHCP relay state: enabled
```

```
DHCP relay hops: 5
```

```
DHCP relay Time Threshold: 10 seconds
```

```
...
```

```
Switch(config)#end
```

```
Switch#copy running-config startup-config
```

3.2.2 (Optional) Configuring Option 82

Follow these steps to configure Option 82:

Step 1	configure Enter Global Configuration Mode.
Step 2	interface { fastEthernet port range fastEthernet port-list gigabitEthernet port range gigabitEthernet port-list ten-gigabitEthernet port range ten-gigabitEthernet port-list } Enter Interface Configuration Mode.
Step 3	ip dhcp relay information option Enable the Option 82 feature on the port.
Step 4	ip dhcp relay information strategy { keep replace drop } Specify the operation for the switch to take when receiving DHCP packets that include the Option 82 field. keep: The switch keeps the Option 82 field of the packets. replace: The switch replaces the Option 82 field of the packets with a new one. The switch presets a default circuit ID and remote ID in TLV (Type, Length, and Value) format. You can also configure the format to include Value only and customize the Value. drop: The switch discards the packets that include the Option 82 field.
Step 5	ip dhcp relay information format { normal private } Specify the packet format for the sub-option fields of Option 82. normal: Indicates the fields consist of three parts: Type, Length, and Value (TLV). private: Indicates the fields consist of the value only.

-
- Step 6 **ip dhcp relay information circuit-id string**
- (Optional) A default circuit ID is preset on the switch, and you can also run this command to customize the circuit ID. The circuit ID configurations of the switch and the DHCP server should be compatible with each other.
- The default circuit ID is a 4-byte value which consists of 2-byte VLAN ID and 2-byte Port ID. The VLAN ID indicates which VLAN the DHCP client belongs to, and the Port ID indicates which port the DHCP client is connected to. For example, if the DHCP client is connected to port 1/0/1 in VLAN 2, this field is **00:02:00:01** in hexadecimal.
- string*: Enter the customized circuit ID with up to 64 characters.
-
- Step 7 **ip dhcp relay information remote-id string**
- (Optional) The switch uses its own MAC address as the default remote ID, and you can also run this command to customize the remote ID. The remote ID configurations of the switch and the DHCP server should be compatible with each other.
- string*: Enter the remote ID with up to 64 characters.
-
- Step 8 **show ip dhcp relay information interface { fastEthernet port | gigabitEthernet port | ten-gigabitEthernet port | port-channel port-channel-id }**
- Verify the Option 82 configurations of the port.
-
- Step 9 **end**
- Return to Privileged EXEC Mode.
-
- Step 10 **copy running-config startup-config**
- Save the settings in the configuration file.
-

The following example shows how to enable Option 82 on port 1/0/7 and configure the strategy as replace, the format as normal, the circuit-id as VLAN20 and the remote-id as Host1:

Switch#configure

Switch(config)#interface gigabitEthernet 1/0/7

Switch(config-if)#ip dhcp relay information option

Switch(config-if)#ip dhcp relay information strategy replace

Switch(config-if)#ip dhcp relay information format normal

Switch(config-if)#ip dhcp relay information circuit-id VLAN20

Switch(config-if)#ip dhcp relay information remote-id Host1

Switch(config-if)#show ip dhcp relay information interface gigabitEthernet 1/0/7

Interface	Option 82 Status	Operation Strategy	Format	Circuit ID	Remote ID	LAG
-----	-----	-----	-----	-----	-----	-----
Gi1/0/7	Enable	Replace	Normal	VLAN20	Host1	N/A

Switch(config-if)#end

Switch#copy running-config startup-config

3.2.3 Configuring DHCP Interface Relay

You can specify a DHCP server for a Layer 3 interface or for a VLAN. The following introduces how to configure DHCP Interface Relay and DHCP VLAN Relay, respectively.

Follow these steps to DHCP Interface Relay:

Step 1	<p>configure</p> <p>Enter Global Configuration Mode.</p>
Step 2	<p>Enter Layer 3 Interface Configuration Mode:</p> <p>Enter VLAN Interface Configuration Mode:</p> <p>interface vlan <i>vlan-id</i> <i>vlan-id</i>: Specify an IEEE 802.1Q VLAN ID that already exists, ranging from 1 to 4094.</p> <p>Enter Routed Port Configuration Mode:</p> <p>interface { fastEthernet <i>port</i> gigabitEthernet <i>port</i> ten-gigabitEthernet <i>port</i> }</p> <p>Enter Interface Configuration Mode.</p> <p><i>port</i>: Specify the Ethernet port number, for example, 1/0/1.</p> <p>no switchport</p> <p>Switch the Layer 2 port into the Layer 3 routed port.</p> <p>Enter Port-channel Interface Configuration Mode:</p> <p>interface { port-cahnnel <i>port-channel</i> }</p> <p>Enter Interface Configuration Mode.</p> <p><i>port-channel</i>: Specify the port channel. Valid values are from 1 to 14.</p> <p>no switchport</p> <p>Switch the port channel to a Layer 3 port channel interface.</p>
Step 3	<p>ip helper-address <i>ip-addr</i></p> <p>Specify DHCP server for the Layer 3 interface.</p> <p><i>ip-addr</i>: Enter the IP address of the DHCP server.</p>
Step 4	<p>show ip dhcp relay</p> <p>Verify the configuration of DHCP Relay.</p>
Step 5	<p>end</p> <p>Return to Privileged EXEC Mode.</p>
Step 6	<p>copy running-config startup-config</p> <p>Save the settings in the configuration file.</p>

The following example shows how to configure the DHCP server address as 192.168.1.7 on VLAN interface 66:

```
Switch#configure
```

```
Switch(config)#interface vlan 66
```

```
Switch(config-if)#ip helper-address 192.168.1.7
```

```
Switch(config-if)#show ip dhcp relay
```

...

DHCP relay helper address is configured on the following interfaces:

Interface	Helper address
-----	-----
VLAN 66	192.168.1.7

```
Switch(config-if)#end
```

```
Switch#copy running-config startup-config
```

3.2.4 Configuring DHCP VLAN Relay

Follow these steps to configure DHCP VLAN Relay:

Step 1	configure
	Enter Global Configuration Mode.

Step 2	<p>Enter Layer 3 Interface Configuration Mode:</p> <p>Enter VLAN Interface Configuration Mode:</p> <p>interface vlan <i>vlan-id</i> <i>vlan-id</i>: Specify an IEEE 802.1Q VLAN ID that already exists, ranging from 1 to 4094.</p> <p>Enter Routed Port Configuration Mode:</p> <p>interface { fastEthernet <i>port</i> gigabitEthernet <i>port</i> ten-gigabitEthernet <i>port</i> }</p> <p>Enter Interface Configuration Mode.</p> <p><i>port</i>: Specify the Ethernet port number, for example, 1/0/1. no switchport</p> <p>Switch the Layer 2 port into the Layer 3 routed port.</p> <p>Enter Port-channel Interface Configuration Mode:</p> <p>interface { port-cahnnel <i>port-channel</i> }</p> <p>Enter Interface Configuration Mode.</p> <p><i>port-channel</i>: Specify the port channel. Valid values are from 1 to 14. no switchport</p> <p>Switch the port channel to a Layer 3 port channel interface.</p>
Step 3	<p>ip dhcp relay default-interface</p> <p>Set the interface as the default relay-agent interface. If the VLAN that the clients belong to does not have an IP address, the switch will use the IP address of this interface to fill in the Relay Agent IP Address field of DHCP packets from the DHCP clients.</p>
Step 4	<p>exit</p> <p>Return to Global Configuration Mode.</p>
Step 5	<p>ip dhcp relay vlan <i>vid</i> helper-address <i>ip-address</i></p> <p>Specify the VLAN ID and the DHCP server.</p> <p><i>vid</i>: Enter the ID of the VLAN, in which the hosts can dynamically get the IP addresses from the DHCP server.</p> <p><i>ip-address</i>: Enter the IP address of the DHCP server.</p>
Step 6	<p>show ip dhcp relay</p> <p>Verify the configuration of DHCP Relay.</p>
Step 7	<p>end</p> <p>Return to Privileged EXEC Mode.</p>
Step 8	<p>copy running-config startup-config</p> <p>Save the settings in the configuration file.</p>

The following example shows how to set the routed port 1/0/2 as the default relay agent interface and configure the DHCP server address as 192.168.1.8 on VLAN 10:

```
Switch#configure
```

```
Switch(config)#interface gigabitEthernet 1/0/2
```

```
Switch(config-if)#no switchport
```

```
Switch(config-if)# ip dhcp relay default-interface
```

```
Switch(config-if)#exit
```

```
Switch(config)#ip dhcp relay vlan 10 helper-address 192.168.1.8
```

```
Switch(config)#show ip dhcp relay
```

```
...
```

DHCP VLAN relay helper address is configured on the following vlan:

vlan	Helper address
-----	-----
VLAN 10	192.168.1.8

```
Switch(config)#end
```

```
Switch#copy running-config startup-config
```

4 DHCP L2 Relay Configuration

To complete DHCP L2 Relay configuration, follow these steps:

- 1) Enable DHCP L2 Relay.
- 2) Configure Option 82 for ports.

4.1 Using the GUI

4.1.1 Enabling DHCP L2 Relay

Choose the menu **L3 FEATURES > DHCP Service > DHCP L2 Relay > Global Config** to load the following page.

Figure 4-1 Enable DHCP L2 Relay

Global Config

DHCP L2 Relay: Enable Apply

VLAN Config

Filter by VLAN: From To Apply

<input type="checkbox"/>	VLAN	Status
<input checked="" type="checkbox"/>	1	Disabled
<input type="checkbox"/>	8	Disabled

Total: 2 1 entry selected. Cancel Apply

Follow these steps to enable DHCP L2 Relay globally for the specified VLAN:

- 1) In the **Global Config** section, enable DHCP L2 Relay globally. Click **Apply**.

DHCP L2 Relay Enable or disable DHCP L2 Relay globally.

- 2) In the **VLAN Config** section, enable DHCP L2 Relay for the specified VLAN. Click **Apply**.

VLAN Displays the VLAN ID.

Status Enable DHCP L2 Relay function for the VLAN.

4.1.2 Configuring Option 82 for Ports

Choose the menu **L3 FEATURES > DHCP Service > DHCP L2 Relay > Port Config** to load the following page.

Figure 4-2 Configure Option 82 for Ports

Port Config									
UNIT1		LAGS							
<input type="checkbox"/>	Port	Option 82 Support	Option 82 Policy	Format	Circuit ID Customizaton	Circuit ID	Remote ID Customizaton	Remote ID	LAG
<input type="checkbox"/>	1/0/1	Disabled	Keep	Normal	Disabled		Disabled		---
<input type="checkbox"/>	1/0/2	Disabled	Keep	Normal	Disabled		Disabled		---
<input type="checkbox"/>	1/0/3	Disabled	Keep	Normal	Disabled		Disabled		---
<input type="checkbox"/>	1/0/4	Disabled	Keep	Normal	Disabled		Disabled		---
<input type="checkbox"/>	1/0/5	Disabled	Keep	Normal	Disabled		Disabled		---
<input type="checkbox"/>	1/0/6	Disabled	Keep	Normal	Disabled		Disabled		---
<input type="checkbox"/>	1/0/7	Disabled	Keep	Normal	Disabled		Disabled		---
<input type="checkbox"/>	1/0/8	Disabled	Keep	Normal	Disabled		Disabled		---
<input type="checkbox"/>	1/0/9	Disabled	Keep	Normal	Disabled		Disabled		---
<input type="checkbox"/>	1/0/10	Disabled	Keep	Normal	Disabled		Disabled		---
Total: 54									

Follow these steps to enable DHCP Relay and configure Option 82:

- 1) Select one or more ports to configure Option 82.

Option 82 Support	<p>Enable or disable the Option 82 feature for the port.</p> <p>Enable it if you want to prevent DHCP client requests from untrusted sources, or assign different IP addresses to clients in different groups from the same DHCP server.</p>
Option 82 Policy	<p>Select the operation for the Option 82 field of the DHCP request packets.</p> <p>Keep: Indicates keeping the Option 82 field of the packets.</p> <p>Replace: Indicates replacing the Option 82 field of the packets with one defined by the switch. By default, the Circuit ID is defined to be the VLAN and the number of the port which receives the DHCP Request packets. The Remote ID is defined as the MAC address of the switch which receives the DHCP Request packets.</p> <p>Drop: Indicates discarding the packets that include the Option 82 field.</p>
Format	<p>Select the format of option 82 sub-option value field.</p> <p>Normal: The format of sub-option value field is TLV (type-length-value).</p> <p>Private: The format of sub-option value field is just value.</p>

Circuit ID Customization	Enable or disable the switch to define the Option 82 sub-option Circuit ID field. If it is enabled, you can manually configure the circuit ID; if it is disabled, the switch will automatically configure the VLAN ID and the port number of the port that received the DHCP packets as the circuit ID.
Circuit ID	With Circuit ID Customization enabled, you can manually configure the circuit ID here.
Remote ID Customization	Enable or disable the switch to define the Option 82 sub-option Remote ID field. If it is enabled, you can manually configure the remote ID; if it is disabled, the switch will automatically configure the switch's MAC address as the remote ID.
Remote ID	With Remote ID Customization enabled, you can manually configure the remote ID here.
LAG	Displays the LAG that the port belongs to.

2) Click **Apply**.

4.2 Using the CLI

4.2.1 Enabling DHCP L2 Relay

Follow these steps to enable DHCP L2 Relay:

Step 1	configure Enter Global Configuration Mode.
Step 2	ip dhcp l2relay Enable DHCP L2 Relay.
Step 3	ip dhcp l2relay vlan <i>vlan-list</i> Enable DHCP L2 Relay for specified VLANs. <i>vlan-list</i> : Specify the vlan to be enabled with DHCP L2 relay.
Step 5	show ip dhcp l2relay Verify the configuration of DHCP Relay.
Step 6	end Return to Privileged EXEC Mode.
Step 7	copy running-config startup-config Save the settings in the configuration file.

The following example shows how to enable DHCP L2 Relay globally and for VLAN 2:

```
Switch#configure
```

```
Switch(config)#ip dhcp l2relay
```

```
Switch(config)#ip dhcp l2relay vlan 2
```

```
Switch(config)#show ip dhcp l2relay
```

```
Global Status: Enable
```

```
VLAN ID: 2
```

```
Switch(config)#end
```

```
Switch#copy running-config startup-config
```

4.2.2 Configuring Option 82 for Ports

Follow these steps to configure Option 82:

Step 1	<p>configure</p> <p>Enter Global Configuration Mode.</p>
Step 2	<p>interface { fastEthernet port range fastEthernet port-list gigabitEthernet port range gigabitEthernet port-list ten-gigabitEthernet port range ten-gigabitEthernet port-list }</p> <p>Enter Interface Configuration Mode.</p>
Step 3	<p>ip dhcp l2relay information option</p> <p>Enable the Option 82 feature on the port.</p>
Step 4	<p>ip dhcp l2relay information strategy { keep replace drop }</p> <p>Specify the operation for the switch to take when receiving DHCP packets that include the Option 82 field.</p> <p>keep: The switch keeps the Option 82 field of the packets.</p> <p>replace: The switch replaces the Option 82 field of the packets with a new one. The switch presets a default circuit ID and remote ID in TLV (Type, Length, and Value) format. You can also configure the format to include Value only and customize the Value.</p> <p>drop: The switch discards the packets that include the Option 82 field.</p>
Step 5	<p>ip dhcp l2relay information format { normal private }</p> <p>Specify the packet format for the sub-option fields of Option 82.</p> <p>normal: Indicates the fields consist of three parts: Type, Length, and Value (TLV).</p> <p>private: Indicates the fields consist of the value only.</p>

-
- Step 6 **ip dhcp l2relay information circuit-id string**
- (Optional) A default circuit ID is preset on the switch, and you can also run this command to customize the circuit ID. The circuit ID configurations of the switch and the DHCP server should be compatible with each other.
- The default circuit ID is a 4-byte value which consists of 2-byte VLAN ID and 2-byte Port ID. The VLAN ID indicates which VLAN the DHCP client belongs to, and the Port ID indicates which port the DHCP client is connected to. For example, if the DHCP client is connected to port 1/0/1 in VLAN 2, this field is **00:02:00:01** in hexadecimal.
- string*: Enter the customized circuit ID with up to 64 characters.
-
- Step 7 **ip dhcp l2relay information remote-id string**
- (Optional) The switch uses its own MAC address as the default remote ID, and you can also run this command to customize the remote ID. The remote ID configurations of the switch and the DHCP server should be compatible with each other.
- string*: Enter the remote ID with up to 64 characters.
-
- Step 8 **show ip dhcp l2relay information interface { fastEthernet port | gigabitEthernet port | port-channel port-channel-id }**
- Verify the Option 82 configuration of the port.
-
- Step 9 **end**
- Return to Privileged EXEC Mode.
-
- Step 10 **copy running-config startup-config**
- Save the settings in the configuration file.
-

The following example shows how to enable Option 82 on port 1/0/7 and configure the strategy as replace, the format as normal, the circuit-id as VLAN20 and the remote-id as Host1:

Switch#configure

Switch(config)#interface gigabitEthernet 1/0/7

Switch(config-if)#ip dhcp l2relay information option

Switch(config-if)#ip dhcp l2relay information strategy replace

Switch(config-if)#ip dhcp l2relay information format normal

Switch(config-if)#ip dhcp l2relay information circuit-id VLAN20

Switch(config-if)#ip dhcp l2relay information remote-id Host1

Switch(config-if)#show ip dhcp l2relay information interface gigabitEthernet 1/0/7

Interface	Option 82 Status	Operation Strategy	Format	Circuit ID	Remote ID	LAG
-----	-----	-----	-----	-----	-----	-----
Gi1/0/7	Enable	Replace	Normal	VLAN20	Host1	N/A

```
Switch(config-if)#end
```

```
Switch#copy running-config startup-config
```

5 Configuration Examples

5.1 Example for DHCP Server

5.1.1 Network Requirements

As the network topology shows, the administrator uses the switch as the DHCP server to assign IP addresses to all the connected devices. The office computers need to obtain IP addresses dynamically, while the FTP server needs a fixed IP address.

Figure 5-1 Network Topology for DHCP Server

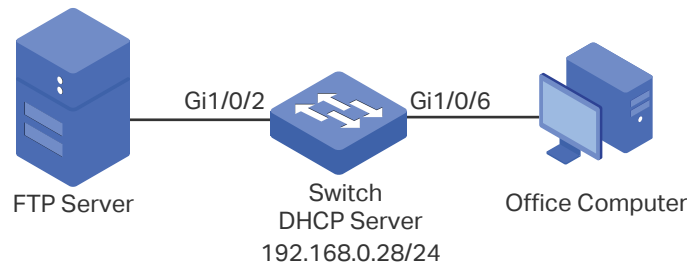

5.1.2 Configuration Scheme

You can enable the DHCP Server service on the switch and create a DHCP IP pool for all the connected devices. Then manually bind the MAC address of the FTP server to an IP address specified for the FTP server.

Demonstrated with SG6654XHP, the following sections provide configuration procedures in two ways: using the GUI and using the CLI.

5.1.3 Using the GUI

- 1) Choose the menu **L3 FEATURES > DHCP Service > DHCP Server > DHCP Server** to load the following page. In the **Global Config** section, enable DHCP Server and click **Apply**.

Figure 5-2 Configuring DHCP Server

Global Config

DHCP Server: Enable

Option 60: (Optional. 1-64 characters)

Option 138: (Optional. Format:192.168.0.1)

- 2) Choose the menu **L3 FEATURES > DHCP Service > DHCP Server > Pool Setting** and click **+ Add** to load the following page. Specify the Pool Name, Network Address,

Subnet Mask, Lease Time, Default Gateway and DNS Server as shown below. Click **Create**.

Figure 5-3 Configuring DHCP Server Pool

DHCP Server Pool

Pool Name: (8 characters maximum)

Network Address: (Format: 192.168.0.0)

Subnet Mask: (Format: 255.255.255.0)

Lease Time: (Optional. 1-2880 min, Default: 120)

▶ Default Gateway: (Optional. Format: 192.168.0.1)

▶ DNS Server: (Optional. Format: 192.168.0.1)

▶ NetBIOS Server: (Optional. Format: 192.168.0.1)

NetBIOS Node Type: (Optional, b/p/m/h/none)

Next Server Address: (Optional. Format: 192.168.0.1)

Domain Name: (0 to 200 characters)

Bootfile: (0 to 128 characters)

- 3) Choose the menu **L3 FEATURES > DHCP Service > DHCP Server > Manual Binding** and click **+ Add** to load the following page. Select the DHCP server pool you just created, and enter the IP address of the FTP server in the IP Address field. Select Hardware Address as the binding mode, and enter the MAC address of the FTP server in the Hardware Address field. Select Ethernet as the Hardware Type. Click **Create**.

Figure 5-4 Configuring Manual Binding

Manual Binding

Pool Name:

IP Address: (Format: 192.168.0.1)

Binding Mode:

Hardware Address: (Format: 00-11-22-33-44-55)

Hardware Type:

- 4) Click  **Save** to save the settings.

5.1.4 Using the CLI

- 1) Enable DHCP Server.

```
Switch#configure
Switch(config)#service dhcp server
```

- 2) Specify the Pool Name, Network Address, Subnet Mask and Lease Time.

```
Switch(config)#ip dhcp server pool pool
Switch(dhcp-config)#network 192.168.0.0 255.255.255.0
Switch(dhcp-config)#lease 120
Switch(dhcp-config)#exit
```

- 3) Bind the specified IP address to the MAC address of the FTP server.

```
Switch(config)# ip dhcp server pool pool
Switch(dhcp-config)# address 192.168.0.8 hardware-address FC-AA-14-59-E9-4A
hardware-type ethernet
Switch(dhcp-config)#end
Switch#copy running-config startup-config
```

Verify the Configuration

```
Switch#show ip dhcp server binding
```

IP Address	Client id/Hardware Address	Type	Lease Time Left
-----	-----	-----	-----
192.168.0.2	01-d43d-7ebf-615f	Automatic	01:57:27
192.168.0.8	01-fcaa-1459-e94a	Manual	Infinite

5.2 Example for DHCP Interface Relay

5.2.1 Network Requirements

The administrator deploys one DHCP server on the network, and wants the server to assign IP addresses to the computers in the Marketing department and the R&D department. It is required that computers in the same department should be on the same subnet, while computers in different departments should be on different subnets.

After adding the DHCP server, the network topology will be as shown in [Figure 5-5](#). The Marketing department and the R&D department belong to VLAN 10 and VLAN 20, respectively. The IP address of VLAN interface 10 is 192.168.2.1/24, and the IP address of VLAN interface 20 is 192.168.3.1/24. The DHCP server is connected to the routed port of

the switch. The Marketing department is connected to port 1/0/1 of the relay agent, and the R&D department is connected to port 1/0/2 of the relay agent.

Figure 5-5 Network Topology for DHCP Interface Relay

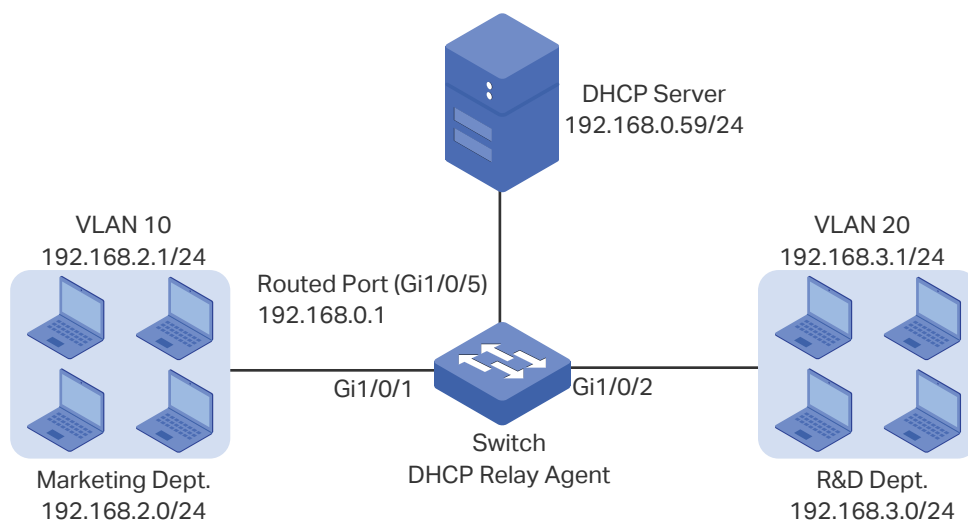

5.2.2 Configuration Scheme

In the given situation, the DHCP server and the computers are isolated in different network segments, so the DHCP requests from the clients cannot be directly forwarded to the DHCP server. To assign IP addresses in two different subnets to two departments respectively, we recommend you to configure DHCP Interface Relay to satisfy the requirement.

The overview of the configurations are as follows:

- 1) Before configuring DHCP Interface Relay, create two DHCP IP pools on the DHCP server for the two departments, respectively. Then create static routes or enable dynamic routing protocol like RIP on the DHCP server to make sure the DHCP server can reach the clients in the two VLANs.
- 2) Configure 802.1Q VLAN on the DHCP relay agent. Add all computers in the marketing department to VLAN 10, and add all computers in the R&D department to VLAN 20.
- 3) Create VLAN interfaces for VLAN 10 and VLAN 20 on the DHCP relay agent.
- 4) Configure DHCP Interface Relay on the DHCP relay agent. Enable DHCP Relay globally, and specify the DHCP server address for each VLAN.

In this example, the DHCP server is demonstrated with SG6654XHP and the DHCP relay agent is demonstrated with SG6654X. This section provides configuration procedures in two ways: using the GUI and using the CLI.

5.2.3 Using the GUI

■ **Configuring the DHCP Server**

- 1) Choose the menu **L3 FEATURES > DHCP Service > DHCP Server > DHCP Server** to load the following page. In the **Global Config** section, enable DHCP Server globally.

Figure 5-6 Configuring DHCP Server

Global Config

DHCP Server: Enable

Option 60: (Optional. 1-64 characters)

Option 138: (Optional. Format:192.168.0.1)

Apply

- 2) Choose the menu **L3 FEATURES > DHCP Service > DHCP Server > Pool Setting** and click **+ Add** to load the following page. Create pool 1 for VLAN 10 and pool 2 for VLAN 20. Configure the corresponding parameters as the following pictures show.

Figure 5-7 Configuring DHCP Pool 1 for VLAN 10

DHCP Server Pool

Pool Name: (8 characters maximum)

Network Address: (Format: 192.168.0.0)

Subnet Mask: (Format: 255.255.255.0)

Lease Time: (Optional. 1-2880 min, Default: 120)

▶ Default Gateway: (Optional. Format: 192.168.0.1)

▶ DNS Server: (Optional. Format: 192.168.0.1)

▶ NetBIOS Server: (Optional. Format: 192.168.0.1)

NetBIOS Node Type: (Optional, b/p/m/h/none)

Next Server Address: (Optional. Format: 192.168.0.1)

Domain Name: (0 to 200 characters)

Bootfile: (0 to 128 characters)

Cancel **Create**

Figure 5-8 Configuring DHCP Pool 2 for VLAN 20

DHCP Server Pool

Pool Name:	pool2	(8 characters maximum)
Network Address:	192.168.3.0	(Format: 192.168.0.0)
Subnet Mask:	255.255.255.0	(Format: 255.255.255.0)
Lease Time:	120	(Optional. 1-2880 min, Default: 120)
▶ Default Gateway:	192.168.3.1	(Optional. Format: 192.168.0.1)
▶ DNS Server:		(Optional. Format: 192.168.0.1)
▶ NetBIOS Server:		(Optional. Format: 192.168.0.1)
NetBIOS Node Type:	▼	(Optional, b/p/m/h/none)
Next Server Address:		(Optional. Format: 192.168.0.1)
Domain Name:		(0 to 200 characters)
Bootfile:		(0 to 128 characters)

Cancel
Create

- 3) Choose the menu **L3 FEATURES > Static Routing > IPv4 Static Routing** and click **+ Add** to load the following page. Create two static routing entries for the DHCP server to make sure that the DHCP server can reach the clients in the two VLANs.

Figure 5-9 Creating the Static Routing Entry for VLAN 10

IPv4 Static Routing

Destination:	192.168.2.0	(Format: 10.10.10.0)
Subnet Mask:	255.255.255.0	(Format: 255.255.255.0)
Next Hop:	192.168.0.1	(Format: 192.168.0.2)
Distance:		(Optional. range: 1-255)

Cancel
Create

Figure 5-10 Creating the Static Routing Entry for VLAN 20

IPv4 Static Routing

Destination: (Format: 10.10.10.0)

Subnet Mask: (Format: 255.255.255.0)

Next Hop: (Format: 192.168.0.2)

Distance: (Optional. range: 1-255)

■ **Configuring the VLANs on the Relay Agent**

- 1) Choose the menu **L2 FEATURES > VLAN > 802.1Q VLAN > VLAN Config** and click **+ Add** to load the following page. Create VLAN 10 for the Marketing department and add port 1/0/1 as an untagged port to the VLAN.

Figure 5-11 Creating VLAN 10

VLAN Config

VLAN ID: (2-4094, format: 2,4-5,8)

VLAN Name: (1-16 characters)

Untagged Ports

Port: (Format: 1/0/1, input or choose below)

1 3 5 7 9 11 13 15 17 19 21 23 25 27 29 31 33 35 37 39
 2 4 6 8 10 12 14 16 18 20 22 24 26 28 30 32 34 36 38 40
 Select All
 41 43 45 47 49 51 53
 42 44 46 48 50 52 54

Selected Unselected Not Available

Tagged Ports

Port: (Format: 1/0/1, input or choose below)

1 3 5 7 9 11 13 15 17 19 21 23 25 27 29 31 33 35 37 39
 2 4 6 8 10 12 14 16 18 20 22 24 26 28 30 32 34 36 38 40
 41 43 45 47 49 51 53
 42 44 46 48 50 52 54

- 2) On the same page, click **+ Add** again to create VLAN 20 for the R&D department and add port 1/0/2 as an untagged port to the VLAN.

Figure 5-12 Creating VLAN 20

VLAN Config

VLAN ID: (2-4094, format: 2,4-5,8)

VLAN Name: (1-16 characters)

Untagged Ports

Port: (Format: 1/0/1, input or choose below)

UNIT1 LAGS

1 3 5 7 9 11 13 15 17 19 21 23 25 27 29 31 33 35 37 39
 2 4 6 8 10 12 14 16 18 20 22 24 26 28 30 32 34 36 38 40
 41 43 45 47 49 51 53
 42 44 46 48 50 52 54

Select All

Selected Unselected Not Available

Tagged Ports

Port: (Format: 1/0/1, input or choose below)

UNIT1 LAGS

1 3 5 7 9 11 13 15 17 19 21 23 25 27 29 31 33 35 37 39
 41 43 45 47 49 51 53
 42 44 46 48 50 52 54

■ **Configuring the VLAN Interface and Routed Port on the Relay Agent**

- 1) Choose the menu **L3 FEATURES > Interface** and click **+ Add** to load the following page. Create VLAN interface 10 and VLAN interface 20. Configure port 1/0/5 as the routed port.

Figure 5-13 Creating VLAN Interface 10

Interface Config

Interface ID: (1-4094)

IP Address Mode: None Static DHCP BOOTP

IP Address: (Format: 192.168.0.1)

Subnet Mask: (Format: 255.255.255.0)

Admin Status: Enable

Interface Name: (Optional. 1-16 characters)

Figure 5-14 Creating VLAN Interface 20

Interface Config

Interface ID: VLAN 20 (1-4094)

IP Address Mode: None Static DHCP BOOTP

IP Address: 192.168.3.1 (Format: 192.168.0.1)

Subnet Mask: 255.255.255.0 (Format: 255.255.255.0)

Admin Status: Enable

Interface Name: (Optional. 1-16 characters)

Cancel Create

- 2) On the same page, click **Add** again to configure port 1/0/5 as the routed port.

Figure 5-15 Configuring the Routed Port

Interface Config

Interface ID: Routed Port 1/0/5 (Format: 1/0/1)

UNIT1

1 3 5 7 9 11 13 15 17 19 21 23 25 27 29 31 33 35 37 39 41 43

2 4 6 8 10 12 14 16 18 20 22 24 26 28 30 32 34 36 38 40 42 44

45 47 49 51 53

46 48 50 52 54

IP Address Mode: None Static DHCP BOOTP

IP Address: 192.168.0.1 (Format: 192.168.0.1)

Subnet Mask: 255.255.255.0 (Format: 255.255.255.0)

Admin Status: Enable

Interface Name: (Optional. 1-16 characters)

Cancel Create

■ **Configuring DHCP Interface Relay on the Relay Agent**

- 1) Choose the menu **L3 FEATURES > DHCP Service > DHCP Relay > DHCP Relay Config** to load the following page. In the **Global Config** section, enable DHCP Relay, and click **Apply**.

Figure 5-16 Enable DHCP Relay

Global Config

DHCP Relay: Enable

DHCP Relay Hops: (1-16)

DHCP Relay Time Threshold: seconds (0-65535)

- Choose the menu **L3 FEATURES > DHCP Service > DHCP Relay > DHCP Interface Relay** and click **+ Add** to load the following page. Specify the DHCP server for the clients in VLAN 10 and VLAN 20.

Figure 5-17 Specify DHCP Server for Interface VLAN 10

DHCP Interface Relay

Interface ID: (1-4094)

Server Address: (Format: 192.168.0.1)

Figure 5-18 Specify DHCP Server for Interface VLAN 20

DHCP Interface Relay

Interface ID: (1-4094)

Server Address: (Format: 192.168.0.1)

- Click  Save to save the settings.

5.2.4 Using the CLI

■ Configuring the DHCP Server

- Enable DHCP service globally.

```
Switch#configure
```

```
Switch(config)#service dhcp server
```

- Create DHCP pool 1 and configure its network address as 192.168.2.0, subnet mask as 255.255.255.0, lease time as 120 minutes, default gateway as 192.168.2.1; Create DHCP pool 2 and configure its network address as 192.168.3.0, subnet mask as 255.255.255.0, lease time as 120 minutes, default gateway as 192.168.3.1.

```
Switch(config)#ip dhcp server pool pool1
```

```
Switch(dhcp-config)#network 192.168.2.0 255.255.255.0
```

```
Switch(dhcp-config)#lease 120
```

```
Switch(dhcp-config)#default-gateway 192.168.2.1
```

```
Switch(dhcp-config)#exit
```

```
Switch(config)#ip dhcp server pool pool2
```

```
Switch(dhcp-config)#network 192.168.2.0 255.255.255.0
```

```
Switch(dhcp-config)#lease 120
```

```
Switch(dhcp-config)#default-gateway 192.168.3.1
```

```
Switch(dhcp-config)#exit
```

- 3) Create two static routing entries to make sure that the DHCP server can reach the clients in the two VLANs.

```
Switch(config)# ip route 192.168.2.0 255.255.255.0 192.168.0.1
```

```
Switch(config)# ip route 192.168.3.0 255.255.255.0 192.168.0.1
```

```
Switch(config)#end
```

```
Switch#copy running-config startup-config
```

■ Configuring the VLAN on the Relay Agent

```
Switch(config)# vlan 10
```

```
Switch(config-vlan)#name Marketing
```

```
Switch(config-vlan)#exit
```

```
Switch(config)#interface gigabitEthernet 1/0/1
```

```
Switch(config-if)#switchport general allowed vlan 10 untagged
```

```
Switch(config-if)#exit
```

```
Switch(config)# vlan 20
```

```
Switch(config-vlan)#name RD
```

```
Switch(config-vlan)#exit
```

```
Switch(config)#interface gigabitEthernet 1/0/2
```

```
Switch(config-if)#switchport general allowed vlan 20 untagged
```

```
Switch(config-if)#exit
```

■ Configuring the VLAN Interfaces Routed Port on the Relay Agent

```
Switch(config)#interface vlan 10
```

```
Switch(config-if)#ip address 192.168.2.1 255.255.255.0
Switch(config-if)#exit
Switch(config)#interface vlan 20
Switch(config-if)#ip address 192.168.3.1 255.255.255.0
Switch(config-if)#exit
Switch(config)#interface gigabitEthernet 1/0/5
Switch(config-if)#ip address 192.168.0.1 255.255.255.0
Switch(config-if)#exit
```

■ Configuring DHCP Interface Relay on the Relay Agent

- 1) Enable DHCP Relay.

```
Switch#configure
Switch(config)#service dhcp relay
```

- 2) Specify the DHCP server for the interface VLAN 10.

```
Switch(config)#interface vlan 10
Switch(config-if)#ip helper-address 192.168.0.59
Switch(config-if)#exit
```

- 3) Specify the DHCP server for interface VLAN 20

```
Switch(config)#interface vlan 20
Switch(config-if)#ip helper-address 192.168.0.59
Switch(config-if)#end
Switch#copy running-config startup-config
```

Verify the Configurations of the DHCP Relay Agent

```
Switch#show ip dhcp relay
```

```
DHCP relay is enabled
```

```
...
```

DHCP relay helper address is configured on the following interfaces:

Interface	Helper address
-----	-----
VLAN10	192.168.0.59
VLAN20	192.168.0.59

```
...
```

5.3 Example for DHCP VLAN Relay

5.3.1 Network Requirements

The administrator needs to deploy the office network for the Marketing department and the R&D department. The detailed requirements are listed below:

- The Marketing department and the R&D department belong to VLAN 10 and VLAN 20, respectively. Both of the VLANs have no Layer 3 gateways.
- Computers in the two departments need to obtain IP addresses from the same DHCP server.

The network topology designed by the administrator is shown below.

Figure 5-19 Network Topology for DHCP VLAN Relay

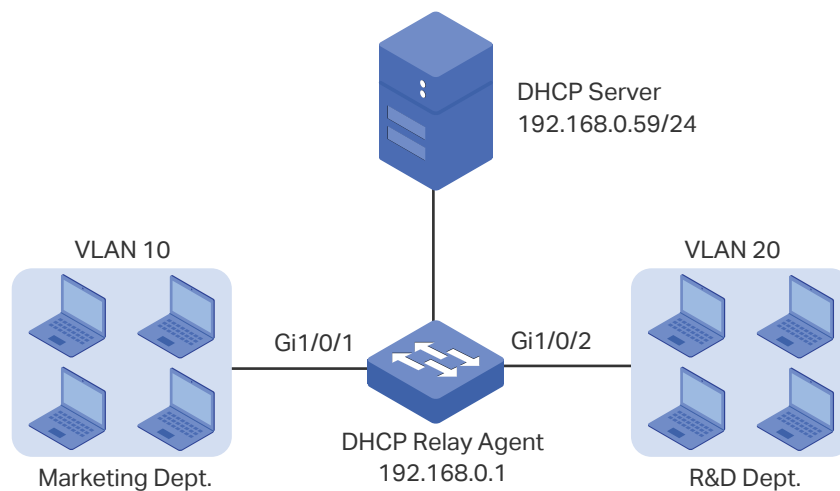

5.3.2 Configuration Scheme

In the given situation, the DHCP server and the computers are isolated by VLANs, so the DHCP request from the clients cannot be directly forwarded to the DHCP server. Considering that the two VLANs have no Layer 3 gateways, we recommend you to configure DHCP VLAN Relay to satisfy the requirement.

The overview of the configurations are as follows:

- 1) Create one DHCP IP pool on the DHCP server, which is on 192.168.0.0/24 network segment.
- 2) Configure 802.1Q VLAN on the DHCP relay agent. Add all computers in the marketing department to VLAN 10, and add all computers in the R&D department to VLAN 20.
- 3) Configure DHCP VLAN Relay on the DHCP relay agent. Enable DHCP Relay globally, choose the VLAN interface 1 (the default management VLAN interface) as the default relay agent interface, and specify the DHCP server address for VLAN 10 and VLAN 20.

In this example, the DHCP server is demonstrated with SG6654XHP and the DHCP relay agent is demonstrated with SG6654X. The following sections provide configuration procedures in two ways: using the GUI and using the CLI.

5.3.3 Using the GUI

■ Configuring the DHCP Server

- 1) Choose the menu **L3 FEATURES > DHCP Service > DHCP Server > DHCP Server** to load the following page. In the **Global Config** section, enable DHCP Server globally.

Figure 5-20 Configuring DHCP Server

Global Config

DHCP Server: Enable

Option 60: (Optional. 1-64 characters)

Option 138: (Optional. Format:192.168.0.1)

Apply

- 2) Choose the menu **L3 FEATURES > DHCP Service > DHCP Server > Pool Setting** and click **+ Add** to load the following page. Create a DHCP pool for the clients. Configure the corresponding parameters as the following picture shows.

Figure 5-21 Configuring DHCP Pool 1 for VLAN 10

DHCP Server Pool

Pool Name: (8 characters maximum)

Network Address: (Format: 192.168.0.0)

Subnet Mask: (Format: 255.255.255.0)

Lease Time: (Optional. 1-2880 min, Default: 120)

▶ Default Gateway: (Optional. Format: 192.168.0.1)

▶ DNS Server: (Optional. Format: 192.168.0.1)

▶ NetBIOS Server: (Optional. Format: 192.168.0.1)

NetBIOS Node Type: (Optional, b/p/m/h/none)

Next Server Address: (Optional. Format: 192.168.0.1)

Domain Name: (0 to 200 characters)

Bootfile: (0 to 128 characters)

Cancel Create

■ **Configuring the VLANs on the Relay Agent**

- 1) Choose the menu **L2 FEATURES > VLAN > 802.1Q VLAN > VLAN Config** and click **+ Add** to load the following page. Create VLAN 10 for the Marketing department and add port 1/0/1 as untagged port to the VLAN.

Figure 5-22 Creating VLAN 10

The screenshot shows the 'VLAN Config' page with the following details:

- VLAN ID:** 10 (highlighted in a red box)
- VLAN Name:** Marketing (highlighted in a red box)
- Untagged Ports:**
 - Port: 1/0/1 (highlighted in a red box)
 - Grid of ports: Port 1 is selected (highlighted in a red box).
- Tagged Ports:** (Empty)
- Buttons:** 'Cancel' and 'Create' (highlighted in a red box)

- 2) On the same page, click **+ Add** again to create VLAN 20 for the R&D department and add port 1/0/2 as untagged port to the VLAN.

Figure 5-23 Creating VLAN 20

The screenshot shows the 'VLAN Config' interface. The 'VLAN ID' field contains '20' and the 'VLAN Name' field contains 'RD'. Both fields are highlighted with a red box. Under 'Untagged Ports', the 'Port' field contains '1/0/2'. Below this, a grid of port icons is shown, with port 2 highlighted in a red box. A legend at the bottom indicates that a blue icon represents 'Selected', a white icon represents 'Unselected', and a grey icon represents 'Not Available'. At the bottom right, there are 'Cancel' and 'Create' buttons, with the 'Create' button highlighted in a red box.

■ **Configuring DHCP VLAN Relay on the Relay Agent**

- 1) Choose the menu **L3 FEATURES > DHCP Service > DHCP Relay > DHCP Relay Config** to load the following page. In the **Global Config** section, enable DHCP Relay, and click **Apply**.

Figure 5-24 Enable DHCP Relay

The screenshot shows the 'Global Config' section for DHCP Relay. The 'DHCP Relay' checkbox is checked and labeled 'Enable', with a red box around it. The 'DHCP Relay Hops' field contains '4' and the 'DHCP Relay Time Threshold' field contains '0'. At the bottom right, there is an 'Apply' button highlighted with a red box.

- 2) Choose the menu **L3 FEATURES > DHCP Service > DHCP Relay > DHCP VLAN Relay** to load the following page. In the **Default Relay Agent Interface** section, specify VLAN interface 1 (the default management VLAN interface) as the default relay-agent interface. Click **Apply**.

Figure 5-25 Specify the Default Relay Agent Interface

Default Relay Agent Interface

Interface ID: (1-4094)

IP Address: 192.168.0.1

- 3) Choose the menu **L3 FEATURES > DHCP Service > DHCP Relay > DHCP VLAN Relay** and click **+ Add** to load the following page. Specify the DHCP server address for the clients in VLAN 10 and VLAN 20.

Figure 5-26 Specify DHCP Server for Interface VLAN 10

DHCP VLAN Relay

VLAN ID: (1-4094)

Server Address: (Format: 192.168.0.1)

Figure 5-27 Specify DHCP Server for Interface VLAN 20

DHCP VLAN Relay

VLAN ID: (1-4094)

Server Address: (Format: 192.168.0.1)

- 4) Click  Save to save the settings.

5.3.4 Using the CLI

■ Configuring the DHCP Server

- 1) Enable DHCP service globally.

```
Switch#configure
```

```
Switch(config)#service dhcp server
```

- 2) Create a DHCP pool and name it as "pool" and configure its network address as 192.168.0.0, subnet mask as 255.255.255.0, lease time as 120 minutes, default gateway as 192.168.0.1.

```
Switch(config)#ip dhcp server pool pool
```

```
Switch(dhcp-config)#network 192.168.0.0 255.255.255.0
```

```
Switch(dhcp-config)#lease 120
```



```
Switch(dhcp-config)#default-gateway 192.168.0.1
Switch(dhcp-config)#dns-server 192.168.0.2
Switch(dhcp-config)#end
Switch#copy running-config startup-config
```

■ Configuring the VLAN on the Relay Agent

```
Switch#configure
Switch(config)# vlan 10
Switch(config-vlan)#name Marketing
Switch(config-vlan)#exit
Switch(config)#interface gigabitEthernet 1/0/1
Switch(config-if)#switchport general allowed vlan 10 untagged
Switch(config-if)#exit
Switch(config)# vlan 20
Switch(config-vlan)#name RD
Switch(config-vlan)#exit
Switch(config)#interface gigabitEthernet 1/0/2
Switch(config-if)#switchport general allowed vlan 20 untagged
Switch(config-if)#exit
```

■ Configuring DHCP VLAN Relay on the Relay Agent

- 1) Enable DHCP Relay.

```
Switch(config)#service dhcp relay
```

- 2) Specify the routed port 1/0/5 as the default relay agent interface.

```
Switch(config)#interface vlan 1
Switch(config-if)#ip dhcp relay default-interface
Switch(config-if)#exit
```

- 3) Specify the DHCP server for VLAN 10 and VLAN 20

```
Switch(config)#ip dhcp relay vlan 10 helper-address 192.168.0.59
Switch(config)#ip dhcp relay vlan 20 helper-address 192.168.0.59
Switch(config)#exit
```

Verify the Configurations of the DHCP Relay Agent

```
Switch#show ip dhcp relay
```

```
Switch#show ip dhcp relay
```

```
DHCP relay state: enabled
```

```
...
```

```
DHCP relay default relay agent interface:
```

```
Interface: VLAN 1
```

```
IP address: 192.168.0.1
```

```
DHCP vlan relay helper address is configured on the following vlan:
```

vlan	Helper address

VLAN 10	192.168.0.59
VLAN 20	192.168.0.59

5.4 Example for Option 82 in DHCP Relay

5.4.1 Network Requirements

As the following figure shows, there are two groups of computers. Group 1 is connected to Switch A via port 1/0/1, and Group 2 is connected via port 1/0/2. All computers are in the same VLAN, but the computers and the DHCP server are in different subnets. For management convenience, the administrator wants to allocate separate address spaces for the two groups of computers.

Figure 5-28 Network Topology for Option 82 in DHCP Relay

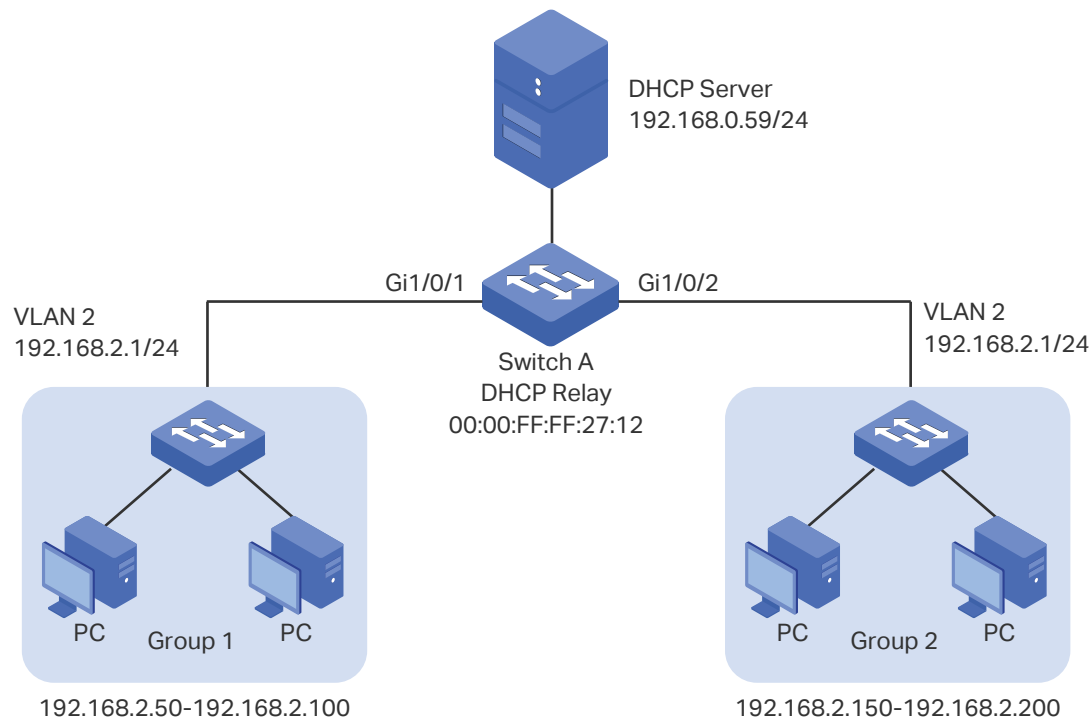

5.4.2 Configuration Scheme

To meet the requirements, you can configure Option 82 in DHCP Relay on Switch A. With DHCP Relay enabled, the switch can forward DHCP requests and replies between clients and the server. With Option 82 enabled, Switch A informs the DHCP server of the group information of each computer, so that the DHCP server can assign IP addresses of different address pools to the computers in different groups.

The overview of the configurations are as follows:

1) Configuring Switch A

- a. Configure 802.1Q VLAN. Add all computers to VLAN 2. For details, refer to [Configuring 802.1Q VLAN](#).
- b. Configure the interface address of VLAN 2. For details, refer to [Configuring Layer 3 Interfaces](#).
- c. Configure DHCP relay and enable Option 82 in DHCP Relay. In this example, both DHCP Interface Relay and DHCP VLAN Relay can implement the requirements. Demonstrated with SG6654XHP, [5.4.3 Configuring the DHCP Relay Switch](#) provides configuration procedures to configure DHCP Interface Relay in two ways: using the GUI and using the CLI.

2) Configuring the DHCP Server

The detailed configurations on the DHCP server may be different among different devices. You can refer to the related document that is for the DHCP server you use. Demonstrated with a Linux ISC DHCP Server, [5.4.4 Configuring the DHCP Server](#) provides information about how to set its DHCP configuration file.

5.4.3 Configuring the DHCP Relay Switch

Using the GUI

Follow these steps to configure DHCP relay and enable Option 82 in DHCP Relay on Switch A:

- 1) Choose the menu **L3 FEATURES > DHCP Service > DHCP Relay > DHCP Relay Config** to load the following page. In the **Global Config** section, enable DHCP Relay, and click **Apply**.

Figure 5-29 Enable DHCP Relay

Global Config

DHCP Relay: Enable

DHCP Relay Hops: (1-16)

DHCP Relay Time Threshold: seconds (0-65535)

- 2) In the **Option 82 Config** section, select port 1/0/1 and port 1/0/2, enable Option 82 Support and set Option 82 Policy as Replace. You can configure other parameters according to your needs. In this example, the Format is set as Normal, and Circuit ID Customization and Remote ID Customization as Disabled. Click **Apply**.

Figure 5-30 Configure Option 82

Option 82 Config

UNIT1 | LAGS

<input type="checkbox"/>	Port	Option 82 Support	Option 82 Policy	Format	Circuit ID Customization	Circuit ID	Remote ID Customization	Remote ID	LAG
<input checked="" type="checkbox"/>	1/0/1	Enable	Replace	Normal	Disabled		Disabled		--
<input checked="" type="checkbox"/>	1/0/2	Enable	Replace	Normal	Disabled		Disabled		--
<input type="checkbox"/>	1/0/3	Disabled	Keep	Normal	Disabled		Disabled		--
<input type="checkbox"/>	1/0/4	Disabled	Keep	Normal	Disabled		Disabled		--
<input type="checkbox"/>	1/0/5	Disabled	Keep	Normal	Disabled		Disabled		--
<input type="checkbox"/>	1/0/6	Disabled	Keep	Normal	Disabled		Disabled		--
<input type="checkbox"/>	1/0/7	Disabled	Keep	Normal	Disabled		Disabled		--
<input type="checkbox"/>	1/0/8	Disabled	Keep	Normal	Disabled		Disabled		--
<input type="checkbox"/>	1/0/9	Disabled	Keep	Normal	Disabled		Disabled		--
<input type="checkbox"/>	1/0/10	Disabled	Keep	Normal	Disabled		Disabled		--

Total: 54 | 2 entries selected. |

- 3) Choose the menu **L3 FEATURES > DHCP Service > DHCP Relay > DHCP Interface Relay** and click **+ Add** to load the following page. Specify the DHCP server address to assign IP addresses for clients in VLAN 2. Click **Create**.

Figure 5-31 Specify DHCP Server for Interface VLAN 2

- 4) Click  **Save** to save the settings.

Using the CLI

Follow these steps to configure DHCP relay and enable Option 82 in DHCP Relay on Switch A:

- 1) Enable DHCP Relay.

```
Switch#configure
```

```
Switch(config)#service dhcp relay
```

- 2) Enable Option 82 for port 1/0/1 and port 1/0/2. Set Option 82 policy as **Replace**. You can configure other parameters according to your needs. In this example, the Format is set as Normal, and Circuit ID Customization and Remote ID Customization as Disabled.

```
Switch#(config)#interface range gigabitEthernet 1/0/1-2
```

```
Switch(config-if)#ip dhcp relay information option
```

```
Switch(config-if)#ip dhcp relay information strategy replace
```

```
Switch(config-if)#ip dhcp relay information format normal
```

```
Switch(config-if)#exit
```

- 3) Specify the DHCP server for the interface VLAN 2.

```
Switch(config)#interface vlan 2
```

```
Switch(config-if)#ip helper-address 192.168.0.59
```

```
Switch(config-if)#end
```

```
Switch#copy running-config startup-config
```

- 4) Verify the Configurations

View global settings:

```
Switch#show ip dhcp relay
```

DHCP relay state: enabled

...

DHCP relay helper address is configured on the following interfaces:

Interface	Helper address
-----	-----
VLAN2	192.168.0.59

...

View port settings:

Switch#show ip dhcp relay information interface

Interface	Option 82 Status	Operation Strategy	Format	Circuit ID	...
-----	-----	-----	-----	-----	...
Gi1/0/1	Enable	Replace	Normal	Default:VLAN-PORT	...
Gi1/0/2	Enable	Replace	Normal	Default:VLAN-PORT	...

...

5.4.4 Configuring the DHCP Server

Note:

- Make sure the DHCP server supports Option 82 and more than one DHCP address pool.
- To make sure the DHCP server can reach the computers, you can create static routes or enable dynamic routing protocol like RIP on the DHCP server.
- In this section, we use different notations to distinguish ASCII strings from hexadecimal numbers. An ASCII string is enclosed with quotation marks, such as "123", while a hexadecimal number is divided by colon into parts of two digits, such as **31:32:33**.

On the DHCP server, you need to create two DHCP classes to identify the Option 82 payloads of DHCP request packets from Group 1 and Group 2, respectively.

In this example, the DHCP relay agent uses the default circuit ID and remote ID in TLV format. According to packet formats described in [Table 1-1](#) and [Table 1-2](#), the sub-options of the two groups are as shown in the following table.

Table 5-1 Sub-options of Group1 and Group 2

Group	Sub-option	Type (Hex)	Length (Hex)	Value (Hex)
1	Circuit ID	00	04	00:02:00:01
	Remote ID	00	06	00:00:FF:FF:27:12

Group	Sub-option	Type (Hex)	Length (Hex)	Value (Hex)
2	Circuit ID	00	04	00:02:00:02
	Remote ID	00	06	00:00:FF:FF:27:12

The configuration file **/etc/dhcpd.conf** of the Linux ISC DHCP Server is:

```
ddns-update-style interim;
ignore client-updates;
```

```
# Create two classes to match the pattern of Option 82 in DHCP request packets from
# Group 1 and Group 2, respectively.
# The agent circuit ID inserted by the DHCP relay switch is 6 bytes long in TLV format, one
# byte for Type, one byte for Length, and 4 bytes for Value. Therefore, the offset is 2 and the
length is 4.
```

```
# Similarly, the offset of the agent remote ID is 2 and the length is 6.
```

```
class "VLAN2Port1" {
    match if substring (option agent.circuit-id, 2, 4) = 00:02:00:01
        and substring (option agent.remote-id, 2, 6) = 00:00:ff:ff:27:12;
}
```

```
class "VLAN2Port2" {
    match if substring (option agent.circuit-id, 2, 4) = 00:02:00:02
        and substring (option agent.remote-id, 2, 6) = 00:00:ff:ff:27:12;
}
```

```
# Create two IP Address pools in the same subnet.
```

```
# Assign different IP addresses to the DHCP clients in different groups.
```

```
subnet 192.168.2.0 netmask 255.255.255.0 {
    option routers 192.168.2.1;
    option subnet-mask 255.255.255.0;
    option domain-name-servers 192.168.0.59;
    option domain-name "example.com";
    default-lease-time 600;
    max-lease-time 7200;
    authoritative;
```

```
pool {
    range 192.168.2.50 192.168.2.100;
    allow members of "VLAN2Port1";
}
```

```
pool {
    range 192.168.2.150 192.168.2.200;
    allow members of "VLAN2Port2";
}
```

5.5 Example for DHCP L2 Relay

5.5.1 Network Requirements

As the following figure shows, two groups of computers are connected to Switch A, and Switch A is connected to the DHCP server. All devices on the network are in the default VLAN 1. All computers get dynamic IP addresses from the DHCP server. For management convenience, the administrator wants to allocate separate address spaces for the two groups of computers.

Figure 5-32 Network Topology for DHCP L2 Relay

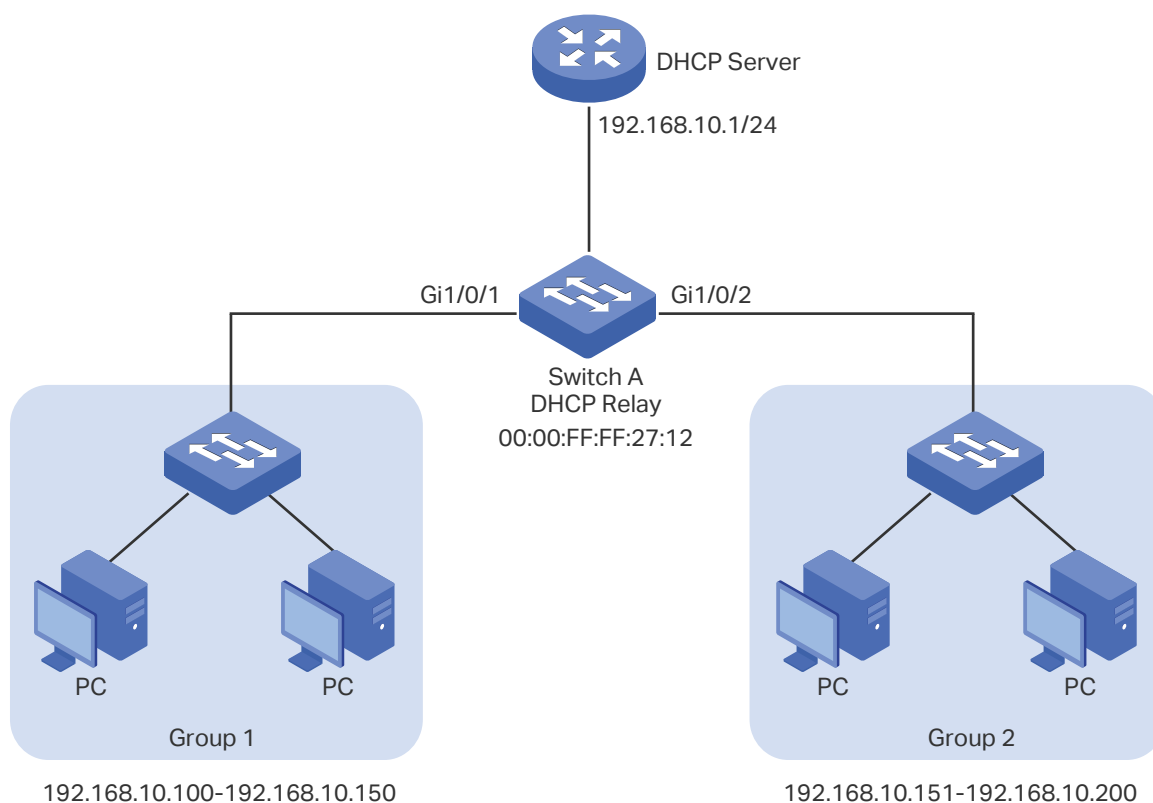

5.5.2 Configuration Scheme

To meet the requirements, you can configure DHCP L2 Relay on Switch A to inform the DHCP server of the group information of each PC, so that the DHCP server can assign IP addresses of different address pools to the PCs in different groups.

The overview of the configurations are as follows:

- 1) Configuring Switch A
 - a. Enable DHCP L2 Relay globally and on VLAN 1.
 - b. Configure Option 82 on ports 1/0/1 and 1/0/2.

Demonstrated with SG6654XHP, [5.5.3 Configuring the DHCP Relay Switch](#) provides configuration procedures in two ways: using the GUI and using the CLI.

2) Configuring the DHCP Server

The detailed configurations on the DHCP server may be different among different devices. You can refer to the related document that is for the DHCP server you use. Demonstrated with a Linux ISC DHCP Server, [5.5.4 Configuring the DHCP Server](#) provides information about how to set its DHCP configuration file.

5.5.3 Configuring the DHCP Relay Switch

Using the GUI

- 1) Choose the menu **L3 FEATURES > DHCP Service > DHCP L2 Relay > Global Config** to load the following page. In the **Global Config** section, enable DHCP L2 Relay globally and click **Apply**. Enable DHCP L2 Relay on VLAN 1 and click **Apply**.

Figure 5-33 Enabling DHCP L2 Relay

The screenshot shows the DHCP L2 Relay configuration interface. It is divided into two main sections: 'Global Config' and 'VLAN Config'.

Global Config: A checkbox labeled 'DHCP L2 Relay:' is checked and labeled 'Enable'. A red box highlights this checkbox and the 'Apply' button to its right.

VLAN Config: A table lists VLANs. The first row is selected, showing 'VLAN' 1 and 'Status' 'Enabled'. A red box highlights the 'Status' dropdown menu, which is currently set to 'Enable'. Below the table, the text 'Total: 1' and '1 entry selected.' are visible. A red box highlights the 'Apply' button at the bottom right of the table area.

- 2) Choose the menu **L3 FEATURES > DHCP Service > DHCP L2 Relay > Port Config** to load the following page. Select port 1/0/1, enable Option 82 Support and select Option 82 Policy as Replace. You can configure other parameters according to your needs. In this example, keep Format as Normal and Remote ID Customization as Disabled. Enable Circuit ID Customization and specify the Circuit ID as Group1. Click **Apply**.

Figure 5-34 Configuring Port 1/0/1

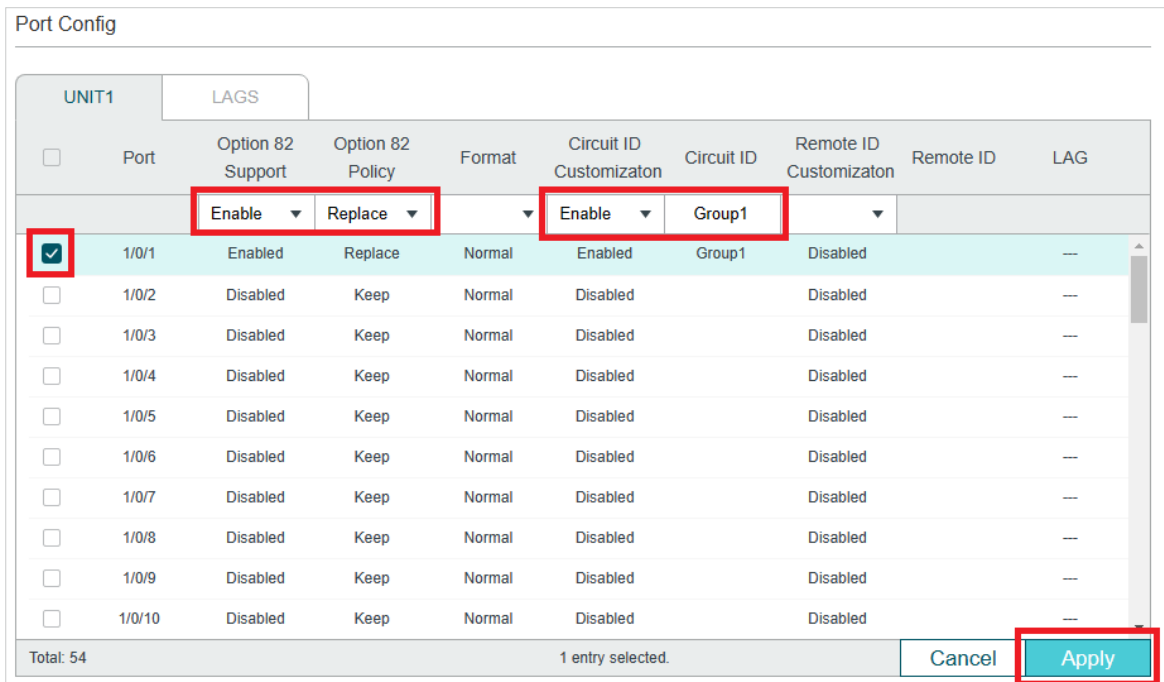

- 3) On the same page, select port 1/0/2, enable Option 82 Support and select Option 82 Policy as Replace. You can configure other parameters according to your needs. In this example, keep Format as Normal and Remote ID Customization as Disabled. Enable Circuit ID Customization and specify the Circuit ID as Group2. Click **Apply**.

Figure 5-35 Configuring Port 1/0/2

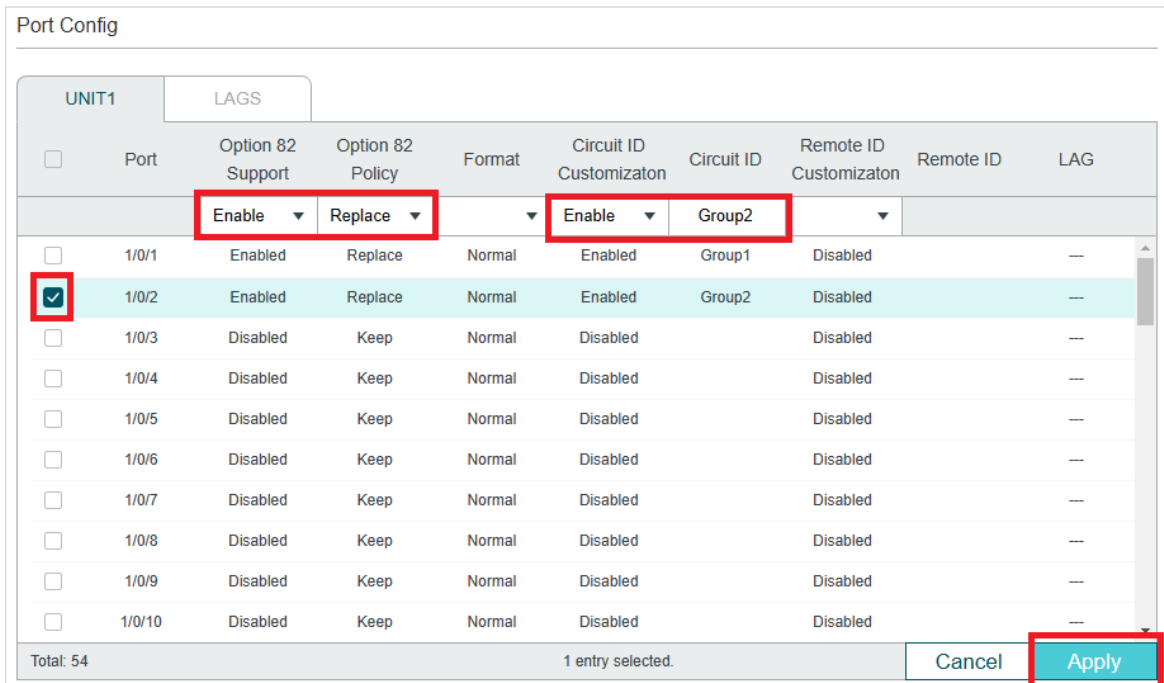

- 4) Click  to save the settings.

Using the CLI

- 1) Enable DHCP L2 Relay globally and on VLAN1.

```
Switch#configure
Switch(config)#ip dhcp l2relay
Switch(config)#ip dhcp l2relay vlan 1
```

- 2) On port 1/0/1, enable Option 82 and select Option 82 Policy as Replace. You can configure other parameters according to your needs. In this example, keep Format as Normal and Remote ID Customization as Disabled. Enable Circuit ID Customization and specify the Circuit ID as Group1.

```
Switch(config)#interface gigabitEthernet 1/0/1
Switch(config-if)#ip dhcp l2relay information option
Switch(config-if)#ip dhcp l2relay information strategy replace
Switch(config-if)#ip dhcp l2relay information circuit-id Group1
Switch(config-if)#exit
```

- 3) On port 1/0/2, enable Option 82 and select Option 82 Policy as Replace. You can configure other parameters according to your needs. In this example, keep Format as Normal and Remote ID Customization as Disabled. Enable Circuit ID Customization and specify the Circuit ID as Group2.

```
Switch(config)#interface gigabitEthernet 1/0/2
Switch(config-if)#ip dhcp l2relay information
Switch(config-if)#ip dhcp l2relay information strategy replace
Switch(config-if)#ip dhcp l2relay information circuit-id Group2
Switch(config-if)#end
Switch#copy running-config startup-config
```

Verify the Configurations

View global settings:

```
Switch#show ip dhcp l2relay
Global Status: Enable
VLAN ID: 1
```

View port settings:

```
Switch#show ip dhcp l2relay information interface gigabitEthernet 1/0/1
```

```

Interface Option 82 Status Operation Strategy Format Circuit ID ...
-----
Gi1/0/1 Enable Replace Normal Group1 ...

Switch#show ip dhcp l2relay information interface gigabitEthernet 1/0/1

Interface Option 82 Status Operation Strategy Format Circuit ID ...
-----
Gi1/0/2 Enable Replace Normal Group2 ...

```

5.5.4 Configuring the DHCP Server

Note:

- Make sure the DHCP server supports Option 82 and more than one DHCP address pool.
- To make sure the DHCP server can reach the computers, you can create static routes or enable dynamic routing protocol like RIP on the DHCP server.
- In this section, we use different notations to distinguish ASCII strings from hexadecimal numbers. An ASCII string is enclosed with quotation marks, such as "123", while a hexadecimal number is divided by colon into parts of two digits, such as **31:32:33**.

On the DHCP server, you need to create two DHCP classes to identify the Option 82 payloads of DHCP request packets from Group 1 and Group 2, respectively.

In this example, the DHCP relay agent uses the customized circuit ID and default remote ID in TLV format. According to packet format described in [Table 1-1](#) and [Table 1-2](#), the sub-options of the two groups are as shown in the following table.

Table 5-2 Sub-options of Group1 and Group 2

Group	Sub-option	Type (Hex)	Length (Hex)	Value
1	Circuit ID	00	06	"Group1" as an ASCII string (or 47:72:6F:75:70:31 in hexadecimal)
	Remote ID	00	06	00:00:FF:FF:27:12
2	Circuit ID	00	06	"Group2" as an ASCII string (or 47:72:6F:75:70:32 in hexadecimal)
	Remote ID	00	06	00:00:FF:FF:27:12

The configuration file **/etc/dhcpd.conf** of the Linux ISC DHCP Server is:

```

ddns-update-style interim;
ignore client-updates;

```

```

# Create two classes to match the pattern of Option 82 in DHCP request packets from
# Group 1 and Group 2, respectively.

```

*# The agent circuit ID inserted by the DHCP relay switch is 8 byte long in TLV format, one
byte for Type, one byte for Length, and 6 bytes for Value. Therefore, the offset is 2 and the
length is 6.
Similarly, the offset of the agent remote ID is 2 and the length is 6.*

```
class "Group1" {  
    match if substring (option agent.circuit-id, 2, 6) = "Group1"  
        and substring (option agent.remote-id, 2, 6) = 00:00:ff:ff:27:12;  
}
```

```
class "Group2" {  
    match if substring (option agent.circuit-id, 2, 6) = "Group2"  
        and substring (option agent.remote-id, 2, 6) = 00:00:ff:ff:27:12;  
}
```

*# Create two IP Address pools in the same subnet.
Assign different IP addresses to the DHCP clients in different groups.*

```
subnet 192.168.10.0 netmask 255.255.255.0 {  
    option routers 192.168.10.1;  
    option subnet-mask 255.255.255.0;  
    option domain-name-servers 192.168.10.1;  
    option domain-name "example.com";  
    default-lease-time 600;  
    max-lease-time 7200;  
    authoritative;
```

```
pool {  
    range 192.168.10.100 192.168.10.150;  
    allow members of "Group1";  
}
```

```
pool {  
    range 192.168.10.151 192.168.10.200;  
    allow members of "Group2";  
}
```

6 Appendix: Default Parameters

Default settings of DHCP Server are listed in the following table.

Table 6-1 Default Settings of DHCP Server

Parameter	Default Setting
Global Config	
DHCP Server	Disabled
Option 60	None
Option 138	None
Ping Time Config	
Ping Packets	1
Ping Timeout	100 ms
Excluded IP Address	
Start IP Address	None
End IP Address	None
Pool Setting	
Pool Name	None
Network Address	None
Subnet Mask	None
Lease Time	120 min
Default Gateway	None
DNS Server	None
NetBIOS Server	None
NetBIOS Node Type	None
Next Server Address	None
Domain Name	None
Bootfile	None

Parameter	Default Setting
Manual Binding	
Pool Name	None
IP Address	None
Binding Mode	Client ID
Client Id	None
Hardware Address	None
Hardware Type	Ethernet

Default settings of DHCP Relay are listed in the following table.

Table 6-2 Default Settings of DHCP Relay

Parameter	Default Setting
DHCP Relay	
DHCP Relay	Disabled
DHCP Relay Hops	4
DHCP Relay Time Threshold	0
Option 82 Configuration	
Option 82 Support	Disabled
Option 82 Policy	Keep
Format	Normal
Circuit ID Customization	Disabled
Circuit ID	None
Remote ID Customization	Disabled
Remote ID	None
DHCP Interface Relay	
Interface ID	None
Server Address	None

Parameter	Default Setting
DHCP VLAN Relay	
Interface ID	None
VLAN ID	None
Server Address	None

Default settings of DHCP L2 Relay are listed in the following table.

Table 6-3 Default Settings of DHCP L2 Relay

Parameter	Default Setting
Global Config	
DHCP Relay	Disabled
VLAN Status	Disabled
Port Config	
Option 82 Support	Disabled
Option 82 Policy	Keep
Format	Normal
Circuit ID Customization	Disabled
Circuit ID	None
Remote ID Customization	Disabled
Remote ID	None

Part 22

Configuring ARP

CHAPTERS

1. Overview
2. ARP Configurations
3. Appendix: Default Parameters

1 Overview

ARP (Address Resolution Protocol) is used to map IP addresses to MAC addresses. Taking an IP address as input, ARP learns the associated MAC address, and stores the IP-MAC address association in an ARP entry for rapid retrieval.

1.1 Supported Features

ARP Table

The ARP table displays all the ARP entries, including dynamic entries and static entries.

Dynamic Entry: Automatically learned and will be deleted after aging time.

Static Entry: Added manually and will be remained unless modified or deleted manually.

Static ARP

You can manually add ARP entries by specifying the IP addresses and MAC addresses.

Gratuitous ARP

Gratuitous ARP is a special kind of ARP. Both the source and destination addresses of the gratuitous ARP packet are the sender its own IP address. It is used to detect duplicate IP address. If an interface sends a gratuitous ARP packet and no replies are received, then the sender knows its IP address is not used by other devices.

Proxy ARP

Normally, the ARP packets can only be transmitted in one broadcast domain, which means if two devices in the same network segment are connected to different Layer 3 interfaces, they cannot communicate with each other because they cannot learn each other's MAC address using ARP packets.

Proxy ARP solves this problem. As shown below, when a host sends an ARP request to another device that is not in the same broadcast domain but on the same network segment, the Layer 3 interface with Proxy ARP enabled will respond the ARP request with its own MAC address if the destination IP is reachable. After that, the ARP request sender sends packets to the switch, and the switch forwards the packets to the intended device.

Figure 1-1 Proxy ARP Application

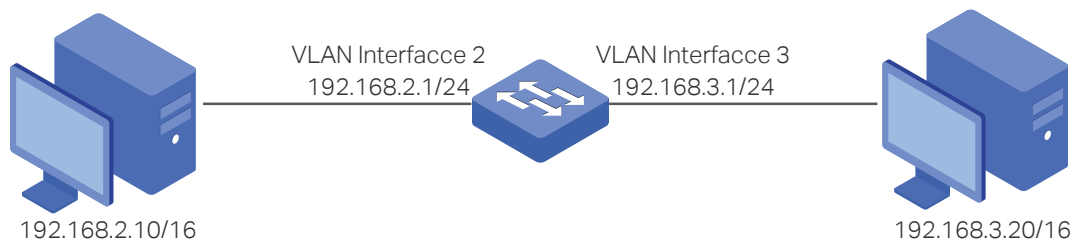

Local Proxy ARP

Local Proxy ARP is similar with Proxy ARP. As shown below, two hosts are in the same VLAN and connected to VLAN interface 1, but port 1/0/1 and port 1/0/2 are isolated on Layer 2. In this case, both of the hosts cannot receive each other's ARP request. So they cannot communicate with each other because they cannot learn each other's MAC address using ARP packets.

To solve this problem, you can enable Local Proxy ARP on the Layer 3 interface and the interface will respond the ARP request sender with its own MAC address. After that, the ARP request sender sends packets to the Layer 3 interface, and the interface forwards the packets to the intended device.

Figure 1-2 Local Proxy ARP Application

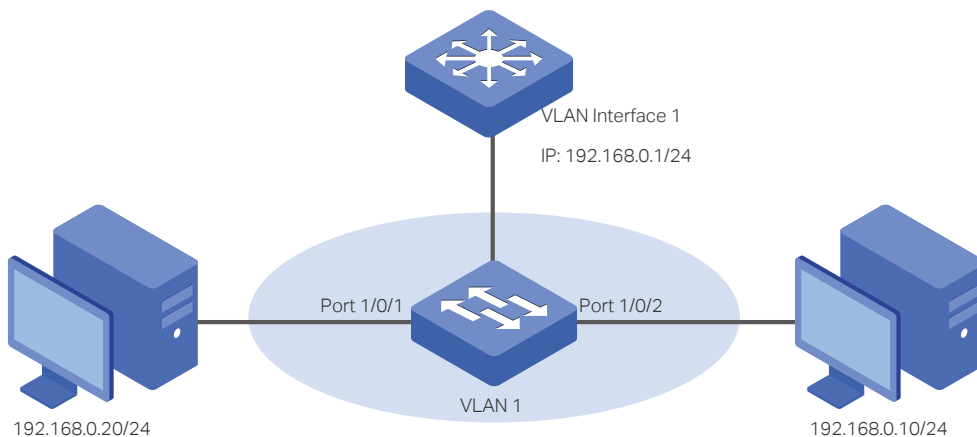

2 ARP Configurations

With ARP configurations, you can:

- View dynamic and static ARP entries.
- Add or delete static ARP entries.

To configure the Gratuitous ARP feature:

- Configure the Gratuitous ARP globally and set the Gratuitous ARP sending interval

To configure the Proxy ARP feature:

- Enable Proxy function for VLAN interfaces or routed ports.

To configure the Local Proxy ARP feature:

- Enable Local Proxy function for VLAN interfaces or routed ports.

2.1 Using the GUI

2.1.1 Viewing the ARP Entries

The ARP table consists of two kinds of ARP entries: dynamic and static.

- Dynamic Entry: Automatically learned and will be deleted after aging time.
- Static Entry: Added manually and will be remained unless modified or deleted manually.

Choose the menu **L3 FEATURES > ARP > ARP Table > ARP Table** to load the following page.

Figure 2-1 Viewing the ARP Entries

ARP Table			
Interface	IP Address	MAC Address	Type
VLAN1	192.168.0.101	40-ed-00-22-30-40	Dynamic
Total: 1			

Interface	Displays the network interface of the ARP entry.
IP Address	Displays the IP address of the ARP entry.
MAC Address	Displays the MAC address of the ARP entry.

Type	<p>Displays the type of the ARP entry.</p> <p>Static: The The entry is added manually and will always remain the same.entry is added manually and will always be remained.</p> <p>Dynamic: The entry that will be deleted after the aging time leased. The aging time is 600 seconds by default. You can also use the command line to change the aging time. For the command line, go to the CLI guide.</p>
-------------	---

2.1.2 Adding Static ARP Entries Manually

You can add desired static ARP entries by manually specifying the IP addresses and MAC addresses.

Choose the menu **L3 FEATURES > ARP > Static ARP** and click  **Add** to load the following page.

Figure 2-2 Adding Static ARP Entries

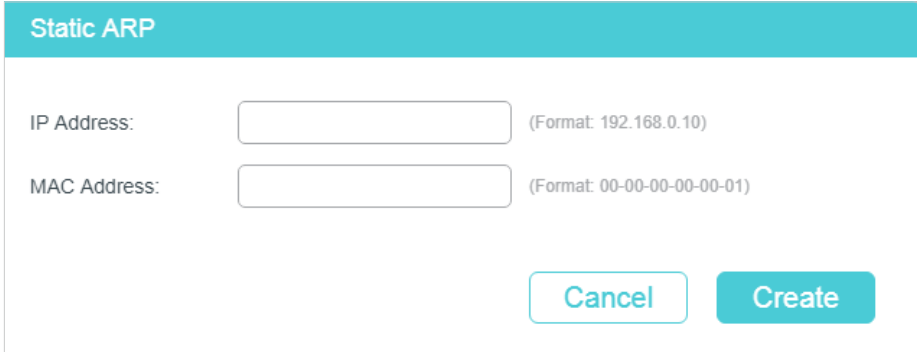

Enter the IP address and MAC address, then click **Create**.

IP address	Enter the IP address of the static ARP entry.
MAC address	Enter the MAC address of the static ARP entry.

2.1.3 Configuring Gratuitous ARP

Choose the menu **L3 FEATURES > ARP > Gratuitous ARP** to load the following page.

Figure 2-3 Configuring Gratuitous ARP

Gratuitous ARP Global Settings

Send on IP Interface Status Up: Enable

Send on Duplicate IP Detected: Enable

Gratuitous ARP Learning: Enable

[Apply](#)

Gratuitous ARP Config

<input type="checkbox"/>	Interface Name	Gratuitous ARP Periodical Send Interval
<input type="checkbox"/>	VLAN1	0
<input type="checkbox"/>	VLAN2	0
<input type="checkbox"/>	VLAN10	0
<input type="checkbox"/>	VLAN20	0
<input type="checkbox"/>	Gi1/0/5	0
Total: 5		

Follow these steps to configure the Gratuitous feature for the interface.

- 1) In the **Gratuitous ARP Global Settings** section, configure the global parameters for gratuitous ARP. Then click **Apply**.

Send on IP Interface Status Up

With this option enabled, the interface will send gratuitous ARP request packets when its status becomes up. This is used to announce the interface's IP address to the other hosts. It is enabled by default.

Send on Duplicate IP Detected

With this option enabled, the interface will send gratuitous ARP request packets when a gratuitous ARP request packet is received for which the IP address is the same as the interface's. In this case, the switch knows that another host is using the same IP address as its own. To claim the IP address for the correct owner, the interface sends gratuitous ARP packets. It is disabled by default.

Gratuitous ARP Learning

Normally, the switch only updates the MAC address table by learning from the ARP reply packet or normal ARP request packet. With this option enabled, the switch will also update the MAC address table by learning from the received gratuitous ARP packets. It is disabled by default.

- 2) In the **Gratuitous ARP Config** section, configure the interval of sending gratuitous ARP request packets for the interface. Then click **Apply**.

Interface Name

Displays the Interface ID of the Layer 3 interface.

Gratuitous ARP Periodical Send Interval

Enter the interval of sending gratuitous ARP request packets for the interface. A value 0 means the interface will not send gratuitous ARP request packets periodically.

2.1.4 Configuring Proxy ARP

Proxy ARP is used in the situation that two devices are in the same network segment but connected to different Layer 3 interfaces.

Choose the menu **L3 FEATURES > ARP > Proxy ARP > Proxy ARP** to load the following page.

Figure 2-4 Configuring Proxy ARP

Proxy ARP Config					
<input type="checkbox"/>	Index	IP Address	Subnet Mask	Interface	Status
<input type="checkbox"/>	1	192.168.0.1	255.255.255.0	VLAN1	Disabled
<input type="checkbox"/>	2	0.0.0.0	0.0.0.0	VLAN2	Disabled
<input type="checkbox"/>	3	192.168.2.1	255.255.255.0	VLAN10	Disabled
<input type="checkbox"/>	4	192.168.3.1	255.255.255.0	VLAN20	Disabled
<input type="checkbox"/>	5	0.0.0.0	0.0.0.0	Gi1/0/5	Disabled
Total: 5					

Select the desired interface and enable proxy ARP. Then click **Apply**.

IP Address	Displays the IP address of the Layer 3 interface
Subnet Mask	Displays the subnet mask of the Layer 3 interface.
Interface	Displays the ID of the Layer 3 interface.
Status	Enable or disable Proxy ARP function for the Layer 3 interface. The interface will respond the ARP request sender with its own MAC address.

2.1.5 Configuring Local Proxy ARP

Local Proxy ARP is used in the situation that two devices are in the same VLAN but isolated on the layer 2 ports.

Choose the menu **L3 FEATURES > ARP > Proxy ARP > Local Proxy ARP** to load the following page.

Figure 2-5 Configuring Local Proxy ARP

Local Proxy ARP Config					
<input type="checkbox"/>	Index	IP Address	Subnet Mask	Interface	Status
<input type="checkbox"/>	1	192.168.0.1	255.255.255.0	VLAN1	Disabled
<input type="checkbox"/>	2	0.0.0.0	0.0.0.0	VLAN2	Disabled
<input type="checkbox"/>	3	192.168.2.1	255.255.255.0	VLAN10	Disabled
<input type="checkbox"/>	4	192.168.3.1	255.255.255.0	VLAN20	Disabled
<input type="checkbox"/>	5	0.0.0.0	0.0.0.0	Gi1/0/5	Disabled
Total: 5					

Select the desired interface and enable local proxy ARP. Then click **Apply**.

IP Address	Displays the IP address of the Layer 3 interface
-------------------	--

Subnet Mask	Displays the subnet Mask of the Layer 3 interface.
Status	Enable or disable Local Proxy ARP function for the Layer 3 interface. The interface will respond the ARP request sender with its own MAC address.

2.2 Using the CLI

2.2.1 Configuring the ARP Entry

■ Adding Static ARP Entries

Follow these steps to add static ARP entries:

Step 1	configure Enter global configuration mode.
Step 2	arp ip mac type Add a static ARP entry. <i>ip</i> : Enter the IP address of the static ARP entry. <i>mac</i> : Enter the MAC address of the static ARP entry. <i>type</i> : Enter the ARP type. Configure it as 'arpa'.
Step 3	show arp [ip] [mac] <i>ip</i> : Specify the IP address of your desired ARP entry. <i>mac</i> : Specify the MAC address of your desired ARP entry.
Step 4	end Return to privileged EXEC mode.
Step 5	copy running-config startup-config Save the settings in the configuration file.

This example shows how to create a static ARP entry with the IP as 192.168.0.1 and the MAC as 00:11:22:33:44:55:

```
Switch#configure
```

```
Switch(config)#arp 192.168.0.1 00:11:22:33:44:55 arpa
```

```
Switch(config)#show arp 192.168.0.1
```

Interface	Address	Hardware Addr	Type
Vlan1	192.168.0.1	00:11:22:33:44:55	STATIC

```
Switch(config)#end
```

```
Switch#copy running-config startup-config
```

■ Configuring the Aging Time of Dynamic ARP Entries

Follow these steps to configure the aging time of dynamic ARP entries:

Step 1 **configure**

Enter global configuration mode.

Step 2 **arp timeout timeout**

Configure the ARP aging time of the VLAN interface or routed port .

timeout: Specify the value of aging time, which ranges from 1 to 3000 in seconds. The default value is 1200 seconds.

Step 3 **end**

Return to privileged EXEC mode.

Step 4 **copy running-config startup-config**

Save the settings in the configuration file.

This example shows how to configure the aging time of dynamic ARP entries as 1000 seconds:

```
Switch#configure
```

```
Switch(config)#arp timeout 1000
```

```
Switch(config)#end
```

```
Switch#copy running-config startup-config
```

■ Clearing Dynamic Entries

Step 1 **configure**

Enter global configuration mode.

Step 2 **clear arp-cache**

Clear all the dynamic ARP entries.

Step 3 **copy running-config startup-config**

Save the settings in the configuration file.

■ Renewing Dynamic ARP Entries Automatically

Step 1 **configure**

Enter global configuration mode.

Step 2 **arp dynamicrenew**
Enable the switch to automatically renew dynamic ARP entries. By default, it is enabled..

Step 3 **copy running-config startup-config**
Save the settings in the configuration file.

■ Viewing ARP Entries

On privileged EXEC mode or any other configuration mode, you can use the following command to view ARP entries:

show arp [*ip*] [*mac*]

ip: Specify the IP address of your desired ARP entry.

mac: Specify the MAC address of your desired ARP entry.

show ip arp { *fastEthernet port* | *gigabitEthernet port* | *ten-gigabitEthernet port* | *port-channel lagid* | *vlan vid* }

Verify the active ARP entries associated with a Layer 3 interface.

port: Specify the number of the routed port.

lagid: Specify the ID of the LAG.

vid: Specify the VLAN interface ID.

2.2.2 Configuring the Gratuitous ARP

■ Configuring Gratuitous ARP Globally

Follow these steps to add static ARP entries:

Step 1 **configure**
Enter global configuration mode.

Step 2 **gratuitous-arp intf-status-up enable**
Enable the Layer 3 interface to send a gratuitous ARP packet to detect if its IP address is used by other devices. It is enabled by default

Step 3 **gratuitous-arp dup-ip-detected enable**
(Optional) Enable the Layer 3 interface to send a gratuitous packet when the interface received a gratuitous ARP packet with the same IP address with its own. It is disabled by default.

Step 4 **gratuitous-arp learning enable**
(Optional) Enable the switch to learn MAC address entries from gratuitous ARP packets. Generally, the switch only learn MAC address entries form normal ARP packets. With this option enabled, the switch will also learn MAC address entries from gratuitous ARP packets. By default, it is disabled.

Step 5 **show gratuitous-arp**
Show the gratuitous ARP configuration.

Step 6 **end**
Return to privileged EXEC mode.

Step 7 **copy running-config startup-config**
Save the settings in the configuration file.

This example shows how to enable Send on IP Interface Status Up, Send on Duplicate IP Detected and Gratuitous ARP Learning features:

Switch#configure

Switch(config)#gratuitous-arp dup-ip-detected enable

Switch(config)#gratuitous-arp intf-status-up enable

Switch(config)#gratuitous-arp learning enable

Switch(config)#show gratuitous-arp

Send on IP interface Status up : Enabled

Send on Duplicate IP Detected : Enabled

Gratuitous ARP Learning : Enabled

Interface	Gratuitous ARP Periodical Send Interval
-----	-----

Gi1/0/18	0
----------	---

VLAN1	0
-------	---

Switch(config)#end

Switch#copy running-config startup-config

■ Configuring Interval of Sending Gratuitous ARP Packets

Follow these steps to configure gratuitous ARP packets for Layer 3 interfaces:

Step 1 **configure**
Enter global configuration mode.

There are three types of Layer 3 interface that are able to send gratuitous ARP packets: routed port, port-channel and VLAN interface.

interface {vlan vid | fastEthernet port | range fastEthernet port-list | gigabitEthernet port | range gigabitEthernet port-list | ten-gigabitEthernet port | range ten-gigabitEthernet port-list | port-channel port-channel | range port-channel port-channel-list }

no switch port

Step 2

Enter interface configuration mode and change the port or port-channel to be a Layer 3 interface.

Interface vlan vlan-id

Enter the vlan interface configuration mode.

vlan-id: Enter the interface VLAN ID.

Step 3

gratuitous-arp send-interval interval

Specify the periodical interval at which the interface sends the gratuitous ARP packet.

interval: Specify the interval in seconds. The valid value ranges from 0 to 65535. Value 0 means the interface does not periodically send gratuitous ARP packets.

Step 4

show gratuitous-arp

Show the gratuitous ARP configuration.

Step 5

end

Return to privileged EXEC mode.

Step 6

copy running-config startup-config

Save the settings in the configuration file.

This example shows how to configure the interval of sending gratuitous ARP packets for VLAN interface 1 as 10 seconds:

Switch#configure

Switch(config)#interface vlan 1

Switch(config-if)#gratuitous-arp send-interval 10

Switch(config-if)#show gratuitous-arp

...

Interface	Gratuitous ARP Periodical Send Interval
VLAN1	10

VLAN1 10

Switch(config-if)#end

Switch#copy running-config startup-config

2.2.3 Configuring Proxy ARP

You can configure proxy ARP and local proxy ARP.

■ Configuring Proxy ARP

Follow these steps to Proxy ARP on the VLAN interface, routed port or port channel.

Step 1	configure Enter global configuration mode.
Step 2	<p>There are three types of Layer 3 interface can be enabled with Proxy ARP: routed port, port-channel and VLAN interface.</p> <p>interface {vlan vid fastEthernet port range fastEthernet port-list gigabitEthernet port range gigabitEthernet port-list ten-gigabitEthernet port range ten-gigabitEthernet port-list port-channel port-channel range port-channel port-channel-list }</p> <p>no switch port</p> <p>Enter interface configuration mode and change the port or port-channel to be a Layer 3 interface.</p> <p>Interface vlan vlan-id Enter the vlan interface configuration mode.</p> <p><i>vlan-id</i>: Enter the interface VLAN ID.</p>
Step 3	ip proxy-arp Enable Proxy ARP function on the specified Layer 3 interface..
Step 4	show ip proxy-arp Show the Proxy ARP configuration..
Step 5	end Return to privileged EXEC mode.
Step 6	copy running-config startup-config Save the settings in the configuration file.

This example shows how to enable Proxy ARP function for VLAN interface 1:

```
Switch#configure
```

```
Switch(config)#interface vlan 1
```

```
Switch(config-if)#ip proxy-arp
```

```
Switch(config-if)#show ip proxy-arp
```

Interface	IP Address	IP Mask	Status
-----	-----	-----	-----
vlan 1	192.168.0.1	255.255.255.0	Enabled

```
Switch(config-if)#end
```

Switch#copy running-config startup-config

- **Configuring Local Proxy ARP**

Follow these steps to Local Proxy ARP on the VLAN interface, routed port or port channel.

Step 1	<p>configure</p> <p>Enter global configuration mode.</p>
Step 2	<p>There are three types of Layer 3 interface can be enabled with Local Proxy ARP: routed port, port-channel and VLAN interface.</p> <p>interface {vlan vid fastEthernet port range fastEthernet port-list gigabitEthernet port range gigabitEthernet port-list ten-gigabitEthernet port range ten-gigabitEthernet port-list port-channel port-channel range port-channel port-channel-list }</p> <p>no switch port</p> <p>Enter interface configuration mode and change the port or port-channel to be a Layer 3 interface.</p> <p>Interface vlan vlan-id</p> <p>Enter the vlan interface configuration mode.</p> <p><i>vlan-id</i>: Enter the interface VLAN ID.</p>
Step 3	<p>ip local-proxy-arp</p> <p>Enable Local Proxy ARP function on the specified Layer 3 interface..</p>
Step 4	<p>show ip local-proxy-arp</p> <p>Show the Local Proxy ARP configuration..</p>
Step 5	<p>end</p> <p>Return to privileged EXEC mode.</p>
Step 6	<p>copy running-config startup-config</p> <p>Save the settings in the configuration file.</p>

This example shows how to enable Local Proxy ARP function for VLAN interface 1:

Switch#configure

Switch(config)#interface vlan 1

Switch(config-if)#ip local-proxy-arp

Switch(config-if)#show ip local-proxy-arp

Interface	IP Address	IP Mask	Status
-----	-----	-----	-----
vlan 1	192.168.0.1	255.255.255.0	Enabled

Switch(config-if)#end

Switch#copy running-config startup-config

3 Appendix: Default Parameters

Default ARP settings are listed in the following tables.

Table 3-1 Default Gratuitous Settings

Parameter	Default Setting
Send on IP Interface Status Up	Enabled
Send on Duplicate IP Detected	Disabled
Gratuitous ARP Learning	Disabled
Gratuitous ARP Periodical Send Interval	0 second

Part 23

Configuring VRRP

CHAPTERS

1. Overview
2. VRRP Configuration
33. Appendix: Default Parameters

1 Overview

 **Note:**

VRRP is only available on certain devices. To check whether your device supports this feature, refer to the actual web interface. If VRRP is available, there is **L3 FEATURES > VRRP** in the menu structure.

VRRP (Virtual Routing Redundancy Protocol) is a function on the switch that dynamically assigns responsibility for a virtual router to one of the VRRP routers on a LAN. The VRRP router that controls the IP address associated with a virtual router is called the Master and will forward packets sent to this IP address. This will allow any Virtual Router IP address on the LAN to be used as the default first hop router by end hosts.

2 VRRP Configuration

2.1 Using the CLI

2.1.1 Configuring VRRP on Specified Ports

Follow these steps to configure VRRP on specified ports:

Step 1	configure Enter global configuration mode.
Step 2	interface {vlan vid fastEthernet port gigabitEthernet port ten-gigabitEthernet port port-channel port-channel I} Enter interface configuration mode.
Step 3	ip vrrp vrid vrid-index Enable the VRRP-V2 protocol on the interface and specify the virtual router ID for it. To disable the protocol on the interface, use the <code>no ip vrrp vrid</code> command. <i>vrid-index</i> : Virtual router ID, ranging from 1 to 255.
Step 4	ipv6 vrrp vrid vrid-index Enable the VRRP-V3 protocol on the interface and specify the virtual router ID for it. To disable the protocol on the interface, use the <code>no ipv6 vrrp vrid</code> command. <i>vrid-index</i> : Virtual router ID, ranging from 1 to 255.
Step 5	ip vrrp vrid vrid-index authentication-mod {simple md5} password Configure the authentication mode of the virtual router on the specified interface. To restore to the default authentication mode, use the <code>no ip vrrp vrid authentication-mode</code> command. <i>vrid-index</i> : Virtual router ID, ranging from 1 to 255. <i>simple md5</i> : Authentication mode, by default it is None and no authentication will be performed. "simple" refers to using a text password for authentication, and "md5" refers to using a text password to perform the authentication of MD5, which has a higher security than Simple mode. <i>password</i> : Password, a string of 1 to 8 alphabets, numbers or symbols. Passwords are case-sensitive, spaces allowed but leading spaces ignored, and cannot contain question marks. Empty by default.

-
- Step 6 **ip vrrp vrid vrid-index description description**
- Configure and modify the description for the virtual router. To delete the description, use the no ip vrrp vrid description command.
- vrid-index*: Virtual router ID, ranging from 1 to 255.
- description*: A string describing the virtual router, containing up to 256 characters, consisting only of numbers, English letters, and dashes.
-
- Step 7 **ip vrrp vrid vrid-index preempt-mode [timer-delay delay-value]**
- Configure the preemption mode and delay time of the specified virtual router on the interface. To set the specified virtual router on the interface to non-preempt mode, use the no ip vrrp vrid preempt-mode command. By default, the virtual router is in preempt mode.
- vrid-index*: Virtual router ID, ranging from 1 to 255.
- delay-value*: When the current primary router is deemed unavailable, the backup router waits before switching to the primary router. The value ranges from 0 to 255 seconds, and the default is 0.
-
- Step 8 **ip vrrp vrid vrid-index priority priority**
- Configure the priority of the specified virtual router on the interface. To restore the default priority, use the no ip vrrp vrid priority command.
- vrid-index*: Virtual router ID, ranging from 1 to 255.
- priority*: Priority, value ranges from 1 to 254. The default priority is 100
-
- Step 9 **ip vrrp vrid vrid-index timer-advertise adver-interval**
- Configure the frequency at which the specified virtual router sends advertisements on the interface. To restore the default advertisement interval, use the no ip vrrp vrid timer-advertise command.
- vrid-index*: Virtual router ID, ranging from 1 to 255.
- adver-interval*: Advertisement interval, for VRRP-V2, the value range is 1~255, the unit is seconds, the default is 1 second; for VRRP-V3, the value range is 100~4095, the unit is centiseconds, the default is 100 centiseconds.
-
- Step 10 **ip vrrp vrid vrid-index track interface {{fastEthernet | gigabitEthernet | hundred-gigabitEthernet | ten-gigabitEthernet | twentyFive-gigabitEthernet | two-gigabitEthernet } port / port-channel portchannel-id / vlan vlan-id} [reduce-priority priority]**
- Configure the specified virtual router on the interface to add a tracking interface. To delete the tracking interface, use the no ip vrrp vrid track interface command.
- port*: Port number.
- portchannel-id*: LAG group number.
- vrid-index*: Virtual router ID, ranging from 1 to 255.
- priority*: Decreasing priority of the tracked interface, ranging from 1 to 254, and the default is 10
-

Step 11 **ip vrrp vrid vrid-index version vrrp-version**

Configure or switch the VRRP version of the specified virtual router on the interface. The default is VRRP-V2.

vrid-index: Virtual router ID, ranging from 1 to 255.

vrrp-version: VRRP protocol version, the value is 2 or 3. Due to the differences between VRRP-V2 and VRRP-V3, version switching is only allowed when authentication is not configured, ipv6 virtual address is not configured, and the default notification time is used.

Step 12 **ip vrrp vrid vrid-index virtual-ip virtual-ip**

Add a primary virtual IPv4 address to a virtual router. Each virtual router has only one primary virtual IP that cannot be deleted. If the virtual router does not exist, a VRRP-V2 version of the virtual router will be automatically created.

vrid-index: Virtual router ID, ranging from 1 to 255.

virtual-ip: The virtual IP address of the virtual router, which must be in the same network segment as the interface.

Step 13 **ip vrrp vrid vrid-index virtual-ip virtual-ip secondary**

Add a secondary virtual IPv4 address to a virtual router. Each virtual router can be configured with up to 32 IP addresses. To delete the corresponding secondary virtual IP address, use the no ip vrrp vrid virtual-ip secondary command.

vrid-index: Virtual router ID, ranging from 1 to 255.

virtual-ip: The virtual IP address of the virtual router, which must be in the same network segment as the interface.

Step 14 **ipv6 vrrp vrid vrid-index address virtual-linklocal link-local**

Add a virtual ipv6 local link address to a virtual router. Each virtual router has only one virtual link-local address. If the virtual router does not exist, a VRRP-V3 version of the virtual router will be automatically created. To delete the virtual link-local address, use the no ipv6 vrrp vrid address link-local command.

vrid-index: Virtual router ID, ranging from 1 to 255.

virtual-linklocal: The virtual link-local address of the virtual router. The address prefix should be the fe80::/10 standard ipv6 address.

Step 15 **ipv6 vrrp vrid vrid-index address virtual-ipv6**

Add a virtual ipv6 address to a virtual router. Each virtual router can be configured with up to 32 ipv6 addresses. To delete the virtual address, use the no ipv6 vrrp vrid address command.

vrid-index: Virtual router ID, ranging from 1 to 255.

virtual-ipv6: The global ipv6 address of the virtual router, which must be in the same network segment as the interface ipv6 address.

-
- Step 16 **show ip vrrp [vrid vrid-index] [interface {{fastEthernet | gigabitEthernet | hundred-gigabitEthernet | ten-gigabitEthernet | twentyFive-gigabitEthernet | two-gigabitEthernet } port / port-channel portchannel-id / vlan vlan-id}]**
- Display basic configuration information of all virtual routers or a specified virtual router.
- vrid-index*: Virtual router ID, ranging from 1 to 255.
- fastEthernet | gigabitEthernet | hundred-gigabitEthernet | ten-gigabitEthernet | twentyFive-gigabitEthernet | two-gigabitEthernet*: Port type, which must be a layer 3 interface.
- port*: Port number.
- portchannel-id*: LAG group number.
- vlan-id*: VLAN value
-
- Step 17 **show ip vrrp statistics [vrid vrid-index] [interface {{fastEthernet | gigabitEthernet | hundred-gigabitEthernet | ten-gigabitEthernet | twentyFive-gigabitEthernet | two-gigabitEthernet } port / port-channel portchannel-id / vlan vlan-id}]**
- Display statistics for all virtual routers or a specified virtual router.
- vrid-index*: Virtual router ID, ranging from 1 to 255.
- fastEthernet | gigabitEthernet | hundred-gigabitEthernet | ten-gigabitEthernet | twentyFive-gigabitEthernet | two-gigabitEthernet*: Port type, which must be a layer 3 interface.
- port*: Port number.
- portchannel-id*: LAG group number.
- vlan-id*: VLAN value
-
- Step 18 **end**
- Return to privileged EXEC mode.
-
- Step 19 **copy running-config startup-config**
- Save the settings in the configuration file.
-
- Step 20 **clear ip vrrp statistics**
- Clear the statistics of all virtual routers on the switch.
-

The following example shows how to configure VRRP on a specified port.

Switch#configure

Switch(config)#interface vlan 2

Switch(config-if)#ip vrrp vrid 5

Switch(config-if)#ip vrrp vrid 5 authentication-mode md5 123

Switch(config-if)#ip vrrp vrid 5 description vr5

Switch(config-if)#ip vrrp vrid 5 preempt-mode timer-delay 12

Switch(config-if)#ip vrrp vrid 5 priority 110

Switch(config-if)#ip vrrp vrid 5 timer-advertise 12

```
Switch(config-if)#ip vrrp vrid 5 track interface vlan 3 reduce-priority 20
```

```
Switch(config-if)#ip vrrp vrid 5 version 3
```

```
Switch(config-if)#ip vrrp vrid 5 virtual-ip 192.168.0.10
```

```
Switch(config-if)#ip vrrp vrid 5 virtual-ip 192.168.0.11 secondary
```

```
Switch(config-if)#ipv6 vrrp vrid 5 address fe80::10 link-local
```

```
Switch(config-if)#ipv6 vrrp vrid 5 address 3001::1
```

```
Switch(config-if)#show ip vrrp vrid 5 interface vlan 2
```

```
Interface:          VLAN2
```

```
VRID:              5
```

```
Version:           2
```

```
Description:       vr5
```

```
Interface IP(v4):
```

```
Interface Link-Local IP(v6): fe80::5ee9:31ff:fe43:31fa
```

```
...
```

```
Switch(config-if)#end
```

```
Switch#copy running-config startup-config
```

```
Switch#clear ip vrrp statistics
```

3 Appendix: Default Parameters

Default settings of VRRP are listed in the following tables.

Table 3-1 Default Settings of VRRP

Parameter	Default Setting
Description	N/A
Priority	100
Advertise Timer	100
Preempt Mode	Enable
Delay Time	0
Authentication	None
Key	N/A
adver-interval (VRRP-V2)	1
adver-interval (VRRP-V3)	100
track priority	10
vrrp-version	VRRP-V2

Part 24

Configuring QoS

CHAPTERS

1. QoS
2. Class of Service Configuration
3. Bandwidth Control Configuration
4. Voice VLAN Configuration
5. Auto VoIP Configuration
6. Configuration Examples
7. Appendix: Default Parameters

1 QoS

1.1 Overview

With network scale expanding and applications developing, internet traffic is dramatically increased, thus resulting in network congestion, packet drops and long transmission delay. Typically, networks treat all traffic equally on FIFO (First In First Out) delivery basis, but nowadays many special applications like VoD, video conferences, VoIP, etc, require more bandwidth or shorter transmission delay to guarantee the performance.

With QoS (Quality of Service) technology, you can classify and prioritize network traffic to provide differentiated services to certain types of traffic.

1.2 Supported Features

You can configure the class of service, bandwidth control, Voice VLAN and Auto VoIP features on the switch to maximize the network performance and bandwidth utilization.

Class of Service

The switch classifies the ingress packets, maps the packets to different priority queues and then forwards the packets according to specified scheduler settings to implement QoS function.

- Priority Mode: Three modes are supported, Port Priority, 802.1p Priority and DSCP Priority.
- Scheduler Mode: Two scheduler types are supported, Strict and Weighted.

Bandwidth Control

Bandwidth Control functions to control the traffic rate and traffic threshold on each port to ensure network performance.

- Rate limit functions to limit the ingress/egress traffic rate on each port. In this way, the network bandwidth can be reasonably distributed and utilized.
- Storm Control function allows the switch to monitor broadcast packets, multicast packets and UL-frames (Unknown unicast frames) in the network. If the transmission rate of the packets exceeds the set rate, the packets will be automatically discarded to avoid network broadcast storm.

Voice VLAN and Auto VoIP

The voice VLAN and Auto VoIP features are used to prioritize the transmission of voice traffic. Voice traffic is typically more time-sensitive than data traffic, and the voice quality

can deteriorate a lot because of packet loss and delay. To ensure the high voice quality, you can configure Voice VLAN or Auto VoIP.

These two features can be enabled on the ports that transmit voice traffic only or transmit both voice traffic and data traffic. Voice VLAN can change the voice packets' 802.1p priority and transmit the packets in desired VLAN. Auto VoIP can inform the voice devices of send the packets with specific configuration by working with the LLDP-MED feature.

2 Class of Service Configuration

With class of service configurations, you can:

- Configure port priority
- Configure 802.1p priority
- Configure DSCP priority
- Specify the scheduler settings

Configuration Guidelines

- Select the priority mode that the ports trust according to your network requirements.
A port can use only one priority to classify the ingress packets. Three priority modes are supported on the switch: Port Priority, 802.1P Priority and DSCP Priority.
 - Port Priority
In this mode, the switch prioritizes packets according to their ingress ports, regardless of the packet field or type.
 - 802.1P Priority
802.1P defines the first three bits in 802.1Q Tag as PRI field. The PRI values are from 0 to 7. 802.1P priority determines the priority of packets based on the PRI value.
In this mode, the switch only prioritizes packets with VLAN tag, regardless of the IP header of the packets.
 - DSCP Priority
DSCP priority determines the priority of packets based on the ToS (Type of Service) field in their IP header. RFC2474 re-defines the ToS field in the IP packet header as DS field. The first six bits (bit 0-bit 5) of the DS field is used to represent DSCP priority. The DSCP values are from 0 to 63.
In this mode, the switch only prioritizes IP packets.
- Specify the 802.1p to queue mapping according to your needs.
For 802.1p Priority, the packets will be forwarded according to the 802.1p to queue mapping directly.
For Port Priority and DSCP Priority, the port priority and DSCP priority will first be mapped to the 802.1p priority, and then mapped to the queue according to the 802.1p to queue mapping.

2.1 Using the GUI

2.1.1 Configuring Port Priority

- **Configuring the Trust Mode and Port to 802.1p Mapping**

Choose the menu **QoS > Class of Service > Port Priority** to load the following page.

Figure 2-1 Configuring the Trust Mode and Port to 802.1p Mapping

Port Priority Config				
UNIT1		LAGS		
<input type="checkbox"/>	Port	802.1p Priority	Trust Mode	LAG
<input type="checkbox"/>	1/0/1	0	Untrusted	--
<input type="checkbox"/>	1/0/2	0	Untrusted	--
<input type="checkbox"/>	1/0/3	0	Untrusted	--
<input type="checkbox"/>	1/0/4	0	Untrusted	--
<input type="checkbox"/>	1/0/5	0	Untrusted	--
<input type="checkbox"/>	1/0/6	0	Untrusted	--
<input type="checkbox"/>	1/0/7	0	Untrusted	--
<input type="checkbox"/>	1/0/8	0	Untrusted	--
<input type="checkbox"/>	1/0/9	0	Untrusted	--
<input type="checkbox"/>	1/0/10	0	Untrusted	--
Total: 54				

Follow these steps to configure the parameters of the port priority:

- 1) Select the desired ports, specify the 802.1p priority and set the trust mode as Untrusted.

802.1p Priority	Specify the port to 802.1p priority mapping for the desired port. The ingress packets are first mapped to 802.1p priority, then to TC queues according to the 802.1p to queue mappings. The untagged packets from one port will be added an 802.1p priority value according to the port to 802.1p priority mapping.
Trust Mode	Select the Trust mode for the desired port. The switch will process the ingress packets according to the trusted priority mode. Untrusted: In this mode, the packets will be processed according to the port priority configuration. Trust 802.1p: In this mode, the packets will be processed according to the 802.1p priority configuration. Trust DSCP: In this mode, the packets will be processed according to the DSCP priority configuration.
LAG	Displays the LAG that the port belongs to.

- 2) Click **Apply**.

■ Configuring the 802.1p to Queue Mapping

Choose the menu **QoS > Class of Service > 802.1p Priority** to load the following page.

Figure 2-2 Configuring the 802.1p to Queue Mapping

802.1p to Queue Mapping

802.1p Priority	Queue
0:	<input type="text" value="TC-1"/>
1:	<input type="text" value="TC-0"/>
2:	<input type="text" value="TC-2"/>
3:	<input type="text" value="TC-3"/>
4:	<input type="text" value="TC-4"/>
5:	<input type="text" value="TC-5"/>
6:	<input type="text" value="TC-6"/>
7:	<input type="text" value="TC-7"/>

802.1p Remap

802.1p Priority	Remap
0:	<input type="text" value="0"/>
1:	<input type="text" value="1"/>
2:	<input type="text" value="2"/>
3:	<input type="text" value="3"/>
4:	<input type="text" value="4"/>
5:	<input type="text" value="5"/>
6:	<input type="text" value="6"/>
7:	<input type="text" value="7"/>

In the **802.1p to Queue Mapping** section, configure the mappings and click **Apply**.

802.1p Priority

Displays the number of 802.1p priority. In QoS, 802.1p priority is used to represent class of service.

Queue

Select the TC queue for the desired 802.1p priority. The packets with the desired 802.1p priority will be put in the corresponding queue.

2.1.2 Configuring 802.1p Priority

■ Configuring the Trust Mode

Choose the menu **QoS > Class of Service > Port Priority** to load the following page.

Figure 2-3 Configuring the Trust Mode

Port Priority Config				
UNIT1		LAGS		
<input type="checkbox"/>	Port	802.1p Priority	Trust Mode	LAG
<input type="checkbox"/>	1/0/1	0	Untrusted	--
<input type="checkbox"/>	1/0/2	0	Untrusted	--
<input type="checkbox"/>	1/0/3	0	Untrusted	--
<input type="checkbox"/>	1/0/4	0	Untrusted	--
<input type="checkbox"/>	1/0/5	0	Untrusted	--
<input type="checkbox"/>	1/0/6	0	Untrusted	--
<input type="checkbox"/>	1/0/7	0	Untrusted	--
<input type="checkbox"/>	1/0/8	0	Untrusted	--
<input type="checkbox"/>	1/0/9	0	Untrusted	--
<input type="checkbox"/>	1/0/10	0	Untrusted	--
Total: 54				

Follow these steps to configure the trust mode:

- 1) Select the desired ports and set the trust mode as Trust 802.1p.

Trust Mode

Select the Trust mode for the desired port. The switch will process the ingress packets according to the trusted priority mode.

Untrusted: In this mode, the packets will be processed according to the port priority configuration.

Trust 802.1p: In this mode, the packets will be processed according to the 802.1p priority configuration.

Trust DSCP: In this mode, the packets will be processed according to the DSCP priority configuration.

- 2) Click **Apply**.

■ **Configuring the 802.1p to Queue Mapping and 802.1p Remap**

For Certain Devices:

Choose the menu **QoS > Class of Service > 802.1p Priority** to load the following page.

Figure 2-4 Configuring the 802.1p to Queue Mapping and 802.1p Remap

802.1p to Queue Mapping

802.1p Priority	Queue
0:	<input type="text" value="TC-0"/>
1:	<input type="text" value="TC-1"/>
2:	<input type="text" value="TC-2"/>
3:	<input type="text" value="TC-3"/>
4:	<input type="text" value="TC-4"/>
5:	<input type="text" value="TC-5"/>
6:	<input type="text" value="TC-6"/>
7:	<input type="text" value="TC-7"/>

802.1p Remap

UNIT1

LAGS

	Port	0	1	2	3	4	5	6	7	LAG
<input checked="" type="checkbox"/>	1/0/1	0	1	2	3	4	5	6	7	--
<input type="checkbox"/>	1/0/2	0	1	2	3	4	5	6	7	--
<input type="checkbox"/>	1/0/3	0	1	2	3	4	5	6	7	--
<input type="checkbox"/>	1/0/4	0	1	2	3	4	5	6	7	--
<input type="checkbox"/>	1/0/5	0	1	2	3	4	5	6	7	--
<input type="checkbox"/>	1/0/6	0	1	2	3	4	5	6	7	--
<input type="checkbox"/>	1/0/7	0	1	2	3	4	5	6	7	--
<input type="checkbox"/>	1/0/8	0	1	2	3	4	5	6	7	--
<input type="checkbox"/>	1/0/9	0	1	2	3	4	5	6	7	--
<input type="checkbox"/>	1/0/10	0	1	2	3	4	5	6	7	--

Follow these steps to configure the parameters of the 802.1p priority:

- 1) In the **802.1p to Queue Mapping** section, configure the mappings and click **Apply**.

802.1p Priority	Displays the number of 802.1p priority. In QoS, 802.1p priority is used to represent class of service. IEEE 802.1p standard defines three bits in 802.1Q tag as PRI field. The PRI values are called 802.1p priority and used to represent the priority of the layer 2 packets. This function requires packets with VLAN tags.
Queue	Select the TC queue for the desired 802.1p priority. The packets with the desired 802.1p priority will be put in the corresponding queue.

- 2) (Optional) In the **802.1p Remap** section, configure the 802.1p to 802.1p mappings for ports and click **Apply**.

0 - 7

Select the number of 802.1p priority to which the desired 802.1p priority will be remapped. 802.1p Remap is used to modify the 802.1p priority of the ingress packets. When the switch detects the packets with desired 802.1p priority, it will modify the value of 802.1p priority according to the map.

For Certain Devices:

Choose the menu **QoS > Class of Service > 802.1p Priority** to load the following page.

Figure 2-5 Configuring the 802.1p to Queue Mapping and 802.1p Remap

802.1p to Queue Mapping

802.1p Priority	Queue
0:	<input type="text" value="TC-1"/>
1:	<input type="text" value="TC-0"/>
2:	<input type="text" value="TC-2"/>
3:	<input type="text" value="TC-3"/>
4:	<input type="text" value="TC-4"/>
5:	<input type="text" value="TC-5"/>
6:	<input type="text" value="TC-6"/>
7:	<input type="text" value="TC-7"/>

802.1p Remap

802.1p Priority	Remap
0:	<input type="text" value="0"/>
1:	<input type="text" value="1"/>
2:	<input type="text" value="2"/>
3:	<input type="text" value="3"/>
4:	<input type="text" value="4"/>
5:	<input type="text" value="5"/>
6:	<input type="text" value="6"/>
7:	<input type="text" value="7"/>

Follow these steps to configure the parameters of the 802.1p priority:

- 1) In the **802.1p to Queue Mapping** section, configure the mappings and click **Apply**.

802.1p Priority

Displays the number of 802.1p priority. In QoS, 802.1p priority is used to represent class of service. IEEE 802.1p standard defines three bits in 802.1Q tag as PRI field. The PRI values are called 802.1p priority and used to represent the priority of the layer 2 packets. This function requires packets with VLAN tags.

Queue Select the TC queue for the desired 802.1p priority. The packets with the desired 802.1p priority will be put in the corresponding queue.

- 2) (Optional) In the **802.1p Remap** section, configure the 802.1p to 802.1p mappings and click **Apply**.

802.1p Priority Displays the number of 802.1p priority. In QoS, 802.1p priority is used to represent class of service. IEEE 802.1p standard defines three bits in 802.1Q tag as PRI field. The PRI values are called 802.1p priority and used to represent the priority of the layer 2 packets. This function requires packets with VLAN tags.

Remap Select the number of 802.1p priority to which the original 802.1p priority will be remapped. 802.1p Remap is used to modify the 802.1p priority of the ingress packets. When the switch detects the packets with desired 802.1p priority, it will modify the value of 802.1p priority according to the map.

 **Note:**

In Trust 802.1p mode, the untagged packets will be added an 802.1p priority based on the port to 802.1p mapping and will be forwarded according to the 802.1p to queue mapping.

2.1.3 Configuring DSCP Priority

■ **Configuring the Trust Mode**

Choose the menu **QoS > Class of Service > Port Priority** to load the following page.

Figure 2-6 Configuring the Trust Mode

Port Priority Config				
UNIT1		LAGS		
<input type="checkbox"/>	Port	802.1p Priority	Trust Mode	LAG
<input type="checkbox"/>	1/0/1	0	Untrusted	--
<input type="checkbox"/>	1/0/2	0	Untrusted	--
<input type="checkbox"/>	1/0/3	0	Untrusted	--
<input type="checkbox"/>	1/0/4	0	Untrusted	--
<input type="checkbox"/>	1/0/5	0	Untrusted	--
<input type="checkbox"/>	1/0/6	0	Untrusted	--
<input type="checkbox"/>	1/0/7	0	Untrusted	--
<input type="checkbox"/>	1/0/8	0	Untrusted	--
<input type="checkbox"/>	1/0/9	0	Untrusted	--
<input type="checkbox"/>	1/0/10	0	Untrusted	--
Total: 54				

Follow these steps to configure the trust mode:

- 1) Select the desired ports and set the trust mode as Trust DSCP.

Trust Mode Select the Trust mode for the desired port. The switch will process the ingress packets according to the trusted priority mode.

Untrusted: In this mode, the packets will be processed according to the port priority configuration.

Trust 802.1p: In this mode, the packets will be processed according to the 802.1p priority configuration.

Trust DSCP: In this mode, the packets will be processed according to the DSCP priority configuration.

2) Click **Apply**.

■ **Configuring the 802.1p to Queue Mapping**

Choose the menu **QoS > Class of Service > 802.1p Priority** to load the following page.

Figure 2-7 Configuring the 802.1p to Queue Mapping

802.1p to Queue Mapping

802.1p Priority	Queue
0:	<input type="text" value="TC-1"/>
1:	<input type="text" value="TC-0"/>
2:	<input type="text" value="TC-2"/>
3:	<input type="text" value="TC-3"/>
4:	<input type="text" value="TC-4"/>
5:	<input type="text" value="TC-5"/>
6:	<input type="text" value="TC-6"/>
7:	<input type="text" value="TC-7"/>

Apply

802.1p Remap

802.1p Priority	Remap
0:	<input type="text" value="0"/>
1:	<input type="text" value="1"/>
2:	<input type="text" value="2"/>
3:	<input type="text" value="3"/>
4:	<input type="text" value="4"/>
5:	<input type="text" value="5"/>
6:	<input type="text" value="6"/>
7:	<input type="text" value="7"/>

Apply

In the **802.1p to Queue Mapping** section, configure the mappings and click **Apply**.

802.1p Priority Displays the number of 802.1p priority. In QoS, 802.1p priority is used to represent class of service.

Queue Select the TC queue for the desired 802.1p priority. The packets with the desired 802.1p priority will be put in the corresponding queue.

■ **Configuring the DSCP to 802.1p Mapping and the DSCP Remap**

For Certain Devices:

Choose the menu **QoS > Class of Service > DSCP Priority** to load the following page.

Figure 2-8 Configuring the DSCP to 802.1p Mapping and the DSCP Remap

<input type="checkbox"/>	DSCP Priority	802.1p Priority	DSCP Remap
<input checked="" type="checkbox"/>	0	0	0 be (000000)
<input type="checkbox"/>	1	0	1
<input type="checkbox"/>	2	0	2
<input type="checkbox"/>	3	0	3
<input type="checkbox"/>	4	0	4
<input type="checkbox"/>	5	0	5
<input type="checkbox"/>	6	0	6
<input type="checkbox"/>	7	0	7
<input type="checkbox"/>	8	1	8 cs1 (001000)
<input type="checkbox"/>	9	1	9

Total: 64 1 entry selected. Cancel Apply

Follow these steps to configure the DSCP Priority:

- 1) Select the desired port, configure the DSCP to 802.1p mapping and the DSCP remap.

DSCP Priority	Displays the number of DSCP priority. DSCP Priority is used to classify the packets based on the value of DSCP, and map them to different queues. ToS (Type of Service) is a part of IP header, and DSCP uses the first six bits of ToS to represent the priority of IP packets. The DSCP values range from 0 to 63.
802.1p Priority	Specify the DSCP to 802.1p mapping for the desired port. The ingress packets are first mapped to 802.1p priority, then to TC queues according to the 802.1p to queue mappings.
DSCP Remap	(Optional) Select the DSCP priority to which the desired DSCP priority will be remapped for the port. When the switch detects the packets with desired DSCP value, it will modify the packets' DSCP value according to the map.

- 2) Click **Apply**.

For Certain Devices:

Choose the menu **QoS > Class of Service > DSCP Priority** to load the following page.

Figure 2-9 Configuring the DSCP to 802.1p Mapping and the DSCP Remap

<input type="checkbox"/>	DSCP Priority	802.1p Priority	DSCP Remap
<input checked="" type="checkbox"/>	0	0	0 be (000000)
<input type="checkbox"/>	1	0	1
<input type="checkbox"/>	2	0	2
<input type="checkbox"/>	3	0	3
<input type="checkbox"/>	4	0	4
<input type="checkbox"/>	5	0	5
<input type="checkbox"/>	6	0	6
<input type="checkbox"/>	7	0	7
<input type="checkbox"/>	8	1	8 cs1 (001000)
<input type="checkbox"/>	9	1	9

Total: 64 1 entry selected. Cancel Apply

Follow these steps to configure the DSCP Priority:

- 1) In the **DSCP Priority Config** section, configure the DSCP to 802.1p mapping and the DSCP remap.

DSCP Priority	Displays the number of DSCP priority. DSCP Priority is used to classify the packets based on the value of DSCP, and map them to different queues. ToS (Type of Service) is a part of IP header, and DSCP uses the first six bits of ToS to represent the priority of IP packets. The DSCP values range from 0 to 63.
802.1p Priority	Specify the DSCP to 802.1p mapping for the desired port. The ingress packets are first mapped to 802.1p priority, then to TC queues according to the 802.1p to queue mappings.
DSCP Remap	(Optional) Select the DSCP priority to which the desired DSCP priority will be remapped for the port. When the switch detects the packets with desired DSCP value, it will modify the packets' DSCP value according to the map.

- 2) Click **Apply**.

 **Note:**

In Trust DSCP mode, non-IP packets will be added an 802.1p priority based on the port to 802.1p mapping and will be forwarded according to the 802.1p to queue mapping.

2.1.4 Specifying the Scheduler Settings

Specify the scheduler settings to control the forwarding sequence of different TC queues when congestion occurs.

For Certain Devices:

Choose the menu **QoS > Class of Service > Scheduler Settings** to load the following page.

Figure 2-10 Specifying the Scheduler Settings

<input type="checkbox"/>	Queue TC-id	Scheduler Type	Queue Weight	Management Type
<input type="checkbox"/>	0	Weighted	1	Taildrop
<input type="checkbox"/>	1	Weighted	1	Taildrop
<input type="checkbox"/>	2	Weighted	1	Taildrop
<input type="checkbox"/>	3	Weighted	1	Taildrop
<input type="checkbox"/>	4	Weighted	1	Taildrop
<input type="checkbox"/>	5	Weighted	1	Taildrop
<input type="checkbox"/>	6	Weighted	1	Taildrop
<input type="checkbox"/>	7	Weighted	1	Taildrop
Total: 8				

Follow these steps to configure the schedule mode:

- 1) In the **Scheduler Config** section, select the desired port.
- 2) Select the desired queue and configure the parameters.

Queue TC-id	Displays the ID number of priority Queue.
Scheduler Type	<p>Select the type of scheduling used for corresponding queue. When the network congestion occurs, the port will determine the forwarding sequence of the packets according to the type.</p> <p>Strict: In this mode, the switch will use SP (Strict Priority) to process the traffic in different queues. When congestion occurs, the traffic will be transmitted according to its queue priority strictly. The queue with higher priority occupies the whole bandwidth. Packets in the queue with lower priority are sent only when the queue with higher priority is empty.</p> <p>Weighted: In this mode, the switch will use WRR (Weighted Round Robin) to process the traffic in different queues. When congestion occurs, all the traffic will be transmitted, but the bandwidth that each traffic queue occupies will be allocated based on the queue weight.</p> <p>Note: If the two scheduler types are both applied to a port, the queues in Strict mode will take precedence.</p>
Queue Weight	Specify the queue weight for the desired queue. This value can be set only in the Weighted mode. The valid values are from 1 to 127.
Management Type	Displays the Management Type for the queues. The switch currently supports Taildrop mode. When the traffic exceeds the limit, the additional traffic will be dropped.

- 3) Click **Apply**.

For Certain Devices:

Choose the menu **QoS > Class of Service > Scheduler Settings** to load the following page.

Figure 2-11 Specifying the Scheduler Settings

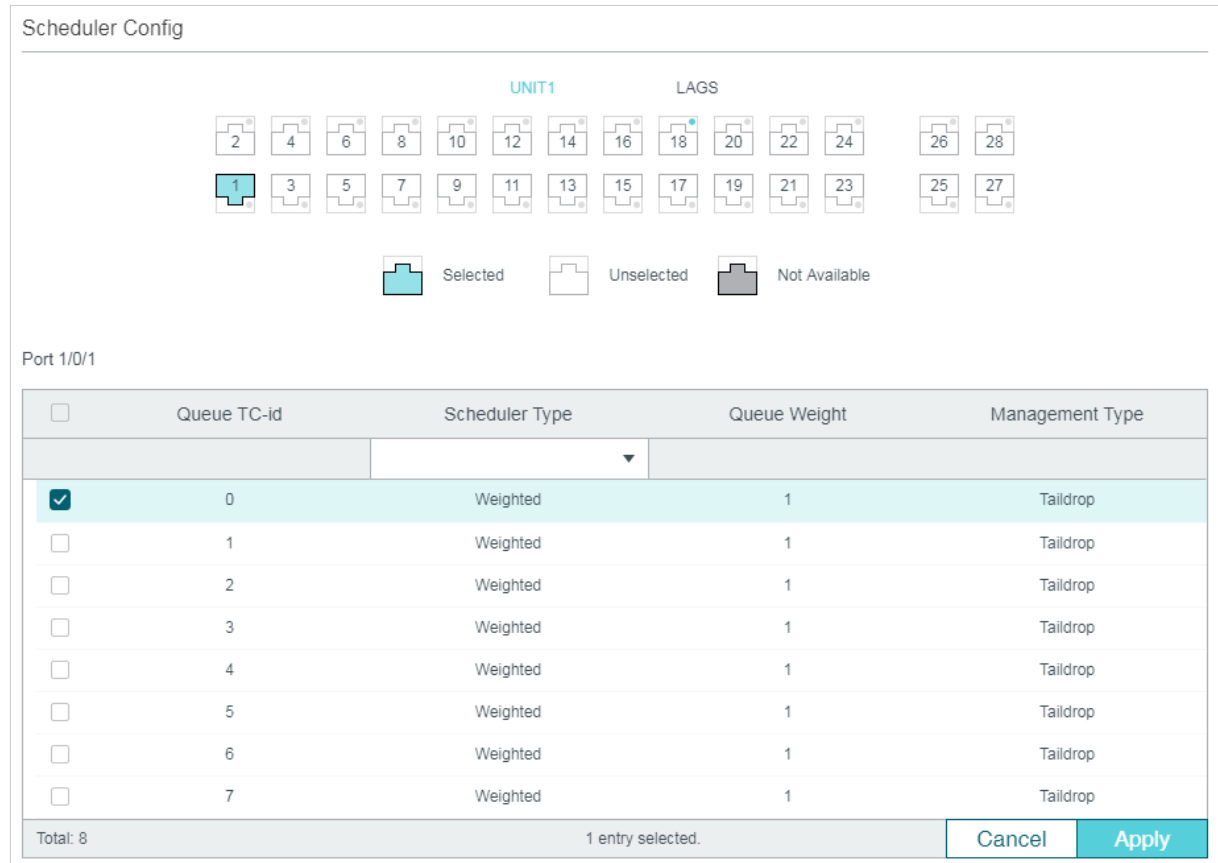

Follow these steps to configure the schedule mode:

- 1) In the **Scheduler Config** section, select the desired queue and configure the parameters.

Queue TC-id Displays the ID number of priority Queue.

Scheduler Type Select the type of scheduling used for corresponding queue. When the network congestion occurs, the port will determine the forwarding sequence of the packets according to the type.

Strict: In this mode, the switch will use SP (Strict Priority) to process the traffic in different queues. When congestion occurs, the traffic will be transmitted according to its queue priority strictly. The queue with higher priority occupies the whole bandwidth. Packets in the queue with lower priority are sent only when the queue with higher priority is empty.

Weighted: In this mode, the switch will use WRR (Weighted Round Robin) to process the traffic in different queues. When congestion occurs, all the traffic will be transmitted, but the bandwidth that each traffic queue occupies will be allocated based on the queue weight.

Note: If the two scheduler types are both applied to a port, the queues in Strict mode will take precedence.

Queue Weight	Specify the queue weight for the desired queue. This value can be set only in the Weighted mode. The valid values are from 1 to 127.
Management Type	Displays the Management Type for the queues. The switch currently supports Taildrop mode. When the traffic exceeds the limit, the additional traffic will be dropped.

2) Click **Apply**.

 **Note:**

With ACL Redirect feature, the switch maps all the packets that meet the configured ACL rules to the new TC queue, regardless of the mapping relations configured in this section.

2.2 Using CLI

2.2.1 Configuring Port Priority

■ Configuring the Trust Mode and the port to 802.1p Mapping

Follow these steps to configure the trust mode and the port to 802.1p mapping:

Step 1	configure Enter global configuration mode
Step 2	interface {fastEthernet port range fastEthernet port-list gigabitEthernet port range gigabitEthernet port-list ten-gigabitEthernet port range ten-gigabitEthernet port-list port-channel port-channel-id range port-channel port-channel-list} Enter interface configuration mode.
Step 3	qos trust mode {untrust dot1p dscp} Select the trust mode for the port. By default, it is untrust. Here we set the trust mode as untrust. <i>untrust:</i> Specify the ports' trust mode as untrust. In this mode, the packets will be processed according to the port priority configuration.
Step 4	qos port-priority {dot1p-priority} Specify the port to 802.1p priority mapping for the desired port. The ingress packets from one port are first mapped to 802.1p priority based on the port to 802.1p mapping, then to TC queues based on the 802.1p to queue mapping. The untagged packets from one port will be added an 802.1p priority value according to the port to 802.1p mapping. <i>dot1p-priority:</i> Specify the 802.1p priority ranging from 0 to 7. The default value is 0.
Step 5	show qos trust interface [fastEthernet port gigabitEthernet port ten-gigabitEthernet port port-channel port-channel-id] Verify the trust mode of the ports.

Step 6 **show qos port-priority interface [fastEthernet port | gigabitEthernet port | ten-gigabitEthernet port | port-channel port-channel-id]**

Verify the port to 802.1p mappings.

Step 7 **end**

Return to privileged EXEC mode.

Step 8 **copy running-config startup-config**

Save the settings in the configuration file.

■ Configuring the 802.1p to Queue Mapping

Follow these steps to configure the 802.1p to queue mapping:

Step 1 **configure**

Enter global configuration mode

Step 2 **qos cos-map {dot1p-priority} {tc-queue}**

Specify the 802.1p to queue mapping. The packets with the desired 802.1p priority will be put in the corresponding queues. By default, the 802.1p priority 0 to 7 is respectively mapped to TC-1, TC-0, TC-2, TC-3, TC-4, TC-5, TC-6, TC-7.

dot1p-priority: Specify the 802.1p priority. The valid values are from 0 to 7.

tc-queue: Specify the ID number of the TC queue. The valid values are from 0 to 7.

Step 3 **show qos cos-map**

Verify the 802.1p to queue mappings.

Step 4 **end**

Return to privileged EXEC mode.

Step 5 **copy running-config startup-config**

Save the settings in the configuration file.

The following example shows how to configure the trust mode of port 1/0/1 as untrust, map the port 1/0/1 to 802.1p priority 1 and map 802.1p priority 1 to TC3:

```
Switch#configure
```

```
Switch(config)#interface gigabitEthernet 1/0/1
```

```
Switch(config-if)#qos trust mode untrust
```

```
Switch(config-if)#qos port-priority 1
```

```
Switch(config-if)#exit
```

```
Switch(config)#qos cos-map 1 3
```

```
Switch(config)#show qos trust interface gigabitEthernet 1/0/1
```

```
Port      Trust Mode   LAG
-----  -
Gi1/0/1   untrust      N/A
```

```
Switch(config)#show qos port-priority interface gigabitEthernet 1/0/1
```

```
Port      CoS Value   LAG
-----  -
Gi1/0/1   CoS 1      N/A
```

```
Switch(config)#show qos cos-map
```

```
-----+-----+-----+-----+-----+-----+-----+-----+-----
Dot1p Value |0  |1  |2  |3  |4  |5  |6  |7
-----+-----+-----+-----+-----+-----+-----+-----+-----
TC          |TC0 |TC3 |TC2 |TC3 |TC4 |TC5 |TC6 |TC7
-----+-----+-----+-----+-----+-----+-----+-----+-----
```

```
Switch(config)#end
```

```
Switch#copy running-config startup-config
```

2.2.2 Configuring 802.1p Priority

■ Configuring the Trust Mode

Follow these steps to configure the trust mode:

Step 1	configure Enter global configuration mode
--------	---

-
- Step 2 **interface {fastEthernet port | range fastEthernet port-list | gigabitEthernet port | range gigabitEthernet port-list | ten-gigabitEthernet port | range ten-gigabitEthernet port-list | port-channel port-channel-id | range port-channel port-channel-list}**
Enter interface configuration mode.
-
- Step 3 **qos trust mode {untrust | dot1p | dscp}**
Select the trust mode for the port. By default, it is untrust. Here we set the trust mode as dot1p.

dot1p: Specify the ports' trust mode as dot1p. In this mode, the tagged packets will be processed according to the 802.1p priority configuration and the untagged packets will be processed according to the port priority configuration.
-
- Step 4 **show qos trust interface [fastEthernet port | gigabitEthernet port | ten-gigabitEthernet port | port-channel port-channel-id]**
Verify the trust mode of the ports.
-
- Step 5 **end**
Return to privileged EXEC mode.
-
- Step 6 **copy running-config startup-config**
Save the settings in the configuration file.
-

■ Configuring the 802.1p to Queue Mapping and 802.1p Remap

Follow these steps to configure the 802.1p to queue mapping and 802.1p remap:

-
- Step 1 **configure**
Enter global configuration mode
-
- Step 2 **qos cos-map {dot1p-priority} {tc-queue}**
Specify the 802.1p to queue mapping. The packets with the desired 802.1p priority will be put in the corresponding queues. By default, the 802.1p priority 0 to 7 is respectively mapped to TC-1, TC-0, TC-2, TC-3, TC-4, TC-5, TC-6, TC-7.

dot1p-priority: Specify the 802.1p priority. The valid values are from 0 to 7.

tc-queue: Specify the ID number of the TC queue. The valid values are from 0 to 7.
-

Step 3 For Certain Devices:

interface {**fastEthernet** *port* | **range fastEthernet** *port-list* | **gigabitEthernet** *port* | **range gigabitEthernet** *port-list* | **ten-gigabitEthernet** *port* | **range ten-gigabitEthernet** *port-list* | **port-channel** *port-channel-id* | **range port-channel** *port-channel-list*}

Enter interface configuration mode.

qos dot1p-remap {*dot1p-priority*} {*new-dot1p-priority*}

(Optional) Specify the 802.1p to 802.1p mappings for the desired port. 802.1p Remap is used to modify the 802.1p priority of the ingress packets. When the switch detects the packets with desired 802.1p priority, it will modify the value of 802.1p priority according to the map. By default, the original 802.1p priority 0 is mapped to the 802.1p priority 0, the original 802.1p priority 1 is mapped to the 802.1p priority 1 and so on.

dot1p-priority: Specify the original 802.1p priority. The valid values are from 0 to 7.

new-dot1p-priority: Specify the new 802.1p priority. The valid values are from 0 to 7.

For Certain Devices:

qos dot1p-remap {*dot1p-priority*} {*new-dot1p-priority*}

(Optional) Specify the 802.1p to 802.1p mappings. 802.1p Remap is used to modify the 802.1p priority of the ingress packets. When the switch detects the packets with desired 802.1p priority, it will modify the value of 802.1p priority according to the map. By default, the original 802.1p priority 0 is mapped to the 802.1p priority 0, the original 802.1p priority 1 is mapped to the 802.1p priority 1 and so on.

dot1p-priority: Specify the original 802.1p priority. The valid values are from 0 to 7.

new-dot1p-priority: Specify the new 802.1p priority. The valid values are from 0 to 7.

Step 4 **show qos cos-map**

Verify the 802.1p to queue mappings.

Step 5 For Certain Devices:

show qos dot1p-remap interface [**fastEthernet** *port* | **gigabitEthernet** *port* | **ten-gigabitEthernet** *port* | **port-channel** *port-channel-id*]

Verify the 802.1p to 802.1p mappings of the ports.

For Certain Devices:

show qos dot1p-remap

Verify the 802.1p to 802.1p mappings globally.

Step 6 **end**

Return to privileged EXEC mode.

Step 7 **copy running-config startup-config**

Save the settings in the configuration file.

 **Note:**

In Trust 802.1p mode, the untagged packets will be added an 802.1p priority based on the port to 802.1p mapping and will be forwarded according to the 802.1p to queue mapping.

The following example shows how to configure the trust mode of port 1/0/1 as dot1p, map 802.1p priority 3 to TC4, and configure to map the original 802.1p 1 to 802.1p priority 3:

Switch#configure

Switch(config)#interface gigabitEthernet 1/0/1

Switch(config-if)#qos trust mode dot1p

Switch(config-if)#exit

Switch(config)#qos cos-map 3 4

Switch(config)#qos dot1p-remap 1 3

Switch(config)#show qos trust interface gigabitEthernet 1/0/1

Port	Trust Mode	LAG
-----	-----	-----
Gi1/0/1	trust 802.1P	N/A

Switch(config)#show qos cos-map

Dot1p Value	0	1	2	3	4	5	6	7
-----	-----	-----	-----	-----	-----	-----	-----	-----
TC	TC0	TC1	TC2	TC4	TC4	TC5	TC6	TC7
-----	-----	-----	-----	-----	-----	-----	-----	-----

Switch(config)#show qos dot1p-remap

Dot1p Value	0	1	2	3	4	5	6	7	LAG
-----	-----	-----	-----	-----	-----	-----	-----	-----	-----
Dot1p Remap	0	3	2	3	4	5	6	7	N/A

Switch(config)#end

Switch#copy running-config startup-config

2.2.3 Configuring DSCP Priority

■ Configuring the Trust Mode

Follow these steps to configure the trust mode:

Step 1	configure Enter global configuration mode
Step 2	interface {fastEthernet port range fastEthernet port-list gigabitEthernet port range gigabitEthernet port-list ten-gigabitEthernet port range ten-gigabitEthernet port-list port-channel port-channel-id range port-channel port-channel-list} Enter interface configuration mode.
Step 3	qos trust mode {untrust dot1p dscp} Select the trust mode for the port. By default, it is untrust. Here we set the trust mode as dscp. <i>dscp</i> : Specify the ports' trust mode as dscp. In this mode, the IP packets will be processed according to the DSCP priority configuration and the non-IP packets will be processed according to the port priority configuration.
Step 4	show qos trust interface [fastEthernet port gigabitEthernet port ten-gigabitEthernet port port-channel port-channel-id] Verify the trust mode of the ports.
Step 5	end Return to privileged EXEC mode.
Step 6	copy running-config startup-config Save the settings in the configuration file.

■ Configuring the 802.1p to Queue Mapping

Follow these steps to configure the 802.1p to queue mapping:

Step 1	configure Enter global configuration mode
Step 2	qos cos-map {dot1p-priority} {tc-queue} Specify the 802.1p to queue mapping. The packets with the desired 802.1p priority will be put in the corresponding queues. By default, the 802.1p priority 0 to 7 is respectively mapped to TC-1, TC-0, TC-2, TC-3, TC-4, TC-5, TC-6, TC-7. <i>dot1p-priority</i> : Specify the 802.1p priority. The valid values are from 0 to 7. <i>tc-queue</i> : Specify the ID number of the TC queue. The valid values are from 0 to 7.
Step 3	show qos cos-map Verify the 802.1p to queue mappings.
Step 4	end Return to privileged EXEC mode.
Step 5	copy running-config startup-config Save the settings in the configuration file.

■ Configuring the DSCP to 802.1p Mapping and DSCP Remap

Follow these steps to configure the DSCP to 802.1p mapping and DSCP remap:

Step 1	<p>configure</p> <p>Enter global configuration mode</p>
Step 2	<p>For Certain Devices:</p> <p>interface {fastEthernet port range fastEthernet port-list gigabitEthernet port range gigabitEthernet port-list ten-gigabitEthernet port range ten-gigabitEthernet port-list port-channel port-channel-id range port-channel port-channel-list}</p> <p>Enter interface configuration mode.</p> <p>qos dscp-map {dscp-value-list} {dot1p-priority}</p> <p>Specify the DSCP to 802.1p mapping for the desired port. The ingress packets with the desired DSCP priority are first mapped to 802.1p priority based on the DSCP to 802.1p mapping, then to TC queues based on the 802.1p to queue mapping. By default, the DSCP priorities 0-7 are mapped to the 802.1p priority 0, the DSCP priorities 8-15 are mapped to the 802.1p priority 1 and so on.</p> <p><i>dscp-value-list</i>: Specify the DSCP value list in the format of "1-3,5,7". The valid values are from 0 to 63.</p> <p><i>dot1p-priority</i>: Specify the 802.1p priority. The valid values are from 0 to 7.</p> <p>For Certain Devices:</p> <p>qos dscp-map {dscp-value-list} {dot1p-priority}</p> <p>Specify the DSCP to 802.1p mapping. The ingress packets with the desired DSCP priority are first mapped to 802.1p priority based on the DSCP to 802.1p mapping, then to TC queues based on the 802.1p to queue mapping. The untagged packets with the desired DSCP priority will be added an 802.1p priority value according to the DSCP to 802.1p mapping. by default, the DSCP priorities 0-7 are mapped to the 802.1p priority 0, the DSCP priorities 8-15 are mapped to the 802.1p priority 1 and so on.</p> <p><i>dscp-value-list</i>: Specify the DSCP value list in the format of "1-3,5,7". The valid values are from 0 to 63.</p> <p><i>dot1p-priority</i>: Specify the 802.1p priority. The valid values are from 0 to 7.</p>
Step 3	<p>qos dscp-remap {dscp-value-list} {dscp-remap-value}</p> <p>(Optional) Specify the DSCP to DSCP mappings. DSCP Remap is used to modify the DSCP priority of the ingress packets. When the switch detects the packets with the desired DSCP priority, it will modify the value of DSCP priority according to the map. By default, the original DSCP priority 0 is mapped to the DSCP priority 0, the original DSCP priority 1 is mapped to the DSCP priority 1 and so on.</p> <p><i>dscp-value-list</i>: Specify the original DSCP priority list in the format of "1-3,5,7". The valid values are from 0 to 63.</p> <p><i>dscp-remap-value</i>: Specify the new DSCP priority. The valid values are from 0 to 63.</p>

-
- Step 4 For Certain Devices:
show qos dscp-map interface [fastEthernet port | gigabitEthernet port | ten-gigabitEthernet port | port-channel port-channel-id]
 Verify the DSCP to queue mappings of ports.
- For Certain Devices:
show qos dscp-map
 Verify the DSCP to queue mappings globally.
-
- Step 5 For Certain Devices:
show qos dscp-remap interface [fastEthernet port | gigabitEthernet port | ten-gigabitEthernet port | port-channel port-channel-id]
 Verify the DSCP to DSCP mappings of the ports.
- For Certain Devices:
show qos dscp-remap
 Verify the DSCP to DSCP mappings globally.
-
- Step 6 **end**
 Return to privileged EXEC mode.
-
- Step 7 **copy running-config startup-config**
 Save the settings in the configuration file.
-

 **Note:**

In Trust DSCP mode, non-IP packets will be added an 802.1p priority based on the port to 802.1p mapping and will be forwarded according to the 802.1p to queue mapping.

The following example shows how to configure the trust mode of port 1/0/1 as dscp, map 802.1p priority 3 to TC4, map DSCP priority 1-3,5,7 to 802.1p priority 3, and configure to map the original DSCP priority 9 to DSCP priority 5:

Switch#configure

Switch(config)#interface gigabitEthernet 1/0/1

Switch(config-if)#qos trust mode dscp

Switch(config-if)#exit

Switch(config)#qos cos-map 3 4

Switch(config)#qos dscp-map 1-3,5,7 3

Switch(config)#qos dscp-remap 9 5

Switch(config)#show qos trust interface gigabitEthernet 1/0/1

```
Port      Trust Mode  LAG
-----  -
```

```
Gi1/0/1  trust DSCP  N/A
```

Switch(config)#show qos cos-map

```
-----+-----+-----+-----+-----+-----+-----+-----+-----
Dot1p Value |0  |1  |2  |3  |4  |5  |6  |7
-----+-----+-----+-----+-----+-----+-----+-----+-----
TC          |TC0 |TC1 |TC2 |TC4 |TC4 |TC5 |TC6 |TC7
-----+-----+-----+-----+-----+-----+-----+-----+-----
```

Switch(config)#show qos dscp-map

```
DSCP:          0  1  2  3  4  5  6  7
DSCP to 802.1P 0  3  3  3  0  3  0  3
-----
DSCP:          8  9 10 11 12 13 14 15
DSCP to 802.1P 1  1  1  1  1  1  1  1
-----
DSCP:          16 17 18 19 20 21 22 23
DSCP to 802.1P 2  2  2  2  2  2  2  2
-----
DSCP:          24 25 26 27 28 29 30 31
DSCP to 802.1P 3  3  3  3  3  3  3  3
-----
DSCP:          32 33 34 35 36 37 38 39
DSCP to 802.1P 4  4  4  4  4  4  4  4
-----
DSCP:          40 41 42 43 44 45 46 47
DSCP to 802.1P 5  5  5  5  5  5  5  5
-----
DSCP:          48 49 50 51 52 53 54 55
```



```

DSCP to 802.1P 6 6 6 6 6 6 6 6
               -----
DSCP:          56 57 58 59 60 61 62 63
DSCP to 802.1P 7 7 7 7 7 7 7 7
               -----

```

Switch(config)#show qos dscp-remap

```

DSCP:          0 1 2 3 4 5 6 7
DSCP remap value 0 1 2 3 4 5 6 7
               -----
DSCP:          8 9 10 11 12 13 14 15
DSCP remap value 8 5 10 11 12 13 14 15
               -----
DSCP:          16 17 18 19 20 21 22 23
DSCP remap value 16 17 18 19 20 21 22 23
               -----
DSCP:          24 25 26 27 28 29 30 31
DSCP remap value 24 25 26 27 28 29 30 31
               -----
DSCP:          32 33 34 35 36 37 38 39
DSCP remap value 32 33 34 35 36 37 38 39
               -----
DSCP:          40 41 42 43 44 45 46 47
DSCP remap value 40 41 42 43 44 45 46 47
               -----
DSCP:          48 49 50 51 52 53 54 55
DSCP remap value 48 49 50 51 52 53 54 55
               -----
DSCP:          56 57 58 59 60 61 62 63
DSCP remap value 56 57 58 59 60 61 62 63
               -----

```

```
Switch(config-if)#end
```

```
Switch#copy running-config startup-config
```

2.2.4 Specifying the Scheduler Settings

Follow these steps to specify the scheduler settings to control the forwarding sequence of different TC queues when congestion occurs.

Step 1 **configure**

Enter global configuration mode.

Step 2 For Certain Devices:

interface {fastEthernet port | range fastEthernet port-list | gigabitEthernet port | range gigabitEthernet port-list | ten-gigabitEthernet port | range ten-gigabitEthernet port-list | port-channel port-channel-id | range port-channel port-channel-list}

Enter interface configuration mode.

qos queue tc-queue mode {sp | wrr} [weight weight]

Specify the type of scheduling used for corresponding queue. When the network congestion occurs, the egress queue will determine the forwarding sequence of the packets according to the type. By default, it is wrr mode and the all the queue weights are 1.

tc-queue: Specify the ID number of TC queue. The valid values are from 0 to 7.

sp: In sp mode, the egress queue will use SP (Strict Priority) to process the traffic in different queues. When congestion occurs, the traffic will be transmitted according to its queue priority strictly. The queue with higher priority occupies the whole bandwidth. Packets in the queue with lower priority are sent only when the queue with higher priority is empty.

wrr: In wrr mode, the egress queue will use WRR (Weighted Round Robin) to process the traffic in different queues. When congestion occurs, all the traffic will be transmitted, but the bandwidth that each traffic queue occupies will be allocated based on the queue weight.

weight: Specify the queue weight for the desired queue. This value can be set only in the wrr mode. The valid values are from 1 to 127.

For Certain Devices:

qos queue tc-queue mode {sp | wrr} [weight weight]

Specify the type of scheduling used for corresponding queue. When the network congestion occurs, the egress queue will determine the forwarding sequence of the packets according to the type. By default, it is wrr mode and the all the queue weights are 1.

tc-queue: Specify the ID number of TC queue. The valid values are from 0 to 7.

sp: In sp mode, the egress queue will use SP (Strict Priority) to process the traffic in different queues. When congestion occurs, the traffic will be transmitted according to its queue priority strictly. The queue with higher priority occupies the whole bandwidth. Packets in the queue with lower priority are sent only when the queue with higher priority is empty.

wrr: In wrr mode, the egress queue will use WRR (Weighted Round Robin) to process the traffic in different queues. When congestion occurs, all the traffic will be transmitted, but the bandwidth that each traffic queue occupies will be allocated based on the queue weight.

weight: Specify the queue weight for the desired queue. This value can be set only in the wrr mode. The valid values are from 1 to 127.

Step 3 `qos queue tc-queue bandwidth rate`

Specify the minimum guaranteed bandwidth for the desired queue. If the queue bandwidth calculated according to the weight is smaller than the minimum bandwidth, the switch will be forced to allocated the minimum bandwidth to the queue, and the other queue will share the rest bandwidth based on the weight.

tc-queue: Specify the ID number of the TC queue. The valid values are from 0 to 7.

rate: Specify the rate for the desired TC queue. The valid values are from 1 to 100. The default value is 0.

Note: Minimum Bandwidth is only available on certain devices.

Step 4 `show qos queue interface [fastEthernet port | gigabitEthernet port | ten-gigabitEthernet port | port-channel port-channel-id]`

Verify the scheduler settings..

Step 5 `end`

Return to privileged EXEC mode.

Step 6 `copy running-config startup-config`

Save the settings in the configuration file.

 **Note:**

With ACL Redirect feature, the switch maps all the packets that meet the configured ACL rules to the new TC queue, regardless of the mapping relations configured in this section.

The following example shows how to specify the scheduler settings for port 1/0/1. Set the scheduler mode of TC1 as sp mode, set the scheduler mode of TC4 as wrr mode and set the queue weight as 5.

Switch#configure

```
Switch(config)#interface gigabitEthernet 1/0/1
```

```
Switch(config-if)#qos queue 1 mode sp
```

```
Switch(config-if)#qos queue 4 mode wrr weight 5
```

```
Switch(config-if)#show qos queue interface gigabitEthernet 1/0/1
```

```
Gi1/0/1----LAG: N/A
```

```
Queue Schedule Mode Weight
```

```
-----
```

```
TC0 WRR 1
```

```
TC1 Strict N/A
```

```
TC2 WRR 1
```

```
TC3 WRR 1
```

```
TC4    WRR        5
TC5    WRR        1
TC6    WRR        1
TC7    WRR        1
```

```
Switch(config-if)#end
```

```
Switch#copy running-config startup-config
```

3 Bandwidth Control Configuration

With bandwidth control configurations, you can:

- Configure rate limit
- Configure storm control

3.1 Using the GUI

3.1.1 Configuring Rate Limit

Choose the menu **QoS > Bandwidth Control > Rate Limit** to load the following page.

Figure 3-1 Configuring Rate Limit

Rate Limit Config				
UNIT1		LAGS		
<input type="checkbox"/>	Port	Ingress Rate (0-1,000,000Kbps)	Egress Rate (0-1,000,000Kbps)	LAG
<input type="checkbox"/>	1/0/1	0	0	--
<input type="checkbox"/>	1/0/2	0	0	--
<input type="checkbox"/>	1/0/3	0	0	--
<input type="checkbox"/>	1/0/4	0	0	--
<input type="checkbox"/>	1/0/5	0	0	--
<input type="checkbox"/>	1/0/6	0	0	--
<input type="checkbox"/>	1/0/7	0	0	--
<input type="checkbox"/>	1/0/8	0	0	--
<input type="checkbox"/>	1/0/9	0	0	--
<input type="checkbox"/>	1/0/10	0	0	--
Total: 54				

Follow these steps to configure the Rate Limit function:

- 1) Select the desired port and configure the upper rate limit to receive and send packets.

Ingress Rate (0-1,000,000Kbps)

Specify the upper rate limit for receiving packets on the port.

The rate ranges from 1 to 1000000 kbps for the gigaport and 1 to 100000 kbps for the fast port, and is rounded off to the nearest multiple of 64. 0 means the ingress rate limit is disabled.

Egress Rate (0-1,000,000Kbps)

Specify the upper rate limit for sending packets on the port.

The rate ranges from 1 to 1000000 kbps for the gigaport and 1 to 100000 kbps for the fast port, and is rounded off to the nearest multiple of 64. 0 means the egress rate limit is disabled.

2) Click **Apply**.

3.1.2 Configuring Storm Control

Choose the menu **QoS > Bandwidth Control > Storm Control** to load the following page.

Figure 3-2 Configuring Storm Control

Storm Control Config										
UNIT1		LAGS								Recover
<input type="checkbox"/>	Port	Rate Mode	Broadcast Threshold	Multicast Threshold	UL-Frame Threshold	Action	Recover Time	LAG		
<input type="checkbox"/>	1/0/1	kbps	0	0	0	Drop	0	--		
<input type="checkbox"/>	1/0/2	kbps	0	0	0	Drop	0	--		
<input type="checkbox"/>	1/0/3	kbps	0	0	0	Drop	0	--		
<input type="checkbox"/>	1/0/4	kbps	0	0	0	Drop	0	--		
<input type="checkbox"/>	1/0/5	kbps	0	0	0	Drop	0	--		
<input type="checkbox"/>	1/0/6	kbps	0	0	0	Drop	0	--		
<input type="checkbox"/>	1/0/7	kbps	0	0	0	Drop	0	--		
<input type="checkbox"/>	1/0/8	kbps	0	0	0	Drop	0	--		
<input type="checkbox"/>	1/0/9	kbps	0	0	0	Drop	0	--		
<input type="checkbox"/>	1/0/10	kbps	0	0	0	Drop	0	--		
Total: 54										

Follow these steps to configure the Storm Control function:

- 1) Select the desired port and configure the upper rate limit for forwarding broadcast packets, multicast packets and UL-frames (Unknown unicast frames).

Rate Mode

Specify the Rate Mode for the broadcast threshold, multicast threshold and UL-Frame threshold on the desired port.

kbps: The switch will limit the maximum speed of the specific kinds of traffic in kilo-bits per second.

ratio: The switch will limit the percentage of bandwidth utilization for specific kinds of traffic.

pps: The switch will limit the maximum number of packets per second for specific kinds of traffic.

Note: **pps** is only available on certain devices.

Broadcast Threshold (0-1,000,000)

Specify the upper rate limit for receiving broadcast packets. The broadcast traffic exceeding the limit will be processed according to the Action configurations.

The valid values differ among different rate modes. For kbps, the rate ranges from 1 to 1000000 kbps, and is rounded off to the nearest multiple of 64. For ratio, the rate ranges from 1 to 100 percent. For pps, the rate ranges from 1 to 1488000 packets per second. The value 0 means the broadcast threshold is disabled.

Multicast Threshold (0-1,000,000)	<p>Specify the upper rate limit for receiving multicast packets. The multicast traffic exceeding the limit will be processed according to the Action configurations.</p> <p>The valid values differ among different rate modes. For kbps, the rate ranges from 1 to 1000000 kbps, and is rounded off to the nearest multiple of 64. For ratio, the rate ranges from 1 to 100 percent. For pps, the rate ranges from 1 to 1488000 packets per second. The value 0 means the multicast threshold is disabled.</p>
UL-Frame Threshold (0-1,000,000)	<p>Specify the upper rate limit for receiving unknown unicast frames. The traffic exceeding the limit will be processed according to the Action configurations.</p> <p>The valid values differ among different rate modes. For kbps, the rate ranges from 1 to 1000000 kbps, and is rounded off to the nearest multiple of 64. For ratio, the rate ranges from 1 to 100 percent. For pps, the rate ranges from 1 to 1488000 packets per second. The value 0 means the unknown unicast threshold is disabled.</p>
Action	<p>Select the action that the switch will take when the traffic exceeds its corresponding limit.</p> <p>Drop: Set the Action as Drop. The port will drop the subsequent packets when the traffic exceeds the limit.</p> <p>Shutdown: Set the Action as Shutdown. The port will be shutdown when the traffic exceeds the limit.</p>
Recover Time	<p>Specify the recover time for the port. When the traffic exceeds the limit, the port will process the packets according to the Action configurations. After the recover time has passed, the port will recover to its normal state. If the recover time is specified as 0, which means the port will not recover to its normal state automatically and you can click Recover to recover the port manually.</p>
LAG	<p>Displays the LAG that the port belongs to.</p>

2) Click **Apply**.

Notes:

- The member ports of an LAG follow the configurations of the LAG and not their own. The individual configurations of the ports can take effect only after the ports leave the LAG.
- You cannot enable Storm Control and Ingress Rate control at the same time for a port.
- The Shutdown action only takes effect on broadcast storm and multicast storm.
- The Shutdown and Recover action take effect on Ports instead of LAG.

3.2 Using the CLI

3.2.1 Configuring Rate Limit

Follow these steps to configure the upper rate limit for the port to receive and send packets:

Step 1	configure Enter global configuration mode.
Step 2	interface {fastEthernet port range fastEthernet port-list gigabitEthernet port range gigabitEthernet port-list ten-gigabitEthernet port range ten-gigabitEthernet port-list port-channel port-channel-id range port-channel port-channel-list} Enter interface configuration mode.
Step 3	bandwidth {ingress ingress-rate egress egress-rate} Configure the upper rate limit for the port to receive and send packets. <i>ingress-rate</i> : Specify the upper rate limit for receiving packets on the port. The rate ranges from 1 to 1000000 kbps for the gigaport and 1 to 100000 kbps for the fast port, and is rounded off to the nearest multiple of 64. <i>egress-rate</i> : Specify the upper rate limit for sending packets on the port. The rate ranges from 1 to 1000000 kbps for the gigaport and 1 to 100000 kbps for the fast port, and is rounded off to the nearest multiple of 64.
Step 4	show bandwidth interface [fastEthernet port gigabitEthernet port ten-gigabitEthernet port port-channel port-channel-id] Verify the ingress/egress rate limit for forwarding packets on the port or LAG. If no port or LAG is specified, it displays the upper ingress/egress rate limit for all ports or LAGs.
Step 5	end Return to privileged EXEC mode.
Step 6	copy running-config startup-config Save the settings in the configuration file.

The following example shows how to configure the ingress-rate as 5120 Kbps and egress-rate as 1024 Kbps for port 1/0/5:

```
Switch#configure
```

```
Switch(config)#interface gigabitEthernet 1/0/5
```

```
Switch(config-if)#bandwidth ingress 5120 egress 1024
```

```
Switch(config-if)#show bandwidth interface gigabitEthernet 1/0/5
```

Port	IngressRate(Kbps)	EgressRate(Kbps)	LAG
-----	-----	-----	-----
Gi1/0/5	5120	1024	N/A

```
Switch(config-if)#end
```

```
Switch#copy running-config startup-config
```

3.2.2 Configuring Storm Control

Follow these steps to configure the upper rate limit on the port for forwarding broadcast packets, multicast packets and unknown unicast frames:

Step 1	configure Enter global configuration mode
Step 2	interface {fastEthernet port range fastEthernet port-list gigabitEthernet port range gigabitEthernet port-list ten-gigabitEthernet port range ten-gigabitEthernet port-list port-channel port-channel-id range port-channel port-channel-list} Enter interface configuration mode.
Step 3	storm-control rate-mode {kbps ratio pps} Specify the Rate Mode for the broadcast threshold, multicast threshold and UL-Frame threshold on the desired port. kbps: The switch will limit the maximum speed of the specific kinds of traffic in kilo-bits per second. ratio: The switch will limit the percentage of bandwidth utilization for specific kinds of traffic. pps: The switch will limit the maximum number of packets per second for specific kinds of traffic. Note: pps is only available on certain devices.
Step 4	storm-control broadcast rate Specify the upper rate limit for receiving broadcast packets. The broadcast traffic exceeding the limit will be processed according to the Action configurations. rate: Specify the upper rate limit for receiving broadcast packets. The valid values differ among different rate modes. For kbps, the rate ranges from 1 to 1000000 kbps, and is rounded off to the nearest multiple of 64. For ratio, the rate ranges from 1 to 100 percent. For pps, the rate ranges from 1 to 1488000 packets per second.
Step 5	storm-control multicast rate Specify the upper rate limit for receiving multicast packets. The multicast traffic exceeding the limit will be processed according to the Action configurations. rate: Specify the upper rate limit for receiving multicast packets. The valid values differ among different rate modes. For kbps, the rate ranges from 1 to 1000000 kbps, and is rounded off to the nearest multiple of 64. For ratio, the rate ranges from 1 to 100 percent. For pps, the rate ranges from 1 to 1488000 packets per second.
Step 6	storm-control unicast rate Specify the upper rate limit for receiving unknown unicast frames. The traffic exceeding the limit will be processed according to the Action configurations. rate: Specify the upper rate limit for receiving unknown unicast frames. The valid values differ among different rate modes. For kbps, the rate ranges from 1 to 1000000 kbps, and is rounded off to the nearest multiple of 64. For ratio, the rate ranges from 1 to 100 percent. For pps, the rate ranges from 1 to 1488000 packets per second.

-
- Step 7 **storm-control exceed {drop | shutdown} [recover-time time]**
- Specify the action and the recover time. The switch will perform the action when the traffic exceeds its corresponding limit. By default, it is drop.
- drop:** Set the Action as Drop. The port will drop the subsequent packets when the traffic exceeds the limit.
- shutdown:** Set the Action as Shutdown. The port will be shutdown when the traffic exceeds the limit.
- time:** Specify the recover time for the port. It takes effect only when the action is set as shutdown. The valid values are from 0 to 3600 and the default value is 0. When the port is shutdown, it can recover to its normal state after the recover time passed. If the recover time is specified as 0, which means the port will not recover to its normal state automatically and you can recover the port manually.
-
- Step 8 **storm-control recover**
- (Optional) Recover the port manually. When the recover time is specified as 0, the port will not recover to its normal state automatically. In this condition, you need to use this command to recover the port manually.
-
- Step 9 **show storm-control interface [fastEthernet port | gigabitEthernet port | ten-gigabitEthernet port | port-channel port-channel-id]**
- Verify the storm control configurations of the port or LAG. If no port or LAG is specified, it displays the storm control configuration for all ports or LAGs.
-
- Step 10 **end**
- Return to privileged EXEC mode.
-
- Step 11 **copy running-config startup-config**
- Save the settings in the configuration file.
-

The following example shows how to configure the upper rate limit of broadcast packets as 1024 kbps, Specify the action as shutdown and set the recover time as 10 for port 1/0/5:

Switch#configure

Switch(config)#interface gigabitEthernet 1/0/5

Switch(config-if)#storm-control rate-mode kbps

Switch(config-if)#storm-control broadcast 1024

Switch(config-if)#storm-control exceed shutdown recover-time 10

Switch(config-if)#show storm-control interface gigabitEthernet 1/0/5

Port	Rate Mode	BcRate	McRate	UIRate	Exceed	Recover Time	LAG
-----	-----	-----	-----	-----	-----	-----	-----
Gi1/0/5	kbps	1024	0	0	shutdown	10	N/A

Switch(config-if)#end

Switch#copy running-config startup-config

4 Voice VLAN Configuration

To complete the voice VLAN configurations, follow these steps:

- 1) Create a 802.1Q VLAN
- 2) Configure OUI addresses
- 3) Configure Voice VLAN globally
- 4) Add ports to Voice VLAN

Configuration Guidelines

- Before configuring voice VLAN, you need to create a 802.1Q VLAN for voice traffic. For details about 802.1Q VLAN Configuration, please refer to [Configuring 802.1Q VLAN](#).
- VLAN 1 is a default VLAN and cannot be configured as the voice VLAN.
- Only one VLAN can be set as the voice VLAN on the switch.

4.1 Using the GUI

4.1.1 Configuring OUI Addresses

The OUI address is assigned as a unique identifier by IEEE (Institute of Electrical and Electronics Engineers) to a device vendor. It is used by the switch to determine whether a packet is a voice packet.

If the OUI address of your voice device is not in the OUI table, you need to add the OUI address to the table.

Choose the menu **QoS > Voice VLAN > OUI Config** to load the following page.

Figure 4-1 Configuring OUI Addresses

OUI Config			
+ Add - Delete			
<input type="checkbox"/>	OUI	Status	Description
<input type="checkbox"/>	00:01:E3	Default	SIEMENS
<input type="checkbox"/>	00:03:6B	Default	CISCO1
<input type="checkbox"/>	00:04:0D	Default	AVAYA1
<input type="checkbox"/>	00:04:13	Default	SNOM
<input type="checkbox"/>	00:0F:E2	Default	H3C
<input type="checkbox"/>	00:12:43	Default	CISCO2
<input type="checkbox"/>	00:1B:4F	Default	AVAYA2
<input type="checkbox"/>	00:60:B9	Default	NITSUKO
<input type="checkbox"/>	00:D0:1E	Default	PINTEL
<input type="checkbox"/>	00:E0:75	Default	VERILINK
Total: 11			

Follow these steps to configure the OUI addresses:

- 1) Click **+ Add** to load the following page.

Figure 4-2 Creating an OUI Entry

OUI

OUI: (Format: 00:00:00)

Description: (0-16 characters)

- 2) Specify the OUI and the Description.

OUI	Enter the OUI address of your voice devices. The OUI address is used by the switch to determine whether a packet is a voice packet. An OUI address is the first 24 bits of a MAC address, and is assigned as a unique identifier by IEEE (Institute of Electrical and Electronics Engineers) to a device vendor. If the source MAC address of a packet matches the OUI addresses in the OUI list, the switch identifies the packet as a voice packet and prioritizes it in transmission.
Status	Displays the status of the OUI entries. Default: Indicates that the corresponding OUI entry is the default setting. Configured: Indicates that the corresponding OUI entry is the user-defined.
Description	Give an OUI address description for identification.

- 3) Click **Create**.

4.1.1 Configuring Voice VLAN Globally

Choose the menu **QoS > Voice VLAN > Global Config** to load the following page.

Figure 4-3 Configuring Voice VLAN Globally

Global Config

Voice VLAN: Enable

VLAN ID: (2-4094)

Priority:

Apply

Follow these steps to configure voice VLAN globally:

- 1) Enable the voice VLAN feature and specify the parameters.

Voice VLAN	Enable or disable Voice VLAN.
VLAN ID	Specify the 802.1Q VLAN ID to set it as voice VLAN.
Priority	Select the priority that will be assigned to voice packets. A bigger value means a higher priority. This is an IEEE 802.1p priority, and you can further configure its scheduler mode in QoS if needed.

- 2) Click **Apply**.

4.1.1 Adding Ports to Voice VLAN

Choose the menu **QoS > Voice VLAN > Port Config** to load the following page.

Figure 4-4 Adding Ports to Voice VLAN

Port Config

UNIT1

LAGS

	Port	Voice VLAN	Operational Status
<input type="checkbox"/>	1/0/1	Disabled	Inactive
<input type="checkbox"/>	1/0/2	Disabled	Inactive
<input type="checkbox"/>	1/0/3	Disabled	Inactive
<input type="checkbox"/>	1/0/4	Disabled	Inactive
<input type="checkbox"/>	1/0/5	Disabled	Inactive
<input type="checkbox"/>	1/0/6	Disabled	Inactive
<input type="checkbox"/>	1/0/7	Disabled	Inactive
<input type="checkbox"/>	1/0/8	Disabled	Inactive
<input type="checkbox"/>	1/0/9	Disabled	Inactive
<input type="checkbox"/>	1/0/10	Disabled	Inactive
Total: 54			

Follow these steps to configure voice VLAN globally:

- 1) Select the desired ports and choose Enable in Voice VLAN filed.

Voice VLAN	Select Enable to add the desired port to Voice VLAN.
Optional Status	Displays the state of the Voice VLAN on the corresponding port. Active: Indicates that the Voice VLAN is enabled on the port. Inactive: Indicates that the Voice VLAN is disabled on the port.

- 2) Click **Apply**.

4.2 Using the CLI

Follow these steps to configure voice VLAN:

Step 1	configure Enter global configuration mode.
Step 2	show voice vlan oui-table Check whether the OUI address of your voice device is in the OUI table. The OUI address is used by the switch to determine whether a packet is a voice packet. An OUI address is the first 24 bits of a MAC address, and is assigned as a unique identifier by IEEE (Institute of Electrical and Electronics Engineers) to a device vendor. If the source MAC address of a packet matches the OUI addresses in the OUI list, the switch identifies the packet as a voice packet and prioritizes it in transmission.
Step 3	voice vlan oui <i>oui-prefix</i> <i>oui-desc</i> <i>string</i> If the OUI address of your voice device is not in the OUI table, add the OUI address to the table. <i>oui-prefix</i> : Enter the OUI address for your voice device in the format of XX:XX:XX. <i>string</i> : Give an OUI address description for identification. It contains 16 characters at most.
Step 4	voice vlan <i>vid</i> Enable the voice VLAN feature and specify an existing 802.1Q VLAN as the voice VLAN. <i>vid</i> : Enter the 802.1Q VLAN ID to set the 802.1Q VLAN as the voice VLAN.
Step 5	voice vlan priority <i>pri</i> Specify the priority that will be assigned to voice packets. <i>pri</i> : Enter the priority that will be assigned to voice packets. A bigger value means a higher priority. The valid values are from 0 to 7 and the default value is 7. This is an IEEE 802.1p priority, and you can further configure its scheduler mode in Class of Service if needed.
Step 6	interface {<i>fastEthernet</i> <i>port</i> <i>range fastEthernet</i> <i>port-list</i> <i>gigabitEthernet</i> <i>port</i> <i>range gigabitEthernet</i> <i>port-list</i> <i>ten-gigabitEthernet</i> <i>port</i> <i>range ten-gigabitEthernet</i> <i>port-list</i> <i>port-channel</i> <i>port-channel-id</i> <i>range port-channel</i> <i>port-channel-list</i>} Enter interface configuration mode.

-
- Step 7 **voice vlan**
Enable the voice VLAN feature on ports and add the desired ports to voice VLAN.
-
- Step 8 **show voice vlan interface**
Verify the voice VLAN configuration information.
-
- Step 8 **end**
Return to privileged EXEC mode.
-
- Step 9 **copy running-config startup-config**
Save the settings in the configuration file.
-

The following example shows how to show the OUI table, set VLAN 8 as voice VLAN, set the priority as 6 and enable voice VLAN feature on port 1/0/3:

Switch#configure

Switch(config)#show voice vlan oui-table

```
00:01:E3   Default   SIEMENS
00:03:6B   Default   CISCO1
00:04:0D   Default   AVAYA1
00:04:13   Default   SNOM
00:0F:E2   Default   H3C
00:12:43   Default   CISCO2
00:1B:4F   Default   AVAYA2
00:60:B9   Default   NITSUKO
00:D0:1E   Default   PINTEL
00:E0:75   Default   VERILINK
00:E0:BB   Default   3COM
```

Switch(config)#voice vlan 8

Switch(config)#voice vlan priority 6

Switch(config)#interface gigabitEthernet 1/0/3

Switch(config-if)#voice vlan

Switch(config-if)#show voice vlan interface

```
Voice VLAN ID      8
Priority            6
```

Interface	Voice VLAN Mode	Operational Status	LAG
-----	-----	-----	---
Gi1/0/1	disabled	Down	N/A
Gi1/0/2	disabled	Down	N/A
Gi1/0/3	enabled	Up	N/A
Gi1/0/4	disabled	Down	N/A
Gi1/0/5	disabled	Down	N/A

...

Switch(config-if)#end

Switch#copy running-config startup-config

5 Auto VoIP Configuration

Configuration Guidelines

- Before configuring Auto VoIP, you need to enable LLDP-MED on ports and configure the relevant parameters. For details about LLDP-MED configuration, please refer to [Configuring LLDP](#).
- Auto VoIP provide flexible solutions for optimizing the voice traffic. It can work with other features such as VLAN and Class of Service to process the voice packets with specific fields. You can choose and configure Auto VoIP and other features according to your needs.

5.1 Using the GUI

Choose the menu **QoS > Auto VoIP** to load the following page.

Figure 5-1 Configuring Auto VoIP

Global Config

Auto VoIP: Enable Apply

Port Config

UNIT1

<input type="checkbox"/>	Port	Interface Mode	Value	CoS Override Mode	Operational Status	DSCP Value
<input type="checkbox"/>	1/0/1	Disable	0	Disabled	Disabled	0
<input type="checkbox"/>	1/0/2	Disable	0	Disabled	Disabled	0
<input type="checkbox"/>	1/0/3	Disable	0	Disabled	Disabled	0
<input type="checkbox"/>	1/0/4	Disable	0	Disabled	Disabled	0
<input type="checkbox"/>	1/0/5	Disable	0	Disabled	Disabled	0
<input type="checkbox"/>	1/0/6	Disable	0	Disabled	Disabled	0
<input type="checkbox"/>	1/0/7	Disable	0	Disabled	Disabled	0
<input type="checkbox"/>	1/0/8	Disable	0	Disabled	Disabled	0
<input type="checkbox"/>	1/0/9	Disable	0	Disabled	Disabled	0
<input type="checkbox"/>	1/0/10	Disable	0	Disabled	Disabled	0

Total: 54

Follow these steps to configure the OUI addresses:

- 1) In the **Global Config** section, enable the Auto VoIP function globally.
- 2) In the **Port Config** section, select the desired and configure the parameters.

Interface Mode	<p>Select the interface mode for the port.</p> <p>Disable: Disable the Auto VoIP function on the corresponding port.</p> <p>None: Allow the voice devices to use its own configuration to send voice traffic.</p> <p>VLAN ID: The voice devices will send voice packets with desired VLAN tag. If this mode is selected, it is necessary to specify the VLAN ID in the Value field.</p> <p>In addition, you need to configure the 802.1Q VLAN to ensure the corresponding ports can forward the packets normally.</p> <p>Dot1p: The voice devices will send voice packets with desired 802.1p priority. If this mode is selected, it is necessary to specify 802.1p priority in the Value field.</p> <p>In addition, you can configure the Class of Service to make the switch process the packets according to the 802.1p priority.</p> <p>Untagged: The voice devices will send untagged voice packets.</p>
Value	<p>Enter the value of VLAN ID or 802.1p priority for the port according to the Interface Mode configurations.</p>
CoS Override Mode	<p>Enable or disable the Class of Service override mode.</p> <p>Enabled: Enable CoS override. The switch will ignore Class of Service settings and put the packets in TC-5 directly.</p> <p>Disabled: Disable CoS override. The switch will then put the voice packets in the corresponding TC queue according to Class of Service settings.</p>
Operational Status	<p>Displays the operating status of the Voice VLAN feature on the interface. To make it enabled, you must enable the Voice VLAN both globally and on the interface.</p>
DSCP Value	<p>Enter the value of DSCP priority. The voice device will generate the packets with the corresponding DSCP value and send them out.</p> <p>In addition, you can configure the Class of Service to make the switch process the packets according to the DSCP priority.</p>

3) Click **Apply**.

5.2 Using the CLI

Follow these steps to configure Auto VoIP:

Step 1	<p>configure</p> <p>Enter global configuration mode.</p>
Step 2	<p>auto-voip</p> <p>Enable Auto VoIP globally.</p>

-
- Step 3 **interface {fastEthernet port | range fastEthernet port-list | gigabitEthernet port | range gigabitEthernet port-list | ten-gigabitEthernet port | range ten-gigabitEthernet port-list | port-channel port-channel-id | range port-channel port-channel-list}**
- Enter interface configuration mode.
-
- Step 4 Select the interface mode for the port.
- no auto-voip**
- Specify the interface mode as disabled, which means the Auto VoIP function is disabled on the corresponding port.
- auto-voip none**
- Specify the interface mode as none. In this mode, the switch allows the voice devices to use its own configuration to send voice traffic.
- auto-voip vlan-id**
- Specify the interface mode as VLAN ID. In this mode, the voice devices will send voice packets with desired VLAN tag. If this mode is selected, it is necessary to specify the 802.1Q VLAN ID. The valid values are from 1 to 4093.
- In addition, you need to configure the 802.1Q VLAN to ensure the corresponding ports can forward the packets normally.
- auto-voip dot1p dot1p**
- Specify the interface mode as dot1p. In this mode, the voice devices will send voice packets with desired 802.1p priority. If this mode is selected, it is necessary to specify 802.1p priority. The valid values are from 0 to 7.
- In addition, you can configure the Class of Service to make the switch process the packets according to the 802.1p priority.
- auto-voip untagged**
- Specify the interface mode as untagged. In this mode, the voice devices will send untagged voice packets.
-
- Step 5 **auto-voip data priority {trust | untrust}**
- Enable or disable the Class of Service override mode. By default, it is trust, which means the Class of Service override mode is disabled.
- trust:** In this mode, The switch will then put the voice packets in the corresponding TC queue according to Class of Service settings.
- untrust:** In this mode, The switch will ignore Class of Service settings and put the packets in TC-5 directly.
-
- Step 6 **auto-voip dscp value**
- Specify the value of DSCP priority. The voice device will send the packets with the corresponding DSCP value.
- In addition, you can configure the Class of Service to make the switch process the packets according to the DSCP priority.
- value:** Enter the value of DSCP priority. The valid values are from 0 to 63 and the default value is 0.
-

-
- Step 7 **show auto-voip**
Verify the global state of Auto VoIP.
-
- Step 8 **show auto-voip interface**
Verify the Auto VoIP configuration information of ports.
-
- Step 8 **end**
Return to privileged EXEC mode.
-
- Step 9 **copy running-config startup-config**
Save the settings in the configuration file.
-

The following example shows how to set the interface mode as dot1p, specify the 802.1p priority as 4, specify the DSCP priority as 10 and enable the CoS override mode for port 1/0/3:

Switch#configure

Switch(config)#auto-voip

Switch(config)#interface gigabitEthernet 1/0/3

Switch(config-if)#auto-voip dot1p 4

Switch(config-if)#auto-voip dscp 10

Switch(config-if)#auto-voip data priority untrust

Switch(config-if)#show auto-voip

Administrative Mode: Enabled

Switch(config-if)#show auto-voip interface

Interface.Gi1/0/1

Auto-VoIP Interface Mode. Disabled

Auto-VoIP COS Override. False

Auto-VoIP DSCP Value. 0

Auto-VoIP Port Status. Disabled

Interface.Gi1/0/2

Auto-VoIP Interface Mode. Disabled

Auto-VoIP COS Override. False

Auto-VoIP DSCP Value. 0

Auto-VoIP Port Status. Disabled

```
Interface.Gi1/0/3
Auto-VoIP Interface Mode.      Enabled
Auto-VoIP Priority.            4
Auto-VoIP COS Override.       True
Auto-VoIP DSCP Value.         10
Auto-VoIP Port Status.        Enabled
...
Switch(config-if)#end
Switch#copy running-config startup-config
```

6 Configuration Examples

6.1 Example for Class of Service

6.1.1 Network Requirements

As shown below, both RD department and Marketing department can access the internet. When congestion occurs, the traffic from two departments can both be forwarded and the traffic from the Marketing department should take precedence.

Figure 6-1 QoS Application Topology

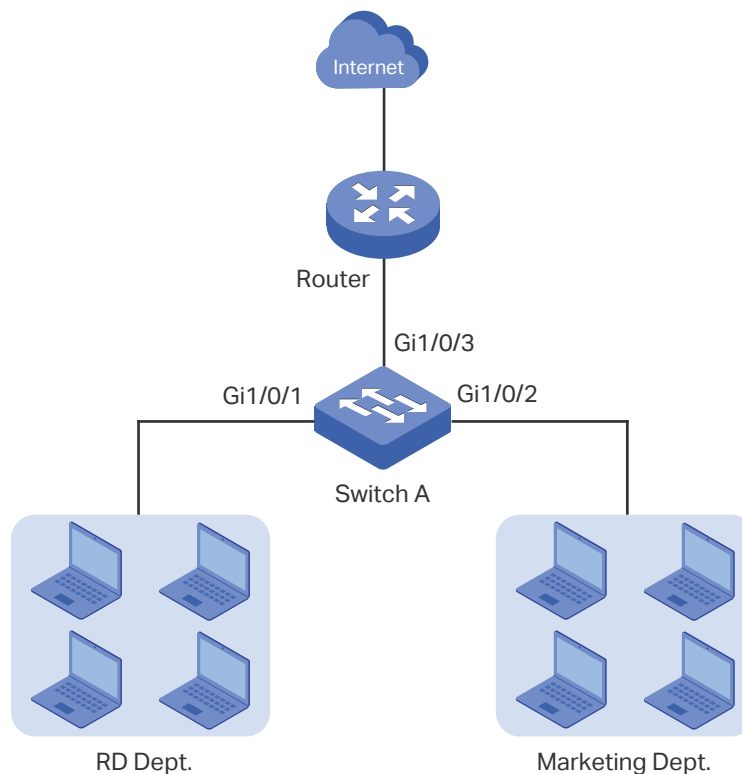

6.1.2 Configuration Scheme

To implement this requirement, you can configure Port Priority to put the packets from the Marketing department into the queue with the higher priority than the packets from the RD department.

- 1) Configure the trust mode of port 1/0/1 and port 1/0/2 as untrusted and map the ports to different queues.
- 2) Set the scheduler type of the queues as weighted for port 1/0/3 and specify the queue weight to make the traffic from the Marketing department take precedence.

Demonstrated with SG6654XHP, the following sections provide configuration procedure in two ways: using the GUI and using the CLI.

6.1.3 Using the GUI

- 1) Choose the menu **QoS > Class of Service > Port Priority** to load the following page. Set the trust mode of port 1/0/1 and 1/0/2 as untrusted. Specify the 802.1p priority of port 1/0/1 as 1 and specify the 802.1p priority of port 1/0/2 as 0. Click **Apply**.

Figure 6-2 Configuring Port Priority

Port Priority Config

<input type="checkbox"/>	Port	802.1p Priority	Trust Mode	LAG
<input checked="" type="checkbox"/>	1/0/1	1	Untrusted	--
<input type="checkbox"/>	1/0/2	0	Untrusted	--
<input type="checkbox"/>	1/0/3	0	Untrusted	--
<input type="checkbox"/>	1/0/4	0	Untrusted	--
<input type="checkbox"/>	1/0/5	0	Untrusted	--
<input type="checkbox"/>	1/0/6	0	Untrusted	--
<input type="checkbox"/>	1/0/7	0	Untrusted	--
<input type="checkbox"/>	1/0/8	0	Untrusted	--
<input type="checkbox"/>	1/0/9	0	Untrusted	--
<input type="checkbox"/>	1/0/10	0	Untrusted	--

Total: 54 1 entry selected.

- 2) Choose the menu **QoS > Class of Service > 802.1p Priority** to load the following page. Map the 802.1p priority 0 to TC-1 and map the 802.1p priority 1 to TC-0. Click **Apply**.

Figure 6-3 Configuring the 802.1p to Queue Mappings

802.1p Priority	Queue
0:	TC-1
1:	TC-0
2:	TC-2
3:	TC-3
4:	TC-4
5:	TC-5
6:	TC-6
7:	TC-7

Apply

802.1p Priority	Remap
0:	0
1:	1
2:	2
3:	3
4:	4
5:	5
6:	6
7:	7

Apply

- 3) Choose the menu **QoS > Class of Service > Scheduler Settings** to load the following page. Select the port 1/0/3 and set the scheduler type of TC-0 and TC-1 as Weighted. Specify the queue weight of TC-0 as 1 and specify the queue weight of TC-1 as 5. Click **Apply**.

Figure 6-4 Configuring the Egress Queue

The screenshot shows the 'Scheduler Config' interface. At the top, there are two groups of ports: 'UNIT1' (ports 2-18) and 'LAGS' (ports 20-28). Port 3 is highlighted with a red box. Below the grid is a legend: a blue square for 'Selected', a white square for 'Unselected', and a grey square for 'Not Available'. Below the legend is the text 'Port 1/0/3'. The main part of the interface is a table with the following columns: Queue TC-id, Scheduler Type, Queue Weight, and Management Type. The table contains 8 rows of queue configurations. The second row (TC-id 1) is highlighted in light blue and has a checkmark in the first column. At the bottom of the table, there is a summary row: 'Total: 8' on the left, '1 entry selected.' in the middle, and 'Cancel' and 'Apply' buttons on the right. The 'Apply' button is highlighted with a red box.

Queue TC-id	Scheduler Type	Queue Weight	Management Type
<input type="checkbox"/>	Weighted	5	
<input checked="" type="checkbox"/>	Weighted	5	Taildrop
<input type="checkbox"/>	Weighted	1	Taildrop
<input type="checkbox"/>	Weighted	1	Taildrop
<input type="checkbox"/>	Weighted	1	Taildrop
<input type="checkbox"/>	Weighted	1	Taildrop
<input type="checkbox"/>	Weighted	1	Taildrop
<input type="checkbox"/>	Weighted	1	Taildrop

4) Click  to save the settings.

6.1.4 Using the CLI

1) Set the trust mode of port 1/0/1 as untrusted and specify the 802.1p priority as 1.

```
Switch_A#configure
Switch_A(config)#interface gigabitEthernet 1/0/1
Switch_A(config-if)#qos trust mode untrust
Switch_A(config-if)#qos port-priority 1
Switch_A(config-if)#exit
```

2) Set the trust mode of port 1/0/2 as untrusted and specify the 802.1p priority as 0.

```
Switch_A(config)#interface gigabitEthernet 1/0/2
Switch_A(config-if)#qos trust mode untrust
Switch_A(config-if)#qos port-priority 0
Switch_A(config-if)#exit
```

3) Map the 802.1p priority 0 to TC-1 and map the 802.1p priority 1 to TC-0.

```
Switch_A(config)#qos cos-map 0 1
Switch_A(config)#qos cos-map 1 0
```

- 4) Set the scheduler type of TC-0 and TC-1 as Weighted for egress port 1/0/3. Specify the queue weight of TC-0 as 1 and specify the queue weight of TC-1 as 5.

```
Switch_A(config)#interface gigabitEthernet 1/0/3
Switch_A(config-if)#qos queue 0 mode wrr weight 1
Switch_A(config-if)#qos queue 1 mode wrr weight 5
Switch_A(config-if)#end
Switch_A#copy running-config startup-config
```

Verify the configurations

Verify the trust mode of the port:

```
Switch_A#show qos trust interface
```

Port	Trust Mode	LAG
-----	-----	-----
Gi1/0/1	untrust	N/A
Gi1/0/2	untrust	N/A
Gi1/0/3	untrust	N/A
Gi1/0/4	untrust	N/A
...		

Verify the port to 802.1p mappings:

```
Switch_A#show qos port-priority interface
```

Port	CoS Value	LAG
-----	-----	-----
Gi1/0/1	CoS 1	N/A
Gi1/0/2	CoS 0	N/A
Gi1/0/3	CoS 0	N/A
Gi1/0/4	CoS 0	N/A
...		

Verify the 802.1p to queue mappings:

```
Switch_A#show qos cos-map
-----+-----+-----+-----+-----+-----+-----+-----+-----
Dot1p Value |0   |1   |2   |3   |4   |5   |6   |7
-----+-----+-----+-----+-----+-----+-----+-----+-----
TC           |TC1 |TC0 |TC2 |TC4 |TC4 |TC5 |TC6 |TC7
-----+-----+-----+-----+-----+-----+-----+-----+-----
```

Verify the scheduler mode of the egress port:

```
Switch_A#show qos queue interface gigabitEthernet 1/0/3
```

```
Gi1/0/3----LAG: N/A
```

```
Queue  Schedule Mode  Weight
```

```
-----  -----  -----
TC0     WRR       1
TC1     WRR       5
TC2     WRR       1
TC3     WRR       1
TC4     WRR       1
TC5     WRR       1
TC6     WRR       1
TC7     WRR       1
```

6.2 Example for Voice VLAN

6.2.1 Network Requirements

As shown below, the company plans to install IP phones in the office area. To ensure the good voice quality, IP phones and the computers will be connected to the different ports of the switch, and the voice traffic requires a higher priority than the data traffic.

Figure 6-5 Voice VLAN Application Topology

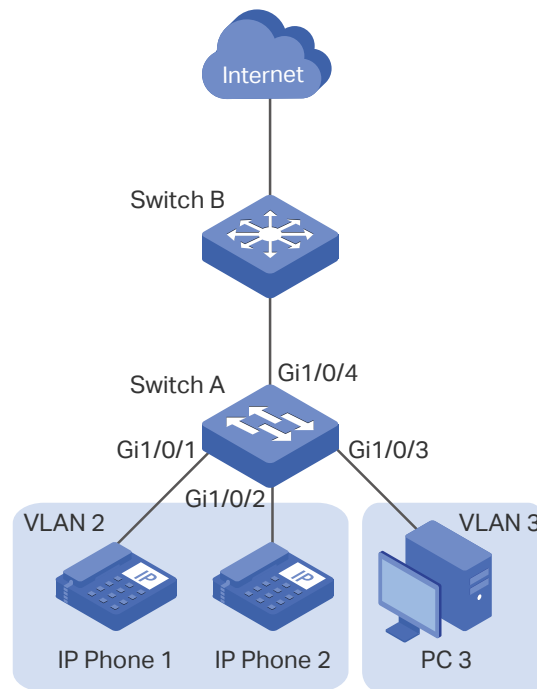

6.2.2 Configuration Scheme

To implement this requirement, you can configure Voice VLAN to ensure that the voice traffic can be transmitted in the same VLAN and the data traffic is transmitted in another VLAN. In addition, specify the priority to make the voice traffic can take precedence when the congestion occurs.

- 1) Configure 802.1Q VLAN for port 1/0/1, port 1/0/2, port 1/0/3 and port 1/0/4.
- 2) Configure Voice VLAN feature on port 1/0/1 and port 1/0/2.

Demonstrated with SG6654XHP, the following sections provide configuration procedure in two ways: using the GUI and using the CLI.

6.2.3 Using the GUI

- 1) Choose the menu **L2 FEATURES > VLAN > 802.1Q VLAN > VLAN Config** and click **+ Add** to load the following page. Create VLAN 2 and add untagged port 1/0/1, port 1/0/2 and port 1/0/4 to VLAN 2. Click **Create**.

Figure 6-6 Configuring VLAN 2

The screenshot shows the 'VLAN Config' interface. At the top, the 'VLAN ID' is set to 2 and the 'VLAN Name' is 'Voice_VLAN'. Below this, the 'Untagged Ports' section is active. A 'Port' field contains '1/0/1-2,1/0/4'. A grid of port icons is displayed, with ports 1, 2, 3, and 4 highlighted in blue to indicate they are selected. A legend below the grid shows a blue icon for 'Selected', a white icon for 'Unselected', and a grey icon for 'Not Available'. The 'Tagged Ports' section is currently empty. At the bottom right, there are 'Cancel' and 'Create' buttons, with the 'Create' button highlighted in red.

- 2) Click **+** Add to load the following page. Create VLAN 3 and add untagged port 1/0/3 and port 1/0/4 to VLAN 3. Click **Create**.

Figure 6-7 Configuring VLAN 3

VLAN Config

VLAN ID: (2-4094, format: 2,4-5,8)

VLAN Name: (1-16 characters)

Untagged Ports

Port: (Format: 1/0/1, input or choose below)

UNIT1
LAGS

1	3	5	7	9	11	13	15	17	19	21	23	25	27	29	31	33	35	37	39
2	4	6	8	10	12	14	16	18	20	22	24	26	28	30	32	34	36	38	40
41	43	45	47	49	51	53													
42	44	46	48	50	52	54													

Select All

Selected
 Unselected
 Not Available

Tagged Ports

Port: (Format: 1/0/1, input or choose below)

UNIT1
LAGS

1	3	5	7	9	11	13	15	17	19	21	23	25	27	29	31	33	35	37	39
---	---	---	---	---	----	----	----	----	----	----	----	----	----	----	----	----	----	----	----

Cancel
Create

- 3) Choose the menu **L2 FEATURES > VLAN > 802.1Q VLAN > Port Config** to load the following page. Disable the Ingress Checking feature on port 1/0/1 and port 1/0/2 and specify the PVID as 2. Click **Apply**.

Figure 6-8 Specifying the Parameters of the Ports

Port Config

UNIT1

LAGS

<input type="checkbox"/>	Port	PVID	Ingress Checking	Acceptable Frame Types	LAG	Details
<input checked="" type="checkbox"/>	1/0/1	2	Disabled	Admit All	---	Details
<input checked="" type="checkbox"/>	1/0/2	2	Disabled	Admit All	---	Details
<input type="checkbox"/>	1/0/3	1	Enabled	Admit All	---	Details
<input type="checkbox"/>	1/0/4	1	Enabled	Admit All	---	Details
<input type="checkbox"/>	1/0/5	1000	Enabled	Admit All	---	Details
<input type="checkbox"/>	1/0/6	1	Enabled	Admit All	---	Details
<input type="checkbox"/>	1/0/7	1	Enabled	Admit All	---	Details
<input type="checkbox"/>	1/0/8	1	Enabled	Admit All	---	Details
<input type="checkbox"/>	1/0/9	1	Enabled	Admit All	---	Details
<input type="checkbox"/>	1/0/10	1	Enabled	Admit All	---	Details

Total: 54
2 entries selected.

Cancel
Apply

- 4) Choose the menu **QoS > Voice VLAN > OUI Config** to load the following page. Check the OUI table.

Figure 6-9 Checking the OUI Table

OUI Config			
<input type="checkbox"/>	OUI	Status	Description
<input type="checkbox"/>	00:01:E3	Default	SIEMENS
<input type="checkbox"/>	00:03:6B	Default	CISCO1
<input type="checkbox"/>	00:04:0D	Default	AVAYA1
<input type="checkbox"/>	00:04:13	Default	SNOM
<input type="checkbox"/>	00:0F:E2	Default	H3C
<input type="checkbox"/>	00:12:43	Default	CISCO2
<input type="checkbox"/>	00:1B:4F	Default	AVAYA2
<input type="checkbox"/>	00:60:B9	Default	NITSUKO
<input type="checkbox"/>	00:D0:1E	Default	PINTEL
<input type="checkbox"/>	00:E0:75	Default	VERILINK
Total: 11			

- 5) Choose the menu **QoS > Voice VLAN > Global Config** to load the following page. Enable Voice VLAN globally. Specify the VLAN ID as 2 and set the priority as 7. Click **Apply**.

Figure 6-10 Configuring Voice VLAN Globally

Global Config	
Voice VLAN:	<input checked="" type="checkbox"/> Enable
VLAN ID:	<input type="text" value="2"/> (2-4094)
Priority:	<input type="text" value="7"/>
<input type="button" value="Apply"/>	

- 6) Choose the menu **QoS > Voice VLAN > Port Config** to load the following page. Enable Voice VLAN on port 1/0/1 and port 1/0/2. Click **Apply**.

Figure 6-11 Enabling Voice VLAN on Ports

Port Config

UNIT1 LAGS

<input type="checkbox"/>	Port	Voice VLAN	Operational Status
<input checked="" type="checkbox"/>	1/0/1	Enabled	Inactive
<input checked="" type="checkbox"/>	1/0/2	Enabled	Inactive
<input type="checkbox"/>	1/0/3	Disabled	Inactive
<input type="checkbox"/>	1/0/4	Disabled	Inactive
<input type="checkbox"/>	1/0/5	Disabled	Inactive
<input type="checkbox"/>	1/0/6	Disabled	Inactive
<input type="checkbox"/>	1/0/7	Disabled	Inactive
<input type="checkbox"/>	1/0/8	Disabled	Inactive
<input type="checkbox"/>	1/0/9	Disabled	Inactive
<input type="checkbox"/>	1/0/10	Disabled	Inactive

Total: 54 2 entries selected. Cancel Apply

7) Click  Save to save the settings.

6.2.4 Using the CLI

1) Create VLAN 2 and add untagged port 1/0/1, port 1/0/2 and port 1/0/4 to VLAN 2.

```
Switch_A#configure
```

```
Switch_A(config)#vlan 2
```

```
Switch_A(config-vlan)#name VoiceVLAN
```

```
Switch_A(config-vlan)#exit
```

```
Switch_A(config)#interface gigabitEthernet 1/0/1
```

```
Switch_A(config-if)#switchport general allowed vlan 2 untagged
```

```
Switch_A(config-if)#exit
```

```
Switch_A(config)#interface gigabitEthernet 1/0/2
```

```
Switch_A(config-if)#switchport general allowed vlan 2 untagged
```

```
Switch_A(config-if)#exit
```

```
Switch_A(config)#interface gigabitEthernet 1/0/4
```

```
Switch_A(config-if)#switchport general allowed vlan 2 untagged
```

```
Switch_A(config-if)#exit
```

2) Create VLAN 3 and add untagged port 1/0/3 and port 1/0/4 to VLAN 3.

```
Switch_A(config)#vlan 3
```

```
Switch_A(config-vlan)#name VLAN3
```

```
Switch_A(config-vlan)#exit
```

```
Switch_A(config)#interface gigabitEthernet 1/0/3
```

```
Switch_A(config-if)#switchport general allowed vlan 3 untagged
```

```
Switch_A(config-if)#exit
```

```
Switch_A(config)#interface gigabitEthernet 1/0/4
```

```
Switch_A(config-if)#switchport general allowed vlan 3 untagged
```

```
Switch_A(config-if)#exit
```

- 3) Disable the Ingress Checking feature on port 1/0/1 and port 1/0/2 and specify the PVID as 2.

```
Switch_A(config)#interface gigabitEthernet 1/0/1
```

```
Switch_A(config-if)#no switchport check ingress
```

```
Switch_A(config-if)#switchport pvid 2
```

```
Switch_A(config-if)#exit
```

```
Switch_A(config)#interface gigabitEthernet 1/0/2
```

```
Switch_A(config-if)#no switchport check ingress
```

```
Switch_A(config-if)#switchport pvid 2
```

```
Switch_A(config-if)#exit
```

- 4) Check the OUI table.

```
Switch(config)#show voice vlan oui
```

```
00:01:E3   Default   SIEMENS
```

```
00:03:6B   Default   CISCO1
```

```
00:12:43   Default   CISCO2
```

```
00:0F:E2   Default   H3C
```

```
00:60:B9   Default   NITSUKO
```

```
00:D0:1E   Default   PINTEL
```

```
00:E0:75   Default   VERILINK
```

```
00:E0:BB   Default   3COM
```

```
00:04:0D   Default   AVAYA1
```

```
00:1B:4F   Default   AVAYA2
```

```
00:04:13   Default   SNOM
```

- 5) Enable Voice VLAN globally. Specify the VLAN ID as 2 and set the priority as 7.

```
Switch_A(config)#voice vlan 2
```

```
Switch_A(config)#voice vlan priority 7
```

- 6) Enable Voice VLAN on port 1/0/1 and port 1/0/2.

```
Switch_A(config)#interface gigabitEthernet 1/0/1
```

```
Switch_A(config-if)#voice vlan
```

```
Switch_A(config-if)#exit
```

```
Switch_A(config)#interface gigabitEthernet 1/0/2
```

```
Switch_A(config-if)#voice vlan
```

```
Switch_A(config-if)#end
```

```
Switch_A#copy running-config startup-config
```

Verify the configurations

Verify the basic VLAN configuration:

```
Switch_A(config)#show vlan brief
```

VLAN	Name	Status	Ports
1	System-VLAN	active	Gi1/0/1, Gi1/0/2, Gi1/0/3, Gi1/0/4, Gi1/0/5, Gi1/0/6, Gi1/0/7, Gi1/0/8, Gi1/0/9, Gi1/0/10, Gi1/0/11, Gi1/0/12, Gi1/0/13, Gi1/0/14, Gi1/0/15, Gi1/0/16, Gi1/0/17, Gi1/0/18, Gi1/0/19, Gi1/0/20, Gi1/0/21, Gi1/0/22, Gi1/0/23, Gi1/0/24, Gi1/0/25, Gi1/0/26, Gi1/0/27, Gi1/0/28
2	VoiceVLAN	active	Gi1/0/1, Gi1/0/2, Gi1/0/4
3	VLAN3	active	Gi1/0/3, Gi1/0/4

Verify the Voice VLAN configuration:

```
Switch_A(config)#show voice vlan interface
```

```
Voice VLAN ID      2
```

```
Priority            7
```

Interface	Voice VLAN Mode	Operational Status	LAG
-----	-----	-----	---
Gi1/0/1	enabled	Up	N/A
Gi1/0/2	enabled	Up	N/A
Gi1/0/3	disabled	Down	N/A
Gi1/0/4	disabled	Down	N/A
Gi1/0/5	disabled	Down	N/A
...			
Gi1/0/28	disabled	Down	N/A

6.3 Example for Auto VoIP

6.3.1 Network Requirements

As shown below, the company plans to install IP phones in the office area. IP phones share switch ports used by computers, because no more ports are available for IP phones. To ensure the good voice quality, the voice traffic requires a higher priority than the data traffic.

Figure 6-12 Auto VoIP Application Topology

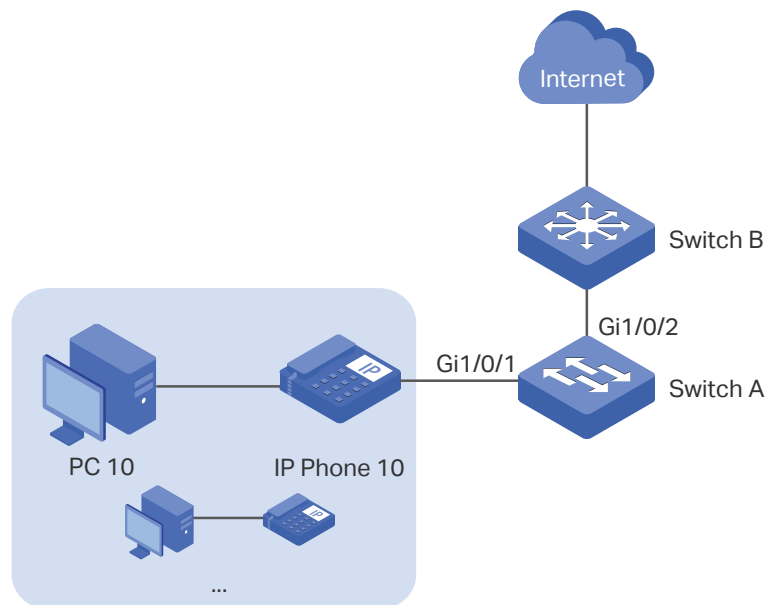

6.3.2 Configuration Scheme

To optimize voice traffic, configure Auto VoIP and LLDP-MED to instruct IP Phones to send traffic with desired DSCP priority. Voice traffic is put in the desired queue and data traffic is put in other queues according to the Class of Service configurations. Make sure that the voice traffic can take precedence when congestion occurs.

- 1) Enable the Auto VoIP feature and configure the DSCP value of ports.
- 2) Configure Class of Service.
- 3) Enable LLDP-MED and configure the corresponding parameters.

Demonstrated with SG6654XHP, the following sections provide configuration procedure in two ways: using the GUI and using the CLI.

6.3.3 Using the GUI

Auto VoIP configurations for port 1/0/1 and other ports connected to the IP phone are the same, the following configuration procedures take port 1/0/1 as example.

- 1) Choose the menu **QoS > Auto VoIP** to load the following page. Enable Auto VoIP globally and specify the DSCP value of port 1/0/1 as 63. Click **Apply**.

Figure 6-13 Configuring Auto VoIP

The screenshot shows the configuration interface for Auto VoIP. In the 'Global Config' section, the 'Auto VoIP' checkbox is checked, and the 'Enable' radio button is selected. An 'Apply' button is visible in the top right. In the 'Port Config' section, a table lists ports from 1/0/1 to 1/0/10. The row for port 1/0/1 is selected, with a checkmark in the first column and '63' in the 'DSCP Value' column. A 'DSCP Value' input field above the table also contains '63'. At the bottom, there are 'Cancel' and 'Apply' buttons, with the 'Apply' button highlighted in red.

UNIT1	Port	Interface Mode	Value	CoS Override Mode	Operational Status	DSCP Value
<input checked="" type="checkbox"/>	1/0/1	Disable	0	Disabled	Disabled	63
<input type="checkbox"/>	1/0/2	Disable	0	Disabled	Disabled	0
<input type="checkbox"/>	1/0/3	Disable	0	Disabled	Disabled	0
<input type="checkbox"/>	1/0/4	Disable	0	Disabled	Disabled	0
<input type="checkbox"/>	1/0/5	Disable	0	Disabled	Disabled	0
<input type="checkbox"/>	1/0/6	Disable	0	Disabled	Disabled	0
<input type="checkbox"/>	1/0/7	Disable	0	Disabled	Disabled	0
<input type="checkbox"/>	1/0/8	Disable	0	Disabled	Disabled	0
<input type="checkbox"/>	1/0/9	Disable	0	Disabled	Disabled	0
<input type="checkbox"/>	1/0/10	Disable	0	Disabled	Disabled	0

- 2) Choose the menu **QoS > Class of Service > Port Priority** to load the following page. Set the trust mode of port 1/0/1 as trust DSCP. Click **Apply**.

Figure 6-14 Configuring Port Priority

Port Priority Config

UNIT1 LAGS

<input type="checkbox"/>	Port	802.1p Priority	Trust Mode	LAG
<input checked="" type="checkbox"/>	1/0/1	1	Trust DSCP	--
<input type="checkbox"/>	1/0/2	0	Untrusted	--
<input type="checkbox"/>	1/0/3	0	Untrusted	--
<input type="checkbox"/>	1/0/4	0	Untrusted	--
<input type="checkbox"/>	1/0/5	0	Untrusted	--
<input type="checkbox"/>	1/0/6	0	Untrusted	--
<input type="checkbox"/>	1/0/7	0	Untrusted	--
<input type="checkbox"/>	1/0/8	0	Untrusted	--
<input type="checkbox"/>	1/0/9	0	Untrusted	--
<input type="checkbox"/>	1/0/10	0	Untrusted	--

Total: 54 1 entry selected. Cancel Apply

- Choose the menu **QoS > Class of Service > DSCP Priority** to load the following page. Specify the 802.1p priority as 7 for DSCP priority 63. Click **Apply**.

Figure 6-15 Specifying the 802.1p priority for DSCP priority 63

DSCP Priority Config

<input type="checkbox"/>	DSCP Priority	802.1p Priority	DSCP Remap
<input type="checkbox"/>	54	6	54
<input type="checkbox"/>	55	6	55
<input type="checkbox"/>	56	7	56 cs7 (111000)
<input type="checkbox"/>	57	7	57
<input type="checkbox"/>	58	7	58
<input type="checkbox"/>	59	7	59
<input type="checkbox"/>	60	7	60
<input type="checkbox"/>	61	7	61
<input type="checkbox"/>	62	7	62
<input checked="" type="checkbox"/>	63	7	63

Total: 64 1 entry selected. Cancel Apply

- Specify the 802.1p priority as 5 for other DSCP priorities. Click **Apply**.

Figure 6-16 Specifying the 802.1p priority for Other DSCP priorities

DSCP Priority Config

<input type="checkbox"/>	DSCP Priority	802.1p Priority	DSCP Remap
<input type="checkbox"/>		5	
<input checked="" type="checkbox"/>	54	5	54
<input checked="" type="checkbox"/>	55	5	55
<input checked="" type="checkbox"/>	56	5	56 cs7 (111000)
<input checked="" type="checkbox"/>	57	5	57
<input checked="" type="checkbox"/>	58	5	58
<input checked="" type="checkbox"/>	59	5	59
<input checked="" type="checkbox"/>	60	5	60
<input checked="" type="checkbox"/>	61	5	61
<input checked="" type="checkbox"/>	62	5	62
<input type="checkbox"/>	63	7	63

Total: 64 63 entries selected.

- Choose the menu **QoS > Class of Service > Scheduler Settings** to load the following page. Set the scheduler mode as weighted and specify the queue weight as 1 for TC-5. Click **Apply**.

Figure 6-17 Configuring the TC-5 for the Port

Scheduler Config

UNIT1 LAGS

Selected Unselected Not Available

Port 1/0/2

<input type="checkbox"/>	Queue TC-id	Scheduler Type	Queue Weight	Management Type
<input type="checkbox"/>		Weighted	1	
<input type="checkbox"/>	0	Weighted	1	Taildrop
<input type="checkbox"/>	1	Weighted	1	Taildrop
<input type="checkbox"/>	2	Weighted	1	Taildrop
<input type="checkbox"/>	3	Weighted	1	Taildrop
<input type="checkbox"/>	4	Weighted	1	Taildrop
<input checked="" type="checkbox"/>	5	Weighted	1	Taildrop
<input type="checkbox"/>	6	Weighted	1	Taildrop
<input type="checkbox"/>	7	Weighted	1	Taildrop

Total: 8 1 entry selected.

- Set the scheduler mode as weighted and specify the queue weight as 10 for TC-7. Click **Apply**.

Figure 6-18 Configuring the TC-7 for the Port

Scheduler Config				
<input type="checkbox"/>	Queue TC-id	Scheduler Type	Queue Weight	Management Type
		Weighted	10	
<input type="checkbox"/>	0	Weighted	1	Taildrop
<input type="checkbox"/>	1	Weighted	1	Taildrop
<input type="checkbox"/>	2	Weighted	1	Taildrop
<input type="checkbox"/>	3	Weighted	1	Taildrop
<input type="checkbox"/>	4	Weighted	1	Taildrop
<input type="checkbox"/>	5	Weighted	1	Taildrop
<input type="checkbox"/>	6	Weighted	1	Taildrop
<input checked="" type="checkbox"/>	7	Weighted	10	Taildrop

Total: 8 1 entry selected. Cancel Apply

- 7) Choose the menu **L2 FEATURES > LLDP > LLDP-MED Config > Port Config** and click Detail of port1/0/1 to load the following page. Check the boxes of all the TLVs. Click **Save**.

Figure 6-19 Configuring the TLVs

Included TLVs Detail(Port:1/0/1)

Included TLVs

All
 Network Policy
 Location Identification
 Extended Power-Via-MDI
 Inventory

Location Identification Parameters

Emergency Number
 Civic Address (Parameters in total should not exceed 230 characters in length)

What:

Country Code:

Language:

Province/State:

City/Township:

County/Parish/District:

Street:

House Number:

Name:

Postal/Zip Code:

Room Number:

Cancel
Save

- 8) Choose the menu **L2 FEATURES > LLDP > LLDP-MED Config > Port Config** to load the following page. Enable LLDP-MED on port 1/0/1. Click **Apply**.

Figure 6-20 Enabling LLDP-MED on the Port

The screenshot shows the 'Port Config' interface for 'UNIT1'. It features a table with columns for 'Port', 'LLDP-MED Status', and 'Included TLVs'. The 'LLDP-MED Status' column is highlighted with a red box, and the 'Apply' button at the bottom right is also highlighted with a red box. The table shows that port 1/0/1 is selected (checkbox checked) and has 'LLDP-MED Status' set to 'Enabled'. Other ports (1/0/2 to 1/0/10) are not selected and have 'LLDP-MED Status' set to 'Disabled'. The 'Included TLVs' column contains a 'Detail' link for each row. At the bottom, there is a 'Total: 54' indicator, '1 entry selected.', and 'Cancel' and 'Apply' buttons.

Port	LLDP-MED Status	Included TLVs
<input checked="" type="checkbox"/> 1/0/1	Enabled	Detail
<input type="checkbox"/> 1/0/2	Disabled	Detail
<input type="checkbox"/> 1/0/3	Disabled	Detail
<input type="checkbox"/> 1/0/4	Disabled	Detail
<input type="checkbox"/> 1/0/5	Disabled	Detail
<input type="checkbox"/> 1/0/6	Disabled	Detail
<input type="checkbox"/> 1/0/7	Disabled	Detail
<input type="checkbox"/> 1/0/8	Disabled	Detail
<input type="checkbox"/> 1/0/9	Disabled	Detail
<input type="checkbox"/> 1/0/10	Disabled	Detail

- 9) Click  to save the settings.

6.3.4 Using the CLI

- 1) Enable Auto VoIP globally and specify the DSCP value of port 1/0/1 as 63.

```
Switch_A#configure
```

```
Switch_A(config)#auto-voip
```

```
Switch_A(config)#interface gigabitEthernet 1/0/1
```

```
Switch_A(config-if)#auto-voip dscp 63
```

```
Switch_A(config-if)#exit
```

- 2) Set the trust mode of port 1/0/1 as trust DSCP. Specify the 802.1p priority as 7 for DSCP priority 63 and specify 802.1p priority as 5 for other DSCP priorities.

```
Switch_A(config)#interface gigabitEthernet 1/0/1
```

```
Switch_A(config-if)#qos trust mode dscp
```

```
Switch_A(config-if)#exit
```

```
Switch_A(config)#qos dscp-map 63 7
```

```
Switch_A(config)#qos dscp-map 0-62 5
```

- 3) On port 1/0/1, set the scheduler mode as weighted and specify the queue weight as 1 for TC-5. Set the scheduler mode as weighted and specify the queue weight as 10 for TC-7.

```
Switch_A(config)#interface gigabitEthernet 1/0/1
```

```
Switch_A(config-if)#qos queue 5 mode wrr weight 1
```

```
Switch_A(config-if)#qos queue 7 mode wrr weight 10
```

```
Switch_A(config-if)#exit
```

- 4) Enable LLDP-MED on port 1/0/1 and select all the TLVs to be included in outgoing LLDPDU.

```
Switch_A(config)#interface gigabitEthernet 1/0/1
```

```
Switch_A(config-if)#lldp med-status
```

```
Switch_A(config-if)#lldp med-tlv-select all
```

```
Switch_A(config-if)#end
```

```
Switch_A#copy running-config startup-config
```

Verify the configurations

Verify the configuration of Auto VoIP:

```
Switch_A(config)#show auto-voip
```

```
Administrative Mode: Enabled
```

Verify the Auto VoIP configuration of ports:

```
Switch_A(config)#show auto-voip interface
```

```
Interface.Gi1/0/1
```

```
Auto-VoIP Interface Mode.      Disabled
```

```
Auto-VoIP COS Override.        False
```

```
Auto-VoIP DSCP Value.         63
```

```
Auto-VoIP Port Status.        Disabled
```

```
Interface.Gi1/0/2
```

```
Auto-VoIP Interface Mode.      Disabled
```

```
Auto-VoIP COS Override.        False
```

```
Auto-VoIP DSCP Value.         0
```

```
Auto-VoIP Port Status.        Disabled
```

```
Interface.Gi1/0/3
```

```
Auto-VoIP Interface Mode.      Disabled
```

```
Auto-VoIP COS Override.        False
```

```
Auto-VoIP DSCP Value.         0
```

```
Auto-VoIP Port Status.        Disabled
```

...

Verify the configuration of Class of Service:

```
Switch_A(config)#show qos trust interface gigabitEthernet 1/0/1
```

```
Port      Trust Mode  LAG
```

```
-----  -
```

```
Gi1/0/1  trust DSCP  N/A
```

```
Switch_A(config)#show qos cos-map
-----+-----+-----+-----+-----+-----+-----+-----+-----
Dot1p Value |0   |1   |2   |3   |4   |5   |6   |7
-----+-----+-----+-----+-----+-----+-----+-----+-----
TC          |TC1 |TC0 |TC2 |TC3 |TC4 |TC5 |TC6 |TC7
```

```
Switch_A(config)#show qos dscp-map
DSCP:          0  1  2  3  4  5  6  7
DSCP to 802.1P 5  5  5  5  5  5  5  5
-----
DSCP:          8  9 10 11 12 13 14 15
DSCP to 802.1P 5  5  5  5  5  5  5  5
-----
DSCP:         16 17 18 19 20 21 22 23
DSCP to 802.1P 5  5  5  5  5  5  5  5
-----
DSCP:         24 25 26 27 28 29 30 31
DSCP to 802.1P 5  5  5  5  5  5  5  5
-----
DSCP:         32 33 34 35 36 37 38 39
DSCP to 802.1P 5  5  5  5  5  5  5  5
-----
DSCP:         40 41 42 43 44 45 46 47
DSCP to 802.1P 5  5  5  5  5  5  5  5
-----
DSCP:         48 49 50 51 52 53 54 55
DSCP to 802.1P 5  5  5  5  5  5  5  5
-----
DSCP:         56 57 58 59 60 61 62 63
```

```
DSCP to 802.1P 5 5 5 5 5 5 5 7
               -----
```

Verify the configuration of LLDP-MED:

```
Switch_A(config)#show lldp interface
```

LLDP interface config:

```
gigabitEthernet 1/0/1:
```

```
Admin Status:      TxRx
SNMP Trap:         Disabled
TLV                Status
---              -----
Port-Description   Yes
System-Capability  Yes
System-Description Yes
System-Name        Yes
Management-Address Yes
Port-VLAN-ID       Yes
Protocol-VLAN-ID   Yes
VLAN-Name          Yes
Link-Aggregation   Yes
MAC-Physic         Yes
Max-Frame-Size     Yes
Power              Yes
LLDP-MED Status:   Enabled
TLV                Status
---              -----
Network Policy     Yes
```

Location Identification	Yes
Extended Power Via MDI	Yes
Inventory Management	Yes
...	

7 Appendix: Default Parameters

Default settings of Class of Service are listed in the following tables.

Table 7-1 Default Settings of Port Priority Configuration

Parameter	Default Setting
802.1P Priority	0
Trust Mode	Untrusted

Table 7-2 Default Settings of 802.1p to Queue Mapping

802.1p Priority	Queues (8)
0	TC1
1	TC0
2	TC2
3	TC3
4	TC4
5	TC5
6	TC6
7	TC7

Table 7-3 Default Settings of 802.1p Remap Configuration

Original 802.1p Priority	New 802.1p Priority
0	0
1	1
2	2
3	3
4	4
5	5
6	6
7	7

Table 7-4 Default Settings of DSCP to 802.1p Mapping

DSCP	802.1p Priority
0 to 7	0
8 to 15	1

DSCP	802.1p Priority
16 to 23	2
24 to 31	3
32 to 39	4
40 to 47	5
48 to 55	6
56 to 63	7

Table 7-5 Default Settings of DSCP Remap Configuration

Original DSCP	New DSCP	Original DSCP	New DSCP	Original DSCP	New DSCP
0	0 be (000000)	22	22 af23 (010110)	44	44
1	1	23	23	45	45
2	2	24	24 cs3 (011000)	46	46 ef (101110)
3	3	25	25	47	47
4	4	26	26 af31 (011010)	48	48 cs6 (110000)
5	5	27	27	49	49
6	6	28	28 af32 (011100)	50	50
7	7	29	29	51	51
8	8 cs1 (001000)	30	30 af33 (011110)	52	52
9	9	31	31	53	53
10	10 af11 (001010)	32	32 cs4 (100000)	54	54
11	11	33	33	55	55
12	12 af12 (001100)	34	34 af41 (100010)	56	56 cs7 (111000)
13	13	35	35	57	57
14	14 af13 (001110)	36	36 af42 (100100)	58	58
15	15	37	37	59	59
16	16 cs2 (010000)	38	38 af43 (100110)	60	60
17	17	39	39	61	61
18	18 af21 (010010)	40	40 cs5 (101000)	62	62
19	19	41	41	63	63
20	20 af22 (010100)	42	42		
21	21	43	43		

Table 7-6 Default Settings of Scheduler Settings Configuration

Parameter	Default Setting
Scheduler Type	Weighted
Queue Weight	1
Management Type	Taildrop

Default settings of Class of Service are listed in the following tables.

Table 7-7 Default Settings of Bandwidth Control

Parameter	Default Setting
Ingress Rate (0-1,000,000Kbps)	0
Egress Rate (0-1,000,000Kbps)	0

Table 7-8 Default Settings of Storm Control

Parameter	Default Setting
Rate Mode	kbps
Broadcast Threshold (0-1,000,000)	0
Multicast Threshold (0-1,000,000)	0
UL-Frame Threshold (0-1,000,000)	0
Action	Drop
Recover Time	0

Default settings of Voice VLAN are listed in the following tables.

Table 7-9 Default Settings of Global Configuration

Parameter	Default Setting
Voice VLAN	Disabled
VLAN ID	None
Priority	7

Table 7-10 Default Settings of Port Configuration

Parameter	Default Setting
Voice VLAN	Disabled

Table 7-11 Default Settings of OUI Table

OUI	Status	Description
00:01:E3	Default	SIEMENS
00:03:6B	Default	CISCO1
00:12:43	Default	CISCO2
00:0F:E2	Default	H3C
00:60:B9	Default	NITSUKO
00:D0:1E	Default	PINTEL
00:E0:75	Default	VERILINK
00:E0:BB	Default	3COM
00:04:0D	Default	AVAYA1
00:1B:4F	Default	AVAYA2
00:04:13	Default	SNOM

Default settings of Auto VoIP are listed in the following tables.

Table 7-12 Default Settings of Auto VoIP

Parameter	Default Setting
Interface Mode	Disabled
Value	None
Cos Override Mode	Disabled
DSCP Value	0

Part 25

Configuring Access Security

CHAPTERS

1. Access Security
2. Access Security Configurations
3. Appendix: Default Parameters

1 Access Security

1.1 Overview

Access Security provides different security measures for accessing the switch remotely so as to enhance the configuration management security.

1.2 Supported Features

Access Control

This function is used to control the users' access to the switch based on IP address, MAC address or port.

HTTP

This function is based on the HTTP protocol. It can allow or deny users to access the switch via a web browser.

HTTPS

This function is based on the SSL or TLS protocol working in transport layer. It supports a security access via a web browser.

SSH

This function is based on the SSH protocol, a security protocol established on application and transport layers. The function with SSH is similar to a telnet connection, but SSH can provide information security and powerful authentication.

Telnet

This function is based on the Telnet protocol subjected to TCP/IP protocol. Through Telnet, users can log on to the switch remotely.

Serial Port

 Note:

Serial Port is only available on certain devices. To check whether your device supports this feature, refer to the actual web interface. If Serial Port is available, there is **SECURITY > Access Security > Serial Port Config** in the menu structure.

You can configure the serial port parameters.

2 Access Security Configurations

With access security configurations, you can:

- Configure the Access Control feature
- Configure the HTTP feature
- Configure the HTTPS feature
- Configure the SSH feature
- Configure the Telnet function
- Configure the Serial Port parameters

2.1 Using the GUI

2.1.1 Configuring the Access Control Feature

Choose the menu **SECURITY > Access Security > Access Control** to load the following page.

Figure 2-1 Configuring the Access Control

Global Config

Access Control: Enable

Control Mode:

[Apply](#)

Entry Table

[+](#) Add [-](#) Delete

<input type="checkbox"/>	ID	Port/IP/MAC	Access Interface	Operation
No Entries in this table.				
Total: 0				

- 1) In the **Global Config** section, enable Access Control, select one control mode and click **Apply**.

Control Mode

Select the control mode for users to log in to the web management page.

IP-based: Only the users within the IP-range you set here are allowed to access the switch.

MAC-based: Only the users with the MAC address you set here are allowed to access the switch.

Port-based: Only the users connecting to the ports you set here are allowed to access the switch.

2) In the **Entry Config** section, click **+ Add** to add an Access Control entry.

- When the **IP-based** mode is selected, the following window will pop up.

Figure 2-2 Configuring Access Control Based on IP Range

Access Interface

Select the interfaces where to apply the Access Control rule. If an interface is unselected, all users can access the switch via it.

SNMP: A function to manage the network devices via NMS.

Telnet: A connection type for users to remote login.

SSH: A connection type based on SSH protocol.

HTTP: A connection type based on HTTP protocol.

HTTPS: A connection type based on SSL protocol.

Ping: A communication protocol to test the connection of the network.

IP Address/ Mask

Enter the IP address and mask to specify an IP range. Only the users within this IP range can access the switch via the specified interfaces.

- When the **MAC-based** mode is selected, the following window will pop up.

Figure 2-3 Configuring Access Control Entry Based on MAC Address

Access Interface

Select the interfaces where to apply the Access Control rule. If an interface is unselected, all users can access the switch via it.

SNMP: A function to manage the network devices via NMS.

Telnet: A connection type for users to remote login.

SSH: A connection type based on SSH protocol.

HTTP: A connection type based on HTTP protocol.

HTTPS: A connection type based on SSL protocol.

Ping: A communication protocol to test the connection of the network.

MAC Address

Enter the MAC address. Only the users with this MAC address can access the switch via the specified interfaces.

- When the **Port-based** mode is selected, the following window will pop up.

Figure 2-4 Configuring Access Control Entry Based on Port

Access Interface	<p>Select the interfaces where to apply the Access Control rule. If an interface is unselected, all users can access the switch via it.</p> <p>SNMP: A function to manage the network devices via NMS.</p> <p>Telnet: A connection type for users to remote login.</p> <p>SSH: A connection type based on SSH protocol.</p> <p>HTTP: A connection type based on HTTP protocol.</p> <p>HTTPS: A connection type based on SSL protocol.</p> <p>Ping: A communication protocol to test the connection of the network.</p>
Port	<p>Select one or more ports. Only the users who are connected to these ports can access the switch via the specified interfaces.</p>

3) Click **Create**. Then you can view the created entries in the table.

2.1.2 Configuring the HTTP Function

Choose the menu **SECURITY > Access Security > HTTP Config** to load the following page.

Figure 2-5 Configuring the HTTP Function

Global Config

HTTP: Enable

Port: (1-65535)

Apply

Session Config

Session Timeout: minutes (5-30)

Apply

Number of Access Users

Number Control: Enable

Number of Admins: (1-16)

Number of Operators: (0-15)

Number of Power Users: (0-15)

Number of Users: (0-15)

Apply

1) In the **Global Control** section, enable HTTP function, specify the port using for HTTP, and click **Apply** to enable the HTTP function.

HTTP	Enable or disable HTTP. When enabled, you can manage the switch through a web browser.
------	--

Port	Specify the port used for HTTP.
------	---------------------------------

- 2) In the **Session Config** section, specify the Session Timeout and click **Apply**.

Session Timeout	Specify the session timeout time. The system will log out automatically if users do nothing within the Session Timeout time.
-----------------	--

- 3) In the **Number of Access Users** section, enable Number Control function, specify the following parameters and click **Apply**.

Number Control	Enable or disable Number Control. When enabled, you can control the number of the users logging on to the web management page at the same time. The total number of users should be no more than 16.
----------------	--

Number of Admins	Specify the maximum number of users whose access level is Admin.
------------------	--

Number of Operators	Specify the maximum number of users whose access level is Operator.
---------------------	---

Number of Power Users	Specify the maximum number of users whose access level is Power User.
-----------------------	---

Number of Users	Specify the maximum number of users whose access level is User.
-----------------	---

2.1.3 Configuring the HTTPS Function

Choose the menu **SECURITY > Access Security > HTTPS Config** to load the following page.

Figure 2-6 Configuring the HTTPS Function

Global Config

HTTPS: Enable

Protocol Version: TLS Version 1.2 ▼

Port: 443 (1-65535)

Apply

Cipher Suite Config

RSA_WITH_RC4_128_MD5: Enable

RSA_WITH_RC4_128_SHA: Enable

RSA_WITH_DES_CBC_SHA: Enable

RSA_WITH_3DES_EDE_CBC_SHA: Enable

ECDHE_WITH_AES_128_GCM_SHA256: Enable

ECDHE_WITH_AES_256_GCM_SHA384: Enable

Apply

Session Config

Session Timeout: 10 minutes (5-30)

Apply

Number of Access Users

Number Control: Enable

Number of Admins: 1 (1-16)

Number of Operators: 0 (0-15)

Number of Power Users: 0 (0-15)

Number of Users: 0 (0-15)

Apply

- 1) In the **Global Config** section, enable HTTPS function, select the protocol version that the switch supports and specify the port using for HTTPS. Click **Apply**.

HTTPS

Enable or disable HTTPS.

HTTPS is based on the SSL or TLS protocol. It provides a secure connection between the client and the switch.

Protocol Version	<p>Select the protocol version for HTTPS. Make sure the protocol in use is compatible with that on your HTTPS client.</p> <p>SSL is a transport protocol. It can provide server authentication, encryption and message integrity to allow secure HTTP connection.</p> <p>TLS is a transport protocol upgraded from SSL. It can support a more secure connection than SSL. TLS and SSL are not compatible with each other.</p> <p>SSL Version 3.0: Select SSL Version 3.0 as the protocol for HTTPS.</p> <p>TLS Version 1.0: Select TLS Version 1.0 as the protocol for HTTPS.</p> <p>TLS Version 1.1: Select TLS Version 1.1 as the protocol for HTTPS.</p> <p>TLS Version 1.2: Select TLS Version 1.2 as the protocol for HTTPS.</p> <p>All: Enable all the above protocols for HTTPS. The HTTPS server and client will negotiate the protocol each time.</p>
Port	Specify the port number for HTTPS service.

- 2) In the **Cipher Suite Config** section, select the algorithm to be enabled and click **Apply**.

RSA_WITH_RC4_128_MD5	128-bit RC4 encryption with MD5 message authentication and RSA key exchange.
RSA_WITH_RC4_128_SHA	128-bit RC4 encryption with SHA-1 message authentication and RSA key exchange.
RSA_WITH_DES_CBC_SHA	56-bit DES encryption with SHA-1 message authentication and RSA key exchange.
RSA_WITH_3DES_EDE_CBC_SHA	168-bit Triple DES encryption with SHA-1 message authentication and RSA key exchange.
ECDHE_WITH_AES_128_GCM_SHA256	128-bit AES in Galois Counter Mode encryption with SHA-256 message authentication and elliptic curve Diffie-Hellman key exchange signed with an RSA certificate or ECDSA certificate.
ECDHE_WITH_AES_256_GCM_SHA384	256-bit AES in Galois Counter Mode encryption with SHA-384 message authentication and elliptic curve Diffie-Hellman key exchange signed with an RSA certificate or ECDSA certificate.

- 3) In the **Session Config** section, specify the Session Timeout and click **Apply**.

Session Timeout	The system will log out automatically if users are inactive for a time period equal to the Session Timeout time.
------------------------	--

- 4) In the **Number of Access Users** section, enable Number Control function, specify the following parameters and click **Apply**.

Number Control	Enable or disable Number Control. When enabled, you can control the number of the users logging on to the web management page at the same time. The total number of users should be no more than 16.
Number of Admins	Specify the maximum number of users whose access level is Admin.
Number of Operators	Specify the maximum number of users whose access level is Operator.
Number of Power Users	Specify the maximum number of users whose access level is Power User.
Number of Users	Specify the maximum number of users whose access level is User.

5) In the **Load Certificate** and **Load Key** section, download the certificate and key.

Certificate File	Select the desired certificate to download to the switch. The certificate must be BASE64 encoded. The SSL certificate and key downloaded must match each other, otherwise the HTTPS connection will not work.
Key File	Select the desired Key to download to the switch. The key must be BASE64 encoded. The SSL certificate and key downloaded must match each other, otherwise the HTTPS connection will not work.

 **Note:**

- The SSL certificate and key downloaded must match each other; otherwise the HTTPS connection will not work.
-

2.1.4 Configuring the SSH Feature

Choose the menu **SECURITY > Access Security > SSH Config** to load the following page.

Figure 2-7 Configuring the SSH Feature

Global Config

SSH: Enable

Protocol V2: Enable

Session Timeout: seconds (1-360)

Maximum Connections: (1-5)

Port: (1-65535)

[Apply](#)

Encryption Algorithm

AES-CBC: Enable

3DES-CBC: Enable

AES-CTR: Enable

AES-GCM: Enable

[Apply](#)

Data Integrity Algorithm

HMAC-SHA1: Enable

HMAC-MD5: Enable

HMAC-SHA2: Enable

UMAC: Enable

[Apply](#)

Import Key File

Choose the SSH public key file to be imported to the switch.

Key Type:

Key File: [Browse](#)

- 1) In the **Global Config** section, select **Enable** to enable SSH function and specify following parameters.

SSH	Enable or disable SSH. SSH is a protocol working in application layer and transport layer. It can provide a secure, remote connection to a device. It is more secure than Telnet protocol as it provides strong encryption.
Protocol V1	Enable or disable SSH version 1.
Protocol V2	Enable or disable SSH version 2.
Session Timeout	Specify the session timeout time. The system will automatically release the connection when the time is up.

Maximum Connections	Specify the maximum number of the connections to the SSH server. New connection will not be established when the number of the connections reaches the maximum number you set.
---------------------	--

Port	Specify the port using for SSH.
------	---------------------------------

- 2) In the **Encryption Algorithm** section, enable the encryption algorithm you want the switch to support and click **Apply**.
- 3) In **Data Integrity Algorithm** section, enable the integrity algorithm you want the switch to support and click **Apply**.
- 4) In **Import Key File** section, select key type from the drop-down list and click **Browse** to download the desired key file.

Key Type	Select the key type. The algorithm of the corresponding type is used for both key generation and authentication.
----------	--

Key File	Select the desired public key to download to the switch. The key length of the downloaded file ranges of 512 to 3072 bits.
----------	--

Note:

- This may take several minutes to import the key file. Please wait without operating the switch.
- After the key file is imported, the original key of the same type will be replaced. If the private key imported on the SSH client does not match the public key here, Password authentication will be used for SSH access.

2.1.5 Configuring the Telnet Function

Choose the menu **SECURITY > Access Security > Telnet Config** to load the following page.

Figure 2-8 Configuring the Telnet Function

Telnet Config

Telnet: Enable

Port: (1-65535)

[Apply](#)

Enable Telnet and click **Apply**.

Telnet	Enable or disable Telnet. Telnet is based on the Telnet protocol subjected to TCP/IP protocol. It allows users to log in to the switch remotely.
--------	--

Port	Specify the port used for Telnet.
------	-----------------------------------

2.1.6 Configuring the Serial Port Parameters

Note:

Serial Port is only available on certain devices. To check whether your device supports this feature, refer to the actual web interface. If Serial Port is available, there is **SECURITY > Access Security > Serial Port Config** in the menu structure.

Choose the menu **SECURITY > Access Security > Serial Port Config** to load the following page.

Figure 2-9 Configuring the Serial Port Parameters

Serial Port Settings

Baud Rate:

Data Bits: 8

Parity Bits: none

Stop Bits: 1

[Apply](#)

Configure the Baud Rate and click **Apply**.

Baud Rate	Configure the baud rate of the console connection. The default value is 38400 bps.
Data Bits	Displays the data bits.
Parity Bits	Displays the parity bits.
Stop Bits	Displays the stop bits.

2.2 Using the CLI

2.2.1 Configuring the Access Control Feature

Follow these steps to configure the access control:

Step 1	<p>configure</p> <p>Enter global configuration mode.</p>
--------	---

-
- Step 2
- Use the following command to control the users' access by limiting the IP address:
user access-control ip-based enable
Configure the control mode as IP-based.
user access-control ip-based { ip-addr ip-mask } [snmp] [telnet] [ssh] [http] [https] [ping] [all]
Only the users within a certain IP-range can access the switch via the specified interfaces.
ip-addr: Specify the IP address of the user.
ip-mask: Specify the subnet mask of the user.
[snmp] [telnet] [ssh] [http] [https] [ping] [all]: Select the interfaces where to apply the Access Control rule. If an interface is unselected, all users can access the switch via it. By default, all the interfaces are selected.
 - Use the following command to control the users' access by limiting the MAC address:
user access-control mac-based enable
Configure the control mode as MAC-based.
user access-control mac-based { mac-addr } [snmp] [telnet] [ssh] [http] [https] [ping] [all]
Only the users with a certain MAC address can access the switch via the specified interfaces.
mac-addr: Specify the MAC address of the user.
[snmp] [telnet] [ssh] [http] [https] [ping] [all]: Select the interfaces where to apply the Access Control rule. If an interface is unselected, all users can access the switch via it. By default, all the interfaces are selected.
 - Use the following command to control the users' access by limiting the ports connected to the users:
user access-control port-based enable
Configure the control mode as Port-based.
user access-control port-based interface { fastEthernet port-list | gigabitEthernet port-list | ten-gigabitEthernet port-list } [snmp] [telnet] [ssh] [http] [https] [ping] [all]
Only the users who are connected to certain ports can access the switch via the specified interfaces.
port-list: Specify the list of Ethernet port, in the format of 1/0/1-4. You can appoint 5 ports at most.
[snmp] [telnet] [ssh] [http] [https] [ping] [all]: Select the interfaces where to apply the Access Control rule. If an interface is unselected, all users can access the switch via it. By default, all the interfaces are selected.
-
- Step 3
- show user configuration**
- Verify the security configuration information of the user authentication information and the access interface.
-
- Step 4
- end**
- Return to privileged EXEC mode.
-

Step 5 **copy running-config startup-config**

Save the settings in the configuration file.

The following example shows how to set the type of access control as IP-based. Set the IP address as 192.168.0.100, set the subnet mask as 255.255.255.0, and select snmp, telnet, http and https to apply the Access Control rule.

Switch#configure**Switch(config)#user access-control ip-based enable**

Switch(config)#user access-control ip-based 192.168.0.100 255.255.255.255 snmp telnet http https

Switch(config)#show user configuration

User authentication mode: IP based

Index	IP Address	Access Interface
-----	-----	-----
1	192.168.0.100/24	SNMP Telnet HTTP HTTPS

Switch(config)#end**Switch#copy running-config startup-config**

2.2.2 Configuring the HTTP Function

Follow these steps to configure the HTTP function:

Step 1 **configure**

Enter global configuration mode.

Step 2 **ip http server**

Enable the HTTP function. By default, it is enabled.

Step 3 **ip http session timeout minutes**

Specify the Session Timeout time. The system will log out automatically if users do nothing within the Session Timeout time.

minutes: Specify the timeout time, which ranges from 5 to 30 minutes. The default value is 10.

-
- Step 4 **ip http max-users** *admin-num operator-num poweruser-num user-num*
- Specify the maximum number of users that are allowed to connect to the HTTP server. The total number of users should be no more than 16.
- admin-num*: Enter the maximum number of users whose access level is Admin. The valid values are from 1 to 16.
- operator-num*: Enter the maximum number of users whose access level is Operator. The valid values are from 0 to 15.
- poweruser-num*: Enter the maximum number of users whose access level is Power User. The valid values are from 0 to 15.
- user-num*: Enter the maximum number of users whose access level is User. The valid values are from 0 to 15.
-
- Step 5 **show ip http configuration**
- Verify the configuration information of the HTTP server, including status, session timeout, access-control, max-user number and the idle-timeout, etc.
-
- Step 6 **end**
- Return to privileged EXEC mode.
-
- Step 7 **copy running-config startup-config**
- Save the settings in the configuration file.
-

The following example shows how to set the session timeout as 9, set the maximum admin number as 6, and set the maximum operator number as 2, the maximum power user number as 2, the maximum user number as 2.

Switch#configure

Switch(config)#ip http server

Switch(config)#ip http session timeout 9

Switch(config)#ip http max-user 6 2 2 2

Switch(config)#show ip http configuration

HTTP Status:	Enabled
HTTP Port:	80
HTTP Session Timeout:	9
HTTP User Limitation:	Enabled
HTTP Max Users as Admin:	6
HTTP Max Users as Operator:	2
HTTP Max Users as Power User:	2
HTTP Max Users as User:	2

Switch(config)#end

Switch#copy running-config startup-config

2.2.3 Configuring the HTTPS Function

Follow these steps to configure the HTTPS function:

Step 1	configure Enter global configuration mode.
Step 2	ip http secure-server Enable the HTTPS function. By default, it is enabled.
Step 3	<p>ip http secure-protocol { ssl3 tls1 tls11 tls12 all }</p> <p>Select the protocol version for HTTPS. Make sure the protocol in use is compatible with that on your HTTPS client.</p> <p>SSL is a transport protocol. It can provide server authentication, encryption and message integrity to allow secure HTTP connection.</p> <p>TLS is a transport protocol upgraded from SSL. It can support a more secure connection than SSL. TLS and SSL are not compatible with each other.</p> <p>ssl3: Select SSL Version 3.0 as the protocol for HTTPS.</p> <p>tls1: Select TLS Version 1.0 as the protocol for HTTPS.</p> <p>tls11: Select TLS Version 1.1 as the protocol for HTTPS.</p> <p>tls12: Select TLS Version 1.2 as the protocol for HTTPS.</p> <p>all: Enable all the above protocols for HTTPS. The HTTPS server and client will negotiate the protocol each time.</p>
Step 4	<p>ip http secure-ciphersuite { [rc4-128-md5] [rc4-128-sha] [des-cbc-sha] [3des-ede-cbc-sha] [ecdhe-a128-g-s256] [ecdhe-a256-g-s384] }</p> <p>Enable the corresponding ciphersuite. By default, these types are all enabled.</p> <p>rc4-128-md5: 128-bit RC4 encryption with MD5 message authentication and RSA key exchange.</p> <p>rc4-128-sha: 128-bit RC4 encryption with SHA-1 message authentication and RSA key exchange.</p> <p>des-cbc-sha: 56-bit DES encryption with SHA-1 message authentication and RSA key exchange.</p> <p>3des-ede-cbc-sha: 168-bit Triple DES encryption with SHA-1 message authentication and RSA key exchange.</p> <p>ecdhe-a128-g-s256: 128-bit AES in Galois Counter Mode encryption with SHA-256 message authentication and elliptic curve Diffie-Hellman key exchange signed with an RSA certificate or ECDSA certificate.</p> <p>ecdhe-a256-g-s384: 256-bit AES in Galois Counter Mode encryption with SHA-384 message authentication and elliptic curve Diffie-Hellman key exchange signed with an RSA certificate or ECDSA certificate.</p>

Step 5	ip http secure-session timeout <i>minutes</i>
	Specify the Session Timeout time. The system will log out automatically if users do nothing within the Session Timeout time.
	<i>minutes</i> : Specify the timeout time, which ranges from 5 to 30 minutes. The default value is 10.

Step 6	ip http secure-max-users <i>admin-num operator-num poweruser-num user-num</i>
	Specify the maximum number of users that are allowed to connect to the HTTPS server. The total number of users should be no more than 16.
	<i>admin-num</i> : Enter the maximum number of users whose access level is Admin. The valid values are from 1 to 16.
	<i>operator-num</i> : Enter the maximum number of users whose access level is Operator. The valid values are from 0 to 15.
	<i>poweruser-num</i> : Enter the maximum number of users whose access level is Power User. The valid values are from 0 to 15.
	<i>user-num</i> : Enter the maximum number of users whose access level is User. The valid values are from 0 to 15.

Step 7	ip http secure-server download certificate <i>ssl-cert ip-address ip-addr</i>
	Download the desired certificate to the switch from TFTP server.
	<i>ssl-cert</i> : Specify the name of the SSL certificate, which ranges from 1 to 25 characters. The certificate must be BASE64 encoded. The SSL certificate and key downloaded must match each other.
	<i>ip-addr</i> : Specify the IP address of the TFTP server. Both IPv4 and IPv6 addresses are supported.

Step 8	ip http secure-server download key <i>ssl-key ip-address ip-addr</i>
	Download the desired key to the switch from TFTP server.
	<i>ssl-key</i> : Specify the name of the key file saved in TFTP server. The key must be BASE64 encoded.
	<i>ip-addr</i> : Specify the IP address of the TFTP server. Both IPv4 and IPv6 addresses are supported.

Step 9	show ip http secure-server
	Verify the global configuration of HTTPS.

Step 10	end
	Return to privileged EXEC mode.

Step 11	copy running-config startup-config
	Save the settings in the configuration file.

The following example shows how to configure the HTTPS function. Enable all the protocol versions, including SSL 3.0, TLS 1.0, TLS 1.1 and TLS1.2. Enable the ciphersuite of 3des-ede-cbc-sha. Set the session timeout time as 15, the maximum admin number as 2, the maximum operator number as 2, the maximum power user number as 2, the maximum user

number as 2. Download the certificate named ca.crt and the key named ca.key from the TFTP server with the IP address 192.168.0.100.

Switch#configure

Switch(config)#ip http secure-server

Switch(config)#ip http secure-protocol all

Switch(config)#ip http secure-ciphersuite 3des-edc-cbc-sha

Switch(config)#ip http secure-session timeout 15

Switch(config)#ip http secure-max-users 2 2 2 2

Switch(config)#ip http secure-server download certificate ca.crt ip-address 192.168.0.100

Start to download SSL certificate...

Download SSL certificate OK.

Switch(config)#ip http secure-server download key ca.key ip-address 192.168.0.100

Start to download SSL key...

Download SSL key OK.

Switch(config)#show ip http secure-server

HTTPS Status:	Enabled
HTTPS Port:	443
SSL Protocol Level(s):	all
SSL CipherSuite:	3des-edc-cbc-sha
HTTPS Session Timeout:	15
HTTPS User Limitation:	Enabled
HTTPS Max Users as Admin:	2
HTTPS Max Users as Operator:	2
HTTPS Max Users as Power User:	2
HTTPS Max Users as User:	2

Switch(config)#end

Switch#copy running-config startup-config

2.2.4 Configuring the SSH Feature

Follow these steps to configure the SSH function:

Step 1	configure Enter global configuration mode.
Step 2	ip ssh server Enable the SSH function. By default, it is enabled.
Step 3	ip ssh timeout value Specify the idle timeout time. The system will automatically release the connection when the time is up. <i>value</i> : Enter the value of the timeout time, which ranges from 1 to 120 seconds. The default value is 120 seconds.
Step 4	ip ssh max-client num Specify the maximum number of the connections to the SSH server. New connection will not be established when the number of the connections reaches the maximum number you set. <i>num</i> : Enter the number of the connections, which ranges from 1 to 5. The default value is 5.
Step 5	ip ssh algorithm { AES128-CBC AES192-CBC AES256-CBC Blowfish-CBC Cast128-CBC 3DES-CBC HMAC-SHA1 HMAC-MD5 } Enable the corresponding algorithm. By default, these types are all enabled. AES128-CBC AES192-CBC AES256-CBC Blowfish-CBC Cast128-CBC 3DES-CBC: Specify the encryption algorithm you want the switch supports. HMAC-SHA1 HMAC-MD5: Specify the data integrity algorithm you want the switch supports.
Step 6	ip ssh algorithm compatibility Enable compatibility configuration to allow SSH to use unsafe encryption algorithms.
Step 7	ip ssh download { v2 } key-file ip-address ip-addr Select the type of the key file and download the desired file to the switch from TFTP server. <i>v2</i> : Select the key type. The algorithm of the corresponding type is used for both key generation and authentication. <i>key-file</i> : Specify the name of the key file saved in TFTP server. Ensure the key length of the downloaded file is in the range of 512 to 3072 bits. <i>ip-addr</i> : Specify the IP address of the TFTP server. Both IPv4 and IPv6 addresses are supported.
Step 8	show ip ssh Verify the global configuration of SSH.
Step 9	end Return to privileged EXEC mode.

Step 10 copy running-config startup-config

Save the settings in the configuration file.

 **Note:**

It will take a long time to download the key file. Please wait without any operation.

The following example shows how to configure the SSH function. Set the version as SSH V1 and SSH V2. Enable the AES128-CBC and Cast128-CBC encryption algorithm. Enable the HMAC-MD5 data integrity algorithm. Choose the key type as SSH-2 RSA/DSA.

Switch(config)#ip ssh server

Switch(config)#ip ssh timeout 100

Switch(config)#ip ssh max-client 4

Switch(config)#ip ssh algorithm AES128-CBC

Switch(config)#ip ssh algorithm Cast128-CBC

Switch(config)#ip ssh algorithm HMAC-MD5

Switch(config)#ip ssh algorithm compatibility

This command will synchronously enable unsafe algorithms such as AES-CBC, 3DES-CBC, HMAC-SHA1, HMAC-MD5, etc. (yes/no)

Switch(config)#ip ssh download v2 publickey ip-address 192.168.0.100

Start to download SSH key file...

Download SSH key file OK.

Switch(config)#show ip ssh

Global Config:

SSH Server: Enabled

Protocol V1: Enabled

Protocol V2: Enabled

Idle Timeout: 100

MAX Clients: 4

Port: 22

Encryption Algorithm:

AES128-CBC: Enabled

AES192-CBC: Disabled

AES256-CBC: Disabled

```

Blowfish-CBC:  Disabled
Cast128-CBC:  Enabled
3DES-CBC:     Disabled
Data Integrity Algorithm:
HMAC-SHA1:    Disabled
HMAC-MD5:     Enabled
Key Type:     SSH-2 RSA/DSA
Key File:
---- BEGIN SSH2 PUBLIC KEY ----
Comment: "dsa-key-20160711"
Switch(config)#end
Switch#copy running-config startup-config

```

2.2.5 Configuring the Telnet Function

Follow these steps enable the Telnet function:

Step 1	configure Enter global configuration mode.
Step 2	telnet enable Enable the telnet function. By default, it is disabled.
Step 3	telnet port port Specify the port using for Telnet. It ranges from 1 to 65535.
Step 4	end Return to privileged EXEC mode.
Step 4	copy running-config startup-config Save the settings in the configuration file.

2.2.6 Configuring the Serial Port Parameters

Note:

Serial Port is only available on certain devices. To check whether your device supports this feature, refer to the actual web interface. If Serial Port is available, there is **SECURITY > Access Security > Serial Port Config** in the menu structure.

Follow these steps enable the serial port parameters:

-
- Step 1 **configure**
Enter global configuration mode.
-
- Step 2 **serial_port baud_rate { 9600 | 19200 | 38400 | 57600 | 115200 }**
Specify the baud rate of the console connection.

9600 | 19200 | 38400 | 57600 | 115200: Specify the communication baud rate on the console port. The default value is 38400 bps.
-
- Step 3 **end**
Return to privileged EXEC mode.
-
- Step 4 **copy running-config startup-config**
Save the settings in the configuration file.
-

3 Appendix: Default Parameters

Default settings of Access Security are listed in the following tables.

Table 3-1 Default Settings of Access Control Configuration

Parameter	Default Setting
Access Control	Disabled

Table 3-2 Default Settings of HTTP Configuration

Parameter	Default Setting
HTTP	Enabled
Port	80
Session Timeout	10 minutes
Number Control	Disabled

Table 3-3 Default Settings of HTTPS Configuration

Parameter	Default Setting
HTTPS	Enabled
Protocol Version	All
Port	443
RSA_WITH_RC4_128_MD5	Disabled
RSA_WITH_RC4_128_SHA	Disabled
RSA_WITH_DES_CBC_SHA	Disabled
RSA_WITH_3DES_EDE_CBC_SHA	Disabled
ECDHE_WITH_AES_128_GCM_SHA256	Enabled
ECDHE_WITH_AES_256_GCM_SHA384	Enabled
Session Timeout	10 minutes
Number Control	Disabled

Table 3-4 Default Settings of SSH Configuration

Parameter	Default Setting
SSH	Enabled
Protocol V2	Enabled
Idle Timeout	120 seconds

Parameter	Default Setting
Maximum Connections	5
Port	22
AES128-CBC	Enabled
AES192-CBC	Enabled
AES256-CBC	Enabled
Blowfish-CBC	Enabled
Cast128-CBC	Enabled
3DES-CBC	Enabled
HMAC-SHA1	Enabled
HMAC-MD5	Enabled
Key Type:	SSH-2 RSA/DSA

Table 3-5 Default Settings of Telnet Configuration

Parameter	Default Setting
Telnet	Disabled
Port	23

Table 3-6 Default Settings of Serial Port

Parameter	Default Setting
Baud Rate	38400 bps

Part 26

Configuring AAA

CHAPTERS

1. Overview
2. AAA Configuration
3. Configuration Example
4. Appendix: Default Parameters

1 Overview

AAA stands for authentication, authorization and accounting. On TP-Link switches, this feature is mainly used to authenticate the users trying to log in to the switch or get administrative privileges. The administrator can create guest accounts and an Enable password for other users. The guests do not have administrative privileges without the Enable password provided.

AAA provides a safe and efficient authentication method. The authentication can be processed locally on the switch or centrally on the RADIUS/TACACS+ server(s). As the following figure shows, the network administrator can centrally configure the management accounts of the switches on the RADIUS server and use this server to authenticate the users trying to access the switch or get administrative privileges.

Figure 1-1 Network Topology of AAA

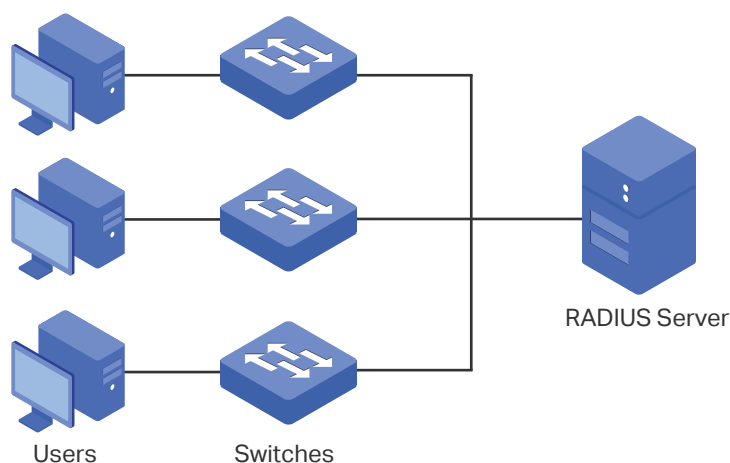

2 AAA Configuration

In the AAA feature, the authentication can be processed locally on the switch or centrally on the RADIUS/TACACS+ server(s). To ensure the stability of the authentication system, you can configure multiple servers and authentication methods at the same time. This chapter introduces how to configure this kind of comprehensive authentication in AAA.

To complete the configuration, follow these steps:

- 1) Add the servers.
- 2) Configure the server groups.
- 3) Configure the method list.
- 4) Configure the AAA application list.
- 5) Configure the login account and the Enable password.

Configuration Guidelines

The basic concepts and working mechanism of AAA are as follows:

■ AAA Default Setting

By default, the AAA feature is enabled and cannot be disabled.

■ Server Group

Multiple servers running the same protocol can be added to a server group, and the servers in the group will authenticate the users in the order they are added. The server that is first added to the group has the highest priority, and is responsible for authentication under normal circumstances. If the first one breaks down or doesn't respond to the authentication request for some reason, the second sever will start working for authentication, and so on.

■ Method List

A server group is regarded as a method, and the local authentication is another method. Several methods can be configured to form a method list. The switch uses the first method in the method list to authenticate the user, and if that method fails to respond, the switch selects the next method. This process continues until the user has a successful communication with a method or until all defined methods are exhausted. If the authentication succeeds or the secure server or the local switch denies the user's access, the authentication process stops and no other methods are attempted.

Two types of method list are provided: Login method list for users of all types to access the switch, and Enable method list for guests to get administrative privileges.

■ AAA Application List

The switch supports the following access applications: Telnet, SSH and HTTP. You can select the configured authentication method lists for each application.

2.1 Using the GUI

2.1.1 Adding Servers

You can add one or more RADIUS/TACACS+ servers on the switch for authentication. If multiple servers are added, the server that is first added to the group has the highest priority and authenticates the users trying to access the switch. The others act as backup servers in case the first one breaks down.

■ Adding RADIUS Server

Choose the menu **SECURITY > AAA > RADIUS Config** and click  Add to load the following page.

Figure 2-1 RADIUS Server Configuration

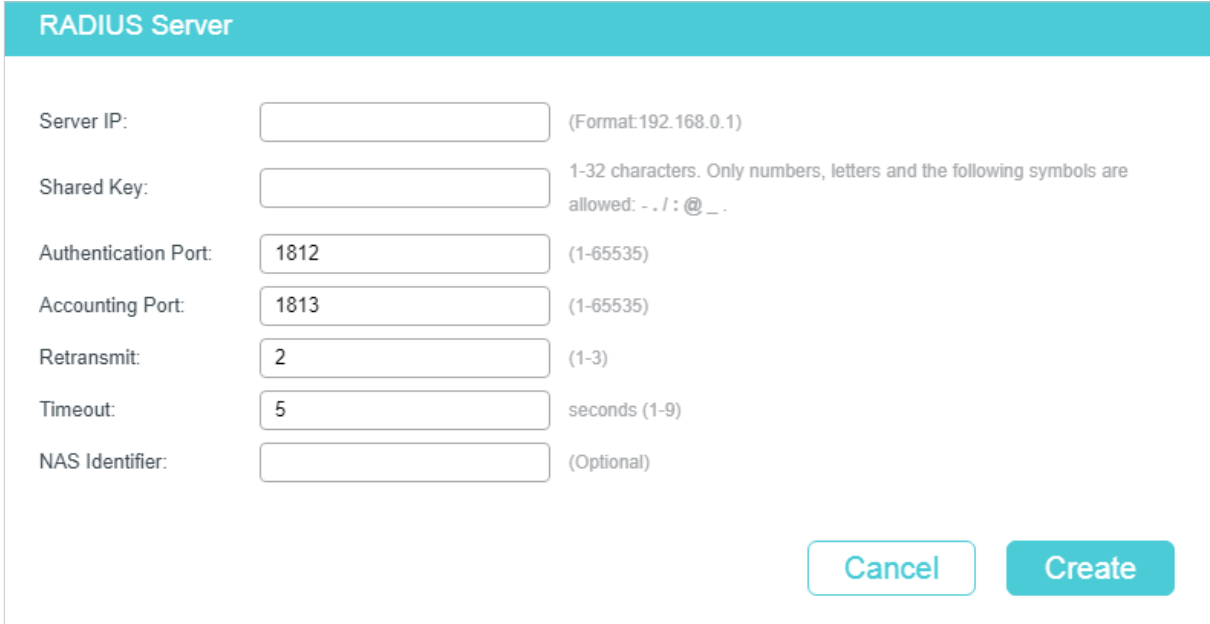

RADIUS Server

Server IP: (Format:192.168.0.1)

Shared Key: 1-32 characters. Only numbers, letters and the following symbols are allowed: - . / : @ _ .

Authentication Port: (1-65535)

Accounting Port: (1-65535)

Retransmit: (1-3)

Timeout: seconds (1-9)

NAS Identifier: (Optional)

Follow these steps to add a RADIUS server:

1) Configure the following parameters.

Server IP	Enter the IP address of the server running the RADIUS secure protocol.
Shared Key	Enter the shared key between the RADIUS server and the switch. The RADIUS server and the switch use the key string to encrypt passwords and exchange responses.
Authentication Port	Specify the UDP destination port on the RADIUS server for authentication requests. The default setting is 1812.

Accounting Port	Specify the UDP destination port on the RADIUS server for accounting requests. The default setting is 1813. Usually, it is used in the 802.1X feature.
Retransmit	Specify the number of times a request is resent to the server if the server does not respond. The default setting is 2.
Timeout	Specify the time interval that the switch waits for the server to reply before resending. The default setting is 5 seconds.
NAS Identifier	Specify the name of the NAS (Network Access Server) to be contained in RADIUS packets for identification. It can range from 1 to 31 characters. The default value is the MAC address of the switch. Generally, the NAS refers to the switch itself.

2) Click **Create** to add the RADIUS server on the switch.

■ Adding TACACS+ Server

Choose the menu **SECURITY > AAA > TACACS+ Config** and click  Add to load the following page.

Figure 2-2 TACACS+ Server Configuration

TACACS+ Server

Server IP: (Format: 192.168.0.1)

Timeout: seconds (1-9)

Shared Key: 1-32 characters. Only numbers, letters and the following symbols are allowed: - . / : @ _ .

Server Port: (1-65535)

Follow these steps to add a TACACS+ server:

1) Configure the following parameters.

Server IP	Enter the IP address of the server running the TACACS+ secure protocol.
Timeout	Specify the time interval that the switch waits for the server to reply before resending. The default setting is 5 seconds.
Shared Key	Enter the shared key between the TACACS+ server and the switch. The TACACS+ server and the switch use the key string to encrypt passwords and exchange responses.
Server Port	Specify the TCP port used on the TACACS+ server for AAA. The default setting is 49.

2) Click **Create** to add the TACACS+ server on the switch.

2.1.2 Configuring Server Groups

The switch has two built-in server groups, one for RADIUS servers and the other for TACACS+ servers. The servers running the same protocol are automatically added to the default server group. You can edit existing server groups or add new server groups on this page.

Choose the menu **SECURITY > AAA > Server Group** to load the following page.

Figure 2-3 Add New Server Group

Server Group List

+ Add - Delete

<input type="checkbox"/>	ID	Server Group	Server Type	Server IP	Operation
<input type="checkbox"/>	1	radius	RADIUS		
<input type="checkbox"/>	2	tacacs	TACACS+		
Total: 2					

There are two default server groups in the list. You can edit the default server groups or follow these steps to configure a new server group:

- 1) Click **Add** and the following window will pop up.

Figure 2-4 Add Server Group

Server Group

Server Group: (1-15 characters)

Server Type:

Server IP:

Configure the following parameters:

Server Group	Specify a name for the server group.
Server Type	Select the server type for the group. The following options are provided: RADIUS and TACACS+.
Server IP	Select the IP address of the server which will be added to the server group.

- 2) Click **Create**.

 **Note:**





- The two default server groups in the list cannot be edited or deleted.
- If multiple servers are added to the server group, the server that is first added to the group has the highest priority and authenticates the users trying to access the switch. The others act as backup servers in case the first one breaks down.

2.1.3 Configuring the Method List

A method list describes the authentication methods and their sequence to authenticate the users. The switch supports Login Method List for users of all types to gain access to the switch, and Enable Method List for guests to get administrative privileges. You can edit the default methods or add a new method on this page.

Choose the menu **SECURITY > AAA > Method List** to load the following page.

Figure 2-5 Method List

Authentication Login Method List							
							+ Add - Delete
<input type="checkbox"/>	ID	Name	Pri1	Pri2	Pri3	Pri4	Operation
<input type="checkbox"/>	1	default	local	--	--	--	 
Total: 1							
Authentication Enable Method List							
							+ Add - Delete
<input type="checkbox"/>	ID	Name	Pri1	Pri2	Pri3	Pri4	Operation
<input type="checkbox"/>	1	default	none	--	--	--	 
Total: 1							

There are two default methods respectively for the Login authentication and the Enable authentication.

You can edit the default methods or follow these steps to add a new method:

- 1) Click  **Add** in the **Authentication Login Method List** section or **Authentication Enable Method List** section to add corresponding type of method list. The following window will pop up.

Figure 2-6 Add New Method

Authentication Login Method

Method List Name: (1-15 characters)

Pri1:

Pri2:

Pri3:

Pri4:

Configure the parameters for the method to be added.

Name	Specify a name for the method.
Pri1- Pri4	<p>Specify the authentication methods in order. The method with priority 1 authenticates a user first, the method with priority 2 is tried if the previous method does not respond, and so on.</p> <p>local: Use the local database in the switch for authentication.</p> <p>none: No authentication is used.</p> <p>radius: Use the remote RADIUS server/server groups for authentication.</p> <p>tacacs: Use the remote TACACS+ server/server groups for authentication.</p> <p>Other user-defined server groups: Use the user-defined server groups for authentication.</p>

- 2) Click **Create** to add the new method.

2.1.4 Configuring the AAA Application List

Choose the menu **SECURITY > AAA > Global Config** to load the following page.

Figure 2-7 Configure Application List

Enable Admin

Enable Admin: Clear Password Set Password

[Apply](#)

AAA Application Config

<input type="checkbox"/>	Index	Module	Login Method	Enable Method
<input type="checkbox"/>	1	console	default	default
<input type="checkbox"/>	2	telnet	default	default
<input type="checkbox"/>	3	ssh	default	default
<input type="checkbox"/>	4	http	default	default
Total: 4				

Follow these steps to configure the AAA application list.

- 1) In the **AAA Application Config** section, select an access application and configure the Login list and Enable list.

Module	Displays the configurable applications on the switch: telnet, ssh and http. Note: Console is only available on certain devices.
Login Method	Select a previously configured Login method. This method will authenticate the users trying to log in to the switch.
Enable Method	Select a previously configured Enable method. This method will authenticate the users trying to get administrative privileges.

- 2) Click **Apply**.

2.1.5 Configuring Login Account and Enable Password

The login account and Enable password can be configured locally on the switch or centrally on the RADIUS/TACACS+ server(s).

■ On the Switch

The local username and password for login can be configured in the User Management feature. For details, refer to [Managing System](#).

To configure the local Enable password for getting administrative privileges, choose the menu **SECURITY > AAA > Global Config** to load the following page.

Figure 2-8 Configure Enable Password

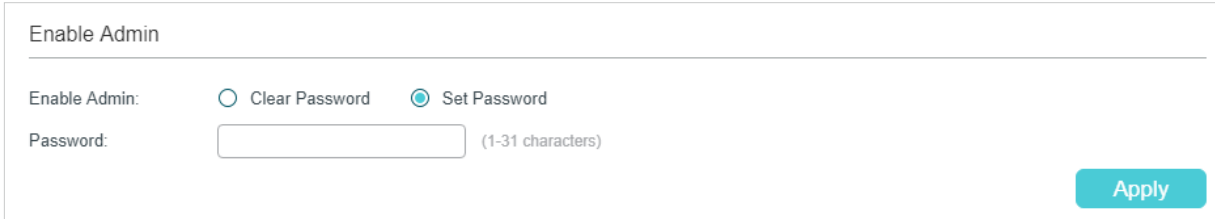

Enable Admin

Enable Admin: Clear Password Set Password

Password: (1-31 characters)

Apply

There are two options: **Clear Password** and **Set Password**. You can choose whether the local Enable password is required when the guests try to get administrative privileges. Click **Apply**.

Tips: The logged-in guests can enter the local Enable password on this page to get administrative privileges.

■ On the Server

The accounts created by the RADIUS/TACACS+ server can only view the configurations and some network information without the Enable password.

Some configuration principles on the server are as follows:

- For Login authentication configuration, more than one login account can be created on the server. Besides, both the user name and password can be customized.
- For Enable password configuration:

On RADIUS server, the user name should be set as **\$enable\$**, and the Enable password is customizable. All the users trying to get administrative privileges share this Enable password.

On TACACS+ server, configure the value of "enable 15" as the Enable password in the configuration file. All the users trying to get administrative privileges share this Enable password.

2.2 Using the CLI

2.2.1 Adding Servers

You can add one or more RADIUS/TACACS+ servers on the switch for authentication. If multiple servers are added, the server with the highest priority authenticates the users trying to access the switch, and the others act as backup servers in case the first one breaks down.

■ Adding RADIUS Server

Follow these steps to add RADIUS server on the switch:

Step 1	configure Enter global configuration mode.
Step 2	<p>radius-server host <i>ip-address</i> [auth-port <i>port-id</i>] [acct-port <i>port-id</i>] [timeout <i>time</i>] [retransmit <i>number</i>] [nas-id <i>nas-id</i>] key { [0] <i>string</i> 7 <i>encrypted-string</i> }</p> <p>Add the RADIUS server and configure the related parameters as needed.</p> <p>host <i>ip-address</i>: Enter the IP address of the server running the RADIUS protocol.</p> <p>auth-port <i>port-id</i>: Specify the UDP destination port on the RADIUS server for authentication requests. The default setting is 1812.</p> <p>acct-port <i>port-id</i>: Specify the UDP destination port on the RADIUS server for accounting requests. The default setting is 1813. Usually, it is used in the 802.1X feature.</p> <p>timeout <i>time</i>: Specify the time interval that the switch waits for the server to reply before resending. The valid values are from 1 to 9 seconds and the default setting is 5 seconds.</p> <p>retransmit <i>number</i>: Specify the number of times a request is resent to the server if the server does not respond. The valid values are from 1 to 3 and the default setting is 2.</p> <p>nas-id <i>nas-id</i>: Specify the name of the NAS (Network Access Server) to be contained in RADIUS packets for identification. It ranges from 1 to 31 characters. The default value is the MAC address of the switch. Generally, the NAS indicates the switch itself.</p> <p>key { [0] <i>string</i> 7 <i>encrypted-string</i> }: Specify the shared key. 0 and 7 represent the encryption type. 0 indicates that an unencrypted key will follow. 7 indicates that a symmetric encrypted key with a fixed length will follow. By default, the encryption type is 0. <i>string</i> is the shared key for the switch and the server. <i>encrypted-string</i> is a symmetric encrypted key with a fixed length, which you can copy from the configuration file of another switch. The key or encrypted-key you configure here will be displayed in the encrypted form.</p>
Step 3	show radius-server Verify the configuration of RADIUS server.
Step 4	end Return to privileged EXEC mode.
Step 5	copy running-config startup-config Save the settings in the configuration file.

The following example shows how to add a RADIUS server on the switch. Set the IP address of the server as 192.168.0.10, the authentication port as 1812, the shared key as 123456, the timeout as 8 seconds and the retransmit number as 3.

Switch#configure

```
Switch(config)#radius-server host 192.168.0.10 auth-port 1812 timeout 8 retransmit 3
key 123456
```

Switch(config)#show radius-server

Server Ip	Auth Port	Acct Port	Timeout	Retransmit	NAS Identifier	Shared key
192.168.0.10	1812	1813	5	2	000AEB132397	123456

Switch(config)#end

Switch#copy running-config startup-config

■ Adding TACACS+ Server

Follow these steps to add TACACS+ server on the switch:

Step 1	configure Enter global configuration mode.
Step 2	tacacs-server host ip-address [port port-id] [timeout time] [key { [0] string 7 encrypted-string }] Add the RADIUS server and configure the related parameters as needed. host ip-address: Enter the IP address of the server running the TACACS+ protocol. port port-id: Specify the TCP destination port on the TACACS+ server for authentication requests. The default setting is 49. timeout time: Specify the time interval that the switch waits for the server to reply before resending. The valid values are from 1 to 9 seconds and the default setting is 5 seconds. key { [0] string 7 encrypted-string }: Specify the shared key. 0 and 7 represent the encryption type. 0 indicates that an unencrypted key will follow. 7 indicates that a symmetric encrypted key with a fixed length will follow. By default, the encryption type is 0. <i>string</i> is the shared key for the switch and the server. <i>encrypted-string</i> is a symmetric encrypted key with a fixed length, which you can copy from the configuration file of another switch. The key or encrypted-key you configured here will be displayed in the encrypted form.
Step 3	show tacacs-server Verify the configuration of TACACS+ server.
Step 4	end Return to privileged EXEC mode.
Step 5	copy running-config startup-config Save the settings in the configuration file.

The following example shows how to add a TACACS+server on the switch. Set the IP address of the server as 192.168.0.20, the authentication port as 49, the shared key as 123456, and the timeout as 8 seconds.

Switch#configure

Switch(config)#tacacs-server host 192.168.0.20 auth-port 49 timeout 8 key 123456

Switch(config)#show tacacs-server

Server Ip	Port	Timeout	Shared key
192.168.0.20	49	8	123456

Switch(config)#end

```
Switch#copy running-config startup-config
```

2.2.2 Configuring Server Groups

The switch has two built-in server groups, one for RADIUS and the other for TACACS+. The servers running the same protocol are automatically added to the default server group. You can add new server groups as needed.

The two default server groups cannot be deleted or edited. Follow these steps to add a server group:

Step 1	configure Enter global configuration mode.
Step 2	aaa group { radius tacacs } group-name Create a server group. <i>radius tacacs</i> : Specify the group type. <i>group-name</i> : Specify a name for the group.
Step 3	server ip-address Add the existing servers to the server group. <i>ip-address</i> : Specify IP address of the server to be added to the group.
Step 4	show aaa group [group-name] Verify the configuration of server group.
Step 5	end Return to privileged EXEC mode.
Step 6	copy running-config startup-config Save the settings in the configuration file.

The following example shows how to create a RADIUS server group named RADIUS1 and add the existing two RADIUS servers whose IP address is 192.168.0.10 and 192.168.0.20 to the group.

```
Switch#configure
```

```
Switch(config)#aaa group radius RADIUS1
```

```
Switch(aaa-group)#server 192.168.0.10
```

```
Switch(aaa-group)#server 192.168.0.20
```

```
Switch(aaa-group)#show aaa group RADIUS1
```

```
192.168.0.10
```

```
192.168.0.20
```



```
Switch(aaa-group)#end
```

```
Switch#copy running-config startup-config
```

2.2.3 Configuring the Method List

A method list describes the authentication methods and their sequence to authenticate the users. The switch supports Login Method List for users of all types to gain access to the switch, and Enable Method List for guests to get administrative privileges.

Follow these steps to configure the method list:

Step 1	configure Enter global configuration mode.
Step 2	aaa authentication login { method-list } { method1 } [method2] [method3] [method4] Configure a login method list. <i>method-list</i> : Specify a name for the method list. <i>method1/method2/method3/method4</i> : Specify the authentication methods in order. The first method authenticates a user first, the second method is tried if the previous method does not respond, and so on. The default methods include radius, tacacs, local and none. None means no authentication is used for login.
Step 3	aaa authentication enable { method-list } { method1 } [method2] [method3] [method4] Configure an Enable password method list. <i>method-list</i> : Specify a name for the method list. <i>method1/method2/method3/method4</i> : Specify the authentication methods in order. The default methods include radius, tacacs, local and none. None means no authentication is used for getting administrative privileges.
Step 4	show aaa authentication [login enable] Verify the configuration method list.
Step 5	end Return to privileged EXEC mode.
Step 6	copy running-config startup-config Save the settings in the configuration file.

The following example shows how to create a Login method list named Login1, and configure the method 1 as the default radius server group and the method 2 as local.

```
Switch#configure
```

```
Switch(config)##aaa authentication login Login1 radius local
```

```
Switch(config)#show aaa authentication login
```

```
Methodlist  pri1    pri2    pri3    pri4
default     local   --      --      --
Login1      radius  local   --      --
```

Switch(config)#end

Switch#copy running-config startup-config

The following example shows how to create an Enable method list named Enable1, and configure the method 1 as the default radius server group and the method 2 as local.

Switch#configure

Switch(config)##aaa authentication enable Enable1 radius local

Switch(config)#show aaa authentication enable

```
Methodlist  pri1    pri2    pri3    pri4
default     local   --      --      --
Enable1     radius  local   --      --
```

Switch(config)#end

Switch#copy running-config startup-config

2.2.4 Configuring the AAA Application List

You can configure authentication method lists on the following access applications: Console, Telnet, SSH and HTTP.

■ Console

Note:

Console is only available on certain devices.

Follow these steps to apply the Login and Enable method lists for the application Console:

Step 1 **configure**
Enter global configuration mode.

Step 2 **line console *linenum***
Enter line configuration mode.

linenum: Enter the number of users allowed to login through console port. Its value is 0 in general, for the reason that console input is only active on one console port at a time.

-
- Step 3 **login authentication { method-list }**
Apply the Login method list for the application Console.
method-list: Specify the name of the Login method list.
-
- Step 4 **enable authentication { method-list }**
Apply the Enable method list for the application Console.
method-list: Specify the name of the Enable method list.
-
- Step 5 **show aaa global**
Verify the configuration of application list.
-
- Step 6 **end**
Return to privileged EXEC mode.
-
- Step 7 **copy running-config startup-config**
Save the settings in the configuration file.
-

The following example shows how to apply the existing Login method list named Login1 and Enable method list named Enable1 for the application Console.

Switch#configure

Switch(config)#line console 0

Switch(config-line)#login authentication Login1

Switch(config-line)#enable authentication Enable1

Switch(config-line)#show aaa global

Module	Login List	Enable List
Console	Login1	Enable1
Telnet	default	default
Ssh	default	default
Http	default	default

Switch(config-line)#end

Switch#copy running-config startup-config

■ Telnet

Follow these steps to apply the Login and Enable method lists for the application Telnet:

-
- Step 1 **configure**
Enter global configuration mode.
-

Step 2	line telnet Enter line configuration mode.
Step 3	login authentication { method-list } Apply the Login method list for the application Telnet. <i>method-list</i> : Specify the name of the Login method list.
Step 4	enable authentication { method-list } Apply the Enable method list for the application Telnet. <i>method-list</i> : Specify the name of the Enable method list.
Step 5	show aaa global Verify the configuration of application list.
Step 6	end Return to privileged EXEC mode.
Step 7	copy running-config startup-config Save the settings in the configuration file.

The following example shows how to apply the existing Login method list named Login1 and Enable method list named Enable1 for the application Telnet.

Switch#configure

Switch(config)#line telnet

Switch(config-line)#login authentication Login1

Switch(config-line)#enable authentication Enable1

Switch(config-line)#show aaa global

Module	Login List	Enable List
Telnet	Login1	Enable1
Ssh	default	default
Http	default	default

Switch(config-line)#end

Switch#copy running-config startup-config

■ SSH

Follow these steps to apply the Login and Enable method lists for the application SSH:

Step 1	configure Enter global configuration mode.
Step 2	line ssh Enter line configuration mode.
Step 3	login authentication { method-list } Apply the Login method list for the application SSH. <i>method-list</i> : Specify the name of the Login method list.
Step 4	enable authentication { method-list } Apply the Enable method list for the application SSH. <i>method-list</i> : Specify the name of the Enable method list.
Step 5	show aaa global Verify the configuration of application list.
Step 6	end Return to privileged EXEC mode.
Step 7	copy running-config startup-config Save the settings in the configuration file.

The following example shows how to apply the existing Login method list named Login1 and Enable method list named Enable1 for the application SSH.

Switch#configure

Switch(config)#line ssh

Switch(config-line)#login authentication Login1

Switch(config-line)#enable authentication Enable1

Switch(config-line)#show aaa global

Module	Login List	Enable List
Telnet	default	default
Ssh	Login1	Enable1
Http	default	default

Switch(config-line)#end

Switch#copy running-config startup-config

■ HTTP

Follow these steps to apply the Login and Enable method lists for the application HTTP:

Step 1	configure Enter global configuration mode.
Step 2	ip http login authentication { method-list } Apply the Login method list for the application HTTP. <i>method-list</i> : Specify the name of the Login method list.
Step 3	ip http enable authentication { method-list } Apply the Enable method list for the application HTTP. <i>method-list</i> : Specify the name of the Enable method list.
Step 4	show aaa global Verify the configuration of application list.
Step 5	end Return to privileged EXEC mode.
Step 6	copy running-config startup-config Save the settings in the configuration file.

The following example shows how to apply the existing Login method list named Login1 and Enable method list named Enable1 for the application HTTP:

Switch#configure

Switch(config)#ip http login authentication Login1

Switch(config)#ip http enable authentication Enable1

Switch(config)#show aaa global

Module	Login List	Enable List
Telnet	default	default
Ssh	default	default
Http	Login1	Enable1

Switch(config)#end

Switch#copy running-config startup-config

2.2.5 Configuring Login Account and Enable Password

The login account and Enable password can be configured locally on the switch or centrally on the RADIUS/TACACS+ server(s).

■ On the Switch

The local username and password for login can be configured in the User Management feature. For details, refer to [Managing System](#).

To configure the local Enable password for getting administrative privileges, follow these steps:

Step 1	<p>configure</p> <p>Enter global configuration mode.</p>
Step 2	<p>Use the following command to create an enable password unencrypted or symmetric encrypted.</p> <p>enable admin password {[0] password 7 encrypted-password }</p> <p>0 indicates that an unencrypted key will follow.</p> <p><i>password</i> is a string with 31 characters at most, which can contain only English letters (case-sensitive), digits and 17 kinds of special characters. The special characters are !\$%()*,-./[]_{}.</p> <p>7 indicates that a symmetric encrypted key with a fixed length will follow. By default, the encryption type is 0.</p> <p><i>encrypted-password</i> is a symmetric encrypted key with a fixed length, which you can copy from the configuration file of another switch. The key or encrypted-key you configured here will be displayed in the encrypted form.</p> <p>Use the following command to create an enable password unencrypted or MD5 encrypted.</p> <p>enable admin secret {[0] password 5 encrypted-password }</p> <p>0 indicates that an unencrypted key will follow.</p> <p><i>password</i> is a string with 31 characters at most, which can contain only English letters (case-sensitive), digits and 17 kinds of special characters. The special characters are !\$%()*,-./[]_{}.</p> <p>5 indicates that an MD5 encrypted password with fixed length will follow. By default, the encryption type is 0.</p> <p><i>encrypted-password</i> is an MD5 encrypted password with fixed length, which you can copy from another switch's configuration file.</p>
Step 3	<p>end</p> <p>Return to privileged EXEC mode.</p>
Step 4	<p>copy running-config startup-config</p> <p>Save the settings in the configuration file.</p>

■ On the Server

The accounts created by the RADIUS/TACACS+ server can only view the configurations and some network information without the Enable password.

Some configuration principles on the server are as follows:

- For Login authentication configuration, more than one login account can be created on the server. Besides, both the user name and password can be customized.

- For Enable password configuration:

On RADIUS server, the user name should be set as **\$enable\$**, and the Enable password is customizable. All the users trying to get administrative privileges share this Enable password.

On TACACS+ server, configure the value of "enable 15" as the Enable password in the configuration file. All the users trying to get administrative privileges share this Enable password.

Tips: The logged-in guests can get administrative privileges by using the command **enable-admin** and providing the Enable password.

3 Configuration Example

3.1 Network Requirements

As shown below, the switch needs to be managed remotely via Telnet. In addition, the senior administrator of the company wants to create an account for the less senior administrators, who can only view the configurations and some network information without the Enable password provided.

Two RADIUS servers are deployed in the network to provide a safer authenticate method for the administrators trying to log in or get administrative privileges. If RADIUS Server 1 breaks down and doesn't respond to the authentication request, RADIUS Server 2 will work, so as to ensure the stability of the authentication system.

Figure 3-1 Network Topology

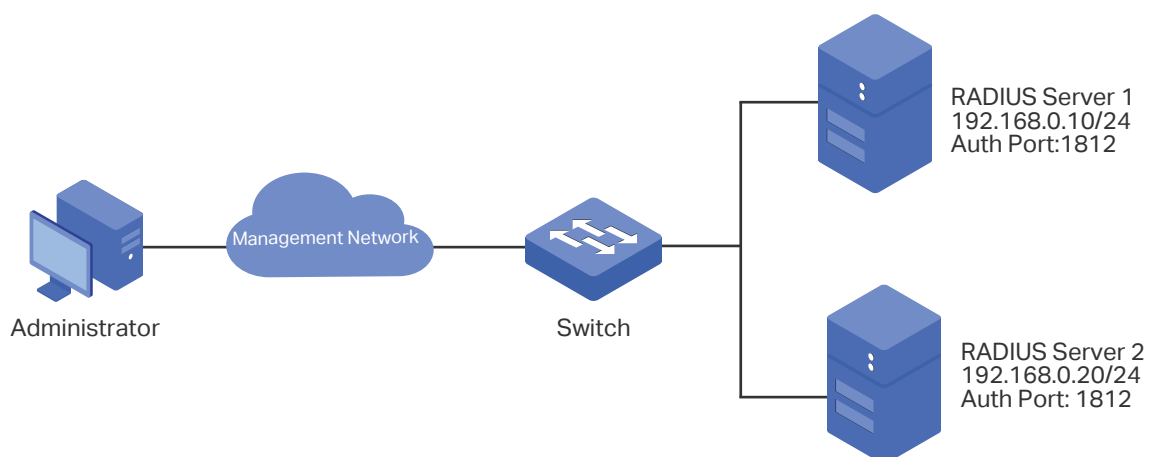

3.2 Configuration Scheme

To implement this requirement, the senior administrator can create the login account and the Enable password on the two RADIUS servers, and configure the AAA feature on the switch. The IP addresses of the two RADIUS servers are 192.168.0.10/24 and 192.168.0.20/24; the authentication port number is 1812; the shared key is 123456.

The overview of configuration on the switch is as follows:

- 1) Add the two RADIUS servers on the switch.
- 2) Create a new RADIUS server group and add the two servers to the group. Make sure that RADIUS Server 1 is the first server for authentication.
- 3) Configure the method list.
- 4) Configure the AAA application list.

Demonstrated with SG6654XHP, the following sections provide configuration procedure in two ways: using the GUI and using the CLI.

3.3 Using the GUI

- 1) Choose the menu **SECURITY > AAA > RADIUS Config** and click **+ Add** to load the following page. Configure the Server IP as 192.168.0.10, the Shared Key as 123456, the Authentication Port as 1812, and keep the other parameters as default. Click **Create** to add RADIUS Server 1 on the switch.

Figure 3-2 Add RADIUS Server 1

RADIUS Server

Server IP:	<input type="text" value="192.168.0.10"/>	(Format:192.168.0.1)
Shared Key:	<input type="text" value="123456"/>	1-32 characters. Only numbers, letters and the following symbols are allowed: - . / : @ _ .
Authentication Port:	<input type="text" value="1812"/>	(1-65535)
Accounting Port:	<input type="text" value="1813"/>	(1-65535)
Retransmit:	<input type="text" value="2"/>	(1-3)
Timeout:	<input type="text" value="5"/>	seconds (1-9)
NAS Identifier:	<input type="text"/>	(Optional)

- 2) On the same page, click **+ Add** to load the following page. Configure the Server IP as 192.168.0.20, the Shared Key as 123456, the Auth Port as 1812, and keep the other parameters as default. Click **Create** to add RADIUS Server 2 on the switch

Figure 3-3 Add RADIUS Server 2

RADIUS Server

Server IP:	<input type="text" value="192.168.0.20"/>	(Format:192.168.0.1)
Shared Key:	<input type="text" value="123456"/>	1-32 characters. Only numbers, letters and the following symbols are allowed: - . / : @ _ .
Authentication Port:	<input type="text" value="1812"/>	(1-65535)
Accounting Port:	<input type="text" value="1813"/>	(1-65535)
Retransmit:	<input type="text" value="2"/>	(1-3)
Timeout:	<input type="text" value="5"/>	seconds (1-9)
NAS Identifier:	<input type="text"/>	(Optional)

- 3) Choose the menu **SECURITY > AAA > Server Group** to load the following page. Click **+ Add**. Specify the group name as RADIUS1 and the server type as RADIUS. Select 192.168.0.10 and 192.168.0.20 to from the drop-down list. Click **Create** to create the server group.

Figure 3-4 Create Server Group

- 4) Choose the menu **SECURITY > AAA > Method List** and click **+ Add** in the **Authentication Login Method List** section. Specify the Method List Name as MethodLogin and select the Pri1 as RADIUS1. Click **Create** to set the method list for the Login authentication.

Figure 3-5 Configure Login Method List

- 5) On the same page, click **+ Add** in the **Authentication Enable Method List** section. Specify the Method List Name as MethodEnable and select the Pri1 as RADIUS1. Click **Create** to set the method list for the Enable password authentication.

Figure 3-6 Configure Enable Method List

Authentication Enable Method

Method List Name: (1-15 characters)

Pri1: ▼

Pri2: ▼

Pri3: ▼

Pri4: ▼

- 6) Choose the menu **SECURITY > AAA > Global Config** to load the following page. In the **AAA Application List** section, select telnet and configure the Login List as Method-Login and Enable List as Method-Enable. Then click **Apply**.

Figure 3-7 Configure AAA Application List

AAA Application List

<input type="checkbox"/>	Index	Module	Login List	Enable List
<input checked="" type="checkbox"/>	1	telnet	MethodLogin ▼	MethodEnable ▼
<input type="checkbox"/>	2	ssh	default	default
<input type="checkbox"/>	3	http	default	default

Total: 3 1 entry selected.

- 7) Click  Save to save the settings.

3.4 Using the CLI

- 1) Add RADIUS Server 1 and RADIUS Server 2 on the switch.

```
Switch(config)#radius-server host 192.168.0.10 auth-port 1812 key 123456
```

```
Switch(config)#radius-server host 192.168.0.20 auth-port 1812 key 123456
```

- 2) Create a new server group named RADIUS1 and add the two RADIUS servers to the server group.

```
Switch(config)#aaa group radius RADIUS1
```

```
Switch(aaa-group)#server 192.168.0.10
```

```
Switch(aaa-group)#server 192.168.0.20
```

```
Switch(aaa-group)#exit
```

- 3) Create two method lists: Method-Login and Method-Enable, and configure the server group RADIUS1 as the authentication method for the two method lists.

```
Switch(config)#aaa authentication login Method-Login RADIUS1
```

```
Switch(config)#aaa authentication enable Method-Enable RADIUS1
```

- 4) Configure Method-Login and Method-Enable as the authentication method for the Telnet application.

```
Switch(config)#line telnet
```

```
Switch(config-line)#login authentication Method-Login
```

```
Switch(config-line)#enable authentication Method-Enable
```

```
Switch(config-line)#end
```

```
Switch#copy running-config startup-config
```

Verify the Configuration

Verify the configuration of the RADIUS servers:

```
Switch#show radius-server
```

Server Ip	Auth Port	Acct Port	Timeout	Retransmit	NAS Identifier	Shared key
192.168.0.10	1812	1813	5	2	000AEB132397	123456
192.168.0.20	1812	1813	5	2	000AEB132397	123456

Verify the configuration of server group RADIUS1:

```
Switch#show aaa group RADIUS1
```

```
192.168.0.10
```

```
192.168.0.20
```

Verify the configuration of the method lists:

```
Switch#show aaa authentication
```

Authentication Login Methodlist:

Methodlist	pri1	pri2	pri3	pri4
default	local	--	--	--
Method-Login	RADIUS1	--	--	--

Authentication Enable Methodlist:

Methodlist	pri1	pri2	pri3	pri4

```
default          none      --      --      --
Method-Enable   RADIUS1  --      --      --
...
```

Verify the status of the AAA feature and the configuration of the AAA application list:

```
Switch#show aaa global
```

```
Module      Login List      Enable List
Telnet      Method-Login    Method-Enable
SSH         default         default
Http        default         default
```

4 Appendix: Default Parameters

Default settings of AAA are listed in the following tables.

Table 4-1 AAA

Parameter	Default Setting
Global Config	
AAA Feature	Enabled
RADIUS Config	
Server IP	None
Shared Key	None
Auth Port	1812
Acct Port	1813
Retransmit	2
Timeout	5 seconds
NAS Identifier	The MAC address of the switch.
TACACS+ Config	
Server IP	None
Timeout	5 seconds
Shared Key	None
Port	49
Server Group: There are two default server groups: radius and tacacs.	
Method List	
Authentication Login Method List	List name: default Pri1: local
Authentication Enable Method List	List name: default Pri1: none

Parameter	Default Setting
AAA Application List	
console	Login List: default Enable List: default
telnet	Login List: default Enable List: default
ssh	Login List: default Enable List: default
http	Login List: default Enable List: default

Part 27

Configuring 802.1x

CHAPTERS

1. Overview
2. 802.1x Configuration
3. Configuration Example
4. Appendix: Default Parameters

1 Overview

802.1x protocol is a protocol for port-based Network Access Control. It is used to authenticate and control access from devices connected to the ports. If the device connected to the port is authenticated by the authentication server successfully, its request to access the LAN will be accepted; if not, its request will be denied.

802.1x authentication uses client-server model which contains three device roles: client/supplicant, authenticator and authentication server. This is described in the figure below:

Figure 1-1 802.1x Authentication Model

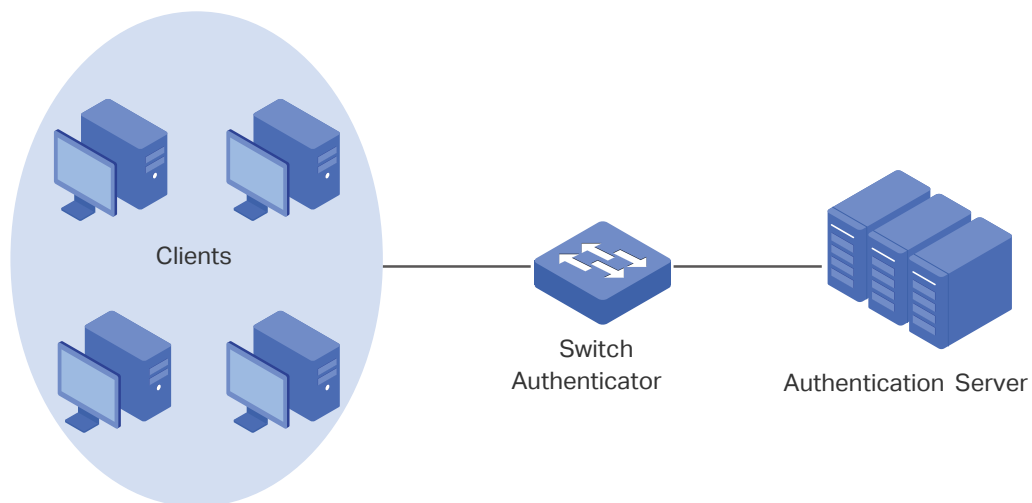

■ Client

A client, usually a computer, is connected to the authenticator via a physical port. We recommend that you install TP-Link 802.1x authentication client software on the client hosts, enabling them to request 802.1x authentication to access the LAN.

■ Authenticator

An authenticator is usually a network device that supports 802.1x protocol. As the above figure shows, the switch is an authenticator.

The authenticator acts as an intermediate proxy between the client and the authentication server. The authenticator requests user information from the client and sends it to the authentication server; also, the authenticator obtains responses from the authentication server and send them to the client. The authenticator allows authenticated clients to access the LAN through the connected ports but denies the unauthenticated clients.

■ Authentication Server

The authentication server is usually the host running the RADIUS server program. It stores information of clients, confirms whether a client is legal and informs the authenticator whether a client is authenticated.

2 802.1x Configuration

To complete the 802.1x configuration, follow these steps:

- 1) Configure the RADIUS server.
- 2) Configure 802.1x globally.
- 3) Configure 802.1x on ports.

In addition, you can view the authenticator state.

Configuration Guidelines

802.1x authentication and Port Security cannot be enabled at the same time. Before enabling 802.1x authentication, make sure that Port Security is disabled.

2.1 Using the GUI

2.1.1 Configuring the RADIUS Server

Configure the parameters of RADIUS sever and configure the RADIUS server group.

■ Adding the RADIUS Server

Choose the menu **SECURITY > AAA > RADIUS Config** and click  **Add** to load the following page.

Figure 2-1 Adding RADIUS Server

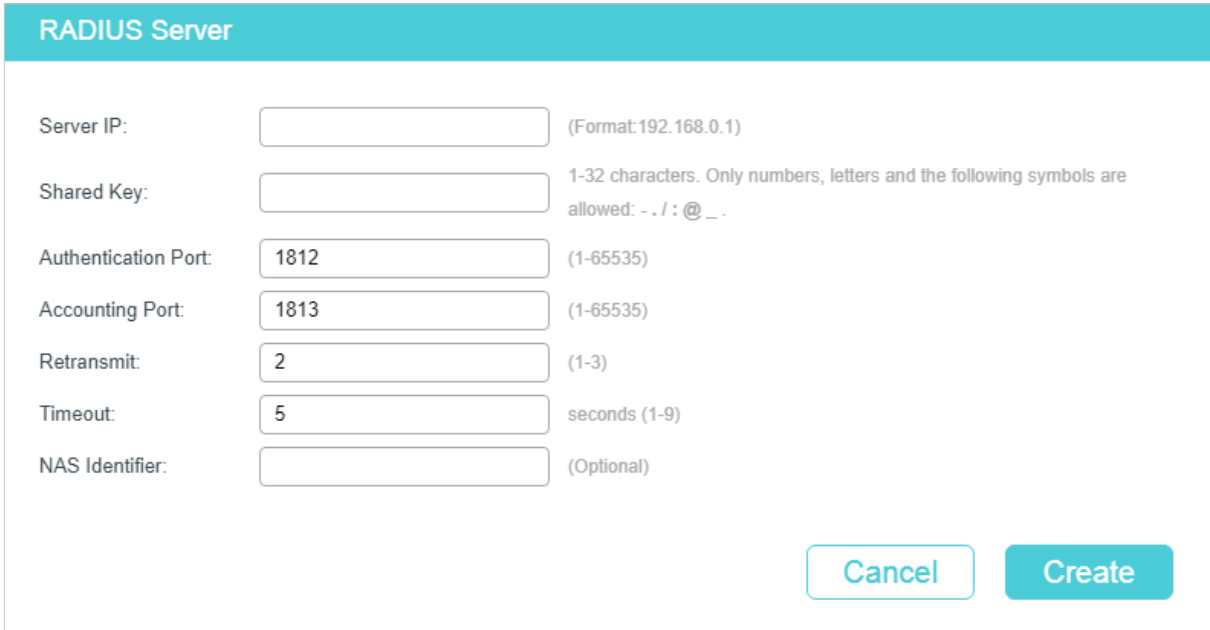

RADIUS Server		
Server IP:	<input type="text"/>	(Format:192.168.0.1)
Shared Key:	<input type="text"/>	1-32 characters. Only numbers, letters and the following symbols are allowed: - . / : @ _ .
Authentication Port:	<input type="text" value="1812"/>	(1-65535)
Accounting Port:	<input type="text" value="1813"/>	(1-65535)
Retransmit:	<input type="text" value="2"/>	(1-3)
Timeout:	<input type="text" value="5"/>	seconds (1-9)
NAS Identifier:	<input type="text"/>	(Optional)

Follow these steps to add a RADIUS server:

1) Configure the parameters of the RADIUS server.





Server IP	Enter the IP address of the server running the RADIUS secure protocol.
Shared Key	Enter the shared key between the RADIUS server and the switch. The RADIUS server and the switch use the key string to encrypt passwords and exchange responses.
Authentication Port	Specify the UDP destination port on the RADIUS server for authentication requests. The default setting is 1812.
Accounting Port	Specify the UDP destination port on the RADIUS server for accounting requests. The default setting is 1813.
Retransmit	Specify the number of times a request is resent to the server if the server does not respond. The default setting is 2.
Timeout	Specify the time interval that the switch waits for the server to reply before resending. The default setting is 5 seconds.
NAS Identifier	Specify the name of the NAS (Network Access Server) to be contained in RADIUS packets for identification. It can range from 1 to 31 characters. The default value is the MAC address of the switch. Generally, the NAS refers to the switch itself.

2) Click **Apply**.



■ Configuring the RADIUS Server Group

Choose the menu **SECURITY > AAA > Server Group** to load the following page.

Figure 2-2 Adding a Server Group

Server Group List					
<input type="checkbox"/>	ID	Server Group	Server Type	Server IP	Operation
<input type="checkbox"/>	1	radius	RADIUS		 
<input type="checkbox"/>	2	tacacs	TACACS+		 
Total: 2					

Follow these steps to add the RADIUS server to a server group:

- 1) Click  to edit the default **radius** server group or click  **Add** to add a new server group.

If you click , the following window will pop up. Select a RADIUS server and click **Save**.

Figure 2-3 Editing Server Group

If you click **+** **Add**, the following window will pop up. Specify a name for the server group, select the server type as RADIUS and select the IP address of the RADIUS server. Click **Save**.

Figure 2-4 Adding Server Group

■ Configuring the Dot1x List

Choose the menu **SECURITY > AAA > Dot1x List** to load the following page.

Figure 2-5 Configuring the Dot1x List

Follow these steps to configure RADIUS server groups for 802.1x authentication and accounting:

- 1) In the **Authentication Dot1x Method** section, select an existing RADIUS server group for authentication from the Pri1 drop-down list and click **Apply**.

- 2) In the **Accounting Dot1x Method** section, select an existing RADIUS server group for accounting from the Pri1 drop-down list and click **Apply**.

2.1.2 Configuring 802.1x Globally

Choose the menu **SECURITY > 802.1x > Global Config** to load the following page.

Figure 2-6 Global Config

Global Config

802.1x: Enable

Authentication Protocol:

Accounting: Enable

Handshake: Enable

VLAN Assignment: Enable

[Apply](#)

Follow these steps to configure 802.1x global parameters:

- 1) In the **Global Config** section, configure the following parameters.

802.1x	Enable or disable 802.1x globally.
Authentication Protocol	<p>Select the 802.1x authentication protocol.</p> <p>EAP: The 802.1x authentication system uses EAP packets to exchange information between the switch and the client. The EAP (Extensible Authentication Protocol) packets with authentication data are encapsulated in the advanced protocol (such as RADIUS) packets, and transmitted to the authentication server.</p> <p>PAP: The 802.1x authentication system uses EAP packets to exchange information between the switch and the client. The transmission of EAP packets is terminated at the switch and the EAP packets are converted to other protocol (such as RADIUS) packets, and transmitted to the authentication server.</p>
Accounting	Enable or disable 802.1x accounting function.
Handshake	Enable or disable the Handshake feature. The Handshake feature is used to detect the connection status between the TP-Link 802.1x Client and the switch. Please disable Handshake feature if you are using other client software instead of TP-Link 802.1x Client.

VLAN Assignment

Enable or disable the 802.1x VLAN assignment feature. 802.1x VLAN assignment is a technology allowing the RADIUS server to send the VLAN assignment to the port when the port is authenticated.

If the assigned VLAN does not exist on the switch, the switch will create the related VLAN automatically, add the authenticated port to the VLAN and change the PVID based on the assigned VLAN.

If the assigned VLAN exists on the switch, the switch will directly add the authenticated port to the related VLAN and change the PVID instead of creating a new VLAN.

If no VLAN is supplied by the RADIUS server or if 802.1x authentication is disabled, the port will be in its original VLAN after successful authentication.

2) Click **Apply**.

2.1.3 Configuring 802.1x on Ports

Choose the menu **SECURITY > 802.1x > Port Config** to load the following page.

Figure 2-7 Port Config

Port Config									
UNIT1									
<input type="checkbox"/>	Port	Status	MAB	Guest VLAN (0-4094)	Port Control	Port Method	Maximum Request (1-9)	Quiet Period (0-999)	Supplicant Timeout (1-60)
<input type="checkbox"/>	1/0/1	Disable	Disable	0	Auto	MAC Based	3	10	30
<input type="checkbox"/>	1/0/2	Disable	Disable	0	Auto	MAC Based	3	10	30
<input type="checkbox"/>	1/0/3	Disable	Disable	0	Auto	MAC Based	3	10	30
<input type="checkbox"/>	1/0/4	Disable	Disable	0	Auto	MAC Based	3	10	30
<input type="checkbox"/>	1/0/5	Disable	Disable	0	Auto	MAC Based	3	10	30
<input type="checkbox"/>	1/0/6	Disable	Disable	0	Auto	MAC Based	3	10	30
<input type="checkbox"/>	1/0/7	Disable	Disable	0	Auto	MAC Based	3	10	30
<input type="checkbox"/>	1/0/8	Disable	Disable	0	Auto	MAC Based	3	10	30
<input type="checkbox"/>	1/0/9	Disable	Disable	0	Auto	MAC Based	3	10	30
<input type="checkbox"/>	1/0/10	Disable	Disable	0	Auto	MAC Based	3	10	30

Total: 54

Follow these steps to configure 802.1x authentication on the desired port:

1) Select one or more ports and configure the following parameters:

Status

Enable or disable 802.1x authentication on the port.

MAB	<p>Enable or disable the MAB (MAC-Based Authentication Bypass) feature for the port.</p> <p>With MAB feature enabled, the switch automatically sends the authentication server a RADIUS access request frame with the client's MAC address as the username and password. It is also necessary to configure the RADIUS server with the client's information for authentication. You can enable this feature on IEEE 802.1x ports connected to devices without 802.1x capability. For example, most printers, IP phones and fax machines do not have 802.1x capability.</p> <p>Note: MAB cannot work if Guest VLAN is enabled.</p>
Guest VLAN	<p>Specify a Guest VLAN ID for the port. It ranges from 0 to 4094. 0 means the Guest VLAN is disabled on the port.</p>
Port Control	<p>Select the Port Control Mode for the port. By default, it is Auto.</p> <p>Auto: If this option is selected, the port can access the network only when it is authenticated.</p> <p>Force-Authorized: If this option is selected, the port can access the network without authentication.</p> <p>Force-Unauthorized: If this option is selected, the port can never be authenticated.</p>
Port Method	<p>Select the Port Method for the port.</p> <p>MAC Based: All clients connected to the port need to be authenticated.</p> <p>Port Based: If a client connected to the port is authenticated, other clients can access the LAN without authentication.</p>
Maximum Request (1-9)	<p>Specify the maximum number of attempts to send the authentication packet. Values can range from 1 to 9 times and the default is 3 times.</p>
Quiet Period (1-999)	<p>Specify the Quiet Period. It ranges from 0 to 999 seconds and the default time is 10 seconds.</p> <p>The quiet period starts after the authentication fails. During the quiet period, the switch does not process authentication requests from the same client.</p>
Supplicant Timeout (1-60)	<p>Specify the maximum time which the switch waits for a response from the client. Values can range from 1 to 9 seconds and the default time is 3 seconds.</p> <p>If the switch does not receive any reply from the client within the specified time, it will resend the request.</p>
Authorized	<p>Displays whether the port is authorized or not.</p>
LAG	<p>Displays the LAG the port belongs to.</p>

2) Click **Apply**.

Note:

If a port is in an LAG, its 802.1x authentication function cannot be enabled. Also, a port with 802.1x authentication enabled cannot be added to any LAG.

2.1.4 View the Authenticator State

Choose the menu **SECURITY > 802.1x > Authenticator State** to load the following page.

Figure 2-8 View Authenticator State

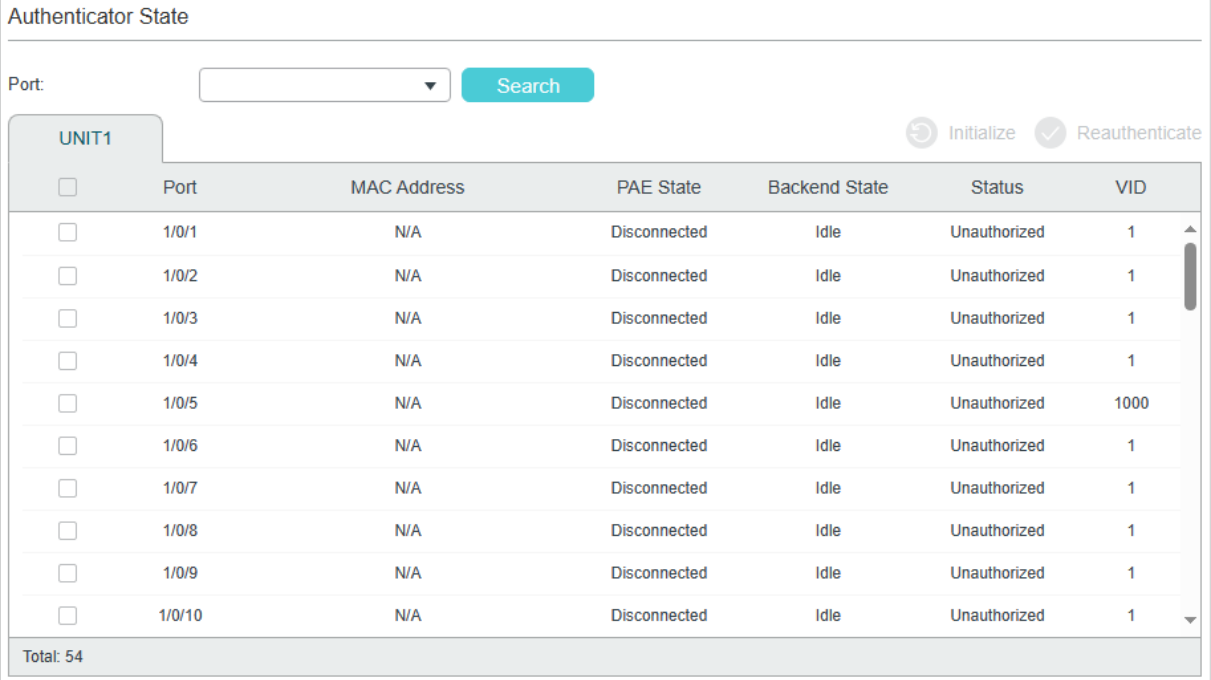

Port	MAC Address	PAE State	Backend State	Status	VID
1/0/1	N/A	Disconnected	Idle	Unauthorized	1
1/0/2	N/A	Disconnected	Idle	Unauthorized	1
1/0/3	N/A	Disconnected	Idle	Unauthorized	1
1/0/4	N/A	Disconnected	Idle	Unauthorized	1
1/0/5	N/A	Disconnected	Idle	Unauthorized	1000
1/0/6	N/A	Disconnected	Idle	Unauthorized	1
1/0/7	N/A	Disconnected	Idle	Unauthorized	1
1/0/8	N/A	Disconnected	Idle	Unauthorized	1
1/0/9	N/A	Disconnected	Idle	Unauthorized	1
1/0/10	N/A	Disconnected	Idle	Unauthorized	1

Total: 54

On this page, you can view the authentication status of each port:

Port	Displays the port number.
MAC Address	Displays the MAC address of the authenticated device. When the port method is Port Based, the MAC address of the first authenticated device will be displayed with a suffix "p".
PAE State	Displays the current state of the authenticator PAE (Physical Address Extension) state machine. Possible values are: Initialize, Disconnected, Connecting, Authenticating, Authenticated, Aborting, Held, ForceAuthorized and ForceUnauthorized.
Backend State	Displays the current state of the backend authentication state machine. Possible values are: Request, Response, Success, Fail, Timeout, Initialize and Idle.
Status	Displays whether the client connected to the port is authorized or not.
VID	Displays the VLAN ID assigned by the authenticator to the supplicant device when the related port is authorized. If the related port is unauthorized, the Guest VLAN ID will be displayed if there is a Guest VLAN ID.

2.2 Using the CLI

2.2.1 Configuring the RADIUS Server

Follow these steps to configure RADIUS:

Step 1	<p>configure</p> <p>Enter global configuration mode.</p>
Step 2	<p>radius-server host <i>ip-address</i> [auth-port <i>port-id</i>] [acct-port <i>port-id</i>] [timeout <i>time</i>] [retransmit <i>number</i>] [nas-id <i>nas-id</i>] key { [0] <i>string</i> 7 <i>encrypted-string</i> }</p> <p>Add the RADIUS server and configure the related parameters as needed.</p> <p>host <i>ip-address</i>: Enter the IP address of the server running the RADIUS protocol.</p> <p>auth-port <i>port-id</i>: Specify the UDP destination port on the RADIUS server for authentication requests. The default setting is 1812.</p> <p>acct-port <i>port-id</i>: Specify the UDP destination port on the RADIUS server for accounting requests. The default setting is 1813. Generally, the accounting feature is not used in the authentication account management.</p> <p>timeout <i>time</i>: Specify the time interval that the switch waits for the server to reply before resending. The valid values are from 1 to 9 seconds and the default setting is 5 seconds.</p> <p>retransmit <i>number</i>: Specify the number of times a request is resent to the server if the server does not respond. The valid values are from 1 to 3 and the default setting is 2.</p> <p>nas-id <i>nas-id</i>: Specify the name of the NAS (Network Access Server) to be contained in RADIUS packets for identification. It ranges from 1 to 31 characters. The default value is the MAC address of the switch. Generally, the NAS indicates the switch itself.</p> <p>key { [0] <i>string</i> 7 <i>encrypted-string</i> }: Specify the shared key. 0 and 7 prevent the encryption type. 0 indicates that an unencrypted key will follow. 7 indicates that a symmetric encrypted key with a fixed length will follow. By default, the encryption type is 0. <i>string</i> is the shared key for the switch and the server. <i>encrypted-string</i> is a symmetric encrypted key with a fixed length, which you can copy from the configuration file of another switch. The key or encrypted-key you configured here will be displayed in the encrypted form.</p>
Step 3	<p>aaa group radius <i>group-name</i></p> <p>Create a RADIUS server group.</p> <p>radius: Specify the group type as radius.</p> <p>group-name: Specify a name for the group.</p>
Step 4	<p>server <i>ip-address</i></p> <p>Add the existing servers to the server group.</p> <p>ip-address: Specify IP address of the server to be added to the group.</p>
Step 5	<p>exit</p> <p>Return to global configuration mode.</p>

Step 6	aaa authentication dot1x default { method } Select the RADIUS group for 802.1x authentication. <i>method</i> : Specify the RADIUS group for 802.1x authentication. aaa accounting dot1x default { method } Select the RADIUS group for 802.1x accounting. <i>method</i> : Specify the RADIUS group for 802.1x accounting. Note: If multiple RADIUS servers are available, you are suggested to add them to different server groups respectively for authentication and accounting.
Step 7	show radius-server (Optional) Verify the configuration of RADIUS server.
Step 8	show aaa group [group-name] (Optional) Verify the configuration of server group.
Step 9	show aaa authentication dot1x (Optional) Verify the authentication method list.
Step 10	show aaa accounting dot1x (Optional) Verify the accounting method list.
Step 11	end Return to privileged EXEC mode.
Step 12	copy running-config startup-config Save the settings in the configuration file.

The following example shows how to enable AAA, add a RADIUS server to the server group named radius1, and apply this server group to the 802.1x authentication. The IP address of the RADIUS server is 192.168.0.100; the shared key is 123456; the authentication port is 1812; the accounting port is 1813.

Switch#configure

Switch(config)#radius-server host 192.168.0.100 auth-port 1812 acct-port 1813 key 123456

Switch(config)#aaa group radius radius1

Switch(aaa-group)#server 192.168.0.100

Switch(aaa-group)#exit

Switch(config)#aaa authentication dot1x default radius1

Switch(config)#aaa accounting dot1x default radius1

Switch(config)#show radius-server

Server Ip	Auth Port	Acct Port	Timeout	Retransmit	NAS Identifier	Shared key
192.168.0.100	1812	1813	5	2	000AEB132397	123456

Switch(config)#show aaa group radius1

192.168.0.100

Switch(config)#show aaa authentication dot1x

Methodlist	pri1	pri2	pri3	pri4
default	radius1	--	--	--

Switch(config)#show aaa accounting dot1x

Methodlist	pri1	pri2	pri3	pri4
default	radius1	--	--	--

Switch(config)#end

Switch#copy running-config startup-config

2.2.2 Configuring 802.1x Globally

Follow these steps to configure 802.1x globally:

-
- | | |
|--------|--|
| Step 1 | configure
Enter global configuration mode. |
|--------|--|
-
- | | |
|--------|--|
| Step 2 | dot1x system-auth-control
Enable 802.1x authentication globally. |
|--------|--|
-

Step 3	dot1x auth-protocol { pap eap } Configure the 802.1x authentication protocol. pap: Specify the authentication protocol as PAP. If this option is selected, the 802.1x authentication system uses EAP (Extensible Authentication Protocol) packets to exchange information between the switch and the client. The transmission of EAP packets is terminated at the switch and the EAP packets are converted to other protocol (such as RADIUS) packets, and transmitted to the authentication server. eap: Specify the authentication protocol as EAP. If this option is selected, the 802.1x authentication system uses EAP packets to exchange information between the switch and the client. The EAP packets with authentication data are encapsulated in the advanced protocol (such as RADIUS) packets, and transmitted to the authentication server.
Step 4	dot1x accounting (Optional) Enable the accounting feature.
Step 5	dot1x handshake (Optional) Enable the Handshake feature. The Handshake feature is used to detect the connection status between the TP-Link 802.1x Client and the switch. Please disable Handshake feature if you are using other client softwares instead of TP-Link 802.1x Client.
Step 6	dot1x vlan-assignment (Optional) Enable or disable the 802.1x VLAN assignment feature. 802.1x VLAN assignment is a technology allowing the RADIUS server to send the VLAN assignment to the port when the port is authenticated. If the assigned VLAN does not exist on the switch, the switch will create the related VLAN automatically, add the authenticated port to the VLAN and change the PVID based on the assigned VLAN. If the assigned VLAN exists on the switch, the switch will directly add the authenticated port to the related VLAN and change the PVID instead of creating a new VLAN. If no VLAN is supplied by the RADIUS server or if 802.1x authentication is disabled, the port will be in its original VLAN after successful authentication.
Step 7	show dot1x global (Optional) Verify global configurations of 802.1x.
Step 8	end Return to privileged EXEC mode.
Step 9	copy running-config startup-config Save the settings in the configuration file.

The following example shows how to enable 802.1x authentication, configure PAP as the authentication method and keep other parameters as default:

```
Switch#configure
```

```
Switch(config)#dot1x system-auth-control
```

```
Switch(config)#dot1x auth-protocol pap
```

```
Switch(config)#show dot1x global
```

```
802.1X State:          Enabled
```

```
Authentication Protocol:  PAP
```

```
Handshake State:       Enabled
```

```
802.1X Accounting State:  Disabled
```

```
802.1X VLAN Assignment State:  Disabled
```

```
Switch(config)#end
```

```
Switch#copy running-config startup-config
```

2.2.3 Configuring 802.1x on Ports

Follow these steps to configure the port:

Step 1	<p>configure</p> <p>Enter global configuration mode.</p>
Step 2	<p>interface {fastEthernet port range fastEthernet port-list gigabitEthernet port range gigabitEthernet port-list ten-gigabitEthernet port range ten-gigabitEthernet port-list }</p> <p>Enter interface configuration mode.</p> <p><i>port</i>: Enter the ID of the port to be configured.</p>
Step 3	<p>dot1x</p> <p>Enable 802.1x authentication for the port.</p>
Step 4	<p>dot1x mab</p> <p>Enable the MAB (MAC-Based Authentication Bypass) feature for the port.</p> <p>With MAB feature enabled, the switch automatically sends the authentication server a RADIUS access request frame with the client's MAC address as the username and password. It is also necessary to configure the RADIUS server with the client's information for authentication. You can enable this feature on IEEE 802.1x ports connected to devices without 802.1x capability. For example, most printers, IP phones and fax machines do not have 802.1x capability.</p> <p>Note: MAB cannot work if Guest VLAN is enabled.</p>

Step 5	<p>dot1x guest-vlan vid</p> <p>(Optional) Configure guest VLAN on the port.</p> <p>vid: Specify the ID of the VLAN to be configured as the guest VLAN. The valid values are from 0 to 4094. 0 means that Guest VLAN is disabled on the port. The configured VLAN must be an existing 802.1Q VLAN. Clients in the guest VLAN can only access resources from specific VLANs.</p> <p>Note: To use Guest VLAN, the control type of the port should be configured as port-based.</p>
Step 6	<p>dot1x port-control { auto authorized-force unauthorized-force }</p> <p>Configure the control mode for the port. By default, it is auto.</p> <p>auto: If this option is selected, the port can access the network only when it is authenticated.</p> <p>authorized-force: If this option is selected, the port can access the network without authentication.</p> <p>unauthorized-force: If this option is selected, the port can never be authenticated.</p>
Step 7	<p>dot1x port-method { mac-based port-based }</p> <p>Configure the control type for the port. By default, it is mac-based.</p> <p>mac-based: All clients connected to the port need to be authenticated.</p> <p>port-based: If a client connected to the port is authenticated, other clients can access the LAN without authentication.</p>
Step 8	<p>dot1x max-req times</p> <p>Specify the maximum number of attempts to send the authentication packet for the client.</p> <p>times: The maximum attempts for the client to send the authentication packet. It ranges from 1 to 9 and the default is 3.</p>
Step 9	<p>dot1x quiet-period [time]</p> <p>(Optional) Enable the quiet feature for 802.1x authentication and configure the quiet period.</p> <p>time: Set a value between 1 and 999 seconds for the quiet period. It is 10 seconds by default. The quiet period starts after the authentication fails. During the quiet period, the switch does not process authentication requests from the same client.</p>
Step 10	<p>dot1x timeout supp-timeout time</p> <p>Configure the supplicant timeout period.</p> <p>time: Specify the maximum time for which the switch waits for response from the client. It ranges from 1 to 60 seconds and the default time is 30 seconds. If the switch does not receive any reply from the client within the specified time, it will resend the request.</p>
Step 11	<p>show dot1x interface [fastEthernet port gigabitEthernet port ten-gigabitEthernet port]</p> <p>(Optional) Verify the configurations of 802.1x authentication on the port.</p> <p>port: Enter the ID of the port to be configured. If no specific port is entered, the switch will show configurations of all ports.</p>

Step 12	end Return to privileged EXEC mode.
Step 13	copy running-config startup-config Save the settings in the configuration file.

The following example shows how to enable 802.1x authentication on port 1/0/2, configure the control type as port-based, and keep other parameters as default:

Switch#configure

Switch(config)#interface gigabitEthernet 1/0/2

Switch(config-if)#dot1x

Switch(config-if)#dot1x port-method port-based

Switch(config-if)#show dot1x interface gigabitEthernet 1/0/2

Port	State	MAB State	GuestVLAN	PortControl	PortMethod
----	-----	-----	-----	-----	-----
Gi1/0/2	disabled	disabled	0	auto	port-based

MaxReq	QuietPeriod	SuppTimeout	Authorized	LAG
-----	-----	-----	-----	---
3	10	30	unauthorized	N/A

Switch(config-if)#end

Switch#copy running-config startup-config

2.2.4 Viewing Authenticator State

You can view the authenticator state. If needed, you can also initialize or reauthenticate the specific client:

Step 1	show dot1x auth-state interface [fastEthernet port gigabitEthernet port ten-gigabitEthernet port] Displays the authenticator state.
Step 2	configure Enter global configuration mode.

-
- Step 3 **interface {fastEthernet *port* | range fastEthernet *port-list* | gigabitEthernet *port* | range gigabitEthernet *port-list* | ten-gigabitEthernet *port* | range ten-gigabitEthernet *port-list*}**
Enter interface configuration mode.

port: Enter the ID of the port to be configured.
-
- Step 4 **dot1x auth-init [mac *mac-address*]**
Initialize the specific client. To access the network, the client needs to provide the correct information to pass the authentication again.

mac-address: Enter the MAC address of the client that will be unauthorized.
-
- Step 5 **dot1x auth-reauth [mac *mac-address*]**
Reauthenticate the specific client.

mac-address: Enter the MAC address of the client that will be reauthenticated.
-
- Step 6 **end**
Return to privileged EXEC mode.
-
- Step 7 **copy running-config startup-config**
Save the settings in the configuration file.
-

3 Configuration Example

3.1 Network Requirements

The network administrator wants to control access from the end users (clients) in the company. It is required that all clients need to be authenticated separately and only the authenticated clients can access the internet.

3.2 Configuration Scheme

- To authenticate clients separately, enable 802.1x authentication, configure the control mode as auto, and set the control type as MAC based.
- Enable 802.1x authentication on the ports connected to clients.
- Keep 802.1x authentication disabled on ports connected to the authentication server and the internet, which ensures unrestricted connections between the switch and the authentication server or the internet.

3.3 Network Topology

As shown in the following figure, Switch A acts as the authenticator. Port 1/0/1 is connected to the client, port 1/0/2 is connected to the RADIUS server, and port 1/0/3 is connected to the internet.

Figure 3-1 Network Topology

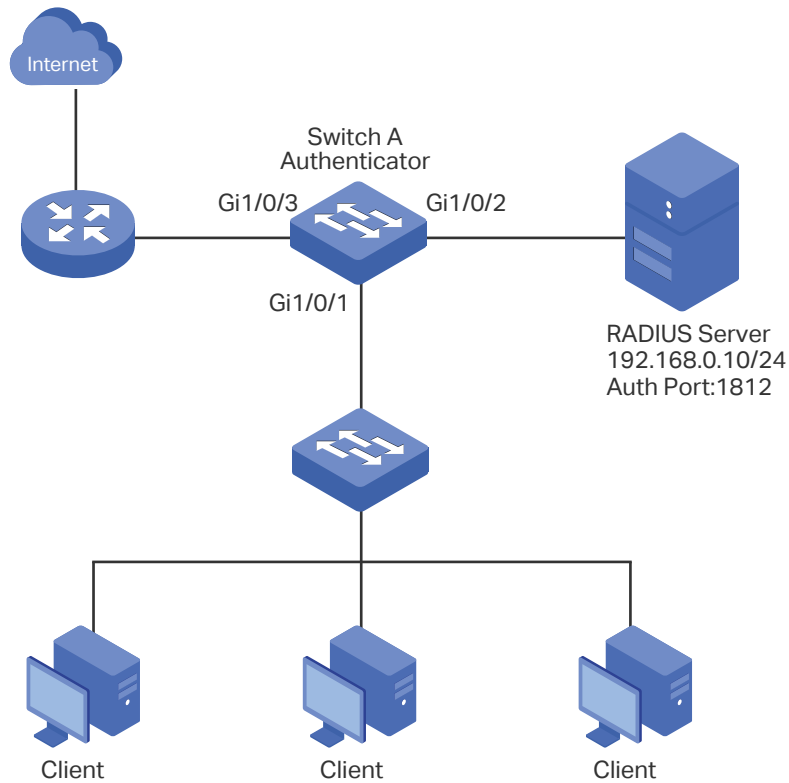

Demonstrated with SG6654XHP acting as the authenticator, the following sections provide configuration procedure in two ways: using the GUI and using the CLI.

3.4 Using the GUI

- 1) Choose the menu **SECURITY > AAA > RADIUS Config** and click **+ Add** to load the following page. Configure the parameters of the RADIUS server and click **Create**.

Figure 3-2 Adding RADIUS Server

RADIUS Server

Server IP:	<input style="width: 90%;" type="text" value="192.168.0.10"/>	<small>(Format: 192.168.0.1)</small>
Shared Key:	<input style="width: 90%;" type="text" value="123456"/>	<small>1-32 characters. Only numbers, letters and the following symbols are allowed: - . / : @ _ .</small>
Authentication Port:	<input style="width: 90%;" type="text" value="1812"/>	<small>(1-65535)</small>
Accounting Port:	<input style="width: 90%;" type="text" value="1813"/>	<small>(1-65535)</small>
Retransmit:	<input style="width: 90%;" type="text" value="2"/>	<small>(1-3)</small>
Timeout:	<input style="width: 90%;" type="text" value="5"/>	<small>seconds (1-9)</small>
NAS Identifier:	<input style="width: 90%;" type="text"/>	<small>(Optional)</small>

- 2) Choose the menu **SECURITY > AAA > Server Group** and click **+ Add** to load the following page. Specify the group name as RADIUS1, select the server type as RADIUS and server IP as 192.168.0.10. Click **Create**.

Figure 3-3 Creating Server Group

The screenshot shows the 'Server Group' configuration page. It has a teal header. Below the header, there are three input fields: 'Server Group:' with the value 'RADIUS1' and a '(1-15 characters)' note; 'Server Type:' with a dropdown menu showing 'RADIUS'; and 'Server IP:' with a dropdown menu showing '192.168.0.10'. At the bottom right, there are two buttons: 'Cancel' and 'Create'. The 'Create' button is highlighted with a red box.

- 3) Choose the menu **SECURITY > AAA > Dot1x List** to load the following page. In the **Authentication Dot1x Method** section, select RADIUS1 as the RADIUS server group for authentication, and click **Apply**.

Figure 3-4 Configuring Authentication RADIUS Server

The screenshot shows the 'Authentication Dot1x Method' configuration page. It has a white header. Below the header, there are two input fields: 'Method List:' with the value 'default' and 'Pri1:' with a dropdown menu showing 'RADIUS1'. At the bottom right, there is an 'Apply' button highlighted with a red box.

- 4) Choose the menu **SECURITY > 802.1x > Global Config** to load the following page. Enable 802.1x authentication and configure the Authentication Method as EAP. Keep the default authentication settings. Click **Apply**.

Figure 3-5 Configuring Global Settings

The screenshot shows the 'Global Config' page. It has a white header. Below the header, there are several settings: '802.1x:' with a checked checkbox and the text 'Enable'; 'Authentication Protocol:' with a dropdown menu showing 'EAP'; 'Accounting:' with an unchecked checkbox and the text 'Enable'; 'Handshake:' with a checked checkbox and the text 'Enable'; and 'VLAN Assignment:' with an unchecked checkbox and the text 'Enable'. At the bottom right, there is an 'Apply' button highlighted with a red box.

- 5) Choose the menu **SECURITY > 802.1x > Port Config** to load the following page. For port 1/0/1, enable 802.1x authentication, set the Control Mode as auto and set the Control Type as MAC Based; For port 1/0/2 and port 1/0/3, disable 802.1x authentication.

Figure 3-6 Configuring Port

Port Config

UNIT1

<input type="checkbox"/>	Port	Status	MAB	Guest VLAN (0-4094)	Port Control	Port Method	Maximum Request (1-9)	Quiet Period (0-999)	Supplicant Timeout (1-60)
<input checked="" type="checkbox"/>	1/0/1	Enable	Disable	0	Auto	MAC Based	3	10	30
<input type="checkbox"/>	1/0/2	Disable	Disable	0	Auto	MAC Based	3	10	30
<input type="checkbox"/>	1/0/3	Disable	Disable	0	Auto	MAC Based	3	10	30
<input type="checkbox"/>	1/0/4	Disable	Disable	0	Auto	MAC Based	3	10	30
<input type="checkbox"/>	1/0/5	Disable	Disable	0	Auto	MAC Based	3	10	30
<input type="checkbox"/>	1/0/6	Disable	Disable	0	Auto	MAC Based	3	10	30
<input type="checkbox"/>	1/0/7	Disable	Disable	0	Auto	MAC Based	3	10	30
<input type="checkbox"/>	1/0/8	Disable	Disable	0	Auto	MAC Based	3	10	30
<input type="checkbox"/>	1/0/9	Disable	Disable	0	Auto	MAC Based	3	10	30
<input type="checkbox"/>	1/0/10	Disable	Disable	0	Auto	MAC Based	3	10	30

Total: 54 1 entry selected. Cancel Apply

- 6) Click  Save to save the settings.

3.5 Using the CLI

- 1) Configure the RADIUS parameters.

```
Switch_A(config)#radius-server host 192.168.0.10 auth-port 1812 key 123456
```

```
Switch_A(config)#aaa group radius RADIUS1
```

```
Switch_A(aaa-group)#server 192.168.0.10
```

```
Switch_A(aaa-group)#exit
```

```
Switch_A(config)#aaa authentication dot1x default RADIUS1
```

- 2) Globally enable 802.1x authentication and set the authentication protocol.

```
Switch_A(config)#dot1x system-auth-control
```

```
Switch_A(config)#dot1x auth-protocol eap
```

- 3) Disable 802.1x authentication on port 1/0/2 and port 1/0/3. Enable 802.1x authentication on port 1/0/1, set the control mode as auto, and set the control type as MAC based.

```
Switch_A(config)#interface gigabitEthernet 1/0/2
```

```
Switch_A(config-if)#no dot1x
```

```
Switch_A(config-if)#exit
```

```

Switch_A(config)#interface gigabitEthernet 1/0/3
Switch_A(config-if)#no dot1x
Switch_A(config-if)#exit
Switch_A(config)#interface gigabitEthernet 1/0/1
Switch_A(config-if)#dot1x
Switch_A(config-if)#dot1x port-method mac-based
Switch_A(config-if)#dot1x port-control auto
Switch_A(config-if)#exit

```

Verify the Configurations

Verify the global configurations of 802.1x authentication:

```

Switch_A#show dot1x global
802.1X State:          Enabled
Authentication Protocol:  EAP
Handshake State:       Enabled
802.1X Accounting State:  Disabled
802.1X VLAN Assignment State:  Disabled

```

Verify the configurations of 802.1x authentication on the port:

```

Switch_A#show dot1x interface

```

Port	State	MAB State	GuestVLAN	PortControl	PortMethod
----	-----	-----	-----	-----	-----
Gi1/0/1	enabled	disabled	0	auto	mac-based
Gi1/0/2	disabled	disabled	0	auto	mac-based
Gi1/0/3	disabled	disabled	0	auto	mac-based
...					
MaxReq	QuietPeriod	SuppTimeout	Authorized	LAG	
-----	-----	-----	-----	---	
3	10	30	unauthorized	N/A	
3	10	30	unauthorized	N/A	

```
3          10          30          unauthorized  N/A
...
```

Verify the configurations of RADIUS :

```
Switch_A#show aaa global
```

Module	Login List	Enable List
Telnet	default	default
Ssh	default	default
Http	default	default

```
Switch_A#show aaa authentication dot1x
```

Methodlist	pri1	pri2	pri3	pri4
default	RADIUS1	--	--	--

```
Switch_A#show aaa group RADIUS1
```

```
192.168.0.10
```

4 Appendix: Default Parameters

Default settings of 802.1x are listed in the following table.

Table 4-1 Default Settings of 802.1x

Parameter	Default Setting
Global Config	
802.1x Authentication	Disabled
Authentication Method	EAP
Handshake	Enabled
Accounting	Disabled
VLAN Assignment	Disabled
Port Config	
802.1x Status	Disabled
MAB	Disabled
Guest VLAN	Disabled
Port Control	Auto
Guest VLAN	0
Maximum Request	3
Quiet Period	10 seconds
Supplicant Timeout	30 seconds
Port Method	MAC Based
Dot1X List	
Authentication Dot1x Method List	List Name: default Pri1: radius
Accounting Dot1x Method List	List Name: default Pri1: radius

Part 28

Configuring Port Security

CHAPTERS

1. Overview
2. Port Security Configuration
3. Appendix: Default Parameters

1 Overview

You can use the Port Security feature to limit the number of MAC addresses that can be learned on each port, thus preventing the MAC address table from being exhausted by the attack packets. In addition, the switch can send a notification if the number of learned MAC addresses on the port exceeds the limit.

2 Port Security Configuration

2.1 Using the GUI

Choose the menu **SECURITY > Port Security** to load the following page.

Figure 2-1 Port Security

Port Security Config						
UNIT1						
<input type="checkbox"/>	Port	Max Learned Number of MAC	Current Learned Number	Exceed Max Learned Trap	Learn Address Mode	Status
<input type="checkbox"/>	Gi1/0/1	64	0	Disable	Delete on Timeout	Disable
<input type="checkbox"/>	Gi1/0/2	64	0	Disable	Delete on Timeout	Disable
<input type="checkbox"/>	Gi1/0/3	64	0	Disable	Delete on Timeout	Disable
<input type="checkbox"/>	Gi1/0/4	64	0	Disable	Delete on Timeout	Disable
<input type="checkbox"/>	Gi1/0/5	64	0	Disable	Delete on Timeout	Disable
<input type="checkbox"/>	Gi1/0/6	64	0	Disable	Delete on Timeout	Disable
<input type="checkbox"/>	Gi1/0/7	64	0	Disable	Delete on Timeout	Disable
<input type="checkbox"/>	Gi1/0/8	64	0	Disable	Delete on Timeout	Disable
<input type="checkbox"/>	Gi1/0/9	64	0	Disable	Delete on Timeout	Disable
<input type="checkbox"/>	Gi1/0/10	64	0	Disable	Delete on Timeout	Disable
Total: 54						

Follow these steps to configure Port Security:

- 1) Select one or more ports and configure the following parameters.

Port	Select one or more ports to configure.
Max Learned Number of MAC	Specify the maximum number of MAC addresses that can be learned on the port. When the learned MAC address number reaches the limit, the port will stop learning. The default value is 64.
Current Learned MAC	Displays the number of MAC addresses that have been learned on the port.
Exceed Max Learned Trap	Enable Exceed Max Learned Trap, and when the maximum number of learned MAC addresses on the specified port is exceeded, a notification will be generated and sent to the management host.

Learn Address Mode	<p>elect the learn mode of the MAC addresses on the port. Three modes are provided:</p> <p>Delete on Timeout: The switch will delete the MAC addresses that are not used or updated within the aging time. It is the default setting.</p> <p>Delete on Reboot: The learned MAC addresses are out of the influence of the aging time and can only be deleted manually. The learned entries will be cleared after the switch is rebooted.</p> <p>Permanent: The learned MAC addresses are out of the influence of the aging time and can only be deleted manually. The learned entries will be saved even the switch is rebooted.</p>
Status	<p>Select the status of Port Security. Three kinds of status can be selected:</p> <p>Forward: When the number of learned MAC addresses reaches the limit, the port will stop learning but send the packets with the MAC addresses that have not been learned.</p> <p>Drop: When the number of learned MAC addresses reaches the limit, the port will stop learning and discard the packets with the MAC addresses that have not been learned.</p> <p>Disable: The number limit on the port is not effective, and the switch follows the original forwarding rules. It is the default setting.</p>

2) Click **Apply**.

 **Note:**

- Port Security cannot be enabled on the member port of a LAG, and the port with Port Security enabled cannot be added to a LAG.
- Port Security and 802.1x cannot be enabled at the same time for a port.

2.2 Using the CLI

Follow these steps to configure Port Security:

Step 1	<p>configure Enter global configuration mode.</p>
Step 2	<p>interface { fastEthernet port range fastEthernet port-list gigabitEthernet port range gigabitEthernet port-list ten-gigabitEthernet port range ten-gigabitEthernet port-list } Enter interface configuration mode.</p>

-
- Step 3 **mac address-table max-mac-count { [max-number *num*] [exceed-max-learned enable | disable] [mode { dynamic | static | permanent }] [status { forward | drop | disable }] }**
 Enable the port security feature of the port and configure the related parameters.
num: The maximum number of MAC addresses that can be learned on the port. The valid values are from 0 to 64. The default value is 64.
- exceed-max-learned:** With exceed-max-learned enabled, when the maximum number of MAC addresses on the specified port is exceeded, a notification will be generated and sent to the management host.
- enable:** Enable exceed-max-learned.
disable: Disable exceed-max-learned.
- mode:** Learn mode of the MAC address. There are three modes:
- dynamic:** The switch will delete the MAC addresses that are not used or updated within the aging time.
- static:** The learned MAC addresses are out of the influence of the aging time and can only be deleted manually. The learned entries will be cleared after the switch is rebooted.
- permanent:** The learned MAC address is out of the influence of the aging time and can only be deleted manually. The learned entries will be saved even the switch is rebooted.
- status:** Status of port security feature. By default, it is disabled.
- drop:** When the number of learned MAC addresses reaches the limit, the port will stop learning and discard the packets with the MAC addresses that have not been learned.
- forward:** When the number of learned MAC addresses reaches the limit, the port will stop learning but send the packets with the MAC addresses that have not been learned.
- disable:** The number limit on the port is not effective, and the switch follows the original forwarding rules. It is the default setting.
-
- Step 4 **show mac address-table max-mac-count interface { fastEthernet *port* | gigabitEthernet *port* | ten-gigabitEthernet *port* }**
 Verify the Port Security configuration and the current learned MAC addresses of the port.
-
- Step 5 **end**
 Return to privileged EXEC mode.
-
- Step 6 **copy running-config startup-config**
 Save the settings in the configuration file.
-

 **Note:**

- Port Security cannot be enabled on the member port of a LAG, and the port with Port Security enabled cannot be added to a LAG.
- On one port, Port Security and 802.1x cannot be enabled at the same time.

The following example shows how to set the maximum number of MAC addresses that can be learned on port 1/0/1 as 30, enable exceed-max-learned feature and configure the mode as permanent and the status as drop:

```
Switch#configure
```

```
Switch(config)#interface gigabitEthernet 1/0/1
```

```
Switch(config-if)#mac address-table max-mac-count max-number 30 exceed-max-learned enable mode permanent status drop
```

```
Switch(config-if)#show mac address-table max-mac-count interface gigabitEthernet 1/0/1
```

Port	Max-learn	Current-learn	Exceed Max Limit	Mode	Status
----	-----	-----	-----	-----	-----
Gi1/0/1	30	0	disable	permanent	drop

```
Switch(config-if)#end
```

```
Switch#copy running-config startup-config
```

3 Appendix: Default Parameters

Default settings of Port Security are listed in the following table.

Table 3-1 Default Parameters of Port Security

Parameter	Default Setting
Max Learned Number of MAC	64
Current Learned Number	0
Exceed Max Learned Trap	Disabled
Learn Address Mode	Delete on Timeout
Status	Disabled

Part 29

Configuring ACL

CHAPTERS

1. Overview
2. ACL Configuration
3. Configuration Example for ACL
4. Appendix: Default Parameters

1 Overview

ACL (Access Control List) filters traffic as it passes through a switch, and permits or denies packets crossing specified interfaces or VLANs. It accurately identifies and processes the packets based on the ACL rules. In this way, ACL helps to limit network traffic, manage network access behaviors, forward packets to specified ports and more.

To configure ACL, follow these steps:

- 1) Configure a time range during which the ACL is in effect.
- 2) Create an ACL and configure the rules to filter different packets.
- 3) Bind the ACL to a port or VLAN to make it effective.

Configuration Guidelines

- A packet "matches" an ACL rule when it meets the rule's matching criteria. The resulting action will be either to "permit" or "deny" the packet that matches the rule.
- If no ACL rule is configured, the packets will be forwarded without being processed by the ACL. If there is configured ACL rules and no matching rule is found, the packets will be dropped.

2 ACL Configuration

2.1 Using the GUI

2.1.1 Configuring Time Range

Some ACL-based services or features may need to be limited to take effect only during a specified time period. In this case, you can configure a time range for the ACL. For details about Time Range configuration, please refer to [Managing System](#)

2.1.2 Creating an ACL

You can create different types of ACL and define the rules based on source MAC or IP address, destination MAC or IP address, protocol type, port number and so on.

MAC ACL: MAC ACL uses source and destination MAC address for matching operations.

IP ACL: IP ACL uses source and destination IP address, IP protocols and so on for matching operations.

Combined ACL: Combined ACL uses source and destination MAC address, and source and destination IP address for matching operations.

IPv6 ACL: IPv6 ACL uses source and destination IPv6 address for matching operations.

Packet Content ACL: Packet Content ACL analyzes and processes data packets based on 4 chunk match conditions, each chunk can specify a user-defined 4-byte segment carried in the packet's first 128 bytes.

 **Note:**

Packet Content ACL is only available on certain devices.

Choose the menu **SECURITY > ACL > ACL Config** and click  **Add** to load the following page.

Figure 2-1 Creating an ACL

Follow these steps to create an ACL:

- 1) Choose one ACL type and enter a number to identify the ACL.
- 2) (Optional) Assign a name to the ACL.
- 3) Click **Create**.

 **Note:**

The supported ACL type and ID range varies on different switch models. Please refer to the on-screen information.

2.1.3 Configuring ACL Rules

 **Note:**

Every ACL has an implicit deny all rule at the end of an ACL rule list. That is, if an ACL is applied to a packet and none of the explicit rules match, then the final implicit deny all rule takes effect and the packet is dropped.

The created ACL will be displayed on the **SECURITY > ACL > ACL Config** page.

Figure 2-2 Editing ACL

<input type="checkbox"/>	ACL Type	ACL ID	ACL Name	Rules	Operation
<input type="checkbox"/>	IP ACL	500	ACL1	None	Edit ACL
Total: 1					

Click **Edit ACL** in the **Operation** column. Then you can configure rules for this ACL.

The following sections introduce how to configure MAC ACL, IP ACL, Combined ACL and IPv6 ACL.

Configuring MAC ACL Rule

Click **Edit ACL** for a MAC ACL entry to load the following page.

Figure 2-3 Configuring the MAC ACL Rule

ACL Details

ACL Type: MAC ACL
 ACL ID: 1
 ACL Name: ACL

ACL Rules Config

↕ Resequence

+ Add
 - Delete
↻ Refresh

<input type="checkbox"/>	Index	Rule ID	S-MAC	D-MAC	Action	Total Matched Counter	Operation
No entries in this table.							
Total: 0							

In **ACL Rules Table** section, click + Add and the following page will appear.

Figure 2-4 Configuring the MAC ACL Rule

MAC ACL Rule

ACL ID: 1
 ACL Name: ACL

Rule ID: Auto Assign

Operation: Permit ▼

S-MAC: (Format: FF-FF-FF-FF-FF-FF)
 Mask: (Format: FF-FF-FF-FF-FF-FF)

D-MAC: (Format: FF-FF-FF-FF-FF-FF)
 Mask: (Format: FF-FF-FF-FF-FF-FF)

VLAN ID: (1-4094)

EtherType: (4-hex number)

User Priority: Default ▼

Time Range: ▼ (Optional)

Logging: Disable ▼

Policy

Mirroring

Redirect

Rate Limit

QoS Remark

Discard
Apply

Follow these steps to configure the MAC ACL rule:

- 1) In the **MAC ACL Rule** section, configure the following parameters:

Rule ID	Enter an ID number to identify the rule. It should not be the same as any existing IP ACL rule IDs. If you select Auto Assign , the rule ID will be assigned automatically and the interval between rule IDs is 5.
Operation	Select an action to be taken when a packet matches the rule. Permit: To forward the matched packets. Deny: To discard the matched packets.
Fragment	With this option selected, the rule will be applied to all fragment packets except for the last fragment packet in the fragment packet group.
S-IP/Mask	Specify the source IP address with a mask.
D-IP/Mask	Specify the destination IP address with a mask.
IP Protocol	Select a protocol type from the drop-down list. The default is No Limit, which indicates that packets of all protocols will be matched. You can also select User-defined to customize the IP protocol. If TCP protocol is selected, you can configure the TCP flags to be used for the rule's matching operations. There are six flags and each has three options, which are *, 0 and 1. The default is *, which indicates that the flag is not used for matching operations. URG: Urgent flag ACK: Acknowledge flag PSH: Push flag RST: Reset flag SYN: Synchronize flag FIN: Finish flag
S-Port/D-Port	Specify the source and destination port number with a mask when TCP/UDP is selected as the IP protocol. Value: Specify the port number. Mask: Specify the port mask with 4 hexadecimal numbers.
DSCP	Specify a DSCP value to be matched between 0 and 63. The default is No Limit.
IP ToS	Specify an IP ToS value to be matched between 0 and 15.
IP Pre	Specify an IP Precedence value to be matched between 0 and 7.
Time Range	Select a time range during which the rule will take effect. The default value is No Limit, which means the rule is always in effect. The Time Range referenced here can be created on the SYSTEM > Time Range page.

Logging

Enable Logging function for the IP ACL rule. Then the times that the rule is matched will be logged every 5 minutes. With ACL Counter trap enabled, a related trap will be generated if the matching times changes. You can refer to Total Matched Counter in the ACL Rules Table to view the matching times.

- 2) In the **Policy** section, enable or disable the Mirroring feature for the matched packets. With this option enabled, choose a destination port to which the packets will be mirrored.

Figure 2-5 Configuring Mirroring

The screenshot shows the 'Policy' configuration interface. The 'Mirroring' checkbox is checked. Below it is a 'Port:' input field with a placeholder '(Format: 1/0/1, input or choose below)'. Underneath is a grid of port icons for 'UNIT1'. The ports are arranged in four rows: Row 1 (1-33), Row 2 (2-34), Row 3 (35-47, 49-53), and Row 4 (36-48, 50-54). Port 1 is highlighted with a blue background, indicating it is selected. A legend at the bottom shows three icons: a blue square for 'Selected', a white square for 'Unselected', and a grey square for 'Not Available'.

- 3) In the **Policy** section, enable or disable the Redirect feature for the matched packets. With this option enabled, choose a destination port to which the packets will be redirected.

Figure 2-6 Configuring Redirect

The screenshot shows the 'Policy' configuration interface. The 'Redirect' checkbox is checked. Below it is a 'Destination Port:' input field with a placeholder '(Format: 1/0/1, input or choose below)'. Underneath is a grid of port icons for 'UNIT1', identical to the one in Figure 2-5. Port 1 is highlighted with a blue background, indicating it is selected. A legend at the bottom shows three icons: a blue square for 'Selected', a white square for 'Unselected', and a grey square for 'Not Available'.

Note:

In the Mirroring feature, the matched packets will be copied to the destination port and the original forwarding will not be affected. While in the Redirect feature, the matched packets will be forwarded only on the destination port.

- 4) In the **Policy** section, enable or disable the Rate Limit feature for the matched packets. With this option enabled, configure the related parameters.

Figure 2-7 Configuring Rate Limit

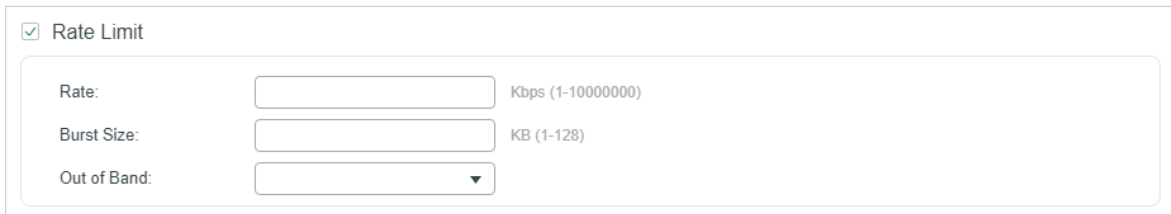

Rate Limit

Rate: Kbps (1-10000000)

Burst Size: KB (1-128)

Out of Band:

Rate	Specify the transmission rate for the matched packets.
Burst Size	Specify the number of bytes allowed in one second.
Out of Band	Specify the action to be taken for the packets whose rate is beyond the specified rate. None: The packets will be forwarded normally. Drop: The packets will be discarded. Remark DSCP: You can specify a DSCP value, and the DSCP field of the packets will be changed to the specified one. Note: Remark DSCP is only available on certain devices.

- 5) In the **Policy** section, enable or disable the QoS Remark feature for the matched packets. With this option enabled, configure the related parameters, and the remarked values will take effect in the QoS processing on the switch.

Figure 2-8 Configuring QoS Remark

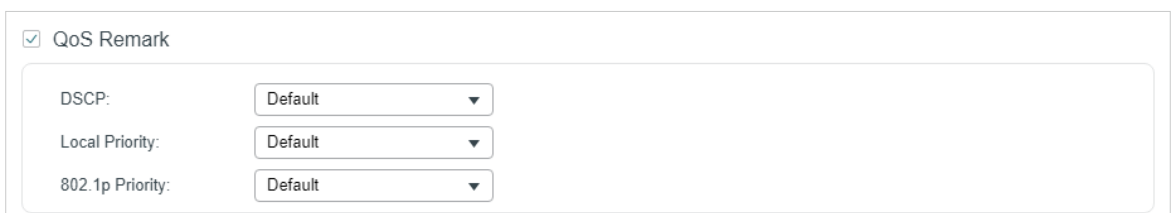

QoS Remark

DSCP: Default

Local Priority: Default

802.1p Priority: Default

DSCP	Specify the DSCP field for the matched packets. The DSCP field of the packets will be changed to the specified one.
Local Priority	Specify the local priority for the matched packets. The local priority of the packets will be changed to the specified one.
802.1p Priority	Specify the 802.1p priority for the matched packets. The 802.1p priority of the packets will be changed to the specified one.

- 6) Click **Apply**.

Configuring IP ACL Rule

Click **Edit ACL** for an IP ACL entry to load the following page.

Figure 2-9 Configuring the IP ACL Rule

ACL Details

ACL Type: IP ACL
 ACL ID: 500
 ACL Name: ACL1

ACL Rules Table

Resequence
 Add Delete Refresh

<input type="checkbox"/>	ID	Rule ID	S-IP	D-IP	IP Protocol	Action	Total Matched Counter	Operation
No entries in this table.								
Total: 0								

In **ACL Rules Config** section, click **Add** and the following page will appear.

Figure 2-10 Configuring the IP ACL Rule

IP ACL Rule

ACL ID: 500
 ACL Name: ACL1

Rule ID: Auto Assign

Operation: Permit ▼

S-IP: (Format: 192.168.0.1)
 Mask: (Format: 255.255.255.0)

D-IP: (Format: 192.168.0.1)
 Mask: (Format: 255.255.255.0)

IP Protocol: No Limit ▼

DSCP: No Limit ▼

IP ToS: (Optional, 0-15)

IP Pre: (Optional, 0-7)

Time Range: ▼ (Optional)

Logging: Disable ▼

Policy

Mirroring

Redirect

Rate Limit

QoS Remark

Discard
Apply

Follow these steps to configure the IP ACL rule:

1) In the **IP ACL Rule** section, configure the following parameters:

Rule ID	<p>Enter an ID number to identify the rule.</p> <p>It should not be the same as any current rule ID in the same ACL. For the convenience of inserting new rules to an ACL, you should set the appropriate interval between rule IDs.</p> <p>If you select Auto Assign, the rule ID will be assigned automatically by the system and the default increment between neighboring rule IDs is 5</p>
Operation	<p>Select an action to be taken when a packet matches the rule.</p> <p>Permit: To forward the matched packets.</p> <p>Deny: To discard the matched packets.</p>
Fragment	<p>With this option selected, the rule will be applied to all fragment packets except for the last fragment packet in the fragment packet group.</p> <p>Note: Fragment is only available on certain devices.</p>
S-IP/Mask	<p>Enter the source IP address with a mask. A value of 1 in the mask indicates that the corresponding bit in the address will be matched.</p>
D-IP/Mask	<p>Enter the destination IP address with a mask. A value of 1 in the mask indicates that the corresponding bit in the address will be matched.</p>
IP Protocol	<p>Select a protocol type from the drop-down list. The default is No Limit, which indicates that packets of all protocols will be matched. You can also select User-defined to customize the IP protocol.</p>
TCP Flag	<p>If TCP protocol is selected, you can configure the TCP Flag to be used for the rule's matching operations. There are six flags and each has three options, which are *, 0 and 1. The default is *, which indicates that the flag is not used for matching operations.</p> <p>URG: Urgent flag.</p> <p>ACK: Acknowledge flag.</p> <p>PSH: Push flag.</p> <p>RST: Reset flag.</p> <p>SYN: Synchronize flag.</p> <p>FIN: Finish flag.</p>
S-Port / D-Port	<p>If TCP/UDP is selected as the IP protocol, specify the source and destination port number with a mask.</p> <p>Value: Specify the port number.</p> <p>Mask: Specify the port mask with 4 hexadecimal numbers.</p>

DSCP	Specify a DSCP value to be matched between 0 and 63. The default is No Limit.
IP ToS	Specify an IP ToS value to be matched between 0 and 15. The default is No Limit.
IP Pre	Specify an IP Precedence value to be matched to be matched between 0 and 7. The default is No Limit.
Time Range	Select a time range during which the rule will take effect. The default value is No Limit, which means the rule is always in effect. The Time Range referenced here can be created on the SYSTEM > Time Range page.
Logging	Enable Logging function for the ACL rule. Then the times that the rule is matched will be logged every 5 minutes and a related trap will be generated. You can refer to Total Matched Counter in the ACL Rules Table to view the matching times.

- In the **Policy** section, enable or disable the Mirroring feature for the matched packets. With this option enabled, choose a destination port to which the packets will be mirrored.

Figure 2-11 Configuring Mirroring

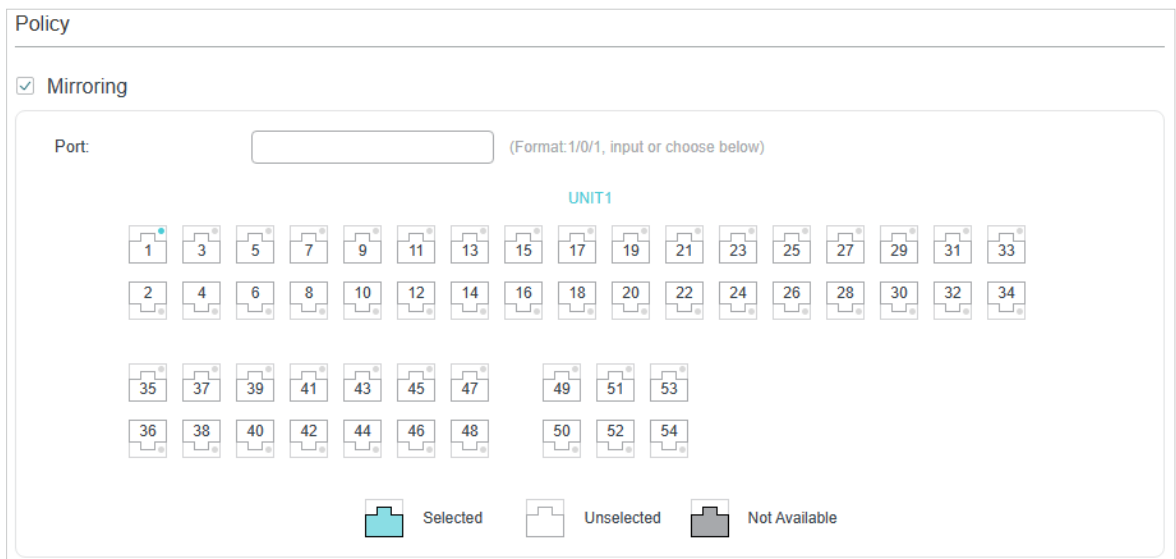

- In the **Policy** section, enable or disable the Redirect feature for the matched packets. With this option enabled, choose a destination port to which the packets will be redirected.

Figure 2-12 Configuring Redirect

Redirect

Destination Port: (Format: 1/0/1, input or choose below)

UNIT1

<input checked="" type="checkbox"/> 1	<input type="checkbox"/> 3	<input type="checkbox"/> 5	<input type="checkbox"/> 7	<input type="checkbox"/> 9	<input type="checkbox"/> 11	<input type="checkbox"/> 13	<input type="checkbox"/> 15	<input type="checkbox"/> 17	<input type="checkbox"/> 19	<input type="checkbox"/> 21	<input type="checkbox"/> 23	<input type="checkbox"/> 25	<input type="checkbox"/> 27	<input type="checkbox"/> 29	<input type="checkbox"/> 31	<input type="checkbox"/> 33
<input type="checkbox"/> 2	<input type="checkbox"/> 4	<input type="checkbox"/> 6	<input type="checkbox"/> 8	<input type="checkbox"/> 10	<input type="checkbox"/> 12	<input type="checkbox"/> 14	<input type="checkbox"/> 16	<input type="checkbox"/> 18	<input type="checkbox"/> 20	<input type="checkbox"/> 22	<input type="checkbox"/> 24	<input type="checkbox"/> 26	<input type="checkbox"/> 28	<input type="checkbox"/> 30	<input type="checkbox"/> 32	<input type="checkbox"/> 34
<input type="checkbox"/> 35	<input type="checkbox"/> 37	<input type="checkbox"/> 39	<input type="checkbox"/> 41	<input type="checkbox"/> 43	<input type="checkbox"/> 45	<input type="checkbox"/> 47	<input type="checkbox"/> 49	<input type="checkbox"/> 51	<input type="checkbox"/> 53							
<input type="checkbox"/> 36	<input type="checkbox"/> 38	<input type="checkbox"/> 40	<input type="checkbox"/> 42	<input type="checkbox"/> 44	<input type="checkbox"/> 46	<input type="checkbox"/> 48	<input type="checkbox"/> 50	<input type="checkbox"/> 52	<input type="checkbox"/> 54							

Selected

Unselected

Not Available

Note:

In the Mirroring feature, the matched packets will be copied to the destination port and the original forwarding will not be affected. While in the Redirect feature, the matched packets will be forwarded only on the destination port.

- 4) In the **Policy** section, enable or disable the Rate Limit feature for the matched packets. With this option enabled, configure the related parameters.

Figure 2-13 Configuring Rate Limit

Rate Limit

Rate: Kbps (1-10000000)

Burst Size: KB (1-128)

Out of Band:

Rate	Specify the transmission rate for the matched packets.
Burst Size	Specify the maximum number of bytes allowed in one second.
Out of Band	<p>Select the action for the packets whose rate is beyond the specified rate.</p> <p>None: The packets will be forwarded normally.</p> <p>Drop: The packets will be discarded.</p> <p>Remark DSCP: You can specify a DSCP value, and the DSCP field of the packets will be changed to the specified one.</p> <p>Note: Remark DSCP is only available on certain devices.</p>

- 5) In the **Policy** section, enable or disable the QoS Remark feature for the matched packets. With this option enabled, configure the related parameters, and the remarked values will take effect in the QoS processing on the switch.

Figure 2-14 Configuring QoS Remark

QoS Remark

DSCP: Default ▼

Local Priority: Default ▼

802.1p Priority: Default ▼

DSCP Specify the DSCP field for the matched packets. The DSCP field of the packets will be changed to the specified one.

Local Priority Specify the local priority for the matched packets. The local priority of the packets will be changed to the specified one.

802.1p Priority Specify the 802.1p priority for the matched packets. The 802.1p priority of the packets will be changed to the specified one.

6) Click **Apply**.

Configuring Combined ACL Rule

Click **Edit ACL** for a Combined ACL entry to load the following page.

Figure 2-15 Configuring the Combined ACL Rule

ACL Details

ACL Type: Combined ACL
 ACL ID: 1000
 ACL Name: ACL_1000

ACL Rules Table

Resequence
 Add Delete Refresh

<input type="checkbox"/>	ID	Rule ID	S-MAC	D-MAC	S-IP	D-IP	VID	Action	Total Matched Counter	Operation
No entries in this table.										
Total: 0										

In **ACL Rules Table** section, click Add and the following page will appear.

Figure 2-16 Configuring the Combined ACL Rule

Combined ACL Rule

ACL ID: 1000
 ACL Name: ACL_1000

Rule ID: Auto Assign

Operation: Permit ▼

S-MAC: (Format: FF-FF-FF-FF-FF-FF)
 Mask: (Format: FF-FF-FF-FF-FF-FF)

D-MAC: (Format: FF-FF-FF-FF-FF-FF)
 Mask: (Format: FF-FF-FF-FF-FF-FF)

VLAN ID: (1-4094)

EtherType: (4-hex number)

S-IP: (Format: 192.168.0.1)
 Mask: (Format: 255.255.255.0)

D-IP: (Format: 192.168.0.1)
 Mask: (Format: 255.255.255.0)

IP Protocol: No Limit ▼

DSCP: No Limit ▼

IP ToS: (Optional, 0-15)

IP Pre: (Optional, 0-7)

User Priority: Default ▼

Time Range: (Optional)

Logging: Disable ▼

Policy

Mirroring

Redirect

Rate Limit

QoS Remark

Discard
Apply

Follow these steps to configure the Combined ACL rule:

1) In the **Combined ACL Rule** section, configure the following parameters:

Rule ID

Enter an ID number to identify the rule.

It should not be the same as any current rule ID in the same ACL. For the convenience of inserting new rules to an ACL, you should set the appropriate interval between rule IDs.

If you select **Auto Assign**, the rule ID will be assigned automatically by the system and the default increment between neighboring rule IDs is 5

Operation	<p>Select an action to be taken when a packet matches the rule.</p> <p>Permit: To forward the matched packets.</p> <p>Deny: To discard the matched packets.</p>
S-MAC/Mask	Enter the source MAC address with a mask. A value of 1 in the mask indicates that the corresponding bit in the address will be matched.
D-MAC/Mask	Enter the destination IP address with a mask. A value of 1 in the mask indicates that the corresponding bit in the address will be matched.
VLAN ID	Enter the ID number of the VLAN with which packets will match. The valid range is 1-4094. If the ACL is bound to a VLAN, the system requires the VLAN ID of a packet to match the ID of the VLAN instead of the ID listed here.
EtherType	Specify the EtherType to be matched using 4 hexadecimal numbers.
S-IP/Mask	Enter the source IP address with a mask. A value of 1 in the mask indicates that the corresponding bit in the address will be matched.
D-IP/Mask	Enter the destination IP address with a mask. A value of 1 in the mask indicates that the corresponding bit in the address will be matched.
IP Protocol	Select a protocol type from the drop-down list. The default is No Limit, which indicates that packets of all protocols will be matched. You can also select User-defined to customize the IP protocol.
TCP Flag	<p>If TCP protocol is selected, you can configure the TCP Flag to be used for the rule's matching operations. There are six flags and each has three options, which are *, 0 and 1. The default is *, which indicates that the flag is not used for matching operations.</p> <p>URG: Urgent flag.</p> <p>ACK: Acknowledge flag.</p> <p>PSH: Push flag.</p> <p>RST: Reset flag.</p> <p>SYN: Synchronize flag.</p> <p>FIN: Finish flag.</p>
S-Port / D-Port	<p>If TCP/UDP is selected as the IP protocol, specify the source and destination port number with a mask.</p> <p>Value: Specify the port number.</p> <p>Mask: Specify the port mask with 4 hexadecimal numbers.</p>
DSCP	Specify a DSCP value to be matched between 0 and 63. The default is No Limit.
IP ToS	Specify an IP ToS value to be matched between 0 and 15. The default is No Limit.

IP Pre	Specify an IP Precedence value to be matched to be matched between 0 and 7. The default is No Limit.
User Priority	Specify the User Priority to be matched.
Time Range	Select a time range during which the rule will take effect. The default value is No Limit, which means the rule is always in effect. The Time Range referenced here can be created on the SYSTEM > Time Range page.
Logging	Enable Logging function for the ACL rule. Then the times that the rule is matched will be logged every 5 minutes and a related trap will be generated. You can refer to Total Matched Counter in the ACL Rules Table to view the matching times.

- In the **Policy** section, enable or disable the Mirroring feature for the matched packets. With this option enabled, choose a destination port to which the packets will be mirrored.

Figure 2-17 Configuring Mirroring

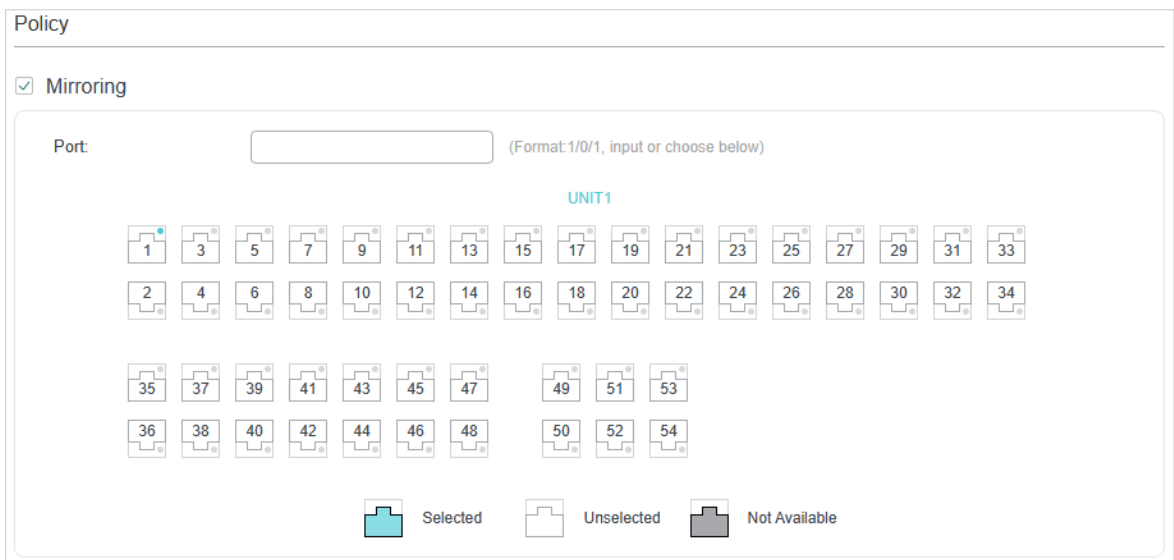

- In the **Policy** section, enable or disable the Redirect feature for the matched packets. With this option enabled, choose a destination port to which the packets will be redirected.

Figure 2-18 Configuring Redirect

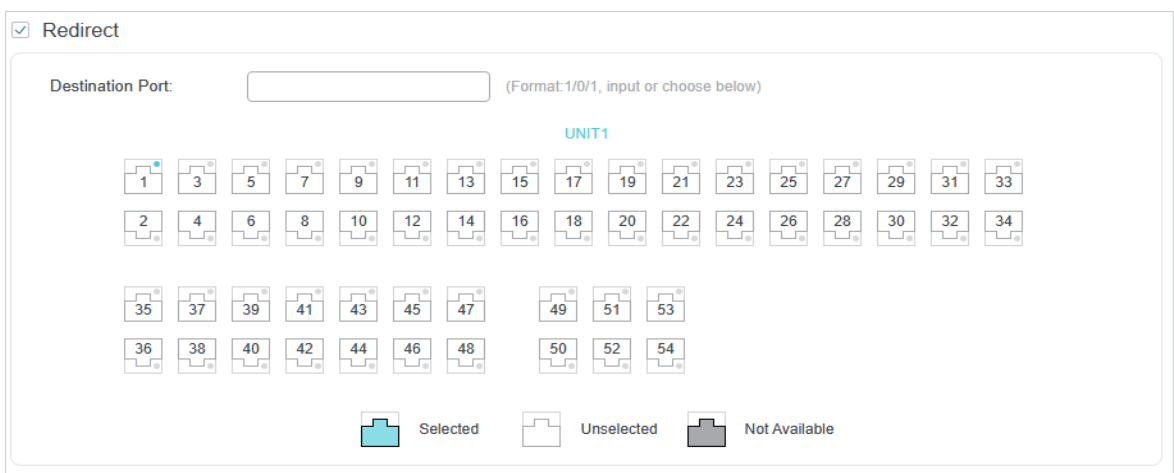

 **Note:**

In the Mirroring feature, the matched packets will be copied to the destination port and the original forwarding will not be affected. While in the Redirect feature, the matched packets will be forwarded only on the destination port.

- 4) In the **Policy** section, enable or disable the Rate Limit feature for the matched packets. With this option enabled, configure the related parameters.

Figure 2-19 Configuring Rate Limit

Rate Limit

Rate: Kbps (1-10000000)

Burst Size: KB (1-128)

Out of Band:

Rate	Specify the transmission rate for the matched packets.
Burst Size	Specify the maximum number of bytes allowed in one second.
Out of Band	<p>Select the action for the packets whose rate is beyond the specified rate.</p> <p>None: The packets will be forwarded normally.</p> <p>Drop: The packets will be discarded.</p> <p>Remark DSCP: You can specify a DSCP value, and the DSCP field of the packets will be changed to the specified one.</p> <p>Note: Remark DSCP is only available on certain devices.</p>

- 5) In the **Policy** section, enable or disable the QoS Remark feature for the matched packets. With this option enabled, configure the related parameters, and the remarked values will take effect in the QoS processing on the switch.

Figure 2-20 Configuring QoS Remark

QoS Remark

DSCP:

Local Priority:

802.1p Priority:

DSCP	Specify the DSCP field for the matched packets. The DSCP field of the packets will be changed to the specified one.
Local Priority	Specify the local priority for the matched packets. The local priority of the packets will be changed to the specified one.
802.1p Priority	Specify the 802.1p priority for the matched packets. The 802.1p priority of the packets will be changed to the specified one.

- 6) Click **Apply**.

Configuring the IPv6 ACL Rule



Click **Edit ACL** for an IPv6 ACL entry to load the following page.

Figure 2-21 Configuring the IPv6 ACL Rule

ACL Details

ACL Type: IPv6 ACL
 ACL ID: 1500
 ACL Name: ACL_1500

ACL Rules Table

 Resequence  Add  Delete  Refresh

<input type="checkbox"/>	ID	Rule ID	IPv6 Source IP	IPv6 Destination IP	Action	Total Matched Counter	Operation
No entries in this table.							
Total: 0							

In **ACL Rules Table** section, click  **Add** and the following page will appear.

Figure 2-22 Configuring the IPv6 ACL Rule

IPv6 ACL Rule

ACL ID: 1500
 ACL Name: ACL_1500

Rule ID: Auto Assign

Operation:

IPv6 Class: (0-63)

Flow Label: (5-hex number: 0x00000-0xFFFFF)

IPv6 Source IP: (Format: 2001::)
 Mask: (Format: FFFF:FFFF:FFFF:FFFF)

IPv6 Destination IP: (Format: 2001::)
 Mask: (Format: FFFF:FFFF:FFFF:FFFF)

IP Protocol:

Time Range: (Optional)

Policy

Mirroring

Redirect

Rate Limit

QoS Remark

Follow these steps to configure the IPv6 ACL rule:

1) In the **IPv6 ACL Rule** section, configure the following parameters:

Rule ID	<p>Enter an ID number to identify the rule.</p> <p>It should not be the same as any current rule ID in the same ACL. For the convenience of inserting new rules to an ACL, you should set the appropriate interval between rule IDs.</p> <p>If you select Auto Assign, the rule ID will be assigned automatically by the system and the default increment between neighboring rule IDs is 5</p>
Operation	<p>Select an action to be taken when a packet matches the rule.</p> <p>Permit: To forward the matched packets.</p> <p>Deny: To discard the matched packets.</p>
IPv6 Class	<p>Specify an IPv6 class value to be matched. The switch will check the class field of the IPv6 header.</p>
Flow Label	<p>Specify a Flow Label value to be matched.</p>
IPv6 Source IP	<p>Enter the source IPv6 address to be matched. All types of IPv6 address will be checked. You may enter a complete 128-bit IPv6 address but only the first 64 bits will be valid.</p>
Mask	<p>The mask is required if the source IPv6 address is entered. Enter the mask in complete format (for example, FFFF:FFFF:0000:FFFF).</p> <p>The IP address mask specifies which bits in the source IPv6 address to match the rule. A value of 1 in the mask indicates that the corresponding bit in the address will be matched.</p>
IPv6 Destination IP	<p>Enter the destination IPv6 address to be matched. All types of IPv6 address will be checked. You may enter a complete 128-bit IPv6 address but only the first 64 bits will be valid.</p>
Mask	<p>The mask is required if the destination IPv6 address is entered. Enter the complete mask (for example, FFFF:FFFF:0000:FFFF).</p> <p>The IP address mask specifies which bits in the source IP address to match the rule. A value of 1 in the mask indicates that the corresponding bit in the address will be matched.</p>
IP Protocol	<p>Select a protocol type from the drop-down list.</p> <p>No Limit: Packets of all protocols will be matched.</p> <p>UDP: Specify the source port and destination port for the UDP packet to be matched.</p> <p>TCP: Specify the source port and destination port for the TCP packet to be matched.</p> <p>User-defined: You can customize an IP protocol.</p>

S-Port / D-Port	If TCP/UDP is selected as the IP protocol, specify the source and destination port numbers.
Time Range	Select a time range during which the rule will take effect. The default value is No Limit, which means the rule is always in effect. The Time Range referenced here can be created on the SYSTEM > Time Range page.

- In the **Policy** section, enable or disable the Mirroring feature for the matched packets. With this option enabled, choose a destination port to which the packets will be mirrored.

Figure 2-23 Configuring Mirroring

Policy

Mirroring

Port: (Format: 1/0/1, input or choose below)

UNIT1

<input checked="" type="checkbox"/> 1	<input type="checkbox"/> 3	<input type="checkbox"/> 5	<input type="checkbox"/> 7	<input type="checkbox"/> 9	<input type="checkbox"/> 11	<input type="checkbox"/> 13	<input type="checkbox"/> 15	<input type="checkbox"/> 17	<input type="checkbox"/> 19	<input type="checkbox"/> 21	<input type="checkbox"/> 23	<input type="checkbox"/> 25	<input type="checkbox"/> 27	<input type="checkbox"/> 29	<input type="checkbox"/> 31	<input type="checkbox"/> 33
<input type="checkbox"/> 2	<input type="checkbox"/> 4	<input type="checkbox"/> 6	<input type="checkbox"/> 8	<input type="checkbox"/> 10	<input type="checkbox"/> 12	<input type="checkbox"/> 14	<input type="checkbox"/> 16	<input type="checkbox"/> 18	<input type="checkbox"/> 20	<input type="checkbox"/> 22	<input type="checkbox"/> 24	<input type="checkbox"/> 26	<input type="checkbox"/> 28	<input type="checkbox"/> 30	<input type="checkbox"/> 32	<input type="checkbox"/> 34
<input type="checkbox"/> 35	<input type="checkbox"/> 37	<input type="checkbox"/> 39	<input type="checkbox"/> 41	<input type="checkbox"/> 43	<input type="checkbox"/> 45	<input type="checkbox"/> 47	<input type="checkbox"/> 49	<input type="checkbox"/> 51	<input type="checkbox"/> 53							
<input type="checkbox"/> 36	<input type="checkbox"/> 38	<input type="checkbox"/> 40	<input type="checkbox"/> 42	<input type="checkbox"/> 44	<input type="checkbox"/> 46	<input type="checkbox"/> 48	<input type="checkbox"/> 50	<input type="checkbox"/> 52	<input type="checkbox"/> 54							

Selected
 Unselected
 Not Available

- In the **Policy** section, enable or disable the Redirect feature for the matched packets. With this option enabled, choose a destination port to which the packets will be redirected.

Figure 2-24 Configuring Redirect

Redirect

Destination Port: (Format: 1/0/1, input or choose below)

UNIT1

<input checked="" type="checkbox"/> 1	<input type="checkbox"/> 3	<input type="checkbox"/> 5	<input type="checkbox"/> 7	<input type="checkbox"/> 9	<input type="checkbox"/> 11	<input type="checkbox"/> 13	<input type="checkbox"/> 15	<input type="checkbox"/> 17	<input type="checkbox"/> 19	<input type="checkbox"/> 21	<input type="checkbox"/> 23	<input type="checkbox"/> 25	<input type="checkbox"/> 27	<input type="checkbox"/> 29	<input type="checkbox"/> 31	<input type="checkbox"/> 33
<input type="checkbox"/> 2	<input type="checkbox"/> 4	<input type="checkbox"/> 6	<input type="checkbox"/> 8	<input type="checkbox"/> 10	<input type="checkbox"/> 12	<input type="checkbox"/> 14	<input type="checkbox"/> 16	<input type="checkbox"/> 18	<input type="checkbox"/> 20	<input type="checkbox"/> 22	<input type="checkbox"/> 24	<input type="checkbox"/> 26	<input type="checkbox"/> 28	<input type="checkbox"/> 30	<input type="checkbox"/> 32	<input type="checkbox"/> 34
<input type="checkbox"/> 35	<input type="checkbox"/> 37	<input type="checkbox"/> 39	<input type="checkbox"/> 41	<input type="checkbox"/> 43	<input type="checkbox"/> 45	<input type="checkbox"/> 47	<input type="checkbox"/> 49	<input type="checkbox"/> 51	<input type="checkbox"/> 53							
<input type="checkbox"/> 36	<input type="checkbox"/> 38	<input type="checkbox"/> 40	<input type="checkbox"/> 42	<input type="checkbox"/> 44	<input type="checkbox"/> 46	<input type="checkbox"/> 48	<input type="checkbox"/> 50	<input type="checkbox"/> 52	<input type="checkbox"/> 54							

Selected
 Unselected
 Not Available

 **Note:**

In the Mirroring feature, the matched packets will be copied to the destination port and the original forwarding will not be affected. While in the Redirect feature, the matched packets will be forwarded only on the destination port.

- 4) In the **Policy** section, enable or disable the Rate Limit feature for the matched packets. With this option enabled, configure the related parameters.

Figure 2-25 Configuring Rate Limit

Rate Limit

Rate: Kbps (1-10000000)

Burst Size: KB (1-128)

Out of Band:

Rate	Specify the transmission rate for the matched packets.
Burst Size	Specify the maximum number of bytes allowed in one second.
Out of Band	<p>Specify the action to be taken for the packets whose rate is beyond the specified rate.</p> <p>None: The packets will be forwarded normally.</p> <p>Drop: The packets will be discarded.</p> <p>Remark DSCP: You can specify a DSCP value, and the DSCP field of the packets will be changed to the specified one.</p> <p>Note: Remark DSCP is only available on certain devices.</p>

- 5) In the **Policy** section, enable or disable the QoS Remark feature for the matched packets. With this option enabled, configure the related parameters, and the remarked values will take effect in the QoS processing on the switch.

Figure 2-26 Configuring QoS Remark

QoS Remark

DSCP:

Local Priority:

802.1p Priority:

DSCP	Specify the DSCP region for the matched packets. The DSCP field of the matched packets will be changed to the specified value.
Local Priority	Specify the local priority for the matched packets. The TC queue of the matched packets will be changed to the specified value.
802.1p Priority	Specify the 802.1p priority for the matched packets. The 802.1p priority field of the matched packets will be changed to the specified value.

6) Click **Apply**.

Configuring the Packet Content ACL Rule

 **Note:**

Packet Content ACL is only available on certain devices.

Click **Edit ACL** for a Packet Content ACL entry to load the following page.

Figure 2-27 Configuring the Packet Content ACL Rule

Packet Content Offset Profile Global Config

Chunk0 Offset: (0-31)

Chunk1 Offset: (0-31)

Chunk2 Offset: (0-31)

Chunk3 Offset: (0-31)

[Apply](#)

ACL Details

ACL Type: Packet Content ACL

ACL ID: 2000

ACL Name: ACL_2000

ACL Rules Table

 Resequencing
[+](#) Add
[-](#) Delete
[↻](#) Refresh

<input type="checkbox"/>	ID	Rule ID	Enabled Chunk	Action	Total Matched Counter	Operation
No entries in this table.						
Total: 0						

In the **Packet Content Offset Profile Global Config** section, configure the Chunk Offset. Click **Apply**.

[Chunk0 Offset/](#)
[Chunk1 Offset/](#)
[Chunk2 Offset/](#)
[Chunk3 Offset](#)

Enter the offset of a chunk. Packet Content ACL analyzes and processes data packets based on 4 chunk match conditions, and each chunk can specify a user-defined 4-byte segment carried in the packet's first 128 bytes. Offset 31 matches the 127, 128, 1, 2 bytes of the packet, offset 0 matches the 3,4,5,6 bytes of the packet, and so on, for the rest of the offset value.

Note: All 4 chunks must be set at the same time.

In **ACL Rules Table** section, click  **Add** and the following page will appear.

Figure 2-28 Configuring the Packet Content ACL Rule

Packet Content Rule

ACL ID: 2000
 ACL Name: ACL_2000
 Rule ID: Auto Assign
 Operation: Deny ▼

Chunk0
 Chunk Value: (8-hex number)
 Chunk Mask: (8-hex number, like '0000ffff')

Chunk1
 Chunk Value: (8-hex number)
 Chunk Mask: (8-hex number, like '0000ffff')

Chunk2
 Chunk Value: (8-hex number)
 Chunk Mask: (8-hex number, like '0000ffff')

Chunk3
 Chunk Value: (8-hex number)
 Chunk Mask: (8-hex number, like '0000ffff')

Time Range: ▼ (Optional)

Policy

Mirroring
 Redirect
 Rate Limit
 QoS Remark

Discard
Apply

Follow these steps to configure the Packet Content ACL rule:

- 1) In the **Packet Content Rule** section, configure the following parameters:

Rule ID	<p>Enter an ID number to identify the rule.</p> <p>It should not be the same as any current rule ID in the same ACL. If you select Auto Assign, the rule ID will be assigned automatically and the interval between rule IDs is 5.</p>
Operation	<p>Select an action to be taken when a packet matches the rule.</p> <p>Permit: To forward the matched packets.</p> <p>Deny: To discard the matched packets.</p>
Chunk0-Chunk3	<p>Specify the EtherType to be matched using 4 hexadecimal numbers.</p>
Chunk Value	<p>Enter the 4-byte value in hexadecimal for the desired chunk, like '0000ffff'. The Packet Content ACL will check this chunk of packets to examine if the packets match the rule or not.</p>
Chunk Mask	<p>Enter the 4-byte mask in hexadecimal for the desired chunk. The mask must be written completely in 4-byte hex mode, like '0000ffff'. The mask specifies which bits to match the rule.</p>
Time Range	<p>Select a time range during which the rule will take effect. The default value is No Limit, which means the rule is always in effect. The Time Range referenced here can be created on the SYSTEM > Time Range page.</p>
Logging	<p>Enable Logging function for the ACL rule. Then the times that the rule is matched will be logged every 5 minutes and a related trap will be generated. You can refer to Total Matched Counter in the ACL Rules Table to view the matching times.</p>

- 2) In the **Policy** section, enable or disable the Mirroring feature for the matched packets. With this option enabled, choose a destination port to which the packets will be mirrored.

Figure 2-29 Configuring Mirroring

Mirroring

Port: (Format: 1/0/1, input or choose below)

UNIT1

<input type="checkbox"/>	<input type="checkbox"/>	<input type="checkbox"/>	<input type="checkbox"/>	<input type="checkbox"/>	<input type="checkbox"/>	<input type="checkbox"/>	<input type="checkbox"/>	<input type="checkbox"/>	<input type="checkbox"/>	<input type="checkbox"/>	<input type="checkbox"/>	<input type="checkbox"/>	<input type="checkbox"/>	<input type="checkbox"/>	<input type="checkbox"/>	<input type="checkbox"/>	<input type="checkbox"/>
<input type="checkbox"/>	<input type="checkbox"/>	<input type="checkbox"/>	<input type="checkbox"/>	<input type="checkbox"/>	<input type="checkbox"/>	<input type="checkbox"/>	<input type="checkbox"/>	<input type="checkbox"/>	<input type="checkbox"/>	<input type="checkbox"/>	<input type="checkbox"/>	<input type="checkbox"/>	<input type="checkbox"/>	<input type="checkbox"/>	<input type="checkbox"/>	<input type="checkbox"/>	<input type="checkbox"/>
<input type="checkbox"/>	<input type="checkbox"/>	<input type="checkbox"/>	<input type="checkbox"/>	<input type="checkbox"/>	<input type="checkbox"/>	<input type="checkbox"/>	<input type="checkbox"/>	<input type="checkbox"/>	<input type="checkbox"/>	<input type="checkbox"/>	<input type="checkbox"/>	<input type="checkbox"/>	<input type="checkbox"/>	<input type="checkbox"/>	<input type="checkbox"/>	<input type="checkbox"/>	<input type="checkbox"/>
<input type="checkbox"/>	<input type="checkbox"/>	<input type="checkbox"/>	<input type="checkbox"/>	<input type="checkbox"/>	<input type="checkbox"/>	<input type="checkbox"/>	<input type="checkbox"/>	<input type="checkbox"/>	<input type="checkbox"/>	<input type="checkbox"/>	<input type="checkbox"/>	<input type="checkbox"/>	<input type="checkbox"/>	<input type="checkbox"/>	<input type="checkbox"/>	<input type="checkbox"/>	<input type="checkbox"/>

Selected

Unselected

Not Available

- 3) In the **Policy** section, enable or disable the Redirect feature for the matched packets. With this option enabled, choose a destination port to which the packets will be redirected.

Figure 2-30 Configuring Redirect

Note:

In the Mirroring feature, the matched packets will be copied to the destination port and the original forwarding will not be affected. While in the Redirect feature, the matched packets will be forwarded only on the destination port.

- 4) In the **Policy** section, enable or disable the Rate Limit feature for the matched packets. With this option enabled, configure the related parameters.

Figure 2-31 Configuring Rate Limit

Rate	Specify the transmission rate for the matched packets.
Burst Size	Specify the maximum number of bytes allowed in one second.
Out of Band	<p>Specify the action to be taken for the packets whose rate is beyond the specified rate.</p> <p>None: The packets will be forwarded normally.</p> <p>Drop: The packets will be discarded.</p> <p>Remark DSCP: You can specify a DSCP value, and the DSCP field of the packets will be changed to the specified one.</p> <p>Note: Remark DSCP is only available on certain devices.</p>

- In the **Policy** section, enable or disable the QoS Remark feature for the matched packets. With this option enabled, configure the related parameters, and the remarked values will take effect in the QoS processing on the switch.

Figure 2-32 Configuring QoS Remark

QoS Remark

DSCP: Default

Local Priority: Default

802.1p Priority: Default

DSCP	Specify the DSCP region for the matched packets. The DSCP field of the matched packets will be changed to the specified value.
Local Priority	Specify the local priority for the matched packets. The TC queue of the matched packets will be changed to the specified value.
802.1p Priority	Specify the 802.1p priority for the matched packets. The 802.1p priority field of the matched packets will be changed to the specified value.

- Click **Apply**.

Viewing the ACL Rules

The rules in an ACL are listed in ascending order of their rule IDs. The switch matches a received packet with the rules in order. When a packet matches a rule, the switch stops the match process and performs the action defined in the rule.

Click **Edit ACL** for an entry you have created and you can view the rule table. We take IP ACL rules table for example.

Figure 2-33 Viewing ACL Rules Table

ACL Rules Table

Resequence

 Add
 Delete
 Refresh

	ID	Rule ID	S-IP	D-IP	IP Protocol	Action	Total Matched Counter	Operation	
<input type="checkbox"/>	1	1	192.168.1.0	192.168.5.0		Permit	0		
<input type="checkbox"/>	2	3	192.168.7.0			Permit	0		
<input type="checkbox"/>	3	5	192.168.0.0			Deny	0		
Total: 3									

Here you can view and edit the ACL rules. You can also click **Resequence** to resequence the rules by providing a Start Rule ID and Step value.

2.1.4 Configuring ACL Binding

You can bind the ACL to a port or a VLAN. The received packets on the port or in the VLAN will then be matched and processed according to the ACL rules. An ACL takes effect only after it is bound to a port or VLAN.

Note:

- Different types of ACLs cannot be bound to the same port or VLAN.
- Multiple ACLs of the same type can be bound to the same port or VLAN. The switch matches the received packets using the ACLs in order. The ACL that is bound earlier has a higher priority.

Binding the ACL to a Port

Choose the menu **SECURITY > ACL > ACL Binding > Port Binding** and click **+ Add** to load the following page.

Figure 2-34 Binding the ACL to a Port

Follow these steps to bind the ACL to a Port:

- 1) Choose ID or Name to be used for matching the ACL. Then select an ACL from the drop-down list.
- 2) Specify the port to be bound.
- 3) Click **Create**.

■ Binding the ACL to a VLAN

Choose the menu **SECURITY > ACL > ACL Binding > VLAN Binding** and click **Add** to load the following page.

Figure 2-35 Binding the ACL to a VLAN

Follow these steps to bind the ACL to a VLAN:

- 1) Choose ID or Name to be used for matching the ACL. Then select an ACL from the drop-down list.
- 2) Enter the ID of the VLAN to be bound.
- 3) Click **Create**.

2.2 Using the CLI

2.2.1 Configuring Time Range

Some ACL-based services or features may need to be limited to take effect only during a specified time period. In this case, you can configure a time range for the ACL. For details about Time Range Configuration, please refer to [Managing System](#).

2.2.2 Configuring ACL

Follow the steps to create different types of ACL and configure the ACL rules.

You can define the rules based on source or destination IP address, source or destination MAC address, protocol type, port number and others.

MAC ACL

Follow these steps to configure MAC ACL:

Step 1 **configure**

Enter global configuration mode.

Step 2 **access-list create** *acl-id* [**name** *acl-name*]

Create a MAC ACL.

acl-id: Enter an ACL ID. The ID ranges from 0 to 499.

acl-name: Enter a name to identify the ACL.

-
- Step 3 **access-list mac** *acl-id-or-name* **rule** { auto | *rule-id* } { deny | permit } **logging** {enable | disable} [**smac** *source-mac* **smask** *source-mac-mask*] [**dmac** *destination-mac* **dmask** *destination-mac-mask*] [**type** *ether-type*] [**pri** *dot1p-priority*] [**vid** *vlan-id*] [**tseg** *time-range-name*]
- Add a MAC ACL Rule.
- acl-id-or-name*: Enter the ID or name of the ACL that you want to add a rule for.
- auto*: The rule ID will be assigned automatically and the interval between rule IDs is 5.
- rule-id*: Assign an ID to the rule.
- deny | permit**: Specify the action to be taken with the packets that match the rule. By default, it is set to permit. The packets will be discarded if "deny" is selected and forwarded if "permit" is selected.
- logging {enable | disable}**: Enable or disable Logging function for the ACL rule. If "enable" is selected, the times that the rule is matched will be logged every 5 minutes. With ACL Counter trap enabled, a related trap will be generated if the matching times changes.
- source-mac*: Enter the source MAC address. The format is FF:FF:FF:FF:FF:FF.
- source-mac-mask*: Enter the mask of the source MAC address. This is required if a source MAC address is entered. The format is FF:FF:FF:FF:FF:FF.
- destination-mac*: Enter the destination MAC address. The format is FF:FF:FF:FF:FF:FF.
- destination-mac-mask*: Enter the mask of the destination MAC address. This is required if a destination MAC address is entered. The format is FF:FF:FF:FF:FF:FF.
- ether-type*: Specify an Ethernet-type with 4 hexadecimal numbers.
- dot1p-priority*: The user priority ranges from 0 to 7. The default is No Limit.
- vlan-id*: The VLAN ID ranges from 1 to 4094.
- time-range-name*: The name of the time-range. The default is No Limit.
-
- Step 4 **exit**
- Return to global configuration mode.
-
- Step 5 **show access-list** [*acl-id-or-name*]
- Display the current ACL configuration.
- acl-id-or-name*: The ID number or name of the ACL.
-
- Step 6 **end**
- Return to privileged EXEC mode.
-
- Step 7 **copy running-config startup-config**
- Save the settings in the configuration file.
-

The following example shows how to create MAC ACL 50 and configure Rule 5 to permit packets with source MAC address 00:34:A2:D4:34:B5:

Switch#configure

```
Switch(config)#access-list create 50
```

```
Switch(config-mac-acl)#access-list mac 50 rule 5 permit logging disable smac  
00:34:A2:D4:34:B5 smask FF:FF:FF:FF:FF:FF
```

```
Switch(config-mac-acl)#exit
```

```
Switch(config)#show access-list 50
```

```
MAC access list 50 name: ACL_50
```

```
rule 5 permit logging disable smac 00:34:a2:d4:34:b5 smask ff:ff:ff:ff:ff
```

```
Switch(config)#end
```

```
Switch#copy running-config startup-config
```

IP ACL

Follow these steps to configure IP ACL:

Step 1 **configure**

Enter global configuration mode.

Step 2 **access-list create *acl-id* [*name acl-name*]**

Create an IP ACL.

acl-id: Enter an ACL ID. The ID ranges from 500 to 999.

acl-name: Enter a name to identify the ACL.

Step 3 **access-list ip** *acl-id-or-name* **rule** {auto | *rule-id* } {deny | permit} **logging** {enable | disable} [**sip** *sip-address* **sip-mask** *sip-address-mask*] [**dip** *dip-address* **dip-mask** *dip-address-mask*] [**dscp** *dscp-value*] [**tos** *tos-value*] [**pre** *pre-value*] [**frag** {enable | disable}] [**protocol** *protocol*] [**s-port** *s-port-number* **s-port-mask** *s-port-mask*] [**d-port** *d-port-number* **d-port-mask** *d-port-mask*] [**tcpflag** *tcpflag*] [**tseg** *time-range-name*]

Add rules to the ACL.

acl-id-or-name: Enter the ID or name of the ACL that you want to add a rule for.

auto: The rule ID will be assigned automatically and the interval between rule IDs is 5.

rule-id: Assign an ID to the rule.

deny | **permit**: Specify the action to be taken with the packets that match the rule. Deny means to discard; permit means to forward. By default, it is set to permit.

logging {enable | disable}: Enable or disable Logging function for the ACL rule. If "enable" is selected, the times that the rule is matched will be logged every 5 minutes. With ACL Counter trap enabled, a related trap will be generated if the matching times changes.

sip-address: Enter the source IP address.

sip-address-mask: Enter the mask of the source IP address. This is required if a source IP address is entered.

dip-address: Enter the destination IP address.

dip-address-mask: Enter the mask of the destination IP address. This is required if a destination IP address is entered.

dscp-value: Specify the DSCP value between 0 and 63.

tos-value: Specify an IP ToS value to be matched between 0 and 15.

pre-value: Specify an IP Precedence value to be matched between 0 and 7.

frag {enable | disable}: Enable or disable matching of fragmented packets. The default is disable. When enabled, the rule will apply to all fragmented packets and always permit to forward the last fragment of a packet.

Note: **frag** {enable | disable} is only available on certain devices.

protocol: Specify a protocol number between 0 and 255.

s-port-number: With TCP or UDP configured as the protocol, specify the source port number.

s-port-mask: With TCP or UDP configured as the protocol, specify the source port mask with 4 hexadecimal numbers.

d-port-number: With TCP or UDP configured as the protocol, specify the destination port number.

d-port-mask: With TCP or UDP configured as the protocol, specify the destination port mask with 4 hexadecimal numbers.

tcpflag: With TCP configured as the protocol, specify the flag value using either binary numbers or * (for example, 01*010*). The default is *, which indicates that the flag will not be matched.

The flags are URG (Urgent flag), ACK (Acknowledge Flag), PSH (Push Flag), RST (Reset Flag), SYN (Synchronize Flag) and FIN (Finish Flag).

time-range-name: The name of the time-range. The default is No Limit.

Step 4 **end**
Return to privileged EXEC mode.

Step 5 **copy running-config startup-config**
Save the settings in the configuration file.

The following example shows how to create IP ACL 600, and configure Rule 1 to permit packets with source IP address 192.168.1.100:

Switch#configure

Switch(config)#access-list create 600

Switch(config)#access-list ip 600 rule 1 permit logging disable sip 192.168.1.100 sip-mask 255.255.255.255

Switch(config)#show access-list 600

IP access list 600 name: ACL_600

rule 1 permit logging disable sip 192.168.1.100 smask 255.255.255.255

Switch(config)#end

Switch#copy running-config startup-config

Combined ACL

Follow these steps to configure Combined ACL:

Step 1 **configure**
Enter global configuration mode

Step 2 **access-list create acl-id [name acl-name]**
Create a Combined ACL.

acl-id: Enter an ACL ID. The ID ranges from 1000 to 1499.

acl-name: Enter a name to identify the ACL.

Step 3 **access-list combined** *acl-id-or-name* **rule** {*auto* | *rule-id* } {*deny* | *permit*} **logging** {*enable* | *disable*} [**smac** *source-mac-address* **smask** *source-mac-mask*] [**dmac** *dest-mac-address* **dmask** *dest-mac-mask*] [**vid** *vlan-id*] [**type** *ether-type*] [**pri** *priority*] [**sip** *sip-address* **sip-mask** *sip-address-mask*] [**dip** *dip-address* **dip-mask** *dip-address-mask*] [**dscp** *dscp-value*] [**tos** *tos-value*] [**pre** *pre-value*] [**protocol** *protocol*] [**s-port** *s-port-number* **s-port-mask** *s-port-mask*] [**d-port** *d-port-number* **d-port-mask** *d-port-mask*] [**tcpflag** *tcpflag*] [**tseg** *time-range-name*]

Add rules to the ACL.

acl-id-or-name: Enter the ID or name of the ACL that you want to add a rule for.

auto: The rule ID will be assigned automatically and the interval between rule IDs is 5.

rule-id: Assign an ID to the rule.

deny | *permit*: Specify the action to be taken with the packets that match the rule. Deny means to discard; permit means to forward. By default, it is set to permit.

logging {*enable* | *disable*}: Enable or disable Logging function for the ACL rule. If "enable" is selected, the times that the rule is matched will be logged every 5 minutes. With ACL Counter trap enabled, a related trap will be generated if the matching times changes.

source-mac-address: Enter the source MAC address.

source-mac-mask: Enter the source MAC address mask.

dest-mac-address: Enter the destination MAC address.

dest-mac-mask: Enter the destination MAC address mask. This is required if a destination MAC address is entered.

vlan-id: The VLAN ID ranges from 1 to 4094.

ether-type: Specify the Ethernet-type with 4 hexadecimal numbers.

priority: The user priority ranges from 0 to 7. The default is No Limit.

sip-address: Enter the source IP address.

sip-address-mask: Enter the mask of the source IP address. It is required if source IP address is entered.

dip-address: This is required if a source IP address is entered.

dip-address-mask: Enter the destination IP address mask. This is required if a destination IP address is entered.

dscp-value: Specify the DSCP value between 0 and 63.

tos-value: Specify an IP ToS value to be matched between 0 and 15.

pre-value: Specify an IP Precedence value to be matched between 0 and 7.

protocol: Specify a protocol number between 0 and 255.

s-port-number: With TCP or UDP configured as the protocol, specify the source port number.

s-port-mask: With TCP or UDP configured as the protocol, specify the source port mask with 4 hexadecimal numbers.

d-port-number: With TCP or UDP configured as the protocol, specify the destination port number.

d-port-mask: With TCP or UDP configured as the protocol, specify the destination port mask with 4 hexadecimal numbers.

tcpflag: With TCP configured as the protocol, specify the flag value using either binary numbers or * (for example, 01*010*). The default is *, which indicates that the flag will not be matched.

The flags are URG (Urgent flag), ACK (Acknowledge Flag), PSH (Push Flag), RST (Reset Flag), SYN (Synchronize Flag), and FIN (Finish Flag).

time-range-name: The name of the time-range. The default is No Limit.

Step 4 **end**

Return to privileged EXEC mode.

Step 5 **copy running-config startup-config**

Save the settings in the configuration file.

The following example shows how to create Combined ACL 1100 and configure Rule 1 to deny packets with source IP address 192.168.3.100 in VLAN 2:

Switch#configure

Switch(config)#access-list create 1100

Switch(config)#access-list combined 1100 logging disable rule 1 permit vid 2 sip 192.168.3.100 sip-mask 255.255.255.255

Switch(config)#show access-list 2600

Combined access list 2600 name: ACL_2600

rule 1 permit logging disable vid 2 sip 192.168.3.100 sip-mask 255.255.255.255

Switch(config)#end

Switch#copy running-config startup-config

IPv6 ACL

Follow these steps to configure IPv6 ACL:

Step 1 **configure**

Enter global configuration mode

Step 2 **access-list create** *acl-id* [**name** *acl-name*]

Create an IPv6 ACL.

acl-id: Enter an ACL ID. The ID ranges from 1500 to 1999.

acl-name: Enter a name to identify the ACL.

Step 3 **access-list ipv6** *acl-id-or-name* **rule** {*auto* | *rule-id*} {*deny* | *permit*} **logging** {*enable* | *disable*} [**class** *class-value*] [**flow-label** *flow-label-value*] [**sip** *source-ip-address* **sip-mask** *source-ip-mask*] [**dip** *destination-ip-address* **dip-mask** *destination-ip-mask*] [**s-port** *source-port-number*] [**d-port** *destination-port-number*] [**tseg** *time-range-name*]

Add rules to the ACL.

acl-id-or-name: Enter the ID or name of the ACL that you want to add a rule for.

auto: The rule ID will be assigned automatically and the interval between rule IDs is 5.

rule-id: Assign an ID to the rule.

deny | *permit*: Specify the action to be taken with the packets that match the rule. Deny means to discard; permit means to forward. By default, it is set to permit.

logging {*enable* | *disable*}: Enable or disable Logging function for the ACL rule. If "enable" is selected, the times that the rule is matched will be logged every 5 minutes. With ACL Counter trap enabled, a related trap will be generated if the matching times changes.

class-value: Specify a class value to be matched. It ranges from 0 to 63.

flow-label-value: Specify a Flow Label value to be matched.

source-ip-address: Enter the source IP address. Enter the destination IPv6 address to be matched. All types of IPv6 address will be checked. You may enter a complete 128-bit IPv6 address but only the first 64 bits will be valid.

source-ip-mask: Enter the source IP address mask. The mask is required if the source IPv6 address is entered. Enter the mask in complete format (for example, ffff:ffff:0000:ffff). The mask specifies which bits in the source IPv6 address to match the rule.

destination-ip-address: Enter the destination IPv6 address to be matched. All types of IPv6 address will be checked. You may enter a complete 128-bit IPv6 addresses but only the first 64 bits will be valid.

destination-ip-mask: Enter the source IP address mask. The mask is required if the source IPv6 address is entered. Enter the mask in complete format (for example, ffff:ffff:0000:ffff). The mask specifies which bits in the source IPv6 address to match the rule.

source-port-number: Enter the TCP/UDP source port if TCP/UDP protocol is selected.

destination-port-number: Enter the TCP/UDP destination port if TCP/UDP protocol is selected.

time-range-name: The name of the time-range. The default is No Limit.

Step 4 **end**

Return to privileged EXEC mode.

Step 5 **copy running-config startup-config**

Save the settings in the configuration file.

The following example shows how to create IPv6 ACL 1600 and configure Rule 1 to deny packets with source IPv6 address CDCD:910A:2222:5498:8475:1111:3900:2020:

Switch#configure

```
Switch(config)#access-list create 1600
```

```
Switch(config)#access-list ipv6 1600 rule 1 deny logging disable sip
CDCD:910A:2222:5498:8475:1111:3900:2020 sip-mask ffff:ffff:ffff:ffff
```

```
Switch(config)#show access-list 1600
```

```
IPv6 access list 1600 name: ACL_1600
```

```
rule 1 deny logging disable sip cdc:910a:2222:5498:8475:1111:3900:2020 sip-mask ffff:ff
ff:ffff:ffff
```

```
Switch(config)#end
```

```
Switch#copy running-config startup-config
```

Packet Content ACL

Note:

Packet Content ACL is only available on certain devices.

Step 1	configure Enter global configuration mode
Step 2	access-list create <i>acl-id</i> [name <i>acl-name</i>] Create a Packet Content ACL. <i>acl-id</i> : Enter an ACL ID. The ID ranges from 2000 to 2499. <i>acl-name</i> : Enter a name to identify the ACL.
Step 3	access-list packet-content profile chunk-offset0 <i>offset0</i> chunk-offset1 <i>offset1</i> chunk-offset2 <i>offset2</i> chunk-offset3 <i>offset3</i> Specify the offset of each chunk, all the 4 chunks must be set at the same time. <i>offset0 -offset3</i> : Specify the offset of each chunk, the value ranges from 0 to 31. When the offset is set as 31, it matches the first 127,128, 1, 2 bytes of the packet; when the offset is set as 0, it matches the 3, 4, 5, 6 bytes, and so on, for the rest of the offset value.

Step 4 **access-list packet-content config** *acl-id-or-name* **rule** { *auto* | *rule-id* } {deny | permit} **logging** { *enable* | *disable* } [**chunk0** *value* **mask0** *mask*] [**chunk1** *value* **mask1** *mask*] [**chunk2** *value* **mask2** *mask*] [**chunk3** *value* **mask3** *mask*] [**tseg** *time-range-name*]

Add rules to the ACL.

acl-id-or-name: Enter the ID or name of the ACL that you want to add a rule for.

auto: The rule ID will be assigned automatically and the interval between rule IDs is 5.

rule-id: Assign an ID to the rule.

deny | *permit*: Specify the action to be taken with the packets that match the rule. Deny means to discard; permit means to forward. By default, it is set to permit.

logging { *enable* | *disable* } : Enable or disable Logging function for the ACL rule. If "enable" is selected, the times that the rule is matched will be logged every 5 minutes. With ACL Counter trap enabled, a related trap will be generated if the matching times changes.

value: Enter the 4-byte value in hexadecimal for the desired chunk, like '0000ffff'. The Packet Content ACL will check this chunk of packets to examine if the packets match the rule or not.

mask: Enter the 4-byte mask in hexadecimal for the desired chunk. The mask must be written completely in 4-byte hex mode, like '0000ffff'. The mask specifies which bits to match the rule.

time-range-name: The name of the time-range. The default is No Limit.

Step 5 **end**

Return to privileged EXEC mode.

Step 6 **copy running-config startup-config**

Save the settings in the configuration file.

The following example shows how to create Packet Content ACL 2000, and deny the packets with the value of its chunk1 0x58:

Switch#configure

Switch(config)#access-list create 2000

Switch(config)#access-list packet-content profile chunk-offset0 *offset0* **chunk-offset1** *offset1* **chunk-offset2** *offset2* **chunk-offset3** *offset3*

Switch(config)#packet-content config 2000 rule 10 deny logging *disable* **chunk1 58 mask1** *ffffff*

Switch(config)#show access-list 2000

Packet content access list 2000 name: ACL_2000

rule 10 deny logging *disable* chunk1 value 0x58 mask 0xffffffff

Switch(config)#end

Switch#copy running-config startup-config

Resequencing Rules

Note:

Resequencing Rules is only available on certain devices.

You can resequence the rules by providing a Start Rule ID and Step value.

Step 1	configure Enter global configuration mode.
Step 2	access-list resequence <i>acl-id-or-name</i> start <i>start-rule-id</i> step <i>rule-id-step-value</i> Resequencing the rules of the specific ACL. <i>acl-id-or-name</i> : Enter the ID or name of the ACL. <i>start-rule-id</i> : Enter the start rule ID. <i>rule-id-step-value</i> : Enter the Step value.
Step 3	end Return to privileged EXEC mode.
Step 4	copy running-config startup-config Save the settings in the configuration file.

The following example shows how to resequence the rules of MAC ACL 100: set the start rule ID as 1 and the step value as 10:

Switch#configure

Switch(config)#access-list resequence 100 start 1 step 10

Switch(config)#show access-list 100

MAC access list 100 name: "ACL_100"

rule 1 deny logging disable smac aa:bb:cc:dd:ee:ff smask ff:ff:ff:ff:ff:ff

rule 11 permit logging disable vid 18

rule 21 permit logging disable dmac aa:cc:ee:ff:dd:33 dmask ff:ff:ff:ff:ff:ff

Switch(config)#end

Switch#copy running-config startup-config

2.2.3 Configuring Policy

Policy allows you to further process the matched packets through operations such as mirroring, rate-limiting, redirecting, or changing priority.

Follow the steps below to configure the policy actions for an ACL rule.

Step 1	<p>configure</p> <p>Enter global configuration mode.</p>
Step 2	<p>access-list action <i>acl-id-or-name</i> rule <i>rule-id</i></p> <p>Configure the policy actions for an ACL rule.</p> <p><i>acl-id-or-name</i>: Enter the ID or name of the ACL.</p> <p><i>rule-id</i>: Enter the ID of the ACL rule.</p>
Step 3	<p>redirect interface { <i>fastEthernet port</i> <i>gigabitEthernet port</i> <i>ten-gigabitEthernet port</i> }</p> <p>(Optional) Define the policy to redirect the matched packets to the desired port.</p> <p><i>port</i>: The destination port to which the packets will be redirected. The default is All.</p> <p>s-mirror interface { <i>fastEthernet port</i> <i>gigabitEthernet port</i> <i>ten-gigabitEthernet port</i> }</p> <p>(Optional) Define the policy to mirror the matched packets to the desired port.</p> <p><i>port</i>: The destination port to which the packets will be mirrored.</p> <p>s-condition rate <i>rate</i> burst <i>burst-size</i> osd { <i>none</i> <i>discard</i> <i>remark dscp dscp</i> }</p> <p>(Optional) Define the policy to monitor the rate of the matched packets.</p> <p><i>rate</i>: Specify a rate from 1 to 1000000 kbps.</p> <p><i>burst-size</i>: Specify the number of bytes allowed in one second ranging from 1 to 128.</p> <p>osd: Select either "none", "discard" or "remark dscp" as the action to be taken for the packets whose rate is beyond the specified rate. The default is None. When "remark dscp" is selected, you also need to specify the DSCP value for the matched packets. The DSCP value ranges from 0 to 63.</p> <p>Note: Remark DSCP is only available on certain devices.</p> <p>qos-remark [<i>dscp dscp</i>] [<i>priority pri</i>] [<i>dot1p pri</i>]</p> <p>(Optional) Define the policy to remark priority for the matched packets.</p> <p><i>dscp</i>: Specify the DSCP region for the data packets. The value ranges from 0 to 63.</p> <p>priority <i>pri</i>: Specify the local priority for the data packets. The value ranges from 0 to 7.</p> <p>dot1p <i>pri</i>: Specify the 802.1p priority for the data packets. The value ranges from 0 to 7.</p>
Step 4	<p>end</p> <p>Return to privileged EXEC mode.</p>
Step 5	<p>copy running-config startup-config</p> <p>Save the settings in the configuration file.</p>

Redirect the matched packets to port 1/0/4 for rule 1 of MAC ACL 10:

```
Switch#configure
```

```
Switch(config)#access-list action 10 rule 1
```

```
Switch(config-action)#redirect interface gigabitEthernet 1/0/4
```

```
Switch(config-action)#exit
```

```
Switch(config)#show access-list 10
```

```
MAC access list 10 name: ACL_10
```

```
rule 5 permit logging disable action redirect Gi1/0/4
```

```
Switch(config)#end
```

```
Switch#copy running-config startup-config
```

2.2.4 Configuring ACL Binding

You can bind the ACL to a port or a VLAN. The received packets on the port or in the VLAN will then be matched and processed according to the ACL rules. An ACL takes effect only after it is bound to a port or VLAN.

Note:

- Different types of ACLs cannot be bound to the same port or VLAN.
- Multiple ACLs of the same type can be bound to the same port or VLAN. The switch matches the received packets using the ACLs in order. The ACL that is bound earlier has a higher priority.

Follow the steps below to bind ACL to a port or a VLAN:

Step 1	configure Enter global configuration mode
Step 2	access-list bind <i>acl-id-or-name</i> interface { [vlan <i>vlan-list</i>] } [[fastEthernet <i>port-list</i>]] [[gigabitEthernet <i>port-list</i>]] [[ten-gigabitEthernet <i>port-list</i>]] } Bind the ACL to a port or a VLAN. <i>acl-id-or-name</i> : Enter the ID or name of the ACL that you want to add a rule for. <i>vlan-list</i> : Specify the ID or the ID list of the VLAN(s) that you want to bind the ACL to. The valid values are from 1 to 4094, for example, 2-3,5. <i>port-list</i> : Specify the number or the list of the Ethernet port that you want to bind the ACL to.
Step 3	show access-list bind View the ACL binding configuration.
Step 4	end Return to privileged EXEC mode.

Step 5 `copy running-config startup-config`

Save the settings in the configuration file.

The following example shows how to bind ACL 1 to port 3 and VLAN 4:

Switch#configure

Switch(config)#access-list bind 1 interface vlan 4 gigabitEthernet 1/0/3

Switch(config)#show access-list bind

ACL ID	ACL NAME	Interface/VID	Direction	Type
-----	-----	-----	-----	----
1	ACL_1	Gi1/0/3	Ingress	Port
1	ACL_1	4	Ingress	VLAN

Switch(config)#end

Switch#copy running-config startup-config

2.2.5 Viewing ACL Counting

You can use the following command to view the number of matched packets of each ACL in the privileged EXEC mode and any other configuration mode:

show access-list *acl-id-or-name* counter

View the number of matched packets of the specific ACL.

acl-id-or-name: Specify the ID or name of the ACL to be viewed.

3 Configuration Example for ACL

3.1 Configuration Example for MAC ACL

3.1.1 Network Requirements

A company forbids the employees in the R&D department to visit the internal forum during work hours. While the manager of the R&D department can get access to the internal forum without limitation.

As shown below, the internal forum server is connected to the switch via port 1/0/1, and computers in the R&D department are connected to the switch via port 1/0/2.

Figure 3-1 Network Topology

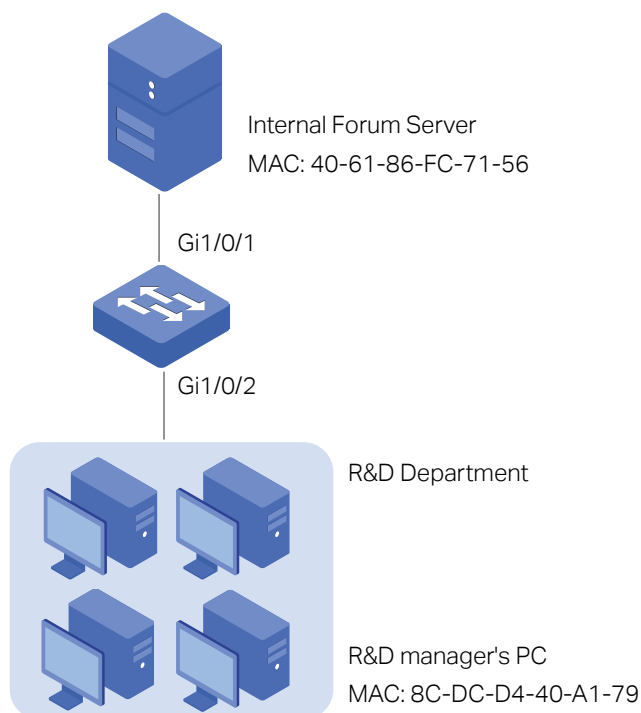

3.1.2 Configuration Scheme

To meet the requirements above, you can set up packet filtering by creating an MAC ACL and configuring rules for it.

■ Time Range Configuration

Create a time range entry for the work hour of the company. Apply the time range to the ACL rule which blocks the access to internal forum server.

■ ACL Configuration

Create a MAC ACL and configure the following rules for it:

- Configure a permit rule to match packets with source MAC address 8C-DC-D4-40-A1-79 and destination MAC address 40-61-86-FC-71-56. This rule allows the manager of R&D department to visit internal forum at any time.
- Configure a deny rule to match packets with destination MAC address 40-61-86-FC-71-56 and apply the time range of work hours. This rule forbids the employees in the R&D department to visit the internal forum during work hours.
- Configure a permit rule to match all the packets that do not match neither of the above rules.

■ Binding Configuration

Bind the MAC ACL to port 1/0/2 so that the ACL rules will be applied to the computer of the devices in the R&D department which are restricted to the internal forum during work hours.

Demonstrated with SG6654XHP, the following sections explain the configuration procedure in two ways: using the GUI and using the CLI.

3.1.3 Using the GUI

- 1) Choose the menu **SYSTEM > Time Range > Time Range Config** and click  **Add** to load the following page. Create a time range named `Work_time`.

Figure 3-2 Configuring Time Range



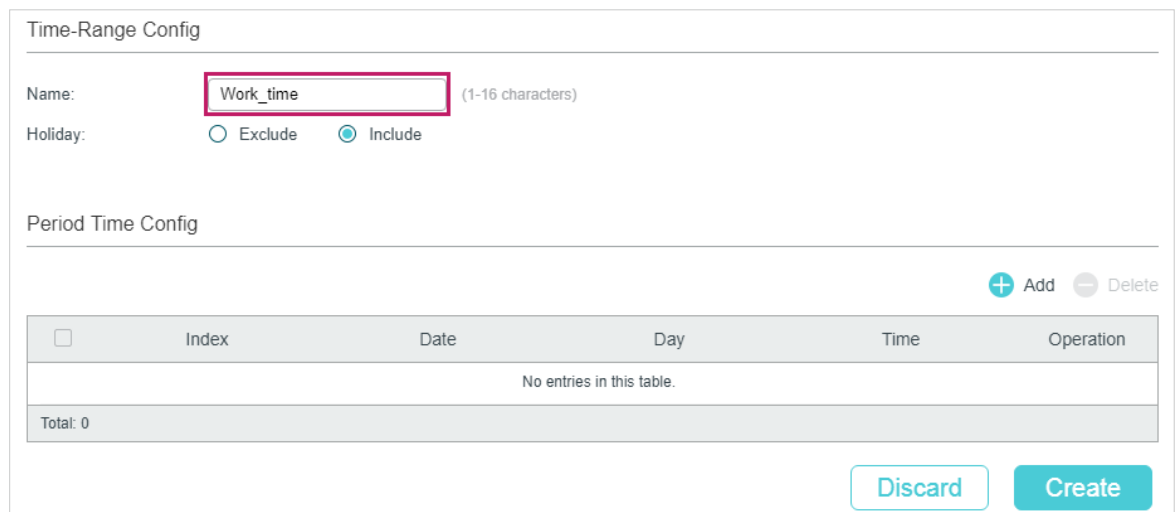

Time-Range Config

Name: (1-16 characters)

Holiday: Exclude Include

Period Time Config

 Add  Delete

<input type="checkbox"/>	Index	Date	Day	Time	Operation
No entries in this table.					
Total: 0					

- 2) In the **Period Time Config** section, click  **Add** and the following window will pop up. Add the work hour of the company in the **Period Time** and click **Save**.

Figure 3-3 Adding Period Time

Period Time Config

Date

From:
 Month: Day: Year:

To:
 Month: Day: Year:

Time

From: 08:00 (Format: HH:MM)

To: 18:00 (Format: HH:MM)

Day of Week

Mon
 Tue
 Wed
 Thu
 Fri
 Sat
 Sun

Cancel
Save

3) After adding the Period Time, click **Create** to save the time range entry.

Figure 3-4 Creating Time Range

Time-Range Config

Name: (1-16 characters)

Holiday: Exclude Include

Period Time Config

+ Add
 - Delete

Index	Date	Day	Time	Operation
0	January 1, 2018 - January 1, 2019	Mon, Tue, Wed, Thu, Fri	08:00 - 18:00	✎ 🗑
Total: 0				

Discard
Create

4) Choose the menu **SECURITY > ACL > ACL Config** and click + Add to load the following page. Then create a MAC ACL for the marketing department.

Figure 3-5 Creating a MAC ACL

ACL

ACL Type: MAC ACL

ACL ID: 100 (0-499)

ACL Name: Forum_Control (Optional)

Cancel Create

- 5) Click **Edit ACL** in the Operation column.

Figure 3-6 Editing the MAC ACL

ACL Config

+ Add - Delete

<input type="checkbox"/>	ACL Type	ACL ID	ACL Name	Rules	Operation
<input type="checkbox"/>	MAC ACL	100	Forum_Control	None	Edit ACL

Total: 1

- 6) On the ACL configuration page, click + Add.

Figure 3-7 Editing the MAC ACL

ACL Details

ACL Type: MAC ACL

ACL ID: 100

ACL Name: Forum_Control

ACL Rules Config

↕ Resequence + Add - Delete ↻ Refresh

<input type="checkbox"/>	Index	Rule ID	S-MAC	D-MAC	Action	Total Matched Counter	Operation
No entries in this table.							

Total: 0

- 7) Configure rule 5 to permit packets with the source MAC address 8C-DC-D4-40-A1-79 and destination MAC address 40-61-86-FC-71-56.

Figure 3-8 Configuring Rule 5

MAC ACL Rule

ACL ID: 100
 ACL Name: Forum_Control

Rule ID: Auto Assign

Operation: ▼

S-MAC: (Format: FF-FF-FF-FF-FF-FF)
 Mask: (Format: FF-FF-FF-FF-FF-FF)

D-MAC: (Format: FF-FF-FF-FF-FF-FF)
 Mask: (Format: FF-FF-FF-FF-FF-FF)

VLAN ID: (1-4094)
 EtherType: (4-hex number)

User Priority: ▼

Time Range: ▼ (Optional)

Logging: ▼

Policy

Mirroring
 Redirect
 Rate Limit
 QoS Remark

- 8) In the same way, configure rule 15 to deny packets with destination MAC address 40-61-86-FC-71-56 and apply the time range of work hours.

Figure 3-9 Configuring Rule 15

MAC ACL Rule

ACL ID: 100
 ACL Name: Forum_Control

Rule ID: Auto Assign
 Operation:

S-MAC: (Format: FF-FF-FF-FF-FF-FF)
 Mask: (Format: FF-FF-FF-FF-FF-FF)

D-MAC: (Format: FF-FF-FF-FF-FF-FF)
 Mask: (Format: FF-FF-FF-FF-FF-FF)

VLAN ID: (1-4094)
 EtherType: (4-hex number)

User Priority:

Time Range: (Optional)

Logging:

Policy

Mirroring
 Redirect
 Rate Limit
 QoS Remark

9) Configure rule 25 to permit all the packets that do not match neither of the above rules.

Figure 3-10 Configuring Rule 25

MAC ACL Rule

ACL ID: 100
 ACL Name: Forum_Control

Rule ID: Auto Assign
 Operation:

S-MAC: (Format: FF-FF-FF-FF-FF-FF)
 Mask: (Format: FF-FF-FF-FF-FF-FF)

D-MAC: (Format: FF-FF-FF-FF-FF-FF)
 Mask: (Format: FF-FF-FF-FF-FF-FF)

VLAN ID: (1-4094)
 EtherType: (4-hex number)

User Priority:
 Time Range: (Optional)
 Logging:

Policy

Mirroring
 Redirect
 Rate Limit
 QoS Remark

10) Choose the menu **SECURITY > ACL > ACL Binding** and click **+** Add to load the following page. Bind ACL 500 to port 1/0/2 to make it take effect.

Figure 3-11 Binding the ACL to Port 1/0/2

Port Binding Config

ACL: ID Name

Direction: (Format: 1/0/1, input or choose below)

Port: (Format: 1/0/1, input or choose below)

UNIT1

1	3	5	7	9	11	13	15	17	19	21	23	25	27	29	31	33	35	37	39
2	4	6	8	10	12	14	16	18	20	22	24	26	28	30	32	34	36	38	40
41 43 45 47				49 51 53															
42 44 46 48				50 52 54															

Select All

- 1) Click  Save to save the settings.

3.1.4 Using the CLI

- 1) Create a time range entry .

```
Switch#config
```

```
Switch(config)#time-range Work_time
```

```
Switch(config-time-range)#holiday include
```

```
Switch(config-time-range)#absolute from 01/01/2018 to 01/01/2019
```

```
Switch(config-time-range)#periodic start 08:00 end 18:00 day-of-the-week 1,2,3,4,5
```

```
Switch(config-time-range)#end
```

```
Switch#copy running-config startup-config
```

- 2) Create a MAC ACL.

```
Switch#configure
```

```
Switch(config)#access-list create 100 name Forum_Control
```

- 3) Configure rule 5 to permit packets with source MAC address 8C-DC-D4-40-A1-79 and destination MAC address 40-61-86-FC-71-56.

```
Switch(config)#access-list mac 100 rule 5 permit logging disable smac 8C:DC:D4:40:A1:79 smask FF: FF: FF: FF: FF: FF dmac 40:61:86:FC:71:56 dmask FF: FF: FF: FF: FF: FF
```

- 4) Configure rule 15 to deny packets with destination MAC address 40-61-86-FC-71-56.

```
Switch(config)#access-list mac 100 rule 15 deny logging disable dmac 40:61:86:FC:71:56 dmask FF: FF: FF: FF: FF: FF tseg Work_time
```

- 5) Configure rule 25 to permit all the packets. The rule makes sure that the traffic to other network resources will not be blocked by the switch.

```
Switch(config)#access-list mac 100 rule 25 permit logging disable
```

- 6) Bind ACL100 to port 1/0/2.

```
Switch(config)#access-list bind 100 interface gigabitEthernet 1/0/2
```

```
Switch(config)#end
```

```
Switch#copy running-config startup-config
```

Verify the Configurations

Verify the MAC ACL 100:

```
Switch#show access-list 100
```

```
MAC access list 100 name: "Forum_Control"
```



```
rule 5 permit logging disable smac 8c:dc:d4:40:a1:79 smask ff:ff:ff:ff:ff:ff dmac
40:61:86:fc:71:56 dmask ff:ff:ff:ff:ff:ff
```

```
rule 15 deny logging disable dmac 40:61:86:fc:71:56 dmask ff:ff:ff:ff:ff:ff tseg "Work_time"
```

```
rule 25 permit logging disable
```

```
Switch#show access-list bind
```

ACL ID	ACL NAME	Interface/VID	Direction	Type
-----	-----	-----	-----	----
100	Forum_Control	Gi1/0/2	Ingress	Port

3.2 Configuration Example for IP ACL

3.2.1 Network Requirements

As shown below, a company's internal server group can provide different types of services. Computers in the Marketing department are connected to the switch via port 1/0/1, and the internal server group is connected to the switch via port 1/0/2.

Figure 3-12 Network Topology

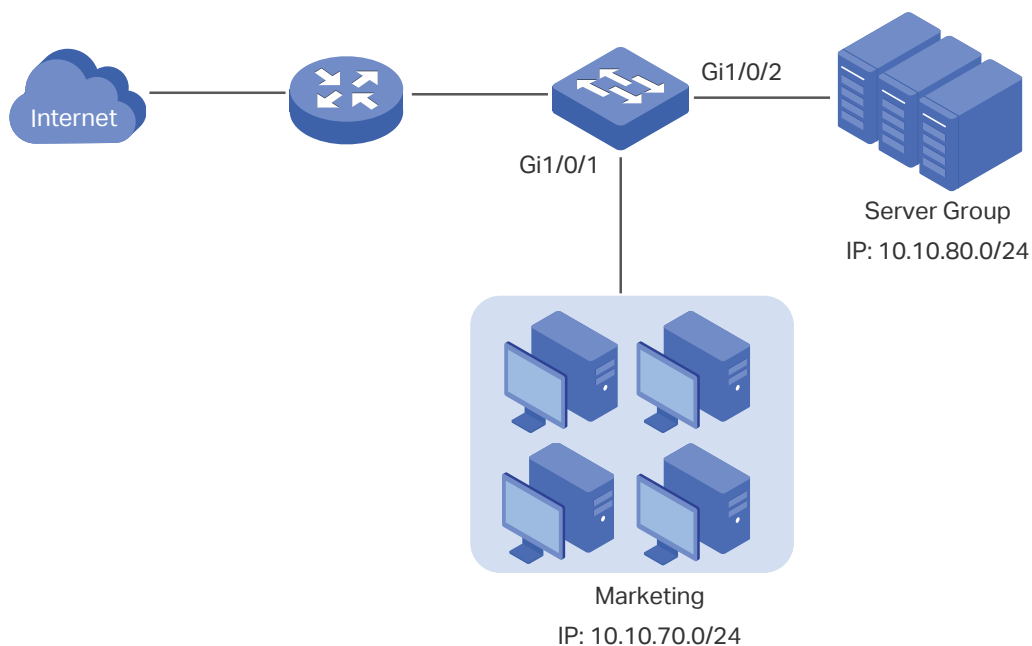

It is required that:

- The Marketing department can only access internal server group in the intranet.
- The Marketing department can only visit http and https websites on the internet.

3.2.2 Configuration Scheme

To meet the requirements above, you can set up packet filtering by creating an IP ACL and configuring rules for it.

■ ACL Configuration

Create an IP ACL and configure the following rules for it:

- Configure a permit rule to match packets with source IP address 10.10.70.0/24, and destination IP address 10.10.80.0/24. This rule allows the Marketing department to access internal network servers from intranet.
- Configure four permit rules to match the packets with source IP address 10.10.70.0/24, and destination ports TCP 80, TCP 443 and TCP/UDP 53. These allow the Marketing department to visit http and https websites on the internet.

The switch matches the packets with the rules in order, starting with Rule 1. If a packet matches a rule, the switch stops the matching process and initiates the action defined in the rule.

■ Binding Configuration

Bind the IP ACL to port 1/0/1 so that the ACL rules will apply to the Marketing department only.

Demonstrated with T1600G-28TS, the following sections explain the configuration procedure in two ways: using the GUI and using the CLI.

3.2.3 Using the GUI

- 1) Choose the menu **SECURITY > ACL > ACL Config** and click **+ Add** to load the following page. Then create an IP ACL for the marketing department.

Figure 3-13 Creating an IP ACL

The screenshot shows the 'ACL' configuration page. The 'ACL Type' dropdown is set to 'IP ACL'. The 'ACL ID' is set to '500' with a range of '(500-999)'. The 'ACL Name' is set to 'marketing' with '(Optional)' next to it. The 'Create' button is highlighted with a red box.

- 2) Click **Edit ACL** in the Operation column.

Figure 3-14 Editing IP ACL

ACL Config

+ Add - Delete

<input type="checkbox"/>	ACL Type	ACL ID	ACL Name	Rules	Operation
<input type="checkbox"/>	IP ACL	500	marketing	None	Edit ACL
Total: 1					

3) On the ACL configuration page, click + Add.

Figure 3-15 Editing IP AC

ACL Details

ACL Type: IP ACL
 ACL ID: 500
 ACL Name: marketing

ACL Rules Table

1 Resequence + Add - Delete Refresh

<input type="checkbox"/>	ID	Rule ID	S-IP	D-IP	IP Protocol	Action	Total Matched Counter	Operation
No Entries in this table.								
Total: 0								

4) Configure rule 1 to permit packets with the source IP address 10.10.70.0/24 and destination IP address 10.10.80.0/24.

Figure 3-16 Configuring Rule 1

IP ACL Rule

ACL ID: 500
 ACL Name: marketing

Rule ID: Auto Assign
 Operation:

S-IP: (Format: 192.168.0.1)
 Mask: (Format: 255.255.255.0)
 D-IP: (Format: 192.168.0.1)
 Mask: (Format: 255.255.255.0)

IP Protocol:
 DSCP:
 IP ToS: (Optional, 0-15)
 IP Pre: (Optional, 0-7)

- In the same way, configure rule 2 and rule 3 to permit packets with source IP 10.10.70.0 and destination port TCP 80 (http service port) and TCP 443 (https service port).

Figure 3-17 Configuring Rule 2

IP ACL Rule

ACL ID: 500

ACL Name: marketing

Rule ID: Auto Assign

Operation:

S-IP: (Format: 192.168.0.1)

Mask: (Format: 255.255.255.0)

D-IP: (Format: 192.168.0.1)

Mask: (Format: 255.255.255.0)

IP Protocol:

URG: ACK: PSH:

RST: SYN: FIN:

S-Port

Value: (0-65535)

Mask: (0000-ffff)

D-Port

Value: (0-65535)

Mask: (0000-ffff)

DSCP:

IP ToS: (Optional, 0-15)

Figure 3-18 Configuring Rule 3

IP ACL Rule

ACL ID: 500

ACL Name: marketing

Rule ID: Auto Assign

Operation: ▼

S-IP: (Format: 192.168.0.1)

Mask: (Format: 255.255.255.0)

D-IP: (Format: 192.168.0.1)

Mask: (Format: 255.255.255.0)

IP Protocol: ▼

URG: ▼ ACK: ▼ PSH: ▼

RST: ▼ SYN: ▼ FIN: ▼

S-Port

Value: (0-65535)

Mask: (0000-ffff)

D-Port

Value: (0-65535)

Mask: (0000-ffff)

DSCP: ▼

IP ToS: (Optional, 0-15)

- 6) In the same way, configure rule 4 and rule 5 to permit packets with source IP 10.10.70.0 and with destination port TCP 53 or UDP 53 (DNS service port).

Figure 3-19 Configuring Rule 4

IP ACL Rule

ACL ID: 500

ACL Name: marketing

Rule ID: Auto Assign

Operation:

S-IP: (Format: 192.168.0.1)

Mask: (Format: 255.255.255.0)

D-IP: (Format: 192.168.0.1)

Mask: (Format: 255.255.255.0)

IP Protocol:

URG: ACK: PSH:

RST: SYN: FIN:

S-Port

Value: (0-65535)

Mask: (0000-ffff)

D-Port

Value: (0-65535)

Mask: (0000-ffff)

DSCP:

IP ToS: (Optional, 0-15)

Figure 3-20 Configuring Rule 5

IP ACL Rule

ACL ID: 500

ACL Name: marketing

Rule ID: Auto Assign

Operation:

S-IP: (Format: 192.168.0.1)

Mask: (Format: 255.255.255.0)

D-IP: (Format: 192.168.0.1)

Mask: (Format: 255.255.255.0)

IP Protocol:

S-Port

Value: (0-65535)

Mask: (0000-ffff)

D-Port

Value: (0-65535)

Mask: (0000-ffff)

DSCP:

IP ToS: (Optional, 0-15)

7) In the same way, configure rule 6 to deny packets with source IP 10.10.70.0.

Figure 3-21 Configuring Rule 6

IP ACL Rule

ACL ID: 500

ACL Name: marketing

Rule ID: Auto Assign

Operation:

S-IP: (Format: 192.168.0.1)

Mask: (Format: 255.255.255.0)

D-IP: (Format: 192.168.0.1)

Mask: (Format: 255.255.255.0)

IP Protocol:

DSCP:

IP ToS: (Optional, 0-15)

IP Pre: (Optional, 0-7)



8) Choose the menu **SECURITY > ACL > ACL Binding** and click  Add to load the following page. Bind ACL Marketing to port 1/0/1 to make it take effect.

Figure 3-22 Binding the ACL to Port 1/0/1

The screenshot shows the 'Port Binding Config' window. At the top, there are radio buttons for 'ID' (selected) and 'Name'. Below that is a dropdown menu showing '500'. The 'Direction' is set to 'Ingress'. The 'Port' field contains '1/0/2'. Below the port field is a grid of port icons labeled 'UNIT1', with port '2' highlighted. At the bottom right, there are 'Cancel' and 'Create' buttons, with 'Create' highlighted.

- 9) Click  Save to save the settings.

3.2.4 Using the CLI

- 1) Create an IP ACL.

```
Switch#configure
```

```
Switch(config)#access-list create 500 name marketing
```

- 2) Configure rule 1 to permit packets with source IP 10.10.70.0/24 and destination IP 10.10.80.0/24.

```
Switch(config)#access-list ip 500 rule 1 permit logging disable sip 10.10.70.0 sip-mask 255.255.255.0 dip 10.10.80.0 dmask 255.255.255.0
```

- 3) Configure rule 2 and Rule 3 to permit packets with source IP 10.10.70.0/24, and destination port TCP 80 (http service port) or TCP 443 (https service port).

```
Switch(config)#access-list ip 500 rule 2 permit logging disable sip 10.10.70.0 sip-mask 255.255.255.0 protocol 6 d-port 80 d-port-mask ffff
```

```
Switch(config)#access-list ip 500 rule 3 permit logging disable sip 10.10.70.0 sip-mask 255.255.255.0 protocol 6 d-port 443 d-port-mask ffff
```

- 4) Configure rule 4 and rule 5 to permit packets with source IP 10.10.70.0/24, and destination port TCP53 or UDP 53.

```
Switch(config)#access-list ip 500 rule 4 permit logging disable sip 10.10.70.0 sip-mask 255.255.255.0 protocol 6 d-port 53 d-port-mask ffff
```

```
Switch(config)#access-list ip 500 rule 5 permit logging disable sip 10.10.70.0 sip-amask 255.255.255.0 protocol 17 d-port 53 d-port-mask ffff
```

- 5) Configure rule 6 to deny packets with source IP 10.10.70.0/24.

```
Switch(config)#access-list ip 500 rule 2 deny logging disable sip 10.10.70.0 sip-mask
255.255.255.0
```

6) Bind ACL500 to port 1.

```
Switch(config)#access-list bind 500 interface gigabitEthernet 1/0/1
```

```
Switch(config)#end
```

```
Switch#copy running-config startup-config
```

Verify the Configurations

Verify the IP ACL 500:

```
Switch#show access-list 500
```

```
rule 1 permit logging disable sip 10.10.70.0 smask 255.255.255.0 dip 10.10.80.0 dmask
255.255.255.0
```

```
rule 2 permit logging disable sip 10.10.70.0 smask 255.255.255.0 protocol 6 d-port 80
```

```
rule 3 permit logging disable sip 10.10.70.0 smask 255.255.255.0 protocol 6 d-port 443
```

```
rule 4 permit logging disable sip 10.10.70.0 smask 255.255.255.0 protocol 6 d-port 53
```

```
rule 5 permit logging disable sip 10.10.70.0 smask 255.255.255.0 protocol 17 d-port 53
```

```
rule 6 deny loggin disable sip 10.10.70.0 smask 255.255.255.0
```

```
Switch#show access-list bind
```

ACL ID	ACL NAME	Interface/VID	Direction	Type
-----	-----	-----	-----	----
500	marketing	Gi1/0/1	Ingress	Port

3.3 Configuration Example for Combined ACL

3.3.1 Network Requirements

To enhance network security, a company requires that only the network administrator can log in to the switch through Telnet connection. The computers are connected to the switch via port 1/0/2. The network topology is shown as below.

Figure 3-23 Network Topology

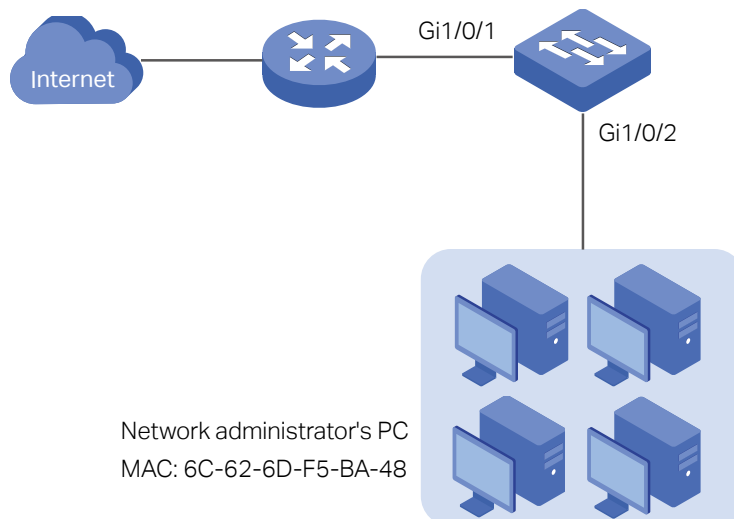

3.3.2 Configuration Scheme

To meet the requirements above, you can set up packet filtering by creating a Combined ACL and configuring rules for it.

■ ACL Configuration

Create a Combined ACL and configure the following rules for it:

- Configure a permit rule to match packets with source MAC address 6C-62-6D-F5-BA-48, and destination port TCP 23. This rule allows the computer of the network administrator to access the switch through Telnet connection.
- Configure a deny rule to match all the packets except the packets with source MAC address 6C-62-6D-F5-BA-48 and destination port TCP 23. This rule blocks the Telnet connection to the switch of other computers.
- Configure a permit rule to match all the packets. This rule allows that other devices are given the network services except Telnet connection.

The switch matches the packets with the rules in order, starting with Rule 1. If a packet matches a rule, the switch stops the matching process and initiates the action defined in the rule.

■ Binding Configuration

Bind the Combined ACL to port 1/0/2 so that the ACL rules will be applied to the computer of the network administrator and the devices which are restricted to Telnet connection.

Demonstrated with SG6654XHP, the following sections explain the configuration procedure in two ways: using the GUI and using the CLI.

3.3.3 Using the GUI

- 1) Choose the menu **SECURITY > ACL > ACL Config** and click **+ Add** to load the following page. Then create a Combined ACL for the marketing department.

Figure 3-24 Creating an Combined ACL

- 2) Click **Edit ACL** in the Operation column.

Figure 3-25 Editing Combined ACL

ACL Type	ACL ID	ACL Name	Rules	Operation
Combined ACL	1000	ACL_Telnet	None	Edit ACL

- 3) On the ACL configuration page, click **+ Add**.

Figure 3-26 Editing Combined ACL

ACL Details

ACL Type: Combined ACL
 ACL ID: 1000
 ACL Name: ACL_Telnet

ACL Rules Config

 Resequence  Add  Delete  Refresh

<input type="checkbox"/>	Index Rule ID	S-MAC	D-MAC	S-IP	D-IP	VID	Action	Total Matched Counter	Operation
No entries in this table.									
Total: 0									

- 4) Configure rule 5 to permit packets with the source MAC address 6C-62-6D-F5-BA-48 and destination port TCP 23 (Telnet service port).

Figure 3-27 Configuring Rule 5

Combined ACL Rule

ACL ID: 1000

ACL Name: ACL_Telnet

Rule ID: Auto Assign

Operation:

S-MAC: (Format: FF-FF-FF-FF-FF-FF)

Mask: (Format: FF-FF-FF-FF-FF-FF)

D-MAC: (Format: FF-FF-FF-FF-FF-FF)

Mask: (Format: FF-FF-FF-FF-FF-FF)

VLAN ID: (1-4094)

EtherType: (4-hex number)

S-IP: (Format: 192.168.0.1)

Mask: (Format: 255.255.255.0)

D-IP: (Format: 192.168.0.1)

Mask: (Format: 255.255.255.0)

IP Protocol:

URG: ACK: PSH:

RST: SYN: FIN:

S-Port

Value: (0-65535)

Mask: (0000-FFFF)

D-Port

Value: (0-65535)

Mask: (0000-FFFF)

DSCP:

IP ToS: (Optional, 0-15)

- 5) Configure rule 15 to deny all the packets except the packet with source MAC address 6C-62-6D-F5-BA-48, and destination port TCP 23 (Telnet service port).

Figure 3-28 Configuring Rule 15

Combined ACL Rule

ACL ID: 1000
 ACL Name: ACL_Telnet

Rule ID: 15
 Operation: Deny

S-MAC: (Format: FF-FF-FF-FF-FF-FF)
 Mask: (Format: FF-FF-FF-FF-FF-FF)

D-MAC: (Format: FF-FF-FF-FF-FF-FF)
 Mask: (Format: FF-FF-FF-FF-FF-FF)

VLAN ID: (1-4094)

EtherType: 0800 (4-hex number)

S-IP: (Format: 192.168.0.1)
 Mask: (Format: 255.255.255.0)

D-IP: (Format: 192.168.0.1)
 Mask: (Format: 255.255.255.0)

IP Protocol: TCP

URG: * ACK: * PSH: *
 RST: * SYN: * FIN: *

S-Port
 Value: (0-65535)
 Mask: (0000-FFFF)

D-Port
 Value: 23 (0-65535)
 Mask: FFFF (0000-FFFF)

DSCP: No Limit

IP ToS: (Optional, 0-15)

- 6) In the same way, configure rule 25 to permit all the packets. The rule makes sure that all devices can get other network services normally.

Figure 3-29 Configuring Rule 25

Combined ACL Rule	
ACL ID:	1000
ACL Name:	ACL_Telnet
Rule ID:	25
Operation:	Permit ▼
<input type="checkbox"/> S-MAC:	<input type="text"/> (Format: FF-FF-FF-FF-FF-FF)
Mask:	<input type="text"/> (Format: FF-FF-FF-FF-FF-FF)
<input type="checkbox"/> D-MAC:	<input type="text"/> (Format: FF-FF-FF-FF-FF-FF)
Mask:	<input type="text"/> (Format: FF-FF-FF-FF-FF-FF)
<input type="checkbox"/> VLAN ID:	<input type="text"/> (1-4094)
<input type="checkbox"/> EtherType:	<input type="text"/> (4-hex number)
<input type="checkbox"/> S-IP:	<input type="text"/> (Format: 192.168.0.1)
Mask:	<input type="text"/> (Format: 255.255.255.0)
<input type="checkbox"/> D-IP:	<input type="text"/> (Format: 192.168.0.1)
Mask:	<input type="text"/> (Format: 255.255.255.0)
IP Protocol:	No Limit ▼
DSCP:	No Limit ▼
IP ToS:	<input type="text"/> (Optional, 0-15)
IP Pre:	<input type="text"/> (Optional, 0-7)
User Priority:	Default ▼
Time Range:	<input type="text"/> ▼ (Optional)
Logging:	Disable ▼

- 7) Choose the menu **SECURITY > ACL > ACL Binding** and click  Add to load the following page. Bind the Policy ACL_Telnet to port 1/0/2 to make it take effect.

Figure 3-30 Binding the ACL to Port 1/0/2

Port Binding Config

ACL: ID Name
 1000

Direction: Ingress

Port: 1/0/2 (Format: 1/0/1, input or choose below)

Select All

INIT1

1 3 5 7 9 11 13 15 17 19 21 23 25 27
 2 4 6 8 10 12 14 16 18 20 22 24 26 28

Cancel Create

- 8) Click  Save to save the settings.

3.3.4 Using the CLI

- 1) Create a Combined ACL.

```
Switch#configure
```

```
Switch(config)#access-list create 1000 name ACL_Telnet
```

- 2) Configure rule 5 to permit packets with the source MAC address 6C-62-6D-F5-BA-48 and destination port TCP 23 (Telnet service port).

```
Switch(config)#access-list combined 1000 rule 5 permit logging disable smac 6C:62:6D:F5:BA:48 smask FF:FF:FF:FF:FF:FF type 0800 protocol 6 d-port 23 d-port-mask FFFF
```

- 3) Configure rule 15 to deny all the packets except the packet with source MAC address 6C-62-6D-F5-BA-48, and destination port TCP 23 (Telnet service port).

```
Switch(config)#access-list combined 1000 rule 15 deny logging disable type 0800 protocol 6 d-port 23 d-port-mask FFFF
```

- 4) Configure rule 25 to permit all the packets. The rule makes sure that all devices can get other network services normally.

```
Switch(config)#access-list combined 1000 rule 25 permit logging disable type 0800 protocol 6 d-port 23 d-port-mask FFFF
```

- 5) Bind ACL500 to port 1/0/2.

```
Switch(config)#access-list bind 500 interface gigabitEthernet 1/0/2
```

```
Switch(config)#end
```

```
Switch#copy running-config startup-config
```

Verify the Configurations

Verify the Combined ACL 1000:

```
Switch#show access-list 1000
```

```
Combined access list 1000 name: "ACL_Telnet"
```

```
rule 5 permit logging disable smac 6c:62:6d:f5:ba:48 smask ff:ff:ff:ff:ff:ff type 0800 protocol 6 d-port 23
```

```
rule 15 deny logging disable type 0800 protocol 6 d-port 23
```

```
rule 25 permit logging disable
```

```
Switch#show access-list bind
```

ACL ID	ACL NAME	Interface/VID	Direction	Type
1000	ACL_Telnet	Gi1/0/2	Ingress	Port

4 Appendix: Default Parameters

The default settings of ACL are listed in the following tables:

Table 4-1 MAC ACL

Parameter	Default Setting
Operation	Permit
User Priority	No Limit
Time-Range	No Limit

Table 4-2 IP ACL

Parameter	Default Setting
Operation	Permit
IP Protocol	All
DSCP	No Limit
IP ToS	No Limit
IP Pre	No Limit
Time-Range	No Limit

Table 4-3 IPv6 ACL

Parameter	Default Setting
Operation	Permit
Time-Range	No Limit

Table 4-4 Combined ACL

Parameter	Default Setting
Operation	Permit
Time-Range	No Limit

Table 4-5 Policy

Parameter	Default Setting
Mirroring	Disabled
Redirect	Disabled
Rate Limit	Disabled
QoS Remark	Disabled

Part 30

Configuring IPv4 IMPB

CHAPTERS

1. IPv4 IMPB
2. IP-MAC Binding Configuration
3. ARP Detection Configuration
4. IPv4 Source Guard Configuration
5. Configuration Examples
6. Appendix: Default Parameters

1 IPv4 IMPB

1.1 Overview

IPv4 IMPB (IP-MAC-Port Binding) is used to bind the IP address, MAC address, VLAN ID and the connected port number of the specified host. Basing on the binding table, the switch can prevent the ARP cheating attacks with the ARP Detection feature and filter the packets that don't match the binding entries with the IP Source Guard feature.

1.2 Supported Features

IP-MAC Binding

This feature is used to add binding entries. The binding entries can be manually configured, or learned by ARP scanning or DHCP snooping. The features ARP Detection and IPv4 Source Guard are based on the IP-MAC Binding entries.

ARP Detection

In an actual complex network, there are high security risks during ARP implementation procedure. The cheating attacks against ARP, such as imitating gateway, cheating gateway, cheating terminal hosts and ARP flooding attack, frequently occur to the network. ARP Detection can prevent the network from these ARP attacks.

- Prevent ARP Cheating Attacks

Based on the IP-MAC Binding entries, the ARP Detection can be configured to detect the ARP packets and filter the illegal ones so as to prevent the network from ARP cheating attacks.

- Prevent ARP Flooding Attack

You can limit the receiving speed of the legal ARP packets on the port to avoid ARP flooding attack.

IPv4 Source Guard

IPv4 Source Guard is used to filter the IPv4 packets based on the IP-MAC Binding table. Only the packets that match the binding rules are forwarded.

2 IP-MAC Binding Configuration

You can add IP-MAC Binding entries in three ways:

- Manual Binding
- Via ARP Scanning
- Via DHCP Snooping

Additionally, you can view, search and edit the entries in the Binding Table.

2.1 Using the GUI

2.1.1 Binding Entries Manually

You can manually bind the IP address, MAC address, VLAN ID and the Port number together on the condition that you have got the detailed information of the hosts.

Choose the menu **SECURITY > IPv4 IMPB > IP-MAC Binding > Manual Binding** and click  **Add** to load the following page.

Figure 2-1 Manual Binding

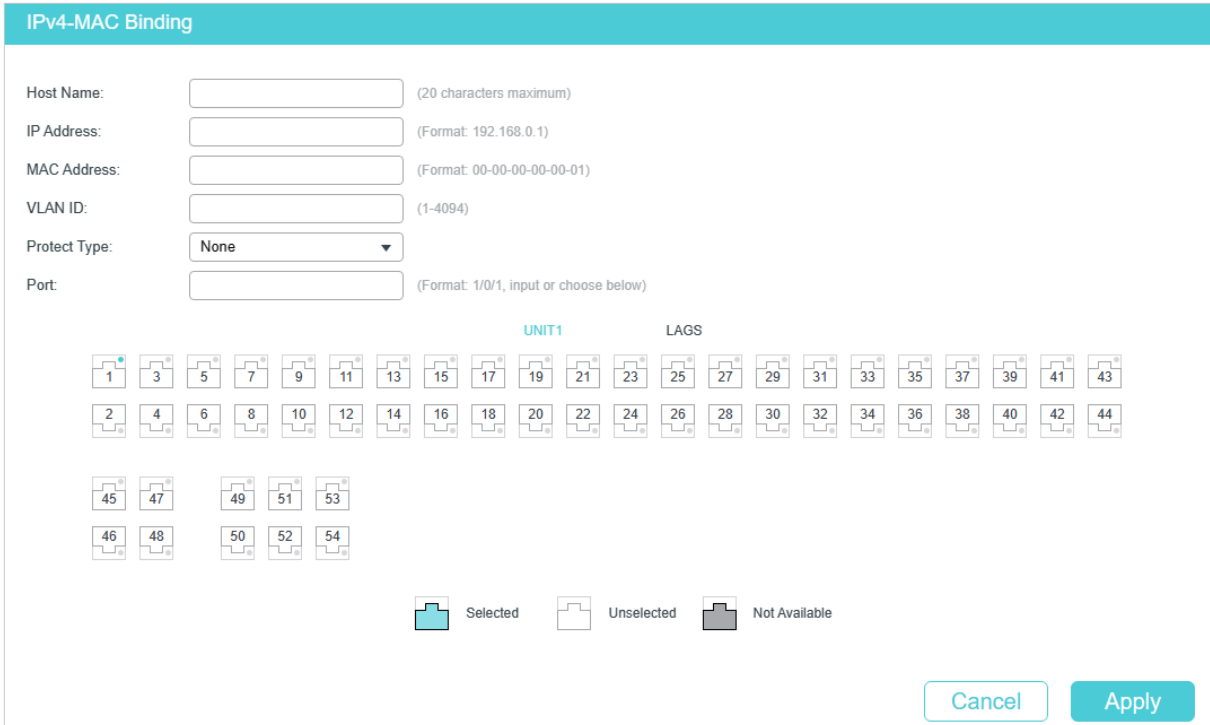

IPv4-MAC Binding

Host Name: (20 characters maximum)

IP Address: (Format: 192.168.0.1)

MAC Address: (Format: 00-00-00-00-00-01)

VLAN ID: (1-4094)

Protect Type: **None** ▼

Port: (Format: 1/0/1, input or choose below)

UNIT1 **LAGS**

1 3 5 7 9 11 13 15 17 19 21 23 25 27 29 31 33 35 37 39 41 43
 2 4 6 8 10 12 14 16 18 20 22 24 26 28 30 32 34 36 38 40 42 44
 45 47 49 51 53
 46 48 50 52 54

Selected Unselected Not Available

Cancel Apply

Follow these steps to manually create an IP-MAC Binding entry:

- 1) Enter the following information to specify a host.

Host Name	Enter a host name for identification.
IP Address	Enter the IP address.
MAC Address	Enter the MAC address.
VLAN ID	Enter the VLAN ID.

- 2) Select protect type for the entry.

Protect Type	Select the protect type for the entry. The entry will be applied to to the specific feature. The following options are provided: None: This entry will not be applied to any feature. ARP Detection: This entry will be applied to the ARP Detection feature. IP Source Guard: This entry will be applied to the IPv4 Source Guard feature. Both: This entry will be applied to both of the features.
--------------	---

- 3) Enter or select the port that is connected to this host.
- 4) Click **Apply**.

2.1.2 Binding Entries via ARP Scanning

With ARP Scanning, the switch sends the ARP request packets of the specified IP field to the hosts. Upon receiving the ARP reply packet, the switch can get the IP address, MAC address, VLAN ID and the connected port number of the host. You can bind these entries conveniently.

 **Note:**

Before using this feature, make sure that your network is safe and the hosts are not suffering from ARP attacks at present; otherwise, you may obtain incorrect IP-MAC Binding entries. If your network is being attacked, it's recommended to bind the entries manually.

Choose the menu **SECURITY > IPv4 IMPB > IP-MAC Binding > ARP Scanning** to load the following page.

Figure 2-2 ARP Scanning

Scanning Option

Starting IP Address: (Format: 192.168.0.1)

Ending IP Address: (Format: 192.168.0.1)

VLAN ID: (1-4094)

[Scan](#)

Scanning Result

[-](#) Delete

<input type="checkbox"/>	Host Name	IP Address	MAC Address	VLAN ID	Port	Protect Type
<input checked="" type="checkbox"/>	---	192.168.0.28	c4-6e-1f-bf-72-51	1	1/0/20	None
<input type="checkbox"/>	---	192.168.0.52	00-0a-eb-13-23-7b	1	1/0/20	None
<input type="checkbox"/>	---	192.168.0.73	00-0a-eb-00-13-01	1	1/0/20	None
<input type="checkbox"/>	---	192.168.0.200	00-19-66-35-e1-b0	1	1/0/20	None
<input type="checkbox"/>	---	192.168.0.225	ea-23-51-06-22-52	1	1/0/20	None
<input type="checkbox"/>	---	192.168.0.226	00-0a-eb-13-23-97	1	1/0/20	None
<input type="checkbox"/>	---	192.168.0.253	14-cc-20-00-00-13	1	1/0/20	None

1 entry selected. [Cancel](#) [Bind](#)

Follow these steps to configure IP-MAC Binding via ARP scanning:

- 1) In the **Scanning Option** section, specify an IP address range and a VLAN ID. Then click **Scan** to scan the entries in the specified IP address range and VLAN.

Starting IP Address/Ending IP Address Specify an IP range by entering a starting and ending IP address.

VLAN ID Specify a VLAN ID.

- 2) In the **Scanning Result** section, select one or more entries and configure the relevant parameters. Then click **Bind**.

Host Name Enter a host name for identification.

IP Address Displays the IP address.

MAC Address Displays the MAC address.

VLAN ID Displays the VLAN ID.

Port Displays the port number.

Protect Type	Select the protect type for the entry. The entry will be applied to to the specific feature. The following options are provided: None: This entry will not be applied to any feature. ARP Detection: This entry will be applied to the ARP Detection feature. IP Source Guard: This entry will be applied to the IP Source Guard feature. Both This entry will be applied to both of the features.
---------------------	--

2.1.3 Binding Entries via DHCP Snooping

With DHCP Snooping enabled, the switch can monitor the IP address obtaining process of the host, and record the IP address, MAC address, VLAN ID and the connected port number of the host.

Choose the menu **SECURITY > IPv4 IMPB > IP-MAC Binding > DHCP Snooping** to load the following page.

Figure 2-3 DHCP Snooping

Global Config

DHCP Snooping: Enable Apply

VLAN Config

Filter by VLAN: From To Apply

<input type="checkbox"/>	VLAN ID	Status
<input type="checkbox"/>	1	Disabled
<input type="checkbox"/>	2	Disabled
<input type="checkbox"/>	10	Disabled
<input type="checkbox"/>	20	Disabled
Total: 4		

Showing 1-4 of 4 records Items per page:

Port Config

UNIT1

LAGS

<input type="checkbox"/>	Port	Maximum Entries	Trust	LAG
<input type="checkbox"/>	1/0/1	1024	Enabled	---
<input type="checkbox"/>	1/0/2	1024	Enabled	---
<input type="checkbox"/>	1/0/3	1024	Enabled	---
<input type="checkbox"/>	1/0/4	1024	Enabled	---
<input type="checkbox"/>	1/0/5	1024	Enabled	---
<input type="checkbox"/>	1/0/6	1024	Enabled	---
<input type="checkbox"/>	1/0/7	1024	Enabled	---
<input type="checkbox"/>	1/0/8	1024	Enabled	---
<input type="checkbox"/>	1/0/9	1024	Enabled	---
<input type="checkbox"/>	1/0/10	1024	Enabled	---
Total: 54				

Follow these steps to configure IP-MAC Binding via DHCP Snooping:

- 1) In the **Global Config** section, enable DHCP Snooping globally. Click **Apply**.
- 2) In the **VLAN Config** section, enable DHCP Snooping on a VLAN or range of VLANs. Click **Apply**.

VLAN ID Displays the VLAN ID of the existing VLAN.

Status Enable or disable DHCP snooping on a VLAN.

- 3) In the **Port Config** section, configure the maximum number of binding entries a port can learn via DHCP snooping. Click **Apply**.

Port	Select one or more ports to configure.
Maximum Entries	Configure the maximum number of DHCP binding entries a port can learn via DHCP snooping.
Trust	Configure the trust status of the port. Only trusted port can forward DHCP packets from DHCP Server.
LAG	Displays the LAG that the port belongs to.

- 4) The learned entries will be displayed in the Binding Table. You can go to **SECURITY > IPv4 IMPB > IP-MAC Binding > Binding Table** to view or edit the entries.

2.1.4 Viewing the Binding Entries

In the Binding Table, you can view, search and edit the specified binding entries.

Choose the menu **SECURITY > IPv4 IMPB > IP-MAC Binding > Binding Table** to load the following page.

Figure 2-4 Binding Table

Binding Table

Source:

IP Address: (Format: 192.168.0.1)

<input type="checkbox"/>	Host Name	IP Address	MAC Address	VLAN ID	Port	Protect Type	Source
<input checked="" type="checkbox"/>	--	192.168.0.28	c4-6e-1f-bf-72-51	1	1/0/20	None	ARP Scanning
<input type="checkbox"/>	PC1	192.168.0.98	74-d4-35-76-a4-d8	1	1/0/6	None	Manual Binding

1 entry selected.

You can specify the search criteria to search your desired entries.

Source	Select the source of the entry and click Search . All: Displays the entries from all sources. Manual Binding: Displays the manually bound entries. ARP Scanning: Displays the binding entries learned from ARP Scanning. DHCP Snooping: Displays the binding entries learned from DHCP Snooping.
IP	Enter an IP address and click Search to search the specific entry.

Additionally, you select one or more entries to edit the host name and protect type and click **Apply**.

Host Name	Enter a host name for identification.
IP Address	Displays the IP address.
MAC Address	Displays the MAC address.
VLAN ID	Displays the VLAN ID.
Port	Displays the port number.
Protect Type	<p>Select the protect type for the entry. The entry will be applied to to the specific feature. The following options are provided:</p> <p>None: This entry will not be applied to any feature.</p> <p>ARP Detection: This entry will be applied to the ARP Detection feature.</p> <p>IP Source Guard: This entry will be applied to the IP Source Guard feature.</p> <p>Both: This entry will be applied to both of the features.</p>
Source	Displays the source of the entry.

2.2 Using the CLI

Binding entries via ARP scanning is not supported by the CLI. The following sections introduce how to bind entries manually and via DHCP Snooping and view the binding entries.

2.2.1 Binding Entries Manually

You can manually bind the IP address, MAC address, VLAN ID and the Port number together on the condition that you have got the detailed information of the hosts.

Follow these steps to manually bind entries:

Step 1	<p>configure</p> <p>Enter global configuration mode.</p>
--------	---

Step 2	<p>ip source binding <i>hostname ip-addr mac-addr vlan vlan-id interface { fastEthernet port gigabitEthernet port ten-gigabitEthernet port port-channel port-channel-id } { none arp-detection ip-verify-source both }</i></p> <p>Manually bind the host name, IP address, MAC address, VLAN ID and port number of the host, and configure the protect type for the host.</p> <p><i>hostname</i>: Specify a name for the host. It contains 20 characters at most.</p> <p><i>ip-addr</i>: Enter the IP address of the host.</p> <p><i>mac-addr</i>: Enter the MAC address of the host, in the format of xx:xx:xx:xx:xx:xx.</p> <p><i>vlan-id</i>: Enter the VLAN ID of the host.</p> <p><i>port</i>: Enter the number of the port on which the host is connected.</p> <p><i>none arp-detection ip-verify-source both</i>: Specify the protect type for the entry. None indicates this entry will not be applied to any feature; arp-detection indicates this entry will be applied to ARP Detection; ip-verify-source indicates this entry will be applied to IPv4 Source Guard.</p>
Step 3	<p>show ip source binding</p> <p>Verify the binding entry.</p>
Step 4	<p>end</p> <p>Return to privileged EXEC mode.</p>
Step 5	<p>copy running-config startup-config</p> <p>Save the settings in the configuration file.</p>

The following example shows how to bind an entry with the hostname host1, IP address 192.168.0.55, MAC address 74:d4:35:76:a4:d8, VLAN ID 10, port number 1/0/5, and enable this entry for the ARP detection feature.

Switch#configure

```
Switch(config)#ip source binding host1 192.168.0.55 74:d4:35:76:a4:d8 vlan 10 interface
gigabitEthernet 1/0/5 arp-detection
```

Switch(config)#show ip source binding

U	Host	IP-Addr	MAC-Addr	VID	Port	ACL	SOURCE
-	----	-----	-----	---	----	---	-----
1	host1	192.168.0.55	74:d4:35:76:a4:d8	10	Gi1/0/5	ARP-D	Manual

Notice:

1. Here, 'ARP-D' for 'ARP-Detection', and 'IP-V-S' for 'IP-Verify-Source'.

Switch(config)#end

Switch#copy running-config startup-config

2.2.2 Binding Entries via DHCP Snooping

Follow these steps to bind entries via DHCP Snooping:

Step 1	configure Enter global configuration mode.
Step 2	ip dhcp snooping Globally enable DHCP Snooping.
Step 3	ip dhcp snooping vlan <i>vlan-range</i> Enable DHCP Snooping on the specified VLAN. <i>vlan-range</i> : Enter the vlan range in the format of 1-3, 5.
Step 4	interface { fastEthernet <i>port</i> range fastEthernet <i>port-list</i> gigabitEthernet <i>port</i> range gigabitEthernet <i>port-list</i> ten-gigabitEthernet <i>port</i> range ten-gigabitEthernet <i>port-list</i> interface port-channel <i>port-channel-id</i> interface range port-channel <i>port-channel-id-list</i> } Enter interface configuration mode.
Step 5	ip dhcp snooping max-entries <i>value</i> Configure the maximum number of binding entries the port can learn via DHCP snooping. <i>value</i> : Enter the value of maximum number of entries. The valid values are from 0 to 512.
Step 6	show ip dhcp snooping Verify global configuration of DHCP Snooping.
Step 7	end Return to privileged EXEC mode.
Step 8	copy running-config startup-config Save the settings in the configuration file.

The following example shows how to enable DHCP Snooping globally and on VLAN 5, and set the maximum number of binding entries port 1/0/1 can learn via DHCP snooping as 100:

```
Switch#configure
```

```
Switch(config)#ip dhcp snooping
```

```
Switch(config)#ip dhcp snooping vlan 5
```

```
Switch(config)#interface gigabitEthernet 1/0/1
```

```
Switch(config-if)#ip dhcp snooping max-entries 100
```

```
Switch(config-if)#show ip dhcp snooping
```

```
Global Status: Enable
```

VLAN ID: 5

```
Switch(config-if)#show ip dhcp snooping interface gigabitEthernet 1/0/1
```

```
Interface max-entries LAG
```

```
-----
```

```
Gi1/0/1 100 N/A
```

```
Switch(config-if)#end
```

```
Switch#copy running-config startup-config
```

2.2.3 Viewing Binding Entries

On privileged EXEC mode or any other configuration mode, you can use the following command to view binding entries:

show ip source binding

View the information of binding entries, including the host name, IP address, MAC address, VLAN ID, port number and protect type.

3 ARP Detection Configuration

To complete ARP Detection configuration, follow these steps:

- 1) Add IP-MAC Binding entries.
- 2) Enable ARP Detection.
- 3) Configure ARP Detection on ports.
- 4) View ARP statistics.

3.1 Using the GUI

3.1.1 Adding IP-MAC Binding Entries

In ARP Detection, the switch detects the ARP packets based on the binding entries in the IP-MAC Binding Table. So before configuring ARP Detection, you need to complete IP-MAC Binding configuration. For details, refer to [IP-MAC Binding Configuration](#).

3.1.2 Enabling ARP Detection

Choose the menu **SECURITY > IPv4 IMPB > ARP Detection > Global Config** to load the following page.

Figure 3-1 ARP Detection Global Config

Global Config

ARP Detect: Enable

Validate Source MAC: Enable

Validate Destination MAC: Enable

Validate IP: Enable

Apply

VLAN Config

<input checked="" type="checkbox"/>	VLAN ID	Status	Log Status
<input checked="" type="checkbox"/>	1	Disabled	Disabled

Total: 1 1 entry selected.

Cancel **Apply**

Follow these steps to enable ARP Detection:

- 1) In the **Global Config** section, enable ARP Detection and configure the related parameters. Click **Apply**.

ARP Detect	Enable the ARP Detection function.
Validate Source MAC	Enable or disable the switch to check whether the source MAC address and the sender MAC address are the same when receiving an ARP packet. If not, the ARP packet will be discarded.
Validate Destination MAC	Enable or disable the switch to check whether the destination MAC address and the target MAC address are the same when receiving an ARP reply packet. If not, the ARP packet will be discarded.
Validate IP	Enable or disable the switch to check whether the sender IP address of all ARP packets and the target IP address of ARP reply packets are legal. The illegal packets will be discarded, including broadcast addresses, multicast addresses, Class E addresses, loopback addresses (127.0.0.0/8) and the following address: 0.0.0.0.

2) In the **VLAN Config** section, enable ARP Detection on the selected VLANs. Click **Apply**.

VLAN ID	Displays the VLAN ID.
Status	Enable or disable ARP Detect in a VLAN.
Log Status	Enable or disable Log feature on the VLAN. With this feature enabled, the switch generates a log when an illegal ARP packet is discarded.

3.1.3 Configuring ARP Detection on Ports

Choose the menu **SECURITY > IPv4 IMPB > ARP Detection >Port Config** to load the following page.

Figure 3-2 ARP Detection on Port

Port Config								
UNIT1		LAGS						
<input type="checkbox"/>	Port	Trust Status	Limit Rate pps (0-300 pps)	Current Speed (pps)	Burst Interval seconds (1-15 seconds)	Status	Operation	LAG
<input type="checkbox"/>	1/0/1	Disabled	100	0	1	Normal	---	---
<input type="checkbox"/>	1/0/2	Disabled	100	0	1	Normal	---	---
<input type="checkbox"/>	1/0/3	Disabled	100	0	1	Normal	---	---
<input type="checkbox"/>	1/0/4	Disabled	100	0	1	Normal	---	---
<input type="checkbox"/>	1/0/5	Disabled	100	0	1	Normal	---	---
<input type="checkbox"/>	1/0/6	Disabled	100	0	1	Normal	---	---
<input type="checkbox"/>	1/0/7	Disabled	100	0	1	Normal	---	---
<input type="checkbox"/>	1/0/8	Disabled	100	0	1	Normal	---	---
<input type="checkbox"/>	1/0/9	Disabled	100	0	1	Normal	---	---
<input type="checkbox"/>	1/0/10	Disabled	100	0	1	Normal	---	---
Total: 54								

Follow these steps to configure ARP Detection on ports:

- 1) Select one or more ports and configure the parameters.

Trust Status	Set whether to make this port a trusted port, on which the ARP packets will be forwarded directly without being checked.
Limit Rate	Specify the maximum number of ARP packets that can be received on the port per second.
Current Speed	Displays the current speed of the received ARP packets.
Burst Interval	Specify a time range. If the speed of received ARP packets always exceeds the limit rate in this time range, the port will be shut down.
Status	Displays the status of the port. Normal: The transmission speed of the ARP packet is normal. Down: The transmission speed of the ARP packet exceeds the defined value.
Operation	If Status is changed to Down, there will be a Recover button. You can click the button to restore the port to the normal status.
LAG	Displays the LAG that the port belongs to.

- 2) Click **Apply**.

3.1.4 Viewing ARP Statistics

You can view the number of the forwarded or dropped ARP packets in each VLAN, which facilitates you to locate the network malfunction and take the related protection measures.



Choose the menu **SECURITY > IPv4 IMPB > ARP Detection > ARP Statistics** to load the following page.

Figure 3-3 View ARP Statistics

Auto Refresh

Auto Refresh: Enable **Apply**

ARP Packets

 Refresh  Clear

VLAN ID	Forwarded	Dropped
1	0	0
Total: 1		

In the **Auto Refresh** section, you can enable the auto refresh feature and specify the refresh interval, and thus the web page will be automatically refreshed.

In the **ARP Packets** section, you can view the number of illegal ARP packets in each VLAN.

VLAN ID	Displays the VLAN ID.
Forwarded	Displays the number of forwarded ARP packets in this VLAN.
Dropped	Displays the number of dropped ARP packets in this VLAN.

3.2 Using the CLI

3.2.1 Adding IP-MAC Binding Entries

In ARP Detection, the switch detects the ARP packets based on the binding entries in the IP-MAC Binding Table. So before configuring ARP Detection, you need to complete IP-MAC Binding configuration. For details, refer to [IP-MAC Binding Configuration](#).

3.2.2 Enabling ARP Detection

Follow these steps to enable ARP Detection:

Step 1	<p>configure</p> <p>Enter global configuration mode.</p>
Step 2	<p>ip arp inspection</p> <p>Globally enable the ARP Detection feature.</p>
Step 3	<p>ip arp inspection validate { src-mac dst-mac ip }</p> <p>Configure the switch to check the IP address or MAC address of the received packets.</p> <p>src-mac: Enable the switch to check whether the source MAC address and the sender MAC address are the same when receiving an ARP packet. If not, the ARP packet will be discarded.</p> <p>dst-mac: Enable the switch to check whether the sender IP address of all ARP packets and the target IP address of ARP reply packets are legal. The illegal packets will be discarded.</p> <p>ip: Enable or disable the switch to check whether the sender IP address of all ARP packets and the target IP address of ARP reply packets are legal. The illegal ARP packets will be discarded, including broadcast addresses, multicast addresses, Class E addresses, loopback addresses (127.0.0.0/8) and the following address: 0.0.0.0.</p>
Step 4	<p>ip arp inspection vlan <i>vlan-list</i></p> <p>Enable ARP Detection on one or more 802.1Q VLANs that already exist.</p> <p>vlan-list: Enter the VLAN ID. The format is 1,5-9.</p>

Step 5	ip arp inspection vlan <i>vlan-list</i> logging (Optional) Enable the Log feature to make the switch generate a log when an ARP packet is discarded. <i>vlan-list</i> : Enter the VLAN ID. The format is 1,5-9.
Step 6	show ip arp inspection Verify the ARP Detection configuration.
Step 7	end Return to privileged EXEC mode.
Step 8	copy running-config startup-config Save the settings in the configuration file.

The following example shows how to enable ARP Detection globally and on VLAN 2, and enable the switch to check whether the source MAC address and the sender MAC address are the same when receiving an ARP packet:

Switch#configure

Switch(config)#ip arp inspection

Switch(config)#ip arp inspection validate src-mac

Switch(config)#ip arp inspection vlan 2

Switch(config)#show ip arp inspection

Global Status: Enable

Verify SMAC: Enable

Verify DMAC: Disable

Verify IP: Disable

Switch(config)#show ip arp inspection vlan

VID	Enable status	Log Status
----	-----	-----
1	Disable	Disable
2	Enable	Disable

Switch(config)#end

Switch#copy running-config startup-config

3.2.3 Configuring ARP Detection on Ports

Follow these steps to configure ARP Detection on ports:

Step 1	configure Enter global configuration mode.
Step 2	interface { fastEthernet port range fastEthernet port-list gigabitEthernet port range gigabitEthernet port-list ten-gigabitEthernet port range ten-gigabitEthernet port-list } Enter interface configuration mode.
Step 3	ip arp inspection trust Configure the port as a trusted port, on which the ARP Detection function will not take effect. The specific ports, such as up-linked ports and routing ports are suggested to be set as trusted ports.
Step 4	ip arp inspection limit-rate value Specify the maximum number of the ARP packets can be received on the port per second. <i>value:</i> Specify the limit rate value. The valid values are from 0 to 300 pps (packets/second), and the default value is 100.
Step 5	ip arp inspection burst-interval value Specify a time range. If the speed of received ARP packets reaches the limit for this time range, the port will be shut down. <i>value:</i> Specify the time range. The valid values are from 1 to 15 seconds, and the default value is 1 second.
Step 6	show ip arp inspection interface View the configurations and status of the ports.
Step 7	show ip arp inspection vlan View the configurations and status of the VLANs.
Step 8	ip arp inspection recover (Optional) For ports on which the speed of receiving ARP packets has exceeded the limit, use this command to restore the port from Down status to Normal status.
Step 9	end Return to privileged EXEC mode.
Step 10	copy running-config startup-config Save the settings in the configuration file.

The following example shows how to set port 1/0/2 as a trusted port, and set limit-rate as 20 pps and burst interval as 2 seconds on port 1/0/2:

Switch#configure

Switch(config)#interface gigabitEthernet 1/0/2

Switch(config-if)#ip arp inspection trust

Switch(config-if)#ip arp inspection limit-rate 20

```
Switch(config-if)#ip arp inspection burst-interval 2
```

```
Switch(config-if)#show ip arp inspection interface gigabitEthernet 1/0/2
```

Interface	Trust state	limit Rate(pps)	Current speed(pps)	Burst Interval	Status	LAG
-----	-----	-----	-----	-----	-----	---
Gi1/0/2	Enable	20	0	2	---	N/A

```
Switch(config-if)#end
```

```
Switch#copy running-config startup-config
```

The following example shows how to restore the port 1/0/1 that is in Down status to Normal status:

```
Switch#configure
```

```
Switch(config)#interface gigabitEthernet 1/0/1
```

```
Switch(config-if)#ip arp inspection recover
```

```
Switch(config-if)#end
```

```
Switch#copy running-config startup-config
```

3.2.4 Viewing ARP Statistics

On privileged EXEC mode or any other configuration mode, you can use the following command to view ARP statistics:

show ip arp inspection statistics

View the ARP statistics on each port, including the number of forwarded ARP packets and the number of dropped ARP packets.

4 IPv4 Source Guard Configuration

To complete IPv4 Source Guard configuration, follow these steps:

- 1) Add IP-MAC Binding entries.
- 2) Configure IPv4 Source Guard.

4.1 Using the GUI

4.1.1 Adding IP-MAC Binding Entries

In IPv4 Source Guard, the switch filters the packets that do not match the rules of IPv4-MAC Binding Table. So before configuring ARP Detection, you need to complete IP-MAC Binding configuration. For details, refer to [IP-MAC Binding Configuration](#).

4.1.2 Configuring IPv4 Source Guard

Choose the menu **SECURITY > IPv4 IMPB > IPv4 Source Guard** to load the following page.

Figure 4-1 IPv4 Source Guard Config

Global Config

IPv4 Source Guard Logging: Enable Apply

Port Config

	UNIT1	LAGS		
<input type="checkbox"/>	Port	Security Type	LAG	
<input type="checkbox"/>	1/0/1	Disable	---	
<input type="checkbox"/>	1/0/2	Disable	---	
<input type="checkbox"/>	1/0/3	Disable	---	
<input type="checkbox"/>	1/0/4	Disable	---	
<input type="checkbox"/>	1/0/5	Disable	---	
<input type="checkbox"/>	1/0/6	Disable	---	
<input type="checkbox"/>	1/0/7	Disable	---	
<input type="checkbox"/>	1/0/8	Disable	---	
<input type="checkbox"/>	1/0/9	Disable	---	
<input type="checkbox"/>	1/0/10	Disable	---	

Total: 54

Follow these steps to configure IPv4 Source Guard:

- 1) In the **Global Config** section, choose whether to enable the Log feature. Click **Apply**.

IPv4 Source Guard Log	Enable IPv4 Source Guard Log feature to generate a log when illegal packets are received.
2) In the Port Config section, configure the protect type for ports and click Apply .	
Port	Select one or more ports to configure.
Security Type	<p>Select Security Type on the port for IPv4 packets. The following options are provided:</p> <p>Disable: The IP Source Guard feature is disabled on the port.</p> <p>SIP: Only a packet with its source IP address and port number matching the IPv4-MAC binding rules can be processed, otherwise the packet will be discarded.</p> <p>SIP+MAC: Only a packet with its source IP address, source MAC address and port number matching the IPv4-MAC binding rules can be processed, otherwise the packet will be discarded.</p> <p>Note: SIP is only available on certain devices.</p>
LAG	Displays the LAG that the port belongs to.

4.2 Using the CLI

4.2.1 Adding IP-MAC Binding Entries

In IPv4 Source Guard, the switch filters the packets that do not match the rules of IPv4-MAC Binding Table. So before configuring ARP Detection, you need to complete IP-MAC Binding configuration. For details, refer to [IP-MAC Binding Configuration](#).

4.2.2 Configuring IPv4 Source Guard

Follow these steps to configure IPv4 Source Guard:

Step 1	<p>configure</p> <p>Enter global configuration mode.</p>
Step 2	<p>interface { fastEthernet port range fastEthernet port-list gigabitEthernet port range gigabitEthernet port-list ten-gigabitEthernet port range ten-gigabitEthernet port-list }</p> <p>Enter interface configuration mode.</p>

-
- Step 3 **ip verify source { sip+mac | sip }**
 Enable IP Source Guard for IPv4 packets.
- sip+mac:** Only the packet with its source IP address, source MAC address and port number matching the IP-MAC binding rules can be processed, otherwise the packet will be discarded.
- sip:** Only the packet with its source IP address and port number matching the IP-MAC binding rules can be processed, otherwise the packet will be discarded.
- Note: SIP is only available on certain devices.
-
- Step 4 **show ip verify source [interface { fastEthernet port | gigabitEthernet port | ten-gigabitEthernet port | port-channel port-channel-id }]**
 Verify the IP Source Guard configuration for IPv4 packets.
-
- Step 5 **end**
 Return to privileged EXEC mode.
-
- Step 6 **copy running-config startup-config**
 Save the settings in the configuration file.
-

The following example shows how to enable IPv4 Source Guard on port 1/0/1:

Switch#configure

Switch(config)#interface gigabitEthernet 1/0/1

Switch(config-if)#ip verify source sip+mac

Switch(config-if)#show ip verify source interface gigabitEthernet 1/0/1

Port	Security-Type	LAG
----	-----	----
Gi1/0/1	SIP+MAC	N/A

Switch(config-if)#end

Switch#copy running-config startup-config

5 Configuration Examples

5.1 Example for ARP Detection

5.1.1 Network Requirements

As shown below, User 1 and User 2 are legal users in the LAN and connected to port 1/0/1 and port 1/0/2. Both of them are in the default VLAN 1. The router has been configured with security feature to prevent attacks from the WAN. Now the network administrator wants to configure Switch A to prevent ARP attacks from the LAN.

Figure 5-1 Network Topology

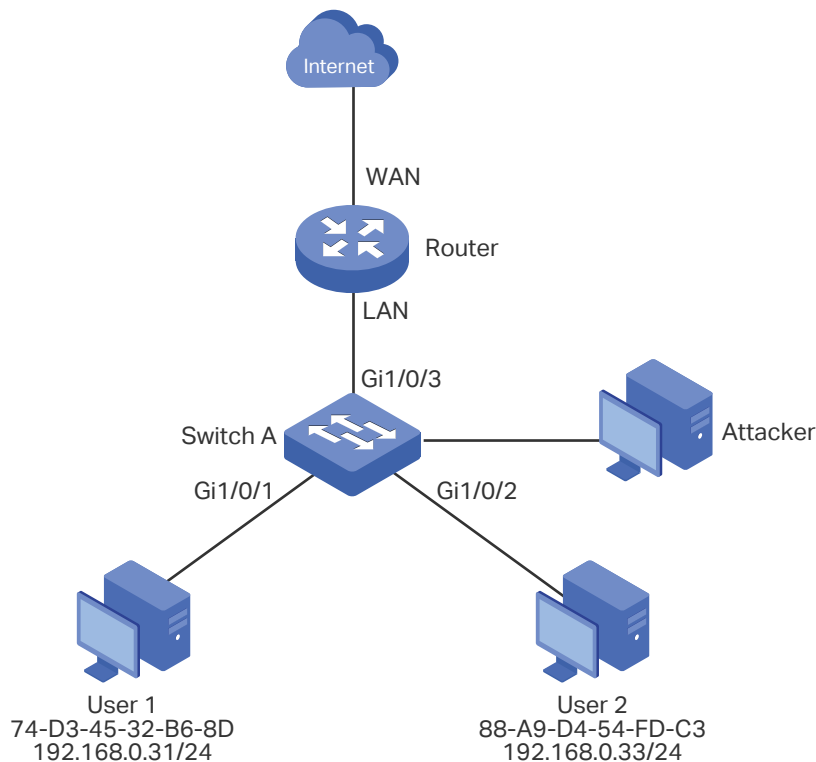

5.1.2 Configuration Scheme

To meet the requirement, you can configure ARP Detection to prevent the network from ARP attacks in the LAN.

The overview of configurations on the switch is as follows:

- 1) Configure IP-MAC Binding. The binding entries for User 1 and User 2 should be manually bound.
- 2) Configure ARP Detection globally.

- 3) Configure ARP Detection on ports. Since port 1/0/3 is connected to the gateway router, set port 1/0/3 as trusted port. To prevent ARP flooding attacks, limit the speed of receiving the legal ARP packets on all ports.

Demonstrated with SG6654XHP, the following sections provide configuration procedure in two ways: using the GUI and using the CLI.

5.1.3 Using the GUI

- 1) Choose the menu **SECURITY > IPv4 IMPB > IP-MAC Binding > Manual Binding** and click **+ Add** to load the following page. Enter the host name, IP address, MAC address and VLAN ID of User 1, select the protect type as ARP Detection, and select port 1/0/1 on the panel. Click **Apply**.

Figure 5-2 Binding Entry for User 1

The screenshot shows the 'IPv4-MAC Binding' configuration page. The form fields are as follows:

- Host Name: User1 (20 characters maximum)
- IP Address: 192.168.0.31 (Format: 192.168.0.1)
- MAC Address: 74-D3-45-32-B6-8D (Format: 00-00-00-00-00-01)
- VLAN ID: 1 (1-4094)
- Protect Type: ARP Detection
- Port: 1/0/1 (Format: 1/0/1, input or choose below)

Below the form is a port grid for UNIT1 and LAGS. Port 1 is selected. The grid shows ports 1 through 54. A legend at the bottom indicates that a blue box represents 'Selected', a white box represents 'Unselected', and a grey box represents 'Not Available'. The 'Apply' button is highlighted in red.

- 2) On the same page, add a binding entry for User 2. Enter the host name, IP address, MAC address and VLAN ID of User 2, select the protect type as ARP Detection, and select port 1/0/2 on the panel. Click **Apply**.

Figure 5-3 Binding Entry for User 2

IPv4-MAC Binding

Host Name: (20 characters maximum)

IP Address: (Format: 192.168.0.1)

MAC Address: (Format: 00-00-00-00-00-01)

VLAN ID: (1-4094)

Protect Type:

Port: (Format: 1/0/1, input or choose below)

UNIT1 LAGS

Grid of ports: 1, 2, 3, 4, 5, 6, 7, 8, 9, 10, 11, 12, 13, 14, 15, 16, 17, 18, 19, 20, 21, 22, 23, 24, 25, 26, 27, 28, 29, 30, 31, 32, 33, 34, 35, 36, 37, 38, 39, 40, 41, 42, 43, 44, 45, 46, 47, 48, 49, 50, 51, 52, 53, 54.

Legend: Selected (blue icon), Unselected (white icon), Not Available (grey icon)

Buttons:

- 3) Choose the menu **SECURITY > IPv4 IMPB > ARP Detection > Global Config** to load the following page. Enable APP Detect, Validate Source MAC, Validate Destination MAC and Validate IP, and click **Apply**. Select VLAN 1, change Status as Enabled and click **Apply**.

Figure 5-4 Enable ARP Detection

Global Config

ARP Detect: Enable

Validate Source MAC: Enable

Validate Destination MAC: Enable

Validate IP: Enable

Buttons:

VLAN Config

<input checked="" type="checkbox"/>	VLAN ID	Status	Log Status
<input checked="" type="checkbox"/>	1	Enabled	Disabled

Total: 1 1 entry selected.

Buttons:

- 4) Choose the menu **SECURITY > IPv4 IMPB > ARP Detection > Port Config** to load the following page. By default, all ports are enabled with ARP Detection and ARP flooding defend. Configure port 1/0/3 as trusted port and keep other defend parameters as default. Click **Apply**.

Figure 5-5 Port Config

Port Config

UNIT1 LAGS

<input type="checkbox"/>	Port	Trust Status	Limit Rate pps (0-300 pps)	Current Speed (pps)	Burst Interval seconds (1-15 seconds)	Status	Operation	LAG
<input type="checkbox"/>	1/0/1	Disabled	100	0	1	Normal	--	--
<input type="checkbox"/>	1/0/2	Disabled	100	0	1	Normal	--	--
<input checked="" type="checkbox"/>	1/0/3	Enabled	100	0	1	Normal	--	--
<input type="checkbox"/>	1/0/4	Disabled	100	0	1	Normal	--	--
<input type="checkbox"/>	1/0/5	Disabled	100	0	1	Normal	--	--
<input type="checkbox"/>	1/0/6	Disabled	100	0	1	Normal	--	--
<input type="checkbox"/>	1/0/7	Disabled	100	0	1	Normal	--	--
<input type="checkbox"/>	1/0/8	Disabled	100	0	1	Normal	--	--
<input type="checkbox"/>	1/0/9	Disabled	100	0	1	Normal	--	--
<input type="checkbox"/>	1/0/10	Disabled	100	0	1	Normal	--	--

Total: 54 1 entry selected.

Cancel Apply

- 5) Click  Save to save the settings.

5.1.4 Using the CLI

- 1) Manually bind the entries for User 1 and User 2.

Switch_A#configure

```
Switch_A(config)#ip source binding User1 192.168.0.31 74:d3:45:32:b6:8d vlan 1
interface gigabitEthernet 1/0/1 arp-detection
```

```
Switch_A(config)#ip source binding User1 192.168.0.32 88:a9:d4:54:fd:c3 vlan 1
interface gigabitEthernet 1/0/2 arp-detection
```

- 2) Enable ARP Detection globally and on VLAN 1.

```
Switch_A(config)#ip arp inspection
```

```
Switch_A(config)#ip arp inspection vlan 1
```

- 3) Configure port 1/0/3 as trusted port.

```
Switch_A(config)#interface gigabitEthernet 1/0/3
```

```
Switch_A(config-if)#ip arp inspection trust
```

```
Switch_A(config-if)#end
```

```
Switch_A#copy running-config startup-config
```

Verify the Configuration

Verify the IP-MAC Binding entries:

Switch_A#show ip source binding

U	Host	IP-Addr	MAC-Addr	VID	Port	ACL	SOURCE
-	----	-----	-----	---	----	---	-----
1	User1	192.168.0.31	74:d3:45:32:b6:8d	1	Gi1/0/1	ARP-D	Manual
1	User2	192.168.0.33	88:a9:d4:54:fd:c3	1	Gi1/0/2	ARP-D	Manual

Notice:

1.Here, 'ARP-D' for 'ARP-Detection',and'IP-V-S' for 'IP-Verify-Source'.

Verify the global configuration of ARP Detection:

Switch_A#show ip arp inspection

Global Status: Enable

Verify SMAC: Enable

Verify DMAC: Enable

Verify IP: Enable

Verify the ARP Detection configuration on VLAN:

Switch_A#show ip arp inspection vlan

VID	Enable status	Log Status
----	-----	-----
1	Enable	Disable

Verify the ARP Detection configuration on ports:

Switch_A#show ip arp inspection interface

Interface	Trust state	limit Rate(pps)	Current speed(pps)	Burst Interval	Status	LAG
-----	-----	-----	-----	-----	-----	---
Gi1/0/1	Disable	100	0	1	---	N/A
Gi1/0/2	Disable	100	0	1	---	N/A
Gi1/0/3	Enable	100	0	1	---	N/A

...

5.2 Example for IP Source Guard

5.2.1 Network Requirements

As shown below, the legal host connects to the switch via port 1/0/1 and belongs to the default VLAN 1. It is required that only the legal host can access the network via port 1/0/1, and other unknown hosts will be blocked when trying to access the network via ports 1/0/1-3.

Figure 5-6 Network Topology

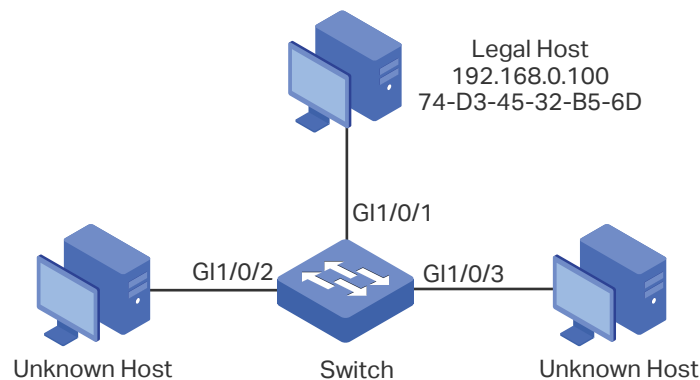

5.2.2 Configuration Scheme

To implement this requirement, you can use IP-MAC Binding and IP Source Guard to filter out the packets received from the unknown hosts. The overview of configuration on the switch is as follows:

- 1) Bind the MAC address, IP address, connected port number and VLAN ID of the legal host with IP-MAC Binding.
- 2) Enable IP Source Guard on ports 1/0/1-3.

Demonstrated with SG6654XHP, the following sections provide configuration procedure in two ways: using the GUI and using the CLI.

5.2.3 Using the GUI

- 1) Choose the menu **SECURITY > IPv4 IMPB > IP-MAC Binding > Manual Binding** and click **+ Add** to load the following page. Enter the host name, IP address, MAC address and VLAN ID of the legal host, select the protect type as IP Source Guard, and select port 1/0/1 on the panel. Click **Apply**.

Figure 5-7 Manual Binding

IPv4-MAC Binding

Host Name: (20 characters maximum)

IP Address: (Format: 192.168.0.1)

MAC Address: (Format: 00-00-00-00-00-01)

VLAN ID: (1-4094)

Protect Type:

Port: (Format: 1/0/1, input or choose below)

UNIT1 LAGS

Selected Unselected Not Available

Cancel Apply

- 2) Choose the menu **SECURITY > IPv4 IMPB > IPv4 Source Guard** to load the following page. Enable IPv4 Source Guard Logging to make the switch generate logs when receiving illegal packets, and click **Apply**. Select ports 1/0/1-3, configure the Security Type as SIP+MAC, and click **Apply**.

Figure 5-8 IPv4 Source Guard

Global Config

IPv4 Source Guard Logging: Enable

Apply

Port Config

UNIT1	LAGS	Port	Security Type	LAG
<input checked="" type="checkbox"/>		1/0/1	SIP+SMAC	---
<input checked="" type="checkbox"/>		1/0/2	SIP+SMAC	---
<input checked="" type="checkbox"/>		1/0/3	SIP+SMAC	---
<input type="checkbox"/>		1/0/4	Disable	---
<input type="checkbox"/>		1/0/5	Disable	---
<input type="checkbox"/>		1/0/6	Disable	---
<input type="checkbox"/>		1/0/7	Disable	---
<input type="checkbox"/>		1/0/8	Disable	---
<input type="checkbox"/>		1/0/9	Disable	---
<input type="checkbox"/>		1/0/10	Disable	---

Total: 54 3 entries selected.

Cancel Apply

- 3) Click  Save to save the settings.

5.2.4 Using the CLI

- 1) Manually bind the IP address, MAC address, VLAN ID and connected port number of the legal host, and apply this entry to the IP Source Guard feature.

```
Switch#configure
```

```
Switch(config)#ip source binding legal-host 192.168.0.100 74:d3:45:32:b5:6d vlan 1
interface gigabitEthernet 1/0/1 ip-verify-source
```

- 2) Enable the log feature and IP Source Guard on ports 1/0/1-3.

```
Switch(config)# ip verify source logging
```

```
Switch(config)# interface range gigabitEthernet 1/0/1-3
```

```
Switch(config-if-range)#ip verify source sip+mac
```

```
Switch(config-if-range)#end
```

```
Switch#copy running-config startup-config
```

Verify the Configuration

Verify the binding entry:

```
Switch#show ip source binding
```

U	Host	IP-Addr	MAC-Addr	VID	Port	ACL	SOURCE
-	----	-----	-----	---	----	---	-----
1	User1	192.168.0.100	74:d3:45:32:b5:6d	1	Gi1/0/1	IP-V-S	Manual

Notice:

1. Here, 'ARP-D' for 'ARP-Detection', and 'IP-V-S' for 'IP-Verify-Source'.

Verify the configuration of IP Source Guard:

```
Switch#show ip verify source
```

```
IP Source Guard log: Enabled
```

Port	Security-Type	LAG
Gi1/0/1	SIP+MAC	N/A
Gi1/0/2	SIP+MAC	N/A
Gi1/0/3	SIP+MAC	N/A

...

6 Appendix: Default Parameters

Default settings of DHCP Snooping are listed in the following table:

Table 6-1 DHCP Snooping

Parameter	Default Setting
Global Config	
DHCP Snooping	Disabled
VLAN Config	
Status	Disabled
Port Config	
Maximum Entry	1024

Default settings of ARP Detection are listed in the following table:

Table 6-2 ARP Detection

Parameter	Default Setting
Global Config	
ARP Detect	Disabled
Validate Source MAC	Disabled
Validate Destination MAC	Disabled
Validate IP	Disabled
VLAN Config	
Status	Disabled
Log Status	Disabled
Port Config	
Trust Status	Disabled
Limit Rate	100 pps

Parameter	Default Setting
Burst Interval	1 second
ARP Statistics	
Auto Refresh	Disabled
Refresh Interval	3 seconds

Default settings of IPv4 Source Guard are listed in the following table:

Table 6-3 ARP Detection

Parameter	Default Setting
Global Config	
IPv4 Source Guard Log:	Disabled
Port Config	
Security Type	Disabled

Part 31

Configuring IPv6 IMPB

CHAPTERS

1. IPv6 IMPB
2. IPv6-MAC Binding Configuration
3. ND Detection Configuration
4. IPv6 Source Guard Configuration
5. Configuration Examples
6. Appendix: Default Parameters

1 IPv6 IMPB

1.1 Overview

IPv6 IMPB (IP-MAC-Port Binding) is used to bind the IPv6 address, MAC address, VLAN ID and the connected port number of the specified host. Basing on the binding table, the switch can prevent ND attacks with the ND Detection feature and filter the packets that don't match the binding entries with the IPv6 Source Guard feature.

1.2 Supported Features

IPv6-MAC Binding

This feature is used to add binding entries. The binding entries can be manually configured, or learned by ND Snooping or DHCPv6 snooping. The features ND Detection and IPv6 Source Guard are based on the IPv6-MAC Binding entries.

ND Detection

Because of the absence of security mechanism, IPv6 ND (Neighbor Discovery) protocol is easy to be exploited by attackers. ND detection feature uses the entries in the IPv6-MAC binding table to filter the forged ND packets and prevent the ND attacks.

The application topology of ND Detection is as the following figure shows. The port that is connected to the gateway should be configured as trusted port, and other ports should be configured as untrusted ports. The forwarding principles of ND packets are as follows:

- All ND packets received on the trusted port will be forwarded without checked.
- RS (Router Solicitation) and NS (Neighbor Solicitation) packets with their source IPv6 addresses unspecified, such as the RS packet for IPv6 address request and the NS packet for duplicate address detection, will not be checked on both kinds of ports.
- RA (Router Advertisement) and RR (Router Redirect) packets received on the untrusted port will be discarded directly, and other ND packets will be checked: The switch will use the IPv6-MAC binding table to compare the IPv6 address, MAC address, VLAN ID and receiving port between the entry and the ND packet. If a match is found, the ND packet is considered legal and will be forwarded; if no match is found, the ND packet is considered illegal and will be discarded.

Figure 1-1 Network Topology of ND Detection

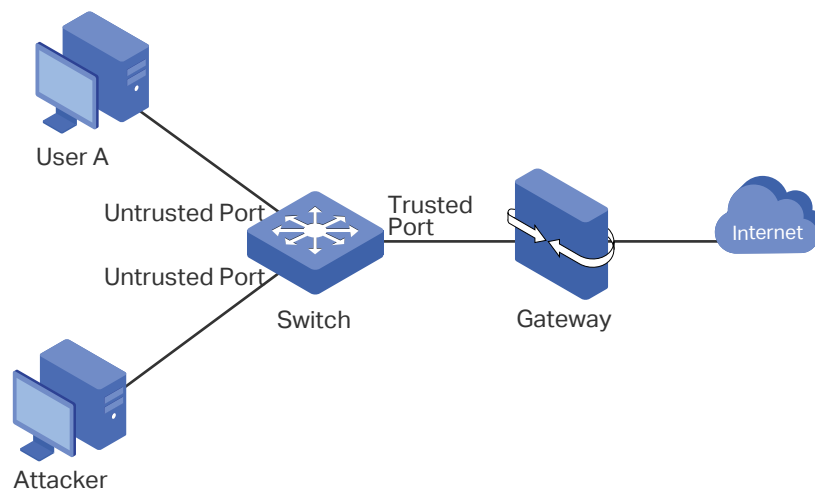

IPv6 Source Guard

IPv6 Source Guard is used to filter the IPv6 packets based on the IPv6-MAC Binding table. Only the packets that match the binding rules are forwarded.

2 IPv6-MAC Binding Configuration

You can add IPv6-MAC Binding entries in three ways:

- Manual Binding
- Via ND Snooping
- Via DHCPv6 Snooping

Additionally, you can view, search and edit the entries in the Binding Table.

2.1 Using the GUI

2.1.1 Binding Entries Manually

You can manually bind the IPv6 address, MAC address, VLAN ID and the Port number together on the condition that you have got the detailed information of the hosts.

Choose the menu **SECURITY > IPv6 IMPB > IPv6-MAC Binding > Manual Binding** and click  **Add** to load the following page.

Figure 2-1 Manual Binding

IP-MAC Binding

Host Name: (20 characters maximum)

IPv6 Address: (Format: 2001::1)

MAC Address: (Format: 00-00-00-00-00-01)

VLAN ID: (1-4094)

Protect Type: None ▼

Port: (Format: 1/0/1, input or choose below)

UNIT1 **LAGS**

1 3 5 7 9 11 13 15 17 19 21 23 25 27 29 31 33 35 37 39 41 43
 2 4 6 8 10 12 14 16 18 20 22 24 26 28 30 32 34 36 38 40 42 44
 45 47 49 51 53
 46 48 50 52 54

Selected Unselected Not Available

Cancel Bind

Follow these steps to manually create an IPv6-MAC Binding entry:

- 1) Enter the following information to specify a host.

Host Name	Enter a host name for identification.
IPv6 Address	Enter the IPv6 address.
MAC Address	Enter the MAC address.
VLAN ID	Enter the VLAN ID.

- 2) Select protect type for the entry.

Protect Type	Select the protect type for the entry. The entry will be applied to to the specific feature. The following options are provided: None: This entry will not be applied to any feature. ND Detection: This entry will be applied to the ND Detection feature. IPv6 Source Guard: This entry will be applied to the IPv6 Source Guard feature. Both: This entry will be applied to both of the features.
--------------	---

- 3) Enter or select the port that is connected to this host.
- 4) Click **Apply**.

2.1.2 Binding Entries via ND Snooping

With ND Snooping, the switch monitors the ND packets, and records the IPv6 addresses, MAC addresses, VLAN IDs and the connected port numbers of the IPv6 hosts. You can bind these entries conveniently.

Note:

Before using this feature, make sure that your network is safe and the hosts are not suffering from ND attacks at present; otherwise, you may obtain incorrect IPv6-MAC Binding entries. If your network is being attacked, it's recommended to bind the entries manually.

Choose the menu **SECURITY > IPv6 IMPB > IPv6-MAC Binding > ND Snooping** to load the following page.

Figure 2-2 ND Snooping

ND Snooping

ND Snooping: Enable Apply

VLAN Config

Filter by VLAN: From To Apply

<input type="checkbox"/>	VLAN ID	Status
<input type="checkbox"/>	1	Disabled
<input type="checkbox"/>	2	Disabled
<input type="checkbox"/>	10	Disabled
<input type="checkbox"/>	20	Disabled
Total: 4		

Showing 1-4 of 4 records Items per page:

Port Config

UNIT1

LAGS

<input type="checkbox"/>	Port	Maximum Entries	LAG
<input type="checkbox"/>	1/0/1	1024	---
<input type="checkbox"/>	1/0/2	1024	---
<input type="checkbox"/>	1/0/3	1024	---
<input type="checkbox"/>	1/0/4	1024	---
<input type="checkbox"/>	1/0/5	1024	---
<input type="checkbox"/>	1/0/6	1024	---
<input type="checkbox"/>	1/0/7	1024	---
<input type="checkbox"/>	1/0/8	1024	---
<input type="checkbox"/>	1/0/9	1024	---
<input type="checkbox"/>	1/0/10	1024	---
Total: 54			

Follow these steps to configure IPv6-MAC Binding via ND Snooping:

- 1) In the **ND Snooping** section, enable ND Snooping and click **Apply**.
- 2) In the **VLAN Config** section, select one or more VLANs and enable ND Snooping. Click **Apply**.

VLAN ID Select one or more VLAN IDs to enable ND Snooping on the VLAN(s).

Status Enable or disable ND Snooping on a VLAN.

- 3) In the **Port Config** section, configure the maximum number of entries a port can learn via ND snooping. Click **Apply**.

Port	Displays the port number.
Maximum Entries	Configure the maximum number of ND binding entries a port can learn via ND Snooping.
LAG	Displays the LAG that the port belongs to.

4) The learned entries will be displayed in the Binding Table. You can go to **SECURITY > IPv6 IMPB > IPv6-MAC Binding > Binding Table** to view or edit the entries.

2.1.3 Binding Entries via DHCPv6 Snooping

With DHCPv6 Snooping enabled, the switch can monitor the IP address obtaining process of the host, and record the IPv6 address, MAC address, VLAN ID and the connected port number of the host.

Choose the menu **SECURITY > IPv6 IMPB > IPv6-MAC Binding > DHCPv6 Snooping** to load the following page.

Figure 2-3 DHCPv6 Snooping

Global Config

DHCPv6 Snooping: Enable Apply

VLAN Config

Filter by VLAN: From To Apply

<input type="checkbox"/>	VLAN ID	Status
<input type="checkbox"/>	1	Disabled
<input type="checkbox"/>	2	Disabled
<input type="checkbox"/>	10	Disabled
<input type="checkbox"/>	20	Disabled
Total: 4		

Showing 1-4 of 4 records Items per page:

Port Config

UNIT1

LAGS

<input type="checkbox"/>	Port	Maximum Entries	LAG
<input type="checkbox"/>	1/0/1	1024	--
<input type="checkbox"/>	1/0/2	1024	--
<input type="checkbox"/>	1/0/3	1024	--
<input type="checkbox"/>	1/0/4	1024	--
<input type="checkbox"/>	1/0/5	1024	--
<input type="checkbox"/>	1/0/6	1024	--
<input type="checkbox"/>	1/0/7	1024	--
<input type="checkbox"/>	1/0/8	1024	--
<input type="checkbox"/>	1/0/9	1024	--
<input type="checkbox"/>	1/0/10	1024	--
Total: 54			

Follow these steps to configure IPv6-MAC Binding via DHCPv6 Snooping:

- 1) In the **Global Config** section, globally enable DHCPv6 Snooping. Click **Apply**.
- 2) In the **VLAN Config** section, enable DHCPv6 Snooping on a VLAN or range of VLANs. Click **Apply**.

VLAN ID Select one or more VLAN IDs to enable DHCPv6 Snooping on the VLAN(s).

Status Enable or disable DHCPv6 Snooping on a VLAN.

- 3) In the **Port Config** section, configure the maximum number of binding entries a port can learn via DHCPv6 snooping. Click **Apply**.

Port Displays the port number.

Maximum Entries Configure the maximum number of DHCPv6 binding entries a port can learn via DHCPv6 Snooping.

LAG Displays the LAG that the port belongs to.

- 4) The learned entries will be displayed in the Binding Table. You can go to **SECURITY > IPv6 IMPB > IPv6-MAC Binding > Binding Table** to view or edit the entries.

2.1.4 Viewing the Binding Entries

In the Binding Table, you can view, search and edit the specified binding entries.

Choose the menu **SECURITY > IPv6 IMPB > IPv6-MAC Binding > Binding Table** to load the following page.

Figure 2-4 Binding Table

Binding Table

Source:

IP Address: (Format: 192.168.0.1)

<input type="checkbox"/>	Host Name	IP Address	MAC Address	VLAN ID	Port	Protect Type	Source
<input checked="" type="checkbox"/>	--	192.168.0.28	c4-6e-1f-bf-72-51	1	1/0/20	None	ARP Scanning
<input type="checkbox"/>	PC1	192.168.0.98	74-d4-35-76-a4-d8	1	1/0/6	None	Manual Binding

1 entry selected.

You can specify the search criteria to search your desired entries.

Source	Select the source of the entry and click Search . All: Displays the entries from all sources. Manual Binding: Displays the manually bound entries. ND Snooping: Displays the binding entries learned from ND Snooping. DHCPv6 Snooping: Displays the binding entries learned from DHCP Snooping.
IP	Enter an IP address and click Search to search the specific entry.

Additionally, you select one or more entries to edit the host name and protect type and click **Apply**.

Host Name	Enter a host name for identification.
IP Address	Displays the IPv6 address.
MAC Address	Displays the MAC address.
VLAN ID	Displays the VLAN ID.
Port	Displays the port number.
Protect Type	Select the protect type for the entry. The entry will be applied to to the specific feature. The following options are provided: None: This entry will not be applied to any feature. ND Detection: This entry will be applied to the ND Detection feature. IPv6 Source Guard: This entry will be applied to the IP Source Guard feature. Both: This entry will be applied to both of the features.
Source	Displays the source of the entry.

2.2 Using the CLI

The following sections introduce how to bind entries manually and via ND Snooping and DHCP Snooping, and how to view the binding entries.

2.2.1 Binding Entries Manually

You can manually bind the IPv6 address, MAC address, VLAN ID and the Port number together on the condition that you have got the detailed information of the hosts.

Follow these steps to manually bind entries:

Step 1	configure Enter global configuration mode.
Step 2	ipv6 source binding <i>hostname ipv6-addr mac-addr</i> vlan <i>vlan-id</i> interface { fastEthernet port gigabitEthernet port ten-gigabitEthernet port port-channel port-channel-id } { none nd-detection ipv6-verify-source both } Manually bind the host name, IP address, MAC address, VLAN ID and port number of the host, and configure the protect type for the host. <i>hostname</i> : Specify a name for the host. It contains 20 characters at most. <i>ipv6-addr</i> : Enter the IPv6 address of the host. <i>mac-addr</i> : Enter the MAC address of the host, in the format of xx:xx:xx:xx:xx:xx. <i>vlan-id</i> : Enter the VLAN ID of the host. <i>port</i> : Enter the number of the port on which the host is connected. none nd-detection ipv6-verify-source both : Specify the protect type for the entry. None indicates this entry will not be applied to any feature; nd-detection indicates this entry will be applied to ND Detection; ipv6-verify-source indicates this entry will be applied to IP Source Guard; both indicates this entry will be applied to both ND Detection and IP Source Guard.
Step 3	show ip source binding Verify the binding entry.
Step 4	end Return to privileged EXEC mode.
Step 5	copy running-config startup-config Save the settings in the configuration file.

The following example shows how to bind an entry with the hostname host1, IPv6 address 2001:0:9d38:90d5::34, MAC address AA-BB-CC-DD-EE-FF, VLAN ID 10, port number 1/0/5, and enable this entry for ND Detection.

Switch#configure

```
Switch(config)#ipv6 source binding host1 2001:0:9d38:90d5::34 aa:bb:cc:dd:ee:ff vlan 10
interface gigabitEthernet 1/0/5 nd-detection
```

Switch(config)#show ipv6 source binding

U	Host	IP-Addr	MAC-Addr	VID	Port	ACL	Source
-	----	-----	-----	---	----	---	-----
1	host1	2001:0:9d38:90d5::34	aa:bb:cc:dd:ee:ff	10	Gi1/0/5	ND-D	Manual

Switch(config)#end

Switch#copy running-config startup-config

2.2.2 Binding Entries via ND Snooping

Follow these steps to bind entries via ND Snooping:

Step 1	configure Enter global configuration mode.
Step 2	ipv6 nd snooping Globally enable ND Snooping.
Step 3	ipv6 nd snooping vlan <i>vlan-range</i> Enable ND Snooping on the specified VLAN. <i>vlan-range</i> : Enter the vlan range in the format of 1-3, 5.
Step 4	interface { fastEthernet <i>port</i> range fastEthernet <i>port-list</i> gigabitEthernet <i>port</i> range gigabitEthernet <i>port-list</i> ten-gigabitEthernet <i>port</i> range ten-gigabitEthernet <i>port-list</i>} Enter interface configuration mode.
Step 5	ipv6 nd snooping max-entries <i>value</i> Configure the maximum number of ND binding entries a port can learn via ND snooping. <i>value</i> : Enter the maximum number of ND binding entries a port can learn via ND snooping. The valid values are from 0 to 1024, and the default is 1024.
Step 6	show ipv6 nd snooping Verify the global configuration of IPv6 ND Snooping
Step 7	show ipv6 nd snooping interface { fastEthernet <i>port</i> gigabitEthernet <i>port</i> ten-gigabitEthernet <i>port</i> } Verify the IPv6 ND Snooping configuration of the specific port.
Step 8	end Return to privileged EXEC mode.
Step 9	copy running-config startup-config Save the settings in the configuration file.

The following example shows how to enable ND Snooping globally and on VLAN 1.

```
Switch#configure
```

```
Switch(config)#ipv6 nd snooping
```

```
Switch(config)#ipv6 nd snooping vlan 1
```

```
Switch(config)#show ipv6 nd snooping
```

```
Global Status: Enable
```

```
VLAN ID: 1
```

```
Switch(config)#end
```

```
Switch#copy running-config startup-config
```

The following example shows how to configure the maximum number of entries that can be learned on port 1/0/1:

```
Switch#configure
```

```
Switch(config)#interface gigabitEthernet 1/0/1
```

```
Switch(config-if)#ipv6 nd snooping max-entries 1000
```

```
Switch(config-if)#show ipv6 nd snooping interface gigabitEthernet 1/0/1
```

```
Interface  max-entries  LAG
-----  -
Gi1/0/1    1000             N/A
```

```
Switch(config-if)#end
```

```
Switch#copy running-config startup-config
```

2.2.3 Binding Entries via DHCPv6 Snooping

Follow these steps to bind entries via DHCP Snooping:

Step 1	configure Enter global configuration mode.
Step 2	ipv6 dhcp snooping Globally enable DHCPv6 Snooping.
Step 3	ipv6 dhcp snooping vlan <i>vlan-range</i> Enable DHCPv6 Snooping on the specified VLAN. <i>vlan-range</i> : Enter the vlan range in the format of 1-3, 5.
Step 4	interface { fastEthernet <i>port</i> range fastEthernet <i>port-list</i> gigabitEthernet <i>port</i> range gigabitEthernet <i>port-list</i> ten-gigabitEthernet <i>port</i> range ten-gigabitEthernet <i>port-list</i> interface port-channel <i>port-channel-id</i> interface range port-channel <i>port-channel-id-list</i> } Enter interface configuration mode.
Step 5	ipv6 dhcp snooping max-entries <i>value</i> Configure the maximum number of binding entries the port can learn via DHCPv6 snooping. <i>value</i> : Enter the value of maximum number of entries. The valid values are from 0 to 512.
Step 6	show ip dhcp snooping Verify global configuration of DHCPv6 Snooping.

Step 7	end Return to privileged EXEC mode.
Step 8	copy running-config startup-config Save the settings in the configuration file.

The following example shows how to enable DHCPv6 Snooping globally and on VLAN 5, and set the maximum number of binding entries port 1/0/1 can learn via DHCPv6 snooping as 100:

Switch#configure

Switch(config)#ipv6 dhcp snooping

Switch(config)#ipv6 dhcp snooping vlan 5

Switch(config)#interface gigabitEthernet 1/0/1

Switch(config-if)#ipv6 dhcp snooping max-entries 100

Switch(config-if)#show ipv6 dhcp snooping

Global Status: Enable

VLAN ID: 5

Switch(config-if)#show ipv6 dhcp snooping interface gigabitEthernet 1/0/1

Interface max-entries LAG

-----	-----	---
Gi1/0/1	100	N/A

Switch(config-if)#end

Switch#copy running-config startup-config

2.2.4 Viewing Binding Entries

On privileged EXEC mode or any other configuration mode, you can use the following command to view binding entries:

show ipv6 source binding

View the information of binding entries, including the host name, IP address, MAC address, VLAN ID, port number and protect type.

3 ND Detection Configuration

To complete ND Detection configuration, follow these steps:

- 1) Add IPv6-MAC Binding entries.
- 2) Enable ND Detection.
- 3) Configure ND Detection on ports.
- 4) View ND statistics.

3.1 Using the GUI

3.1.1 Adding IPv6-MAC Binding Entries

The ND Detection feature allows the switch to detect the ND packets based on the binding entries in the IPv6-MAC Binding Table and filter out the illegal ND packets. Before configuring ND Detection, complete IPv6-MAC Binding configuration. For details, refer to [IPv6-MAC Binding Configuration](#).

3.1.2 Enabling ND Detection

Choose the menu **SECURITY > IPv6 IMPB > ND Detection > Global Config** to load the following page.

Figure 3-1 ND Detection Global Config

<input type="checkbox"/>	VLAN ID	Status	Log Status
<input checked="" type="checkbox"/>	1	Disabled	Disabled
<input type="checkbox"/>	8	Disabled	Disabled
Total: 2		1 entry selected.	

Follow these steps to enable ND Detection:

- 1) In the **Global Config** section, enable ND Detection and configure the related parameters. Click **Apply**.

ND Detection Enable the ND Detection function.

- 2) In the **VLAN Config** section, enable ND Detection on the selected VLANs. Click **Apply**.

VLAN ID	Displays the VLAN ID.
Status	Enable or disable ND Detection in a VLAN.
Log Status	Enable the Log feature to generate a log when a ND packet is discarded.

3.1.3 Configuring ND Detection on Ports

Choose the menu **SECURITY > IPv6 IMPB > ND Detection >Port Config** to load the following page.

Figure 3-2 ND Detection on Port

Port Config			
UNIT1		LAGS	
<input type="checkbox"/>	Port	Trust Status	LAG
<input type="checkbox"/>	1/0/1	Disabled	---
<input type="checkbox"/>	1/0/2	Disabled	---
<input type="checkbox"/>	1/0/3	Disabled	---
<input type="checkbox"/>	1/0/4	Disabled	---
<input type="checkbox"/>	1/0/5	Disabled	---
<input type="checkbox"/>	1/0/6	Disabled	---
<input type="checkbox"/>	1/0/7	Disabled	---
<input type="checkbox"/>	1/0/8	Disabled	---
<input type="checkbox"/>	1/0/9	Disabled	---
<input type="checkbox"/>	1/0/10	Disabled	---
Total: 54			

Follow these steps to configure ND Detection on ports:

- 1) Select one or more ports and configure the parameters.

Port	Select one or more ports to configure.
Trust Status	Set whether to make this port a trusted port, on which the ND packets will be forwarded directly without checked.
LAG	Displays the LAG that the port belongs to.

- 2) Click **Apply**.

3.1.4 Viewing ND Statistics

You can view the number of the illegal ND packets received on each port, which facilitates you to locate the network malfunction and take the related protection measures.



Choose the menu **SECURITY > IPv6 IMPB > ND Detection > ND Statistics** to load the following page.

Figure 3-3 View ND Statistics

Auto Refresh

Auto Refresh: Enable Apply

Illegal ND Packets

 Refresh
 Clear

VLAN ID	Forwarded	Dropped
1	0	0
8	0	0
Total: 2		

In the **Auto Refresh** section, you can enable the auto refresh feature and specify the refresh interval, and thus the web page will be automatically refreshed.

In the **Illegal ND Packet** section, you can view the number of illegal ND packets in each VLAN.

VLAN ID	Displays the VLAN ID.
Forwarded	Displays the number of forwarded ND packets in this VLAN.
Dropped	Displays the number of dropped ND packets in this VLAN.

3.2 Using the CLI

3.2.1 Adding IPv6-MAC Binding Entries

The ND Detection feature allows the switch to detect the ND packets based on the binding entries in the IPv6-MAC Binding Table and filter out the illegal ND packets. Before configuring ND Detection, complete IPv6-MAC Binding configuration. For details, refer to [IPv6-MAC Binding Configuration](#).

3.2.2 Enabling ND Detection

Follow these steps to enable ND Detection:

Step 1	<p>configure</p> <p>Enter global configuration mode.</p>
Step 2	<p>ipv6 nd detection</p> <p>Globally enable the ND Detection feature.</p>

-
- Step 3 **ipv6 nd detection vlan *vlan-range***
 Enable ND Detection on the specified VLAN.
vlan-range: Enter the vlan range in the format of 1-3, 5.
-
- Step 4 **ipv6 nd detection vlan *vlan-range* logging**
 (Optional) Enable the Log feature to make the switch generate a log when an ND packet is discarded.
vlan-range: Enter the vlan range in the format of 1-3, 5.
-
- Step 5 **show ipv6 nd detection**
 Verify the global ND Detection configuration.
-
- Step 6 **end**
 Return to privileged EXEC mode.
-
- Step 7 **copy running-config startup-config**
 Save the settings in the configuration file.
-

The following example shows how to enable ND Detection globally and on VLAN 1:

Switch#configure

Switch(config)#ipv6 nd detection

Switch(config)#ipv6 nd detection vlan 1

Switch(config)#show ipv6 nd detection

Global Status: Enable

Switch(config)#show ipv6 nd detection vlan

VID	Enable status	Log Status
----	-----	-----
1	Enable	Disable

Switch(config)#end

Switch#copy running-config startup-config

3.2.3 Configuring ND Detection on Ports

Follow these steps to configure ND Detection on ports:

-
- Step 1 **configure**
 Enter global configuration mode.
-

Step 2	interface { fastEthernet port range fastEthernet port-list gigabitEthernet port range gigabitEthernet port-list ten-gigabitEthernet port range ten-gigabitEthernet port-list } Enter interface configuration mode.
Step 3	ipv6 nd detection trust Configure the port as a trusted port, on which the ND packets will not be checked. The specific ports, such as up-linked ports and routing ports are suggested to be set as trusted ports.
Step 4	show ipv6 nd detection interface { fastEthernet port gigabitEthernet port ten-gigabitEthernet port port-channel port-channel-id } Verify the global ND Detection configuration of the port.
Step 5	end Return to privileged EXEC mode.
Step 6	copy running-config startup-config Save the settings in the configuration file.

The following example shows how to configure port 1/0/1 as trusted port:

Switch#configure

Switch(config)#interface gigabitEthernet 1/0/1

Switch(config-if)#ipv6 nd detection trust

Switch(config-if)#show ipv6 nd detection interface gigabitEthernet 1/0/1

```
Interface Trusted LAG
```

```
-----
```

```
Gi1/0/1 Enable N/A
```

Switch(config-if)#end

Switch#copy running-config startup-config

3.2.4 Viewing ND Statistics

On privileged EXEC mode or any other configuration mode, you can use the following command to view ND statistics:

show ipv6 nd detection statistics

View the ND statistics on each port, including the number of forwarded ND packets and the number of dropped ND packets.

4 IPv6 Source Guard Configuration

To complete IPv6 Source Guard configuration, follow these steps:

- 1) Add IP-MAC Binding entries.
- 2) Configure IPv6 Source Guard.

4.1 Using the GUI

4.1.1 Adding IPv6-MAC Binding Entries

The ND Detection feature allows the switch to detect the ND packets based on the binding entries in the IPv6-MAC Binding Table and filter out the illegal ND packets. Before configuring ND Detection, complete IPv6-MAC Binding configuration. For details, refer to [IPv6-MAC Binding Configuration](#).

4.1.2 Configuring IPv6 Source Guard

Before configuring IPv6 Source Guard, you need to configure the SDM template as EnterpriseV6.

Choose the menu **SECURITY > IPv6 IMPB > IPv6 Source Guard** to load the following page.

Figure 4-1 IPv6 Source Guard Config

<input type="checkbox"/>	Port	Security Type	LAG
<input type="checkbox"/>	1/0/1	Disable	--
<input type="checkbox"/>	1/0/2	Disable	--
<input type="checkbox"/>	1/0/3	Disable	--
<input type="checkbox"/>	1/0/4	Disable	--
<input type="checkbox"/>	1/0/5	Disable	--
<input type="checkbox"/>	1/0/6	Disable	--
<input type="checkbox"/>	1/0/7	Disable	--
<input type="checkbox"/>	1/0/8	Disable	--
<input type="checkbox"/>	1/0/9	Disable	--
<input type="checkbox"/>	1/0/10	Disable	--

Total: 54

Follow these steps to configure IPv6 Source Guard:

- 1) Select one or more ports and configure the protect type for ports.

Port	Displays the port number.
Security Type	<p>Select Security Type on the port for IPv6 packets. The following options are provided:</p> <p>Disable: The IP Source Guard feature is disabled on the port.</p> <p>SIPv6+MAC: Only the packet with its source IPv6 address, source MAC address and port number matching the IPv6-MAC binding rules can be processed, otherwise the packet will be discarded.</p> <p>SIPv6: Only the packet with its source IPv6 address and port number matching the IPv6-MAC binding rules can be processed, otherwise the packet will be discarded.</p>
LAG	Displays the LAG that the port belongs to.

2) Click **Apply**.

4.2 Using the CLI

4.2.1 Adding IPv6-MAC Binding Entries

The ND Detection feature allows the switch to detect the ND packets based on the binding entries in the IPv6-MAC Binding Table and filter out the illegal ND packets. Before configuring ND Detection, complete IPv6-MAC Binding configuration. For details, refer to [IPv6-MAC Binding Configuration](#).

4.2.2 Configuring IPv6 Source Guard

Before configuring IPv6 Source Guard, you need to configure the SDM template as EnterpriseV6.

Follow these steps to configure IPv6 Source Guard:

Step 1	<p>configure</p> <p>Enter global configuration mode.</p>
Step 2	<p>interface { fastEthernet port range fastEthernet port-list gigabitEthernet port range gigabitEthernet port-list ten-gigabitEthernet port range ten-gigabitEthernet port-list }</p> <p>Enter interface configuration mode.</p>
Step 3	<p>ipv6 verify source { sipv6+mac sipv6 }</p> <p>Enable IPv6 Source Guard for IPv6 packets.</p> <p>sipv6+mac: Only the packet with its source IPv6 address, source MAC address and port number matching the IPv6-MAC binding rules can be processed, otherwise the packet will be discarded.</p> <p>sipv6: Only the packet with its source IPv6 address and port number matching the IPv6-MAC binding rules can be processed, otherwise the packet will be discarded.</p>

Step 4 **show ipv6 verify source [interface { fastEthernet port | gigabitEthernet port | ten-gigabitEthernet port | port-channel port-channel-id }]**

Verify the IP Source Guard configuration for IPv6 packets.

Step 5 **end**

Return to privileged EXEC mode.

Step 6 **copy running-config startup-config**

Save the settings in the configuration file.

The following example shows how to enable IPv6 Source Guard on port 1/0/1:

Switch#configure

Switch(config)#interface gigabitEthernet 1/0/1

Switch(config-if)#ipv6 verify source sipv6+mac

Switch(config-if)#show ipv6 verify source interface gigabitEthernet 1/0/1

Port	Security-Type	LAG
----	-----	----
Gi1/0/1	SIPv6+MAC	N/A

Switch(config-if)#end

Switch#copy running-config startup-config

5 Configuration Examples

5.1 Example for ND Detection

5.1.1 Network Requirements

As shown below, User 1 and User 2 are legal IPv6 users in the LAN and connected to port 1/0/1 and port 1/0/2. Both of them are in the default VLAN 1. The router has been configured with security feature to prevent attacks from the WAN. Now the network administrator wants to configure Switch A to prevent ND attacks from the LAN.

Figure 5-1 Network Topology

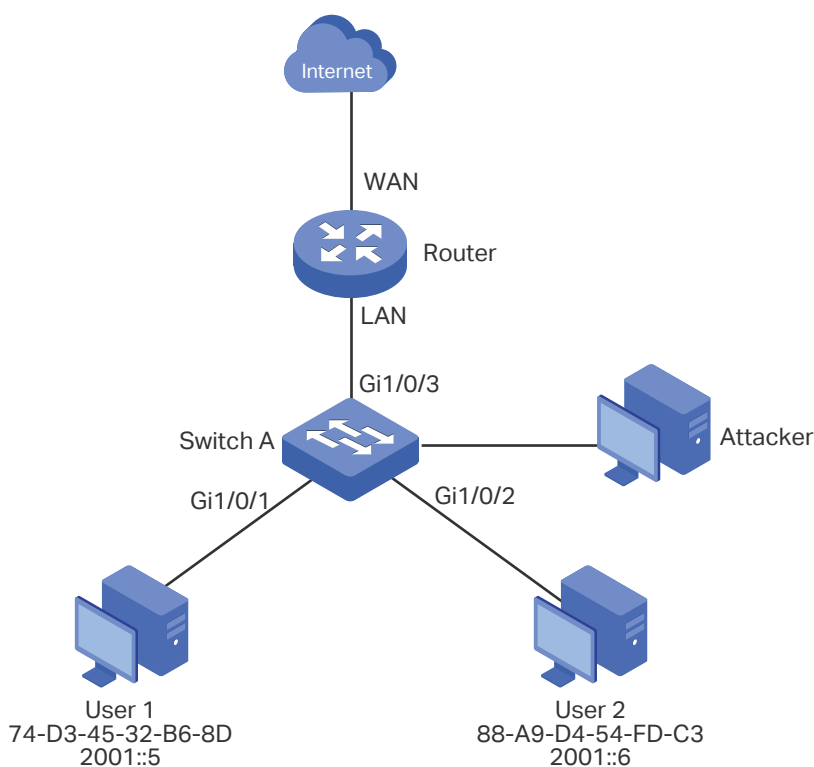

5.1.2 Configuration Scheme

To meet the requirement, you can configure ND Detection to prevent the network from ND attacks in the LAN.

The overview of configurations on the switch is as follows:

- 1) Configure IPv6-MAC Binding. The binding entries for User 1 and User 2 should be manually bound.
- 2) Configure ND Detection globally.

- 3) Configure ND Detection on ports. Since port 1/0/3 is connected to the gateway router, set port 1/0/3 as trusted port.

Demonstrated with SG6654XHP, the following sections provide configuration procedure in two ways: using the GUI and using the CLI.

5.1.3 Using the GUI

- 1) Choose the menu **SECURITY > IPv6 IMPB > IPv6-MAC Binding > Manual Binding** and click **+ Add** to load the following page. Enter the host name, IPv6 address, MAC address and VLAN ID of User 1, select the protect type as ND Detection, and select port 1/0/1 on the panel. Click **Apply**.

Figure 5-2 Binding Entry for User 1

The screenshot displays the 'IP-MAC Binding' configuration page. The form contains the following fields and values:

- Host Name: User1 (20 characters maximum)
- IPv6 Address: 2001::5 (Format: 2001::1)
- MAC Address: 74-D3-45-32-B6-8D (Format: 00-00-00-00-00-01)
- VLAN ID: 1 (1-4094)
- Protect Type: ND Detection
- Port: 1/0/1 (Format: 1/0/1, input or choose below)

Below the form is a port selection grid. The grid is organized into 'UNIT1' and 'LAGS' sections. The 'UNIT1' section shows ports 1 through 44, with port 1 highlighted in blue to indicate it is selected. The 'LAGS' section shows ports 45 through 54. A legend at the bottom indicates that a blue icon represents 'Selected', a white icon represents 'Unselected', and a grey icon represents 'Not Available'. The 'Bind' button at the bottom right is highlighted with a red box.

- 2) In the same way, add a binding entry for User 2. Enter the host name, IPv6 address, MAC address and VLAN ID of User 2, select the protect type as ND Detection, and select port 1/0/2 on the panel. Click **Apply**.

Figure 5-3 Binding Entry for User 2

IP-MAC Binding

Host Name: (20 characters maximum)

IPv6 Address: (Format: 2001::1)

MAC Address: (Format: 00-00-00-00-00-01)

VLAN ID: (1-4094)

Protect Type:

Port: (Format: 1/0/1, input or choose below)

UNIT1 LAGS

1 3 5 7 9 11 13 15 17 19 21 23 25 27 29 31 33 35 37 39 41 43

2 4 6 8 10 12 14 16 18 20 22 24 26 28 30 32 34 36 38 40 42 44

45 47 49 51 53

46 48 50 52 54

Selected Unselected Not Available

- 3) Choose the menu **SECURITY > IPv6 IMBP > ND Detection > Global Config** to load the following page. Enable ND Detection and click **Apply**. Select VLAN 1, change Status as Enabled and click **Apply**.

Figure 5-4 Enable ND Detection

Global Config

ND Detection: Enable

VLAN Config

<input checked="" type="checkbox"/>	VLAN ID	Status	Log Status
<input checked="" type="checkbox"/>	1	Enabled	Disabled

Total: 1 1 entry selected.

- 4) Choose the menu **SECURITY > IPv6 IMBP > ND Detection > Port Config** to load the following page. By default, all ports are enabled with ND Detection. Since port 1/0/3 is connected to the gateway router, configure port 1/0/3 as trusted port. Click **Apply**.

Figure 5-5 Port Config

Port Config

UNIT1 LAGS

<input type="checkbox"/>	Port	Trust Status	LAG
<input type="checkbox"/>	1/0/1	Disabled	---
<input type="checkbox"/>	1/0/2	Disabled	---
<input checked="" type="checkbox"/>	1/0/3	Enabled	---
<input type="checkbox"/>	1/0/4	Disabled	---
<input type="checkbox"/>	1/0/5	Disabled	---
<input type="checkbox"/>	1/0/6	Disabled	---
<input type="checkbox"/>	1/0/7	Disabled	---
<input type="checkbox"/>	1/0/8	Disabled	---
<input type="checkbox"/>	1/0/9	Disabled	---
<input type="checkbox"/>	1/0/10	Disabled	---

Total: 54 1 entry selected. Cancel Apply

- 5) Click  Save to save the settings.

5.1.4 Using the CLI

- 1) Manually bind the entries for User 1 and User 2.

```
Switch_A#configure
```

```
Switch_A(config)#ipv6 source binding User1 2001::5 74:d3:45:32:b6:8d vlan 1 interface
gigabitEthernet 1/0/1 nd-detection
```

```
Switch_A(config)#ip source binding User1 2001::6 88:a9:d4:54:fd:c3 vlan 1 interface
gigabitEthernet 1/0/2 nd-detection
```

- 2) Enable ND Detection globally and on VLAN 1.

```
Switch_A(config)#ipv6 nd detection vlan 1
```

- 3) Configure port 1/0/3 as trusted port.

```
Switch_A(config)#interface gigabitEthernet 1/0/3
```

```
Switch_A(config-if)#ipv6 nd detection trust
```

```
Switch_A(config-if)#end
```

```
Switch_A#copy running-config startup-config
```

Verify the Configuration

Verify the IPv6-MAC Binding entries:

```
Switch_A#show ipv6 source binding
```

U	Host	IP-Addr	MAC-Addr	VID	Port	ACL	SOURCE
-	----	-----	-----	---	----	---	-----
1	User1	2001::5	74:d3:45:32:b6:8d	1	Gi1/0/1	ND-D	Manual
1	User2	2001::6	88:a9:d4:54:fd:c3	1	Gi1/0/2	ND-D	Manual

Notice:

1.Here, 'ND-D' for 'ND-Detection',and'IP-V-S' for 'IP-Verify-Source'.

Verify the global configuration of ND Detection:

```
Switch_A#show ipv6 nd detection
```

Global Status: Enable

Verify the ND Detection configuration on VLAN:

```
Switch_A#show ipv6 nd detection vlan
```

VID	Enable status	Log Status
----	-----	-----
1	Enable	Disable

Verify the ND Detection configuration on ports:

```
Switch_A#show ipv6 nd detection interface
```

Interface	Trusted	LAG
-----	-----	---
Gi1/0/1	Disable	N/A
Gi1/0/2	Disable	N/A
Gi1/0/3	Enable	N/A

...

5.2 Example for IPv6 Source Guard

5.2.1 Network Requirements

As shown below, the legal IPv6 host connects to the switch via port 1/0/1 and belongs to the default VLAN 1. It is required that only the legal host can access the network via port

1/0/1, and other unknown hosts will be blocked when trying to access the network via ports 1/0/1-3.

Figure 5-6 Network Topology

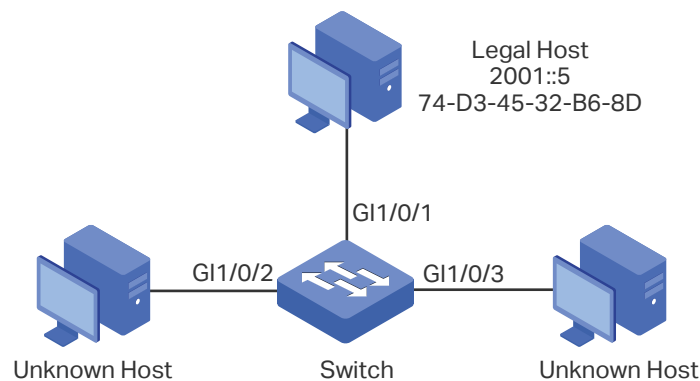

5.2.2 Configuration Scheme

To implement this requirement, you can use IPv6-MAC Binding and IPv6 Source Guard to filter out the packets received from the unknown hosts. The overview of configuration on the switch is as follows:

- 1) Bind the MAC address, IPv6 address, connected port number and VLAN ID of the legal host with IPv6-MAC Binding.
- 2) Enable IPv6 Source Guard on ports 1/0/1-3.

Demonstrated with SG6654XHP, the following sections provide configuration procedure in two ways: using the GUI and using the CLI.

5.2.3 Using the GUI

- 1) Choose the menu **SECURITY > IPv6 IMPB > IPv6-MAC Binding > Manual Binding** and click **+ Add** to load the following page. Enter the host name, IPv6 address, MAC address and VLAN ID of the legal host, select the protect type as IPv6 Source Guard, and select port 1/0/1 on the panel. Click **Apply**.

Figure 5-7 Manual Binding

The screenshot shows the 'IP-MAC Binding' configuration interface. The form contains the following fields:

- Host Name: LegalHost (20 characters maximum)
- IPv6 Address: 2001::5 (Format: 2001::1)
- MAC Address: 74-D3-45-32-B6-8D (Format: 00-00-00-00-00-01)
- VLAN ID: 1 (1-4094)
- Protect Type: IPv6 Source Guard
- Port: 1/0/1 (Format: 1/0/1, input or choose below)

Below the form is a grid of port icons for UNIT1 and LAGS. Port 1/0/1 is selected. A legend indicates that a blue icon represents 'Selected', a white icon represents 'Unselected', and a grey icon represents 'Not Available'. A 'Bind' button is highlighted in red.

- 2) Choose the menu **SECURITY > IPv6 IMPB > IPv6 Source Guard** to load the following page. Select ports 1/0/1-3, configure the Security Type as SIPv6+MAC, and click **Apply**.

Figure 5-8 IPv6 Source Guard

The screenshot shows the 'IPv6 Source Guard Config' page. It features a table with the following columns: Port, Security Type, and LAG. The 'Security Type' dropdown is set to 'SIPv6+MAC'. The first three rows are selected, and the 'Apply' button is highlighted in red.

Port	Security Type	LAG
1/0/1	SIPv6+SMAC	---
1/0/2	SIPv6+SMAC	---
1/0/3	SIPv6+SMAC	---
1/0/4	Disable	---
1/0/5	Disable	---
1/0/6	Disable	---
1/0/7	Disable	---
1/0/8	Disable	---
1/0/9	Disable	---
1/0/10	Disable	---

Total: 54 3 entries selected. Cancel Apply

- 3) Click  Save to save the settings.

5.2.4 Using the CLI

- 1) Manually bind the IPv6 address, MAC address, VLAN ID and connected port number of the legal host, and apply this entry to the IPv6 Source Guard feature.

Switch#configure

```
Switch(config)#ipv6 source binding legal-host 2001::5 74:d3:45:32:b6:8d vlan 1
interface gigabitEthernet 1/0/1 ipv6-verify-source
```

- 2) Enable IPv6 Source Guard on ports 1/0/1-3.

```
Switch(config)# ipv6 verify source

Switch(config)# interface range gigabitEthernet 1/0/1-3

Switch(config-if-range)#ipv6 verify source sipv6+mac

Switch(config-if-range)#end

Switch#copy running-config startup-config
```

Verify the Configuration

Verify the binding entry:

```
Switch#show ip source binding
```

U	Host	IP-Addr	MAC-Addr	VID	Port	ACL	SOURCE
-	----	-----	-----	---	----	---	-----
1	legal-host	2001::5	74:d3:45:32:b6:8d	1	Gi1/0/1	IP-V-S	Manual

Notice:

1. Here, 'ND-D' for 'ND-Detection', and 'IP-V-S' for 'IP-Verify-Source'.

Verify the configuration of IPv6 Source Guard:

```
Switch#show ipv6 verify source
```

Port	Security-Type	LAG
Gi1/0/1	SIPv6+MAC	N/A
Gi1/0/2	SIPv6+MAC	N/A
Gi1/0/3	SIPv6+MAC	N/A

...

6 Appendix: Default Parameters

Default settings of DHCP Snooping are listed in the following table:

Table 6-1 DHCPv6 Snooping

Parameter	Default Setting
Global Config	
DHCPv6 Snooping	Disabled
VLAN Config	
Status	Disabled
Port Config	
Maximum Entry	1024

Default settings of ND Detection are listed in the following table:

Table 6-2 ND Detection

Parameter	Default Setting
Global Config	
ND Detection	Disabled
VLAN Config	
Status	Disabled
Log Status	Disabled
Port Config	
Trust Status	Disabled
ND Statistics	
Auto Refresh	Disabled
Refresh Interval	3 seconds

Default settings of IPv6 Source Guard are listed in the following table:

Table 6-3 ND Detection

Parameter	Default Setting
Port Config	
Security Type	Disabled

Part 32

Configuring DHCP Filter

CHAPTERS

1. DHCP Filter
2. DHCPv4 Filter Configuration
3. DHCPv6 Filter Configuration
4. Configuration Examples
5. Appendix: Default Parameters

1 DHCP Filter

1.1 Overview

During the working process of DHCP, generally there is no authentication mechanism between the DHCP server and the clients. If there are several DHCP servers on the network, security problems and network interference will happen. DHCP Filter resolves this problem.

With DHCP Filter configured, the switch can check whether the received DHCP packets are legal and discard the illegal ones. In this way, DHCP Filter ensures that users get IP addresses only from the legal DHCP server and enhances the network security.

As the following figure shows, there are both legal and illegal DHCP servers on the network. You can configure DHCP Server1 as a legal DHCP server by providing the IP address and port number of DHCP Server1. When receiving the DHCP respond packets, the switch will forward the packets from the legal DHCP server.

Figure 1-1 Network Topology

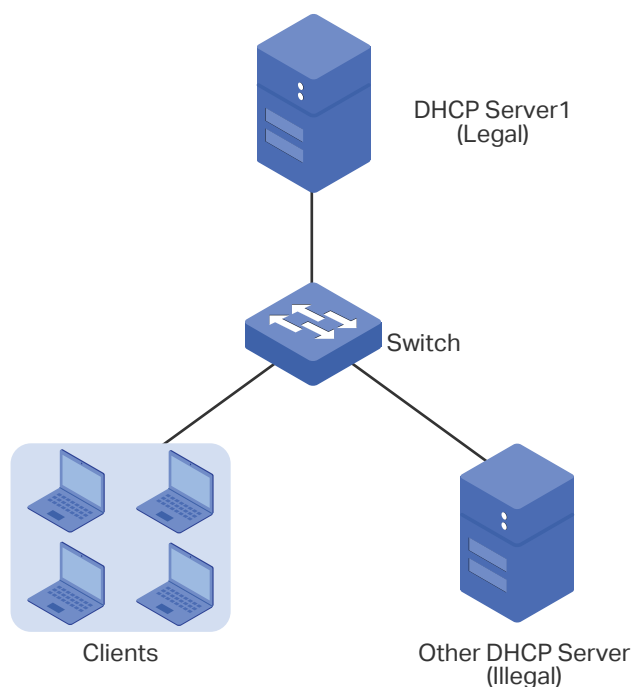

Additionally, you can limit the forwarding rate of DHCP packets on each port.

1.2 Supported Features

The switch supports DHCPv4 Filter and DHCPv6 Filter.

DHCPv4 Filter

DHCPv4 Filter is used for DHCPv4 servers and IPv4 clients.

DHCPv6 Filter

DHCPv6 Filter is used for DHCPv6 servers and IPv6 clients.

2 DHCPv4 Filter Configuration

To complete DHCPv4 Filter configuration, follow these steps:

- 1) Configure the basic DHCPv4 Filter parameters.
- 2) Configure legal DHCPv4 servers.

2.1 Using the GUI

2.1.1 Configuring the Basic DHCPv4 Filter Parameters

Choose the menu **SECURITY > DHCP Filter > DHCPv4 Filter > Basic Config** to load the following page.

Figure 2-1 DHCPv4 Filter Basic Config

Global Config

DHCPv4 Filter: Enable Apply

Port Config

	UNIT1	LAGS				
<input type="checkbox"/>	Port	Status	MAC Verify	Rate Limit	Decline Protect	LAG
<input type="checkbox"/>	1/0/1	Disabled	Disabled	Disabled	Disabled	---
<input type="checkbox"/>	1/0/2	Disabled	Disabled	Disabled	Disabled	---
<input type="checkbox"/>	1/0/3	Disabled	Disabled	Disabled	Disabled	---
<input type="checkbox"/>	1/0/4	Disabled	Disabled	Disabled	Disabled	---
<input type="checkbox"/>	1/0/5	Disabled	Disabled	Disabled	Disabled	---
<input type="checkbox"/>	1/0/6	Disabled	Disabled	Disabled	Disabled	---
<input type="checkbox"/>	1/0/7	Disabled	Disabled	Disabled	Disabled	---
<input type="checkbox"/>	1/0/8	Disabled	Disabled	Disabled	Disabled	---
<input type="checkbox"/>	1/0/9	Disabled	Disabled	Disabled	Disabled	---
<input type="checkbox"/>	1/0/10	Disabled	Disabled	Disabled	Disabled	---

Total: 54

Follow these steps to complete the basic settings of DHCPv4 Filter:

- 1) In the **Global Config** section, enable DHCPv4 globally.
- 2) In the **Port Config** section, select one or more ports and configure the related parameters.

Port Select one or more ports to configure.

Status	Enable or disable DHCPv4 Filter feature on the port.
MAC Verify	Enable or disable the MAC Verify feature. There are two fields in the DHCP packet that contain the MAC address of the host. The MAC Verify feature compares the two fields of a DHCP packet and discards the packet if the two fields are different. This prevents the IP address resource on the DHCP server from being exhausted by forged MAC addresses.
Rate Limit	Enable or disable the Rate Limit feature and specify the maximum number of DHCP packets that can be forwarded on the port per second. The excessive DHCP packets will be discarded.
Decline Protect	Enable or disable the Decline Protect feature and specify the maximum number of DHCP Decline packets that can be forwarded on the port per second. The excessive DHCP Decline packets will be discarded.
LAG	Displays the LAG that the port belongs to.

3) Click **Apply**.

 **Note:**

The member ports of an LAG follow the configurations of the LAG and not their own. The individual configurations of the ports can take effect only after the ports leave the LAG.

2.1.2 Configuring Legal DHCPv4 Servers

Choose the menu **SECURITY > DHCP Filter > DHCPv4 Filter > Legal DHCPv4 Servers** and click  **Add** to load the following page.

Figure 2-2 Adding Legal DHCPv4 Server

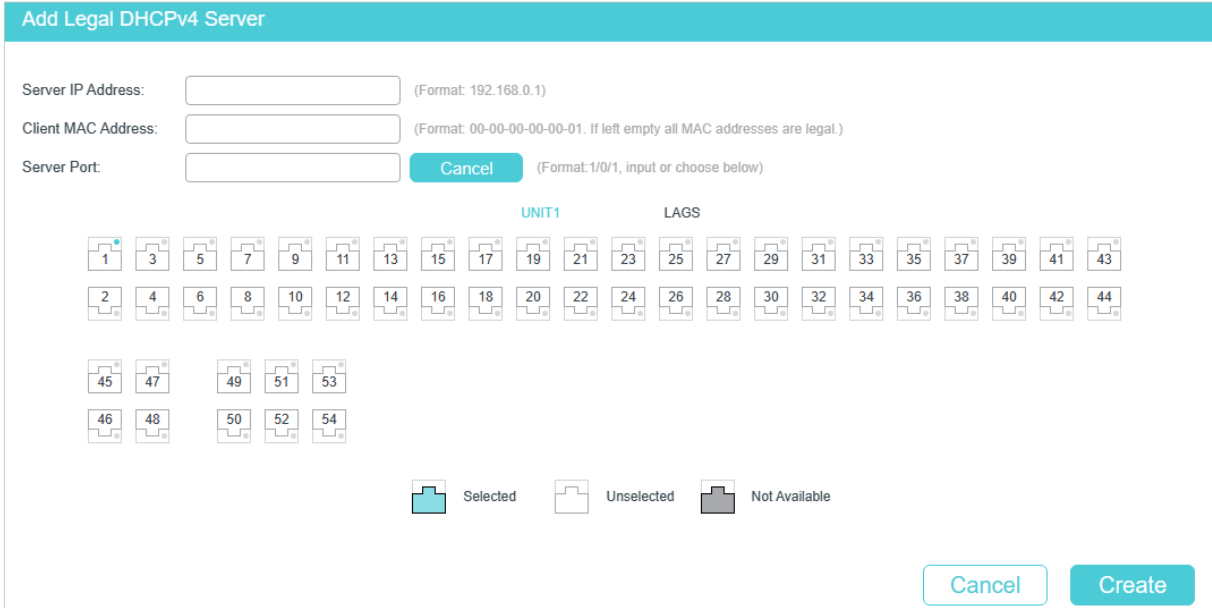

Follow these steps to add a legal DHCPv4 server:

1) Configure the following parameters:

Server IP Address	Specify the IP address of the legal DHCP server.
Client MAC Address	(Optional) Specify the MAC address of the DHCP client. Leaving this field empty means all the DHCP clients.
Server Port	Select a port for the permit entry.

2) Click **Create**.

2.2 Using the CLI

2.2.1 Configuring the Basic DHCPv4 Filter Parameters

Follow these steps to complete the basic settings of DHCPv4 Filter:

Step 1	configure Enter global configuration mode.
Step 2	ip dhcp filter Enable DHCPv4 Filter globally.
Step 3	interface { fastEthernet port range fastEthernet port-list gigabitEthernet port range gigabitEthernet port-list ten-gigabitEthernet port range ten-gigabitEthernet port-list interface port-channel port-channel-id interface range port-channel port-channel-id-list } Enter interface configuration mode.
Step 4	ip dhcp filter Enable DHCPv4 Filter on the port.
Step 5	ip dhcp filter mac-verify Enable the MAC Verify feature. There are two fields in the DHCP packet that contain the MAC address of the host. The MAC Verify feature compares the two fields of a DHCP packet and discards the packet if the two fields are different. This prevents the IP address resource on the DHCP server from being exhausted by forged MAC addresses.
Step 6	ip dhcp filter limit rate value Enable the limit rate feature and specify the maximum number of DHCP messages that can be forwarded on the port per second. The excessive DHCP packets will be discarded. <i>value</i> : Specify the limit rate value. The following options are provided: 0, 5,10,15,20,25 and 30 (packets/second). The default value is 0, which indicates disabling limit rate.

-
- Step 7 **ip dhcp filter decline rate value**
- Enable the decline protect feature and specify the maximum number of Decline packets can be forwarded per second on the port. The excessive Decline packets will be discarded.
- value*: Specify the limit rate value of Decline packets. The following options are provided: 0, 5, 10, 15, 20, 25 and 30 (packets/second). The default value is 0, which indicates disabling this feature.
-
- Step 8 **show ip dhcp filter**
- Verify the global DHCPv4 Filter configuration.
-
- Step 9 **show ip dhcp filter interface [fastEthernet port | gigabitEthernet port | ten-gigabitEthernet port | port-channel port-channel-id]**
- Verify the DHCPv4 Filter configuration of the port.
-
- Step 10 **end**
- Return to privileged EXEC mode.
-
- Step 11 **copy running-config startup-config**
- Save the settings in the configuration file.
-

 **Note:**

The member port of an LAG (Link Aggregation Group) follows the configuration of the LAG and not its own. The configurations of the port can take effect only after it leaves the LAG.

The following example shows how to enable DHCPv4 Filter globally and how to enable DHCPv4 Filter, enable the MAC verify feature, set the limit rate as 10 pps and set the decline rate as 20 pps on port 1/0/1:

Switch#configure

Switch(config)#ip dhcp filter

Switch(config)#interface gigabitEthernet 1/0/1

Switch(config-if)#ip dhcp filter

Switch(config-if)#ip dhcp filter mac-verify

Switch(config-if)#ip dhcp filter limit rate 10

Switch(config-if)#ip dhcp filter decline rate 20

Switch(config-if)##show ip dhcp filter

Global Status: Enable

Switch(config-if)#show ip dhcp filter interface gigabitEthernet 1/0/1

Interface	state	MAC-Verify	Limit-Rate	Dec-rate	LAG
-----	-----	-----	-----	-----	---

Gi1/0/1	Enable	Enable	10	20	N/A
---------	--------	--------	----	----	-----

```
Switch(config-if)#end
```

```
Switch#copy running-config startup-config
```

2.2.2 Configuring Legal DHCPv4 Servers

Follow these steps configure legal DHCPv4 servers:

Step 1	configure Enter global configuration mode.
Step 2	ip dhcp filter server permit-entry server-ip <i>ipAddr</i> client-mac <i>macAddr</i> interface { <i>fastEthernet port-list</i> <i>gigabitEthernet port-list</i> <i>ten-gigabitEthernet port-list</i> <i>port-channel port-channel-id</i> } Create an entry for the legal DHCPv4 server. <i>ipAddr</i> : Specify the IP address of the legal DHCPv4 server. <i>macAddr</i> : Specify the MAC address of the DHCP Client. The value "all" means all client mac addresses. <i>port-list</i> <i>port-channel-id</i> : Specify the port that the legal DHCPv4 server is connected to.
Step 3	show ip dhcp filter server permit-entry Verify configured legal DHCPv4 server information.
Step 4	end Return to privileged EXEC mode.
Step 5	copy running-config startup-config Save the settings in the configuration file.

The following example shows how to create an entry for the legal DHCPv4 server whose IP address is 192.168.0.100 and connected port number is 1/0/1 without client MAC address restricted:

```
Switch#configure
```

```
Switch(config)#ip dhcp filter server permit-entry server-ip 192.168.0.100 client-mac all interface gigabitEthernet 1/0/1
```

```
Switch(config)#show ip dhcp filter server permit-entry
```

Server IP	Client MAC	Interface
-----	-----	-----
192.168.0.100	all	Gi1/0/1

```
Switch(config)#end
```

```
Switch#copy running-config startup-config
```

3 DHCPv6 Filter Configuration

To complete DHCPv6 Filter configuration, follow these steps:

- 1) Configure the basic DHCPv6 Filter parameters.
- 2) Configure legal DHCPv6 servers.

3.1 Using the GUI

3.1.1 Configuring the Basic DHCPv6 Filter Parameters

Choose the menu **SECURITY > DHCP Filter > DHCPv6 Filter > Basic Config** to load the following page.

Figure 3-1 DHCPv6 Filter Basic Config

Global Config

DHCPv6 Filter: Enable Apply

Port Config

UNIT1	LAGS	Port	Status	Rate Limit	Decline Protect	LAG
<input type="checkbox"/>		1/0/1	Disabled	Disabled	Disabled	---
<input type="checkbox"/>		1/0/2	Disabled	Disabled	Disabled	---
<input type="checkbox"/>		1/0/3	Disabled	Disabled	Disabled	---
<input type="checkbox"/>		1/0/4	Disabled	Disabled	Disabled	---
<input type="checkbox"/>		1/0/5	Disabled	Disabled	Disabled	---
<input type="checkbox"/>		1/0/6	Disabled	Disabled	Disabled	---
<input type="checkbox"/>		1/0/7	Disabled	Disabled	Disabled	---
<input type="checkbox"/>		1/0/8	Disabled	Disabled	Disabled	---
<input type="checkbox"/>		1/0/9	Disabled	Disabled	Disabled	---
<input type="checkbox"/>		1/0/10	Disabled	Disabled	Disabled	---

Total: 54

Follow these steps to complete the basic settings of DHCPv6 Filter:

- 1) In the **Global Config** section, enable DHCPv6 globally.
- 2) In the **Port Config** section, select one or more ports and configure the related parameters.

Port Select one or more ports to configure.

Status	Enable or disable DHCPv6 Filter feature on the port.
Rate Limit	Enable or disable the Rate Limit feature and specify the maximum number of DHCP packets that can be forwarded on the port per second. The excessive DHCP packets will be discarded.
Decline Protect	Enable or disable the Decline Protect feature and specify the maximum number of DHCP Decline packets that can be forwarded on the port per second. The excessive DHCP Decline packets will be discarded.
LAG	Displays the LAG that the port belongs to.

3) Click **Apply**.

 **Note:**

The member ports of an LAG follow the configurations of the LAG and not their own. The individual configurations of the ports can take effect only after the ports leave the LAG.

3.1.2 Configuring Legal DHCPv6 Servers

Choose the menu **SECURITY > DHCP Filter > DHCPv6 Filter > Legal DHCPv6 Servers** and click  **Add** to load the following page.

Figure 3-2 Adding Legal DHCPv6 Server

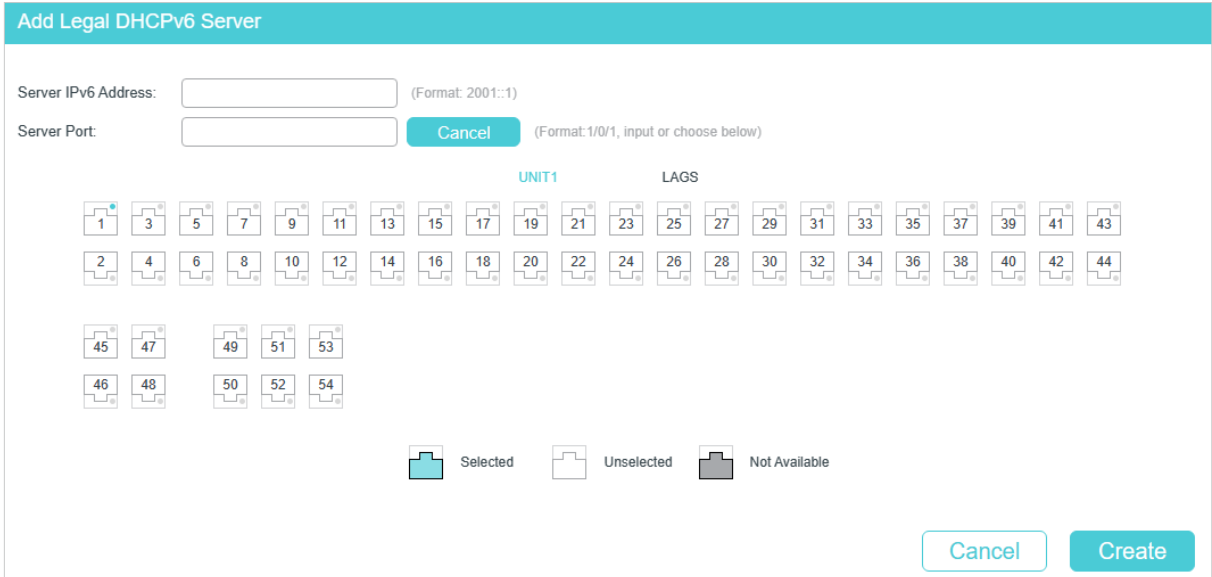

The screenshot shows the 'Add Legal DHCPv6 Server' configuration page. It includes the following elements:

- Server IPv6 Address:** A text input field with a placeholder '(Format: 2001::1)'. A 'Cancel' button is located to its right.
- Server Port:** A dropdown menu with a placeholder '(Format: 1/0/1, input or choose below)'. A 'Cancel' button is located to its right.
- UNIT1:** A grid of 19 port selection buttons, numbered 1 through 19.
- LAGS:** A grid of 25 port selection buttons, numbered 2 through 24, plus an additional button for port 25.
- Legend:** Three icons representing 'Selected' (blue), 'Unselected' (white), and 'Not Available' (grey).
- Buttons:** 'Cancel' and 'Create' buttons at the bottom right.

Follow these steps to add a legal DHCPv6 server:

1) Configure the following parameters:

Server IPv6 Address	Specify the IPv6 address of the DHCPv6 Server to be permitted.
Server Port	Select a port for the permit entry.

2) Click **Create**.

3.2 Using the CLI

3.2.1 Configuring the Basic DHCPv6 Filter Parameters

Follow these steps to complete the basic settings of DHCPv6 Filter:

Step 1	configure Enter global configuration mode.
Step 2	ipv6 dhcp filter Enable DHCPv6 Filter globally.
Step 3	interface { fastEthernet port range fastEthernet port-list gigabitEthernet port range gigabitEthernet port-list ten-gigabitEthernet port range ten-gigabitEthernet port-list interface port-channel port-channel-id interface range port-channel port-channel-id-list } Enter interface configuration mode.
Step 4	ipv6 dhcp filter Enable DHCPv6 Filter on the port.
Step 5	ipv6 dhcp filter limit rate value Enable the limit rate feature and specify the maximum number of DHCP messages that can be forwarded on the port per second. The excessive DHCP packets will be discarded. <i>value</i> : Specify the limit rate value. The following options are provided: 0, 5,10,15,20,25 and 30 (packets/second). The default value is 0, which indicates disabling limit rate.
Step 6	ipv6 dhcp filter decline rate value Enable the decline protect feature and specify the maximum number of Decline packets can be forwarded per second on the port. The excessive Decline packets will be discarded. <i>value</i> : Specify the limit rate value of Decline packets. The following options are provided: 0, 5,10,15,20,25 and 30 (packets/second). The default value is 0, which indicates disabling this feature.
Step 7	show ipv6 dhcp filter Verify the global DHCPv6 Filter configuration.
Step 8	show ipv6 dhcp filter interface [fastEthernet port gigabitEthernet port ten-gigabitEthernet port port-channel port-channel-id] Verify the DHCPv6 Filter configuration of the port.
Step 9	end Return to privileged EXEC mode.
Step 10	copy running-config startup-config Save the settings in the configuration file.

 **Note:**

The member port of an LAG (Link Aggregation Group) follows the configuration of the LAG and not its own. The configurations of the port can take effect only after it leaves the LAG.

The following example shows how to enable DHCPv6 Filter globally and how to enable DHCPv6 Filter, set the limit rate as 10 pps and set the decline rate as 20 pps on port 1/0/1:

Switch#configure

Switch(config)#ipv6 dhcp filter

Switch(config)#interface gigabitEthernet 1/0/1

Switch(config-if)#ipv6 dhcp filter

Switch(config-if)#ipv6 dhcp filter limit rate 10

Switch(config-if)#ipv6 dhcp filter decline rate 20

Switch(config-if)##show ipv6 dhcp filter

Global Status: Enable

Switch(config-if)#show ip dhcp filter interface gigabitEthernet 1/0/1

Interface	state	Limit-Rate	Dec-rate	LAG
-----	-----	-----	-----	---
Gi1/0/1	Enable	10	20	N/A

Switch(config-if)#end

Switch#copy running-config startup-config

3.2.2 Configuring Legal DHCPv6 Servers

Follow these steps configure legal DHCPv6 servers:

Step 1	<p>configure</p> <p>Enter global configuration mode.</p>
Step 2	<p>ipv6 dhcp filter server permit-entry server-ip <i>ipAddr</i> interface { fastEthernet <i>port-list</i> gigabitEthernet <i>port-list</i> ten-gigabitEthernet <i>port-list</i> port-channel <i>port-channel-id</i> }</p> <p>Create an entry for the legal DHCPv6 server.</p> <p><i>ipAddr</i>: Specify the IPv6 address of the legal DHCPv6 server.</p> <p><i>port-list</i> <i>port-channel-id</i>: Specify the port that the legal DHCPv6 server is connected to.</p>
Step 3	<p>show ip dhcp filter server permit-entry</p> <p>Verify configured legal DHCPv6 server information.</p>

-
- Step 4 **end**
Return to privileged EXEC mode.
-
- Step 5 **copy running-config startup-config**
Save the settings in the configuration file.
-

The following example shows how to create an entry for the legal DHCPv6 server whose IPv6 address is 2001::54 and connected port number is 1/0/1:

Switch#configure

Switch(config)#ipv6 dhcp filter server permit-entry server-ip 2001::54 interface gigabitEthernet 1/0/1

Switch(config)#show ipv6 dhcp filter server permit-entry

Server IP	Interface
-----	-----
2001::54	Gi1/0/1

Switch(config)#end

Switch#copy running-config startup-config

4 Configuration Examples

4.1 Example for DHCPv4 Filter

4.1.1 Network Requirements

As shown below, all the DHCPv4 clients get IP addresses from the legal DHCPv4 server, and any other DHCPv4 server in the LAN is regarded as illegal. Now it is required that only the legal DHCPv4 server is allowed to assign IP addresses to the clients.

Figure 4-1 Network Topology

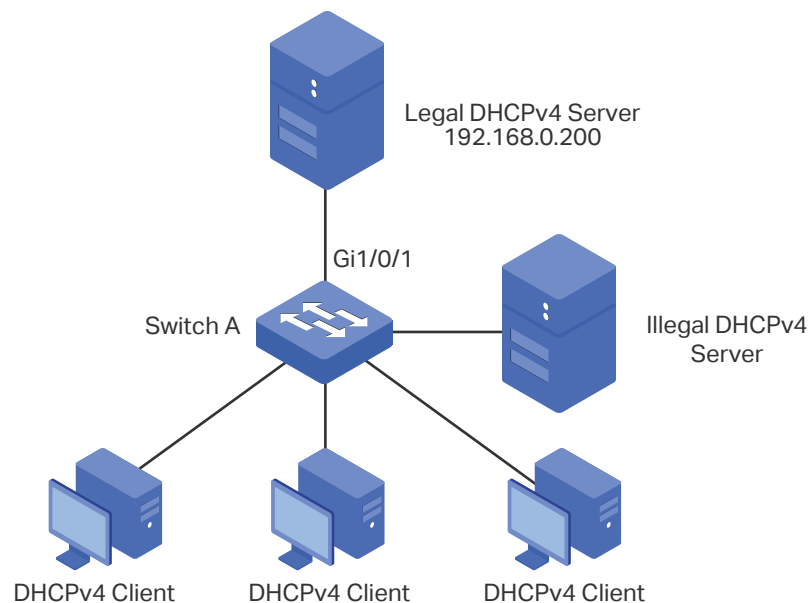

4.1.2 Configuration Scheme

To meet the requirements, you can configure DHCPv4 Filter to filter the DHCPv4 packets from the illegal DHCPv4 server.

The overview of configuration is as follows:

- 1) Enable DHCPv4 Filter globally and on all ports.
- 2) Create an entry for the legal DHCPv4 server.

Demonstrated with SG6654XHP, the following sections provide configuration procedure in two ways: using the GUI and using the CLI.

4.1.3 Using the GUI

- 1) Choose the menu **SECURITY > DHCP Filter > DHCPv4 Filter > Basic Config** to load the following page. Enable DHCPv4 Filter globally and click **Apply**. Select all ports, change Status as Enable, and click **Apply**.

Figure 4-2 Basic Config

Global Config

DHCPv4 Filter: Enable Apply

Port Config

UNIT1

LAGS

	Port	Status	MAC Verify	Rate Limit	Decline Protect	LAG
<input checked="" type="checkbox"/>		Enable				
<input checked="" type="checkbox"/>	1/0/1	Enabled	Disabled	Disabled	Disabled	---
<input checked="" type="checkbox"/>	1/0/2	Enabled	Disabled	Disabled	Disabled	---
<input checked="" type="checkbox"/>	1/0/3	Enabled	Disabled	Disabled	Disabled	---
<input checked="" type="checkbox"/>	1/0/4	Enabled	Disabled	Disabled	Disabled	---
<input checked="" type="checkbox"/>	1/0/5	Enabled	Disabled	Disabled	Disabled	---
<input checked="" type="checkbox"/>	1/0/6	Enabled	Disabled	Disabled	Disabled	---
<input checked="" type="checkbox"/>	1/0/7	Enabled	Disabled	Disabled	Disabled	---
<input checked="" type="checkbox"/>	1/0/8	Enabled	Disabled	Disabled	Disabled	---
<input checked="" type="checkbox"/>	1/0/9	Enabled	Disabled	Disabled	Disabled	---
<input checked="" type="checkbox"/>	1/0/10	Enabled	Disabled	Disabled	Disabled	---

Total: 54 54 entries selected. Cancel Apply

- 2) Choose the menu **SECURITY > DHCP Filter > DHCPv4 Filter > Legal DHCPv4 Servers** and click **+ Add** to load the following page. Specify the IP address and connected port number of the legal DHCPv4 server. Click **Create**.

Figure 4-3 Create Entry for Legal DHCPv4 Server

The screenshot shows a configuration window titled "Add Legal DHCPv4 Server". It contains three input fields: "Server IP Address" (192.168.0.200), "Client MAC Address" (empty), and "Server Port" (1/0/1). Below these fields is a grid of interface icons labeled "UNIT1" and "LAGS". Interface 1 is selected. At the bottom right, the "Create" button is highlighted with a red box.

- 3) Click  Save to save the settings.

4.1.4 Using the CLI

- 1) Enable DHCPv4 Filter globally and on all pots:

```
Switch_A#configure
```

```
Switch_A(config)#ip dhcp filter
```

```
Switch_A(config)#interface range gigabitEthernet 1/0/1-28
```

```
Switch_A(config-if-range)#ip dhcp filter
```

```
Switch_A(config-if-range)#exit
```

- 2) Create an entry for the legal DHCPv4 server:

```
Switch_A(config)#ip dhcp filter server permit-entry server-ip 192.168.0.200 client-mac  
all interface gigabitEthernet 1/0/1
```

```
Switch_A(config)#end
```

```
Switch_A#copy running-config startup-config
```

Verify the Configuration

Verify the global DHCPv4 Filter configuration:

```
Switch_A#show ip dhcp filter
```

Global Status: Enable

Verify the DHCPv4 Filter configuration on ports:

```
Switch_A#show ip dhcp filter interface
```

Interface	state	MAC-Verify	Limit-Rate	Dec-rate	LAG
-----	-----	-----	-----	-----	---
Gi1/0/1	Enable	Disable	Disable	Disable	N/A
Gi1/0/2	Enable	Disable	Disable	Disable	N/A
Gi1/0/3	Enable	Disable	Disable	Disable	N/A
Gi1/0/4	Enable	Disable	Disable	Disable	N/A
...					

Verify the legal DHCPv4 server configuration:

```
Switch_A#show ip dhcp filter server permit-entry
```

Server IP	Client MAC	Interface
-----	-----	-----
192.168.0.200	all	Gi1/0/1

4.2 Example for DHCPv6 Filter

4.2.1 Network Requirements

As shown below, all the DHCPv6 clients get IP addresses from the legal DHCPv6 server, and any other DHCPv6 server in the LAN is regarded as illegal. Now it is required that only the legal DHCPv6 server is allowed to assign IP addresses to the clients.

Figure 4-1 Network Topology

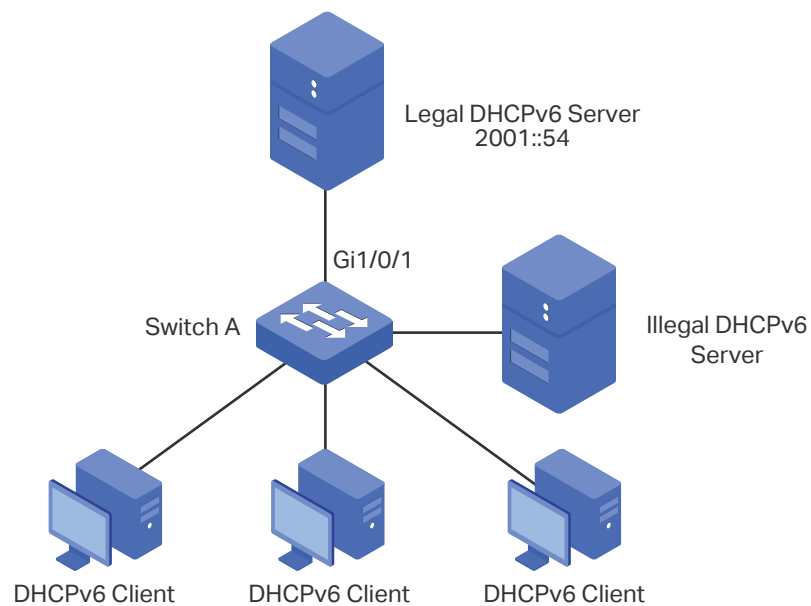

4.2.2 Configuration Scheme

To meet the requirements, you can configure DHCPv6 Filter to filter the DHCPv6 packets from the illegal DHCPv6 server.

The overview of configuration is as follows:

- 1) Enable DHCPv6 Filter globally and on all ports.
- 2) Create an entry for the legal DHCPv6 server.

Demonstrated with SG6654XHP, the following sections provide configuration procedure in two ways: using the GUI and using the CLI.

4.2.3 Using the GUI

- 1) Choose the menu **SECURITY > DHCP Filter > DHCPv6 Filter > Basic Config** to load the following page. Enable DHCPv6 Filter globally and click **Apply**. Select all ports, change Status as Enable, and click **Apply**.

Figure 4-2 Basic Config

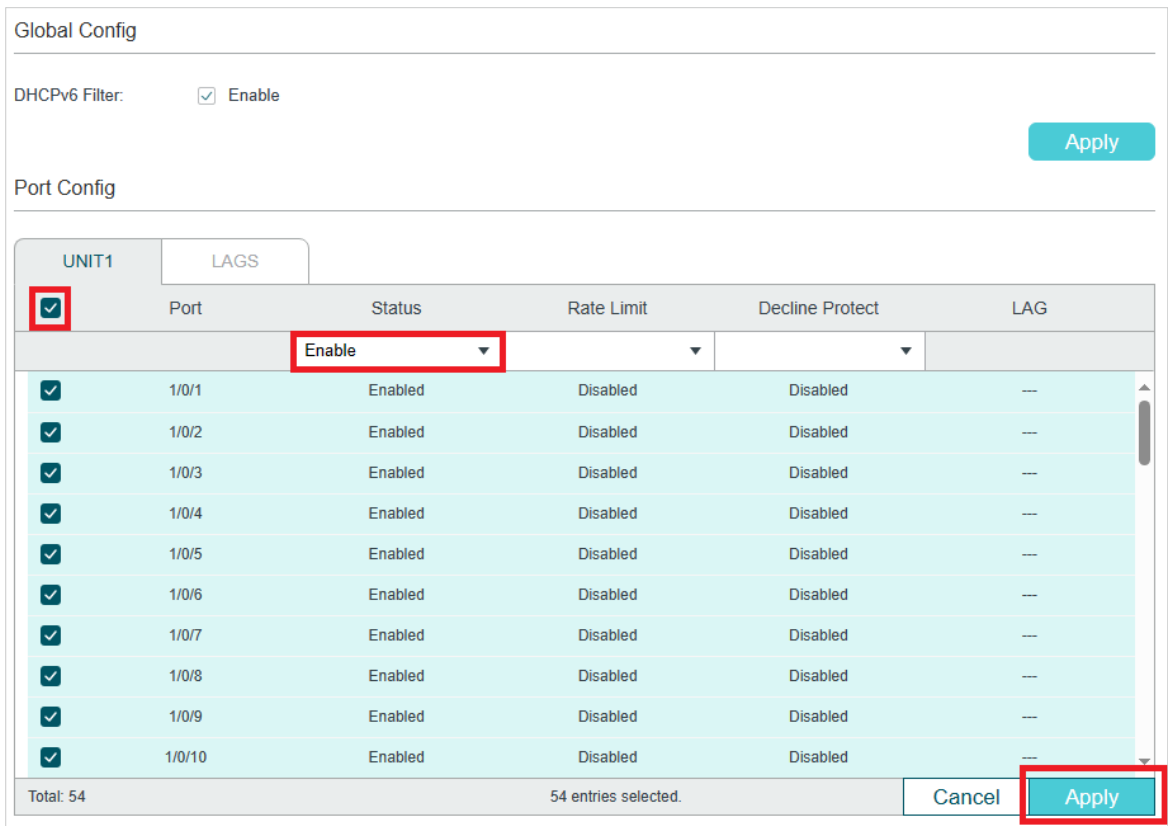

- 2) Choose the menu **SECURITY > DHCP Filter > DHCPv6 Filter > Legal DHCPv6 Servers** and click **+ Add** to load the following page. Specify the IP address and connected port number of the legal DHCPv6 server. Click **Create**.

Figure 4-3 Create Entry for Legal DHCPv6 Server

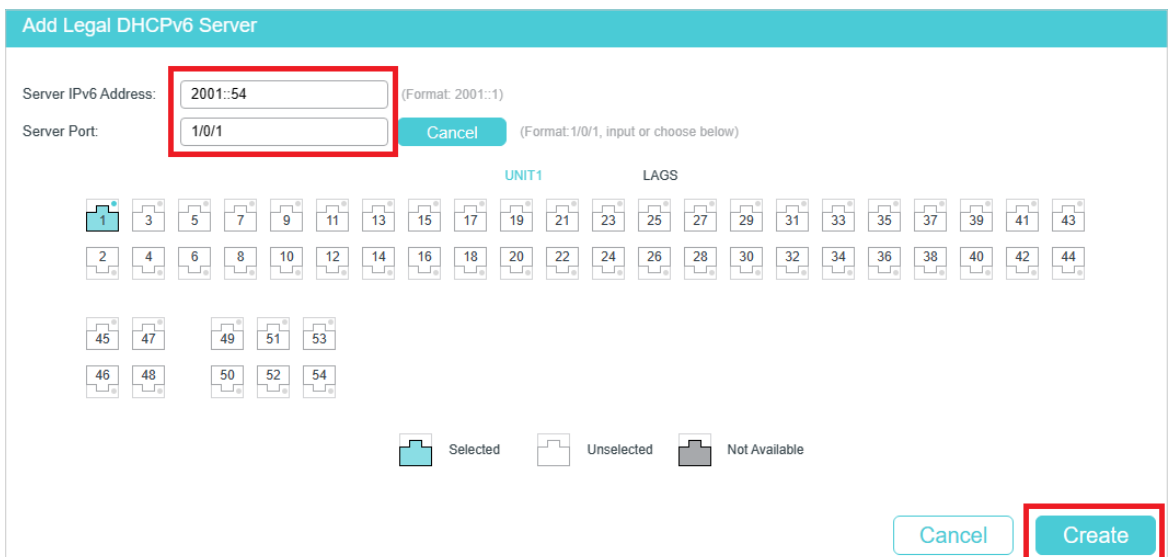

- 3) Click **Save** to save the settings.

4.2.4 Using the CLI

- 1) Enable DHCPv6 Filter globally and on all pots:

```
Switch_A#configure
Switch_A(config)#ipv6 dhcp filter
Switch_A(config)#interface range gigabitEthernet 1/0/1-28
Switch_A(config-if-range)#ipv6 dhcp filter
Switch_A(config-if-range)#exit
```

- 2) Create an entry for the legal DHCPv6 server:

```
Switch_A(config)#ipv6 dhcp filter server permit-entry server-ip 2001::54 interface
gigabitEthernet 1/0/1
Switch_A(config)#end
Switch_A#copy running-config startup-config
```

Verify the Configuration

Verify the global DHCPv6 Filter configuration:

```
Switch_A#show ipv6 dhcp filter
Global Status: Enable
```

Verify the DHCPv6 Filter configuration on ports:

```
Switch_A#show ipv6 dhcp filter interface
```

Interface	state	Limit-Rate	Dec-rate	LAG
-----	-----	-----	-----	---
Gi1/0/1	Enable	Disable	Disable	N/A
Gi1/0/2	Enable	Disable	Disable	N/A
Gi1/0/3	Enable	Disable	Disable	N/A
Gi1/0/4	Enable	Disable	Disable	N/A
...				

Verify the legal DHCPv6 server configuration:

```
Switch_A#show ipv6 dhcp filter server permit-entry
```

Server IP	Interface
-----	-----
2001::54	Gi1/0/1

5 Appendix: Default Parameters

Default settings of DHCPv4 Filter are listed in the following table:

Table 5-1 DHCPv4 Filter

Parameter	Default Setting
Global Config	
DHCPv4 Filter	Disabled
Port Config	
Status	Disabled
MAC Verify	Disabled
Rate Limit	Disabled
Decline Protect	Disabled

Table 5-2 DHCPv6 Filter

Parameter	Default Setting
Global Config	
DHCPv6 Filter	Disabled
Port Config	
Status	Disabled
Rate Limit	Disabled
Decline Protect	Disabled

Part 33

Configuring DoS Defend

CHAPTERS

1. Overview
2. DoS Defend Configuration
3. Appendix: Default Parameters

1 Overview

The DoS (Denial of Service) defend feature provides protection against DoS attacks. DoS attacks occupy the network bandwidth maliciously by sending numerous service requests to the hosts. It results in an abnormal service or breakdown of the network.

With DoS Defend feature, the switch can analyze the specific fields of the IP packets, distinguish the malicious DoS attack packets and discard them directly. Also, DoS Defend feature can limit the transmission rate of legal packets. When the number of legal packets exceeds the threshold value and may incur a breakdown of the network, the switch will discard the packets.

2 DoS Defend Configuration

2.1 Using the GUI

Choose the menu **SECURITY > DoS Defend** to load the following page.

Figure 2-1 DoS Defend

Follow these steps to configure DoS Defend:

- 1) In the **DoS Defend** section, enable DoS Protection and click **Apply**.
- 2) In the **DoS Defend Config** section, select one or more defend types according to your needs and click **Apply**. The following table introduces each type of DoS attack.

Scan SYNFIN	The attacker sends a packet with its SYN field and the FIN field set to 1. The SYN field is used to request initial connection whereas the FIN field is used to request disconnection. Therefore, the packet of this type is illegal.
Xmascan	The attacker sends an illegal packet with its TCP index, FIN, URG and PSH field set to 1.
NULL Scan	The attacker sends an illegal packet with its TCP index and all the control fields set to 0. During the TCP connection and data transmission, the packets with all control fields set to 0 are considered illegal.
SYN sPort less 1024	The attacker sends an illegal packet with its TCP SYN field set to 1 and source port smaller than 1024.
Ping Flooding	The attacker floods the destination system with Ping packets, creating a broadcast storm that makes it impossible for the system to respond to legal communication.

**SYN/SYN-ACK
Flooding**

The attacker uses a fake IP address to send TCP request packets to the server. Upon receiving the request packets, the server responds with SYN-ACK packets. Since the IP address is fake, no response will be returned. The server will keep on sending SYN-ACK packets. If the attacker sends overflowing fake request packets, the network resource will be occupied maliciously and the requests of the legal clients will be denied.

3) Click **Apply**.

2.2 Using the CLI

Follow these steps to configure DoS Defend:

-
- | | |
|--------|----------------------------------|
| Step 1 | configure |
| | Enter global configuration mode. |
-
- | | |
|--------|---|
| Step 2 | ip dos-prevent |
| | Globally enable the DoS defend feature. |
-

Step 3

ip dos-prevent type { land | scan-synfin | xma-scan | null-scan | port-less-1024 | blat | ping-flood | syn-flood | win-nuke | ping-of-death | smurf }

Configure one or more defend types according to your needs. The types of DoS attack are introduced as follows.

land: The attacker sends a specific fake SYN (synchronous) packet to the destination host. Because both the source IP address and the destination IP address of the SYN packet are set to be the IP address of the host, the host will be trapped in an endless circle of building the initial connection.

scan-synfin: The attacker sends the packet with its SYN field and the FIN field set to 1. The SYN field is used to request initial connection whereas the FIN field is used to request disconnection. Therefore, a packet of this type is illegal.

xma-scan: The attacker sends the illegal packet with its TCP index, FIN, URG and PSH field set to 1.

null-scan: The attacker sends the illegal packet with its TCP index and all the control fields set to 0. During the TCP connection and data transmission, the packets with all the control fields set to 0 are considered as the illegal packets.

port-less-1024: The attacker sends the illegal packet with its TCP SYN field set to 1 and source port smaller than 1024.

blat: The attacker sends the illegal packet with the same source port and destination port on Layer 4 and with its URG field set to 1. Similar to the Land Attack, the system performance of the attacked host is reduced because the Host circularly attempts to build a connection with the attacker.

ping-flood: The attacker floods the destination system with Ping packets, creating a broadcast storm that makes it impossible for system to respond to legal communication.

syn-flood: The attacker uses a fake IP address to send TCP request packets to the server. Upon receiving the request packets, the server responds with SYN-ACK packets. Since the IP address is fake, no response will be returned. The server will keep on sending SYN-ACK packets. If the attacker sends overflowing fake request packets, the network resource will be occupied maliciously and the requests of the legal clients will be denied.

win-nuke: An Operation System with bugs cannot process the URG (Urgent Pointer) of TCP packets. If the attacker sends TCP packets to port 139 (NetBIOS) of the host with Operation System bugs, it will cause blue screen.

ping-of-death: Ping of Death attack means that the attacker sends abnormal ping packets larger than 65535 bytes to cause system crash on the target computer.

Note: Ping of Death is only available on certain devices.

smurf: Smurf attack is a distributed denial-of-service attack in which large numbers of Internet Control Message Protocol (ICMP) packets with the intended victim's spoofed source IP are broadcast to a computer network using an IP broadcast address. Most devices on a network will, by default, respond to this by sending a reply to the source IP address. If the number of machines on the network that receive and respond to these packets is very large, the victim's computer will be flooded with traffic.

Note: Smurf is only available on certain devices.

Step 4

show ip dos-prevent

Verify the DoS Defend configuration.

-
- Step 5 **end**
Return to privileged EXEC mode.
-
- Step 6 **copy running-config startup-config**
Save the settings in the configuration file.
-

The following example shows how to enable the DoS Defend type named land:

Switch#configure

Switch(config)#ip dos-prevent

Switch(config)#ip dos-prevent type land

Switch(config)#show ip dos-prevent

```
DoS Prevention State:   Enabled
Type                    Status
----                    -
Land Attack             Enabled
Scan SYNFIN             Disabled
Xmascan                 Disabled
NULL Scan               Disabled
SYN sPort less 1024    Disabled
Blat Attack             Disabled
Ping Flooding           Disabled
SYN/SYN-ACK Flooding   Disabled
WinNuke Attack          Disabled
Smurf Attack            Disabled
Ping Of Death           Disabled
```

Switch(config)#end

Switch#copy running-config startup-config

3 Appendix: Default Parameters

Default settings of Network Security are listed in the following tables.

Table 3-1 DoS Defend

Parameter	Default Setting
DoS Defend	Disabled

Part 34

Monitoring the System

CHAPTERS

1. Overview
2. Monitoring the CPU
3. Monitoring the Memory

1 Overview

With System Monitor function, you can:

- Monitor the CPU utilization of the switch.
- Monitor the memory utilization of the switch.

The CPU utilization should be always under 80%, and excessive use may result in switch malfunctions. For example, the switch fails to respond to management requests (ICMP ping, SNMP timeouts, slow Telnet or SSH sessions). You can monitor the system to verify a CPU utilization problem.

2 Monitoring the CPU

2.1 Using the GUI

Choose the menu **MAINTENANCE > System Monitor > CPU Monitor** to load the following page.

Figure 2-1 Monitoring the CPU

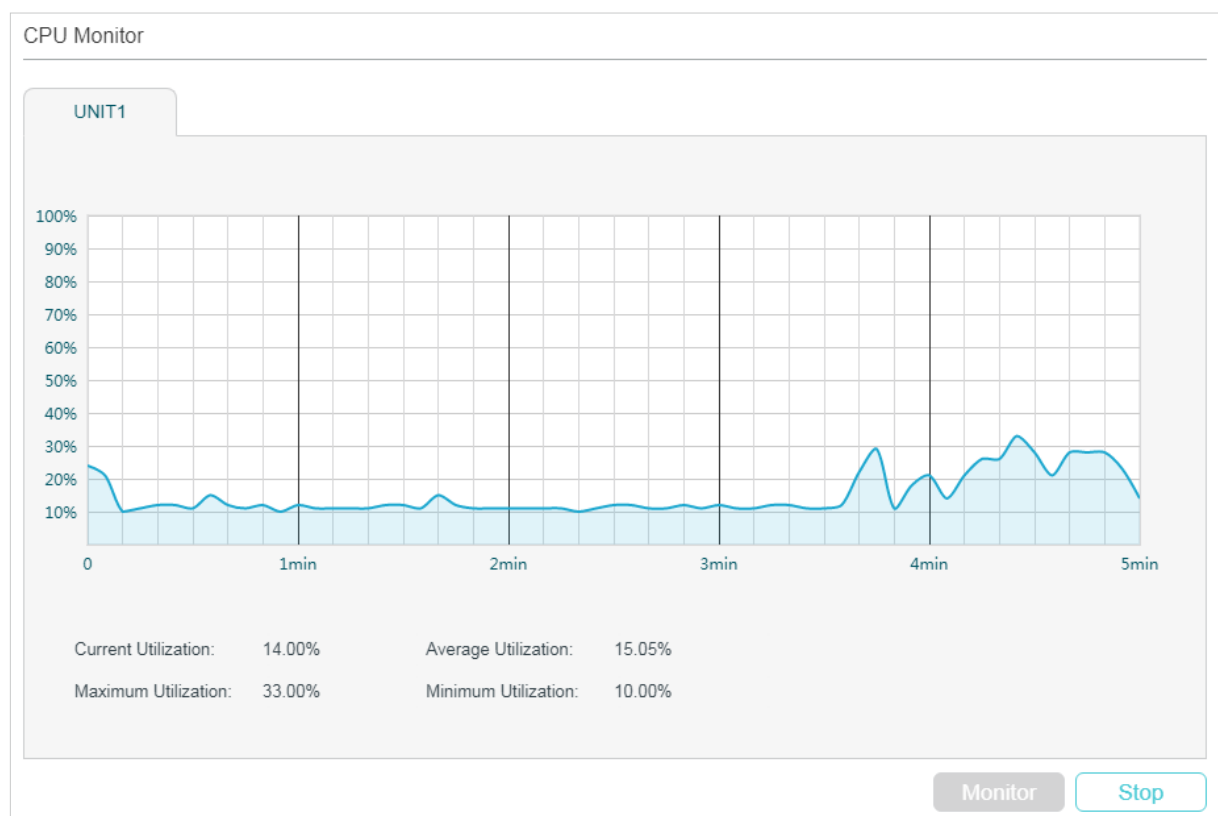

Click **Monitor** to enable the switch to monitor and display its CPU utilization rate every five seconds.

2.2 Using the CLI

On privileged EXEC mode or any other configuration mode, you can use the following command to view the CPU utilization:

show cpu-utilization

View the memory utilization of the switch in the last 5 seconds, 1minute and 5minutes.

The following example shows how to monitor the CPU:

Switch#show cpu-utilization

Unit	CPU Utilization		
No.	Five-Seconds	One-Minute	Five-Minutes
-----+-----			
1	13%	13%	13%

3 Monitoring the Memory

3.1 Using the GUI

Choose the menu **MAINTENANCE > System Monitor > Memory Monitor** to load the following page.

Figure 3-1 Monitoring the Memory

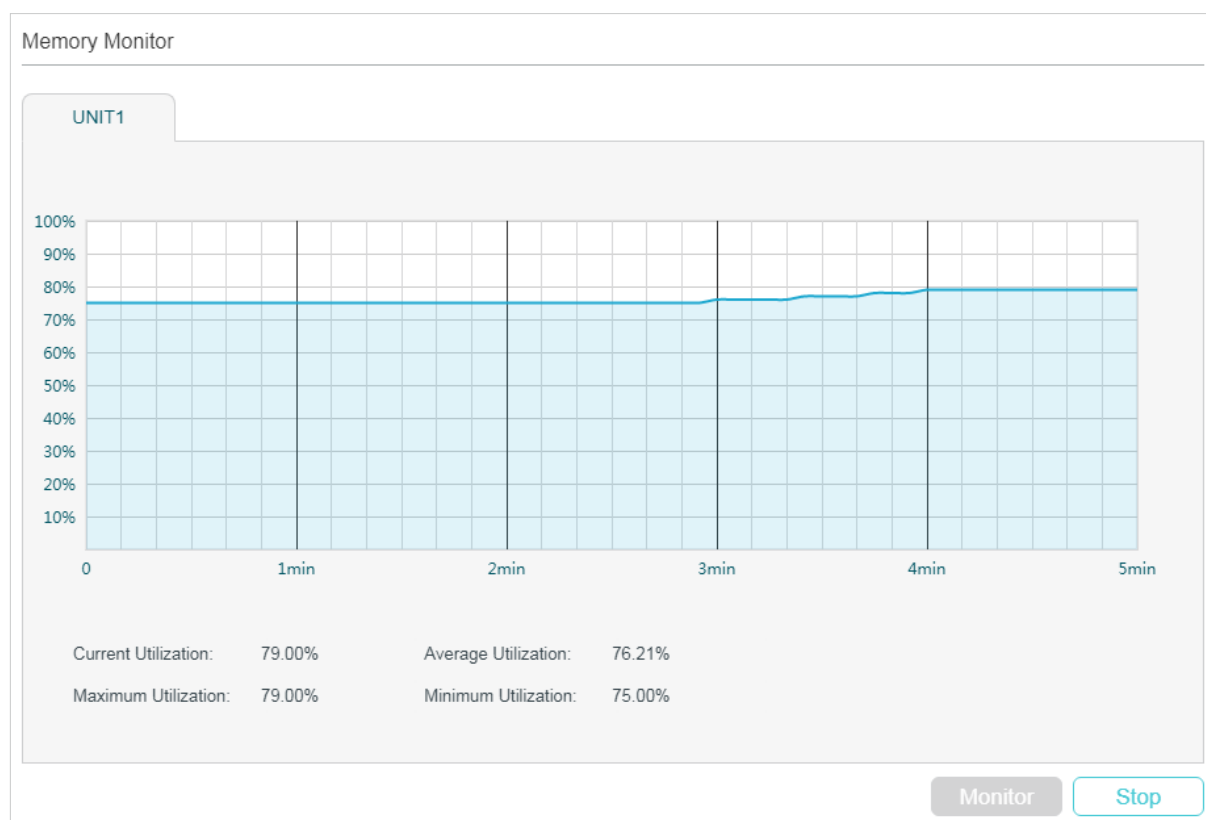

Click **Monitor** to enable the switch to monitor and display its memory utilization rate every five seconds.

3.2 Using the CLI

On privileged EXEC mode or any other configuration mode, you can use the following command to view the memory utilization:

show memory-utilization

View the current memory utilization of the switch.

The following example shows how to monitor the memory:

Switch#show memory-utilization

Unit | Current Memory Utilization

-----+-----

1 | 74%

Part 35

Monitoring Traffic

CHAPTERS

1. Traffic Monitor
2. Appendix: Default Parameters

1 Traffic Monitor

With Traffic Monitor function, you can monitor each port's traffic information, including the traffic summary and traffic statistics in detail.

1.1 Using the GUI

Choose the menu **MAINTENANCE > Traffic Monitor** to load the following page.

Figure 1-1 Traffic Summary

Traffic Summary

Auto Refresh: Enable Apply

Refresh
 Clear

<input type="checkbox"/> UNIT1	<input type="checkbox"/> LAGS	Port	Packets Rx	Packets Tx	Octets Rx	Octets Tx	Statistics
<input type="checkbox"/>		1/0/1	6066	10899	664232	9786653	Statistics
<input type="checkbox"/>		1/0/2	0	0	0	0	Statistics
<input type="checkbox"/>		1/0/3	0	0	0	0	Statistics
<input type="checkbox"/>		1/0/4	0	0	0	0	Statistics
<input type="checkbox"/>		1/0/5	0	0	0	0	Statistics
<input type="checkbox"/>		1/0/6	0	0	0	0	Statistics
<input type="checkbox"/>		1/0/7	0	0	0	0	Statistics
<input type="checkbox"/>		1/0/8	0	0	0	0	Statistics
<input type="checkbox"/>		1/0/9	0	0	0	0	Statistics
<input type="checkbox"/>		1/0/10	0	0	0	0	Statistics
		Total: 54					

Follow these steps to view the traffic summary of each port:

- 1) To get the real-time traffic summary, enable **Auto Refresh**, or click **Refresh**.

Auto Refresh: With this option enabled, the switch will automatically refresh the traffic summary.

Refresh Interval: Specify the time interval for the switch to refresh the traffic summary.

- 2) In the **Traffic Summary** section, click **UNIT1** to show the information of the physical ports, and click **LAGS** to show the information of the LAGs.

Packets Rx: Displays the number of packets received on the port. Error packets are not counted.

Packets Tx:	Displays the number of packets transmitted on the port. Error packets are not counted.
Octets Rx:	Displays the number of octets received on the port. Error octets are counted.
Octets Tx:	Displays the number of octets transmitted on the port. Error octets are counted.

To view a port's traffic statistics in detail, click **Statistics** on the right side of the entry.

Figure 1-2 Traffic Statistics

Statistics ✕			
Port1/0/1			
Received		Sent	
Broadcast:	153	Broadcast:	3,296
Multicast:	622	Multicast:	19
Unicast:	5,305	Unicast:	7,620
Jumbo:	0	Jumbo:	0
Pkts:	6,080	Pkts:	10,935
Bytes:	666,423	Bytes:	9,801,998
Alignment Errors:	0	Collisions Errors:	0
Undersize Packets:	0		
Octets Packets			
64-Octets Packets:		5,772	
65-to-127-Octets Packets:		1,240	
128-to-255-Octets Packets:		423	
256-to-511-Octets Packets:		3,602	
512-to-1023-Octets Packets:		493	
1024-to-Jumbo-Octets Packets:		5,485	

Received:

Displays the detailed information of received packets.

Broadcast: Displays the number of valid broadcast packets received on the port. Error frames are not counted.

Multicast: Displays the number of valid multicast packets received on the port. Error frames are not counted.

Unicast: Displays the number of valid unicast packets received on the port. Error frames are not counted.

Jumbo: Displays the number of valid jumbo packets received on the port. Error frames are not counted.

Alignment Errors: Displays the number of the received packets that have a Frame Check Sequence (FCS) with a non-integral octet (Alignment Error). The size of the packet is between 64 bytes and 1518 bytes.

Undersize Packets: Displays the number of the received packets (excluding error packets) that are less than 64 bytes long.

64-Octets Packets: Displays the number of the received packets (including error packets) that are 64 bytes long.

65-to-127-Octets Packets: Displays the number of the received packets (including error packets) that are between 65 and 127 bytes long.

128-to-255-Octets Packets: Displays the number of the received packets (including error packets) that are between 128 and 255 bytes long.

256-to-511-Octets Packets: Displays the number of the received packets (including error packets) that are between 256 and 511 bytes long.

512-to-1023-Octets Packets: Displays the number of the received packets (including error packets) that are between 512 and 1023 bytes long.

1024-to-Jumbo-Octets Packets: Displays the number of the received packets (including error packets) that are between 1024 and 1518 bytes long.

Pkts: Displays the number of packets received on the port. Error packets are not counted.

Bytes: Displays the number of bytes received on the port. Error packets are not counted.

Sent:

Displays the detailed information of sent packets.

Broadcast: Displays the number of valid broadcast packets transmitted on the port. Error frames are not counted.

Multicast: Displays the number of valid multicast packets transmitted on the port. Error frames are not counted.

Unicast: Displays the number of valid unicast packets transmitted on the port. Error frames are not counted.

Pkts: Displays the number of packets transmitted on the port. Error packets are not counted.

Bytes: Displays the number of bytes transmitted on the port. Error packets are not counted.

Collisions: Displays the number of collisions experienced by a half-duplex port during packet transmissions.

1.2 Using the CLI

On privileged EXEC mode or any other configuration mode, you can use the following command to view the traffic information of each port or LAG:

```
show interface counters [ fastEthernet port | gigabitEthernet port | ten-gigabitEthernet port | port-channel port-channel-id ]
```

port: The port number.

port-channel-id : The group number of the LAG.

If you enter no port number or group number, the information of all ports and LAGs will be displayed.

The displaying information includes:

Tx Collisions: Displays the number of collisions experienced by a port during packet transmissions.

Tx Ucast / Tx Mcast / Tx Bcast / Tx Jumbo: Displays the number of valid unicast / multicast / broadcast / jumbo packets transmitted on the port. Error frames are not counted.

Tx Pkts: Displays the number of packets transmitted on the port. Error packets are not counted.

Tx Bytes: Displays the number of bytes transmitted on the port. Error packets are not counted.

Rx Ucast / Rx Mcast / Rx Bcast / Rx Jumbo: Displays the number of valid unicast / multicast / broadcast / jumbo packets received on the port. Error frames are not counted.

Rx Alignment: Displays the number of the received packets that have a Frame Check Sequence (FCS) with a non-integral octet (Alignment Error). The size of the packet is between 64 bytes and 1518 bytes.

Rx UnderSize: Displays the number of the received packets (excluding error packets) that are less than 64 bytes long.

Rx 64Pkts: Displays the number of the received packets (including error packets) that are 64 bytes long.

Rx 65-127Pkts: Displays the number of the received packets (including error packets) that are between 65 and 127 bytes long.

Rx 128-255Pkts: Displays the number of the received packets (including error packets) that are between 128 and 255 bytes long.

Rx 256-511Pkts: Displays the number of the received packets (including error packets) that are between 256 and 511 bytes long.

Rx 512-1023Pkts: Displays the number of the received packets (including error packets) that are between 512 and 1023 bytes long.

Rx 1024-1518Pkts: Displays the number of the received packets (including error packets) that are between 1024 and 1518 bytes long.

Rx Pkts: Displays the number of packets received on the port. Error packets are not counted.

Rx Bytes: Displays the number of bytes received on the port. Error packets are not counted.

2 Appendix: Default Parameters

Table 2-1 Traffic Statistics Monitoring

Parameter	Default Setting
Traffic Summary	
Auto Refresh	Disabled
Refresh Rate	10 seconds

Part 36

Mirroring Traffic

CHAPTERS

1. Mirroring
2. Configuration Examples
3. Appendix: Default Parameters

1 Mirroring

You can analyze network traffic and troubleshoot network problems using Mirroring. Mirroring allows the switch to send a copy of the traffic that passes through specified sources (ports, LAGs or the CPU) to a destination port. It does not affect the switching of network traffic on source ports, LAGs or the CPU.

1.1 Using the GUI

Choose the menu **MAINTENANCE > Mirroring** to load the following page.

Figure 1-1 Port Mirroring Session List

Port Mirroring Session List				
Session	Destination Port	Mode	Source Interfaces	Operation
1		Ingress Only Egress Only Both		Edit Clear
Total: 1				

The above page displays a mirroring session, and no more session can be created. Click **Edit** to configure this mirroring session on the following page.

Figure 1-2 Configure the Mirroring Session

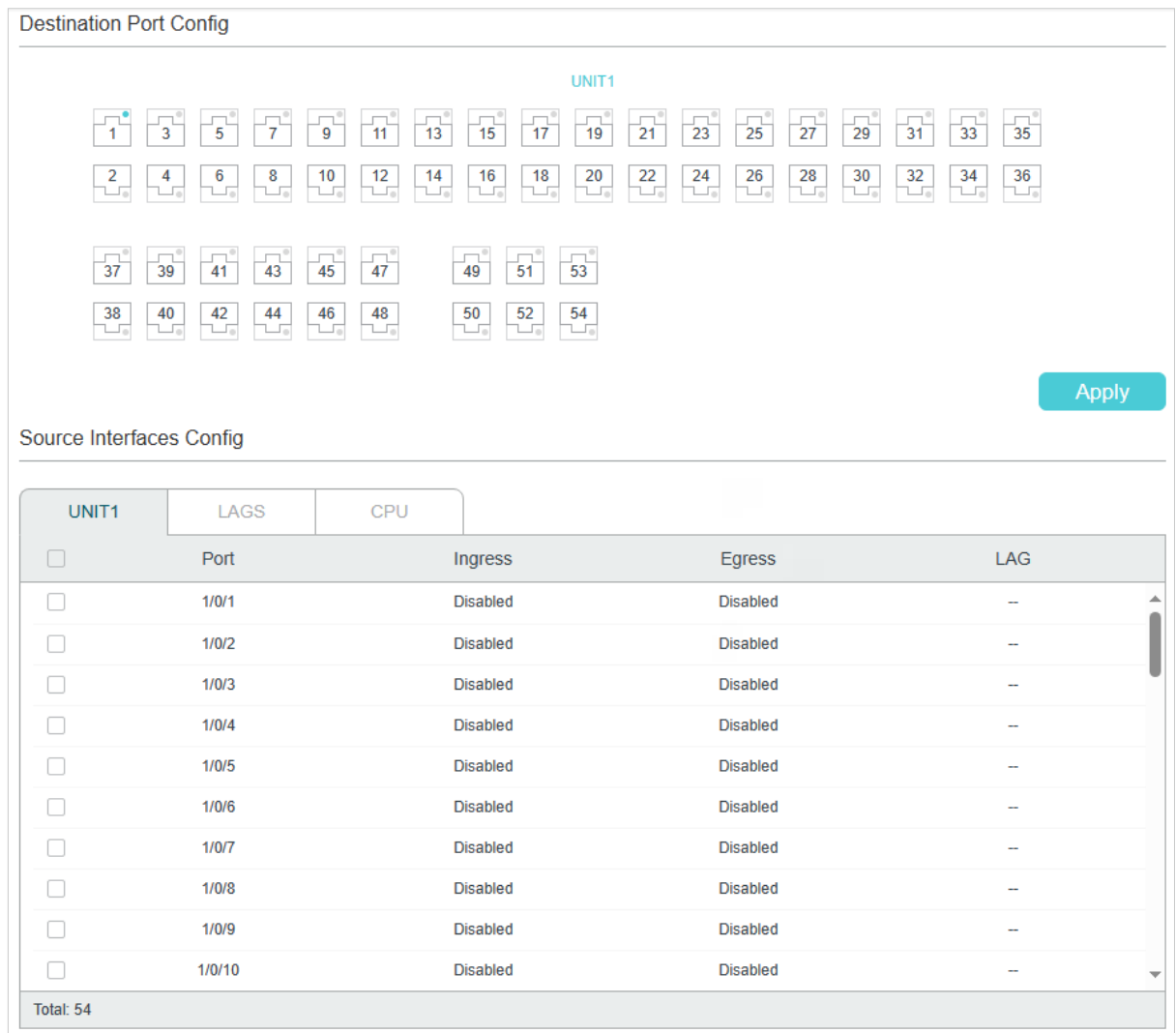

Follow these steps to configure the mirroring session:

- 1) In the **Destination Port Config** section, specify a destination port for the mirroring session, and click **Apply**.
- 2) In the **Source Interfaces Config** section, specify the source interfaces and click **Apply**. Traffic passing through the source interfaces will be mirrored to the destination port. There are three source interface types: port, LAG, and CPU. Choose one or more types according to your need.

Port

Click the Unit ID and select the desired ports as the source interfaces.

Ingress: Send a copy of traffic received by the port to the monitoring port.

Egress: Send a copy of traffic sent by the port to the monitoring port.

LAGS

Select the desired LAGs as the source interfaces.

Ingress: Send a copy of traffic received by the LAG members to the monitoring port.

Egress: Send a copy of traffic sent by the LAG members to the monitoring port.

CPU

Configure the CPU as the source interfaces.

Ingress: Send a copy of traffic received by the CPU to the monitoring port.

Egress: Send a copy of traffic sent by the CPU to the monitoring port.

 **Note:**

- The member ports of an LAG cannot be set as a destination port or source port.
 - A port cannot be set as the destination port and source port at the same time.
-

1.2 Using the CLI

Follow these steps to configure Mirroring.

Step 1	<p>configure</p> <p>Enter global configuration mode.</p>
Step 2	<p>monitor session <i>session_num</i> destination interface { fastEthernet <i>port</i> gigabitEthernet <i>port</i> ten-gigabitEthernet <i>port</i> }</p> <p>Enable the port mirror function and set the destination port.</p> <p><i>session_num</i>: The monitor session number. It can only be specified as 1.</p> <p><i>port</i>: The destination port number. You can specify only one destination port for the mirror session.</p>
Step 3	<p>monitor session <i>session_num</i> source { cpu <i>cpu_numbr</i> interface { fastEthernet <i>port-list</i> gigabitEthernet <i>port-list</i> ten-gigabitEthernet <i>port-list</i> port-channel <i>port-channel-id</i> } } mode</p> <p>Configure ports or LAGs as the monitored interfaces.</p> <p><i>session_num</i>: The monitor session number. It can only be specified as 1.</p> <p><i>cpu_number</i>: The CPU number. It can only be specified as 1.</p> <p><i>port-list</i>: List of source ports. It is multi-optional.</p> <p><i>mode</i>: The monitor mode. There are three options: rx, tx and both:</p> <p>rx: The incoming packets of the source port will be copied to the destination port.</p> <p>tx: The outgoing packets of the source port will be copied to the destination port.</p> <p>both: Both of the incoming and outgoing packets on source port can be copied to the destination port.</p> <p>Note:</p> <p>You can configure one or more source interface types (ports, LAGs and the CPU) according to your needs.</p>
Step 4	<p>show monitor session</p> <p>Verify the Port Mirror configuration.</p>
Step 5	<p>end</p> <p>Return to privileged EXEC mode.</p>
Step 6	<p>copy running-config startup-config</p> <p>Save the settings in the configuration file.</p>

The following example shows how to copy the received and transmitted packets on port 1/0/1,2,3 and the CPU to port 1/0/10.

Switch#configure

```
Switch(config)#monitor session 1 destination interface gigabitEthernet 1/0/10
```

```
Switch(config)#monitor session 1 source interface gigabitEthernet 1/0/1-3 both
```

```
Switch(config)#monitor session 1 source cpu 1 both
```

Switch(config)#show monitor session

```
Monitor Session:          1
Destination Port:        Gi1/0/10
Source Ports(Ingress):   Gi1/0/1-3
Source Ports(Egress):    Gi1/0/1-3
Source CPU(Ingress):     cpu1
Source CPU(Egress):      cpu1
```

Switch(config-if)#end

Switch#copy running-config startup-config

Follow these steps to configure the RSPAN monitoring:

Step 1 **configure**

Enter global configuration mode.

Step 2 **monitor session 1 destination remote vlan *vlanid***

Configure the RSPAN VLAN for remote port monitoring of egress packets. Please set the destination port before using this command. To disable this function, use the no monitor session 1 destination remote vlan command.

vlanid: Remote port monitoring export message VLAN. The value ranges from 2 to 4094 and is mutually exclusive with voice VLAN and internal VLAN

Step 3 **monitor session 1 source remote vlan *vlanid***

Monitor the packets added to the RSPAN VLAN port. To disable this function, use the no monitor session 1 source remote vlan command.

vlanid: VLAN ID, ranging from 1 to 4094.

Step 4 **end**

Return to privileged EXEC mode.

Step 5 **copy running-config startup-config**

Save the settings in the configuration file.

2 Configuration Examples

2.1 Network Requirements

As shown below, several hosts and a network analyzer are directly connected to the switch. For network security and troubleshooting, the network manager needs to use the network analyzer to monitor the data packets from the end hosts.

Figure 2-1 Network Topology

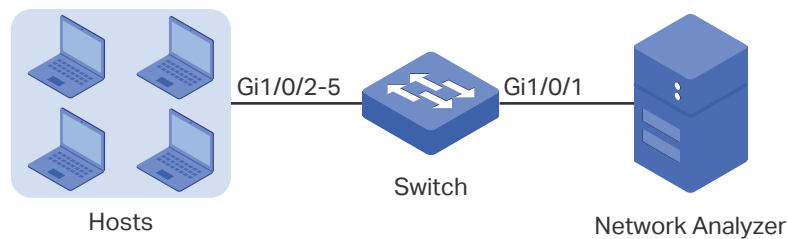

2.2 Configuration Scheme

To implement this requirement, you can use Mirroring feature to copy the packets from ports 1/0/2-5 to port 1/0/1. The overview of configuration is as follows:

- 1) Specify ports 1/0/2-5 as the source ports, allowing the switch to copy the packets from the hosts.
- 2) Specify port 1/0/1 as the destination port so that the network analyzer can receive mirrored packets from the hosts.

Demonstrated with SG6654XHP, the following sections provide configuration procedure in two ways: using the GUI and using the CLI.

2.3 Using the GUI

- 1) Choose the menu **MAINTENANCE > Mirroring** to load the following page. It displays the information of the mirroring session.

Figure 2-2 Mirror Session List

Port Mirroring Session List				
Session	Destination Port	Mode	Source Interfaces	Operation
1		Ingress Only Egress Only Both		Edit Clear
Total: 1				

- Click **Edit** on the above page to load the following page. In the **Destination Port Config** section, select port 1/0/1 as the destination port and click **Apply**.

Figure 2-3 Destination Port Configuration

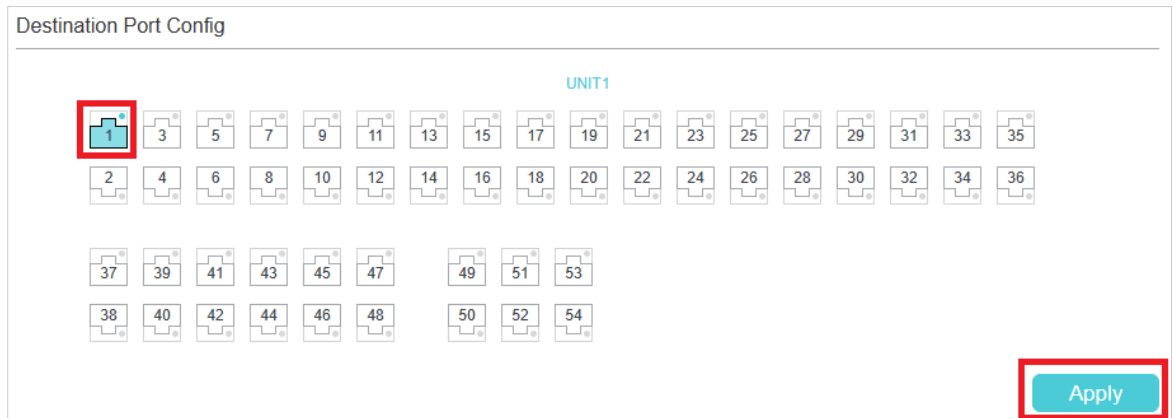

- In the **Source Interfaces Config** section, select ports 1/0/2-5 as the source ports, and enable **Ingress** and **Egress** to allow the received and sent packets to be copied to the destination port. Then click **Apply**.

Figure 2-4 Source Port Configuration

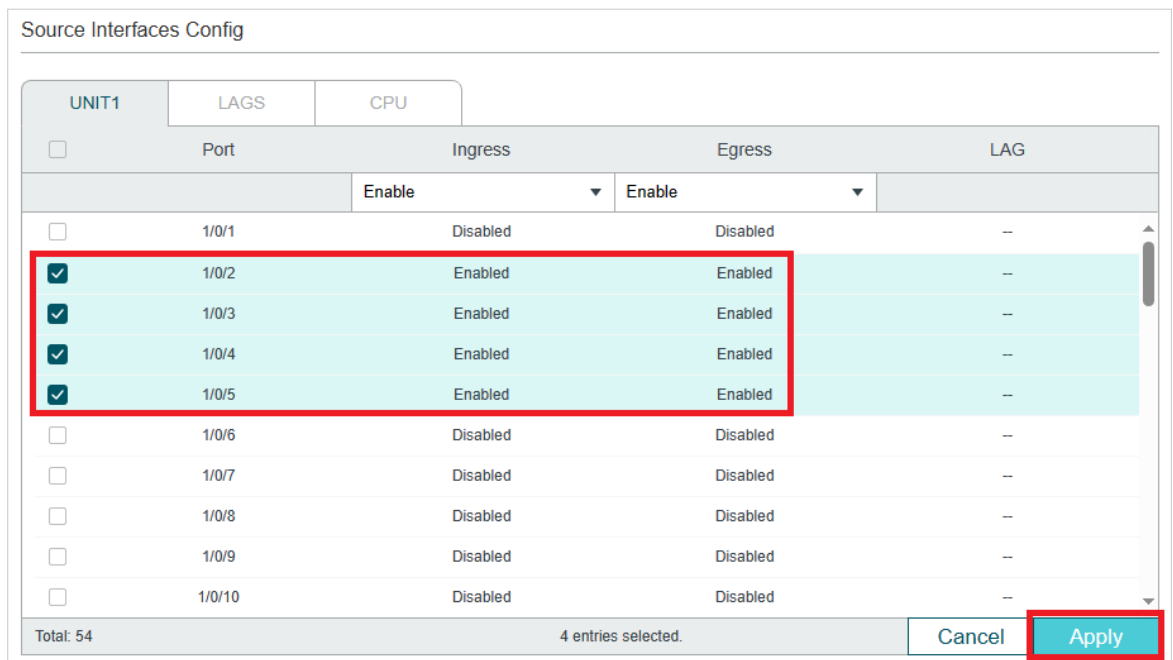

- Click  to save the settings.

2.4 Using the CLI

```
Switch#configure
```

```
Switch(config)#monitor session 1 destination interface gigabitEthernet 1/0/1
```

```
Switch(config)#monitor session 1 source interface gigabitEthernet 1/0/2-5 both
```

```
Switch(config)#end
```

```
Switch#copy running-config startup-config
```

Verify the Configuration

```
Switch#show monitor session 1
```

```
Monitor Session:      1
```

```
Destination Port:     Gi1/0/1
```

```
Source Ports(Ingress): Gi1/0/2-5
```

```
Source Ports(Egress):  Gi1/0/2-5
```

3 Appendix: Default Parameters

Default settings of Switching are listed in the following tables.

Table 3-1 Configurations for Ports

Parameter	Default Setting
Ingress	Disabled
Egress	Disabled

Part 37

Configuring sFlow

(Only for Certain Devices)

CHAPTERS

1. Overview
2. sFlow Configuration
3. Configuration Example
4. Appendix: Default Parameters

1 Overview

 **Note:**

sFlow is only available on certain devices. To check whether your device supports this feature, refer to the actual web interface. If sFlow is available, there is **MAINTENANCE > sFlow** in the menu structure.

sFlow is used to monitor high-speed switched and routed networks. The sFlow monitoring system consists of an sFlow agent (embedded in a switch or router or in a standalone probe) and an sFlow collector (installed in a host).

sFlow Agent

The sFlow Agent is embedded in a switch or router or in a standalone probe. It uses sampling technology to capture traffic statistics from the device it is monitoring, and packages the sampled data into sFlow datagrams. sFlow datagrams are used to immediately forward the sampled data to an sFlow Collector for analysis.

The switch provides a packet-based sFlow, which samples one packet out of a specified number of packets.

sFlow Collector

The sFlow Collector is installed in a host. It analyzes sFlow datagrams to produce a rich, real-time, network-wide view of traffic flows.

2 sFlow Configuration

To complete the configuration, follow these steps:

- 1) Configure the sFlow Agent.
- 2) Configure the sFlow Collector.
- 3) Configure the sFlow Sampler.

Configuration Guidelines

To get analytic results, you should choose a proper collector. For details on sFlow collectors, refer to <https://sflow.org>.

2.1 Using the GUI

2.1.1 Configuring the sFlow Agent

Choose the menu **MAINTENANCE > sFlow > sFlow Agent** to load the following page.

Figure 2-1 Configuring the sFlow Agent

Follow these steps to configure the sFlow Agent:

- 1) Enable the sFlow function, specify the sFlow Agent IP address.

sFlow Agent	Enable or disable sFlow agent. When enabled, the switch acts as an sFlow agent.
Agent Address	Enter the IP address of the sFlow agent. Normally it is the management IP address of the switch.
sFlow Version	Displays the sFlow version.

- 2) Click **Apply**.

Note:

- A valid Agent Address should be assigned before you enable the sFlow function.

2.1.2 Configuring the sFlow Collector

Choose the menu **MAINTENANCE > sFlow > sFlow Collector** to load the following page.

Figure 2-2 Configuring the sFlow Collector

Collector Config							
<input type="checkbox"/>	Collector ID	Description	Collector IP	Collector Port	Maximum Datagram Size	Timeout (s)	Lifetime (s)
<input checked="" type="checkbox"/>	1		0.0.0.0	6343	300	0	0
<input type="checkbox"/>	2		0.0.0.0	6343	300	0	0
<input type="checkbox"/>	3		0.0.0.0	6343	300	0	0
<input type="checkbox"/>	4		0.0.0.0	6343	300	0	0
Total: 4			1 entry selected.			<input type="button" value="Cancel"/>	<input type="button" value="Apply"/>

Follow these steps to configure the sFlow Collector:

- 1) Select a Collector and configure the relevant parameters.

Collector ID	Displays the Collector ID. The switch supports 4 collectors at most.
Description	Give a collector description for identification with 16 characters at most.
Collector IP	Enter the IP address of the host that runs the sFlow collector.
Collector Port	Specify the UDP port number for the sFlow collector. The default is port 6343.
Maximum Datagram Size	Specify the maximum number of data bytes that can be sent in a single sample datagram. Valid values are from 300 to 1400 bytes and the default is 300 bytes.
Timeout (s)	Specify the aging time after which the sFlow collector will become invalid. The values are from 0 to 2000000 seconds; the default is 0, which means the collector is always valid.
Lifetime (s)	Displays the remaining time of the collector. Lifetime counts down from Timeout.

- 2) Click **Apply**.

Note:

- A timeout value of 0 indicates that the collector will never time out.

2.1.3 Configuring the sFlow Sampler

An sFlow Sampler is a data source that collects flow samples. Usually the ports act as sFlow Samplers.

Choose the menu **MAINTENANCE > sFlow> sFlow Sampler** to load the following page.

Figure 2-3 Configuring the sFlow Sampler

Global Config

Ingress Sampling Rate: Hz (0 or 1024-65535)

Egress Sampling Rate: Hz (0 or 1024-65535)

[Apply](#)

Sampler Config

UNIT1

<input type="checkbox"/>	Port	Collector ID	Maximum Header Size (Bytes)	LAG
<input type="checkbox"/>	1/0/1	0	128	--
<input type="checkbox"/>	1/0/2	0	128	--
<input type="checkbox"/>	1/0/3	0	128	--
<input type="checkbox"/>	1/0/4	0	128	--
<input type="checkbox"/>	1/0/5	0	128	--
<input type="checkbox"/>	1/0/6	0	128	--
<input type="checkbox"/>	1/0/7	0	128	--
<input type="checkbox"/>	1/0/8	0	128	--
<input type="checkbox"/>	1/0/9	0	128	--
<input type="checkbox"/>	1/0/10	0	128	--

Total: 54

Follow these steps to configure the sFlow Sampler:

- 1) Set one or more ports to be Samplers and configure the relevant parameters . One port can be bound to only one collector.

Collector ID	Choose a collector to be bound with the port.
Ingress Sampling Rate (Hz)	Specify the ingress sampling frequency; the sampler takes one packet out of the specified number of packets. The default is 0 which means no packets will be sampled.
Egress Sampling Rate (Hz)	Specify the egress sampling frequency; the sampler takes one packet out of the specified number of packets. The default is 0 which means no packets will be sampled.
Maximum Header Size (Bytes)	Specify the maximum number of bytes that should be copied from a sampled packet. Valid values are from 18 to 256 bytes and the default is 128 bytes.
LAG	Displays the LAG that the port belongs to.

- 2) Click **Apply**.

 **Note:**

- Each port can be bound to only one collector.
 - To disable the sampling feature on a port, you can set the Collector ID as 0, or configure both the Ingress Sampling Rate and Egress Sampling Rate as 0.
-

2.2 Using the CLI

Follow these steps to configure the sFlow:

-
- | | |
|--------|--|
| Step 1 | configure
Enter global configuration mode. |
|--------|--|
-
- | | |
|--------|--|
| Step 2 | sflow address { ipv4-addr }
Configure the IP address of sFlow Agent.

<i>ipv4-addr</i> : Enter the management IP address of the switch to monitor traffic on the switch ports. |
|--------|--|
-
- | | |
|--------|---|
| Step 3 | sflow enable
Enable the sFlow function. |
|--------|---|
-
- | | |
|--------|---|
| Step 4 | sflow collector collector-ID value { [descript <i>descript</i>] [[ip <i>ip</i>] [port <i>port</i>] [maxData <i>maxData</i>] [timeout <i>timeout</i>] }
Configure parameters of the sFlow collector.

<i>value</i> : Enter the ID of the sFlow collector. The values are from 1 to 4.
<i>descript</i> : Give a collector description for identification with 16 characters at most.
<i>ip</i> : Enter the IP address of the host that runs the sFlow collector.
<i>port</i> : Enter the UDP port number for the sFlow collector. The default is port 6343.
<i>maxData</i> : Specify the maximum number of data bytes that can be sent in a single sample datagram. The values are from 300 to 1400 bytes; the default is 300 bytes.
<i>timeout</i> : Specify the aging time after which the sFlow collector will become invalid. The values are from 0 to 2000000 seconds; the default is 0, which means the collector is always valid. |
|--------|---|
-

Step 5 **sflow sampler** { [collector-ID value] [inRate ingress-rate] [egRate egress-rate] [maxHeader maxHeader] }

Configure parameters of the sFlow sampler.

value: Enter the ID of the sFlow collector which the sFlow sampler will send sFlow datagrams to. The values are from 0 to 4. 0 means sampling feature is disabled on the port.

ingress-rate: Specify the ingress sampling frequency. The samplers takes one packet out of the specified number of packets. Valid values are from 1024 to 65535. The default is 0 which means no packets will be sampled.

egress-rate: Specify the egress sampling frequency. The samplers takes one packet out of the specified number of packets. Valid values are from 1024 to 65535. The default is 0 which means no packets will be sampled.

maxHeader: Specify the maximum number of bytes that should be copied from a sampled packet. Valid values are from 18 to 256 bytes and the default is 128 bytes.

Step 6 **interface** { fastEthernet port | range fastEthernet port-list | gigabitEthernet port | range gigabitEthernet port-list | ten-gigabitEthernet port | range ten-gigabitEthernet port-list }

Configure the sampler on the specified ports.

port/port-list: The number or the list of the Ethernet ports that you want to monitor.

Step 7 **show sflow** { [global] [collector] [sampler] }

Verify the sFlow configurations.

global: View the global configuration of sFlow.

collector: View the global configuration of the sFlow collector.

sampler: View the global configuration of the sFlow sampler.

Step 8 **end**

Return to privileged EXEC mode.

Step 9 **copy running-config startup-config**

Save the settings in the configuration file.

The following example shows how to configure the switch whose IP address is 192.168.0.1 to send sFlow packets to the host whose IP address is 192.168.0.100. Set the sFlow agent IP address as 192.168.0.1, the sFlow collector IP address 1 as 192.168.0.100; configure Gigabit Ethernet port 1 as the sFlow sampler, the Collector-ID as 1, and the ingress rate as 1024:

Switch#configure

Switch(config)#sflow address 192.168.0.1

Switch(config)#sflow enable

Switch(config)#sflow collector collector-ID 1 ip 192.168.0.100

Switch(config)# sflow collector collector-ID 1 port 6343

Switch(config)#interface gigabitEthernet 1/0/1

Switch(config-if)#sflow sampler collector-ID 1

Switch(config-if)#show sflow global

SFLOW Global State: Enable

SFLOW Agent IP: 192.168.0.1

SFLOW Version: v5

Switch(config-if)#show sflow collector

Collector	Col-IP	Col-Port	MaxData	Timeout	Lifetime	Description
1	192.168.0.100	6343	300	0	0	

...

Switch(config-if)#show sflow sampler

Sample Rate:

Ingress Sampling Rate: 0

Egress Sampling Rate: 0

Port	Collector	MaxHeader	LAG
Gi1/0/1	1	128	N/A
Gi1/0/2	0	128	N/A
Gi1/0/3	0	128	N/A

...

Switch(config-if)#end

Switch#copy running-config startup-config

3 Configuration Example

3.1 Network Requirements

The company network manager needs to monitor and analyze the network usage in department A.

Figure 3-1 Network Topology

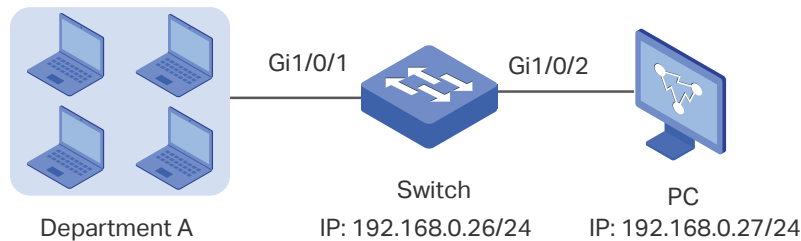

3.2 Configuration Scheme

The network manager can configure sFlow to monitor and analyze the network. Set the switch as the sFlow Agent that collects traffic data on port 1/0/1, and configure an sFlow Collector on the PC to process sFlow packets and display results.

Demonstrated with T2600G-28TS, this chapter provides configuration procedures in two ways: using the GUI and Using the CLI.

3.3 Using the GUI

- 1) Choose the menu **MAINTENANCE > sFlow > sFlow Agent** to load the following page. Enable sFlow Agent, set the switch IP address 192.168.0.26 as the Agent address, and click **Apply**.

Figure 3-2 Configuring sFlow Agent

sFlow Agent Config

sFlow Agent: Enable

Agent Address: (Format: 192.168.0.1)

sFlow Version: 5

- 2) Choose the menu **MAINTENANCE > sFlow > sFlow Collector** to load the following page. Select Collector 1, enter the PC's IP address 192.168.0.27 as the Collector IP address, and click **Apply**.

Figure 3-3 Configuring sFlow Collector

Collector Config

<input type="checkbox"/>	Collector ID	Description	Collector IP	Collector Port	Maximum Datagram Size	Timeout (s)	Lifetime (s)
<input checked="" type="checkbox"/>	1		192.168.0.27	6343	300	0	0
<input type="checkbox"/>	2		0.0.0.0	6343	300	0	0
<input type="checkbox"/>	3		0.0.0.0	6343	300	0	0
<input type="checkbox"/>	4		0.0.0.0	6343	300	0	0

Total: 4 1 entry selected.

- 3) Choose the menu **MAINTENANCE > sFlow > sFlow Sampler** to load the following page. Select Collector 1 for port 1/0/1, set the ingress rate as 1024, then click **Apply**.

Figure 3-4 Configuring sFlow Sampler

Global Config

Ingress Sampling Rate: Hz (0 or 1024-65535)

Egress Sampling Rate: Hz (0 or 1024-65535)

Sampler Config

UNIT1

<input type="checkbox"/>	Port	Collector ID	Maximum Header Size (Bytes)	LAG
<input checked="" type="checkbox"/>	1/0/1	1	128	--
<input type="checkbox"/>	1/0/2	0	128	--
<input type="checkbox"/>	1/0/3	0	128	--
<input type="checkbox"/>	1/0/4	0	128	--
<input type="checkbox"/>	1/0/5	0	128	--
<input type="checkbox"/>	1/0/6	0	128	--
<input type="checkbox"/>	1/0/7	0	128	--
<input type="checkbox"/>	1/0/8	0	128	--
<input type="checkbox"/>	1/0/9	0	128	--
<input type="checkbox"/>	1/0/10	0	128	--

Total: 54 1 entry selected.

- 4) Click  to save the settings.

3.4 Using the CLI

- 1) Configure the sFlow Agent.

Switch#configure

```
Switch(config)#sflow address 192.168.0.26
```

```
Switch(config)#sflow enable
```

- 2) Configure the sFlow collector.

```
Switch(config)#sflow collector collector-ID 1 ip 192.168.0.27
```

```
Switch(config)# sflow collector collector-ID 1 port 6343
```

- 3) Configure the sFlow sampler.

```
Switch(config)#interface gigabitEthernet 1/0/1
```

```
Switch(config-if)#sflow sampler collector-ID 1
```

```
Switch(config-if)#sflow sampler ingRate 1024
```

```
Switch(config-if)#end
```

```
Switch#copy running-config startup-config
```

Verify the Configurations

Verify the configuration of global sFlow:

```
Switch#show sflow global
```

```
sFlow Status: Enable
```

```
Agent Address: 192.168.0.26
```

```
sFlow Version: v5
```

Verify the configuration of sFlow collector:

```
Switch#show sflow collector
```

Collector	Col-IP	Col-Port	MaxData	Timeout	Lifetime	Description
-----	-----	-----	-----	-----	-----	-----
1	192.168.0.27	6343	300	0	0	
2	0.0.0.0	6343	300	0	0	
3	0.0.0.0	6343	300	0	0	
4	0.0.0.0	6343	300	0	0	

Verify the configuration of sFlow sampler:

```
Switch#show sflow sampler
```

Port	Collector	IngRate	EgRate	MaxHeader	LAG
-----	-----	-----	-----	-----	---
Gi1/0/1	1	1024	1024	128	N/A
Gi1/0/2	0	0	0	128	N/A
...					

4 Appendix: Default Parameters

Default settings of maintenance are listed in the following tables.

Table 4-1 Default Settings of sFlow

Parameter	Default Setting
sFlow Agent	
sFlow Agent	Disabled
Agent Address	0.0.0.0
sFlow Version	5
sFlow Collector	
Collector IP	0.0.0.0
Collector Port	6343
Maximum Datagram Size	300 bytes
Timeout (s)	0
sFlow Sampler	
Collector ID	0, indicates sampling feature is disabled on the port.
Ingress Sampling Rate (Hz)	0
Egress Sampling Rate (Hz)	0
Maximum Header Size (Bytes)	128

Part 38

Configuring OAM

(Only for Certain Devices)

CHAPTERS

1. Ethernet OAM
2. Ethernet OAM Configurations
3. Viewing OAM Statistics
4. Configuration Example
5. Appendix: Default Parameters

1 Ethernet OAM

1.1 Overview

Note:

Ethernet OAM is only available on certain devices. To check whether your device supports this feature, refer to the actual web interface. If Ethernet OAM is available, there is **MAINTENANCE > Ethernet OAM** in the menu structure.

Ethernet OAM (Operation, Administration, and Maintenance) is a Layer 2 protocol for monitoring and troubleshooting Ethernet networks. It can monitor link performance, monitor faults and generate alarms so that a network administrator can manage the network effectively. TP-Link switches support EFM OAM which is defined in IEEE 802.3ah.

The following basic concepts of OAM will be introduced: OAM entity, OAMPDUs (OAM Protocol Data Units), and OAM connection.

OAM Entity

A port that is enabled with OAM on the switch is called an OAM entity.

OAMPDUs

Through OAMPDUs exchanged between OAM entities, failure conditions on the network are reported to network administrators. The OAMPDUs are defined as follows:

- **Information OAMPDU:** The Information OAMPDU is used to send state information, such as local information, remote information, and user-defined information, to the remote OAM entity for maintaining OAM connection.
- **Event Notification OAMPDU:** The Event Notification OAMPDU is used for the Link Monitoring feature. The local OAM entity can use the Event Notification OAMPDU to notify the remote OAM entity that a fault has occurred to the link.
- **Loopback Control OAMPDU:** Loopback Control OAMPDU is used for the Remote Loopback feature. The local OAM entity can control OAM remote loopback state of the remote OAM entity through the Loopback Control OAMPDU.

OAM Connection

OAM connection is established between OAM entities before OAM works. An OAM entity can operate in two modes: active and passive. Only the active OAM entity can initiate an OAM connection; the passive OAM entity waits and responds to OAM connection establishment requests. So at least one of the two entities should be in active mode.

Figure 1-1 OAM Connection Establishment

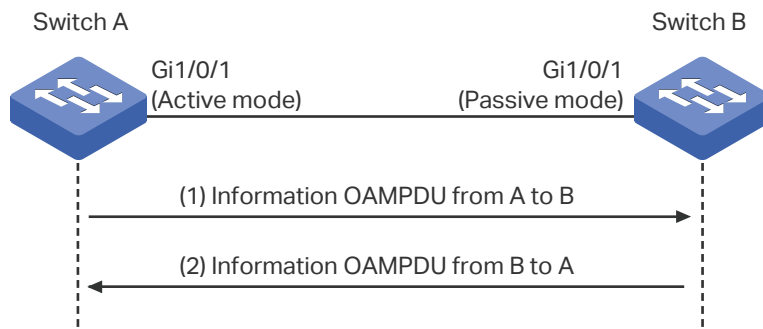

As the above figure shows, the OAM entity on Switch A is in active mode, and that on Switch B is in passive mode. Switch A initiates an OAM connection by sending an Information OAMPDU. Switch B compares the OAM information in the received OAMPDU with its own and sends back an Information OAMPDU to Switch A. If the OAM information of the two entities matches, an OAM connection will be established. After that, the two OAM entities will exchange Information OAMPDUs periodically to keep the OAM connection valid.

1.2 Supported Features

The switch supports the following OAM features: Link Monitoring, Remote Failure Indication (RFI), and Remote Loopback.

Link Monitoring

Link Monitoring is for monitoring link performance under various circumstances. When problems are detected on the link, the OAM entity will send its remote peer the Event Notification OAMPDUs to report link events.

The link events are described as follows:

Table 1-1 OAM Link Events

OAM Link Events	Definition
Error Symbol Period	An Error Symbol Period event occurs if the number of error symbols exceeds the defined threshold within a specific period of time.
Error Frame	An Error Frame event occurs if the number of error frames exceeds the defined threshold within a specific period of time.
Error Frame Period	An Error Frame Period event occurs if the number of error frames in a specific number of received frames exceeds the defined threshold.
Error Frame Seconds	An Error Frame Seconds event occurs if the number of error frame seconds exceeds the threshold within a specific period of time. A second is defined as an error frame second if error frames occur within that second.

Remote Failure Indication (RFI)

With Remote Failure Indication, an OAM entity can send the failure conditions of the link, such as disruption in traffic because of the device failure, to its peer through Information OAMPDUs. This allows the network administrator to stay informed of the link faults and take action quickly. The switch supports two kinds of failure conditions:

Dying Gasp: An unrecoverable fault, such as power failure, occurs.

Critical Event: Unspecified critical event occurs.

Remote Loopback

With Remote Loopback, administrators can test link performance including the delay, jitter, and frame loss rate during installation or troubleshooting.

Figure 1-2 Remote Loopback

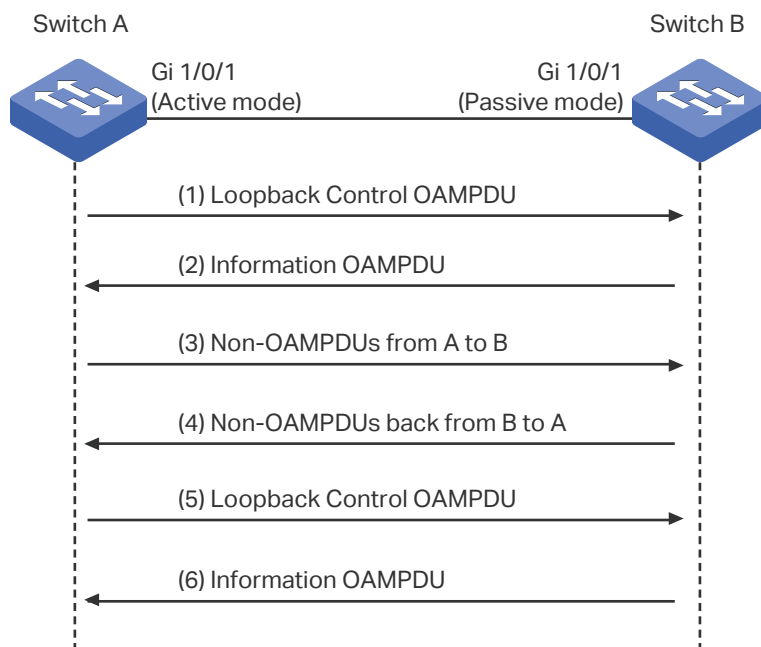

As the above figure shows, the OAM connection has been established between the two entities. The OAM entity on Switch A is in active mode, and that on Switch B is in passive mode.

The working mechanism of Remote Loopback is as follows:

- 1) Switch A sends a Loopback Control OAMPDU to put the peer into remote loopback mode. Note that at least one of the two entities should be configured in active mode because only the entity in active mode can generate Loopback Control OAMPDU.
- 2) After receiving the Loopback Control OAMPDU, Switch B turns into remote loopback mode and sends an Information OAMPDU to inform its state updating.
- 3) Switch A sends Non-OAMPDU packets to Switch B for link testing.
- 4) Switch B receives the testing packets and sends back these packets along the original path. Through these returned packets, administrators can test the link performance.

- 5) When Remote Loopback is finished, Switch A sends a Loopback Control OAMPDU to disable the remote loopback mode on Switch B.
- 6) Switch B receives the Loopback Control OAMPDU and exits remote loopback mode. Besides, Switch B sends an Information OAMPDU to inform its state updating.

TP-Link switches can act as Switch A and initiate Remote Loopback request.

2 Ethernet OAM Configurations

To complete OAM configurations, follow these steps:

- 1) Enable OAM and configure OAM mode on the port.
- 2) Configure the following OAM features according to your needs:
 - Link Monitoring
 - Remote Failure Indication (RFI)
 - Remote Loopback
- 3) View the OAM status on the port.

2.1 Using the GUI

2.1.1 Enabling OAM and Configuring OAM Mode

Choose the menu **MAINTENANCE > Ethernet OAM > Basic Config > Basic Config** to load the following page.

Figure 2-1 Basic Configuration

Basic Config			
UNIT1			
<input type="checkbox"/>	Port	Mode	Status
<input type="checkbox"/>	1/0/1	Active	Disabled
<input type="checkbox"/>	1/0/2	Active	Disabled
<input type="checkbox"/>	1/0/3	Active	Disabled
<input type="checkbox"/>	1/0/4	Active	Disabled
<input type="checkbox"/>	1/0/5	Active	Disabled
<input type="checkbox"/>	1/0/6	Active	Disabled
<input type="checkbox"/>	1/0/7	Active	Disabled
<input type="checkbox"/>	1/0/8	Active	Disabled
<input type="checkbox"/>	1/0/9	Active	Disabled
<input type="checkbox"/>	1/0/10	Active	Disabled
Total: 54			

Follow these steps to complete the basic OAM configuration:

- 1) Select one or more ports, configure the OAM mode and enable OAM.

Mode	Select OAM mode for the port. Active: The port in this mode can initiate OAM connection. Passive: The port in this mode cannot initiate OAM connection or send loopback control OAMPDUs. Note: OAM connection cannot be established between two ports in passive mode. Make sure that at least one side is in active mode.
Status	Enable or disable OAM on the port. By default, it is disabled.

2) Click **Apply**.

2.1.2 Configuring Link Monitoring

Choose the menu **MAINTENANCE > Ethernet OAM > Link Monitoring > Link Monitoring** to load the following page.

Figure 2-2 Configure Link Monitoring

Link Event

Current Link Event: Error Symbol Period ▼

Link Monitoring Config

UNIT1	Port	Threshold (Error Symbols)	Window (100ms)	Event Notification
<input type="checkbox"/>	1/0/1	1	10	Enabled
<input type="checkbox"/>	1/0/2	1	10	Enabled
<input type="checkbox"/>	1/0/3	1	10	Enabled
<input type="checkbox"/>	1/0/4	1	10	Enabled
<input type="checkbox"/>	1/0/5	1	10	Enabled
<input type="checkbox"/>	1/0/6	1	10	Enabled
<input type="checkbox"/>	1/0/7	1	10	Enabled
<input type="checkbox"/>	1/0/8	1	10	Enabled
<input type="checkbox"/>	1/0/9	1	10	Enabled
<input type="checkbox"/>	1/0/10	1	10	Enabled
Total: 54				

Follow these steps to configure Link Monitoring:

1) In the **Link Event** section, select a Link Event type to configure.

Current Link Event

Select a Link Event type to be configured. The following options are provided:

Error Symbol Period: An Error Symbol Period event occurs if the number of error symbols exceeds the defined threshold within a specific period of time.

Error Frame: An Error Frame event occurs if the number of error frames exceeds the defined threshold within a specific period of time.

Error Frame Period: An Error Frame Period event occurs if the number of error frames in a specific number of received frames exceeds the defined threshold.

Error Frame Seconds: An Error Frame Seconds event occurs if the number of error frame seconds exceeds the threshold within a specific period of time. A second is defined as an error frame second if error frames occur within that second.

- 2) In the **Link Monitoring Config** section, select one or more ports, and configure the threshold and period for the selected link event.

Threshold

Specify the threshold for the selected link event.

Threshold (Error Symbols): If you select **Error Symbol Period** as the link event type, specify the threshold of received error symbols within a specific period of time. Valid error frame values are from 1 to 4294967295, and the default value is 1.

Threshold (Error Frames): If you select **Error Frame** or **Error Frame Period** as the link event type, specify the threshold of error frames within a specific period of time or in specific number of received frames. Valid error frame values are from 1 to 4294967295, and the default value is 1.

Threshold (Error Seconds): If you select **Error Frame Seconds** as the link event type, specify the threshold of error frame seconds. Valid values are from 1 to 900, and the default value is 1.

Window

Specify the period for the selected link event.

Window (100ms): If you select **Error Symbol Period**, **Error Frame** or **Error Frame Seconds** as the link event type, specify the time period in units of 100ms (for example, 2 refers to 200ms), in which if the received errors exceed the threshold, a link event will be generated. For **Error Symbol Period** and **Error Frame**, valid values are from 10*100 to 600*100 ms. For **Error Frame Seconds**, valid values are from 100*100 to 9000*100 ms.

Window (Frames): If you select **Error Frame Period** as the link event type, specify the number of frames, in which if the frame errors exceed the threshold, a link event will be generated. Valid values are from 148810 to 89286000 frames, and the default value is 1488100 frames.

Event Notification

Enable or disable notifications to report the link event. By default, all types of link event can be reported.

- 3) Click **Apply**.

2.1.3 Configuring RFI

Choose the menu **MAINTENANCE > Ethernet OAM > Remote Failure Indication** to load the following page.

Figure 2-3 Configure RFI

Remote Failure Indication Config			
UNIT1			
<input type="checkbox"/>	Port	Dying Gasp Notification	Critical Event Notification
<input type="checkbox"/>	1/0/1	Enabled	Enabled
<input type="checkbox"/>	1/0/2	Enabled	Enabled
<input type="checkbox"/>	1/0/3	Enabled	Enabled
<input type="checkbox"/>	1/0/4	Enabled	Enabled
<input type="checkbox"/>	1/0/5	Enabled	Enabled
<input type="checkbox"/>	1/0/6	Enabled	Enabled
<input type="checkbox"/>	1/0/7	Enabled	Enabled
<input type="checkbox"/>	1/0/8	Enabled	Enabled
<input type="checkbox"/>	1/0/9	Enabled	Enabled
<input type="checkbox"/>	1/0/10	Enabled	Enabled
Total: 54			

Follow these steps to configure Remote Failure Indication:

- 1) Select one or more ports and configure the Dying Gasp Notification and Critical Event Notification features.

Dying Gasp Notification

With Dying Gasp Notification enabled, if the switch detects an unrecoverable fault on the network, it will report this condition locally and send Information OAMPDU to notify the peer.

Critical Event Notification

With Critical Event Notification enabled, if the switch detects an unspecified critical event occurs, it will report this condition locally and send Information OAMPDU to notify the peer.

- 2) Click **Apply**.

2.1.4 Configuring Remote Loopback

Choose the menu **MAINTENANCE > Ethernet OAM > Remote Loopbak** to load the following page.

Figure 2-4 Configure Remote Loopback

Remote Loopback Config			
UNIT1			
<input type="checkbox"/>	Port	Received Remote Loopback	Remote Loopback
<input checked="" type="checkbox"/>	1/0/1	Ignore	---
<input type="checkbox"/>	1/0/2	Ignore	---
<input type="checkbox"/>	1/0/3	Ignore	---
<input type="checkbox"/>	1/0/4	Ignore	---
<input type="checkbox"/>	1/0/5	Ignore	---
<input type="checkbox"/>	1/0/6	Ignore	---
<input type="checkbox"/>	1/0/7	Ignore	---
<input type="checkbox"/>	1/0/8	Ignore	---
<input type="checkbox"/>	1/0/9	Process	---
<input type="checkbox"/>	1/0/10	Ignore	---

Follow these steps to configure Remote Loopback:

- 1) Select one or more ports and configure the relevant options.

Received Remote Loopback

Choose to ignore or to process the received remote loopback requests.

Remote Loopback

Start or stop the remote loopback process. The port to be configured should be in active mode and has established OAM connection with the peer.

Start: Request the remote peer to start the OAM remote loopback mode.

Stop: Request the remote peer to stop the OAM remote loopback mode.

- 2) Click **Apply**.

2.1.5 Viewing OAM Status

Choose the menu **MAINTENANCE > Ethernet OAM > Basic Config > Discovery Info** to load the following page.

Figure 2-5 View OAM Status

Discovery Info

UNIT1

Selected

Unselected

Not Available

Local Client	
OAM Status:	Disabled
Mode:	Active
Maximum OAMPDU:	1518 Bytes
Remote Loopback:	Not Supported
Unidirection:	Not Supported
Link Monitoring:	Supported
Variable Request:	Not Supported
PDU Revision:	0
Operation Status:	Disable
Loopback Status:	No Loopback

Select a port to view whether the OAM connection is established with the peer. Additionally, you can view the OAM information of the local and the remote entities.

The OAM information of the local entity is as follows:

OAM Status	Displays whether OAM is enabled on the port.
Mode	Displays OAM mode of the local entity.
Maximum OAMPDU	Displays the maximum size of OAMPDUs.
Remote Loopback	Displays whether the local entity supports Remote Loopback.
Unidirection	Displays whether the local entity supports Unidirection.
Link Monitoring	Displays whether the local entity supports Link Monitoring.

Variable Request	Displays whether the local entity supports Variable Request.
PDU Revision	Displays the PDU Revision of the local entity.
Operation Status	<p>Displays the status of OAM connection:</p> <p>Disable: OAM is disabled on the port.</p> <p>LinkFault: The link between the local entity and the remote entity is down.</p> <p>PassiveWait: The port is in passive mode and is waiting to see if the peer device is OAM capable.</p> <p>ActiveSendLocal: The port is in active mode and is sending local information.</p> <p>SendLocalAndRemote: The local port has discovered the peer but has not yet accepted or rejected the configuration of the peer.</p> <p>SendLocalAndRemoteOK: The local device agrees the OAM peer entity.</p> <p>PeeringLocallyRejected: The local OAM entity rejects the remote peer OAM entity.</p> <p>PeeringRemotelyRejected: The remote OAM entity rejects the local device.</p> <p>NonOperHalfDuplex: Ethernet OAM is enabled but the port is in half-duplex operation. You should configure the port as a full-duplex port.</p> <p>Operational: OAM connection is established with the peer and OAM works normally.</p>
Loopback Status	<p>Displays the loopback status.</p> <p>No Loopback: Neither the local entity nor the remote entity is in the loopback mode.</p> <p>Local Loopback: The local entity is in the loopback mode.</p> <p>Remote Loopback: The remote entity is in the loopback mode.</p>

The OAM information of the remote entity is as follows:

Mode	Displays the OAM mode of the remote entity.
MAC Address	Displays the MAC address of the remote entity.
Vendor (OUI)	Displays the Vendor's OUI of the remote entity.
Maximum OAMPDU	Displays the maximum size of OAMPDU.
Remote Loopback	Displays whether the remote entity supports Remote Loopback.
Unidirection	Displays whether the remote entity supports Unidirection.
Link Monitoring	Displays whether the remote entity supports Link Monitoring.

Variable Request	Displays whether the remote entity supports Variable Request.
PDU Revision	Displays the PDU Revision of the remote entity.
Vendor Information	Displays the vendor information of the remote entity.

2.2 Using the CLI

2.2.1 Enabling OAM and Configuring OAM Mode

Follow these steps to enable OAM and configure OAM mode on the port:

Step 1	configure Enter global configuration mode.
Step 2	interface {fastEthernet port range fastEthernet port-list gigabitEthernet port range gigabitEthernet port-list ten-gigabitEthernet port range ten-gigabitEthernet port-list} Enter interface configuration mode.
Step 3	ethernet-oam Enable OAM on the port.
Step 4	ethernet-oam mode { passive active } Configure the OAM mode of the port. passive: Specify the OAM mode as passive. The port in this mode cannot initiate OAM connection or send Loopback Control OAMPDU. active: Specify the OAM mode as active. The port in this mode can initiate OAM connection. It is the default setting. Note: OAM connection cannot be established between two ports in passive mode. Make sure that at least one side is in active mode.
Step 5	show ethernet-oam configuration [interface fastEthernet { port port-list } interface gigabitEthernet { port port-list } ten-gigabitEthernet { port port-list }] Verify the OAM configuration.
Step 6	end Return to privileged EXEC mode.
Step 7	copy running-config startup-config Save the settings in the configuration file.

The following example shows how to enable OAM and configure the OAM mode as passive on port 1/0/1.

```
Switch#configure
```

```
Switch(config)#interface gigabitEthernet 1/0/1
```

```
Switch(config-if)#ethernet-oam
```

```
Switch(config-if)#ethernet-oam mode passive
```

```
Switch(config-if)#show ethernet-oam configuration interface gigabitEthernet 1/0/1
```

```
Gi1/0/1
```

```
-----
```

```
OAM          : Enabled
```

```
Mode         : Passive
```

```
...
```

```
Switch(config-if)#end
```

```
Switch#copy running-config startup-config
```

2.2.2 Configuring Link Monitoring

With Link Monitoring, the following link events can be reported: Error Symbol Period, Error Frame, Error Frame Period, Error Frame Seconds.

■ Configuring Error Symbol Period Event

An Error Symbol Period event occurs if the number of symbol errors exceeds the defined threshold within a specific period of time.

Follow these steps to configure the Error Symbol Period event:

Step 1	configure Enter global configuration mode.
Step 2	interface {fastEthernet port range fastEthernet port-list gigabitEthernet port range gigabitEthernet port-list ten-gigabitEthernet port range ten-gigabitEthernet port-list} Enter interface configuration mode.

Step 3	ethernet-oam link-monitor symbol-period [threshold <i>threshold</i>] [window <i>window</i>] [notify {disable enable}]
	Configure the relevant parameters of Error Symbol Period event.
	<i>threshold</i> : Specify the threshold of received symbol errors within a specific period of time. Valid values are from 1 to 4294967295, and the default value is 1.
	<i>window</i> : Specify the time period in units of 100ms (for example, 2 refers to 200ms), in which if the received errors exceed the threshold, a link event will be generated. Valid values are from 10*100 to 600*100 ms, and the default value is 10*100 ms.
	<i>disable enable</i> : Enable or disable notifications to report the link event. By default, it is enabled.
Step 4	show ethernet-oam configuration [interface fastEthernet { port port-list } interface gigabitEthernet { port port-list } interface ten-gigabitEthernet { port port-list }]
	Verify the OAM configuration.
Step 5	end
	Return to privileged EXEC mode.
Step 6	copy running-config startup-config
	Save the settings in the configuration file.

The following example shows how to enable Error Frame event notification and configure the threshold as 1 and the window as 1000 ms (10*100 ms) on port 1/0/1:

Switch#configure

Switch(config)#interface gigabitEthernet 1/0/1

Switch(config-if)#ethernet-oam link-monitor symbol-period threshold 1 window 10 notify enable

Switch(config-if)#show ethernet-oam configuration interface gigabitEthernet 1/0/1

Gi1/0/1

...

Symbol Period Error

Notify State : Enabled

Window : 1000 milliseconds

Threshold : 1 Error Symbol

...

Switch(config-if)#end

Switch#copy running-config startup-config

■ Configuring Error Frame Event

An Error Frame event occurs if the number of frame errors exceeds the defined threshold within a specific period of time.

Follow these steps to configure the Error Frame event:

Step 1	configure Enter global configuration mode.
Step 2	interface {fastEthernet port range fastEthernet port-list gigabitEthernet port range gigabitEthernet port-list ten-gigabitEthernet port range ten-gigabitEthernet port-list} Enter interface configuration mode.
Step 3	ethernet-oam link-monitor frame [threshold threshold] [window window] [notify {disable enable}] Configure the relevant parameters of Error Frame event. <i>threshold:</i> Specify the threshold of received frame errors within a specific period of time. Valid values are from 1 to 4294967295, and the default value is 1. <i>window:</i> Specify the time period in units of 100ms (for example, 2 refers to 200ms), in which if the number of received errors exceeds the threshold, a link event will be generated. Valid values are from 10*100 to 600*100 ms, and the default value is 10*100 ms. <i>disable enable:</i> Enable or disable notifications to report the link event. By default, it is enabled.
Step 4	show ethernet-oam configuration [interface fastEthernet { port port-list } interface gigabitEthernet { port port-list } ten-gigabitEthernet { port port-list }] Verify the OAM configuration.
Step 5	end Return to privileged EXEC mode.
Step 6	copy running-config startup-config Save the settings in the configuration file.

The following example shows how to enable Error Frame notification and configure the threshold as 1 and the window as 2000 ms (20*100 ms) on port 1/0/1:

```
Switch#configure
```

```
Switch(config)#interface gigabitEthernet 1/0/1
```

```
Switch(config-if)#ethernet-oam link-monitor frame threshold 1 window 20 notify enable
```

```
Switch(config-if)#show ethernet-oam configuration interface gigabitEthernet 1/0/1
```

Gi1/0/1

...

Frame Error

Notify State : Enabled

Window : 2000 milliseconds

Threshold : 1 Error Frame

...

Switch(config-if)#end

Switch#copy running-config startup-config

■ Configuring Error Frame Period Event

An Error Frame Period event occurs if the number of frame errors in specific number of received frames exceeds the defined threshold.

Follow these steps to configure the Error Frame Period event:

Step 1	configure Enter global configuration mode.
Step 2	interface {fastEthernet port range fastEthernet port-list gigabitEthernet port range gigabitEthernet port-list ten-gigabitEthernet port range ten-gigabitEthernet port-list} Enter interface configuration mode.
Step 3	ethernet-oam link-monitor frame-period [threshold threshold] [window window] [notify {disable enable}] Configure the relevant parameters of Error Frame Period. <i>threshold</i> : Specify the threshold of received symbol errors in specific number of received frames. Valid values are from 1 to 4294967295, and the default value is 1. <i>window</i> : Specify the number of frames, in which if the frame errors exceed the threshold, a link event will be generated. Valid values are from 148810 to 89286000, and the default value is 1488100. <i>disable enable</i> : Enable or disable the port to report the failure condition.
Step 4	show ethernet-oam configuration [interface fastEthernet {port port-list} interface gigabitEthernet {port port-list} ten-gigabitEthernet {port port-list}] Verify the OAM configuration.
Step 5	end Return to privileged EXEC mode.

Step 6 **copy running-config startup-config**

Save the settings in the configuration file.

The following example shows how to enable Error Frame Period notification and configure the threshold as 1 and the window as 1488100 on port 1/0/1:

Switch#configure

Switch(config)#interface gigabitEthernet 1/0/1

Switch(config-if)#ethernet-oam link-monitor frame-period threshold 1 window 1488100 notify enable

Switch(config-if)#show ethernet-oam configuration interface gigabitEthernet 1/0/1

Gi1/0/1

...

Frame Period Error

Notify State : Enabled

Window : 1488100 Frames

Threshold : 1 Error Frame

...

Switch(config-if)#end

Switch#copy running-config startup-config

■ Configuring Error Frame Seconds Event

An Error Frame Seconds event occurs if the number of error frame seconds exceeds the threshold within a specific period of time. A second is called an error frame second if error frames occur in the second.

Follow these steps to configure Error Frame Seconds event:

Step 1 **configure**

Enter global configuration mode.

Step 2 **interface {fastEthernet port | range fastEthernet port-list | gigabitEthernet port | range gigabitEthernet port-list | ten-gigabitEthernet port | range ten-gigabitEthernet port-list}**

Enter interface configuration mode.

Step 3	ethernet-oam link-monitor frame-seconds [threshold threshold] [window window] [notify {disable enable}]
	Configure the relevant parameters of Error Frame Period.
	<i>threshold</i> : Specify the threshold of received error frame seconds within a specific period of time. Valid values are from 1 to 900, and the default value is 1.
	<i>window</i> : Specify the period time in 100ms, in which if the received errors exceed the threshold, a link event will be generated. Valid values are from 100*100 to 9000*100 ms, and the default value is 600*100 ms.
	<i>disable enable</i> : Enable or disable the port to report the failure condition.
Step 4	show ethernet-oam configuration [interface fastEthernet { port port-list } interface gigabitEthernet { port port-list } ten-gigabitEthernet { port port-list }]
	Verify the OAM configuration.
Step 5	end
	Return to privileged EXEC mode.
Step 6	copy running-config startup-config
	Save the settings in the configuration file.

The following example shows how to enable Error Frame Seconds notification and configure the threshold as 1 and the window as 80000 ms (800*100 ms) on port 1/0/1:

Switch#configure

Switch(config)#interface gigabitEthernet 1/0/1

Switch(config-if)#ethernet-oam link-monitor frame-seconds threshold 1 window 800 notify enable

Switch(config-if)#show ethernet-oam configuration interface gigabitEthernet 1/0/1

Gi1/0/1

...

Frame Seconds Error

Notify State : Enabled

Window : 80000 milliseconds

Threshold : 1 Error Seconds

...

Switch(config-if)#end

Switch#copy running-config startup-config

2.2.3 Configuring Remote Failure Indication

Follow these steps to configure Remote Failure Indication:

Step 1	configure Enter global configuration mode.
Step 2	interface {fastEthernet port range fastEthernet port-list gigabitEthernet port range gigabitEthernet port-list ten-gigabitEthernet port range ten-gigabitEthernet port-list} Enter interface configuration mode.
Step 3	ethernet-oam remote-failure { dying-gasp critical-event } notify { disable enable } Configure the Dying Gasp Notification and Critical Event Notification features on the port. dying-gasp: Enable Dying Gasp Notification, and if the switch detects an unrecoverable fault on the network, such as power failure, occurs, it will send Information OAMPDU to notify the peer. critical-event: Enable Critical Event Notification, and if the switch detects an unspecified critical event occurs, it will send Information OAMPDU to notify the peer. disable enable: Enable or disable notification to report the link events.
Step 4	show ethernet-oam configuration [interface fastEthernet { port port-list } interface gigabitEthernet { port port-list } ten-gigabitEthernet { port port-list }] Verify the OAM configuration.
Step 5	end Return to privileged EXEC mode.
Step 6	copy running-config startup-config Save the settings in the configuration file.

The following example shows how to enable Dying Gasp and Critical Event on port 1/0/1:

```
Switch#configure
```

```
Switch(config)#interface gigabitEthernet 1/0/1
```

```
Switch(config-if)#ethernet-oam remote-failure dying-gasp notify enable
```

```
Switch(config-if)#ethernet-oam remote-failure critical-event notify enable
```

```
Switch(config-if)#show ethernet-oam configuration interface gigabitEthernet 1/0/1
```

```
Gi1/0/1
```

```
-----
```

```
...
```

```
Dying Gasp      : Enabled
```

Critical Event : Enabled

...

Switch(config-if)#end

Switch#copy running-config startup-config

2.2.4 Configuring Remote Loopback

Follow these steps to configure Remote Loopback:

Step 1	configure Enter global configuration mode.
Step 2	interface {fastEthernet port range fastEthernet port-list gigabitEthernet port range gigabitEthernet port-list ten-gigabitEthernet port range ten-gigabitEthernet port-list} Enter interface configuration mode.
Step 3	ethernet-oam remote-loopback received-remote-loopback { process ignore } Configure the port to ignore or to process the received remote loopback request.
Step 4	ethernet-oam remote-loopback { start stop } Request the remote peer to start or stop the OAM remote loopback mode. The port to be configured here should be in active mode that has established OAM connection with the peer.
Step 5	show ethernet-oam configuration [interface fastEthernet { port port-list } interface gigabitEthernet { port port-list } ten-gigabitEthernet { port port-list }] Verify the OAM configuration.
Step 6	end Return to privileged EXEC mode.
Step 7	copy running-config startup-config Save the settings in the configuration file.

The following example shows how to start the OAM remote loopback mode of the peer on port 1/0/1:

Switch#configure

Switch(config)#interface gigabitEthernet 1/0/1

Switch(config-if)# ethernet-oam remote-loopback start

2.2.5 Verifying OAM Connection

On privileged EXEC mode or any other configuration mode, you can use the following command to view whether the OAM connection is established with the peer. Additionally, you can view the OAM information of the local entity and the remote entity.

```
show ethernet-oam status [ interface fastEthernet { port | port-list } | interface gigabitEthernet { port | port-list } | ten-gigabitEthernet { port | port-list }]
```

View the OAM status and the relevant information of the specified port, including the local entity and the remote entity.

The displayed OAM information of the local entity is as follows:

OAM: Displays whether OAM is enabled.

Mode: Displays OAM mode of the local entity.

Max OAMPDU: Displays the maximum size of OAMPDU.

Remote Loopback: Displays whether the local entity supports Remote Loopback.

Unidirection: Displays whether the local entity supports Unidirection.

Link Monitoring: Displays whether the local entity supports Link Monitoring.

Variable Request: Displays whether the local entity supports Variable Request.

PDU Revision: Displays the PDU Revision of the local entity.

Operation Status: Displays the status of OAM connection, including:

Disable: OAM is disabled on the port.

LinkFault: The link between the local entity and the remote entity is down.

PassiveWait: The port is in passive mode and is waiting to see if the peer device is OAM capable.

ActiveSendLocal: The port is in active mode and is sending local information.

SendLocalAndRemote: The local port has discovered the peer but has not yet accepted or rejected the configuration of the peer.

SendLocalAndRemoteOK: The local device agrees the OAM peer entity.

PeeringLocallyRejected: The local OAM entity rejects the remote peer OAM entity.

PeeringRemotelyRejected: The remote OAM entity rejects the local device.

NonOperHalfDuplex: Ethernet OAM is enabled but the port is in half-duplex operation. You should configure the port as a full-duplex port.

Operational: OAM connection is established with the peer and OAM works normally.

Loopback Status: Displays the loopback status, including:

No Loopback: Neither the local client nor the remote client is in the loopback mode.

Local Loopback: The local client is in the loopback mode.

Remote Loopback: The remote client is in the loopback mode.

The displayed OAM information of the remote entity is as follows:

Mode: Displays OAM mode of the local entity.

MAC Address: Displays the MAC address of the remote entity.

Vendor (OUI): Displays the Vendor's OUI of the remote entity.

Max OAMPDU: Displays the maximum size of OAMPDU.

Remote Loopback: Displays whether the remote entity supports Remote Loopback.

Unidirection: Displays whether the remote entity supports Unidirection.

Link Monitoring: Displays whether the remote entity supports Link Monitoring.

Variable Request: Displays whether the remote entity supports Variable Request.

PDU Revision: Displays the PDU Revision of the remote entity.

Vendor Information: Displays the vendor information of the remote entity.

The following example shows how to view the OAM status of port 1/0/1:

```
Switch(config)#show ethernet-oam status interface gigabitEthernet 1/0/1
```

```
Gi1/0/1
```

```
Local Client
```

```
-----  
OAM           : Enabled
```

```
Mode          : Active
```

```
Max OAMPDU    : 1518 Bytes
```

```
Remote Loopback : Supported
```

```
Unidirection  : Not Supported
```

Link Monitoring : Supported
Variable Request : Not Supported
PDU Revision : 1
Operation Status : Operational
Loopback Status : No Loopback

Remote Client

Mode : Passive
MAC Address : 18-A6-F7-DB-63-81
Vendor(OUI) : 000aeb
Max OAMPDU : 1518 Bytes
Remote Loopback : Supported
Unidirection : Not Supported
Link Monitoring : Supported
Variable Request : Not Supported
PDU Revision : 1
Loopback Status : No Loopback
Vendor Information : 00000000

3 Viewing OAM Statistics

You can view the following OAM statistics:

- OAMPDUs
- Event Logs

3.1 Using the GUI

3.1.1 Viewing OAMPDUs

Choose the menu **MAINTENANCE > Ethernet OAM > Statistics > OAMPDUs Statistics** to load the following page.

Figure 3-1 OAMPDUs Statistics

OAMPDUs Statistics

UNIT1

Selected Unselected Not Available

Port 1/0/1:	Tx	Rx
Information OAMPDUs	0	0
Unique Event Notification OAMPDUs	0	0
Duplicate Event Notification OAMPDUs	0	0
Variable Request OAMPDUs	0	0
Variable Response OAMPDUs	0	0
Loopback Control OAMPDUs	0	0
Organization Specific OAMPDUs	0	0
Unsupported OAMPDUs	0	0
Frames Lost Due to OAM	0	

Select a port and view the number of different OAMPDUs transmitted and received on it:

Tx	Displays the number of OAMPDUs that have been transmitted on the port.
Rx	Displays the number of OAMPDUs that have been received on the port.
Information OAMPDUs	Displays the number of Information OAMPDUs that have been transmitted or received on the port.
Unique Event Notification OAMPDUs	Displays the number of Unique Event Notification OAMPDUs that have been transmitted or received on the port.
Duplicate Event Notification OAMPDUs	Displays the number of Duplicate Event Notification OAMPDUs that have been transmitted or received on the port.
Variable Request OAMPDUs	Displays the number of Variable Request OAMPDUs that have been transmitted or received on the port.
Variable Response OAMPDUs	Displays the number of Variable Response OAMPDUs that have been transmitted or received on the port.
Loopback Control OAMPDUs	Displays the number of Loopback Control OAMPDUs that have been transmitted or received on the port.
Organization Specific OAMPDUs	Displays the number of Organization Specific OAMPDUs that have been transmitted or received on the port.
Unsupported OAMPDUs	Displays the number of Unsupported OAMPDUs that have been transmitted or received on the port.
Frames Lost Due To OAM	Displays the number of frames that are not transmitted successfully on the OAM sublayer but not due to an internal OAM error.

3.1.2 Viewing Event Logs

Choose the menu **MAINTENANCE > Ethernet OAM > Statistics > Event Logs Statistics** to load the following page.

Figure 3-2 Event Logs Statistics

Event Logs Statistics

UNIT1

1

2

3

4

5

6

7

8

9

10

11

12

13

14

15

16

17

18

19

20

21

22

23

24

25

26

27

28

29

30

31

32

33

34

35

36

37

38

39

40

41

42

43

44

45

46

47

48

49

50

51

52

53

54

Selected

Unselected

Not Available

Port undefined:

↻ Refresh
 ✕ Clear

	Local	Remote
Error Symbol Period Events	0	0
Error Frame Events	0	0
Error Frame Period Events	0	0
Error Frame Seconds Events	0	0
Dying Gasp Events	0	0
Critical Events	0	0

Event Log Table:

Type	Location	Timestamp	Value	Window	Threshold	Accumulated Errors
No entries in this table.						

Select a port and view the local and remote event logs on it.

Local	Displays the number of link events that have occurred on the local link.
Remote	Displays the number of link events that have occurred on the remote link.
Error Symbol Period Events	Displays the number of error symbol period link events that have occurred on the local link or remote link.
Error Frame Events	Displays the number of error frame link events that have occurred on the local link or remote link.
Error Frame Period Events	Displays the number of error frame period link events that have occurred on the local link or remote link.

Error Frame Seconds Events	Displays the number of error frame seconds link events that have occurred on the local link or remote link.
Dying Gasp Events	Displays the number of Dying Gasp link events that have occurred on the local link or remote link.
Critical Events	Displays the number of Critical Event link events that have occurred on the local link or remote link.

Additionally, you can view the detailed information of the event logs in the **Event Log Table** section.

Type	Displays the types of the link event.
Location	Displays the location where the link event occurred.
Timestamp	Displays the time reference when the link event occurred.
Value	Displays the number of symbol errors or frame errors in the period.
Window	Displays the period of the link event.
Threshold	Displays the threshold of the errors.
Accumulated Errors	Displays the number of errors that have been detected since the OAM feature was last reset.

3.2 Using the CLI

3.2.1 Viewing OAMPDUs

On privileged EXEC mode or any other configuration mode, you can use the following command to view the number of OAMPDUs received and sent on the specified port.

```
show ethernet-oam statistics [ interface fastEthernet { port | port-list } | interface gigabitEthernet { port | port-list } | ten-gigabitEthernet { port | port-list }]
```

View the number of different OAMPDUs transmitted and received on the specified port, including Information OAMPDU, Unique Event Notification OAMPDU, Duplicate Event Notification OAMPDU, Loopback Control OAMPDU, Variable Request OAMPDU, Variable Response OAMPDU, Organization Specific OAMPDUs, Unsupported OAMPDU, and Frames Lost Due To OAM (frames that are not transmitted successfully on the OAM sublayer but not due to an internal OAM error).

The following example shows how to view the transmitted and received OAMPDUs on port 1/0/1.

```
Switch#show ethernet-oam statistics interface gigabitEthernet 1/0/1
```

```
Gi1/0/1
```

```
-----
```

Information OAMPDU TX	: 28
Information OAMPDU RX	: 28
Unique Event Notification OAMPDU TX	: 0
Unique Event Notification OAMPDU RX	: 0
Duplicate Event Notification OAMPDU TX	: 0
Duplicate Event Notification OAMPDU RX	: 0
Loopback Control OAMPDU TX	: 1
Loopback Control OAMPDU RX	: 0
Variable Request OAMPDU TX	: 0
Variable Request OAMPDU RX	: 0
Variable Response OAMPDU TX	: 0
Variable Response OAMPDU RX	: 0
Organization Specific OAMPDUs TX	: 0
Organization Specific OAMPDUs RX	: 0
Unsupported OAMPDU TX	: 0
Unsupported OAMPDU RX	: 0
Frames Lost Due To OAM	: 0

3.2.2 Viewing Event Logs

On privileged EXEC mode or any other configuration mode, you can use the following command to view the local and remote event logs on the specified port.

```
show ethernet-oam event-log [ interface fastEthernet { port | port-list } | interface gigabitEthernet { port | port-list } | ten-gigabitEthernet { port | port-list }]
```

View the local and remote event logs on the specified port.

An event list will be displayed, including the following information:

Type: Displays the type of the link event.

Location: Displays the location where the link event occurred (local or remote).

Timestamp: Displays the time reference when the link event occurred.

And the number of local and remote event logs will be displayed, including the following events:

Error Symbol Event: Displays the number of error symbol period link events that have occurred on the local link or remote link.

Error Frame Event: Displays the number of error frame link events that have occurred on the local link or remote link.

Error Frame Period Event: Displays the number of error frame period link events that have occurred on the local link or remote link.

Error Frame Seconds Event: Displays the number of error frame seconds link events that have occurred on the local link or remote link.

Dying Gasp: Displays the number of Dying Gasp link events that have occurred on the local link or remote link.

Critical Event: Displays the number of Critical Event link events that have occurred on the local link or remote link.

The following example shows how to view the event logs on port 1/0/1.

```
Switch#show ethernet-oam event-log interface gigabitEthernet 1/0/1
```

```
Gi1/0/1
```

```
Event Listing
```

```
-----
Type           Location      Time Stamp
-----
Critical Event Remote        2016-01-01 08:08:00
```

```
Local Event Statistics
```

```
Error Symbol Event : 0
```

Error Frame Event : 0

Error Frame Period Event : 0

Error Frame Seconds Event : 0

Dying Gasp : 0

Critical Event : 0

Remote Event Statistics

Error Symbol Event : 0

Error Frame Event : 0

Error Frame Period Event : 0

Error Frame Seconds Event : 0

Dying Gasp : 0

Critical Event : 1

4 Configuration Example

4.1 Network Requirements

A network administrator wants to manage and troubleshoot the network more effectively, requiring that the link failure and frame errors on the link between Switch A and Switch B can be monitored and reported via the Ethernet OAM feature.

Figure 4-1 Network Topology



4.1.1 Configuration Scheme

To meet the requirement, configure OAM on port 1/0/1 of each switch. Two features can be configured: Link Monitoring and Remote Failure Indication. With Link Monitoring, the frame errors on the link can be monitored and reported; with Remote Failure Indication, the link failure can be monitored and reported.

The overview of configuration is as follows:

- 1) Enable OAM and configure the OAM mode for port 1/0/1 on each switch. Here we configure OAM mode of the port on Switch A as active, and that on switch B as passive.
- 2) Configure Link Monitoring for port 1/0/1 on each switch.
- 3) Configure Remote Failure Indication for port 1/0/1 on each switch.

Demonstrated with T2600G-28TS, the following sections provide configuration procedure in two ways: using the GUI and using the CLI.

4.1.2 Using the GUI

The configurations for Switch A and Switch B are similar. We take Switch A as an example.

- 1) Choose the menu **MAINTENANCE > Ethernet OAM > Basic Config > Basic Config** to load the following page. Select port 1/0/1, and configure the mode as Active and the state as Enable. Click **Apply**.

Figure 4-2 Basic Configuration

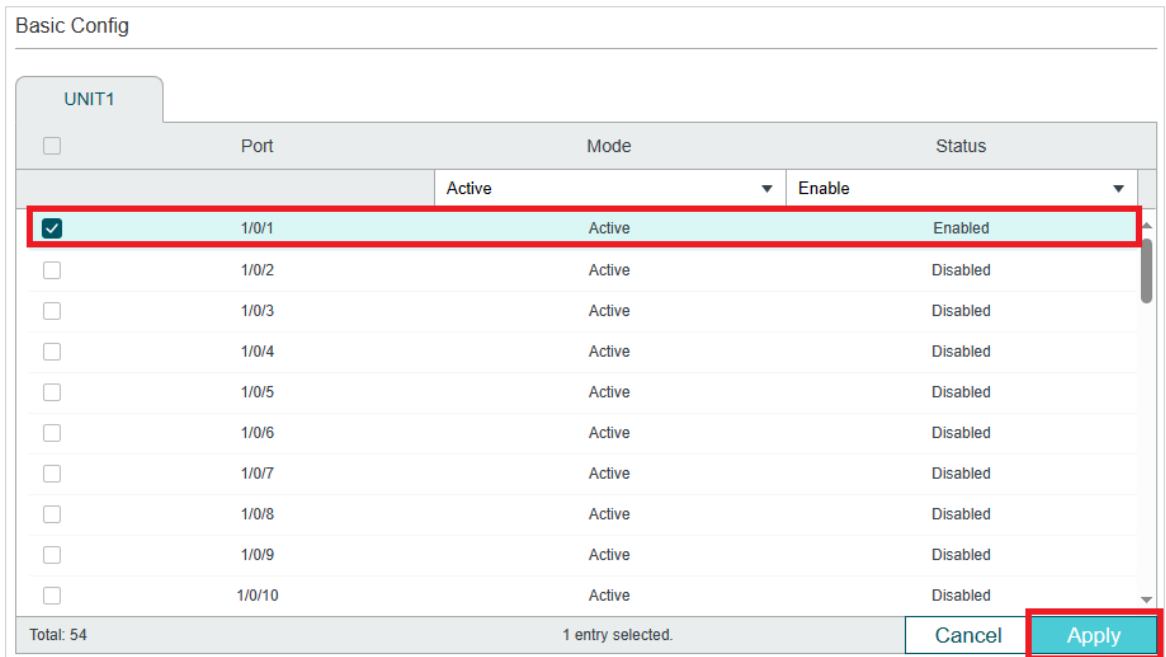

- 2) Choose the menu **MAINTENANCE > Ethernet OAM > Link Monitoring** to load the following page. Select each Link Event type and configure the relevant parameters on port 1/0/1. Make sure that Event Notification is enabled and specify the threshold and window according to your needs. Here we keep the default parameters. Click **Apply**.

Figure 4-3 Link Monitoring Configuration

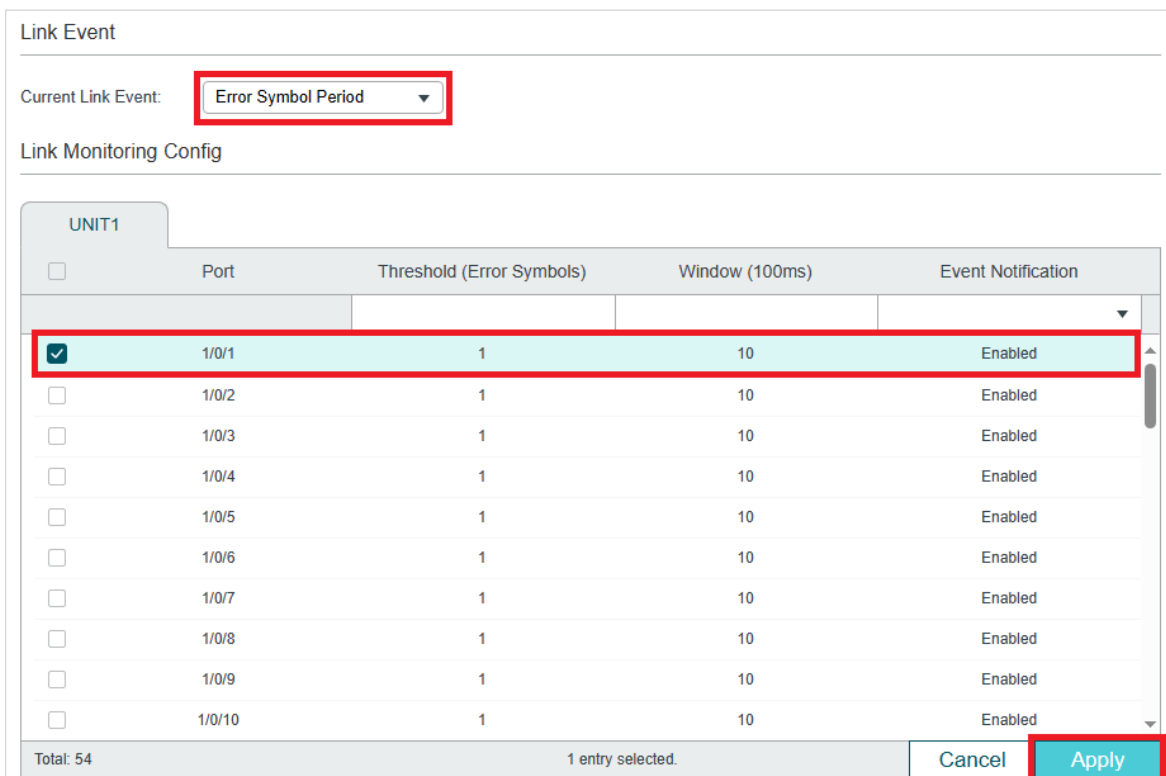

- 3) Choose the menu **MAINTENANCE > Ethernet OAM > Remote Failure Indication** to load the following page. Select port 1/0/1 and enable Dying Gasp Notification and Critical Event Notification. Click **Apply**.

Figure 4-4 Remote Failure Indication Configuration

Remote Failure Indication Config

UNIT1

<input type="checkbox"/>	Port	Dying Gasp Notification	Critical Event Notification
<input checked="" type="checkbox"/>	1/0/1	Enabled	Enabled
<input type="checkbox"/>	1/0/2	Enabled	Enabled
<input type="checkbox"/>	1/0/3	Enabled	Enabled
<input type="checkbox"/>	1/0/4	Enabled	Enabled
<input type="checkbox"/>	1/0/5	Enabled	Enabled
<input type="checkbox"/>	1/0/6	Enabled	Enabled
<input type="checkbox"/>	1/0/7	Enabled	Enabled
<input type="checkbox"/>	1/0/8	Enabled	Enabled
<input type="checkbox"/>	1/0/9	Enabled	Enabled
<input type="checkbox"/>	1/0/10	Enabled	Enabled

Total: 54 1 entry selected.

- 4) Choose the menu **MAINTENANCE > Ethernet OAM > Basic Config > Discovery Info** to load the following page. Select port 1/0/1 to check the OAM status. When the connection status becomes **Operational**, it indicates that OAM connection has been established and OAM works normally.

Figure 4-5 Discovery Information

Local Client	
OAM Status:	Enabled
Mode:	Active
Maximum OAMPDU:	1518 Bytes
Remote Loopback:	Supported
Unidirection:	Not Supported
Link Monitoring:	Supported
Variable Request:	Not Supported
PDU Revision:	2
Operation Status:	Operational
Loopback Status:	--

Remote Client	
Mode:	Passive
MAC Address:	00-0A-EB-13-23-97
Vendor (OUI):	000aeb
Maximum OAMPDU:	1518 Bytes
Remote Loopback:	Supported
Unidirection:	Not Supported
Link Monitoring:	Supported
Variable Request:	Not Supported
PDU Revision:	0
Vendor Information:	00000000

- 5) Click  to save the settings.
- 6) Choose the menu **MAINTENANCE > Ethernet OAM > Statistics > Event Log** to load the following page. Select port 1/0/1 to view the event logs on the port.

Figure 4-6 OAM Event Logs



4.1.3 Using the CLI

- 1) Enable OAM and configure OAM mode as active on port 1/0/1.

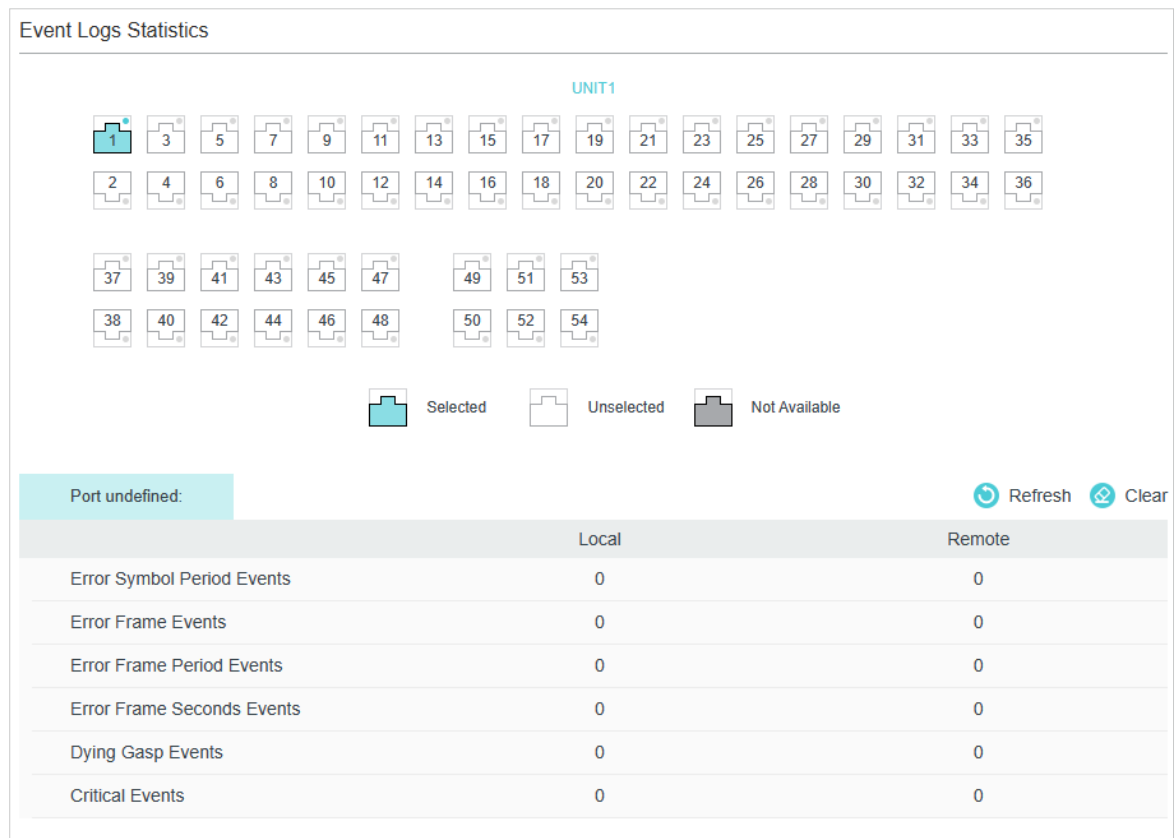
```
Switch_A#configure
```

```
Switch_A(config)# interface gigabitEthernet 1/0/1
```

```
Switch_A(config-if)#ethernet-oam
```

```
Switch_A(config-if)#ethernet-oam mode active
```

- 2) Configure Link Monitoring on the port. Enable Event Notification and keep the threshold and window as the default.

```
Switch_A(config-if)#ethernet-oam link-monitor symbol-period notify enable
```

```
Switch_A(config-if)#ethernet-oam link-monitor frame-period notify enable
```

```
Switch_A(config-if)#ethernet-oam link-monitor frame notify enable
```

```
Switch_A(config-if)#ethernet-oam link-monitor frame-seconds notify enable
```

- 3) Configure Remote Failure Indication on the port. Enable Dying Gasp Notification and Critical Event Notification.

```
Switch_A(config-if)#ethernet-oam remote-failure critical-event notify enable
```

```
Switch_A(config-if)#ethernet-oam remote-failure dying-gasp notify enable
```

```
Switch_A(config-if)#ethernet-oam link-monitor frame-period notify enable
Switch_A(config-if)#ethernet-oam link-monitor frame notify enable
Switch_A(config-if)#end
Switch_A#copy running-config startup-config
```

Verify the Configuration

Verify the configuration of OAM:

```
Switch_A#show ethernet-oam configuration interface gigabitEthernet 1/0/1
```

```
Gi1/0/1
```

```
-----
OAM      : Enabled
```

```
Mode     : Active
```

```
Dying Gasp  : Enabled
```

```
Critical Event  : Enabled
```

```
Remote Loopback OAMPDU : Not Processed
```

```
Symbol Period Error
```

```
Notify State  : Enabled
```

```
Window       : 1000 milliseconds
```

```
Threshold    : 1 Error Symbol
```

```
Frame Error
```

```
Notify State  : Enabled
```

```
Window       : 1000 milliseconds
```

```
Threshold    : 1 Error Frame
```

```
Frame Period Error
```

```
Notify State  : Enabled
```

```
Window       : 148810 Frames
```

```
Threshold    : 1 Error Frame
```

Frame Seconds Error

Notify State : Enabled
Window : 60000 milliseconds
Threshold : 1 Error Seconds

Verify the OAM connection:

```
Switch_A#show ethernet-oam status interface gigabitEthernet 1/0/1
```

```
Gi1/0/1
```

```
Local Client
```

```
-----  
OAM : Enabled  
Mode : Active  
Max OAMPDU : 1518 Bytes  
Remote Loopback : Supported  
Unidirection : Not Supported  
Link Monitoring : Supported  
Variable Request : Not Supported  
PDU Revision : 2  
Operation Status : Operational  
Loopback Status : No Loopback
```

```
Remote Client
```

```
-----  
Mode : Passive  
MAC Address : 18-A6-F7-DB-63-81  
Vendor(OUI) : 000aeb  
Max OAMPDU : 1518 Bytes  
Remote Loopback : Supported  
Unidirection : Not Supported  
Link Monitoring : Supported
```

Variable Request : Not Supported
 PDU Revision : 1
 Loopback Status : No Loopback
 Vendor Information : 00000000

View the OAM event logs:

Switch_A#show ethernet-oam event-log interface gigabitEthernet 1/0/1

Gi1/0/1

Event Listing

```

-----
Type          Location      Time Stamp
-----
Critical Event Remote        2016-01-01 08:08:00
  
```

Local Event Statistics

Error Symbol Event : 0
 Error Frame Event : 0
 Error Frame Period Event : 0
 Error Frame Seconds Event : 0
 Dying Gasp : 0
 Critical Event : 0

Remote Event Statistics

Error Symbol Event : 0
 Error Frame Event : 0
 Error Frame Period Event : 0
 Error Frame Seconds Event : 0
 Dying Gasp : 0
 Critical Event : 1

5 Appendix: Default Parameters

Default settings of Ethernet OAM are listed in the following tables.

Table 5-1 Ethernet OAM

Parameter	Default Setting
Basic Config	
Mode	Active
Status	Disabled
Link Monitoring	
Error Symbol Period	Threshold : 1 error symbol Window: 10*100 ms Event Notification: Enabled
Error Frame	Threshold : 1 error frame Window: 10*100 ms Event Notification: Enabled
Error Frame Period	Threshold : 1 error frame Window: 1488100 frames Event Notification: Enabled
Error Frame Seconds	Threshold : 1 error second Window: 600*100 ms Event Notification: Enabled
Remote Failure Indication	
Dying Gasp Notification	Enabled
Critical Event Notification	Enabled
Remote Loopback	
Received Remote Loopback	Ignore

Part 39

Configuring DLDP

CHAPTERS

1. Overview
2. DLDP Configuration
3. Appendix: Default Parameters

1 Overview

DLDP (Device Link Detection Protocol) is a Layer 2 protocol that enables devices connected through fiber or twisted-pair Ethernet cables to detect whether a unidirectional link exists.

A unidirectional link occurs whenever traffic sent by a local device is received by its peer device but traffic from the peer device is not received by the local device. Once a unidirectional link is detected, DLDP can shut down the related port automatically or inform users.

Unidirectional links can cause a variety of problems, such as spanning-tree topology loops. Once detecting a unidirectional link, DLDP can shut down the related port automatically or inform users.

2 DLDP Configuration

Configuration Guidelines

- A DLDP-capable port cannot detect a unidirectional link if it is connected to a DLDP-incapable port of another switch.
- To detect unidirectional links, make sure DLDP is enabled on both sides of the links.

2.1 Using the GUI

Choose the menu **MAINTENANCE > DLDP** to load the following page.

Figure 2-1 Configure DLDP

Global Config

DLDP: Enable

Advertisement Interval: seconds (1-30)

Shut Mode: Auto Manual

Auto Refresh: Enable

[Apply](#)

Port Config

UNIT1

	Port	DLDP	Protocol State	Link State	Neighbour State
<input type="checkbox"/>	1/0/1	Disabled	Initial	Link-Up	N/A
<input type="checkbox"/>	1/0/2	Disabled	Initial	Link-Down	N/A
<input type="checkbox"/>	1/0/3	Disabled	Initial	Link-Down	N/A
<input type="checkbox"/>	1/0/4	Disabled	Initial	Link-Down	N/A
<input type="checkbox"/>	1/0/5	Disabled	Initial	Link-Down	N/A
<input type="checkbox"/>	1/0/6	Disabled	Initial	Link-Down	N/A
<input type="checkbox"/>	1/0/7	Disabled	Initial	Link-Down	N/A
<input type="checkbox"/>	1/0/8	Disabled	Initial	Link-Down	N/A
<input type="checkbox"/>	1/0/9	Disabled	Initial	Link-Down	N/A
<input type="checkbox"/>	1/0/10	Disabled	Initial	Link-Down	N/A

Total: 54

Follow these steps to configure DLDP:

- 1) In the **Global Config** section, enable DLDP and configure the relevant parameters. Click **Apply**.

DLDP	Enable or disable DLDP globally.
------	----------------------------------

Advertisement Interval	Configure the interval to send advertisement packets. Valid values are from 1 to 30 seconds, and the default value is 5 seconds.
Shut Mode	Choose how to shut down the port when a unidirectional link is detected: Auto: When a unidirectional link is detected on a port, DLDP will generate logs and traps then shut down the port, and the DLDP link state will change to Disable. Manual: When an unidirectional link is detected on a port, DLDP will generate logs and traps, and then the users can manually shut down the unidirectional link ports.
Auto Refresh	With this option enabled, the switch will automatically refresh the DLDP information.
Refresh Interval	After Auto Refresh is enabled, specify the time interval at which the switch will refresh the DLDP information.

- 2) In the **Port Config** section, select one or more ports, enable DLDP and click **Apply**. Then you can view the relevant DLDP information in the table.

DLDP	Enable or disable DLDP on the port.
Protocol State	Displays the DLDP protocol state. Initial: DLDP is disabled. Inactive: DLDP is enabled but the link is down. Active: DLDP is enabled and the link is up, or the neighbor entries in this device are empty. Advertisement: No unidirectional link is detected (the device has established bidirectional links with all its neighbors) or DLDP has remained in an Active status for more than 5 seconds. Probe: In this state, the device will send out Probe packets to detect whether the link is unidirectional. The port enters this state from the Active state if it receives a packet from an unknown neighbor. Disable: A unidirectional link is detected.
Link State	Displays the link state. Link-Down: The link is down. Link-Up: The link is up.
Neighbour State	Displays the neighbour state. Unknown: Link detection is in progress. Unidirectional: The link between the port and the neighbor is unidirectional. Bidirectional: The link between the port and the neighbor is bidirectional.

2.2 Using the CLI

Follow these steps to configure DLDP:

Step 1	configure	Enter global configuration mode.
Step 2	dldp	Globally enable DLDP.
Step 3	dldp interval <i>interval-time</i>	Configure the interval of sending advertisement packets on ports that are in the advertisement state. <i>interval-time</i> : Specify the interval time. The valid values are from 1 to 30 seconds. By default, it is 5 seconds.
Step 3	dldp shut-mode { auto manual }	Configure the DLDP shutdown mode when a unidirectional link is detected. <i>auto</i> : The switch automatically shuts down ports when a unidirectional link is detected. It is the default setting. <i>manual</i> : The switch displays an alert when a unidirectional link is detected. Then the users can manually shut down the unidirectional link ports.
Step 4	interface {fastEthernet <i>port</i> range fastEthernet <i>port-list</i> gigabitEthernet <i>port</i> range gigabitEthernet <i>port-list</i> ten-gigabitEthernet <i>port</i> range ten-gigabitEthernet <i>port-list</i>}	Enter interface configuration mode.
Step 5	dldp	Enable DLDP on the specified port.
Step 6	show dldp	Verify the global DLDP configuration.
Step 7	show dldp interface	Verify the DLDP configuration of the ports.
Step 8	end	Return to privileged EXEC mode.
Step 9	copy running-config startup-config	Save the settings in the configuration file.

The following example shows how to enable DLDP globally, configure the DLDP interval as 10 seconds and specify the shutdown mode as auto.

Switch#configure

```

Switch(config)#dldp
Switch(config)#dldp interval 10
Switch(config)#dldp shut-mode auto
Switch(config)#show dldp
DLDP Global State: Enable
DLDP Message Interval: 10
DLDP Shut Mode: Auto
Switch(config)#end
Switch#copy running-config startup-config

```

The following example shows how to enable DLDP on port 1/0/1.

```

Switch#configure
Switch(config)#interface gigabitEthernet 1/0/1
Switch(config-if)#dldp
Switch(config-if)#show dldp interface

```

Port	DLDP State	Protocol State	Link State	Neighbor State
----	-----	-----	-----	-----
Gi1/0/1	Enable	Inactive	Link-Down	N/A
Gi1/0/2	Disable	Initial	Link-Down	N/A
...				

```

Switch(config-if)#end
Switch#copy running-config startup-config

```

3 Appendix: Default Parameters

Default settings of DLDP are listed in the following table.

Table 3-1 Default Settings of DLDP

Parameter	Default Setting
Global Config	
DLDP State	Disabled
Advertisement Interval	5 seconds
Shut Mode	Auto
Auto Refresh	Disabled
Refresh Interval	3 seconds
Port Config	
DLDP	Disabled

Part 40

Configuring SNMP & RMON

CHAPTERS

1. SNMP
2. SNMP Configurations
3. Notification Configurations
4. RMON
5. RMON Configurations
6. Configuration Example
7. Appendix: Default Parameters

1 SNMP

1.1 Overview

SNMP (Simple Network Management Protocol) is designed for managing and monitoring network devices. With SNMP, network managers can view or modify network device information using an NMS (Network Management System) software, and troubleshoot according to notifications sent by those devices in a timely manner.

As the following figure shows, the SNMP system consists of an SNMP manager, an SNMP agent, and a MIB (Management Information Base).

The SNMP manager is a host that runs NMS applications. The agent and MIB reside on the managed device, such as the switch, router, host or printer. By configuring SNMP on the switch, you define the relationship between the manager and the agent.

Figure 1-1 SNMP System

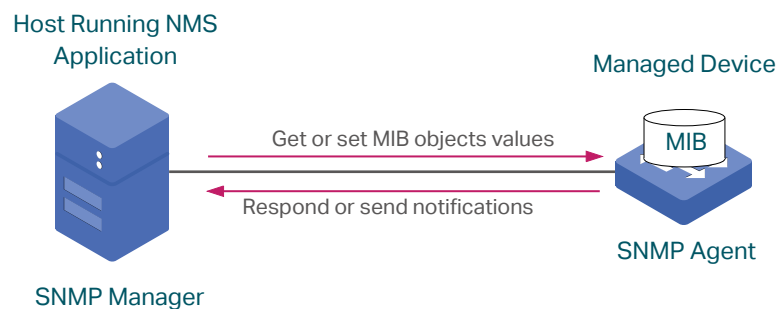

1.2 Basic Concepts

The following basic concepts of SNMP will be introduced: SNMP manager, SNMP agent, MIB (Management Information Base), SNMP entity, SNMP engine, Notification types and SNMP version.

SNMP Manager

The SNMP manager uses SNMP to monitor and control SNMP agents, providing a friendly management interface for the administrator to manage network devices conveniently. It can get values of MIB objects from an agent or set values for them. Also, it receives notifications from the agents so as to learn the condition of the network.

SNMP Agent

An SNMP agent is a process running on the managed device. It contains MIB objects whose values can be requested or set by the SNMP manager. An agent can send unsolicited trap messages to notify the SNMP manager that a significant event has occurred on the agent.

MIB

A MIB is a collection of managed objects that is organized hierarchically. The objects define the attributes of the managed device, including the names, status, access rights, and data types. Each object can be addressed through an object identifier (OID).

As the following figure shows, the MIB hierarchy can be depicted as a tree with a nameless root, the levels of which are assigned by different organizations. The top-level MIB object IDs belong to different standard organizations, while lower-level object IDs are allocated by associated organizations. Vendors can define private branches that include managed objects for their own products.

Figure 1-2 MIB Tree

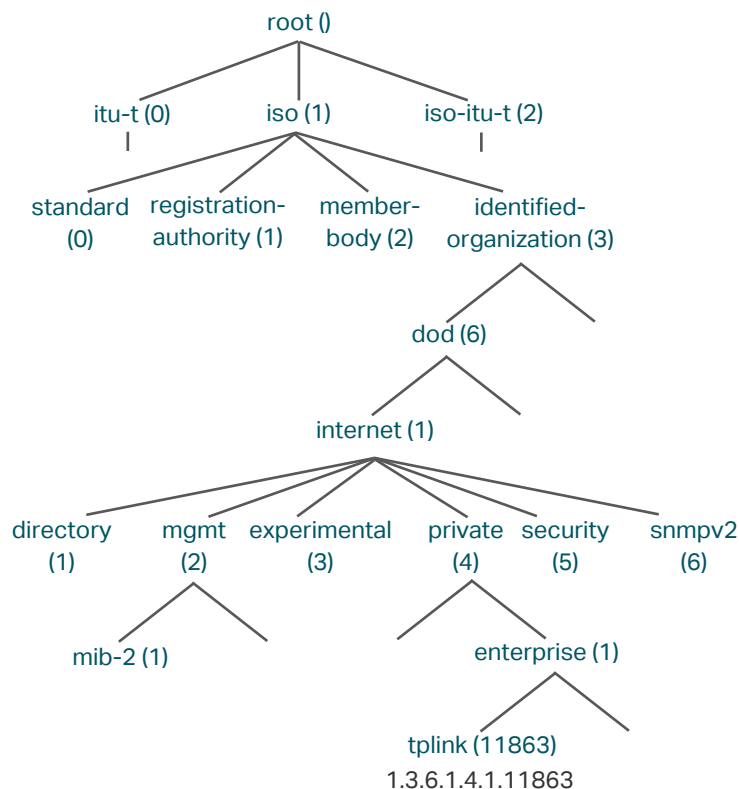

TP-Link switches provide private MIBs that can be identified by the OID 1.3.6.1.4.1.11863. The MIB file can be found on the provided CD or in the download center of our official website: <https://www.tp-link.com/download-center.html>.

Also, TP-Link switches support the following public MIBs:

- LLDP.mib
- LLDP-Ext-Dot1.mib
- LLDP-Ext-MED.mib
- RFC1213.mib
- RFC1493-Bridge.mib
- RFC1757-RMON.mib
- RFC2618-RADIUS-Auth-Client.mib

- RFC2620-RADIUS-Acc-Client.mib
- RFC2674-pBridge.mib
- RFC2674-qBridge.mib
- RFC2863-pBridge.mib
- RFC2925-Disman-Ping.mib
- RFC2925-Disman-Traceroute.mib

For detail information about the supported public MIBs, see [Supported Public MIBs for TP-Link Switches](#).

SNMP Entity

An SNMP entity is a device running the SNMP protocol. Both the SNMP manager and SNMP agent are SNMP entities.

SNMP Engine

An SNMP engine is a part of the SNMP entity. Every SNMP entity has one and only one engine. An SNMP engine provides services for sending and receiving messages, authenticating and encrypting messages, and controlling access to managed objects.

An SNMP engine can be uniquely identified by an engine ID within an administrative domain. Since there is a one-to-one association between SNMP engines and SNMP entities, we can also use the engine ID to uniquely identify the SNMP entity within that administrative domain.

Notification Types

Notifications are messages that the switch sends to the NMS host when important events occur. Notifications facilitate the monitoring and management of the NMS. There are two types of notifications:

- **Trap:** When the NMS host receives a Trap message, it will not send a response to the switch. Thus the switch cannot tell whether a message is received or not, and the messages that are not received will not be resent.
- **Inform:** When the NMS host receives an Inform message, it sends a response to the switch. If the switch does not receive any response within the timeout interval, it will resend the Inform message. Therefore, Inform is more reliable than Trap.

SNMP Version

The device supports three SNMP versions with the security level from low to high: SNMPv1, SNMPv2c and SNMPv3. [Table 1-1](#) lists features supported by different SNMP versions, and [Table 1-2](#) shows corresponding application scenarios.

Table 1-1 Features Supported by Different SNMP Versions

Feature	SNMPv1	SNMPv2c	SNMPv3
Access Control	Based on SNMP Community and MIB View	Based on SNMP Community and MIB View	Based on SNMP User, Group, and MIB View
Authentication and Privacy	Based on Community Name	Based on Community Name	Supported authentication and privacy modes are as follows: Authentication: MD5/SHA Privacy: DES
Trap	Supported	Supported	Supported
Inform	Not supported	Supported	Supported

Table 1-2 Application Scenarios of Different Versions

Version	Application Scenario
SNMPv1	SNMPv1 is applicable to small-scale networks with simple networking, good stability and low security requirements, such as campus networks and small enterprise networks.
SNMPv2c	SNMPv2c is applicable to medium and large-scale networks with low security requirements (or are already secure enough like VPN networks) and heavy traffic. The added feature Inform helps to ensure that the notifications from the switch are received by the NMS host even when network congestion occurs.
SNMPv3	SNMPv3 is applicable to networks of various scales, particularly those that have high security requirements and require devices to be managed by authenticated administrators (such as when data needs to be transferred on public networks).

2 SNMP Configurations

To complete the SNMP configuration, choose an SNMP version according to network requirements and supportability of the NMS application, and then follow these steps:

- Choose SNMPv1 or SNMPv2c

- 1) Enable SNMP.
- 2) Create an SNMP view for managed objects.
- 3) Create a community, specify the accessible view and the corresponding access rights.

- Choose SNMPv3

- 1) Enable SNMP.
- 2) Create an SNMP view for managed objects.
- 3) Create an SNMP group, and specify the security level and accessible view.
- 4) Create SNMP users, and configure the authentication mode, privacy mode and corresponding passwords.

2.1 Using the GUI

2.1.1 Enabling SNMP

Choose the **MAINTENANCE > SNMP > Global Config** to load the following page.

Figure 2-1 Configuring Global Parameters

Global Config

SNMP: Enable

Local Engine ID: Default ID (10-64 Hex)

Remote Engine ID: (Null or 10-64 Hex)

Apply

SNMP View Config

+ Add - Delete

☐	Index	View Name	View Type	MIB Object ID	Operation
☐	1	viewDefault	Include	1	✎ 🗑
☐	2	viewDefault	Exclude	1.3.6.1.6.3.15	✎ 🗑
☐	3	viewDefault	Exclude	1.3.6.1.6.3.16	✎ 🗑
☐	4	viewDefault	Exclude	1.3.6.1.6.3.18	✎ 🗑
Total: 4					

Follow these steps to configure SNMP globally:

- 1) In the **Global Config** section, enable SNMP and configure the local and remote engine ID.

SNMP	Enable or disable SNMP globally.
Local Engine ID	Configure the ID of the local SNMP agent. It is only used in SNMPv3. The local engine ID is a unique alphanumeric string used to identify the SNMP engine on the switch. To restore to the default ID, click Default ID .
Remote Engine ID	Configure the ID of the remote SNMP manager. It is only used in SNMPv3. If no remote SNMP manager is needed, you can leave this field empty. The remote engine ID is a unique alphanumeric string. It is used to identify the SNMP engine on the remote device that receives inform messages from switch.

- 2) Click **Apply**.

 **Note:**









In SNMPv3, changing the value of the SNMP engine ID has important side effects. A user’s password is converted to an MD5 or SHA security digest based on the password itself and the engine ID. If the value of local engine ID changes, the switch will automatically delete all SNMPv3 local users as their security digests become invalid. Similarly, all SNMPv3 remote users will be deleted if the value of remote engine ID changes.

2.1.2 Creating an SNMP View

An SNMP view is a subnet of a MIB. NMS manages MIB objects based on the view. The system has a default view named viewDefault. You can create a new one or edit the default view according to your needs.

Choose the menu **MAINTENANCE > SNMP > Global Config** to load the following page.

Figure 2-2 SNMP View Config

SNMP View Config					
<input type="checkbox"/>	Index	View Name	View Type	MIB Object ID	Operation
<input type="checkbox"/>	1	viewDefault	Include	1	 
<input type="checkbox"/>	2	viewDefault	Exclude	1.3.6.1.6.3.15	 
<input type="checkbox"/>	3	viewDefault	Exclude	1.3.6.1.6.3.16	 
<input type="checkbox"/>	4	viewDefault	Exclude	1.3.6.1.6.3.18	 
Total: 4					

Follow these steps to create an SNMP view:

- 1) Click  **Add** to load the following page. Enter a view name, and specify the view type and a MIB object ID that is related to the view.

Figure 2-3 Creating an SNMP View

The form titled "SNMP View Config" contains the following fields and controls:

- View Name:** A text input field with a maximum length of 16 characters.
- View Type:** Two radio buttons: "Include" (selected) and "Exclude".
- MIB Object ID:** A text input field with a maximum length of 61 characters.
- Buttons:** "Cancel" and "Create" buttons at the bottom right.

View Name	Configure the view name. A complete view consists of all MIB objects that have the same view name.
View Type	Configure the view to include or exclude the related MIB object. Include: The NMS can view or manage the function indicated by the object. Exclude: The NMS cannot view or manage the function indicated by the object.
MIB Object ID	Enter a MIB Object ID to specify a specific function of the device. For specific ID rules, refer to the device related MIBs.

2) Click **Create**.

2.1.3 Creating SNMP Communities (For SNMP v1/v2c)

Choose the menu **MAINTENANCE > SNMP > SNMP v1/v2c** and click **Add** to load the following page.

Figure 2-4 Creating an SNMP Community

The form titled "SNMP Community Config" contains the following fields and controls:

- Community Name:** A text input field with a maximum length of 255 characters.
- Access Mode:** Two radio buttons: "Read Only" (selected) and "Read & Write".
- MIB View:** A dropdown menu currently showing "viewDefault".
- Buttons:** "Cancel" and "Create" buttons at the bottom right.

Follow these steps to create an SNMP community:

1) Set the community name, access rights and the related view.

Community Name	Configure the community name. This community name is used like a password to give the NMS access to MIB objects in the switch's SNMP agent.
-----------------------	---

Access Mode	Specify the access right to the related view. Read Only: The NMS can view but not modify parameters of the specified view. Read & Write: The NMS can view and modify parameters of the specified view.
MIB View	Choose an SNMP view that allows the community to access.

2) Click **Create**.

2.1.4 Creating an SNMP Group (For SNMP v3)

Choose the menu **MAINTENANCE > SNMP > SNMP v3 > SNMP Group** and click  Add to load the following page.

Figure 2-5 Creating an SNMP Group

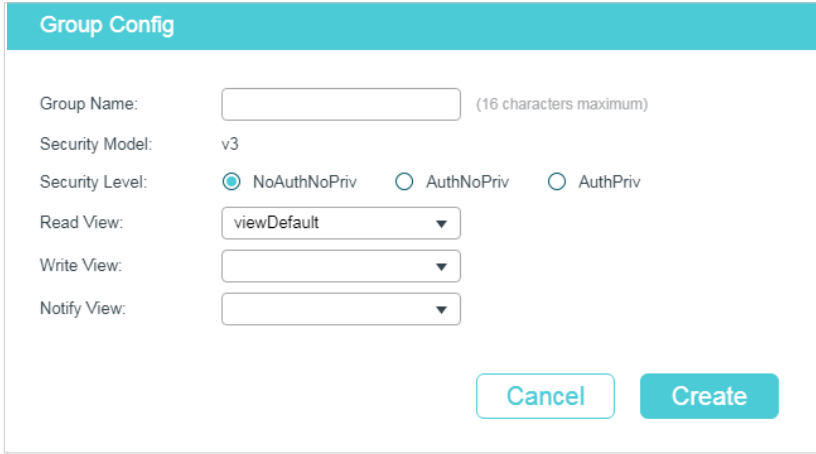

Group Config

Group Name: (16 characters maximum)

Security Model: v3

Security Level: NoAuthNoPriv AuthNoPriv AuthPriv

Read View:

Write View:

Notify View:

Follow these steps to create an SNMP Group and configure related parameters.

1) Assign a name to the group, then set the security level and the read view, write view and notify view.

Group Name	Set the SNMP group name using 1 to 16 characters. The identifier of a group consists of a group name, security model and security level. Groups of the same identifier are recognized as being in the same group.
Security Model	Displays the security model. SNMPv3 uses v3, the most secure level.
Security Level	Set the security level for the SNMPv3 group. NoAuthNoPriv: No authentication algorithm but a user name match is applied to check packets, and no privacy algorithm is applied to encrypt them. AuthNoPriv: An authentication algorithm is applied to check packets, but no privacy algorithm is applied to encrypt them. AuthPriv: An authentication algorithm and a privacy algorithm are applied to check and encrypt packets.

Read View	Choose a view to allow parameters to be viewed but not modified by the NMS. The view is necessary for any group.
Write View	Choose a view to allow parameters to be modified by the NMS. The view in Write View should also be added to Read View.
Notify View	Choose a view to allow it to send notifications to the NMS.

2) Click **Create**.

2.1.5 Creating SNMP Users (For SNMP v3)

Choose the menu **MAINTENANCE > SNMP > SNMP v3 > SNMP User** and click  Add to load the following page.

Figure 2-6 Creating an SNMP User

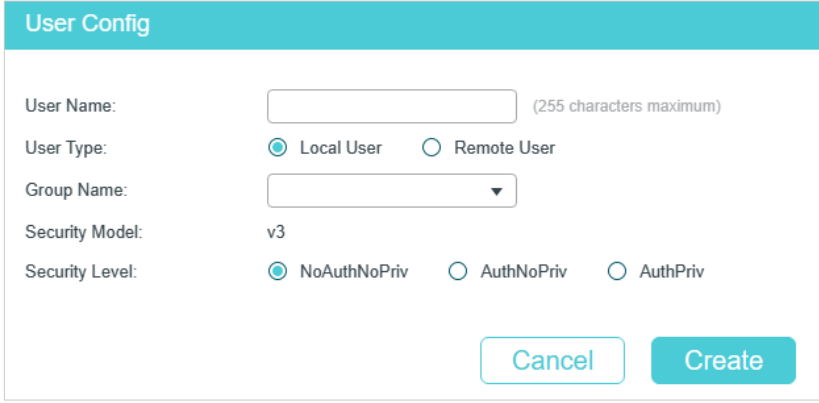

Follow these steps to create an SNMP user:

1) Specify the user name and user type as well as the group which the user belongs to. Then configure the security level.

User Name	Set the SNMP user name using 1 to 16 characters. For different entries, user names cannot be the same.
User Type	Choose a user type based on the location of the user. Local User: The user resides on the local engine, which is the SNMP agent of the switch. Remote User: The user resides on the NMS. Before configuring a remote user, you need to set the remote engine ID first. The remote engine ID and user password are used when computing the authentication and privacy digests.
Group Name	Choose the name of the group that the user belongs to. Users with the same Group Name, Security Model and Security Level will be in the same group.
Security Model	Displays the security model. SNMPv3 uses v3, the most secure model.

Security Level	<p>Set the security level. The security level from lowest to highest is: NoAuthNoPriv, AuthNoPriv, AuthPriv. The security level of the user should not be lower than the group it belongs to.</p> <p>NoAuthNoPriv: No authentication algorithm but a user name match is applied to check packets, and no privacy algorithm is applied to encrypt them.</p> <p>AuthNoPriv: An authentication algorithm is applied to check packets, but no privacy algorithm is applied to encrypt them.</p> <p>AuthPriv: An authentication algorithm and a privacy algorithm are applied to check and encrypt packets.</p>
-----------------------	---

- 2) If you have chosen **AuthNoPriv** or **AuthPriv** as the security level, you need to set corresponding Authentication Mode or Privacy Mode. If not, skip this step.

Authentication Mode	<p>With AuthNoPriv or AuthPriv selected, configure the authentication mode and password for authentication. Two authentication modes are provided:</p> <p>MD5: Enable the HMAC-MD5 algorithm for authentication.</p> <p>SHA: Enable the SHA (Secure Hash Algorithm) algorithm for authentication. SHA algorithm is securer than MD5 algorithm.</p>
----------------------------	--

Authentication Password	Set the password for authentication.
--------------------------------	--------------------------------------

Privacy Mode	With AuthPriv selected, configure the privacy mode and password for encryption. The switch uses the DES (Data Encryption Standard) algorithm for encryption.
---------------------	--

Privacy Password	Set the password for encryption.
-------------------------	----------------------------------

- 3) Click **Create**.

2.2 Using the CLI

2.2.1 Enabling SNMP

Step 1	<p>configure</p> <p>Enter Global Configuration Mode.</p>
--------	---

Step 2	<p>snmp-server</p> <p>Enabling SNMP.</p>
--------	---

Step 3 **snmp-server engineID** {[**local** *local-engineID*] [**remote** *remote-engineID*]}

Configure the local engine ID and the remote engine ID.

local-engineID: Enter the engine ID of the local SNMP agent (the switch) with 10 to 64 hexadecimal digits. A valid engine ID must contain an even number of characters. By default, the switch generates the engine ID using TP-Link's enterprise number (80002e5703) and its own MAC address.

The local engine ID is a unique alphanumeric string used to identify the SNMP engine. As an SNMP agent contains only one SNMP engine, the local engine ID can uniquely identify the SNMP agent.

remote-engineID: Enter the remote engine ID with 10 to 64 hexadecimal digits. A valid engine ID must contain an even number of characters. The remote engine ID is a unique alphanumeric string. It is used to identify the SNMP engine on the remote device that receives inform messages from switch.

Note:

In SNMPv3, changing the value of the SNMP engine ID has important side effects. A user's password is converted to an MD5 or SHA security digest based on the password itself and the engine ID. If the value of local engine ID changes, the switch will automatically delete all SNMPv3 local users as their security digests become invalid. Similarly, all SNMPv3 remote users will be deleted if the value of remote engine ID changes.

Step 4 **show snmp-server**

Displays the global settings of SNMP.

Step 5 **show snmp-server engineID**

Displays the engine ID of SNMP.

Step 6 **end**

Return to Privileged EXEC Mode.

Step 7 **copy running-config startup-config**

Save the settings in the configuration file.

The following example shows how to enable SNMP and set 123456789a as the remote engine ID:

```
Switch#configure
```

```
Switch(config)#snmp-server
```

```
Switch(config)#snmp-server engineID remote 123456789a
```

```
Switch(config)#show snmp-server
```

```
SNMP agent is enabled.
```

```
0 SNMP packets input
```

```
0 Bad SNMP version errors
```

- 0 Unknown community name
- 0 Illegal operation for community name supplied
- 0 Encoding errors
- 0 Number of requested variables
- 0 Number of altered variables
- 0 Get-request PDUs
- 0 Get-next PDUs
- 0 Set-request PDUs
- 0 SNMP packets output
 - 0 Too big errors (Maximum packet size 1500)
 - 0 No such name errors
 - 0 Bad value errors
 - 0 General errors
 - 0 Response PDUs
 - 0 Trap PDUs

Switch(config)#show snmp-server engineID

Local engine ID: 80002e5703000aeb13a23d

Remote engine ID: 123456789a

Switch(config)#end**Switch#copy running-config startup-config**

2.2.2 Creating an SNMP View

Specify the OID (Object Identifier) of the view to determine objects to be managed.

-
- | | |
|--------|----------------------------------|
| Step 1 | configure |
| | Enter Global Configuration Mode. |
-

Step 2 **snmp-server view** *name mib-oid* {include | exclude}

Configure the view.

name: Enter a view name with 1 to 16 characters. You can create multiple entries with each associated to a MIB object. A complete view consists of all MIB objects that have the same view name.

mib-oid: Enter the MIB object ID with 1 to 61 characters. When a MIB Object ID is specified, all its child Object IDs are specified. For specific ID rules, refer to the device related MIBs.

include | exclude: Specify a view type. Include indicates that objects of the view can be managed by the NMS, while exclude indicates that objects of the view cannot be managed by the NMS.

Step 3 **show snmp-server view**

Displays the view table.

Step 4 **end**

Return to Privileged EXEC Mode.

Step 5 **copy running-config startup-config**

Save the settings in the configuration file.

The following example shows how to set a view to allow the NMS to manage all function. Name the view as View:

Switch#configure

Switch(config)#snmp-server view View 1 include

Switch(config)#show snmp-server view

No.	View Name	Type	MOID
---	-----	-----	----
1	viewDefault	include	1
2	viewDefault	exclude	1.3.6.1.6.3.15
3	viewDefault	exclude	1.3.6.1.6.3.16
4	viewDefault	exclude	1.3.6.1.6.3.18
5	View	include	1

Switch(config)#end

Switch#copy running-config startup-config

2.2.3 Creating SNMP Communities (For SNMP v1/v2c)

For SNMPv1 and SNMPv2c the Community Name is used for authentication, functioning as the password.

Step 1	configure Enter Global Configuration Mode.
Step 2	snmp-server community <i>name</i> { read-only read-write } [<i>mib-view</i>] Configure the community. <i>name</i> : Enter a group name with 1 to 16 characters. <i>read-only</i> <i>read-write</i> : Choose an access permissions for the community. Read-only indicates that the NMS can view but cannot modify parameters of the view, while read-write indicates that the NMS can both view and modify. <i>mib-view</i> : Enter a view to allow it to be accessed by the community. The name contains 1 to 61 characters. The default view is viewDefault.
Step 3	show snmp-server community Displays community entries.
Step 4	end Return to Privileged EXEC Mode.
Step 5	copy running-config startup-config Save the settings in the configuration file.

The following example shows how to set an SNMP community. Name the community as the nms-monitor, and allow the NMS to view and modify parameters of View:

Switch#configure

Switch(config)#snmp-server community nms-monitor read-write View

Switch(config)#show snmp-server community

Index	Name	Type	MIB-View
-----	-----	-----	-----
1	nms-monitor	read-write	View

Switch(config)#end

Switch#copy running-config startup-config

2.2.4 Creating an SNMP Group (For SNMPv3)

Create an SNMP group and set user access control with read, write and notify views. Meanwhile, set the authentication and privacy modes to secure the communication between the NMS and managed devices.

Step 1	configure Enter Global Configuration Mode.
--------	--

-
- Step 2 **snmp-server group** *name* [**smode** v3] [**slev** {noAuthNoPriv | authNoPriv | authPriv}] [**read** *read-view*] [**write** *write-view*] [**notify** *notify-view*]
- Create an SNMP group.
- name*: Enter the group name with 1 to 16 characters. The identifier of a group consists of a group name, security model and security level. Groups of the same identifier are recognized as being in the same group.
- v3**: Configure the security model for the group. v3 indicates SNMPv3, the most secure model.
- noAuthNoPriv | authNoPriv | authPriv**: Choose a security level. The security levels are sorted from low to high, and the default is noAuthNoPriv.
- noAuthNoPriv** indicates no authentication algorithm but a user name match is applied to check packets, and no privacy algorithm is applied to encrypt them. **authNoPriv** indicates an authentication algorithm is applied to check packets, but no privacy algorithm is applied to encrypt them. **authPriv** indicates an authentication algorithm and a privacy algorithm are applied to check and encrypt packets.
- read-view*: Set the view to be the Read view. Then the NMS can view parameters of the specified view.
- write-view*: Set the view to be the Write view. Then the NMS can modify parameters of the specified view. Note that the view in the Write view should also be in the Read view.
- notify-view*: Set the view to be the Notify view. Then the NMS can get notifications of the specified view from the agent.
-
- Step 3 **show snmp-server group**
- Displays SNMP group entries.
-
- Step 4 **end**
- Return to Privileged EXEC Mode.
-
- Step 5 **copy running-config startup-config**
- Save the settings in the configuration file.
-

The following example shows how to create an SNMPv3 group with the group name as nms1, the security level as authPriv, and the Read and Notify view are both View:

Switch#configure

Switch(config)#snmp-server group nms1 **smode** v3 **slev** authPriv **read** View **notify** View

Switch(config)#show snmp-server group

No.	Name	Sec-Mode	Sec-Lev	Read-View	Write-View	Notify-View
---	-----	-----	-----	-----	-----	-----
1	nms1	v3	authPriv	View		View

Switch(config)#end

Switch#copy running-config startup-config

2.2.5 Creating SNMP Users (For SNMPv3)

Create SNMP users and add them to the SNMP group. Users in the same group have the same access rights which are controlled by the read, write and notify views of the group.

Step 1	<p>configure</p> <p>Enter Global Configuration Mode.</p>
Step 2	<p>Choose a security level for the user and run the corresponding command to create the user. The security levels from low to high are NoAuthNoPriv, AuthNoPriv, and AuthPriv. The security level of a user should not be lower than that of the group it belongs to.</p> <p>To create a user with the security level as NoAuthNoPriv:</p> <pre>snmp-server user <i>name</i> { <i>local</i> <i>remote</i> } <i>group-name</i> [smode <i>v3</i>] slev noAuthNoPriv</pre> <p><i>name</i>: Enter the user name with 1 to 16 characters.</p> <p><i>local</i> <i>remote</i>: Choose a user type based on the location of the user. Local indicates that the user resides on the local SNMP engine (the switch), while remote indicates that the user resides on the NMS. Before configuring a remote user, you need to set the remote engine ID first. The remote engine ID and user password are used when computing the authentication and privacy digests.</p> <p><i>group-name</i>: Enter the name of the group which the user belongs to. Users with the same Group Name, Security Model and Security Level will be in the same group.</p> <p><i>v3</i>: Configure the security model for the user. <i>v3</i> indicates SNMPv3, the most secure model.</p> <p><i>noAuthNoPriv</i>: Configure the security level as noAuthNoPriv. For this level, no authentication algorithm but a user name match is applied to check packets, and no privacy algorithm is applied to encrypt them.</p> <p>To create a user with the security level as AuthNoPriv:</p> <pre>snmp-server user <i>name</i> { <i>local</i> <i>remote</i> } <i>group-name</i> [smode <i>v3</i>] slev authNoPriv cmode {MD5 SHA} cpwd <i>confirm-pwd</i></pre> <p><i>authNoPriv</i>: Configure the security level as authNoPriv. For this level, an authentication algorithm is applied to check packets, but no privacy algorithm is applied to encrypt them.</p> <p><i>MD5</i> <i>SHA</i>: Choose an authentication algorithm when the security level is set as authNoPriv or authPriv. SHA authentication mode has a higher security than MD5 mode. By default, the Authentication Mode is none.</p> <p><i>confirm-pwd</i>: Enter an authentication password with 1 to 16 characters excluding question mark and space. This password in the configuration file will be displayed in the symmetric encrypted form.</p> <p>To create a user with the security as AuthPriv:</p> <pre>snmp-server user <i>name</i> { <i>local</i> <i>remote</i> } <i>group-name</i> [smode <i>v3</i>] slev authPriv cmode {MD5 SHA} cpwd <i>confirm-pwd</i> emode DES epwd <i>encrypt-pwd</i></pre> <p><i>authPriv</i>: Configure the security level as authPriv. For this level, an authentication algorithm and a privacy algorithm are applied to check and encrypt packets.</p> <p><i>DES</i>: Configure the privacy mode as DES. The switch will use the DES algorithm to encrypt the packets. By default, the Privacy Mode is none.</p> <p><i>encrypt-pwd</i>: Enter a privacy password with 1 to 16 characters excluding question mark and space. This password in the configuration file will be displayed in the symmetric encrypted form.</p>

Step 3	show snmp-server user Displays the information of SNMP users.
Step 4	end Return to Privileged EXEC Mode.
Step 5	copy running-config startup-config Save the settings in the configuration file.

The following example shows how to create a remote SNMP user named admin and add it to group nms1. The security settings are as [Table 2-1](#):

Table 2-1 Security Settings for the User

Parameter	Value
Security Level	v3
Authentication Mode	SHA
Authentication Password	1234
Privacy Mode	DES
Privacy Password	5678

Switch#configure

```
Switch(config)#snmp-server user admin remote nms1 smode v3 slev authPriv cmode
SHA cpwd 1234 emode DES epwd 5678
```

Switch(config)#show snmp-server user

```
No. U-Name  U-Type  G-Name  S-Mode  S-Lev  A-Mode  P-Mode
--- -----  -----  -----  -----  -----  -----
1  admin    remote  nms1    v3      authPriv  SHA    DES
```

Switch(config)#end

Switch#copy running-config startup-config

3 Notification Configurations

With Notification enabled, the switch can send notifications to the NMS about important events relating to the device's operation. This facilitates the monitoring and management of the NMS.

To configure SNMP notification, follow these steps:

- 1) Configure the information of NMS hosts.
- 2) Enable SNMP traps.

Configuration Guidelines

To guarantee the communication between the switch and the NMS, ensure the switch and the NMS can reach one another.

3.1 Using the GUI

3.1.1 Configuring the Information of NMS Hosts

Choose the menu **MAINTENANCE > SNMP > Notification > Notification Config** and click  **Add** to load the following page.

Figure 3-1 Adding an NMS Host

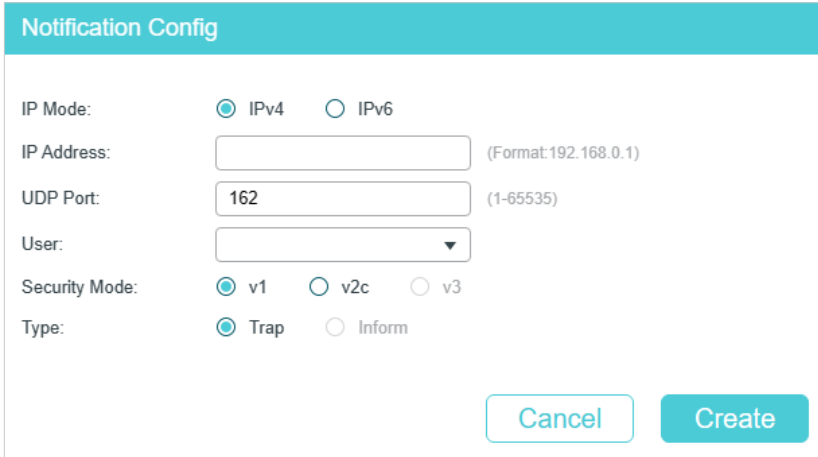

Follow these steps to add an NMS host:

- 1) Choose the IP mode according to the network environment, and specify the IP address of the NMS host and the UDP port that receives notifications.

IP Mode	Choose the IP mode of the NMS.
----------------	--------------------------------

IP Address	<p>If you set IP Mode as IPv4, specify an IPv4 address for the NMS host.</p> <p>If you set IP Mode as IPv6, specify an IPv6 address for the NMS host.</p>
UDP Port	<p>Specify a UDP port on the NMS to receive notifications. For communication security, we recommend that you change the port number under the condition that communications on other UDP ports are not affected.</p>

- 2) Specify the user name or community name used by the NMS host, and configure the security model and security level based on the user or community.

User	<p>Choose the user name or community name used by the NMS.</p>
Security Model	<p>If a community name (created for SNMPv1/v2c) is entered in User Name, specify the security mode as v1 or v2c. If a user name (created for SNMPv3) is entered in User Name, here displays the security mode as v3. The NMS host should use the corresponding SNMP version.</p> <p><i>Note:</i> The NMS host should use the corresponding SNMP version.</p>
Security Level	<p>If Security Level is v3, here displays the security level of the user.</p>

- 3) Choose a notification type based on the SNMP version. If you choose the Inform type, you need to set retry times and timeout interval.

Type	<p>Specify the notification type. For SNMPv1, the supported type is trap. For SNMPv2c and SNMPv3, you can configure the type as trap or inform.</p> <p>Trap: The switch will send Trap messages to the NMS when certain events occur. When the NMS receives a Trap message, it will not send a response to the switch. Thus the switch cannot tell whether a message is received or not, and the messages that are not received will not be resent.</p> <p>Inform: The switch will send Inform messages to the NMS when certain events occur. When the NMS receives an Inform message, it sends a response to the switch. If the switch does not receive a response within the timeout interval, it will resend the Inform message. Therefore, Informs are more reliable than Traps.</p>
Retry Times	<p>Configure the retry time for Inform messages. The switch will resend the Inform message if it does not receive response from the NMS within the timeout interval. It will stop sending Inform messages when the retry time reaches the limit.</p>
Timeout	<p>Configure the length of time that the switch waits for a response from the NMS after sending an inform message.</p>

- 4) Click **Create**.

3.1.2 Enabling SNMP Traps

Choose the menu **MAINTENANCE > SNMP > Notification > Trap Config** to load the following page.

Figure 3-2 Enabling SNMP Traps

SNMP Traps

<input checked="" type="checkbox"/> SNMP Authentication	<input checked="" type="checkbox"/> Coldstart	<input checked="" type="checkbox"/> Warmstart
<input checked="" type="checkbox"/> Link Status	<input type="checkbox"/> CPU Utilization	<input type="checkbox"/> Memory Utilization
<input type="checkbox"/> Flash Operation	<input type="checkbox"/> VLAN Create/Delete	<input type="checkbox"/> IP Change
<input type="checkbox"/> Storm Control	<input type="checkbox"/> Rate Limit	<input type="checkbox"/> LLDP
<input type="checkbox"/> Loopback Detection	<input type="checkbox"/> Spanning Tree	<input type="checkbox"/> PoE
<input type="checkbox"/> IP-MAC Binding	<input type="checkbox"/> IP Duplicate	<input type="checkbox"/> DHCP Filter
<input type="checkbox"/> DDM Temperature	<input type="checkbox"/> DDM Voltage	<input type="checkbox"/> DDM Bias Current
<input type="checkbox"/> DDM TX Power	<input type="checkbox"/> DDM RX Power	<input type="checkbox"/> ACL Counter

Apply

Follow these steps to enable some or all of the supported traps:

- 1) Select the traps to be enabled according to your needs. With a trap enabled, the switch will send the corresponding trap message to the NMS when the trap is triggered.

SNMP Authentication	Triggered when a received SNMP request fails the authentication.
Coldstart	Indicates an SNMP initialization caused by the reinitialization of the switch system. The trap can be triggered when you reboot the switch.
Warmstart	Indicates the SNMP feature on the switch is reinitialized with the physical configuration unchanged. The trap can be triggered if you disable and then enable SNMP after the SNMP is completely configured and enabled.
Link Status	<p>Triggered when the switch detects a link status change:</p> <p>Linkup Trap: Indicates that a port status changes from linkdown to linkup.</p> <p>Linkdown Trap: Indicates that a port status changes from linkup to linkdown.</p> <p>Link Status Trap can be triggered when it is enabled both globally and on the port, and you connect a new device to the port or disconnect a device from the port.</p> <p>To enable the trap on a port, run the command snmp-server traps link-status in Interface Configuration Mode of the port. To disable it, run the corresponding no command.</p> <p>By default, the trap is enabled both globally and on all ports, which means that link status changes on any ports will trigger the trap. If you do not want to receive notification messages about some specific ports, disable the trap on those ports.</p>

CPU Utilization	Triggered when the utilization rate of the CPU has exceeded the limit that you have set. The limit of CPU utilization rate for the switch is 80% by default.
Memory Utilization	Triggered when the memory utilization exceeds 80%.
Flash Operation	Triggered when flash is modified during operations such as backup, reset, firmware upgrade, configuration import, and so on.
VLAN Create/Delete	Triggered when certain VLANs are created or deleted successfully.
IP Change	Monitors the IP address changes of each port. The trap can be triggered when the IP address of any port is changed.
Storm Control	Monitors whether the storm rate has reached the limit that you have set. The trap can be triggered when the feature is enabled and broadcast/multicast/unknown-unicast frames are sent to the port with a rate higher than what you have set.
Rate Limit	Monitors whether the bandwidth has reached the limit you have set. The trap can be triggered when the Rate Limit feature is enabled and packets are sent to the port with a rate higher than what you have set.
LLDP	Indicates LLDP topology changes. The trap can be triggered when a new remote device attached to a local port, or a remote device disconnected or moved from one port to another.
Loopback Detection	Triggered when the switch detects a loopback with loopback detection feature, or when a loopback is cleared.
Spanning Tree	Indicates spanning tree changes. The trap can be triggered in the following situations: a port changes from non-forwarding state to forwarding state or the other way round; a port receives a packet with TC flag or a TCN packet.

PoE	<p>Allow all PoE-related traps, including:</p> <p>Over-max-pwr-budget: Triggered when the total power required by the connected PDs exceeds the maximum power the PoE switch can supply.</p> <p>Port-pwr-change: Triggered when a port starts to supply power or stops supplying power.</p> <p>Port-pwr-deny: Triggered when the switch powers off PDs on low-priority PoE ports. When the total power required by the connected PDs exceeds the system power limit, the switch will power off PDs on low-priority PoE ports to ensure stable running of the other PDs.</p> <p>Port-pwr-over-30w: Triggered when the power required by the connected PD exceeds 30 watts.</p> <p>Port-pwr-overload: Triggered when the power required by the connected PD exceeds the maximum power the port can supply.</p> <p>Port-short-circuit: Triggered when a short circuit is detected on a port.</p> <p>Thermal-shutdown: Triggered when the PSE chip overheats. The switch will stop supplying power in this case.</p> <p><i>Note:</i> PoE trap is only available on certain devices.</p>
IP-MAC Binding	<p>Triggered in the following two situations: the ARP Inspection feature is enabled and the switch receives an illegal ARP packet; or the IPv4 Source Guard feature is enabled and the switch receives an illegal IP packet.</p>
IP Duplicate	<p>Triggered when the switch detects an IP conflict event.</p>
DHCP Filter	<p>Triggered when the DHCPv4 Filter feature is enabled and the switch receives DHCP packets from an illegal DHCP server.</p>
DDM Temperature	<p>Monitors the temperature of SFP modules inserted into the SFP ports on the switch. The trap can be triggered when the temperature of any SFP module has reached the warning or alarm threshold.</p> <p><i>Note:</i> DDM Temperature is only available on certain devices.</p>
DDM Voltage	<p>Monitors the voltage of SFP modules inserted into the SFP ports on the switch. The trap can be triggered when the voltage of any SFP module has reached the warning or alarm threshold.</p> <p><i>Note:</i> DDM Voltage is only available on certain devices.</p>
DDM Bias Current	<p>Monitors the bias current of SFP modules inserted into the SFP ports on the switch. The trap can be triggered when the bias current of any SFP module has reached the warning or alarm threshold.</p> <p><i>Note:</i> DDM Bias Current is only available on certain devices.</p>

DDM TX Power	Monitors the TX Power of SFP modules inserted into the SFP ports on the switch. The trap can be triggered when the TX Power of any SFP module has reached the warning or alarm threshold. <i>Note:</i> DDM TX Power is only available on certain devices.
DDM RX Power	Monitors the RX Power of SFP modules inserted into the SFP ports on the switch. The trap can be triggered when the RX Power of any SFP module has reached the warning or alarm threshold. <i>Note:</i> DDM RX Power is only available on certain devices.
ACL Counter	Monitors matched ACL information, including the matched ACL ID, rule ID and the number of the matched packets. With both this trap and the Logging feature in ACL rule settings enabled, the switch will check the matched ACL information every five minutes and send SNMP traps if there is any updated information.

2) Click **Apply**.

3.2 Using the CLI

3.2.1 Configuring the NMS Host

Configure parameters of the NMS host and packet handling mechanism.

Step 1	configure Enter Global Configuration Mode.
--------	--

Step 2

snmp-server host *ip udp-port user-name* [**smode** { v1 | v2c | v3 }] [**slev** {noAuthNoPriv | authNoPriv | authPriv }] [**type** { trap | inform}] [**retries** *retries*] [**timeout** *timeout*]

Configure parameters of the NMS host and packet handling mechanism.

ip: Specify the IP address of the NMS host in IPv4 or IPv6. Make sure the NMS host and the switch can reach each other.

udp-port: Specify a UDP port on the NMS host to receive notifications. The default is port 162. For communication security, we recommend that you change the port number under the condition that communications on other UDP ports are not affected.

user-name: Enter the name used by the NMS host. When the NMS host uses SNMPv1 or SNMPv2c, enter the Community Name; when the NMS host uses SNMPv3, enter the User Name of the SNMP Group.

v1 | v2c | v3: Choose the security model used by the user from the following: SNMPv1, SNMPv2c, SNMPv3. The NMS host should use the corresponding SNMP version.

noAuthNoPriv | authNoPriv | authPriv: For SNMPv3 groups, choose a security level from noAuthNoPriv (no authorization and no encryption), authNoPriv (authorization and no encryption), authPriv (authorization and encryption). The default is noAuthNoPriv. Note that if you have chosen v1 or v2c as the security model, the security level cannot be configured.

trap | inform: Choose a notification type for the NMS host. For SNMPv1, the supported type is Trap. For SNMPv2c and SNMPv3, you can configure the type as Trap or Inform.

Trap: The switch will send Trap messages to the NMS host when certain events occur. When the NMS host receives a Trap message, it will not send a response to the switch. Thus the switch cannot tell whether a message is received or not, and the messages that are not received will not be resent.

Inform: The switch will send Inform messages to the NMS host when certain events occur. When the NMS host receives an Inform message, it sends a response to the switch. If the switch does not receive any response within the timeout interval, it will resend the Inform message. Therefore, Inform is more reliable than Trap.

retries: Set the retry times for Inform messages. The range is between 1 to 255 and the default is 3. The switch will resend the Inform message if it does not receive any response from the NMS host within the timeout interval. And it will stop sending Inform message when the retry times reaches the limit.

timeout: Set the time that the switch waits for a response. Valid values are from 1 to 3600 seconds; the default is 100 seconds. The switch will resend the Inform message if it does not receive a response from the NMS host within the timeout interval.

Step 3

show snmp-server host

Verify the information of the host.

Step 4

end

Return to Privileged EXEC Mode.

Step 5

copy running-config startup-config

Save the settings in the configuration file.

The following example shows how to configure an NMS host with the parameters shown in [Table 3-1](#).

Table 3-1 Parameters for the NMS Hosts

Parameter	Value
IP Address	172.16.1.222
UDP Port	162
User Name	admin
Security Model	v3
Security Level	authPriv
Notification Type	Inform
Retry Times	3
Timeout Interval	100 seconds

Switch#configure

```
Switch(config)#snmp-server host 172.16.1.222 162 admin smode v3 slev authPriv type
inform retries 3 timeout 100
```

Switch(config)#show snmp-server host

No.	Des-IP	UDP	Name	SecMode	SecLev	Type	Retry	Timeout
---	-----	-----	----	-----	-----	----	-----	-----
1	172.16.1.222	162	admin	v3	authPriv	inform	3	100

Switch(config)#end

Switch#copy running-config startup-config

3.2.2 Enabling SNMP Traps

The switch supports many types of SNMP traps, like SNMP standard traps, ACL traps, and VLAN traps, and the corresponding commands are different. With a trap enabled, the switch will send the corresponding trap message to the NMS when the trap is triggered. Follow these steps to enable the traps according to your needs.

■ Enabling the SNMP Standard Traps Globally

-
- Step 1 **configure**
Enter Global Configuration Mode.
-

Step 2	<p>snmp-server traps snmp [linkup linkdown warmstart coldstart auth-failure]</p> <p>Enable the corresponding SNMP standard traps. The command without any parameter enables all SNMP standard traps. By default, all SNMP standard traps are enabled.</p> <p>linkup linkdown: Enable Linkup Trap and Linkdown Trap globally.</p> <p>Linkup Trap indicates that a port status changes from linkdown to linkup. The trap can be triggered when you connect a new device to the port, and the trap is enabled both globally and on the port.</p> <p>Linkdown Trap indicates that a port status changes from linkup to linkdown. The trap can be triggered when you disconnect a device from the port, and the trap is enabled both globally and on the port.</p> <p>To enable Linkup Trap and Linkdown Trap on a port, run the command snmp-server traps link-status in Interface Configuration Mode of the port. To disable them, run the corresponding no command.</p> <p>By default, the traps are enabled both globally and on all ports, which means that the traps will be triggered when a device is connected to or disconnected from any port of the switch. If you do not want to receive notification messages about some specific ports, disable the traps on those ports.</p> <p>warmstart: Indicates that the SNMP entity is reinitializing itself with its configurations unchanged. For a switch running SNMP, the trap can be triggered if you disable and then enable SNMP without changing any parameters.</p> <p>coldstart: Indicates that the SNMP entity is reinitializing itself such that its configurations may be changed. The trap can be triggered when you reboot the switch.</p> <p>auth-failure: Triggered when a received SNMP request fails the authentication.</p>
--------	---

Step 3	<p>end</p> <p>Return to Privileged EXEC Mode.</p>
--------	--

Step 4	<p>copy running-config startup-config</p> <p>Save the settings in the configuration file.</p>
--------	--

The following example shows how to configure the switch to send linkup traps:

```
Switch#configure
Switch(config)#snmp-server traps snmp linkup
Switch(config)#end
Switch#copy running-config startup-config
```

■ Enabling the SNMP Extended Traps Globally

Step 1	<p>configure</p> <p>Enter Global Configuration Mode.</p>
--------	---

Step 2	snmp-server traps { rate-limit cpu flash lldp remtableschange lldp topologychange loopback-detection storm-control spanning-tree memory }
	<p>Enable the corresponding SNMP extended traps. By default, all SNMP extended traps are disabled.</p> <p>rate-limit: Monitors whether the bandwidth has reached the limit you have set. The trap can be triggered when the Rate Limit feature is enabled and packets are sent to the port with a rate higher than what you have set.</p> <p>cpu: Monitors the load status of the switch CPU. The trap can be triggered when the utilization rate of the CPU exceeds 80%.</p> <p>flash: Triggered when flash is modified during operations such as backup, reset, firmware upgrade, and configuration import.</p> <p>lldp remtableschange: Indicates that the switch senses an LLDP topology change. The trap can be triggered when adding or removing a remote device, and when the information of some remote devices is aged out or cannot be stored into the switch because of insufficient resources. This trap can be used by an NMS to trigger LLDP remote systems table maintenance polls.</p> <p>lldp topologychange: Indicates that the switch senses an LLDP-MED topology change (the topology change of media endpoints). The trap can be triggered when adding or removing a media endpoint that supports LLDP, such as an IP Phone. An LLDP Remtableschange trap will be also triggered every time LLDP Topologychange trap is triggered.</p> <p>loopback-detection: Triggered when the Loopback Detection feature is enabled and a loopback is detected or cleared.</p> <p>storm-control: Monitors whether the storm rate has reached the limit that you have set. The trap can be triggered when the Storm Control feature is enabled and broadcast/multicast/unknown-unicast frames are sent to the port with a rate higher than what you have set.</p> <p>spanning-tree: Indicates spanning tree changes. The trap can be triggered in the following situations: a port changes from non-forwarding state to forwarding state or the other way round; a port receives a TCN (Topology Change Notification) BPDU or a Configuration BPDU with the TC (Topology Change) bit set.</p> <p>memory: Monitors the load status of the switch memory. The trap can be triggered when the memory utilization exceeds 80%.</p>
Step 3	end Return to Privileged EXEC Mode.
Step 4	copy running-config startup-config Save the settings in the configuration file.

The following example shows how to configure the switch to enable bandwidth-control traps:

```
Switch#configure
```

```
Switch(config)#snmp-server traps bandwidth-control
```

```
Switch(config)#end
```

```
Switch#copy running-config startup-config
```

■ Enabling the DDM Traps Globally

Note:

DDM Traps are only available on certain devices. To check whether your device supports this feature, refer to the actual web interface.

Step 1	configure Enter Global Configuration Mode.
Step 2	snmp-server traps ddm [temperature voltage bias_current tx_power rx_power] Enable the corresponding DDM traps. DDM function is used to monitor the status of the SFP modules inserted into the SFP ports on the switch. The command without parameter enables all SNMP DDM traps. By default, all DDM traps are disabled. temperature: Monitors the temperature of SFP modules inserted into the SFP ports on the switch. The trap can be triggered when the temperature of any SFP module has reached the warning or alarm threshold. voltage: Monitors the voltage of SFP modules inserted into the SFP ports on the switch. The trap can be triggered when the voltage of any SFP module has reached the warning or alarm threshold. bias_current: Monitors the bias current of SFP modules inserted into the SFP ports on the switch. The trap can be triggered when the bias current of any SFP module has reached the warning or alarm threshold. tx_power: Monitors the TX Power of SFP modules inserted into the SFP ports on the switch. The trap can be triggered when the TX Power of any SFP module has reached the warning or alarm threshold. rx_power: Monitors the RX Power of SFP modules inserted into the SFP ports on the switch. The trap can be triggered when the RX Power of any SFP module has reached the warning or alarm threshold.
Step 3	end Return to Privileged EXEC Mode.
Step 4	copy running-config startup-config Save the settings in the configuration file.

The following example shows how to configure the switch to enable DDM temperature trap:

```
Switch#configure
```

```
Switch(config)#snmp-server traps ddm temperature
```

```
Switch(config)#end
```

```
Switch#copy running-config startup-config
```

■ Enabling the VLAN Traps Globally

Step 1	configure Enter Global Configuration Mode.
--------	--

Step 2	<p>snmp-server traps vlan [create delete]</p> <p>Enable the corresponding VLAN traps. The command without parameter enables all SNMP VLAN traps. By default, all VLAN traps are disabled.</p> <p>create: Triggered when certain VLANs are created successfully.</p> <p>delete: Triggered when certain VLANs are deleted successfully.</p>
<hr/>	
Step 3	<p>end</p> <p>Return to Privileged EXEC Mode.</p>
<hr/>	
Step 4	<p>copy running-config startup-config</p> <p>Save the settings in the configuration file.</p>

The following example shows how to configure the switch to enable all the SNMP VLAN traps:

Switch#configure

Switch(config)#snmp-server traps vlan

Switch(config)#end

Switch#copy running-config startup-config

■ Enabling the SNMP Security Traps Globally

Step 1	<p>configure</p> <p>Enter Global Configuration Mode.</p>
<hr/>	
Step 2	<p>snmp-server traps security { dhcp-filter ip-mac-binding }</p> <p>Enable the corresponding security traps. By default, all security traps are disabled.</p> <p>dhcp-filter: Triggered when the DHCPv4 Filter feature is enabled and the switch receives DHCP packets from an illegal DHCP server.</p> <p>ip-mac-binding: Triggered when the ARP Inspection feature is enabled and the switch receives an illegal ARP packet, or the IPv4 Source Guard feature is enabled and the switch receives an illegal IP packet.</p>
<hr/>	
Step 3	<p>end</p> <p>Return to Privileged EXEC Mode.</p>
<hr/>	
Step 4	<p>copy running-config startup-config</p> <p>Save the settings in the configuration file.</p>

The following example shows how to configure the switch to enable DHCP filter trap:

Switch#configure

Switch(config)#snmp-server traps security dhcp-filter

Switch(config)#end

Switch#copy running-config startup-config

■ Enabling the ACL Trap Globally

Step 1	configure Enter Global Configuration Mode.
Step 2	snmp-server traps security acl Enable the ACL trap. By default, it is disabled. The trap monitors matched ACL information, including the matched ACL ID, rule ID and the number of the matched packets. With both this trap and the Logging feature in the ACL rule settings enabled, the switch will check the matched ACL information every five minutes and send SNMP traps if there is any updated information.
Step 3	end Return to Privileged EXEC Mode.
Step 4	copy running-config startup-config Save the settings in the configuration file.

The following example shows how to configure the switch to enable ACL trap:

Switch#configure

Switch(config)#snmp-server traps acl

Switch(config)#end

Switch#copy running-config startup-config

■ Enabling the IP Traps Globally

Step 1	configure Enter Global Configuration Mode.
Step 2	snmp-server traps ip { change duplicate } Enable the IP traps. By default, all IP traps are disabled. change: Monitors the changes of interfaces' IP addresses. The trap can be triggered when the IP address of any interface is changed. duplicate: Triggered when the switch detects an IP conflict.
Step 3	end Return to Privileged EXEC Mode.
Step 4	copy running-config startup-config Save the settings in the configuration file.

The following example shows how to configure the switch to enable IP-Change trap:

```
Switch#configure
```

```
Switch(config)#snmp-server traps ip change
```

```
Switch(config)#end
```

```
Switch#copy running-config startup-config
```

■ Enabling the SNMP PoE Traps Globally

Note:

PoE trap is only available on certain devices. To check whether your device supports this feature, refer to the actual web interface.

Step 1	configure Enter Global Configuration Mode.
Step 2	<p>snmp-server traps power [over-max-pwr-budget port-pwr-change port-pwr-deny port-pwr-over-30w port-pwr-overload port-short-circuit thermal-shutdown]</p> <p>Enable the PoE traps. The command without any parameter enables all PoE traps. By default, all PoE traps are disabled.</p> <p>over-max-pwr-budget: Triggered when the total power required by the connected PDs exceeds the maximum power the PoE switch can supply.</p> <p>port-pwr-change: Triggered when the total power required by the connected PDs exceeds the maximum power the PoE switch can supply.</p> <p>port-pwr-deny: Triggered when the switch powers off PDs on low-priority PoE ports. The switch powers off them to ensure stable running of the other PDs when the total power required by the connected PDs exceeds the system power limit.</p> <p>port-pwr-over-30w: Triggered when the power required by the connected PD exceeds 30 watts.</p> <p>port-pwr-overload: Triggered when the power required by the connected PD exceeds the maximum power the port can supply.</p> <p>port-short-circuit: Triggered when a short circuit is detected on a port.</p> <p>thermal-shutdown: Triggered when the PSE chip overheats. The switch will stop supplying power in this case.</p>
Step 3	end Return to Privileged EXEC Mode.
Step 4	copy running-config startup-config Save the settings in the configuration file.

The following example shows how to configure the switch to enable all PoE traps:

```
Switch#configure
```

```
Switch(config)#snmp-server traps power
```

```
Switch(config)#end
```

```
Switch#copy running-config startup-config
```

■ Enabling the Link-status Trap for Ports

Step 1	configure Enter Global Configuration Mode.
Step 2	interface {fastEthernet <i>port</i> range fastEthernet <i>port-list</i> gigabitEthernet <i>port</i> range gigabitEthernet <i>port-list</i> ten-gigabitEthernet <i>port</i> range ten-gigabitEthernet <i>port-list</i> } Configure notification traps on the specified ports. <i>port/port-list</i> : The number or the list of the Ethernet ports that you desire to configure notification traps. To configure multiple ports, enter a list of port numbers separated by commas, or use a hyphen to indicate a range of port numbers. For example, 1-3, 5 indicates port 1, 2, 3, 5.
Step 3	snmp-server traps link-status Enable Link Status Trap for the port. By default, it is enabled. Link Status Trap (including Linkup Trap and Linkdown Trap) can be triggered when the link status of a port changes, and the trap is enabled both globally and on the port. To enable Linkup Trap and Linkdown Trap globally, run the command snmp-server traps snmp [linkup linkdown] in Global Configuration Mode. To disable it, run the corresponding no command.
Step 4	end Return to Privileged EXEC Mode.
Step 5	copy running-config startup-config Save the settings in the configuration file.

The following example shows how to configure the switch to enable link-status trap:

```
Switch#configure
```

```
Switch(config)#interface gigabitEthernet 1/0/1
```

```
Switch(config-if)#snmp-server traps link-status
```

```
Switch(config-if)#end
```

```
Switch#copy running-config startup-config
```

4 RMON

RMON (Remote Network Monitoring) together with the SNMP system allows the network manager to monitor remote network devices efficiently. RMON reduces traffic flow between the NMS and managed devices, which is convenient to manage large networks.

RMON includes two parts: the NMS and the Agents running on every network device. The NMS is usually a host that runs the management software to manage Agents of network devices. The Agent is usually a switch or router that collects traffic statistics (such as the total number of packets on a network segment during a certain time period, or total number of correct packets that are sent to a host). Based on SNMP protocol, the NMS collects network data by communicating with Agents. However, the NMS cannot obtain every datum of RMON MIB because the device resources are limited. Generally, the NMS can only get information of the following four groups: Statistics, History, Event and Alarm.

- **Statistics:** Collects Ethernet statistics (like the total received bytes, the total number of broadcast packets, and the total number of packets with specified size) on an interface.
- **History:** Collects a history group of statistics on Ethernet ports for a specified polling interval.
- **Event:** Specifies the action to be taken when an event is triggered by an alarm. The action can be to generate a log entry or an SNMP trap.
- **Alarm:** Monitors a specific MIB object for a specified interval, and triggers an event at a specified value (rising threshold or falling threshold).

5 RMON Configurations

With RMON configurations, you can:

- Configuring the Statistics group.
- Configuring the History group.
- Configuring the Event group.
- Configuring the Alarm group.

Configuration Guidelines

To ensure that the NMS receives notifications normally, complete configurations of SNMP and SNMP Notification before configuring RMON.

5.1 Using the GUI

5.1.1 Configuring the Statistics Group

Choose the menu **MAINTENANCE > SNMP > RMON > Statistics** and click  Add to load the following page.

Figure 5-1 Creating a Statistics Entry

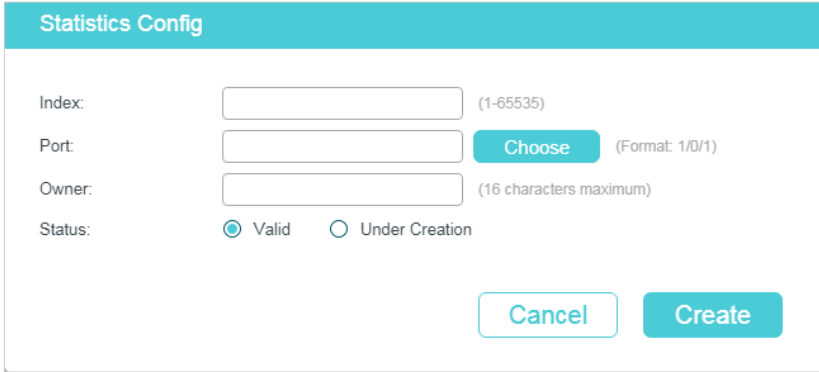

Follow these steps to configure the Statistics group:

- 1) Specify the entry index, the port to be monitored, and the owner name of the entry. Set the entry as Valid or Under Creation.

Index	Enter the ID of the entry.
Port	Specify an Ethernet port to be monitored in the entry. You can click Choose to choose a port from the list or manually enter the port number, for example, 1/0/1 in the input box.
Owner	Enter the owner name of the entry with 1 to 16 characters.

Status Configure the entry as Valid or Under Creation. By default, it is Valid. The switch start to collect Ethernet statistics for a Statistics entry since the entry status is configured as valid.

Valid: The entry is created and valid.

Under Creation: The entry is created but invalid.

2) Click **Create**.

5.1.2 Configuring History Group

Choose the menu **MAINTENANCE > SNMP > RMON > History** to load the following page.

Figure 5-2 Configuring the History Entry

History Control Config						
<input type="checkbox"/>	Index	Port	Interval (seconds)	Maximum Buckets	Owner	Status
<input type="checkbox"/>	1	1/0/1	1800	10	monitor	Disabled
<input type="checkbox"/>	2	1/0/1	1800	10	monitor	Disabled
<input type="checkbox"/>	3	1/0/1	1800	10	monitor	Disabled
<input type="checkbox"/>	4	1/0/1	1800	10	monitor	Disabled
<input type="checkbox"/>	5	1/0/1	1800	10	monitor	Disabled
<input type="checkbox"/>	6	1/0/1	1800	10	monitor	Disabled
<input type="checkbox"/>	7	1/0/1	1800	10	monitor	Disabled
<input type="checkbox"/>	8	1/0/1	1800	10	monitor	Disabled
<input type="checkbox"/>	9	1/0/1	1800	10	monitor	Disabled
<input type="checkbox"/>	10	1/0/1	1800	10	monitor	Disabled
Total: 12						

Follow these steps to configure the History group:

1) Select a History entry, and specify a port to be monitored.

Index Displays the index of History entries. The switch supports up to 12 History entries.

Port Specify a port to be monitored.

2) Set the sample interval and the maximum buckets of History entries.

Interval (seconds) Specify the number of seconds in each polling cycle. Valid values are from 10 to 3600 seconds. Every history entry has its own timer. For the monitored port, the switch samples packet information and generates a record in every interval.

Maximum Buckets Set the maximum number of records for the History entry. Valid values are from 10 to 130. When the number of records exceeds the limit, the earliest record will be overwritten.

3) Enter the owner name, and set the status of the entry. Click **Apply**.

Owner	Enter the owner name of the entry with 1 to 16 characters. By default, it is monitor.
Status	Enable or disable the entry. By default, it is disabled. Enable: The entry is enabled. Disable: The entry is disabled.

 **Note:**

To change the parameters of a History entry, enable the entry at the same time; otherwise, the change cannot take effect.

5.1.3 Configuring Event Group

Choose the menu **MAINTENANCE > SNMP > RMON > Event** to load the following page.

Figure 5-3 Configuring the Event Entry

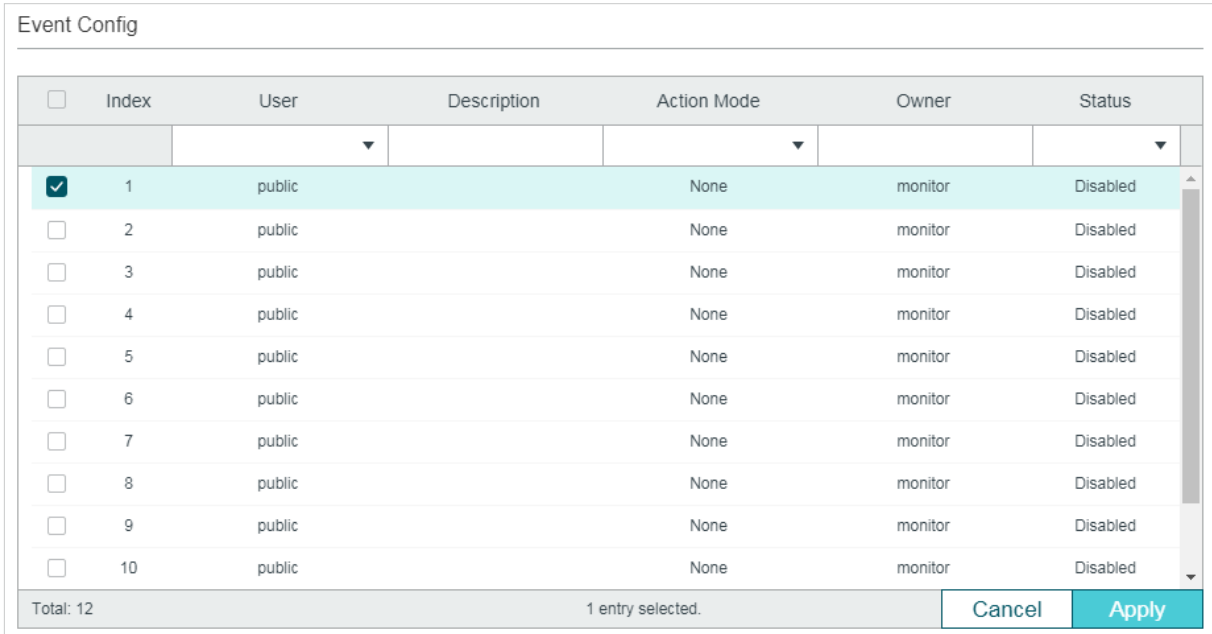

<input type="checkbox"/>	Index	User	Description	Action Mode	Owner	Status
<input checked="" type="checkbox"/>	1	public		None	monitor	Disabled
<input type="checkbox"/>	2	public		None	monitor	Disabled
<input type="checkbox"/>	3	public		None	monitor	Disabled
<input type="checkbox"/>	4	public		None	monitor	Disabled
<input type="checkbox"/>	5	public		None	monitor	Disabled
<input type="checkbox"/>	6	public		None	monitor	Disabled
<input type="checkbox"/>	7	public		None	monitor	Disabled
<input type="checkbox"/>	8	public		None	monitor	Disabled
<input type="checkbox"/>	9	public		None	monitor	Disabled
<input type="checkbox"/>	10	public		None	monitor	Disabled

Total: 12 1 entry selected. Cancel Apply

Follow these steps to configure the Event group:

- 1) Choose an Event entry, and specify an SNMP User for the entry.

Index	Displays the index of Event entries. The switch supports up to 12 Event entries.
User	Choose an SNMP user name or community name for the entry. The name should be the same as what you have set in SNMP previously.

- 2) Set the description and action to be taken when the event is triggered.

Description	Enter an brief description of this event to make identifying it easier.
--------------------	---

Action Mode Specify the action for the switch to take when the event is triggered.

None: No action.

Log: The switch records the event in the log, and the NMS should initiate requests to get notifications.

Notify: The switch sends notifications to the NMS.

Log & Notify: The switch records the event in the log and sends notifications to the NMS.

3) Enter the owner name, and set the status of the entry. Click **Apply**.

Owner Enter the owner name of the entry with 1 to 16 characters.

Status Enable or disable the entry.

Enable: The entry is enabled.

Disable: The entry is disabled.

5.1.4 Configuring Alarm Group

Before you begin, complete configurations of Statistics entries and Event entries, because the Alarm entries must be associated with Statistics and Event entries.

Choose the menu **MAINTENANCE > SNMP > RMON > Alarm** to load the following page.

Figure 5-4 Configuring the Alarm Entry

<input type="checkbox"/>	Index	Variable	Statistics	Sample Type	Rising Threshold	Rising Event	Falling Threshold	Falling Event
<input checked="" type="checkbox"/>	1	RecBytes	0	Absolute	100	0	100	0
<input type="checkbox"/>	2	RecBytes	0	Absolute	100	0	100	0
<input type="checkbox"/>	3	RecBytes	0	Absolute	100	0	100	0
<input type="checkbox"/>	4	RecBytes	0	Absolute	100	0	100	0
<input type="checkbox"/>	5	RecBytes	0	Absolute	100	0	100	0
<input type="checkbox"/>	6	RecBytes	0	Absolute	100	0	100	0
<input type="checkbox"/>	7	RecBytes	0	Absolute	100	0	100	0
<input type="checkbox"/>	8	RecBytes	0	Absolute	100	0	100	0
<input type="checkbox"/>	9	RecBytes	0	Absolute	100	0	100	0
<input type="checkbox"/>	10	RecBytes	0	Absolute	100	0	100	0

Total: 12 1 entry selected.

Follow these steps to configure the Alarm group:

- 1) Select an alarm entry, choose a variable to be monitored, and associate the entry with a statistics entry.

Index	Displays the index of Alarm entries. The switch supports up to 12 Alarm entries.
Variable	<p>Set the alarm variable to be monitored. The switch will monitor the specified variable in sample intervals and act in the set way when the alarm is triggered.</p> <p>RecBytes: Total number of received bytes.</p> <p>RecPackets: Total number of received packets.</p> <p>BPackets: Total number of broadcast packets.</p> <p>MPackets: Total number of multicast packets.</p> <p>CRC&Align ERR: Packets that contain FCS Error or Alignment Error, within a size of 64 to 1518 bytes.</p> <p>Undersize: Packets that are smaller than 64 bytes.</p> <p>Oversize: Packets that are larger than 1518 bytes.</p> <p>Jabbers: Packets that are sent when port collisions occur.</p> <p>Collisions: Collision times in the network segment.</p> <p>64, 65-127, 128-255, 256-511, 512-1023, 1024-1518: Total number of packets of the specified size.</p>
Statistics	Associate the alarm entry with a statistics entry. Then the switch monitors the specified variable of the statistics entry.

- 2) Set the sample type, the rising and falling threshold, the corresponding event entries, and the alarm type of the entry.

Sample Type	<p>Configure the sampling method of the specified variable.</p> <p>Absolute: Compare the sampling value against the preset threshold.</p> <p>Delta: The switch obtains the difference between the sampling values of the current interval and the previous interval, and then compares the difference against the preset threshold.</p>
Rising Threshold	<p>Specify the rising threshold of the variable. Valid values are from 1 to 2147483647. When the sampling value or the difference value exceeds the threshold, the system will trigger the corresponding Rising Event.</p> <p><i>Note:</i> The rising threshold should be larger than the falling threshold.</p>
Rising Event	Specify the index of the event that will be triggered when the sampled value exceeds the preset threshold. The Event entry specified here should be enabled first.

Falling Threshold	<p>Set the falling threshold of the variable. Valid values are from 1 to 2147483647. When the sampling value or the difference value is below the threshold, the system will trigger the corresponding Falling Event.</p> <p><i>Note:</i> The falling threshold should be less than the rising threshold.</p>
Falling Event	<p>Specify the index of the Event entry that will be triggered when the sampling value or the difference value is below the preset threshold. The Event entry specified here should be enabled first.</p>
Alarm Type	<p>Specify the alarm type for the entry.</p> <p>Rising: The alarm is triggered only when the sampling value or the difference value exceeds the rising threshold.</p> <p>Falling: The alarm is triggered only when the sampling value or the difference value is below the falling threshold.</p> <p>All: The alarm is triggered when the sampling value or the difference value exceeds the rising threshold or is below the falling threshold.</p>

3) Enter the owner name, and set the status of the entry. Click **Apply**.

Interval (seconds)	Set the sampling interval. Valid values are from 10 to 3600 seconds.
Owner	Enter the owner name of the entry with 1 to 16 characters.
Status	<p>Enable or disable the entry.</p> <p>Enable: The entry is enabled.</p> <p>Disable: The entry is disabled.</p>

5.2 Using the CLI

5.2.1 Configuring Statistics

Step 1	<p>configure</p> <p>Enter Global Configuration Mode.</p>
--------	---

Step 2 **rmon statistics** *index* **interface** { **fastEthernet** *port* | **gigabitEthernet** *port* | **ten-gigabitEthernet** *port* } [**owner** *owner-name*] [**status** { **underCreation** | **valid** }]

Configure RMON Statistic entries.

index: Specify the index of the Statistics entry, which ranges from 1 to 65535. To configure multiple indexes, enter a list of indexes separated by commas, or use a hyphen to indicate a range of indexes. For example, 1-3, 5 indicates 1, 2, 3, 5.

port: Specify the port to be bound to the entry.

owner-name: Enter the owner name of the entry with 1 to 16 characters. The default name is monitor.

underCreation | **valid**: Enter the status of the entry. UnderCreation indicates that the entry is created but invalid, while Valid indicates the entry is created and valid. By default, it is valid.

The switch starts to collect Ethernet statistics for a Statistics entry since the entry status is configured as valid.

Step 3 **show rmon statistics** [*index*]

Displays the statistics entries and their configurations.

index: Enter the index of statistics entry that you want to view. Valid values are from 1 to 65535. The command without any parameters displays all existing statistics entries.

Step 4 **end**

Return to Privileged EXEC Mode.

Step 5 **copy running-config startup-config**

Save the settings in the configuration file.

The following example shows how to create Statistics entries 1 and 2 on the switch to monitor port 1/0/1 and 1/0/2, respectively. The owner of the entries are both monitor and the status are both valid:

Switch#configure

Switch(config)#rmon statistics 1 interface gigabitEthernet 1/0/1 owner monitor status valid

Switch(config)#rmon statistics 2 interface gigabitEthernet 1/0/2 owner monitor status valid

Switch(config)#show rmon statistics

Index	Port	Owner	State
-----	----	-----	-----
1	Gi1/0/1	monitor	valid
2	Gi1/0/2	monitor	valid

Switch(config)#end

Switch#copy running-config startup-config**5.2.2 Configuring History**

Step 1	configure Enter Global Configuration Mode.
Step 2	rmon history <i>index</i> interface { fastEthernet <i>port</i> gigabitEthernet <i>port</i> ten-gigabitEthernet <i>port</i> } [interval <i>seconds</i>] [owner <i>owner-name</i>] [buckets <i>number</i>] Configuring RMON History entries. <i>index</i> : Specify the index of the History entry, which ranges from 1 to 12. To configure multiple indexes, enter a list of indexes separated by commas, or use a hyphen to indicate a range of indexes. For example, 1-3, 5 indicates 1, 2, 3, 5. <i>port</i> : Specify the port to be bound to the entry. <i>seconds</i> : Set the sample interval. The values are from 10 to 3600 seconds, and the default is 1800 seconds. <i>owner-name</i> : Enter the owner name of the entry with 1 to 16 characters. The default name is monitor. <i>number</i> : Set the maximum number of records for the history entry. When the number of records exceeds the limit, the earliest record will be overwritten. The values are from 10 to 130; the default is 50.
Step 3	show rmon history [<i>index</i>] Displays the specified History entry and related configurations. To show multiple entries, enter a list of indexes separated by commas, or use a hyphen to indicate a range of indexes. For example, 1-3, 5 indicates 1, 2, 3, 5. <i>index</i> : Enter the index of History entry that you want to view. Valid values are from 1 to 12. The command without any parameters displays all existing statistics entries.
Step 4	end Return to Privileged EXEC Mode.
Step 5	copy running-config startup-config Save the settings in the configuration file.

The following example shows how to create a History entry on the switch to monitor port 1/0/1. Set the sample interval as 100 seconds, maximum buckets as 50, and the owner as monitor:

Switch#configure

```
Switch(config)#rmon history 1 interface gigabitEthernet 1/0/1 interval 100 owner monitor buckets 50
```

Switch(config)#show rmon history

Index	Port	Interval	Buckets	Owner	State
1	Gi1/0/1	100	50	monitor	Enable

Switch(config)#end

Switch#copy running-config startup-config

5.2.3 Configuring Event

Step 1	<p>configure</p> <p>Enter Global Configuration Mode.</p>
Step 2	<p>rmon event <i>index</i> [user <i>user-name</i>] [description <i>description</i>] [type { none log notify log-notify }] [owner <i>owner-name</i>]</p> <p>Configuring RMON Event entries.</p> <p><i>index</i>: Specify the index of the Event entry, which ranges from 1 to 12. To configure multiple indexes, enter a list of indexes separated by commas, or use a hyphen to indicate a range of indexes. For example, 1-3, 5 indicates 1, 2, 3, 5.</p> <p><i>user-name</i>: Enter the SNMP user name or community name of the entry. The name should be what you have set in SNMP previously. The default name is public.</p> <p><i>description</i>: Give a description to the entry with 1 to 16 characters. By default, the description is empty.</p> <p>none log notify log-notify: Specify the action type of the event; then the switch will take the specified action to deal with the event. By default, the type is none. None indicates the switch takes no action, log indicates the switch records the event only, notify indicates the switch sends notifications to the NMS only, and log-notify indicates the switch records the event and sends notifications to the NMS.</p> <p><i>owner-name</i>: Enter the owner name of the entry with 1 to 16 characters. The default name is monitor.</p>
Step 3	<p>show rmon event [<i>index</i>]</p> <p>Displays the specified Event entry and related configurations. To show multiple entries, enter a list of indexes separated by commas, or use a hyphen to indicate a range of indexes. For example, 1-3, 5 indicates 1, 2, 3, 5.</p> <p><i>index</i>: Enter the index of Event entry that you want to view. Valid values are from 1 to 12. The command without any parameters displays all existing statistics entries.</p>
Step 4	<p>end</p> <p>Return to Privileged EXEC Mode.</p>
Step 5	<p>copy running-config startup-config</p> <p>Save the settings in the configuration file.</p>

The following example shows how to create an Event entry on the switch. Set the user name as admin, the event type as Notify (set the switch to initiate notifications to the NMS), and the owner as monitor:

Switch#configure

```
Switch(config)#rmon event 1 user admin description rising-notify type notify owner monitor
```

Switch(config)#show rmon event

Index	User	Description	Type	Owner	State
-----	----	-----	----	-----	-----
1	admin	rising-notify	Notify	monitor	Enable

Switch(config)#end

```
Switch#copy running-config startup-config
```

5.2.4 Configuring Alarm

Step 1

configure

Enter Global Configuration Mode.

Step 2

```
rmon alarm index stats-index sindex [alarm-variable { revbyte | revpkt | bpkt | mpkt | crc-align | undersize | oversize | jabber | collision | 64 | 65-127 | 128-255 | 256-511 | 512-1023 | 1024-1518}] [s-type {absolute | delta}] [rising-threshold r-threshold] [rising-event-index r-event] [falling-threshold f-threshold] [falling-event-index f-event] [a-type {rise | fall | all}] [owner owner-name] [interval interval]
```

Configuring RMON alarm entries.

index: Specify the index of the Alarm entry, which ranges from 1 to 12. To configure multiple indexes, enter a list of indexes separated by commas, or use a hyphen to indicate a range of indexes. For example, 1-3, 5 indicates 1, 2, 3, 5.

sindex: Specify the index of the related Statistics entry, which ranges from 1 to 65535.

revbyte | revpkt | bpkt | mpkt | crc-align | undersize | oversize | jabber | collision | 64 | 65-127 | 128-255 | 256-511 | 512-1023 | 1024-1518: Choose an alarm variable to monitor. The switch will monitor the specified variable in sample intervals and act in the set way when the alarm is triggered. The default variable is revbyte.

revbyte means total number of received bytes; *revpkt* means total number of received packets; *bpkt* means total number of broadcast packets. *mpkt* means total number of multicast packets; *crc-align* means packets that contain FCS Error or Alignment Error, within a size of 64 to 1518 bytes; *undersize* means packets that are smaller than 64 bytes; *oversize* means packets that are larger than 1518 bytes; *jabber* means packets that are sent when port collisions occur; *collision* means the collision times in the network segment; *64 | 65-127 | 128-255 | 256-511 | 512-1023 | 1024-1518* means total number of packets of the specified size.

absolute | delta: Choose the sampling method of the specified variable. The default is absolute. In the absolute mode, the switch compares the sampling value against the preset threshold; in the delta mode, the switch obtains the difference between the sampling values of the current interval and the previous interval, and then compares the difference against the preset threshold.

r-threshold: Enter the rising threshold. Valid values are from 1 to 2147483647, and the default is 100. The rising threshold should be larger than the falling threshold.

r-event: Enter the index of the Event entry that will be triggered when the sampling value or the difference value exceeds the preset threshold. Valid values are from 1 to 12. The Event entry specified here should be enabled first.

f-threshold: Enter a falling threshold. Valid values are from 1 to 2147483647, and the default is 100. The falling threshold should be less than the rising threshold.

f-event: Enter the index of the Event entry that will be triggered when the sampling value or the difference value is below the preset threshold. Valid values are from 1 to 12. The Event entry specified here should be enabled first.

rise | fall | all: Choose an alarm type; the default is all. Rise indicates that the alarm is triggered only when the sampling value or difference value exceeds the rising threshold. Fall indicates that the alarm is triggered only when the sampling value or difference value is below the falling threshold. All indicates that the alarm is triggered when the sampling value or difference value either exceeds the rising threshold or is below the falling threshold.

owner-name: Enter the owner name of the entry using 1 to 16 characters. The default name is monitor.

interval: Set the sampling interval. The value ranges from 10 to 3600 seconds; the default is 1800 seconds.

Step 3 **show rmon alarm [index]**

Displays the specified alarm entry and related configurations. To show multiple entries, enter a list of indexes separated by commas, or use a hyphen to indicate a range of indexes. For example, 1-3, 5 indicates 1, 2, 3, 5.

index: Enter the index of Alarm entry that you want to view. Valid values are from 1 to 12. The command without any parameters displays all existing statistics entries.

Step 4 **end**

Return to Privileged EXEC Mode.

Step 5 **copy running-config startup-config**

Save the settings in the configuration file.

The following example shows how to set an alarm entry to monitor BPPackets on the switch. Set the related Statistics entry index as 1, the sample type as Absolute, the rising threshold as 3000, the related rising event entry index as 1, the falling threshold as 2000, the related falling event index as 2, the alarm type as all, the notification interval as 10 seconds, and the owner of the entry as monitor:

Switch#configure

```
Switch(config)#rmon alarm 1 stats-index 1 alarm-variable bpkt s-type absolute rising-  
threshold 3000 rising-event-index 1 falling-threshold 2000 falling-event-index 2 a-type  
all interval 10 owner monitor
```

```
Switch(config)#show rmon alarm
```

```
Index-State:    1-Enabled  
Statistics index: 1  
Alarm variable: BPkt  
Sample Type:   Absolute  
RHold-REvent: 3000-1  
FHold-FEvent: 2000-2  
Alarm startup: All  
Interval:      10  
Owner:         monitor
```

```
Switch(config)#end
```

```
Switch#copy running-config startup-config
```

6 Configuration Example

6.1 Network Requirements

The following figure shows the network topology of a company. The company has requirements as follows:

- 1) Monitor storm traffic of ports 1/0/1 and 1/0/2 on Switch A, and send notifications to the NMS when the actual rate of broadcast, multicast or unknown-unicast packets exceeds the preset threshold.
- 2) Monitor the traffic of ports 1/0/1 and 1/0/2 on Switch A, and regularly collect and save data for follow-up checks. Specifically, Switch A should notify the NMS when the number of packets transmitted and received on the ports during the sample interval exceeds the preset rising threshold, and should record but not notify the NMS when that is below the preset falling threshold.

The NMS host with IP address 192.168.1.222 is connected to the core switch, Switch B. Switch A is connected to Switch B via port 1/0/3. Port 1/0/3 and the NMS can reach one another.

Figure 6-1 Network Topology

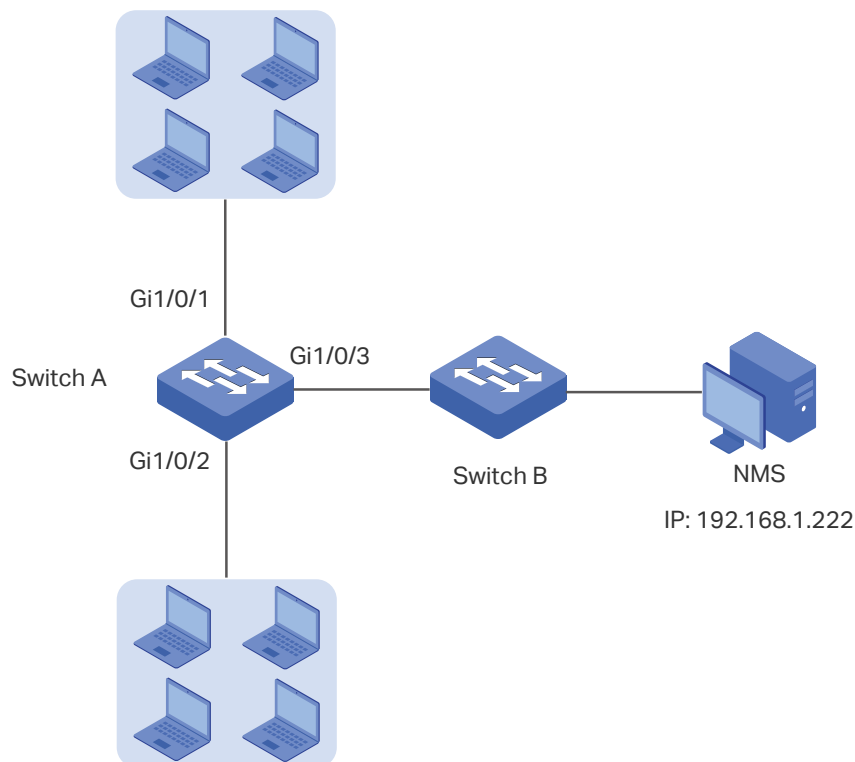

6.2 Configuration Scheme

- 1) On Switch A, set thresholds for broadcast, multicast and unknown-unicast packets on ports 1/0/1 and 1/0/2. Enable SNMP and configure the corresponding parameters. Enable Trap notifications on the ports. Switch A can then send notifications to the NMS when the rate of storm traffic exceeds the preset threshold.
- 2) After SNMP and Notification configurations, create Statistic entries on the ports to monitor the real-time transmitting and receiving of packets and create History entries to regularly collect and save related data. Create two Event entries: one is the Notify type used to notify the NMS, and the other is the Log type used to record related events.
- 3) Create an Alarm entry to monitor RecPackets (Received Packets). Configure the rising and falling thresholds. Configure the rising event as the Notify event entry, and the falling event as the Log event entry.

Demonstrated with SG6654XHP, this chapter provides configuration procedures in two ways: using the GUI and using the CLI.

6.3 Using the GUI

■ Configuring Storm Control on Ports

Configure Storm Control on the required ports. For detailed configuration, refer to [Configuring QoS](#).

■ Configuring SNMP

- 1) Choose **MAINTENANCE > SNMP > Global Config** to load the following page. In the **Global Config** section, enable SNMP, and set the Remote Engine ID as 123456789a. Click **Apply**.

Figure 6-2 Enabling SNMP

Global Config

SNMP: Enable

Local Engine ID: Default ID (10-64 Hex)

Remote Engine ID: (Null or 10-64 Hex)

- 2) In the **SNMP View Config** section, click **+ Add** to load the following page. Name the SNMP view as View, set the view type as Include, and set MIB Object ID as 1 (which means all functions). Click **Create**.

Figure 6-3 Creating an SNMP View

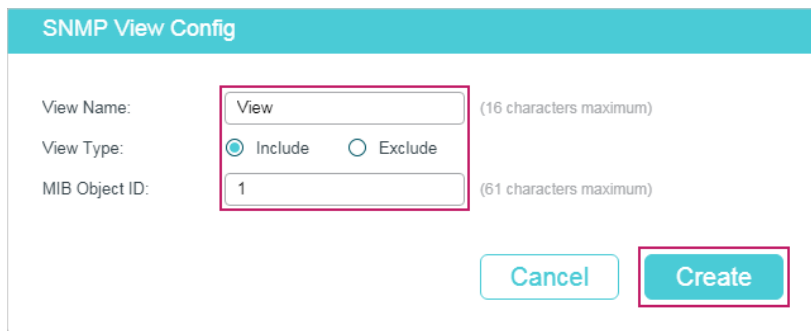

The image shows the 'SNMP View Config' form. It has a teal header. The form contains three input fields: 'View Name' with the value 'View' and a note '(16 characters maximum)', 'View Type' with radio buttons for 'Include' (selected) and 'Exclude', and 'MIB Object ID' with the value '1' and a note '(61 characters maximum)'. At the bottom right, there are two buttons: 'Cancel' and 'Create'.

- 3) Choose **MAINTENANCE > SNMP > SNMP v3 > SNMP Group** and click **+** Add to load the following page. Create a group named nms-monitor, enable authentication and privacy, and add View to Read View and Notify View. Click **Create**.

Figure 6-4 Configuring an SNMP Group

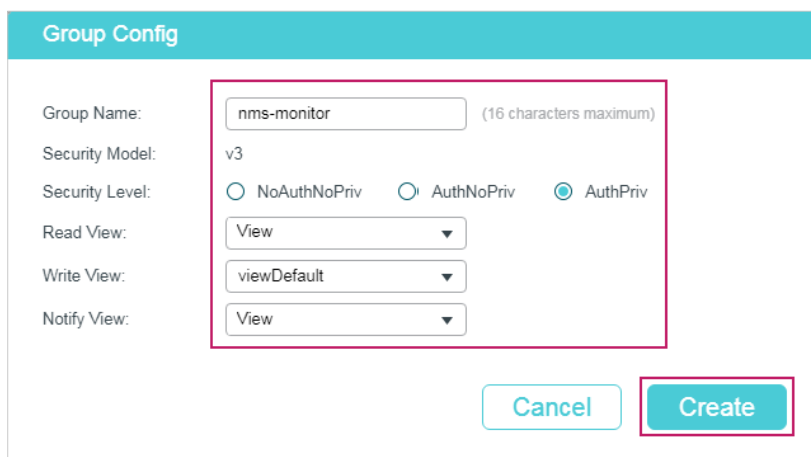

The image shows the 'Group Config' form. It has a teal header. The form contains several fields: 'Group Name' with the value 'nms-monitor' and a note '(16 characters maximum)', 'Security Model' set to 'v3', 'Security Level' with radio buttons for 'NoAuthNoPriv', 'AuthNoPriv', and 'AuthPriv' (selected), 'Read View' with a dropdown menu showing 'View', 'Write View' with a dropdown menu showing 'viewDefault', and 'Notify View' with a dropdown menu showing 'View'. At the bottom right, there are two buttons: 'Cancel' and 'Create'.

- 4) Choose **MAINTENANCE > SNMP > SNMP v3 > SNMP User** and click **+** Add to load the following page. Create a user named admin for the NMS, set the user type as Remote User and specify the group name. Set the Security Level in accordance with that of the group nms-monitor. Choose SHA authentication algorithm and DES privacy algorithm, and set corresponding passwords. Click **Create**.

Figure 6-5 Creating an SNMP User

The screenshot shows the 'User Config' form with the following fields and values:

- User Name: admin (16 characters maximum)
- User Type: Local User Remote User
- Group Name: nms-monitor
- Security Model: v3
- Security Level: NoAuthNoPriv AuthNoPriv AuthPriv
- Authentication Mode: MD5 SHA
- Authentication Password: **** (16 characters maximum)
- Privacy Mode: DES
- Privacy Password: **** (16 characters maximum)

Buttons: Cancel, Create

- 5) Choose **MAINTENANCE > SNMP > Notification > Notification Config** and click Add to load the following page. Choose the IP Mode as IPv4, and specify the IP address of the NMS host and the port of the host for transmitting notifications. Specify the User as admin and choose the type as Inform. Set the retry times as 3, with the timeout period as 100 seconds. Click **Create**.

Figure 6-6 Creating an SNMP Notification Entry

The screenshot shows the 'Notification Config' form with the following fields and values:

- IP Mode: IPv4 IPv6
- IP Address: 192.168.1.222 (Format: 192.168.0.1)
- UDP Port: 162 (0-65535)
- User: admin
- Security Mode: v1 v2c v3
- Security Level: NoAuthNoPriv AuthNoPriv AuthPriv
- Type: Trap Inform
- Retry Times: 3 (1-255)
- Timeout: 100 (1-3600)

Buttons: Cancel, Create

- 6) Choose **MAINTENANCE > SNMP > Notification > Trap Config** to load the following page. Enable Storm Control trap and click **Apply**.

Figure 6-7 Enabling Storm Control Trap

The image shows a configuration window titled "SNMP Traps". It contains a grid of 24 checkboxes. The "Storm Control" checkbox is checked and highlighted with a red box. The "Apply" button in the bottom right corner is also highlighted with a red box. Other checked items include "SNMP Authentication", "Coldstart", and "Warmstart".

7) Click  to save the settings.

■ **Configuring RMON**

1) Choose **MAINTENANCE > SNMP > RMON > Statistics** and click  Add to load the following page. Create Statistics entries 1 and 2, and bind them to ports 1/0/1 and 1/0/2, respectively. Set the owner of the entries as monitor and the status as Valid.

Figure 6-8 Configuring Statistics Entry 1

The image shows the "Statistics Config" window for Entry 1. The fields are: Index: 1 (with a "(1-65535)" constraint); Port: 1/0/1 (with a "Choose" button and "(Format: 1/0/1)" constraint); Owner: monitor (with a "(16 characters maximum)" constraint); Status: Valid (selected radio button) and Under Creation (unselected radio button). "Cancel" and "Create" buttons are at the bottom.

Figure 6-9 Configuring Statistics Entry 2

The image shows the "Statistics Config" window for Entry 2. The fields are: Index: 2 (with a "(1-65535)" constraint); Port: 1/0/2 (with a "Choose" button and "(Format: 1/0/1)" constraint); Owner: monitor (with a "(16 characters maximum)" constraint); Status: Valid (selected radio button) and Under Creation (unselected radio button). "Cancel" and "Create" buttons are at the bottom.

2) Choose the menu **MAINTENANCE > SNMP > RMON > History** to load the following page. Configure entries 1 and 2. Bind entries 1 and 2 to ports 1/0/1 and 1/0/2, respectively. Set the Interval as 100 seconds, Maximum Buckets as 50, the owner of the entries as monitor, and the status as enabled.

Figure 6-10 Configuring the History Entries

History Control Config							
<input type="checkbox"/>	Index	Port	Interval (seconds)	Maximum Buckets	Owner	Status	
<input type="checkbox"/>	1	1/0/1	100	50	monitor	Enabled	▲
<input type="checkbox"/>	2	1/0/2	100	50	monitor	Enabled	
<input type="checkbox"/>	3	1/0/1	1800	50	monitor	Disabled	
<input type="checkbox"/>	4	1/0/1	1800	50	monitor	Disabled	
<input type="checkbox"/>	5	1/0/1	1800	50	monitor	Disabled	
<input type="checkbox"/>	6	1/0/1	1800	50	monitor	Disabled	
<input type="checkbox"/>	7	1/0/1	1800	50	monitor	Disabled	
<input type="checkbox"/>	8	1/0/1	1800	50	monitor	Disabled	
<input type="checkbox"/>	9	1/0/1	1800	50	monitor	Disabled	
<input type="checkbox"/>	10	1/0/1	1800	50	monitor	Disabled	
Total: 12							

- 3) Choose the menu **MAINTENANCE > SNMP > RMON > Event** to load the following page. Configure entries 1 and 2. For entry 1, set the SNMP user name as admin, type as Notify, description as "rising_notify", owner as monitor, and status as enable. For entry 2, set the SNMP user name as admin, type as Log, description as "falling_log", owner as monitor, and status as enabled.

Figure 6-11 Configuring the Event Entries

Event Config							
<input type="checkbox"/>	Index	User	Description	Action Mode	Owner	Status	
<input type="checkbox"/>	1	admin	rising_notify	Notify	monitor	Enabled	▲
<input type="checkbox"/>	2	admin	falling_log	Log	monitor	Enabled	
<input type="checkbox"/>	3	public		None	monitor	Disabled	
<input type="checkbox"/>	4	public		None	monitor	Disabled	
<input type="checkbox"/>	5	public		None	monitor	Disabled	
<input type="checkbox"/>	6	public		None	monitor	Disabled	
<input type="checkbox"/>	7	public		None	monitor	Disabled	
<input type="checkbox"/>	8	public		None	monitor	Disabled	
<input type="checkbox"/>	9	public		None	monitor	Disabled	
<input type="checkbox"/>	10	public		None	monitor	Disabled	
Total: 12							

- 4) Choose **MAINTENANCE > SNMP > RMON > Alarm** to load the following page. Configure entries 1 and 2. For entry 1, set the alarm variable as RecPackets, related statistics entry ID as 1 (bound to port 1/0/1), the sample type as Absolute, the rising threshold as 3000, associated rising event entry ID as 1 (which is the notify type), the falling threshold as 2000, the associated falling event entry ID as 2 (which is the log type), the alarm type as All, the interval as 10 seconds, the owner name as monitor. For entry 2, set the associated statistics entry ID as 2 (bound to port 1/0/2). Other configurations are the same as those of entry 1.

Figure 6-12 Configuring the Alarm Entries

<input type="checkbox"/>	Index	Variable	Statistics	Sample Type	Rising Threshold	Rising Event	Falling Threshold	Falling Event	Alarm Type	Interval (seconds)	Owner	Status
<input type="checkbox"/>	1	RecPackets	1	Absolute	3000	1	2000	2	All	10	monitor	Enabled
<input type="checkbox"/>	2	RecPackets	2	Absolute	3000	1	2000	2	All	10	monitor	Enabled
<input type="checkbox"/>	3	RecBytes	0	Absolute	100	0	100	0	All	1800	monitor	Disabled
<input type="checkbox"/>	4	RecBytes	0	Absolute	100	0	100	0	All	1800	monitor	Disabled
<input type="checkbox"/>	5	RecBytes	0	Absolute	100	0	100	0	All	1800	monitor	Disabled
<input type="checkbox"/>	6	RecBytes	0	Absolute	100	0	100	0	All	1800	monitor	Disabled
<input type="checkbox"/>	7	RecBytes	0	Absolute	100	0	100	0	All	1800	monitor	Disabled
<input type="checkbox"/>	8	RecBytes	0	Absolute	100	0	100	0	All	1800	monitor	Disabled
<input type="checkbox"/>	9	RecBytes	0	Absolute	100	0	100	0	All	1800	monitor	Disabled
<input type="checkbox"/>	10	RecBytes	0	Absolute	100	0	100	0	All	1800	monitor	Disabled

Total: 12

- 5) Click  to save settings.

6.4 Using the CLI

■ Configuring Storm Control on ports

Configure the Storm Control on the required ports of Switch A. For detailed configuration, refer to [Configuring QoS](#).

■ Configuring SNMP

- 1) Enable SNMP and specify the remote engine ID.

```
Switch_A#configure
```

```
Switch_A(config)#snmp-server
```

```
Switch_A(config)#snmp-server engineID remote 123456789a
```

- 2) Create a view with the name View; set the MIB Object ID as 1 (which represents all functions), and the view type as Include.

```
Switch_A(config)#snmp-server view View 1 include
```

- 3) Create a group of SNMPv3 with the name of nms-monitor. Enable Auth Mode and Privacy Mode, and set both the Read and Notify views as View.

```
Switch_A(config)#snmp-server group nms-monitor smode v3 slev authPriv read View notify View
```

- 4) Create an SNMP user named admin. Set the user as a remote user and configure the security model and security level based on the group. Set the Auth Mode as SHA algorithm, password as 1234, the Privacy Mode as DES, and password as 1234.

```
Switch_A(config)#snmp-server user admin remote nms-monitor smode v3 slev authPriv cmode SHA cpwd 1234 emode DES epwd 1234
```

- 5) To configure Notification, specify the IP address of the NMS host and UDP port. Set the User, Security Model and Security Level according to configurations of the SNMP User.

Choose the type as Inform, and set the retry times as 3, and the timeout period as 100 seconds.

```
Switch_A(config)#snmp-server host 192.168.1.222 162 admin smode v3 slev authPriv  
type inform retries 3 timeout 100
```

■ Enable storm-control Trap

```
Switch_A(config)#snmp-server traps storm-control
```

■ Configuring RMON

- 1) Create Statistics entries 1 and 2 to monitor ports 1/0/1 and 1/0/2, respectively. The owner of the entries is set as monitor, and the status is set as valid.

```
Switch_A(config)#rmon statistics 1 interface gigabitEthernet 1/0/1 owner monitor  
status valid
```

```
Switch_A(config)#rmon statistics 2 interface gigabitEthernet 1/0/2 owner monitor  
status valid
```

- 2) Create History entries 1 and 2 and bind them to ports 1/0/1 and 1/0/2, respectively. Set the sample interval as 100 seconds, max buckets as 50, and the owner as monitor.

```
Switch_A(config)#rmon history 1 interface gigabitEthernet 1/0/1 interval 100 owner  
monitor buckets 50
```

```
Switch_A(config)#rmon history 2 interface gigabitEthernet 1/0/2 interval 100 owner  
monitor buckets 50
```

- 3) Create Event entries 1 and 2 for the SNMP user admin. Set entry 1 as the Notify type and its description as "rising_notify". Set entry 2 as the Log type and its description as "falling_log". Set the owner of them as monitor.

```
Switch_A(config)#rmon event 1 user admin description rising_notify type notify owner  
monitor
```

```
Switch_A(config)#rmon event 2 user admin description falling_log type log owner  
monitor
```

- 4) Create Alarm entries 1 and 2. For entry 1, set the alarm variable as RecPackets, associated Statistics entry ID as 1 (bound to port 1/0/1), the sample type as Absolute, the rising threshold as 3000, the associated rising event entry ID as 1 (Notify type), the falling threshold as 2000, the associated falling event entry ID as 2 (the log type), the alarm type as all, the interval as 10 seconds, and the owner name as monitor. For entry 2, set the associated statistics entry ID as 2 (bound to port 1/0/2), while all other configurations are the same as those of entry 1.

```
Switch_A(config)#rmon alarm 1 stats-index 1 alarm-variable revpkt s-type absolute  
rising-threshold 3000 rising-event-index 1 falling-threshold 2000 falling-event-index 2  
a-type all interval 10 owner monitor
```

```
Switch_A(config)#rmon alarm 2 stats-index 2 alarm-variable revpkt s-type absolute
rising-threshold 3000 rising-event-index 1 falling-threshold 2000 falling-event-index 2
a-type all interval 10 owner monitor
```

Verify the Configurations

Verify global SNMP configurations:

```
Switch_A(config)#show snmp-server
```

SNMP agent is enabled.

```
0  SNMP packets input
   0  Bad SNMP version errors
   0  Unknown community name
   0  Illegal operation for community name supplied
   0  Encoding errors
   0  Number of requested variables
   0  Number of altered variables
   0  Get-request PDUs
   0  Get-next PDUs
   0  Set-request PDUs
0  SNMP packets output
   0  Too big errors(Maximum packet size 1500)
   0  No such name errors
   0  Bad value errors
   0  General errors
   0  Response PDUs
   0  Trap PDUs
```

Verify SNMP engine ID:

```
Switch_A(config)#show snmp-server engineID
```

Local engine ID: 80002e5703000aeb13a23d

Remote engine ID: 123456789a

Verify SNMP view configurations:

Switch_A(config)#show snmp-server view

No.	View Name	Type	MOID
1	viewDefault	include	1
2	viewDefault	exclude	1.3.6.1.6.3.15
3	viewDefault	exclude	1.3.6.1.6.3.16
4	viewDefault	exclude	1.3.6.1.6.3.18
5	View	include	1

Verify SNMP group configurations:

Switch_A(config)#show snmp-server group

No.	Name	Sec-Mode	Sec-Lev	Read-View	Write-View	Notify-View
1	nms-monitor	v3	authPriv	View		View

Verify SNMP user configurations:

Switch_A(config)#show snmp-server user

No.	U-Name	U-Type	G-Name	S-Mode	S-Lev	A-Mode	P-Mode
1	admin	remote	nms-monitor	v3	authPriv	SHA	DES

Verify SNMP host configurations:

Switch_A(config)#show snmp-server host

No.	Des-IP	UDP	Name	SecMode	SecLev	Type	Retry	Timeout
1	172.168.1.222	162	admin	v3	authPriv	inform	3	100

Verify RMON statistics configurations:

Switch_A(config)#show rmon statistics

Index	Port	Owner	State
1	Gi1/0/1	monitor	valid
2	Gi1/0/2	monitor	valid

Verify RMON history configurations:

Switch_A(config)#show rmon history

Index	Port	Interval	Buckets	Owner	State
1	Gi1/0/1	100	50	monitor	Enable
2	Gi1/0/2	100	50	monitor	Enable

Verify RMON event configurations:

Switch_A(config)#show rmon event

Index	User	Description	Type	Owner	State
1	admin	rising_notify	Notify	monitor	Enable
2	admin	falling_log	Log	monitor	Enable

Verify RMON alarm configurations:

Switch_A(config)#show rmon alarm

```

Index-State:      1-Enabled
Statistics index: 1
Alarm variable:   RevPkt
Sample Type:     Absolute
RHold-REvent:    3000-1
FHold-FEvent:    2000-2
Alarm startup:    All
Interval:        10
Owner:           monitor

```

Index-State: 2-Enabled
Statistics index: 2
Alarm variable: RevPkt
Sample Type: Absolute
RHold-REvent: 3000-1
FHold-FEvent: 2000-2
Alarm startup: All
Interval: 10
Owner: monitor

7 Appendix: Default Parameters

Default settings of SNMP are listed in the following tables.

Table 7-1 Default Global Config Settings

Parameter	Default Setting
SNMP	Disabled
Local Engine ID	Automatically
Remote Engine ID	None

Table 7-2 Default SNMP View Table Settings

View Name	View Type	MIB Object ID
viewDefault	Include	1
viewDefault	Exclude	1.3.6.1.6.3.15
viewDefault	Exclude	1.3.6.1.6.3.16
viewDefault	Exclude	1.3.6.1.6.3.18

Table 7-3 Default SNMP v1/v2c Settings

Parameter	Default Setting
Community Entry	No entries
Community Name	None
Access	Read-only
MIB View	viewDefault

Table 7-4 Default SNMP v3 Settings

Parameter	Default Setting
SNMP Group	
Group Entry	No entries
Group Name	None
Security Model	v3
Security Level	NoAuthNoPriv
Read View	viewDefault
Write View	None
Notify View	None

Parameter	Default Setting
SNMP User	
User Entry	No entries
User Name	None
User Type	Local User
Group Name	None
Security Model	v3
Security Level	noAuthNoPriv
Authentication Mode	MD5 (when Security Level is configured as AuthNoPriv or AuthPriv)
Authentication Password	None
Privacy Mode	DES (when Security Level is configured as AuthPriv)
Privacy Password	None

Default settings of Notification are listed in the following table.

Table 7-5 Default Notification Settings

Parameter	Default Setting
Notification Config	
Notification Entry	No entries
IP Mode	IPv4
IP Address	None
UDP Port	162
User	None
Security Model	v1
Security Level	noAuthNoPriv
Type	Trap
Retry	None
Timeout	None
Trap Config	
Enabled SNMP Traps	SNMP Authentication, Coldstart, Warmstart, Link Status

Default settings of RMON are listed in the following tables.

Table 7-6 Default Statistics Config Settings

Parameter	Default Setting
Statistics Entry	No entries
ID	None
Port	None
Owner	None
IP Mode	Valid

Table 7-7 Default Settings for History Entries

Parameter	Default Setting
Port	1/0/1
Interval	1800 seconds
Max Buckets	50
Owner	monitor
Status	Disabled

Table 7-8 Default Settings for Event Entries

Parameter	Default Setting
User	public
Description	None
Type	None
Owner	monitor
Status	Disabled

Table 7-9 Default Settings for Alarm Entries

Parameter	Default Setting
Variable	RecBytes
Statistics	0, means no Statistics entry is selected.
Sample Type	Absolute
Rising Threshold	100
Rising Event	0, means no event is selected.
Falling Threshold	100
Falling Event	0, means no event is selected.
Alarm Type	All

Parameter	Default Setting
Interval	1800 seconds
Owner	monitor
Status	Disabled

Part 41

Diagnosing the Device & Network

CHAPTERS

1. Diagnosing the Device
2. Diagnosing the Network
3. Appendix: Default Parameters

1 Diagnosing the Device

The device diagnostics feature provides cable testing, which allows you to troubleshoot based on the connection status, cable length and fault location.

1.1 Using the GUI

Choose the menu **MAINTENANCE > Device Diagnostics** to load the following page.

Figure 1-1 Diagnosing the Cable

Cable Test

UNIT1

1

3

5

7

9

11

13

15

17

19

21

23

25

27

29

31

33

35

2

4

6

8

10

12

14

16

18

20

22

24

26

28

30

32

34

36

37

39

41

43

45

47

49

51

53

38

40

42

44

46

48

50

52

54

Selected

Unselected

Not Available

Result			
Pair	Status	Length (meters)	Fault Location (meters)
A	--	--	--
B	--	--	--
C	--	--	--
D	--	--	--

Follow these steps to diagnose the cable:

- 1) Select your desired port for the test and click **Apply**.
- 2) Check the test results in the **Result** section.

Pair	Displays the Pair number.
-------------	---------------------------

Status	Displays the cable status. Test results include normal, short, open and crosstalk. Normal: The cable is connected normally. Short: A short circuit is being caused by abnormal contact of wires in the cable. Open: No device is connected to the other end or the connection is broken. Crosstalk: Impedance mismatch due to the quality of the cable.
Length	If the connection status is normal, the length range of the cable is displayed.
Fault Location	If the connection status is short, close or crosstalk, here displays the length from the port to the trouble spot.

1.2 Using the CLI

On privileged EXEC mode or any other configuration mode, you can use the following command to check the connection status of the cable that is connected to the switch.

```
show cable-diagnostics interface { fastEthernet port | gigabitEthernet port | ten-gigabitEthernet port }
```

View the cable diagnostics of the connected Ethernet Port.

port: Enter the port number in 1/0/1 format to check the result of the cable test.

```
show cable-diagnostics careful interface { fastEthernet port | gigabitEthernet port | ten-gigabitEthernet port }
```

View the cable diagnostics of the connected Ethernet Port. When taking the careful cable test, the switch will only test the cable for the port which is in the link-down status.

port: Enter the port number in 1/0/1 format to check the result of the cable test.

The following example shows how to check the cable diagnostics of port 1/0/2:

```
Switch#show cable-diagnostics interface gigabitEthernet 1/0/2
```

Port	Pair	Status	Length	Error
Gi1/0/2	Pair-A	Normal	2 (+/- 10m)	---
	Pair-B	Normal	2 (+/- 10m)	---
	Pair-C	Normal	0 (+/- 10m)	---
	Pair-D	Normal	2 (+/- 10m)	---

2 Diagnosing the Network

The network diagnostics feature provides Ping testing and Tracert testing. You can test connectivity to remote hosts, or to the gateways from the switch to the destination.

With Network Diagnostics, you can:

- Troubleshoot with Ping testing.
- Troubleshoot with Tracert testing.

2.1 Using the GUI

2.1.1 Troubleshooting with Ping Testing

You can use the Ping tool to test connectivity to remote hosts.

Choose the menu **MAINTENANCE > Network Diagnostics > Ping** to load the following page.

Figure 2-1 Troubleshooting with Ping Testing

The screenshot shows a web interface titled "Ping Config". It contains four input fields with their respective values and units: "Destination IP" with "192.168.0.1" (format: 192.168.0.1 or 2001::1), "Ping Times" with "4" (range: 1-10), "Data Size" with "64" (range: 1-1500 bytes), and "Interval" with "1000" (range: 100-1000 milliseconds). A blue "Ping" button is located to the right of the fields. Below the fields is a light blue bar labeled "Ping Result".

Follow these steps to test the connectivity between the switch and another device in the network:

- 1) In the **Ping Config** section, enter the IP address of the destination device for Ping test, set Ping times, data size and interval according to your needs, and then click **Ping** to start the test.

Destination IP	Enter the IP address of the destination node for Ping testing. Both IPv4 and IPv6 are supported.
Ping Times	Enter the number of times test data will be sent for Ping testing. It is recommended to use the default value of 4.
Data Size	Enter the size of the data sent for Ping testing. It is recommended to keep the default value of 64 bytes.

Interval	Specify the interval at which ICMP request packets are sent. We recommend keeping the default value of 1000 milliseconds.
-----------------	---

- 2) In the **Ping Result** section, check the test results.

2.1.2 Troubleshooting with Tracert Testing

You can use the Tracert tool to find the path from the switch to the destination, and test connectivity between the switch and routers along the path.

Choose the menu **MAINTENANCE > Network Diagnostics > Tracert** to load the following page.

Figure 2-1 Troubleshooting with Tracert Testing

The screenshot shows a web interface for Tracert testing. It has a title 'Tracert Config' and a light blue header bar. Below the header, there are two input fields: 'Destination IP:' with the value '192.168.0.100' and a format hint '(Format: 192.168.0.1 or 2001::1)'; and 'Maximum Hops:' with the value '4' and a hint 'hops (1-30)'. To the right of these fields is a blue 'Tracert' button. Below the input fields is a light blue bar labeled 'Tracert Result'.

Follow these steps to test connectivity between the switch and routers along the path from the source to the destination:

- 1) In the **Tracert Config** section, enter the IP address of the destination, set the max hop, and then click **Tracert** to start the test.

Destination IP	Enter the IP address of the destination device. Both IPv4 and IPv6 are supported.
Maximum Hops	Specify the maximum number of the route hops the test data can pass through.

- 2) In the **Tracert Result** section, check the test results.

2.2 Using the CLI

2.2.1 Configuring the Ping Test

On privileged EXEC mode, you can use the following command to test the connectivity between the switch and one node of the network.

```
ping [ ip | ipv6 ] { ip_addr } [ -n count ] [ -l size ] [ -i interval ]
```

Test the connectivity between the switch and destination device.

ip: The type of the IP address for ping test should be IPv4.

ipv6: The type of the IP address for ping test should be IPv6.

ip_addr: The IP address of the destination node for ping test. If the parameter ip/ipv6 is not selected, both IPv4 and IPv6 addresses are supported, such as 192.168.0.100 or fe80::1234.

count: Specify the amount of times to send test data for Ping testing. The values are from 1 to 10 times; the default is 4 times.

size: Specify the size of the sending data for ping testing. The values are from 1 to 1500 bytes; the default is 64 bytes.

interval: Specify the interval to send ICMP request packets. The values are from 100 to 1000 milliseconds; the default is 1000 milliseconds.

The following example shows how to test the connectivity between the switch and the destination device with the IP address 192.168.0.10. Specify the ping times as 3, the data size as 1000 bytes and the interval as 500 milliseconds:

```
Switch#ping ip 192.168.0.10 -n 3 -l 1000 -i 500
```

```
Pinging 192.168.0.10 with 1000 bytes of data :
```

```
Reply from 192.168.0.10 : bytes=1000 time<16ms TTL=64
```

```
Reply from 192.168.0.10 : bytes=1000 time<16ms TTL=64
```

```
Reply from 192.168.0.10 : bytes=1000 time<16ms TTL=64
```

```
Ping statistics for 192.168.0.10:
```

```
Packets: Sent = 3 , Received = 3 , Lost = 0 (0% loss)
```

```
Approximate round trip times in milli-seconds:
```

```
Minimum = 0ms , Maximum = 0ms , Average = 0ms
```

2.2.2 Configuring the Tracert Test

On privileged EXEC mode, you can use the following command to test the connectivity between the switch and routers along the path from the source to the destination:

```
tracert [ ip | ipv6 ] ip_addr [ maxHops ]
```

Test the connectivity of the gateways along the path from the source to the destination.

ip: The type of the IP address for tracert test should be IPv4.

ipv6: The type of the IP address for tracert test should be IPv6.

ip_addr: Enter the IP address of the destination device. If the parameter ip/ipv6 is not selected, both IPv4 and IPv6 addresses are supported, such as 192.168.0.100 or fe80::1234.

maxHops: Specify the maximum number of the route hops the test data can pass through. The range is 1 to 30 hops; the default is 4 hops.

The following example shows how to test the connectivity between the switch and the network device with the IP address 192.168.0.100. Set the maxhops as 2:

```
Switch#tracert 192.168.0.100 2
```

```
Tracing route to 192.168.0.100 over a maximum of 2 hops
```

```
 1    8 ms   1 ms   2 ms   192.168.1.1
 2    2 ms   2 ms   2 ms   192.168.0.100
```

```
Trace complete.
```

3 Appendix: Default Parameters

Default settings of Network Diagnostics are listed in the following tables.

Table 3-1 Default Settings of Ping Config

Parameter	Default Setting
Destination IP	192.168.0.1
Ping Times	4
Data Size	64 bytes
Interval	1000 milliseconds

Table 3-2 Default Settings of Tracert Config

Parameter	Default Setting
Destination IP	192.168.0.100
Maximum Hops	4 hops

Part 42

Configuring System Logs

CHAPTERS

1. Overview
2. System Logs Configurations
3. Configuration Example
4. Appendix: Default Parameters

1 Overview

The switch generates messages in response to events, faults, or errors occurred, as well as changes in configuration or other occurrences. You can check system messages for debugging and network management.

System logs can be saved in various destinations, such as the log buffer, log file or remote log servers, depending on your configuration. Logs saved in the log buffer and log file are called local logs, and logs saved in remote log servers are called remote logs. Remote logs facilitate you to remotely monitor the running status of the network.

You can set the severity level of the log messages to control the type of log messages saved in each destination.

2 System Logs Configurations

System logs configurations include:

- Configure the local logs.
- Configure the remote logs.
- Backing up the logs.
- Viewing the log table.

Configuration Guidelines

Logs are classified into the following eight levels. Messages of levels 0 to 4 mean the functionality of the switch is affected. Please take actions according to the log message.

Table 2-1 Levels of Logs

Severity	Level	Description	Example
Emergencies	0	The system is unusable and you have to reboot the switch.	Software malfunctions affect the functionality of the switch.
Alerts	1	Actions must be taken immediately.	The memory utilization reaches the limit.
Critical	2	Cause analysis or actions must be taken immediately.	The memory utilization reaches the warning threshold.
Errors	3	Error operations or unusual processing that will not affect subsequent operations but that should be noted and analyzed.	Wrong command or password is entered.
Warnings	4	Conditions that may cause process failure and that should be noted.	Error protocol packets are detected.
Notifications	5	Normal but significant conditions.	The shutdown command is applied to a port.
Informational	6	Normal messages for your information.	The display command is used.
Debugging	7	Debug-level messages that you can ignore.	General operational information.

2.1 Using the GUI

2.1.1 Configuring the Local Logs

Choose the menu **MAINTENANCE > Logs > Local Logs** to load the following page.

Figure 2-1 Configuring the Local Logs

Local Logs Config				
<input type="checkbox"/>	Channel	Severity	Status	Sync-Period
<input type="checkbox"/>	Log Buffer	level_6	Enable	Immediately
<input type="checkbox"/>	Log File	level_3	Disable	24hour(s)
Total: 2				

Follow these steps to configure the local logs:

- 1) Select your desired channel and configure the corresponding severity and status.

Channel	Local logs includes 2 channels: log buffer and log file. Log buffer: Log buffer indicates the RAM for saving system logs. The channel is enabled by default. Information in the log buffer is displayed on the MAINTENANCE > Logs > Logs Table page. It will be lost when the switch is restarted. Log file: Log file indicates the flash sector for saving system logs. Information in the log file will not be lost after the switch is restarted and can be exported on the MAINTENANCE > Logs > Back Up Logs page.
Severity	Specify the severity level of the log messages that are saved to the selected channel. Only log messages with a severity level value that is the same or lower than this will be saved. There are eight severity levels marked from 0 to 7. A lower value indicates a higher severity.
Status	Enable or disable the channel.
Sync-Periodic	By default, the log information is saved in the log buffer immediately, and synchronized to the log file every 24 hours. If necessary, you can modify the log synchronization frequency using the CLI.

- 2) Click **Apply**.

 **Note:**

- A smaller value for the severity level means a higher priority.

2.1.2 Configuring the Remote Logs

You can configure up to four hosts to receive the switch's system logs. These hosts are called Log Servers. The switch will forward the log message to the servers once a log

message is generated. To display the logs, the servers should run a log server software that complies with the syslog standard.

Choose the menu **MAINTENANCE > Logs > Remote Logs** to load the following page.

Figure 2-2 Configuring the Remote Logs

Log Server Config						
<input type="checkbox"/>	Index	Server IP	UDP Port	Severity	Status	
<input type="checkbox"/>	1	0.0.0.0	514	level_6	Disable	
<input type="checkbox"/>	2	0.0.0.0	514	level_6	Disable	
<input type="checkbox"/>	3	0.0.0.0	514	level_6	Disable	
<input type="checkbox"/>	4	0.0.0.0	514	level_6	Disable	
Total: 4						

Follow these steps to configure the information of remote log servers:

1) Select an entry to enable the server, and then set the server IP address and severity.

Server IP	Enter the IP address of the log server.
UDP Port	Displays the UDP port used by the server to receive the log messages. The switch uses standard port 514 to send log messages.
Severity	Specify the severity level of the log messages sent to the selected log server. Only log messages with a severity level value that is the same or lower than this will be saved.
Status	Enable or disable the log server.

2) Click **Apply**.

 **Note:**

- A smaller value for the severity level means a higher priority.

2.1.3 Backing up the Logs

Choose the menu **MAINTENANCE > Logs > Back Up Logs** to load the following page.

Figure 2-3 Backing up the Log File

Back Up Logs

Click this button to back up the log file.

[Back Up Logs](#)

Click **Back Up Logs** to save the system logs as a file on your computer. If the switch system breaks down, you can check the file for troubleshooting.

2.1.4 Viewing the Log Table

Choose the menu **MAINTENANCE > Logs > Log Table** to load the following page.

Figure 2-4 View the Log Table

Log Info				
Index	Time	Module	Severity	Content
		All Modules ▼	All Levels ▼	
1	2006-01-01 11:08:58	Port	level_6	Modify monitor session 1, config port Gi1/0/1 as destination port.
2	2006-01-01 10:58:11	User	level_5	Login the web by admin on web(192.168.0.101).
3	2006-01-01 08:57:49	User	level_5	Logout the web by admin on web(192.168.0.101).
4	2006-01-01 08:52:29	DHCP6F	level_6	Enable DHCP6 Filter on Te1/0/54.
5	2006-01-01 08:52:29	DHCP6F	level_6	Enable DHCP6 Filter on Te1/0/53.
6	2006-01-01 08:52:29	DHCP6F	level_6	Enable DHCP6 Filter on Te1/0/52.
7	2006-01-01 08:52:29	DHCP6F	level_6	Enable DHCP6 Filter on Te1/0/51.
8	2006-01-01 08:52:29	DHCP6F	level_6	Enable DHCP6 Filter on Te1/0/50.
9	2006-01-01 08:52:29	DHCP6F	level_6	Enable DHCP6 Filter on Te1/0/49.
10	2006-01-01 08:52:29	DHCP6F	level_6	Enable DHCP6 Filter on Gi1/0/48.
Total: 232				

Select a module and a severity to view the corresponding log information.

Time	Displays the time the log event occurred. To get the exact time the log event occurred, you need to configure the system time on the SYSTEM > System Info > System Time Web management page.
Module	Select a module from the drop-down list to display the corresponding log information.
Severity	Select a severity level to display logs that have a severity level that is the same value or lower.
Content	Displays the detailed information of the log event.

2.2 Using the CLI

2.2.1 Configuring the Local Logs

Follow these steps to configure the local logs:

- Step 1 **configure**
Enter global configuration mode.

Step 2	logging buffer Configure the switch to save system messages in log buffer. Log buffer indicates the RAM for saving system logs. Information in the log buffer will be lost when the switch is restarted. You can view the logs with show logging buffer command.
Step 3	logging buffer level level Specify the severity level of the log information that should be saved to the buffer. <i>level</i> : Enter the severity level ranging from 0 to 7. A lower value indicates a higher severity. Only log messages with a severity level value that is the same or lower than this will be saved. The default level is 6, indicating that the log information of levels 0 to 6 will be saved in the log buffer.
Step 4	logging file flash Configure the switch to save system messages in log file. Log file indicates the flash sector for saving system logs. Information in the log file will not be lost after the switch is restarted. You can view the logs with show logging flash command.
Step 5	logging file flash frequency { periodic periodic immediate } Specify the frequency to synchronize the system logs in the log buffer to the flash. <i>periodic</i> : Specify the frequency ranging from 1 to 48 hours. By default, the synchronization process takes place every 24 hours. <i>immediate</i> : The system log file in the buffer will be synchronized to the flash immediately. This option means frequent operations on the flash and is not recommended.
Step 6	logging file flash level level Specify the severity level of the log information that should be saved to the flash. <i>level</i> : Enter the severity level ranging from 0 to 7. A lower value indicates a higher severity. Only log messages with a severity level value that is the same or lower than this will be saved to the flash. The default level is 3, indicating that the log messages of levels 0 to 3 will be saved in the log flash.
Step 7	show logging local-config View the configuration information of the local logs.
Step 8	end Return to privileged EXEC mode.
Step 9	copy running-config startup-config Save the settings in the configuration file.

The following example shows how to configure the local logs on the switch. Save logs of levels 0 to 5 to the log buffer, and synchronize logs of levels 0 to 2 to the flash every 10 hours:

```
Switch#configure
```

```
Switch(config)#logging buffer
```

```
Switch(config)#logging buffer level 5
```

```
Switch(config)#logging file flash
```

```
Switch(config)#logging file flash frequency periodic 10
```

```
Switch(config)#logging file flash level 2
```

```
Switch(config)#show logging local-config
```

Channel	Level	Status	Sync-Periodic
-----	-----	-----	-----
Buffer	5	enable	Immediately
Flash	2	enable	10 hour(s)
Console	5	enable	Immediately
Monitor	5	enable	Immediately

```
Switch(config)#end
```

```
Switch#copy running-config startup-config
```

2.2.2 Configuring the Remote Logs

You can configure up to four hosts to receive the switch's system logs. These hosts are called Log Servers. The switch will forward the log message to the servers once a log message is generated. To display the logs, the servers should run a log server software that complies with the syslog standard.

Follow these steps to set the remote log:

Step 1 **configure**

Enter global configuration mode.

Step 2 **logging host index idx host-ip level**

Configure a remote host to receive the switch's system logs. The host is called Log Server. You can remotely monitor the settings and operation status of the switch through the log server.

idx: Enter the index of the log server. The switch supports 4 log servers at most.

host-ip: Enter the IP address of the log server.

level: Specify the severity level of the log messages sent to the log server. The range is from 0 to 7, and a lower value indicates a higher severity. Only log messages with a severity level value that is the same or lower than this will be sent. The default is 6, indicating that the log information of levels 0 to 6 will be sent to the log server.

Step 3 **show logging loghost [index]**

View the configuration information of the log server.

index: Enter the index of the log server to view the corresponding configuration information. If no value is specified, information of all log hosts will be displayed.

Step 4 **end**
Return to privileged EXEC mode.

Step 5 **copy running-config startup-config**
Save the settings in the configuration file.

The following example shows how to set the remote log on the switch. Enable log server 2, set its IP address as 192.168.0.148, and allow logs of levels 0 to 5 to be sent to the server:

Switch#configure

Switch(config)# logging host index 2 192.168.0.148 5

Switch(config)# show logging loghost

Index	Host-IP	Severity	Status
-----	-----	-----	-----
1	0.0.0.0	6	disable
2	192.168.0.148	5	enable
3	0.0.0.0	6	disable
4	0.0.0.0	6	disable

Switch(config)#end

Switch#copy running-config startup-config

3 Configuration Example

3.1 Network Requirements

The company network manager needs to monitor network of department A for troubleshooting.

Figure 3-1 Network Topology

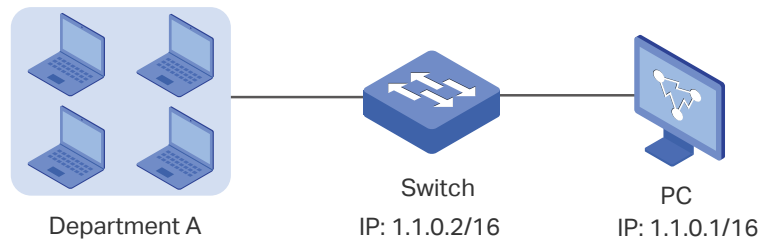

3.2 Configuration Scheme

The network manager can configure the PC as a log server to receive the switch’s system logs. Make sure the switch and the PC are reachable to each other; configure a log server that complies with the syslog standard on the PC and set the PC as the log server.

Demonstrated with SG6654XHP, this chapter provides configuration procedures in two ways: using the GUI and Using the CLI.

3.3 Using the GUI

- 1) Choose the menu **MAINTENANCE > Logs > Remote Logs** to load the following page. Enable host 1, and set the PC’s IP address 1.1.0.1 as the server IP address, and the severity as level_5; click **Apply**.

Figure 3-2 Configuring the Log Server

Log Server Config					
<input type="checkbox"/>	Index	Server IP	UDP Port	Severity	Status
<input checked="" type="checkbox"/>	1	1.1.0.1	514	level_6	Enable
<input type="checkbox"/>	2	0.0.0.0	514	level_6	Disable
<input type="checkbox"/>	3	0.0.0.0	514	level_6	Disable
<input type="checkbox"/>	4	0.0.0.0	514	level_6	Disable
Total: 4			1 entry selected.		<input type="button" value="Cancel"/> <input type="button" value="Apply"/>

- 2) Click  to save the settings.

3.4 Using the CLI

Configure the remote log host.

```
Switch#configure
```

```
Switch(config)# logging host index 1 1.1.0.1 5
```

```
Switch(config)#end
```

```
Switch#copy running-config startup-config
```

Verify the Configurations

```
Switch# show logging loghost
```

Index	Host-IP	Severity	Status
-----	-----	-----	-----
1	1.1.0.1	5	enable
2	0.0.0.0	6	disable
3	0.0.0.0	6	disable
4	0.0.0.0	6	disable

4 Appendix: Default Parameters

Default settings of maintenance are listed in the following tables.

Table 4-1 Default Settings of Local Logs

Parameter	Default Setting
Status of Log Buffer	Enabled
Severity of Log Buffer	Level_6
Sync-Periodic of Log Buffer	Immediately
Status of Log File	Disabled
Severity of Log File	Level_3
Sync-Periodic of Log File	24 hours

Table 4-2 Default Settings of Remote Logs

Parameter	Default Setting
Server IP	0.0.0.0
UDP Port	514
Severity	Level_6
Status	Disabled

COPYRIGHT & TRADEMARKS

Specifications are subject to change without notice.  tp-link is a registered trademark of TP-Link Corporation Limited. Other brands and product names are trademarks or registered trademarks of their respective holders.

No part of the specifications may be reproduced in any form or by any means or used to make any derivative such as translation, transformation, or adaptation without permission from TP-Link Corporation Limited. Copyright © 2020 TP-Link Corporation Limited. All rights reserved.

<https://www.tp-link.com>