



User's Manual

1. Usage Notice

2. Introduction

3. Basic Operations

4. User Settings

5. LAN Control

6. Troubleshooting

7. Appendices

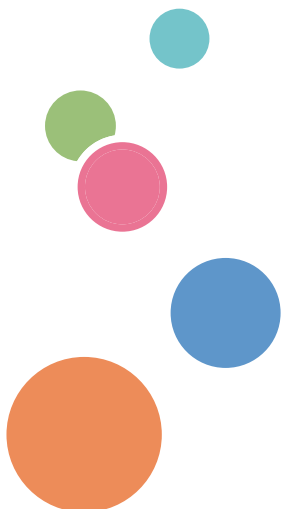

Read this manual carefully before you use this machine and keep it handy for future reference. For safe and correct use, be sure to read the Precautions in this manual before using the machine.



Table of Contents

Usage Notice	2	<i>AUDIO</i>	53
<i>Precautions</i>	2	<i>OPTIONS</i>	54
<i>Safety Labels of This Machine</i>	11	<i>3D</i>	58
<i>Regulation & Safety Notices</i>	13	LAN Control	60
<i>Other Information</i>	18	<i>Controlling this Device with Web</i>	
Introduction	19	<i>Browser</i>	60
<i>Product Features</i>	19	<i>Connecting to the device</i>	60
<i>Package Overview</i>	20	<i>Log in</i>	61
<i>Product Overview</i>	21	<i>System Status</i>	62
<i>Connection Ports</i>	22	<i>General Setup</i>	63
<i>Control Panel</i>	23	<i>Projector Control</i>	64
<i>Remote Control</i>	24	<i>Network Setup</i>	66
<i>Remote Control ID Setup</i>	26	<i>Alert Setup</i>	67
<i>Remote Control Battery Installation</i>	27	<i>Crestron</i>	68
<i>Remote Control Operating Range</i>	28	<i>Crestron Tools</i>	69
<i>Installing the Projector</i>	29	<i>Crestron Info</i>	69
Basic Operations	30	<i>Contacting the IT administrator of</i>	
<i>Connecting the Projector</i>	30	<i>Crestron</i>	70
<i>Connect to Computer/Notebook</i>	30	<i>Reset to Default</i>	70
<i>Connect to AV Equipment</i>	31	<i>Reboot System</i>	71
<i>Powering On/Off the Projector</i>	32	<i>License Information</i>	71
<i>Powering On the Projector</i>	32	<i>LAN FW Update</i>	72
<i>Powering Off the Projector</i>	33	Troubleshooting	73
<i>Warning Indicator</i>	33	Appendices	77
<i>Adjusting the Projected Image</i>	35	<i>List of Compatible Signals</i>	77
<i>Adjusting the Position of Projector</i>		<i>Configurations of Terminals</i>	81
<i>Image</i>	35	<i>Terminal: Computer In (Mini D-sub</i>	
<i>Adjusting the Projector Zoom, Focus,</i>		<i>15 pin) [Monitor Out]</i>	81
<i>and Lens Shift</i>	36	<i>Terminal: PC Control (D-sub 9 pin)</i>	81
<i>Adjusting Projection Image Size</i>	37	<i>Terminal: Microphone</i>	81
User Settings	39	<i>Specifications</i>	82
<i>Using the On Screen Display (OSD)</i> 39		<i>Cabinet Dimensions</i>	83
<i>How to operate</i>	39	<i>Copyrights</i>	85
<i>PICTURE</i>	40	<i>Trademarks</i>	85
<i>SCREEN</i>	44		
<i>SETTINGS</i>	49		

Usage Notice

Precautions



Follow all warnings, precautions and maintenance as recommended in this user's guide to maximize the life of your unit.

- Warning- **Indicates a potentially hazardous situation which, if instructions are not followed, could result in death or serious injury.**

- Caution- **Indicates a potentially hazardous situation which, if instructions are not followed, may result in minor or moderate injury or damage to property.**

- Warning- Do not use flammable sprays or solvents in the vicinity of this machine. Also, avoid placing these items in the vicinity of this machine. Doing so could result in fire or electric shock.
- Warning- Do not place vases, plant pots, cups, toiletries, medicines, small metal objects, or containers holding water or any other liquids, on or close to this machine. Fire or electric shock could result from spillage or if such objects or substances fall inside this machine
- Warning- Keep the machine and attachments out of the reach of children. If the machine is near children, it may cause injury.
- Warning- Plastic bags can be dangerous, please do not leave near babies and young children. To avoid the threat of suffocation, please keep away from their nose and mouth.
- Warning- Do not use any power sources other than those that match the specifications shown in this manual. Doing so could result in fire or electric shock.
- Warning- Do not damage, break, or modify the power cord. Also, do not place heavy objects on the power cord, or pull the cord or bend it severely. Doing so could result in fire or electric shock.
- Warning- Touching the prongs of the power cable's plug with anything metallic constitutes a fire and electric shock hazard.
- Warning- The supplied power cord is for use with this machine only. Do not use it with other appliances. Doing so could result in fire or electric shock.

Usage Notice

- Warning- It is dangerous to handle the power cord plug with wet hands. Doing so could result in electric shock.
- Warning- Be sure to disconnect the plug from the wall outlet at least once a year and check for the following:
 - There are burn marks on the plug.
 - The prongs on the plug are deformed.If any of the above conditions exist, do not use the plug and consult your dealer or service representative. Use of the plug could result in fire or electric shock.
- Warning- Be sure to disconnect the power cord from the wall outlet at least once a year and check for the following:
 - The power cord's inner wires are exposed, broken, etc.
 - The power cord's coating has a crack or dent.
 - When bending the power cord, the power turns off and on.
 - Part of the power cord becomes hot.
 - The power cord is damaged.If any of the above conditions exist, do not use the power cord and consult your dealer or service representative. Use of the power cord could result in fire or electric shock.
- Warning- Do not use the connection cable if it is deformed, cracked, or damaged. Doing so could result in fire or electric shock. If the connection cable is deformed, cracked, or damaged, contact your service representative to request a replacement cable.
- Warning- When using an extension cord or power strip, only connect equipment whose total power consumption is within the power rating for the extension cord or power strip. If the power rating is exceeded, it may cause heat buildup and result in fire.
- Warning- If the machine emits smoke or odours, or if it behaves unusually, you must turn off its power immediately. After turning off the power, be sure to disconnect the power cord plug from the wall outlet. Then contact your service representative and report the problem. Do not use the machine. Doing so could result in fire or electric shock.
- Warning- If metal objects, or water or other fluids fall inside this machine, you must turn off its power immediately. After turning off the power, be sure to disconnect the power cord plug from the wall outlet. Then contact

Usage Notice

- your service representative and report the problem. Do not use the machine. Doing so could result in fire or electric shock.
- Warning- Never operate this unit on AC power during a thunderstorm. If you see lightning or hear thunder, never touch the unit, cables and/or peripherals. An electric surge caused by the storm, may result in an electrical shock or damage to the unit.
 - Warning- If the machine topples, or if a cover or other part gets broken, you must turn off its power immediately. After turning off the power, be sure to disconnect the power cord plug from the wall outlet. Then contact your service representative and report the problem. Do not use the machine. Doing so could result in fire or electric shock.
 - Warning- Never push objects of any kind into this product through openings as they may touch dangerous voltage points or short-out parts that could result in a fire or electric shock. Never spill liquid of any kind on the product.
 - Warning- Do not remove any covers or screws. There are high voltage components inside the machine that may cause electric shock. Contact your service representative if any of the machine's internal components require maintenance, adjustment, or repair.
 - Warning- Do not disassemble or modify the machine. Doing so may cause injury or malfunction.
 - Warning- Installing the Projector on a Wall or Ceiling:
 - a) Do not attempt to clean or replace parts for a machine that is installed in a high location on a wall or ceiling. Doing so may cause it to fall down, resulting in an injury.
 - b) Contact your sales or service representative to clean or replace parts for a machine that is installed on a wall or ceiling.
 - c) If a machine is incorrectly installed on a wall or ceiling, it may fall down and cause an injury. Contact your sales or service representative if you want to install a machine on a wall or ceiling.
 - d) Do not obstruct the machine's vents. Doing so risks fire caused by overheated internal components.
 - e) For users, do not install the projector by yourself.

Usage Notice

Contact your sales or service representative if you want to install the projector on a wall or ceiling.

f) For sales or service representatives:

- Use brackets that are strong enough to support the projector. WXL5860/ WUL5860 Series weights less than 5.0 kg.

- The projector must be installed in a location that is sturdy enough to support the full weight of the projector and brackets.

- Use only the screws (M4 screws). Use all three of the projector's screw holes to attach the brackets.

g) Do not use the projector in oil-mist or smoke environment. Doing so may cause the projector case to crack and fall from its ceiling mount. This may cause serious injury.

- Warning- Do not use lens cap when projector is powered on.
- Caution- Keep the machine away from humidity and dust. Otherwise a fire or an electric shock might occur.
- Caution- Do not place any objects on the machine. Doing so may cause the machine to topple over, possibly resulting in injury.
- Caution- Do not place the machine on an unstable or tilted surface. If it topples over, an injury might occur.
- Caution- Do not place the machine or use it in an environment where it might get wet such as from snow, rain, or being near water. Doing so could result in fire or electric shock.
- Caution- Do not put your face or hand near the exhaust vents. Doing so could result in burns or an accident due to hot air coming from the exhaust vents.
- Caution- Do not use the machine on soft material such as paper or cloth that might get sucked into the intake vents. Doing so may cause heat buildup inside the machine, resulting in malfunction, burns, or fire.
- Caution- Do not place the machine in a location where air flow is poor. Doing so may cause fire due to internal components becoming overheated.
- Caution- Do not place or store the machine in a location where direct sunlight or heat generation might occur. The heat may deform or wear out the exterior parts or negatively affect internal parts. Doing so could result in fire.

Usage Notice

- Caution- Do not place low heat resistant material near the exhaust vents. Hot air may come from the exhaust vents, resulting in damage to the machine or an accident.
- Caution- Do not obstruct the machine's vents. Doing so risks fire caused by overheated internal components.
- Caution- Push the power plug all the way into the power outlet. Do not use a power outlet with a loose connection. Doing so may result in heat buildup. Plug the power cord in the correct direction into the base. If they are not plugged in correctly, it could result in smoke, fire, or electric shock.
- Caution- If this machine is not going to be used for several days or longer at a time, disconnect its power cord from the wall outlet.
- Caution- When disconnecting the power cord from the wall outlet, always pull the plug, not the cord. Pulling the cord can damage the power cord. Use of damaged power cords could result in fire or electric shock.
- Caution- Be sure to disconnect the plug from the wall outlet and clean the prongs and the area around the prongs at least once a year. Allowing dust to build up on the plug constitutes a fire hazard.
- Caution- When performing maintenance on the machine, always disconnect the power cord from the wall outlet.
- Caution- Do not place the power cord and connection cable in a way that might cause someone to trip and fall. The machine might fall over and cause an injury.
- Caution- The machine may be very hot after it is turned off, especially the vents.
- Caution- Do not place the machine on other equipment or vice versa. Doing so may cause heat buildup inside the machine or cause the other equipment to malfunction.
- Caution- Do not increase the volume unless you are listening while increasing the volume. Also, lower the volume before turning off the power, because a loud sound may be emitted when the power is turned on and cause hearing damage.
- Caution- If the machine's interior is not cleaned regularly, dust will accumulate. Fire and breakdown can result from heavy accumulation of dust inside this machine. Contact your sales or service representative for details about and charges for cleaning the machine's interior.

Usage Notice

- Caution- Unplug the power cord from the wall outlet before you move the machine. While moving the machine, take care that the power cord is not damaged under the machine. Failing to take these precautions could result in fire or electric shock.
- Caution- Do not use attachments not recommended by RICOH. Use of an incompatible attachments could cause hazards or damage to the product.
- Caution- Unplug this product from the wall outlet and take the product to qualified service personnel if you encounter any of the following conditions:
 - a) The power supply cord or plug is damaged.
 - b) Liquid has been spilled, or objects have fallen into the product.
 - c) The product has been exposed to rain or water.
 - d) The product does not operate normally when following the operating instructions. Adjust only those controls that are covered by the operating instructions.
 - e) The product has been dropped or damaged in any way. (If the cabinet should break, please handle with care to avoid injury.)
- Caution- This product incorporates glass components, including a lens. If this should break, please handle with care to avoid injury and contact your sales representative for repair service. Avoid any broken pieces of glass since they may cause injury.
- Caution- Do not place anything in front of the lens while the projector is operating. Things placed in front of the lens may overheat and burn or start a fire.
- Caution- Unauthorized substitutions may result in fire, electric shock, or other hazards.

Upon completion of any service or repairs to this product, ask the service technician to perform safety checks to verify that the product is in proper operating condition.
- Caution- Do not use the product in a closed installation location. Do not place the product in a box or in any other closed installation location. Otherwise it may overheat, which could result in a risk of fire.

Usage Notice

- Caution- Leave more than 30 cm of space between the intake vent and the partition or more than 60 cm of space between the exhaust vent and the partition.

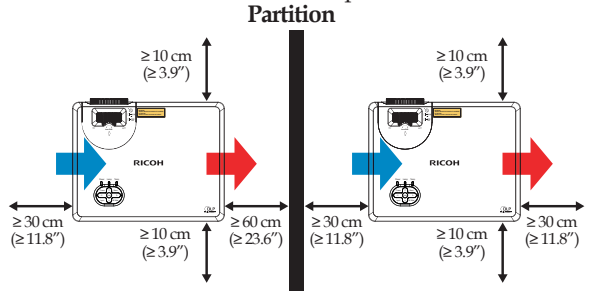

- Caution- For 360° installation, install the projector more than 10 cm away from the ceiling or the floor and more than 30 cm away from the wall on the left side or on the right side.

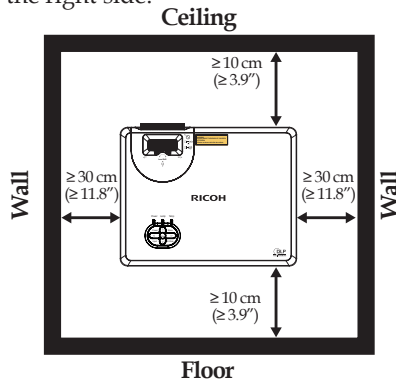

- Caution- When installing the projector on the right side (preferred) or left side, leave a space of at least 30 cm between the intake vent and the surface or 60 cm between the exhaust vent and the surface.

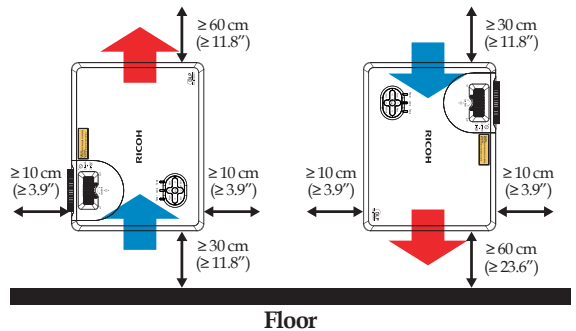

Usage Notice

ABOUT THE LASER LIGHT SOURCE

- Warning- Do not look into the lens or vent when the product is on. The bright light may damage your eyes. Be especially careful in an environment with children.
- Caution- Never allow children to stare into the projector beam at any distance from the projector.
- Caution- Do not start the projector by the remote controller while in front of the lens.
- Caution- Do not use optical aids such as binoculars or telescopes inside the beam.
- Caution- This projector has built-in laser module. Possibly hazardous optical radiation emitted from this product. Do not stare into the beam. May be harmful to the eyes.
- Caution- Use of controls or adjustments or performance of procedures other than those specified herein may result in hazardous radiation exposure.
- Caution- Do not block the projection light when it is on. If you do so, the part that is blocking the projection light may get quite hot and deform, deteriorate or cause a burn or fire. The reflected light may make the lens hot and cause a product failure. To temporarily suspend projection, select the mute function. To suspend longer, turn off the product.

REMOTE CONTROL BATTERY

Warning

- Never throw batteries into a fire.

Using the batteries improperly may cause them to explode or leak and may result in serious injury. If battery-leaking fluid contacts skin, wash the fluid off immediately with clean water and consult a doctor. If the fluid spills on an instrument, avoid contact and wipe it off using tissue paper. Then dispose of the used tissue paper as flammable garbage after moistening the tissue with water.

- Keep new and used batteries away from children.

If the battery compartment does not close securely, stop using the product and keep it away from children. If you think batteries might have been swallowed or placed inside any part of the body, seek immediate medical attention.

Notes

- Be sure to use AAA (R03) size batteries.
- Dispose of batteries in a designated disposal area.
- Attention should be drawn to the environmental aspects of battery disposal.
- If the remote control does not operate correctly, or if the operating range becomes reduced, replace the batteries.
- Avoid contact with water or liquid.
- Do not expose the remote control to moisture or heat.
- Do not drop the remote control.
- If the batteries have leaked in the remote control, carefully wipe the case clean and install new batteries.
- Dispose of used batteries according to the instructions.
- The remote control may fail to operate if the infrared remote sensor is exposed to bright sunlight or fluorescent lighting.

Important:

Contents of this manual are subject to change without prior notice. In no event will the company be liable for direct, indirect, special, incidental, or consequential damages as a result of handling or operating this product.

Safety Labels of This Machine

1. Do not look into the lens while the light source is on. The strong light from the light source may cause damage to your eyesight.
2. Do not place anything in front of the lens while the projector is operating. Things placed in front of the lens may overheat and burn or start a fire. If you want to temporarily stop the projected image, use the AV mute on the remote control or the keypad.
3. Laser aperture warning:
 - CLASS 1 LASER PRODUCT - RISK GROUP 2
 - Do not stare into the beam, maybe harmful to the eyes.
 - Do not look into the light source light using optical instruments (such as magnifying glasses and mirrors). Visual impairment could result.
 - When turning on the projector, make sure no one within projection range is looking at the lens.

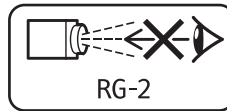

- Keep any items (magnifying glass etc.) out of the light path of the projector. The light path being projected from the lens is extensive, therefore any kind of abnormal objects that can redirect light coming out of the lens, can cause an unpredictable outcome such as a fire or injury to the eyes.
4. Do not remove any screws. Do not block or cover the vents.
 5. WARNING: MOUNT ABOVE THE HEADS OF CHILDREN. (For USA and Canada only)
The use of a ceiling mount is recommended with this product to place it above the eyes of children.

Usage Notice

3



CLASS 1 LASER PRODUCT- IEC/EN 60825-1:2014.
RISK GROUP 2: Possibly hazardous optical radiation emitted from this product. Do not stare into the beam. May be harmful to the eyes.
APPAREIL A LASER DE CLASSE 1 - IEC/EN 60825-1:2014.
RISQUES DE GROUPE 2: LE PRODUIT PEUT ÉMETTRE DES RADIATIONS OPTIQUES DANGEREUSES, NE PAS RESTER DANS LA TRAJECTOIRE DU FAISCEAU, PEUT ÊTRE DANGEREUX POUR LES YEUX.

一类激光产品 - IEC/EN 60825-1:2014
 风险组别2: 本产品可能发射有害的光辐射
 勿直视光束, 可能引起眼睛伤害
 等級1雷射產品 - IEC/EN 60825-1:2014
 風險組別2: 本產品可能發射有害的光輻射勿直視光束, 可能對眼睛有害
 クラス1レーザー製品 - IEC/EN 60825-1:2014
 リスクグループ2: この製品から出力される光は使用状況によっては強力な光となり、眼に影響を及ぼすおそれがありますので光線を直接見しないでください。

Complies with 21 CFR 1040.10 and 1040.11 except for conformance as a Risk Group 2 LP as defined in IEC 62471-5:Ed. 1.0. For more information see Laser Notice No. 57, dated May 8, 2019.

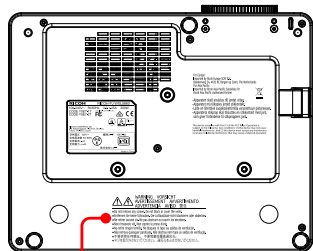

4

WARNING VORSICHT
AVERTISSEMENT ATTENTION
AVVERTENZA AVISO

- Do not remove any screws. Do not block or cover the vents.
- N'ôtez pas les vis. Ne bloquez ni couvrez pas les orifices.
- No retirar tornillos. No los bloques ni tape los salidas de ventilación.
- Não remova parafusos. Não obstrua nem tape as saídas de ventilação.
- 不要螺丝拆卸, 不要堵塞或遮盖通风口。
- 不要取除ネジをしないでください。通気口をふさぎしないでください。

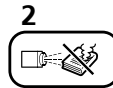
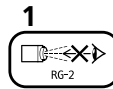

5 For USA and Canada only

WARNING:
MOUNT ABOVE THE HEADS OF CHILDREN.
ATTENTION:
Montez au-dessus de la tête des enfants.

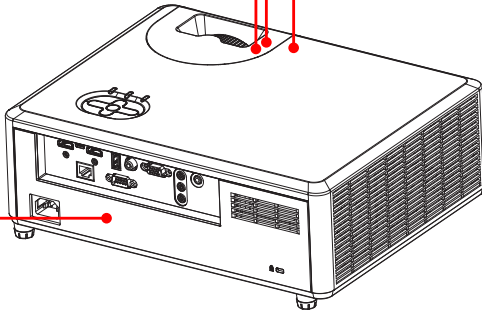

Power Switch Symbols

The meaning of the symbols for the switches on this machine as follows:

On/Standby (Off)

Usage Notice

Regulation & Safety Notices

This appendix lists the general notices of your Projector.

Notice: Users in the United States of America **FCC notice**

MODEL NAME: RICOH PJ WXL5860/WUL5860

TRADE NAME: PROJECTOR MODEL NAME: RICOH PJ WXL5860/WUL5860 Tested To Comply With FCC Standards FOR HOME OR OFFICE USE

This device complies with Part 15 of the FCC Rules. Operation is subject to the following two conditions:

1. This device may not cause harmful interference and
2. This device must accept any interference received, including interference that may cause undesired operation.

This device has been tested and found to comply with the limits for a Class B digital device pursuant to Part 15 of the FCC rules. These limits are designed to provide reasonable protection against harmful interference in a residential installation. This device generates, uses and can radiate radio frequency energy and, if not installed and used in accordance with the instructions, may cause harmful interference to radio communications.

However, there is no guarantee that interference will not occur in a particular installation. If this device does cause harmful interference to radio or television reception, which can be determined by turning the device off and on, the user is encouraged to try to correct the interference by one or more of the following measures:

- Reorient or relocate the receiving antenna.
 - Increase the separation between the device and receiver.
 - Connect the device into an outlet on a circuit different from that to which the receiver is connected.
 - Consult the dealer or an experienced radio/television technician for help.
- **Caution-** Changes or modifications not expressly approved by the party responsible for compliance could void the user's authority to operate the equipment.

Usage Notice

RESPONSIBLE PARTY: PFU America, Inc.
350 Cobalt Way, Sunnyvale, California, 94085, USA
Telephone number: (408)992-2900

Notice: Shielded cables

All connections to other computing devices must be made using shielded cables to maintain compliance with FCC regulations.

Caution

Changes or modifications not expressly approved by the manufacturer could void the user's authority, which is granted by the Federal Communications Commission, to operate this projector.

Notes to Users in the State of California

Perchlorate Material - special handling may apply, See www.dtsc.ca.gov/hazardouswaste/perchlorate.

Usage Notice

Declaration of Conformity for EU countries

- EMC Directive 2014/30/EU (including amendments)
- Low Voltage Directive 2014/35/EU

Notice: Users in EU countries

CE Marking Traceability Information (For EU Countries Only)

Manufacturer:

Ricoh Co., Ltd.

3-6 Nakamagome 1-chome, Ohta-ku, Tokyo. 143-8555,
Japan

Importer:

PFU (EMEA) LIMITED Viale Monza 259, 20126 Milano (MI)
Italy

Notice: Users in UK

UKCA Marking Traceability Information (For UK Only)

Manufacturer:

Ricoh Co., Ltd.

3-6 Nakamagome 1-chome, Ohta-ku, Tokyo. 143-8555,
Japan

Importer:

PFU (EMEA) LIMITED Belmont, Belmont Road, Uxbridge
UB8 1HE England

User Information on Electrical and Electronic Equipment

Users in the countries where this symbol shown in this section has been specified in national law on collection and treatment of E-waste.

Usage Notice

Our Products contain high quality components and are designed to facilitate recycling.

Our products or product packaging are marked with the symbol below.



This product contains substances which are harmful to humans and the environment.

The symbol indicates that the product must not be treated as municipal waste. It must be disposed of separately via the appropriate return and collection systems available. By following these instructions you ensure that this product is treated correctly and help to reduce potential impacts on the environment and human health, which could otherwise result from inappropriate handling. Recycling of products helps to conserve natural resources and protect the environment.

For more detailed information on collection and recycling systems for this product, please contact the shop where you purchased it, your local dealer or sales/service representatives.

Notice: Users in Turkey

AEEE Yönetmeliğine Uygundur.

Bu sistem sarf malzemeleri ve yedek parçaları da dahil olmak üzere AEEE Yönetmeliğine Uygundur.

All Other Users

If you wish to discard this product, please contact your local authorities, the shop where you bought this product, your local dealer or sales/service representatives.

Laser Notice

IEC 60825-1:2014: CLASS 1 LASER PRODUCT - RISK GROUP 2.

The product's intended use as a consumer laser product and compliant with EN 50689:2021.

CLASS 1 CONSUMER LASER PRODUCT
EN 50689:2021

Usage Notice

Notice: Users in the EU

Note for the Battery and/or Accumulator Symbol



In accordance with the Battery Directive 2006/66/EC Article 20 Information for end-users Annex II, the above symbol is printed on batteries and accumulators. This symbol means that in the European Union, used batteries and accumulators should be disposed of separately from your household waste. In the EU, there are separate collection systems for not only used electrical and electronic products but also batteries and accumulators. Please dispose of them correctly at your local community waste collection/recycling centre.

COMMISSION REGULATION (EU) 2019/2020

The light source of this product is not intended for applications other than image projection.

Other Information

Copyrights to Images

When projecting images using the projector, be careful not to infringe the copyright of protected materials. The following are examples that may infringe the copyright of protected materials.

- Broadcasting images or movies for commercial purposes
- Modifying images or movies using functions such as freeze, magnify, or zoom to broadcast images for commercial purposes or public viewing
- Varying the aspect ratio of images or movies using a function that changes the screen size to broadcast images for commercial purposes or public viewing

Note to Users Viewing 3D Images

Pay attention to the following points when viewing images using 3D glasses with projector:

- How 3D images are viewed may vary according to the individual.
- Do not use 3D glasses for viewing any material other than 3D images.
- Before viewing 3D images, make sure to read the manuals provided with your 3D glasses and 3D compatible content.
- Avoid viewing 3D images for a long period of time. Take a break of 15 minutes or longer after every hour of viewing.
- If you feel sick while viewing 3D images, stop viewing them. If you continue to feel sick, consult a doctor.
- When viewing 3D image in a room where on LED lighting system or fluorescent lights are used, you may feel that the light in the room flickers. If this is the case, dim the lights until you do not notice any flickers, or turn off the lights.
- If you or any member of your family has a history of light-sensitive seizures, consult a doctor before viewing 3D images.

Product Features

Outstanding features include:

- Native resolution WXGA (1280x800), WUXGA (1920x1200)
- Maximum resolution HDMI 1920x1200 @ 60Hz
- Light weight 11.02 lbs (5 kg)
- Manual focus projection 1:1.36 (WXL5860) or 1:1.3 (WUL5860) zoom lens
- Built-in full screen NTSC / PAL / SECAM video capability with S-video / Composite / component through D-sub terminals
- WUXGA / 1080P / UXGA / WXGA / Quad VGA / SXGA+ / SXGA / XGA / SVGA / VGA / MAC compatibility
- User friendly multilingual on screen display
- Automatic image resizing to WXGA (1280x800), WUXGA (1920x1200) full screen
- The projector supports 360 degree free orientation operation (refer to page 29)

Introduction

Package Overview

This projector comes with all the items shown below. Check to make sure your unit is complete. Contact your dealer immediately if anything is missing.

Note

❖ Due to the difference in applications for each country, some regions may have different accessories.

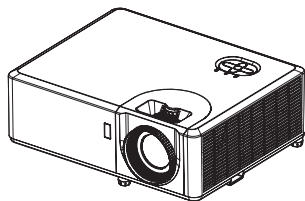

Projector

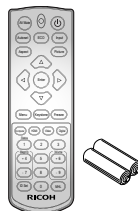

Remote Control
(with Batteries,
please see page
27)

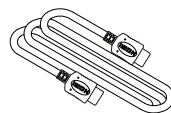

HDMI Cable

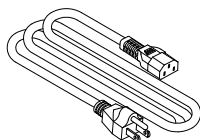

Power Cord

*Models for Europe are packed with two different codes, one for EU and one for UK.

Documentation:

Read This First

Product Overview

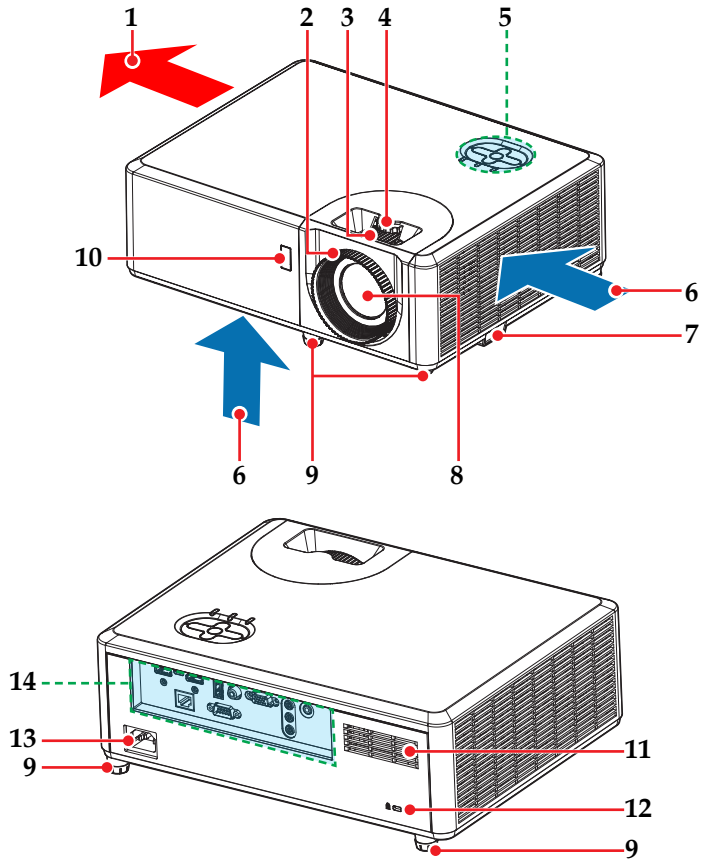

- | | |
|-------------------------|--|
| 1. Ventilation (outlet) | 9. Adjustable feet |
| 2. Focus ring | 10. Remote receiver |
| 3. Zoom lever | 11. Speaker |
| 4. Lens shift dial | 12. Anti-theft lock hole
(Kensington™ lock) |
| 5. Control panel | 13. AC In socket |
| 6. Ventilation (inlet) | 14. Connection ports |
| 7. Security bar | |
| 8. Lens | |

Introduction

Connection Ports

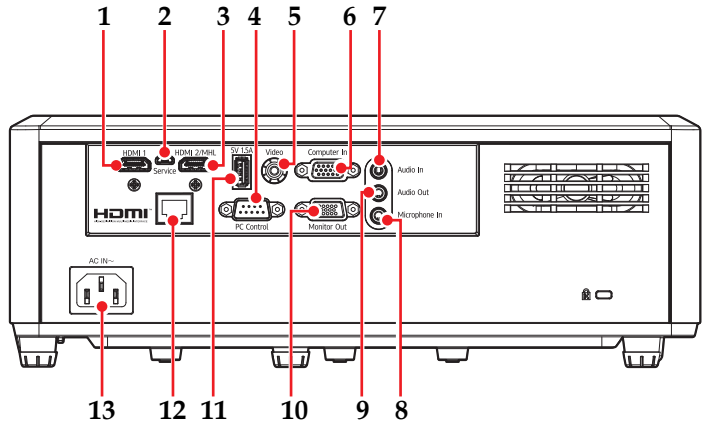

Note

❖ Compatible with MHL version 2.0, the charging current 5V@0.9A.

- | | |
|---|---------------------------|
| 1. HDMI 1 In terminal | 7. Audio In terminal |
| 2. Service terminal | 8. Microphone In terminal |
| 3. HDMI 2/MHL terminal (supports HDMI / MHL dongle) | 9. Audio Out terminal |
| 4. PC Control terminal | 10. Monitor Out terminal |
| 5. Video terminal | 11. 5V/1.5A terminal |
| 6. Computer In terminal | 12. LAN terminal |
| | 13. AC In socket |

Introduction

Control Panel

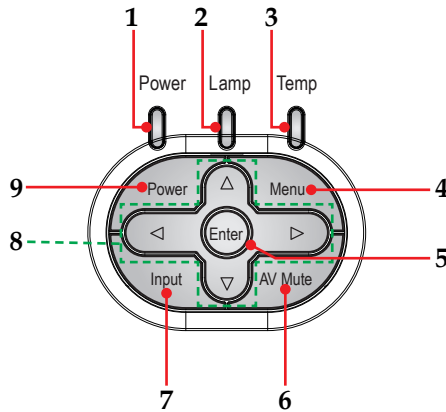

1	Power indicator	Indicate the projector's power status.
2	Lamp indicator	Indicate the projector's laser status.
3	Temp indicator	Indicate the inside of the projector's temperature status.
4	Menu	Press "Menu" to launch the on screen display (OSD), or go back to the previous menu. (See page 39)
5	Enter	Select or confirm settings.
6	AV Mute	Momentarily turn off/on the audio and video.
7	Input	Select an input source.
8	Four Directional Select Keys	Use ▲, ▼, ◀, or ▶ to select items or make adjustments to your selection.
9	Power	Refer to the "Power On/Off the Projector" section. (pages 32~33)

Remote Control

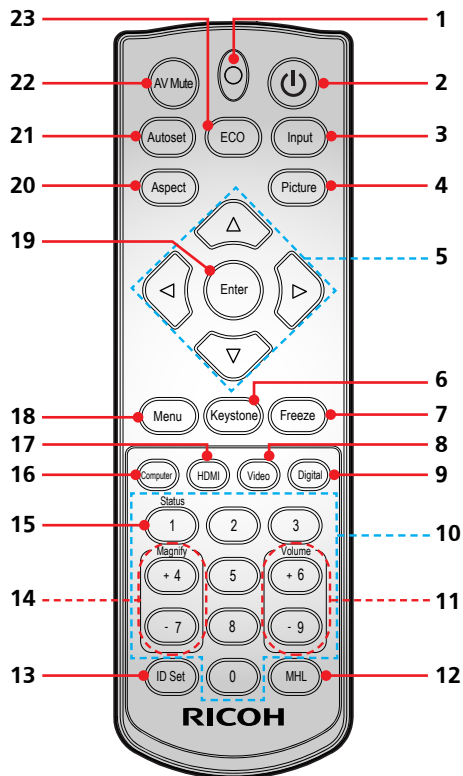

1	Indicator	Blinks when remote code is sent.
2	Power	Refer to the "Power On/Off the Projector" section. (See pages 32~33)
3	Input	Press "Input" to choose your desired input source.
4	Picture	Select the preset picture mode.
5	Four Directional Select Keys	Use ▲, ▼, ◀, or ▶ to select items or make adjustments to your selection.
6	Keystone	Display menu "Keystone".

Introduction

7	Freeze	Pause the screen image. Press again to resume the screen image.
8	Video	Choose a signal from Video terminal.
9	Digital	This function is not supported.
10	Number (0~9)	Input numbers.
11	Volume +/-	Increase or decrease speaker volume.
12	MHL	Press "MHL" to control your MHL device.
13	ID Set	Change ID setting of remote control. (See page 26)
14	Magnify +/-	Zoom in/out the projector display. Magnified area can be moved after pressing [Enter] key. (See page 47)
15	Status	Display menu "Information".
16	Computer	Choose a signal from Computer In terminal.
17	HDMI	Choose a signal from HDMI1/HDMI2 terminal.
18	Menu	Press "Menu" to launch the On Screen Display (OSD), back to the top level of OSD for the OSD main menu operation. (See page 39)
19	Enter	Confirm your section of items in sub menu operation.
20	Aspect	Use this function to choose your desired aspect ratio.
21	Autoset	Automatically synchronize the projector to the input source.
22	AV Mute	Momentarily turn off/on the audio and video.
23	ECO	Display menu "Laser Power Mode".

Remote Control ID Setup

The IR remote allows individual addressing of projectors. The projector can be set with a specific number from “1” to “99” as its address, and it only responds to the IR remote set to the same ID code. ID code “0” is the default value of the IR remote, and all projectors will respond to the IR remote set to “0”.

Follow below methods to set up the IR remote:

ID Code	Change Method
1	Press “ID Set” for 3 seconds, and press “0” then “1” within 2 seconds.
2	Press “ID Set” for 3 seconds, and press “0” then “2” within 2 seconds.
3	Press “ID Set” for 3 seconds, and press “0” then “3” within 2 seconds.
...	...
10	Press “ID Set” for 3 seconds, and press “1” then “0” within 2 seconds.
11	Press “ID Set” for 3 seconds, and press “1” then “1” within 2 seconds.
...	...
98	Press “ID Set” for 3 seconds, and press “9” then “8” within 2 seconds.
99	Press “ID Set” for 3 seconds, and press “9” then “9” within 2 seconds.

To have the IR remote return to default state where all projectors can be controlled, press “ID Set” for “3” seconds, and press “0” twice within 2 seconds.

Remote Control Battery Installation

- 1 Push the clip to release the battery cover.
- 2 Install new batteries (AAA/R03). Ensure that you have the batteries' polarity (+/-) aligned correctly.
- 3 Close the battery cover and press it down until it clicks into place. Do not mix different types of batteries or new and old batteries.

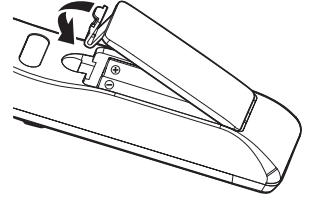
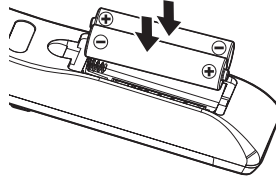
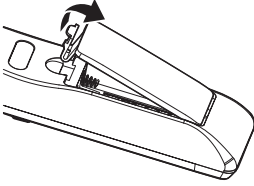

To ensure safe operation, please observe the following precautions :

- Use AAA/R03 type battery.
- Avoid contact with water or liquid.
- Do not expose the remote control to moisture or heat.
- Do not drop the remote control.
- If the battery has leaked in the remote control, carefully wipe the case clean and install new battery.
- Risk of an explosion if battery is replaced by an incorrect type.
- Dispose of used battery according to the instructions.
- Remove batteries from remote control when not using for extended periods.
- The remote control may fail to operate if the infrared remote sensor is exposed to bright sunlight or fluorescent lighting.

Introduction

Remote Control Operating Range

Point the remote control toward the projector (Remote Receiver) when pressing any button.

Maximum operating range for the remote control is about 7m (23.0feet) and $\pm 30^\circ$ in front of the projector.

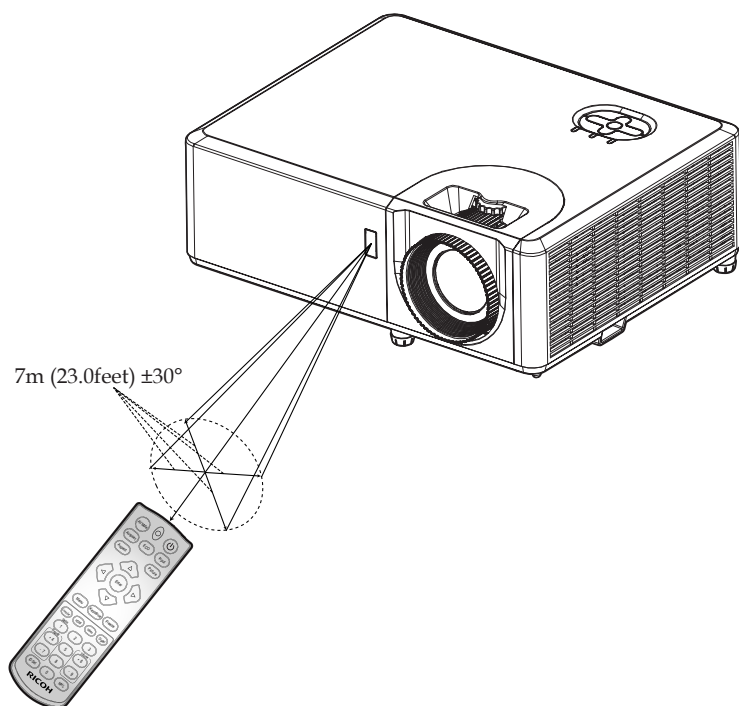

Installing the Projector

When you select a position for the projector, consider the size and shape of your screen, the location of your power outlets, and the distance between the projector and the rest of your equipment. Follow these general guidelines:

- ❖ Position the projector on a flat surface at a right angle to the screen.
- ❖ Position the projector to the desired distance from the screen. The distance from the lens of the projector to the screen, the zoom setting, and the video format determine the size of the projected image.
- ❖ 360 degree free orientation operation:

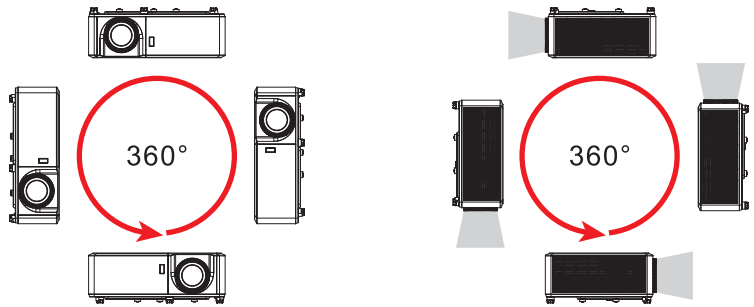

Basic Operations

Connecting the Projector

Connect to Computer/Notebook

Note

- ❖ Make sure that the power plug is fully inserted into both the projector AC inlet and the wall outlet.
 - ❖ The AC outlet must be near this equipment and must be easily accessible.
 - ❖ Due to the difference in applications for each country, some regions may have different accessories.
 - ❖ When HDMI input is selected, only audio signal with HDMI can be output.
 - ❖ When Audio Out is connected, Built-in speaker doesn't sound.
 - ❖ To ensure the projector works well with your computer, please make sure the timing of the display mode is compatible with your projector.
- (*) Use the cables that come with the projector. (*)

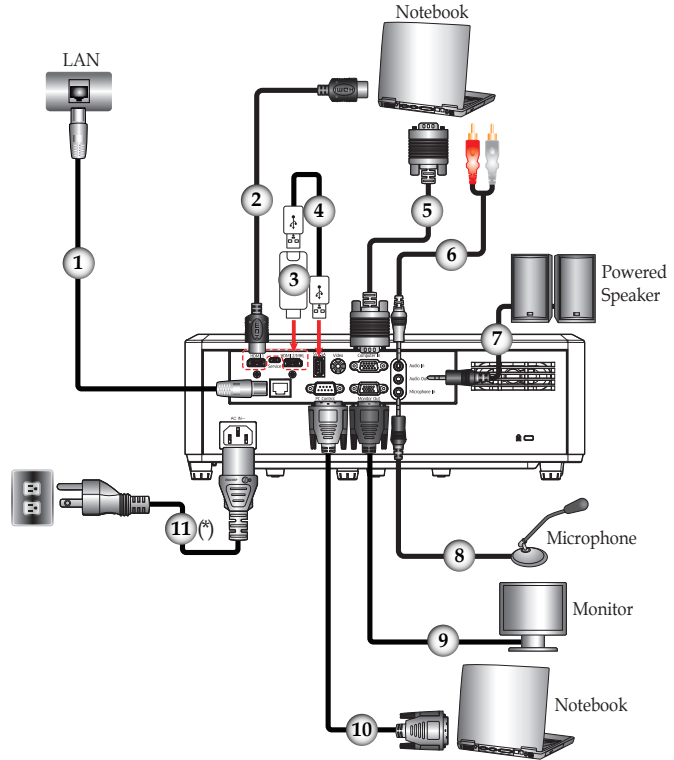

1.....LAN cable (Cat5 cable)	7..... Audio cable
2..... HDMI cable (supplied)	8.....Microphone cable
3..... HDMI dongle	9..... RGB cable
4.....USB cable	10..... RS-232 cable
5.....RGB cable	11.....Power cord (supplied)
6.....Audio cable	

Basic Operations

Connect to AV Equipment

Note

- ❖ Make sure that the power plug is fully inserted into both the projector AC inlet and the wall outlet.
 - ❖ The AC outlet must be near this equipment and must be easily accessible.
 - ❖ Due to the difference in applications for each country, some regions may have different accessories.
 - ❖ When HDMI input is selected, only audio signal with HDMI can be output.
 - ❖ When Audio Out is connected, Built-in speaker doesn't sound.
 - ❖ Use the cables that come with the projector.
- (*)

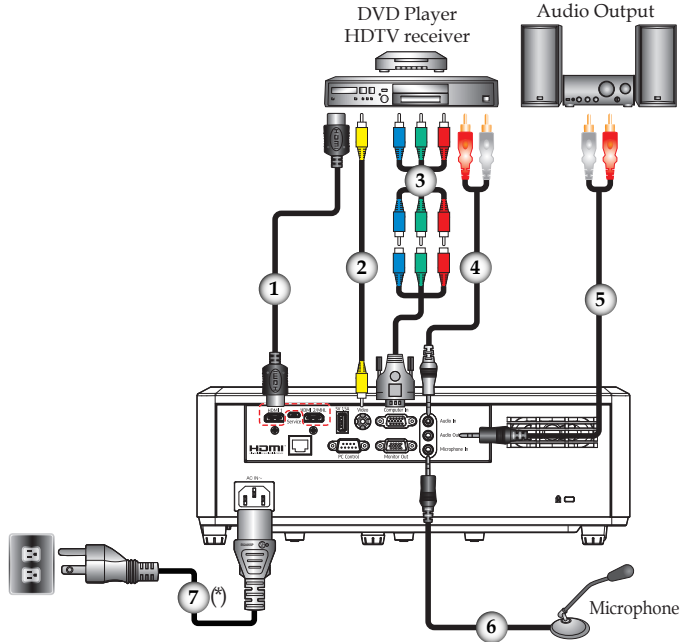

- | | |
|--------|-----------------------|
| 1..... | HDMI cable (supplied) |
| 2..... | Video cable |
| 3..... | Component-RGB cable |
| 4..... | Audio cable |
| 5..... | Audio cable |
| 6..... | Microphone cable |
| 7..... | Power cord (supplied) |

Basic Operations

Powering On/Off the Projector

Powering On the Projector

Note

- ❖ If you connect multiple sources at the same time, press "Input" on the control panel or the desired source button on the remote control to switch inputs.
- ❖ Turn on the projector first and then the signal sources.

1. Ensure that the power cord and signal cable are securely connected. The Power indicator will turn red.
2. Remove the lens cap (if applicable).
3. Turn on the projector by pressing the "Power" button on the control panel or the  button on the remote control. The Power indicator will flash blue. The startup screen will display and the Power indicator will turn blue.
4. Turn on your source (computer, notebook, video player, etc.) The projector will detect your source automatically. Make sure that the "Auto Source" has been set to "On".

CAUTION:

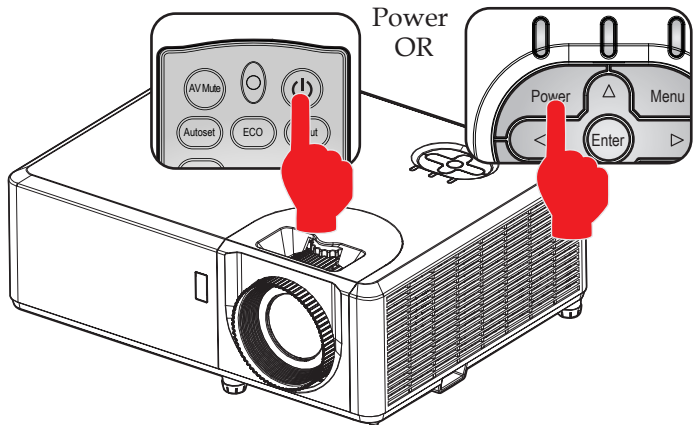

- Do not look into the lens while the laser is on. The strong light from the laser may cause damage to your eyesight.
- Do not block the air intake or exhaust. Doing so could cause a fire due to internal overheating.
- Do not place your hands, face, or other objects near the air exhaust, or the bottom of the unit. Doing so could result in injury and/or damage the object.

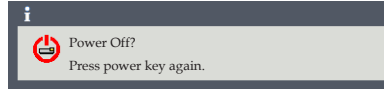

Powering Off the Projector

1. Press the  button and you will see a message as below on the on-screen display.



2. Press the  button to turn off the projector. If you do not press the  button again, the warning message will disappear after 5 seconds.
3. The cooling fan continues to operate for about 5 seconds for cooling cycle and the Power indicator will flash red. After cooling down, the light stops flashing, and then the projector will enter the standby mode.
4. Disconnect the power cord from the electrical outlet and the projector.

Warning Indicator

- ❖ When the “Temp” indicator lights red and the “Power” indicator lights blue, it indicates the projector has overheated. The projector will automatically shut itself down.

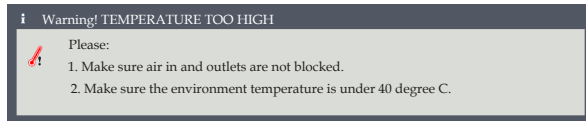

Basic Operations

- ❖ When the “Temp” indicator flashes red and the “Power” indicator lights blue and the message below displays, it indicates the cooling fan failed (FAN1: 1 sec on, 1 sec off; FAN2: 2 sec on, 2 sec off; FAN3: 3 sec on, 3 sec off). Stop using the projector and disconnect the power cord from the electrical outlet, then contact your local dealer or our service center.

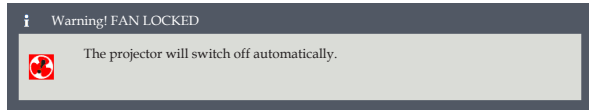

For more information of the warning indicator, please see page 76.

Adjusting the Projected Image

Adjusting the Position of Projector Image

The projector is equipped with rear and front adjustable feet to raise and lower the image to fill the screen.

1. Locate the adjustable foot you wish to modify on the underside of the projector.
2. Rotate the adjustable ring clockwise to raise the projector or counter clockwise to lower it. Repeat with the remaining feet as necessary.

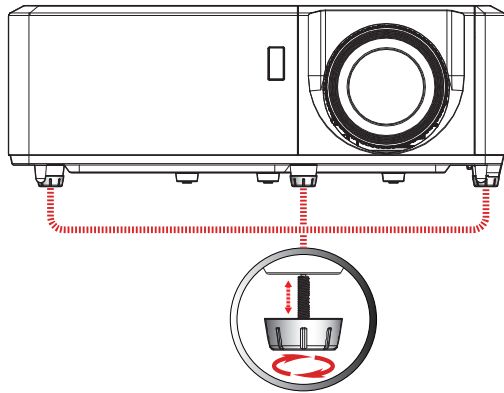

Note

❖ The projector has one adjustable foot in the front and two adjustable feet on the rear. The maximum length of the feet is 26 mm. The tilt angle is up to 6° .

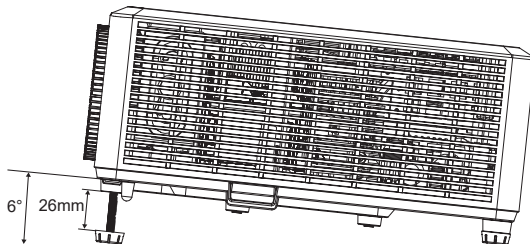

Basic Operations

Adjusting the Projector Zoom, Focus, and Lens Shift

Note

- ❖ The image is not stable immediately after the projector is turned on. Adjust the image at least 30 minutes after the projector is turned on.
- ❖ The projected image becomes unsharp when Keystone correction is enabled. This is a limitation of digital correction.

You may turn the zoom lever to zoom in or out. To focus the image, turn the focus ring clockwise or counterclockwise until the image is clear. To adjust the image position, turn the lens shift dial clockwise or counterclockwise to adjust the position of the projected image vertically.

Focus Distances (lens to wall):

- ▶ RICOH PJ WXL5860 (WXGA): from 1.0m to 7.2m (from 3.28 feet to 23.62 feet)
- ▶ RICOH PJ WUL5860 (WUXGA): from 1.0m to 7.9m (from 3.28 feet to 25.92 feet)

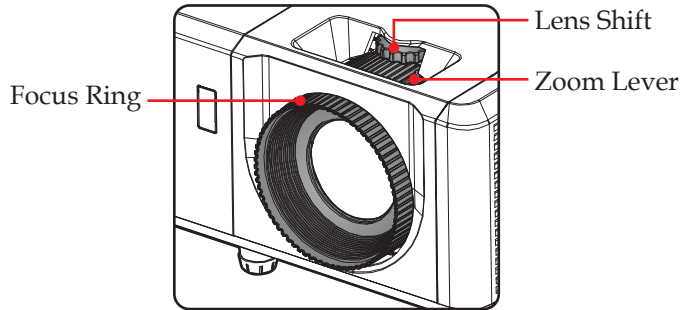

Basic Operations

Adjusting Projection Image Size

Projection Image Size (Diagonal) for:

- ▶ WXGA (WXL5860):
 - <Tele>: 30" to 219" (0.76m to 5.56m)
 - <Wide>: 42" to 300" (1.07m to 7.62m)
- ▶ WUXGA (WUL5860):
 - <Tele>: 29" to 231" (0.74m to 5.87m)
 - <Wide>: 38" to 303" (0.97m to 7.70m)

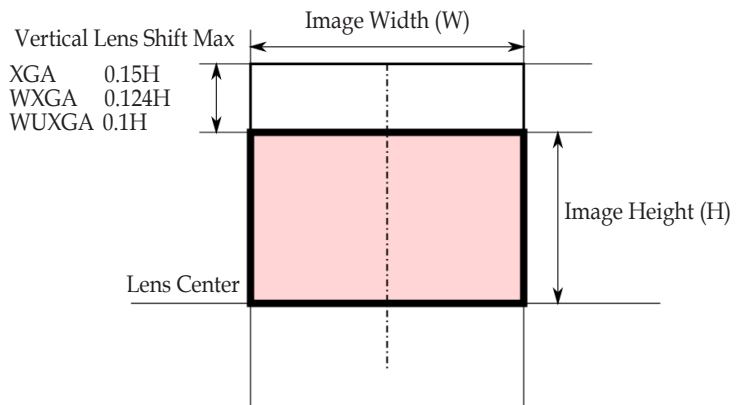
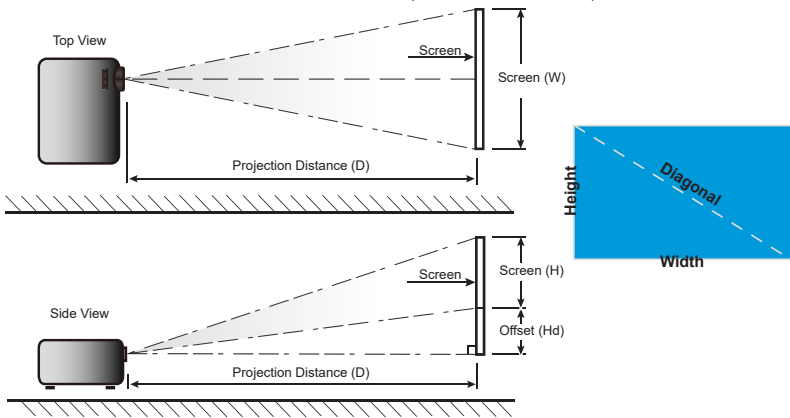

Basic Operations

RICOH PJ WXL5860 (WXGA)

Diagonal Length Size of (16:10) Screen	Screen Size WxH				Projection Distance				Offset (Hd)			
	(m)		(inch)		(m)		(feet)		(m)		(inch)	
	Width	Height	Width	Height	Wide	Tele	Wide	Tele	Min	Max	Min	Max
30	0.65	0.40	25.4	15.9	--	0.98	--	3.2	0.00	0.05	0.0	2.0
42	0.90	0.57	35.6	22.3	1.01	1.38	3.3	4.5	0.00	0.07	0.0	2.8
60	1.29	0.81	50.9	31.8	1.44	1.97	4.7	6.5	0.00	0.10	0.0	3.9
70	1.51	0.94	59.4	37.1	1.68	2.30	5.5	7.5	0.00	0.12	0.0	4.6
80	1.72	1.08	67.8	42.4	1.92	2.62	6.3	8.6	0.00	0.13	0.0	5.3
90	1.94	1.21	76.3	47.7	2.16	2.95	7.1	9.7	0.00	0.15	0.0	5.9
100	2.15	1.35	84.8	53.0	2.40	3.28	7.9	10.8	0.00	0.17	0.0	6.6
120	2.58	1.62	101.8	63.6	2.88	3.94	9.4	12.9	0.00	0.20	0.0	7.9
150	3.23	2.02	127.2	79.5	3.60	4.92	11.8	16.1	0.00	0.25	0.0	9.9
180	3.88	2.42	152.6	95.4	4.32	5.90	14.2	19.4	0.00	0.30	0.0	11.8
200	4.31	2.69	169.6	106.0	4.79	6.56	15.7	21.5	0.00	0.33	0.0	13.1
219	4.72	2.95	185.7	116.1	5.25	7.18	17.2	23.6	0.00	0.37	0.0	14.4
300	6.46	4.04	254.4	159.0	7.19	--	23.6	--	0.00	0.50	0.0	19.7

❖ This table is for user's reference only.

❖ Zoom ratio is 1.36x.

RICOH PJ WUL5860 (WUXGA)

Diagonal Length Size of (16:10) Screen	Screen Size WxH				Projection Distance				Offset (Hd)			
	(m)		(inch)		(m)		(feet)		(m)		(inch)	
	Width	Height	Width	Height	Wide	Tele	Wide	Tele	Min	Max	Min	Max
29	0.62	0.39	24.6	15.4	--	0.99	--	3.3	0.00	0.04	0.0	1.5
38	0.82	0.51	32.2	20.1	0.99	1.30	3.2	4.3	0.00	0.05	0.0	2.0
60	1.29	0.81	50.9	31.8	1.56	2.05	5.1	6.7	0.00	0.08	0.0	3.2
70	1.51	0.94	59.4	37.1	1.82	2.40	6.0	7.9	0.00	0.09	0.0	3.7
80	1.72	1.08	67.8	42.4	2.08	2.74	6.8	9.0	0.00	0.11	0.0	4.2
90	1.94	1.21	76.3	47.7	2.35	3.08	7.7	10.1	0.00	0.12	0.0	4.8
100	2.15	1.35	84.8	53.0	2.61	3.42	8.6	11.2	0.00	0.13	0.0	5.3
120	2.58	1.62	101.8	63.6	3.13	4.11	10.3	13.5	0.00	0.16	0.0	6.4
150	3.23	2.02	127.2	79.5	3.91	5.14	12.8	16.9	0.00	0.20	0.0	7.9
180	3.88	2.42	152.6	95.4	4.69	6.16	15.4	20.2	0.00	0.24	0.0	9.5
200	4.31	2.69	169.6	106.0	5.21	6.85	17.1	22.5	0.00	0.27	0.0	10.6
231	4.98	3.11	195.9	122.4	6.02	7.91	19.8	26.0	0.00	0.31	0.0	12.2
303.1	6.53	4.08	257.0	160.6	7.90	--	25.9	--	0.00	0.41	0.0	16.1

❖ This table is for user's reference only.

❖ Zoom ratio is 1.3x.

Using the On Screen Display (OSD)

The Projector has a multilingual On Screen Display that allows you to make image adjustments and change a variety of settings.

How to operate

1. To open the OSD, press “Menu” on the Control Panel or Remote Control.
2. When OSD is displayed, use ▲▼ keys to select any item in the main menu. While making a selection on a particular page, press “Enter” key to enter sub menu.
3. Use ▲▼ keys to select the desired item in the sub menu and press “Enter” key to view further settings. Adjust the settings by using ◀▶ key or ▲▼ key.
4. Select the next item to be adjusted in the sub menu and adjust as described above.
5. Press “Enter”, and the screen will return to the previous menu.
6. Press “Menu” key to return to the main menu.
7. To exit, press “Menu” again. The OSD menu will close and the projector will automatically save the new settings.

Note

❖ If no button operation is made for approximately 10 seconds, the OSD will be closed automatically.

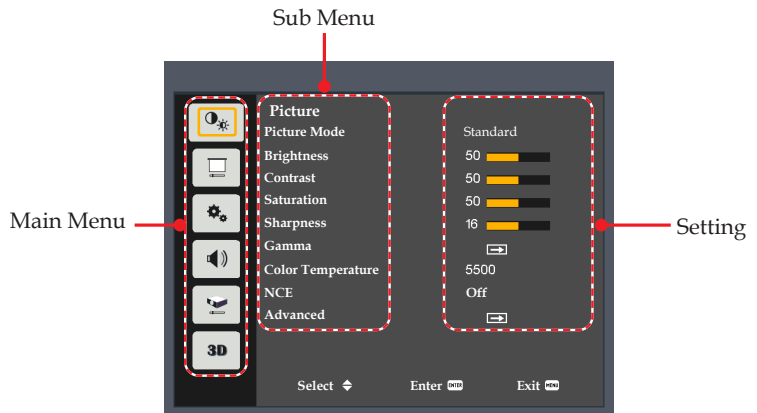

User Settings

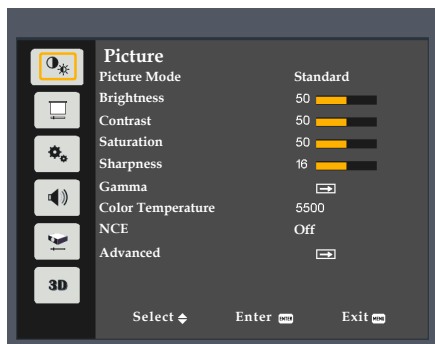

Picture

Picture Mode

There are factory presets optimized for various types of images. The available options:

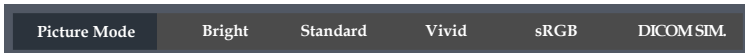

Note

❖ Picture Mode, Color Temperature, NCE, and advanced picture functions are grayed out in 3D mode.

- ▶ Bright: Mode for emphasizing brightness.
- ▶ Standard: Mode for optimizing the balance between brightness and color reproduction.
- ▶ Vivid: Mode for emphasizing color.
- ▶ sRGB: Standard color values.
- ▶ DICOM SIM.: This mode is suitable for projecting a monochrome medical image such as an X ray radiography, MRI, etc.

Brightness

Adjust the brightness of the image.

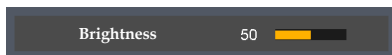

- ▶ Press the ◀ key to darken image.
- ▶ Press the ▶ key to lighten the image.

User Settings

Contrast

The contrast controls the degree of difference between the lightest and darkest parts of the picture. Adjusting the contrast changes the amount of black and white in the image.



- ▶ Press the ◀ key to decrease the contrast.
- ▶ Press the ▶ key to increase the contrast.

Saturation

Adjust the color saturation of the image.



- ▶ Press the ◀ key to decrease the amount of color in the image.
- ▶ Press the ▶ key to increase the amount of color in the image.

Note

❖ "Saturation" function is only supported if the input signal is Video.

Sharpness

Adjust the sharpness of the image.



- ▶ Press the ◀ key to decrease the sharpness.
- ▶ Press the ▶ key to increase the sharpness.

Gamma

Use this function to optimize the image output.

The available options: 1.8 / 2 / Standard(2.2) / 2.4 / Shine.

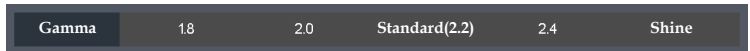

User Settings

Color Temperature

Use this function to select the preset color temperature. The available options: 5500/ 6500 / 7500 / Native.



NCE (Natural Color Enhancer)

Use this function to enhance color and reproduce vivid colors.



- ▶ On: Enable NCE.
- ▶ Off: Disable NCE.

Advanced

Configure the advanced image settings.

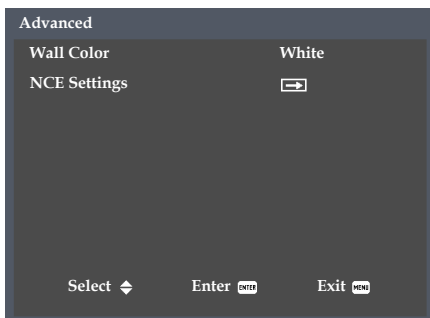

- ▶ Wall Color: Use this function to obtain an optimized screen image according to the wall color. The available options: White/ Light Yellow/ Light Blue/ Pink / Dark Green.



User Settings

- ▶ NCE Settings: Configure the image color settings.

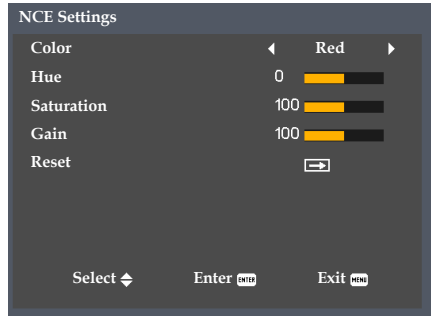

- Color: Use the ◀ or ▶ key to select the red, green, blue, cyan, yellow, magenta, and white.

When Red / Green / Blue / Cyan / Yellow / Magenta is selected in Color:

- Hue: Use the ◀ or ▶ key to adjust the color balance.
- Saturation: Use the ◀ or ▶ key to adjust the color saturation.
- Gain: Use the ◀ or ▶ key to adjust the color brightness.
- Reset: Return the NCE settings to the factory default values.

When White is selected in Color:

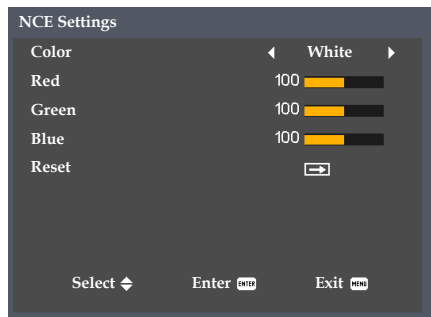

- Red: Use the ◀ or ▶ key to adjust the gain of red.
- Green: Use the ◀ or ▶ key to adjust the gain of green.
- Blue: Use the ◀ or ▶ key to adjust the gain of blue.
- Reset: Return the NCE settings to the factory default values.

User Settings

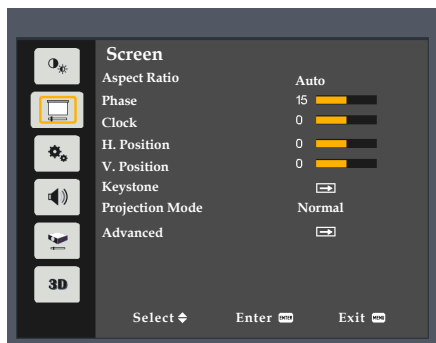

Screen

Aspect Ratio

Use this function to choose your desired aspect ratio.



- ▶ Auto: Automatically selects the appropriate display format.
- ▶ 4:3: Displays 4:3 aspect ratio.
- ▶ 16:9: Displays 16:9 aspect ratio.
- ▶ 16:10: Displays 16:10 aspect ratio.

Phase

Eliminate flicker from the image displayed. Use the ◀ or ▶ key to adjust the value.



Clock

Adjust the number of total dots in one horizontal period. Use the ◀ or ▶ key to adjust number to match your PC image.



Note

❖ “Phase” and “Clock” functions are only supported under Computer Signal source.

User Settings

Note

❖ “H. Position” and “V. Position” functions are only supported under Computer Signal source.

H. Position (Horizontal Position)

Shift the projected image position horizontally.



- ▶ Press the ◀ key to move the image left.
- ▶ Press the ▶ key to move the image right.

V. Position (Vertical Position)

Shift the projected image position vertically.



- ▶ Press the ◀ key to move the image down.
- ▶ Press the ▶ key to move the image up.

Note

❖ The projected image becomes unsharp when Keystone correction is enabled.

Keystone

Adjust image distortion caused by tilting the projector.

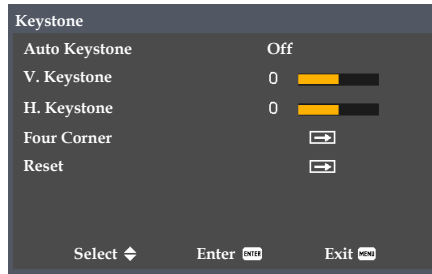

- ▶ Auto Keystone: Adjust image distortion caused by tilting the projector.

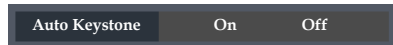

- On: Automatically adjust vertical image.
- Off: Manually adjust vertical image.

- ▶ V. Keystone: Adjust the vertical keystone.

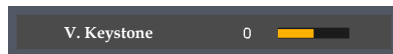

User Settings

- ▶ H. Keystone: Adjust the horizontal keystone.

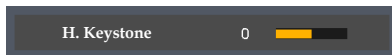

- ▶ Four Corner: Compensate for image distortion by adjusting one corner at a time.

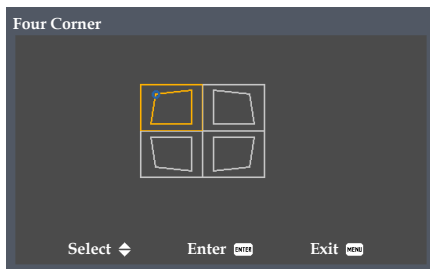

- ▶ Reset: Return the keystone settings to the factory default values.

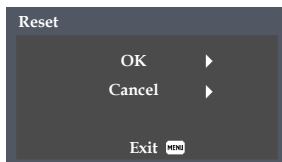

Projection Mode

Use this function to select the projector mode, depending upon how the projector is mounted.

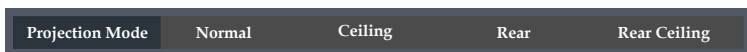

- ▶ Normal: This is the default selection. The image is projected directly onto the screen.
- ▶ Ceiling: When selected, the image will appear upside down.
- ▶ Rear: When selected, the image will appear reversed.
- ▶ Rear Ceiling: When selected, the image will appear reversed in upside down position.

User Settings

Advanced

Configure the advanced screen settings.

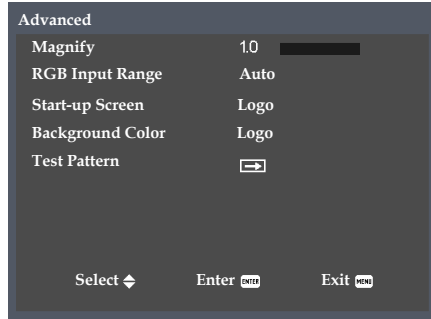

Note

❖
“RGB Input Range”
function is only
supported under
HDMI source.

- ▶ Magnify: Use the ◀ or ▶ key to zoom in or zoom out the image. In magnified mode, press [Enter] to erase magnify scale display.



And press [Enter] again to enter moving magnified area mode. 4 triangles are displayed and magnified area can be moved by 4 direction keys.

Method of operation using a remote control:

1. Use the [Magnify] key on the remote control to enlarge the screen.
 2. Press the [Enter] key. The magnification display disappears.
 3. Press the [Enter] key again. 4 triangles are displayed to indicate that you can move.
 4. Press the ▲ / ▼ / ◀ / ▶ key to move the part to be enlarged.
- ▶ RGB Input Range: Adjust the color range of the HDMI image data.



- Auto: Automatically detect RGB range.
- Limited Range: Process the input image with a limited RGB range.
- Full Range: Select this mode when computer signal or full range signal from AV equipment is input.

User Settings

- ▶ Start-up Screen: Set the start-up screen.

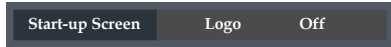

- Logo: Set the logo screen for start up screen.
- Off: Set the black screen for start up screen.

- ▶ Background Color: Set the background color.



- Logo: Display logo screen when no signal is available.
- Blue: Display blue screen when no signal is available.
- Black: Display black screen when no signal is available.

- ▶ Test Pattern: Use this function to choose your desired test pattern between grid and white. Choose "Off" to disable this function.



User Settings

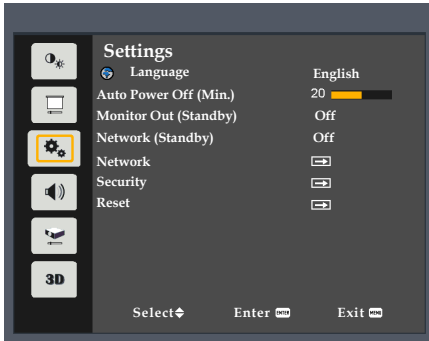

Settings

Language

Choose the multilingual OSD. Press “Enter” to open the sub menu and then use the ▲ or ▼ or ◀ or ▶ key to select your preferred language. Press “Enter” to finalize the selection.



User Settings

Note

- ❖ Default value of "Auto Power Off (Min.)" is 20 min.

Auto Power Off (Min.)

Set the countdown timer interval (in minutes). The countdown timer will start, when there is no signal being sent to the projector. The projector will automatically power off when the countdown has finished. When countdown timer is selected to "0", auto power off is disabled.

Auto Power Off (Min.) 20 

Monitor Out (Standby)

Enable/Disable the Monitor output function.

Monitor Out (Standby) On Off

- ▶ On: Enable the Monitor Out function at projector standby status.
- ▶ Off: Disable the Monitor Out function at projector standby status.

Network (Standby)

Enable/Disable the network function.

Network (Standby) On Off





- ▶ On: Enable the network function at projector standby status.
- ▶ Off: Disable the network function at projector standby status.

Note

- ❖ Consult network administrator for network settings.

Network

Configure the network settings.

Network		
Status	Connected	
DHCP	On	
IP Address	192.168.0.100	
Subnet Mask	255.255.255.0	
Gateway	192.168.0.1	
DNS	192.168.0.1	
Apply		
MAC Address	11-22-33-44-55-66	
Reset		
Select 	Enter 	Exit 

User Settings

- ▶ Status: Display the network connection status.
- ▶ DHCP: Select “On” to allow the projector to obtain an IP address automatically from your network. Select “Off” to manually assign IP, Subnet Mask and Gateway configuration.

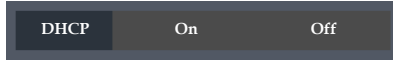

- ▶ IP Address: Set an IP address or display IP address provided from server.

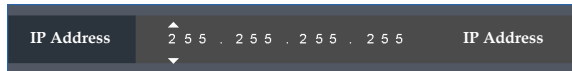

- ▶ Subnet Mask: Set subnet mask number or display subnet mask number provided from server.

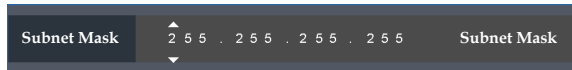

- ▶ Gateway: Set the default gateway of the network connected to the projector or display the default gateway of the network provided from server.

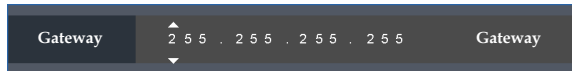

- ▶ DNS: Display the IP address of the domain name system (DNS) server.

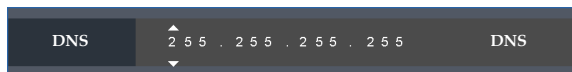

- ▶ Apply: Select “Yes” to apply the changes made in network configuration settings.

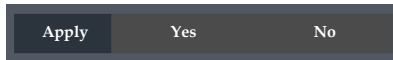

- ▶ MAC Address: Display MAC address.
- ▶ Reset: Clean current webpage password and new webpage password need to be set again.

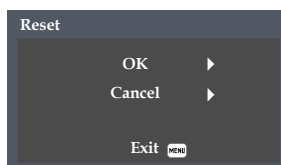

User Settings

Security

Note

❖ The default security code is "123456".

Configure the security settings.

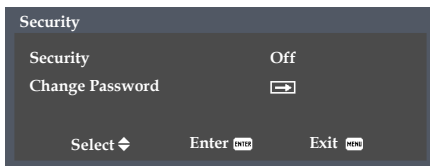

- ▶ Security: Select "On" to use the security verification when the turning on the projector. Select "Off" to be able to switch on the projector without a password verification.



- ▶ Change Password: Set the password.



Reset

Reset adjustments and settings to factory defaults. Selecting "OK" will return all menu item settings to their factory defaults. However, laser usage time, language, network (standby), remote control ID will not return to the default settings.

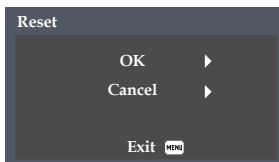

User Settings



Audio

Mute

Temporarily turn off the sound.

Note

❖ “Mute” function affects both internal and external speaker volume.

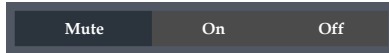

- ▶ Choose “On” to mute the sound.
- ▶ Choose “Off” to turn mute off.

Volume

Adjust the volume level.



- ▶ Press the ◀ key to decrease the volume.
- ▶ Press the ▶ key to increase the volume.

Audio Input

Set the audio input source.



- ▶ Default: Automatically outputs audio.
- ▶ Audio In: Only outputs audio from “Audio Input” connector.
- ▶ MIC In: Only outputs audio from “MIC In” connector.

User Settings

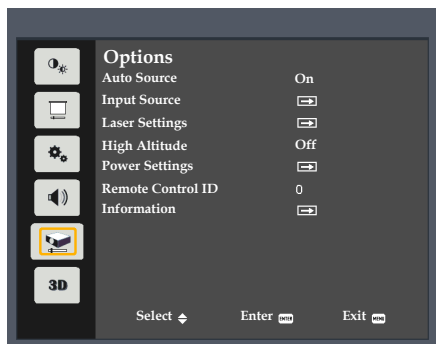

Options

Auto Source

When this function is turned "On", the projector will search for other signals if the current input signal is lost. When this function is turned "Off", it will only search a specified connection port.

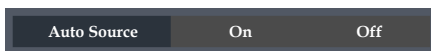

Input Source

Use this option to enable/disable input sources. Press the ► key to enter the sub menu and select which sources you require. Press "Enter" to finalize the selection. The projector will only search for inputs that are enabled.

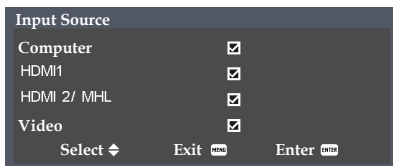

User Settings

Laser Settings

Use this option to view the laser diode usage status and configure the laser settings. Press the “Enter” key to enter the sub menu and configure the desired settings.

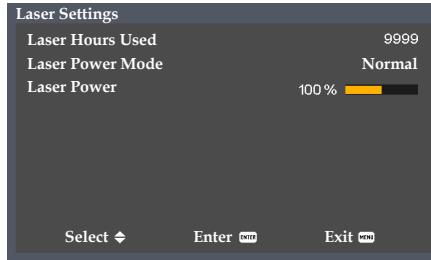

- ▶ Laser Hours Used: Display the projection time.
- ▶ Laser Power Mode: Set the brightness mode. Choose “Normal” to increase the brightness, “Eco.” to dim the projector laser diode which will lower power consumption and extend the laser diode life, and “Image ECO” to adjust power consumption dynamically.

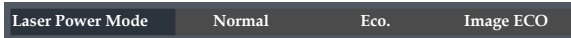

- ▶ Laser Power: Adjust 50%~100% power for Normal mode.



High Altitude

When “On” is selected, the fans will spin faster. Set High Altitude mode to “On” when the projector is used over 2500ft (750m) elevation.



User Settings

Power Settings

Use this option to configure the power settings. Press the "Enter" key to enter the sub menu and configure the desired settings. If changes are made, they will take effect the next time the projector is powered on.

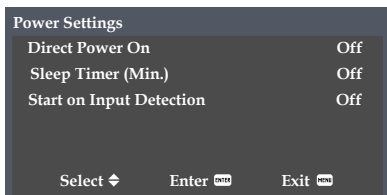

- ▶ **Direct Power On:** Select "On" to automatically power on the projector when the AC power is supplied. If this option is set to "Off", user needs to press the "Power" button on the control panel or the "⏻" button on the remote control to power on the projector.

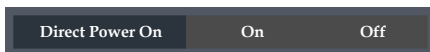

- ▶ **Sleep Timer (Min.):** Set the countdown timer interval. The projector will shut down automatically after the countdown has reached 0.

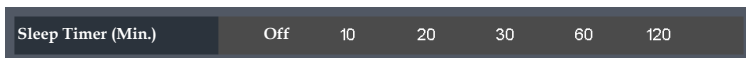

Note

❖ "Start on Input Detection" is only available for HDMI device.

- ▶ **Start on Input Detection:** Select "On" to automatically power on the projector when the AC power is supplied. If this option is set to "Off", user needs to press the "Power" button on the control panel or the "⏻" button on the remote control to power on the projector.



- On: Automatically power on the projector if HDMI device is available in standby.
- Off: Manually power on the projector even if HDMI device is available in standby.

User Settings

Note

❖ The ID range is from 00~99.

Remote Control ID

Adjust remote customer code after setting "ID Set" and Number (0~9) key in remote. (See page 26)



Information

Display the projector information.

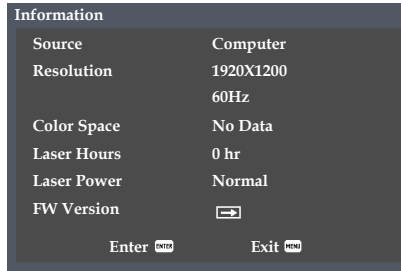

- ▶ Source: Display the current source.
- ▶ Resolution: Display the related information of the current source.
- ▶ Color Space: Display the color space of the current source.
- ▶ Laser Hours: Display the laser diode hours.
- ▶ Laser Power: Display the power mode of the laser diode.
- ▶ FW Version: Display the firmware version for System, MCU, and LAN.

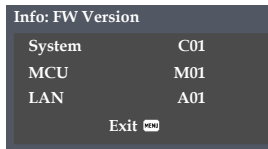

User Settings

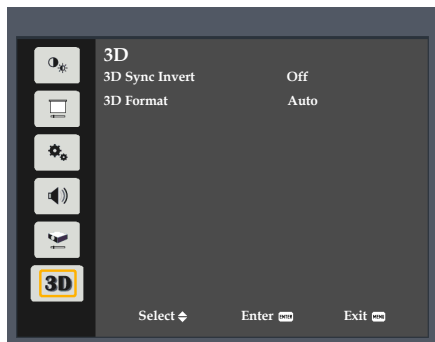

3D

Note

❖ Compatible 3D source, 3D content and Optical 3D glasses are required for 3D viewing.

❖ “3D Sync Invert” is only available when 3D is enabled.

❖ This setting may need to change when re-start running 3D movie.

❖ 3D function is turned on automatically when Blu-ray 3D source is input.

3D Sync Invert

Use this option to enable/disable the 3D sync invert function.



- ▶ Off: Choose “Off” for default frame contents.
- ▶ On: Choose “On” to invert left and right frame contents.

3D Format

Use this option to select the appropriate 3D format content.

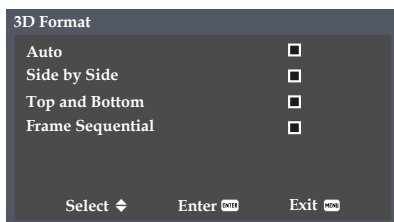

User Settings

- ▶ Auto: Use this mode to let the system to automatically select the appropriate 3D format content.
- ▶ Side by Side: Use this mode for “Side by Side” format 3D content.
- ▶ Top and Bottom: Use this mode for “Top and Bottom” format 3D content.
- ▶ Frame Sequential: Use this mode for “Frame Sequential” format 3D content.

Controlling this Device with Web Browser

Note

❖ When you are connecting the device to an existing network, set according to the instructions of the network administrator.

You can control this device from a PC by using a web browser.

Connecting to the device

1. Confirmation of the IP address of the device

Select the “Settings” → “Network” in the menu of this device, and verify the IP address. (See pages 50~51 on the projector user’s manual).

Network	
Status	Connected
DHCP	On
IP Address	192.168.0.100
Subnet Mask	255.255.255.0
Gateway	192.168.0.1
DNS	192.168.0.1
Apply	→
MAC Address	11-22-33-44-55-66
Reset	□
Select	⏏
Enter	↵
Exit	⏪

Note

❖ This web page uses JavaScript. Turn on and use the JavaScript with the settings of the browser you intend to use.

2. Connection

Enter the IP address that was verified by opening the web browser.

For example, enter `http://192.168.0.100/` if the IP address is displayed as shown above.

LAN Control

Log in

1. When you open the web page for the first time, you will see a screen like the one below. Please enter valid user password.

The screenshot shows the RICOH Projector Web Server Admin interface. The main heading is "RICOH Projector Web Server" with a sub-heading "Projector Name:". On the left is a dark sidebar with "Admin" and "License Information" (a link). The main content area has two sections:

- Change Username and Password for Webpage**:
 - Enter User Name:
 - Enter New password:
 - Confirm New password:
 - Reusing passwords is not recommended.
 - Password cannot be blank.
 - Password needs to be at least eight single-byte characters in length and use a mix of the following 3 types of letters:
 - Uppercase letters
 - Lowercase letters
 - Digits
 - The user name and password are used by the Web Control function. Changing the current settings may interrupt the connection. For details, refer to the user's manual.
- Change P.I.Link Password**:
 - Enter New password:
 - Confirm New password:
 - Reusing passwords is not recommended.
 - The password is used for the communication control via a LAN (including Panasonic application software). Changing the current settings may interrupt the connection. For details, refer to the user's manual.

An "Apply" button is located at the bottom right of the form area.

2. When you open the web page after entering valid password, you will see a screen like the one below. Enter the password in the "Password" field.

The screenshot shows the RICOH Projector Web Server Admin interface after a successful login. The main heading is "RICOH Projector Web Server" with a sub-heading "Projector Name:". On the left is a dark sidebar with "Admin" and "License Information" (a link). The main content area is mostly blank, with a small login form centered:

User Name	<input type="text" value="admin"/>
Password	<input type="password"/>
<input type="button" value="Login"/>	

LAN Control

System Status

The current status of the projector is displayed. You can check projector model name, firmware version, current LAN configuration, and change the interface language if needed.

Note

❖ The version name displayed on the web page in the diagram may differ from the actual display.

RICOH RICOH Projector Web Server
Projector Name:

Admin > System Status

- System Status
- General Setup
- Projector Control
- Network Setup
- Alert Setup
- Crestron
- Reset to Default
- Reboot System
- LAN FW Update

Model Name	LX3005T/WX1.4760 Series
Projector Name	
FW Version	
System	C07
LAN	B08
LAN Status	
IP Address	192.168.1.101
Subnet Mask	255.255.255.0
Default Gateway	192.168.1.1
MAC Address	00:50:41:8C:4D:60

English

[License Information](#)

General Setup

You can change the projector name and password with this item.

Note

- ❖ The projector name set here is also used in PJLink control.
- ❖ If the characters of new password and the characters of confirm (new) password do not match, error message will be displayed. In this case, re-enter the password.

The screenshot shows the RICOH Projector Web Server Admin interface. The main heading is "RICOH Projector Web Server" with a "Projector Name:" field and a "Logout" button. The left sidebar contains navigation options: System Status, General Setup (highlighted), Projector Control, Network Setup, Alert Setup, Creston, Reset to Default, Reboot System, and LAN FW Update. The main content area is titled "Admin - General Setup" and contains several sections: "Change User name and password for Webpage" with fields for "Enter User name" (containing "admin"), "Enter Old password", "Enter New password", and "Confirm New password", along with an "Apply" button and a list of password requirements; "PJLink Setting" with "PJLink Password" options (Enable/Disable), "Current Password", "New Password", and "Confirm Password" fields, and an "Apply" button; and "License Information" at the bottom left.

- ▶ Changing projector name.
Enter the new projector name in the "Projector Name" field.
Click "Apply".
- ▶ Changing the password for Webpage (Web Control).
Enter the current password in the "Enter Old Password" field.
Enter the new password in both the "Enter New Password" field and "Confirm New Password" field.
Click "Apply".
- ▶ Changing the password for PJLink.
Click "Enable" to enable password.
Enter the current password in the "Current Password" field.
Enter the new password in both the "New Password" field and "Confirm Password" field.
Click "Apply".

Projector Control

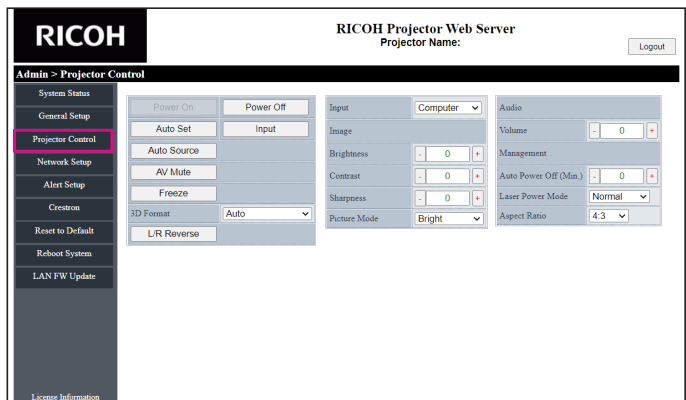

You can control the projector with this item.

The items for control are described in this section.

Control button: When you click a button, the corresponding function will be performed.

Power On	The power of the projector turns on. To turn ON, choose "Settings" → "Network (Standby)" to "On".
Power Off	Turns OFF the power of the projector.
Auto Set	Resync the current source.
Input	Toggle through the input sources (Computer->HDMI1->HDMI2/MHL->Video->Computer...).
Auto Source	Turn off/on the function of "Auto Source".
AV Mute	Turn off/on the audio and video.
Freeze	Freeze/unfreeze the image.
L/R Reverse	Turn off/on the function of "3D Sync Invert".

LAN Control

Adjustment button: Projector can be adjusted by +/- button.

Auto Power Off (Min.)	Set the countdown timer interval in minutes.
Brightness	Adjust brightness by +/- button. Value will return to the initial value when you click the Reset button.
Contrast	Adjust contrast by +/- button. Value will return to the initial value when you click the Reset button.
Sharpness	Adjust sharpness by +/- button. Value will return to the initial value when you click the Reset button.
Volume	Adjust volume by +/- button.

Adjust the projector by selecting a value from the pull-down menu.

Laser Power Mode	Select the desired power mode between "Normal", "Eco.", and "Image ECO".
Input	"Computer", "HDMI1", "HDMI 2/MHL", and "Video".
Picture Mode	Select the desired picture mode between "Bright", "Standard", "Vivid", "sRGB", and "DICOM SIM.".
Aspect Ratio	Select the desired aspect ratio between "Auto", "4:3", "16:9", and "16:10".
3D Format	Select the desired 3D format between "Auto", "Side by Side", "Top and Bottom", and "Frame Sequential".

Network Setup

RICOH RICOH Projector Web Server
Projector Name:

Admin > Network Setup

System Status
General Setup
Projector Control
Network Setup
Alert Setup
Creoson
Reset to Default
Reboot System
LAN FW Update

License Information

DHCP On Off

IP Address

192	168	1	101
-----	-----	---	-----

Subnet Mask

255	255	255	0
-----	-----	-----	---

Default Gateway

192	168	1	1
-----	-----	---	---

DNS Server

192	168	1	1
-----	-----	---	---

Set the network of the projector.



❖ IPv6 cannot be used in this device.

- ▶ Automatically configuring the network settings from DHCP. Check automatic setting and then click "Apply".
- ▶ Configuring the network settings manually. Check manual setting, enter appropriate values in the IP address, Subnet Mask, Default Gateway (Gateway) and DNS Server fields, and then click "Apply".

Alert Setup

You can send email alerts when an error occurs.
You can carry out settings for alert mail in this section.

RICOH Projector Web Server		Projector Name:	Logout
Admin > Alert Setup			
System Status	Alert Type	<input checked="" type="checkbox"/> Fan Error	
General Setup		<input checked="" type="checkbox"/> High Temp Warning	<input checked="" type="checkbox"/> Light Source Error
Projector Control	Alert Mail Notification	<input checked="" type="checkbox"/>	
Network Setup	SMTP Setting		
Alert Setup	SMTP Server	192.168.1.112	
Creation	From	test@test.com	
Reset to Default	User Name	test	
Reboot System	Password	****	
LAN FW Update	Email Setting		
License Information	Mail Subject	Ricoth	
	Mail Content	Temp	
	To	test1@test.com;test@test.com	
		Apply	Send Test Mail

Note

❖ When you have changed the settings, verify that the e-mail settings are done correctly. It is recommended that you send a test mail.

❖ E-mail transmission protocol supports only SMTP. Other protocols cannot be used.

❖ When Japanese or Chinese characters are used in an e-mail content, the e-mail may be received with unreadable characters. In such case, please use English characters for the e-mail content.

- ▶ Alert types
Check the type of error for which you want to send alert mail.
- ▶ Alert mail notification
Check and perform the following settings.
- ▶ SMTP Setting
Set the following:
 - SMTP Server: Server address (server name) (SMTP server)
 - From: e-mail address of the sender
 - User Name: User name of the mail server
 - Password: Mail server password
- ▶ Email Setting
 - Mail Subject
 - Mail Content
 - To: Enter the e-mail address of the sender.
 - Click "Apply" to fix the value.

Enter the IP address of projector in *xxx.xxx.xxx.xxx.

Send Test Mail

When you click [Send Test Mail], test email will be sent.
The text will be "Email Test xxx.xxx.xxx.xxx *".

LAN Control

Crestron

You can use the control of projectors that uses Crestron.

Note

- ❖ When projector is in standby mode, only the “Power” button will work.
- ❖ Crestron is valid while the browsers supports adobe flash player.



- ▶ Power: Switch ON/OFF the power.
- ▶ Source List: Correspondence between the input display and input terminal of the device is as follows.
 - Computer
 - HDMI1
 - HDMI2/MHL
 - Video
- ▶ Other buttons work in the same manner as Projector Control.

LAN Control

Note

- ❖ After setting the user password, you will be able to access Crestron's page by entering the password.
- ❖ After enabling the Admin password, you will be able to access the page of Crestron tool only upon entering the Admin password.

Crestron Tools

You can perform settings of the projector network and Crestron Room View.

The screenshot shows the 'Crestron Control' and 'Projector' configuration pages. The 'Crestron Control' section includes fields for IP Address (192.168.0.50), IP ID (7), and Port (41794), with a 'Send' button. The 'Projector' section includes fields for Projector Name (RICOH PROJECTOR), Location (LOCATION), Assigned to (Projector), DHCP (Enabled), IP Address (192.168.0.100), Subnet Mask (255.255.255.0), Default Gateway (192.168.0.254), and DNS Server (192.168.0.51), with 'Send' buttons. The 'User Password' section has 'Enabled' checkbox, 'New Password', and 'Confirm' fields with a 'Send' button. The 'Admin Password' section has 'Enabled' checkbox, 'New Password', and 'Confirm' fields with a 'Send' button. An 'exit' button is at the bottom.

Crestron Info

You can display information about the firmware version of the projector and status of the laser.

The screenshot shows the 'Projector Information' and 'Projector Status' pages. The 'Projector Information' section includes fields for Projector Name (RICOH PROJECTOR), Location (LOCATION), Firmware Version (A02), Mac Address (00:50:41:87:2B:17), Resolution (1600X1200 60Hz), Lamp Hours (4), and Assigned to (Projector). The 'Projector Status' section includes fields for Power Status (Power On), Source (Computer), Picture mode (Standard), Projection (Front), Lamp Mode (Normal), and Error Status (0:No Error). An 'exit' button is at the bottom.

LAN Control

Contacting the IT administrator of Crestron

You can contact the IT administrators who are using X-Panel.

Note

- ❖ Crestron offers Xpanel.exe.

The screenshot shows the X-Panel interface for a projector. At the top, there is a navigation bar with 'Model: Projector', 'Tool', 'Info', and 'Contact IT Help'. Below this is a search box with a 'Title' label and a 'Send' button. The main content area is divided into two columns: 'Projector Information' and 'Projector Status'. The 'Projector Information' column contains fields for Projector Name (RICOH PROJECTOR), Location (LOCATION), Firmware Version (A02), Mac Address (00:50:41:87:2B:17), Resolution (1600X1200 60Hz), Lamp Hours (4), and Assigned to (Projector). The 'Projector Status' column contains fields for Power Status (Power On), Source (Computer), Picture mode (Standard), Projection (Front), Lamp Mode (Normal), and Error Status (No Error). An 'exit' button is located at the bottom center of the interface.

Reset to Default

You can reset the network to factory settings.

Press the **Apply** button. Webpage password will be cleaned and new webpage password need be set again.

The screenshot shows the RICOH Projector Web Server interface. The top header displays 'RICOH' and 'RICOH Projector Web Server' with the Projector Name and a 'Logout' button. The main content area is titled 'Admin > Reset to Default'. On the left, there is a navigation menu with options: System Status, General Setup, Projector Control, Network Setup, Alert Setup, Crestron, Reset to Default (highlighted with a red box), Reboot System, and LAN FW Update. The main content area features a warning icon and the text 'Reset Default' followed by 'This will restore the LAN settings.' and an 'Apply' button. The bottom of the page shows 'License Information'.

Reboot System

You can restart the system.
Press the **Apply** button.

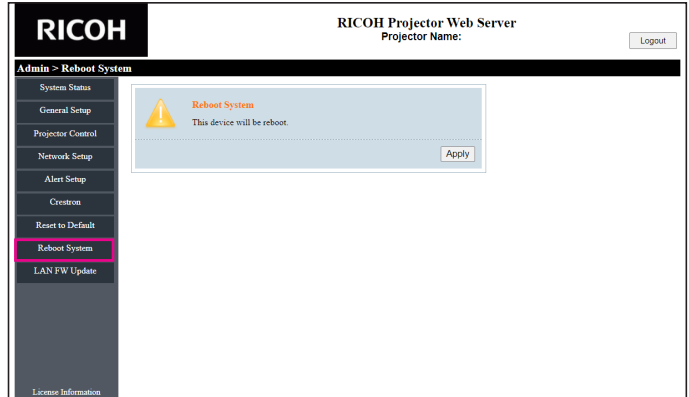

License Information

Display supported licenses.

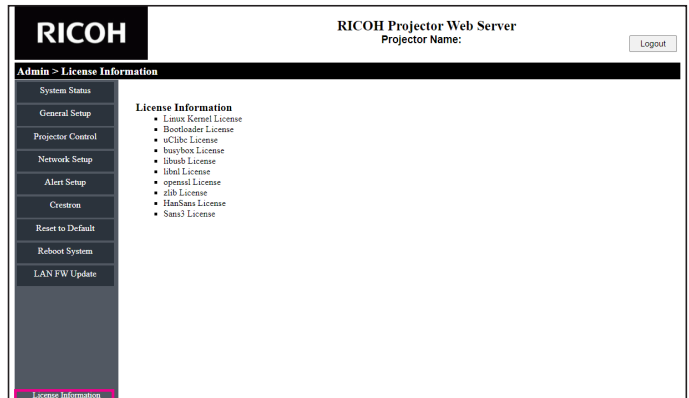

LAN Control

LAN FW Update

You can update LAN firmware.

Click "Select" and select the path where the LAN firmware update file is saved. Then click "Update" to start updating the firmware.

The updated LAN firmware could be downloaded from RICOH's home page.

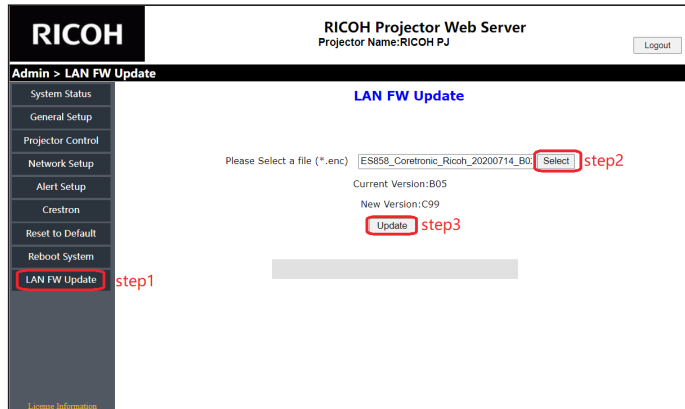

It is the customer's responsibility to update the firmware. If the firmware update fails due to a power outage or communication error, repair costs may be charged.

- ▶ Use the software that corresponds to the product you are using.
- ▶ Do not touch the software and the projector during the firmware update. You may not be able to update the firmware normally.
- ▶ Please note the following during the firmware update:
 - Do not disconnect the network communication.
 - Do not turn off the projector.
 - Do not close the web browser.
 - Do not turn off the PC.

Troubleshooting

If you experience trouble with the projector, refer to the following information. If the problem persists, please contact your local dealer or service center.

Problem: No image appears on screen

- ▶ Ensure all the cables and power connections are correctly and securely connected as described in the “Connecting the Projector” section.
- ▶ Ensure the pins of terminals are not crooked or broken.
- ▶ Make sure the projector is switched on.
- ▶ Ensure that the “AV Mute” feature is not turned on.
- ▶ Make sure you have removed the lens cap and the projector is switched on.

Problem: Partial, scrolling or incorrectly displayed image

- ▶ Press “Autoset” on the remote control.
- ▶ Adjust the computer display settings. Verify the resolution setting is less than or equal to 1600 x 1200 (3840 x 2160 for HDMI) resolution. See your operating system’s Help file.
- ▶ If you are using a Notebook:
 1. First, follow the steps above to adjust resolution of the computer.
 2. Press the toggle output settings. For example: [Fn]+[F3]

PANASONIC, NEC => Fn+F3
HP, SHARP, TOSHIBA => Fn+F5
IBM, SONY => Fn+F7
DELL, EPSON => Fn+F8
FUJITSU => Fn+F10
APPLE =>F7

- ▶ If you experience difficulty changing resolutions or your monitor freezes, restart all equipment including the projector.

Problem: The screen of the Notebook computer is not displaying a presentation

▶ If you are using a Notebook PC:

Some Notebook PCs may deactivate their own screens when a second display device is in use. Each has a different way to be reactivated. Refer to your computer's documentation for detailed information.

Problem: Image is unstable or flickering

- ▶ Adjust the "Phase" or "Clock" to correct it. Refer to the "H. Position" or "V. Position" section for more information.
- ▶ Check and reconfigure the display mode of your graphic card to make it compatible with the product.

Problem: Image is out of focus

- ▶ Adjust the Focus Ring on the projector lens.
- ▶ Make sure the projection screen is between the required distance. (refer to page 36)
- ▶ The projected image becomes unsharp when keystone correction is enabled. This is a limitation of digital correction.

Problem: The image is stretched when displaying 16:9 DVD

Change the aspect ratio by pressing the "Aspect" button on the remote control or select "Screen > Aspect Ratio" from the OSD menu to show image with proper aspect ratio.

Problem: Image is too small or too large

- ▶ Adjust the Zoom lever on the top of the projector.
- ▶ Move the projector closer to or further from the screen.
- ▶ Press the "Aspect" button on the remote control or press the "Menu" button on the projector panel, go to "Screen > Aspect Ratio" and try the different settings.

Troubleshooting

Problem: Image is reversed

- ▶ Select “Screen > Projection Mode” from the OSD menu to adjust the image.

Problem: Indicator lighting message

Note

Steady light => ☀
No light => ⊗

Status	Condition	Power indicator		Temp indicator	Status indicator
		Red	Blue		
Standby		☀	⊗	⊗	⊗
Power On		⊗	☀	⊗	⊗
Standby LAN On		☀	⊗	⊗	⊗
Warming Up		⊗	Flashing * 0.5 sec On/Off	⊗	⊗
Cooling Down		Flashing * 0.5 sec On/Off	⊗	⊗	⊗
Download Mode		☀	☀	☀	☀
Error Status					
Over Heat		⊗	☀	☀	⊗
CW Breakdown		Flashing * 0.5 sec On/Off	⊗	⊗	☀
Laser Fail *Laser hour(H)	[0, 100)	⊗	Flashing * 5 sec On/Off	⊗	☀
	[100, 1000)	☀	☀	⊗	☀
	[1000, 20000)	☀	⊗	⊗	☀
Fan Lock		⊗	☀	Flashing * Fan1: 1 sec On/Off * Fan2: 2 sec On/Off * Fan3: 3 sec On/Off	⊗

Troubleshooting

Problem: Message Reminders

- ▶ Temperature Error - the projector is overheat inside. Check the environmental condition.



- ▶ Fan Error - the cooling system fan is not working.

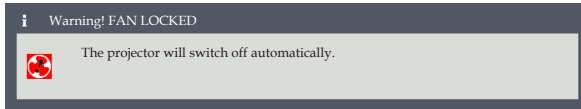

List of Compatible Signals

A. VGA Analog				
(1) PC Signal				
Modes	Resolution	V.Frequency (Hz)	H.Frequency (kHz)	Clock [MHz]
VGA	640x480	60.0	31.5	25.2
	640x480	67.0	35.0	26.8
	640x480	72.0	37.9	31.5
	640x480	75.0	37.5	31.5
	640x480	85.0	43.3	36.0
SVGA	800x600	56.0	35.1	36.0
	800x600	60.0	37.9	40.0
	800x600	72.0	48.1	50.0
	800x600	75.0	46.9	49.5
	800x600	85.0	53.7	56.3
MAC	832x624	75.0	49.1	57.3
XGA	1024x768	60.0	48.4	65.0
	1024x768	70.0	56.5	75.0
	1024x768	75.0	60.0	78.8
	1024x768	85.0	68.7	94.5
	1024x768	120.0	99.0	137.8
MAC	1152x864	75.0	67.5	108.0
SXGA	1280x1024	60.0	64.0	108.0
	1280x1024	72.0	77.0	133.0
	1280x1024	75.0	80.0	135.0
QVGA	1280x960	60.0	60.0	101.3
SXGA+	1400x1050	60.0	65.3	121.8
UXGA	1600x1200	60.0	75.5	162.0
	1920x1080	60.0	67.5	148.5
WUXGA	1920x1200(RB)	60.0	74.0	154.0

Appendices

A. VGA Analog				
(2) Extended Wide Timing				
Modes	Resolution	V.Frequency (Hz)	H.Frequency (kHz)	Clock [MHz]
WXGA	1280x720	60.0	44.8	74.2
	1280x800	60.0	49.6	83.5
	1366x768	60.0	47.7	84.8
	1440x900	60.0	59.9	106.5
WSXGA+	1680x1050	60.0	65.3	146.3
(3) Component Signal				
480p	720x480	59.94	31.5	27.0
576p	720x576	50.0	31.3	27.0
720p	1280x720	60.0	45.0	74.25
	1280x720	50.0	37.5	74.25
1080i	1920x1080	60.0	33.8	74.25
	1920x1080	50.0	28.1	74.25
1080p	1920x1080	23.98/24.0	27.0	74.25
	1920x1080	60.0	67.5	148.5
	1920x1080	50.0	56.3	148.5
(4) 3D				
SVGA	800x600	120.0	77.4	83.0
XGA	1024x768	120.0	98.9	137.75
WXGA	1280x720	120.0	92.9	162.0
WXGA	1280x800	120.0	101.6	146.25

Appendices

B. HDMI Digital				
(1) PC Signal				
Modes	Resolution	V.Frequency (Hz)	H.Frequency (kHz)	Pixel CLK [MHz]
VGA	640x480	60.0	31.5	25.2
	640x480	67.0	35.0	26.8
	640x480	72.0	37.9	31.5
	640x480	75.0	37.5	31.5
	640x480	85.0	43.3	36.0
SVGA	800x600	56.0	35.1	36.0
	800x600	60.0	37.9	40.0
	800x600	72.0	48.1	50.0
	800x600	75.0	46.9	49.5
	800x600	85.0	53.7	56.3
MAC	832x624	75.0	49.1	57.3
XGA	1024x768	60.0	48.4	65.0
	1024x768	70.0	56.5	75.0
	1024x768	75.0	60.0	78.8
	1024x768	85.0	68.7	94.5
MAC	1152x864	75.0	67.5	108.0
SXGA	1280x1024	60.0	64.0	108.0
	1280x1024	72.0	77.0	133.0
	1280x1024	75.0	80.0	135.0
QVGA	1280x960	60.0	60.0	101.3
SXGA+	1400x1050	60.0	65.3	121.8
UXGA	1600x1200	60.0	75.0	162.0
	1920x1080	60.0	67.5	148.5
WUXGA	1920x1200 (RB)	60.0	74.0	154.0
4k	3840x2160	30.0	n/a	n/a
	3840x2160	60.0	n/a	n/a
(2) Extended Wide Timing				
WXGA	1280x720	60.0	44.8	74.2
	1280x800	60.0	49.6	83.5
	1366x768	60.0	47.7	84.8
	1440x900	60.0	59.9	106.5
WXGA+	1680x1050	60.0	65.3	146.3

Appendices

B. HDMI Digital				
(3) Component Signal				
Modes	Resolution	V.Frequency (Hz)	H.Frequency (kHz)	Pixel CLK [MHz]
480p	720x480	59.94	31.5	27.0
576p	720x576	50.0	31.3	27.0
720p	1280x720	60.0	45.0	74.25
	1280x720	50.0	37.5	74.25
1080i	1920x1080	60.0	33.8	74.25
	1920x1080	50	28.1	74.25
1080p	1920x1080	23.98/24	27.0	74.25
	1920x1080	60.0	67.5	148.5
	1920x1080	50.0	56.3	148.5
(4) 3D				
SVGA	800x600	120.0	77.4	83.0
XGA	1024x768	120.0	98.9	137.75
WXGA	1280x720	120.0	92.9	162.0
WXGA	1280x800	120.0	101.6	146.25
720p	1280x720	50.0	37.5	Frame Packing
	1280x720	60.0	45.0	Frame Packing
1080p	1920x1080	24.0	27.0	Frame Packing
720p	1280x720	50.0	37.5	Top and Bottom
	1280x720	60.0	45.0	Top and Bottom
1080i	1920x1080	50.0(25)	28.13	Top and Bottom
	1920x1080	60.0(30)	33.75	Top and Bottom
1080p	1920x1080	24.0	28.13	Top and Bottom
	1920x1080	50.0	28.13	Top and Bottom
	1920x1080	60.0	28.13	Top and Bottom
720p	1280x720	60.0	45.0	Side by Side (Half)
1080i	1920x1080	50.0(25)	28.13	Side by Side (Half)
	1920x1080	60.0(30)	33.75	Side by Side (Half)
1080p	1920x1080	50.0	56.26	Side by Side (Half)
	1920x1080	60.0	67.5	Side by Side (Half)
(5) Input signal frequency range:				
<ul style="list-style-type: none"> Analog: fh=15kHz~100kHz, fv=24Hz~60Hz, Max. pixel rate: 162.5MHz. Digital (HDMI): fh=15kHz~100kHz, fv=24Hz~60Hz, Max. pixel rate: 200MHz. 				

Configurations of Terminals

Terminal: Computer In (Mini D-sub 15 pin) [Monitor Out]



1	Red (R/Cr) Input [R Output]	9	DDC 5V [NC*]
2	Green (G/Y) Input [G Output]	10	Ground (Ver. sync.)
3	Blue (B/Cb) Input [B Output]	11	NC*
4	NC*	12	DDC Data [NC*]
5	Ground (Horiz.sync.)	13	Horiz. sync. Input [Output] (Composite H/V sync. Input)
6	Ground (Red)		
7	Ground (Green)	14	Vert. sync. Input [Output]
8	Ground (Blue)	15	DDC CLK [NC*]

* Do not connect anything.

Terminal: PC Control (D-sub 9 pin)

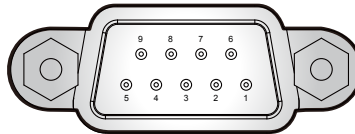

1	NC*	6	NC*
2	TXD (Sending Data)	7	NC*
3	RXD (Receiving Data)	8	NC*
4	NC*	9	NC*
5	GND	* Do not connect anything.	

Note

❖ Contact your dealer for control cable and commands.

Terminal: Microphone

Note

❖ Plug-in power is not supported.

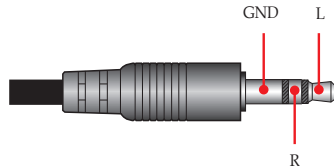

Appendices

Specifications

■ List of general specifications

Item	WXL5860	WUL5860
DLP chip	0.65" DMD WXGA	0.48" DMD WUXGA
Projection Lens	F# 2.51 - 2.93, f=15.99-21.42mm, 1.36x Zoom Lens	F# 1.94 - 2.23, f=12.82-16.74mm, 1.3x Zoom Lens
Projection Distance (focus range)	1.0 - 7.2m (3.28 - 23.62 feet)	1.0 - 7.9m (3.28 - 25.92 feet)
Throw Ratio (distance/width)	1.113 - 1.523	1.21 - 1.59
Dimension (WxDxH)	265 x 337 x 108 (w/o feet)	
	265 x 337 x 122.5 (w feet)	
Weight	Approx. 4.3kg(9.5lbs)	Approx. 4.6kg(10.1lbs)
I/O Terminal	<ul style="list-style-type: none">• HDMI 1 In (HDCP ver1.1)• Service (Micro-USB)• HDMI 2/MHL (HDMI ver2.0/HDCP ver2.2/MHL ver2.0)• PC Control (RS232C)• Video• Computer In (D-sub 15pin)	<ul style="list-style-type: none">• Monitor Out (D-sub 15pin)• Audio In (3.5mm stereo mini jack)• Microphone In (3.5mm stereo mini jack)• Audio Out (3.5mm stereo mini jack)• 5V/1.5A (USB type-A)• LAN• AC In
Speaker	8W x2	
Laser diode life	20,000h	
Noise Level	<ul style="list-style-type: none">• Normal (100%): Typ. 32dBA /Max. 34dBA• ECO: Typ. 31dBA /Max. 33dBA	
Environment	<ul style="list-style-type: none">• Operational Temperatures: 0° to 40°C (32° to 104°F); up to 85% humidity (non-condensing)• Storage Temperatures: -10° to 60°C (14° to 140°F); up to 85% humidity (non-condensing)	
Power Consumption	<ul style="list-style-type: none">• Eco mode: 230W Max. @110Vac• Normal (100%): 300W Max. @110Vac• Eco mode: 225W Max. @220Vac• Normal (100%): 300W Max. @220Vac	
Standby Power	0.5W or less	

Note

- This model complies with the above specifications.
- Designs and specifications are subject to change without notice.
- This model may not be compatible with features and/or specifications that may be added in the future.

Cabinet Dimensions

Unit: mm

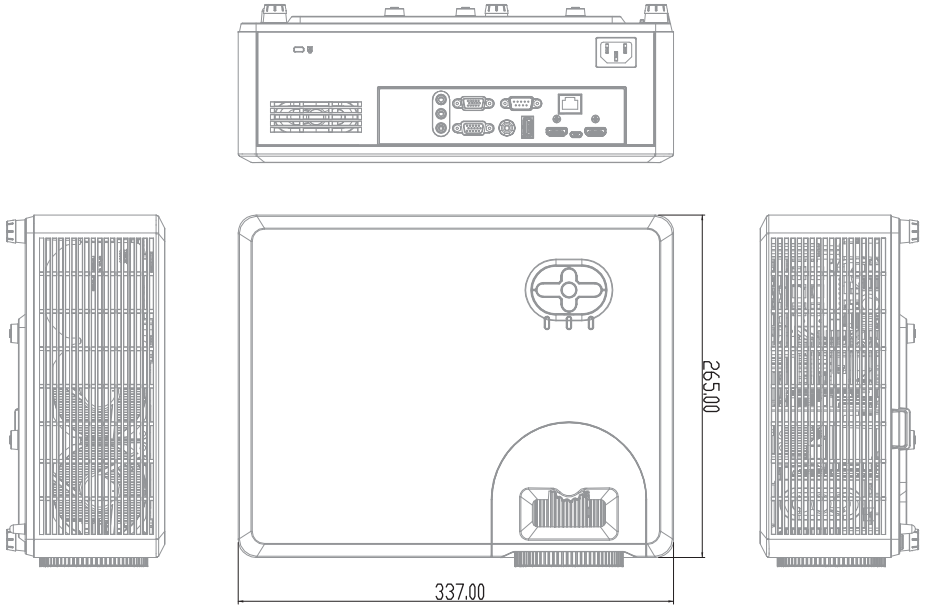

Appendices

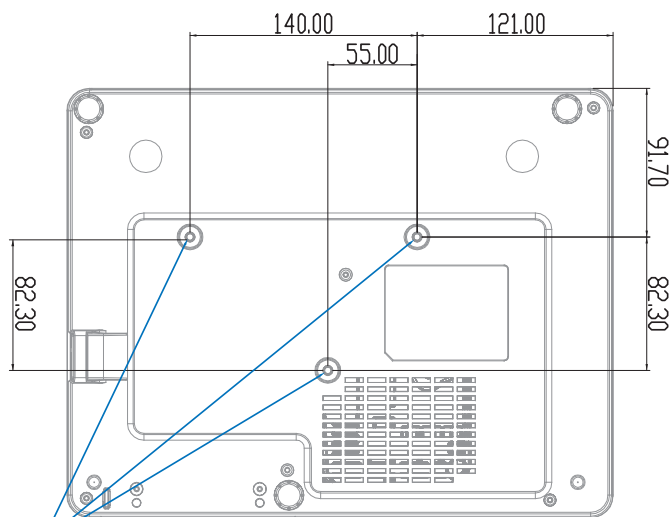
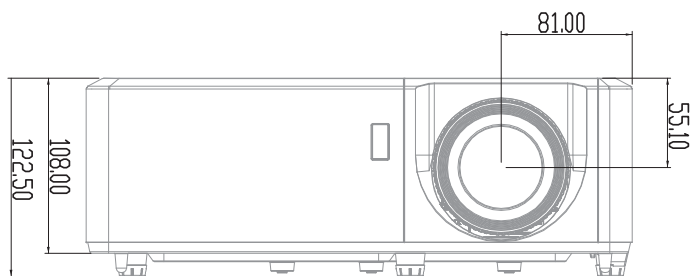

INSERT NUT M4.0*L10 mm

Holes for ceiling mount
Screw size and max. length:
(3) M4-10 mm

Copyrights

Information concerning copyrights, etc. of installed software. Open-source software and third-party software are used in this product.

Information on the copyrights of such software can be found on the License Information page on the web page of this device.

(See “Controlling this Device with Web Browser” on page 60.)

You can also view and download the source code from the following URL

http://www.support-download.com/bb/html/dr_ut_e/oss/index.htm

Trademarks

- DLP is trademarks or registered trademark of Texas Instruments.
- Microsoft, Windows, Windows Vista, Internet Explorer and PowerPoint are either a registered trademark or trademark of Microsoft Corporation in the United States and/or other countries.
- HDMI, the HDMI Logo and High-Definition Multimedia Interface are trademarks or registered trademarks of HDMI Licensing Administrator, Inc.
- MHL, Mobile High-Definition Link, and MHL Logo are trademarks or registered trademarks of MHL,LLC.
- Kensington is a trademark or registered trademark of ACCO Brands.
- Blu-ray is a trademark of Blu-ray Association.
- Other product and company names mentioned in this user’s manual may be the trademarks or registered trademarks of their respective holders.