



User's Manual

1. Usage Notice

2. Introduction

3. Basic Operations

4. User Settings

5. LAN Control

6. Troubleshooting

7. Appendices

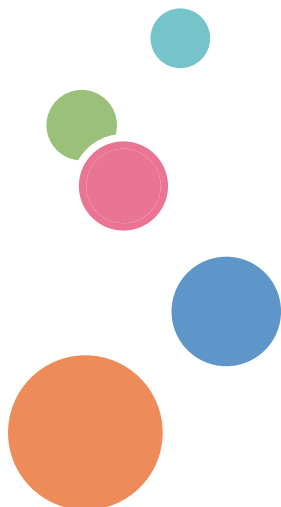

Read this manual carefully before you use this machine and keep it handy for future reference. For safe and correct use, be sure to read the Precautions in this manual before using the machine.

Table of Contents

Usage Notice	2	<i>Audio</i>	62
<i>Precautions</i>	2	<i>Options</i>	63
<i>Safety Labels of This Machine</i>	12	<i>3D Settings</i>	67
<i>Regulation & Safety Notices</i>	14	<i>Controlling this Device with Web Browser</i>	69
<i>Other Information</i>	20	LAN Control	69
<i>Package Overview</i>	21	<i>Projector Login</i>	74
Introduction	21	<i>Operation & Settings</i>	75
<i>Product Overview</i>	22	<i>Date and Time</i>	76
<i>Connection Ports</i>	23	<i>Schedule</i>	77
<i>Control Panel</i>	24	<i>Display Status</i>	78
<i>Remote Control</i>	26	<i>Upgrade</i>	78
<i>Remote Control ID Setup</i>	28	<i>Software License</i>	79
<i>Remote Control Battery Installation</i>	29	<i>Account</i>	79
<i>Remote Control Operating Range</i>	30	<i>Network Settings</i>	80
<i>Installing the Projector</i>	31	<i>Network Functions</i>	80
Basic Operations	32	<i>Controlling the projector with the Projector Management Utility</i>	81
<i>Connecting the Projector</i>	32	Troubleshooting	86
<i>Connect to Computer/Notebook</i>	32	Appendices	91
<i>Connecting HDBaseT</i>	33	<i>List of Compatible Signals</i>	91
<i>Powering On/Off the Projector</i>	34	<i>Configurations of Terminals</i>	102
<i>Powering On the Projector</i>	34	<i>Terminal: Computer In (D-sub 15 pin)</i>	102
<i>Powering Off the Projector</i>	35	<i>Terminal: PC Control (D-sub 9 pin)</i>	102
<i>Warning Indicator</i>	35	<i>Terminal: AUDIO IN/ AUDIO OUT</i>	103
<i>Adjusting the Projected Image</i>	36	<i>Specifications</i>	104
<i>Adjusting the Position of Projector Image</i>	36	<i>Cabinet Dimensions</i>	105
<i>Adjusting the Projector's Zoom and Lens Shift</i>	37	<i>Ceiling Mount Installation</i>	107
<i>Adjusting Projection Image Shift</i>	38	<i>Copyrights</i>	108
<i>Lens Shift Range</i>	39	<i>Trademarks</i>	108
<i>Adjusting Projection Image Size</i>	40		
User Settings	46		
<i>Using the On Screen Display (OSD)</i>	46		
<i>How to operate</i>	46		
<i>Picture</i>	47		
<i>Screen</i>	50		
<i>Using Blending function</i>	56		
<i>Settings</i>	59		

Usage Notice

Precautions



Follow all warnings, precautions and maintenance as recommended in this user's guide to maximize the life of your unit.

- **Warning-** **Indicates a potentially hazardous situation which, if instructions are not followed, could result in death or serious injury.**
- **Caution-** **Indicates a potentially hazardous situation which, if instructions are not followed, may result in minor or moderate injury or damage to property.**
- **Warning-** Do not use flammable sprays or solvents in the vicinity of this machine. Also, avoid placing these items in the vicinity of this machine. Doing so could result in fire or electric shock.
- **Warning-** Do not place vases, plant pots, cups, toiletries, medicines, small metal objects, or containers holding water or any other liquids, on or close to this machine. Fire or electric shock could result from spillage or if such objects or substances fall inside this machine.
- **Warning-** Keep the machine and attachments out of the reach of children. If the machine is near children, it may cause injury.
- **Warning-** Plastic bags can be dangerous, please do not leave near babies and young children. To avoid the threat of suffocation, please keep away from their nose and mouth.
- **Warning-** Do not use any power sources other than those that match the specifications shown in this manual. Doing so could result in fire or electric shock.
- **Warning-** Do not damage, break, or modify the power cord. Also, do not place heavy objects on the power cord, or pull the cord or bend it severely. Doing so could result in fire or electric shock.
- **Warning-** Touching the prongs of the power cable's plug with anything metallic constitutes a fire and electric shock hazard.
- **Warning-** The supplied power cord is for use with this machine only. Do not use it with other appliances. Also, do not use power cord other than the one supplied with this

Usage Notice

- Warning- machine. Doing so could result in fire or electric shock.
It is dangerous to handle the power cord plug with wet hands. Doing so could result in electric shock.
- Warning- Be sure to disconnect the plug from the wall outlet at least once a year and check for the following:
 - There are burn marks on the plug.
 - The prongs on the plug are deformed.If any of the above conditions exist, do not use the plug and consult your dealer or service representative. Use of the plug could result in fire or electric shock.
- Warning- Be sure to disconnect the power cord from the wall outlet at least once a year and check for the following:
 - The power cord's inner wires are exposed, broken, etc.
 - The power cord's coating has a crack or dent.
 - When bending the power cord, the power turns off and on.
 - Part of the power cord becomes hot.
 - The power cord is damaged.If any of the above conditions exist, do not use the power cord and consult your dealer or service representative. Use of the power cord could result in fire or electric shock.
- Warning- Do not use the connection cable if it is deformed, cracked, or damaged. Doing so could result in fire or electric shock. If the connection cable is deformed, cracked, or damaged, contact your service representative to request a replacement cable.
- Warning- When using an extension cord or power strip, only connect equipment whose total power consumption is within the power rating for the extension cord or power strip. If the power rating is exceeded, it may cause heat buildup and result in fire.
- Warning- If the machine emits smoke or odours, or if it behaves unusually, you must turn off its power immediately. After turning off the power, be sure to disconnect the power cord plug from the wall outlet. Then contact your service representative and report the problem. Do not use the machine. Doing so could result in fire or electric shock.
- Warning- If metal objects, or water or other fluids fall inside this machine, you must turn off its power immediately.

Usage Notice

- After turning off the power, be sure to disconnect the power cord plug from the wall outlet. Then contact your service representative and report the problem. Do not use the machine. Doing so could result in fire or electric shock.
- Warning- Never operate this unit on AC power during a thunderstorm. If you see lightning or hear thunder, never touch the unit, cables and/or peripherals. An electrical surge caused by the storm, may result in an electric shock or damage to the unit.
 - Warning- If the machine topples, or if a cover or other part gets broken, you must turn off its power immediately. After turning off the power, be sure to disconnect the power cord plug from the wall outlet. Then contact your service representative and report the problem. Do not use the machine. Doing so could result in fire or electric shock.
 - Warning- Never push objects of any kind into this product through openings as they may touch dangerous voltage points or short-out parts that could result in a fire or electric shock. Never spill liquid of any kind on the product.
 - Warning- Do not remove any covers or screws. There are high voltage components inside the machine that may cause electric shock. Contact your service representative if any of the machine's internal components require maintenance, adjustment, or repair.
 - Warning- Do not disassemble or modify the machine. Doing so may cause injury or malfunction.
 - Warning- Installing the Projector on a Wall or Ceiling:
 - a) Do not attempt to clean or replace parts for a machine that is installed in a high location on a wall or ceiling. Doing so may cause it to fall down, resulting in an injury.
 - b) Contact your sales or service representative to clean or replace parts for a machine that is installed on a wall or ceiling.
 - c) If a machine is incorrectly installed on a wall or ceiling, it may fall down and cause an injury. Contact your sales or service representative if you want to install a machine on a wall or ceiling.
 - d) Do not obstruct the machine's vents. Doing so risks fire caused by overheated internal components.
 - e) For users, do not install the projector by yourself.

Usage Notice

Contact your sales or service representative if you want to install the projector on a wall or ceiling.

f) For sales or service representatives:

- Use bracket or ceiling mount that is strong enough to support the projector. RICOH PJ WUL6670/WUL6680/WUL6690 Series weight is approx. 14kg.

- The projector must be installed in a location that is sturdy enough to support the full weight of the projector and brackets. Make sure the screws are tightened.

- Use only the screws (M4 screws). Use all four of the projector's screw holes to attach the brackets.

g) Do not use the projector in oil-mist or smoke environment. Doing so may cause the projector case to crack and fall from its ceiling mount. This may cause serious injury.

- Warning- Do not use lens cap when projector is powered on.
- Caution- Keep the machine away from humidity and dust. Otherwise a fire or an electric shock might occur.
- Caution- Do not place any objects on the machine. Doing so may cause the machine to topple over, possibly resulting in injury.
- Caution- Do not place the machine on an unstable or tilted surface. If it topples over, an injury might occur.
- Caution- Do not place the machine or use it in an environment where it might get wet such as from snow, rain, or being near water. Doing so could result in fire or electric shock.
- Caution- Do not put your face or hand near the exhaust vents. Doing so could result in burns or an accident due to hot air coming from the exhaust vents.
- Caution- Do not use the machine on soft material such as paper or cloth that might get sucked into the intake vents. Doing so may cause heat buildup inside the machine, resulting in malfunction, burns, or fire.
- Caution- Do not place the machine in a location where air flow is poor. Doing so may cause fire due to internal components becoming overheated.
- Caution- Do not place or store the machine in a location where direct sunlight or heat generation might occur. The heat may deform or wear out the exterior parts or negatively affect internal parts. Doing so could result in fire.

Usage Notice

- Caution- Do not place low heat resistant material near the exhaust vents. Hot air may come from the exhaust vents, resulting in damage to the machine or an accident.
- Caution- Do not obstruct the machine's vents. Doing so risks fire caused by overheated internal components.
- Caution- Push the power plug all the way into the power outlet. Do not use a power outlet with a loose connection. Doing so may result in heat buildup. Plug the power cord in the correct direction into the base. If they are not plugged in correctly, it could result in smoke, fire, or electric shock.
- Caution- If this machine is not going to be used for several days or longer at a time, disconnect its power cord from the wall outlet.
- Caution- When disconnecting the power cord from the wall outlet, always pull the plug, not the cord. Pulling the cord can damage the power cord. Use of damaged power cords could result in fire or electric shock.
- Caution- Be sure to disconnect the plug from the wall outlet and clean the prongs and the area around the prongs at least once a year. Allowing dust to build up on the plug constitutes a fire hazard.
- Caution- When performing maintenance on the machine, always disconnect the power cord from the wall outlet.
- Caution- Do not place the power cord and connection cable in a way that might cause someone to trip and fall. The machine might fall over and cause an injury.
- Caution- The machine may be very hot after it is turned off, especially the vents.
- Caution- Do not place the machine on other equipment or vice versa. Doing so may cause heat buildup inside the machine or cause the other equipment to malfunction.
- Caution- Do not increase the volume unless you are listening while increasing the volume. Also, lower the volume before turning off the power, because a loud sound may be emitted when the power is turned on and cause hearing damage.
- Caution- If the machine's interior is not cleaned regularly, dust will accumulate. Fire and breakdown can result from heavy accumulation of dust inside this machine. Contact your sales or service representative for details about and charges for cleaning the machine's interior.

Usage Notice

- Caution- Unplug the power cord from the wall outlet before you move the machine. While moving the machine, take care that the power cord is not damaged under the machine. Failing to take these precautions could result in fire or electric shock.
- Caution- Do not use attachments not recommended by RICOH. Use of an incompatible attachments could cause hazards or damage to the product.
- Caution- Unplug this product from the wall outlet and take the product to qualified service personnel if you encounter any of the following conditions:
 - a) The power supply cord or plug is damaged.
 - b) Liquid has been spilled, or objects have fallen into the product.
 - c) The product has been exposed to rain or water.
 - d) The product does not operate normally when following the operating instructions. Adjust only those controls that are covered by the operating instructions.
 - e) The product has been dropped or damaged in any way. (If the cabinet should break, please handle with care to avoid injury.)
- Caution- This product incorporates glass components, including a lens. If this should break, please handle with care to avoid injury and contact your sales representative for repair service. Avoid any broken pieces of glass since they may cause injury.
- Caution- Do not place anything in front of the lens while the projector is operating. Things placed in front of the lens may overheat and burn or start a fire. If you want to temporarily block the projection, use the “AV mute” function of the remote control.
- Caution- Unauthorized substitutions may result in fire, electric shock, or other hazards.

Upon completion of any service or repairs to this product, ask the service technician to perform safety checks to verify that the product is in proper operating condition.
- Caution- Do not use the product in a closed installation location. Do not place the product in a box or in any other closed installation location. Otherwise it may overheat, which could result in a risk of fire.

Usage Notice

- Caution- Leave more than 1m of space between the intake vent and the partition or more than 1m of space between the exhaust vent and the partition.

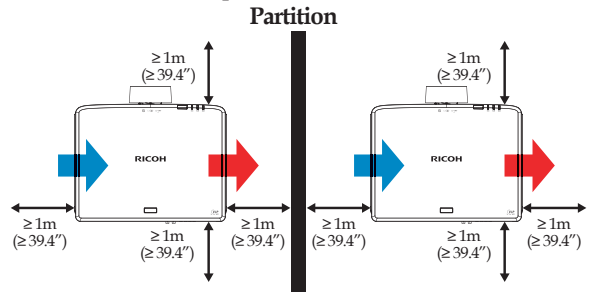

- Caution- For 360° installation, install the projector more than 1m away from the ceiling, the floor and the wall on the left side or on the right side.

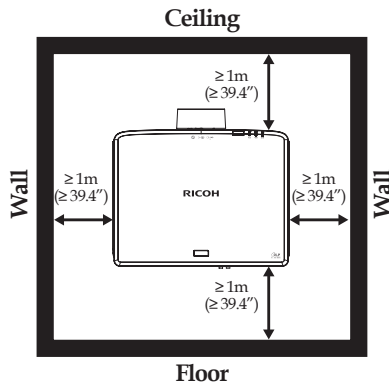

- Caution- When installing the projector on the right side (preferred) or left side, leave a space of at least 1m between the intake vent and the surface or 1m between the exhaust vent and the surface.

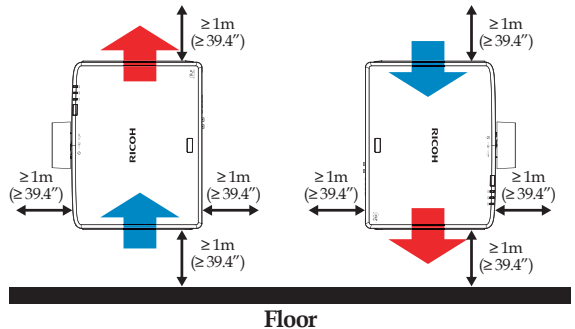

Usage Notice

ABOUT THE LASER LIGHT SOURCE

- Warning- Do not look into the lens or vent when the product is on. The bright light may damage your eyes. Be especially careful in an environment with children.
- Caution- Never allow children to stare into the projector beam at any distance from the projector.
- Caution- Do not start the projector by the remote controller while in front of the lens.
- Caution- Do not use optical aids such as binoculars or telescopes inside the beam.
- Caution- This projector has built-in laser module. Possibly hazardous optical radiation emitted from this product. Do not stare into the beam. May be harmful to the eyes.
- Caution- Use of controls or adjustments or performance of procedures other than those specified herein may result in hazardous radiation exposure.
- Caution- Do not block the projection light when it is on. If you do so, the part that is blocking the projection light may get quite hot and deform, deteriorate or cause a burn or fire. The reflected light may make the lens hot and cause a product failure. To temporarily suspend projection, select the mute function. To suspend longer, turn off the product.

REMOTE CONTROL BATTERY

Warning

- Do not touch the battery directly with bare hands if it leaks.

If the liquid gets into your eyes, do not rub them. It may cause blindness. Immediately wash with clean water and consult a doctor.

- Never throw batteries into a fire.

Using the batteries improperly may cause them to explode or leak and may result in serious injury. Do not touch the liquid leaking from the battery directly with your bare hands. If battery-leaking fluid contacts skin, wash the fluid off immediately with clean water and consult a doctor. If the fluid spills on an instrument, avoid contact and wipe it off using tissue paper. Then dispose of the used tissue paper as flammable garbage after moistening the tissue with water.

- Keep new and used batteries away from children.
If the battery compartment does not close securely, stop using the product and keep it away from children. If you think batteries might have been swallowed or placed inside any part of the body, seek immediate medical attention.
- Do not mix new batteries with used batteries, old batteries, or batteries of different types. Otherwise, fluid leakage may occur.
- Risk of an explosion if battery is replaced by an incorrect type.
- Remove the batteries from the remote control when they are used up. Otherwise, fluid leakage may occur.

Usage Notice

Notes

- Be sure to use AAA (R03) size batteries.
- When storing or disposing of batteries, insulate the terminals with tape or similar material. Do not mix with other batteries or metal objects.
- Dispose of batteries at a designated disposal area and according to local rules.
- Attention should be drawn to the environmental aspects of battery disposal.
- If the remote control does not operate correctly, or if the operating range becomes reduced, replace the batteries.
- Avoid contact with water or liquid.
- Do not expose the remote control to moisture or heat.
- Do not drop the remote control.
- If the batteries have leaked in the remote control, carefully wipe the case clean and install new batteries.
- Remove batteries from remote control when not using for extended periods.
- The remote control may fail to operate if the infrared remote sensor is exposed to bright sunlight or fluorescent lighting.

Important:

Contents of this manual are subject to change without prior notice. In no event will the company be liable for direct, indirect, special, incidental, or consequential damages as a result of handing or operating this product.

Safety Labels of This Machine

1. Do not look into the lens while the light source is on. The strong light from the light source may cause damage to your eyesight.
2. Do not place anything in front of the lens while the projector is operating. Things placed in front of the lens may overheat and burn or start a fire. If you want to temporarily stop the projected image, use the AV mute on the remote control.
3. Laser aperture warning:
 - CLASS 1 LASER PRODUCT - RISK GROUP 2 IEC62471-5:2015
 - Do not stare into the beam, maybe harmful to the eyes.
 - Do not look into the light source light using optical instruments (such as magnifying glasses and mirrors). Visual impairment could result.
 - When turning on the projector, make sure no one within projection range is looking at the lens.

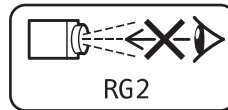

- Keep any items (magnifying glass etc.) out of the light path of the projector. The light path being projected from the lens is extensive, therefore any kind of abnormal objects that can redirect light coming out of the lens, can cause an unpredictable outcome such as a fire or injury to the eyes.
 - Do not remove any screws. Do not block or cover the vents.
4. Do not remove any screws. Do not block or cover the vents.
 5. **WARNING: MOUNT ABOVE THE HEADS OF CHILDREN.** (For USA and Canada only)
The use of a ceiling mount is recommended with this product to place it above the eyes of children.

Usage Notice

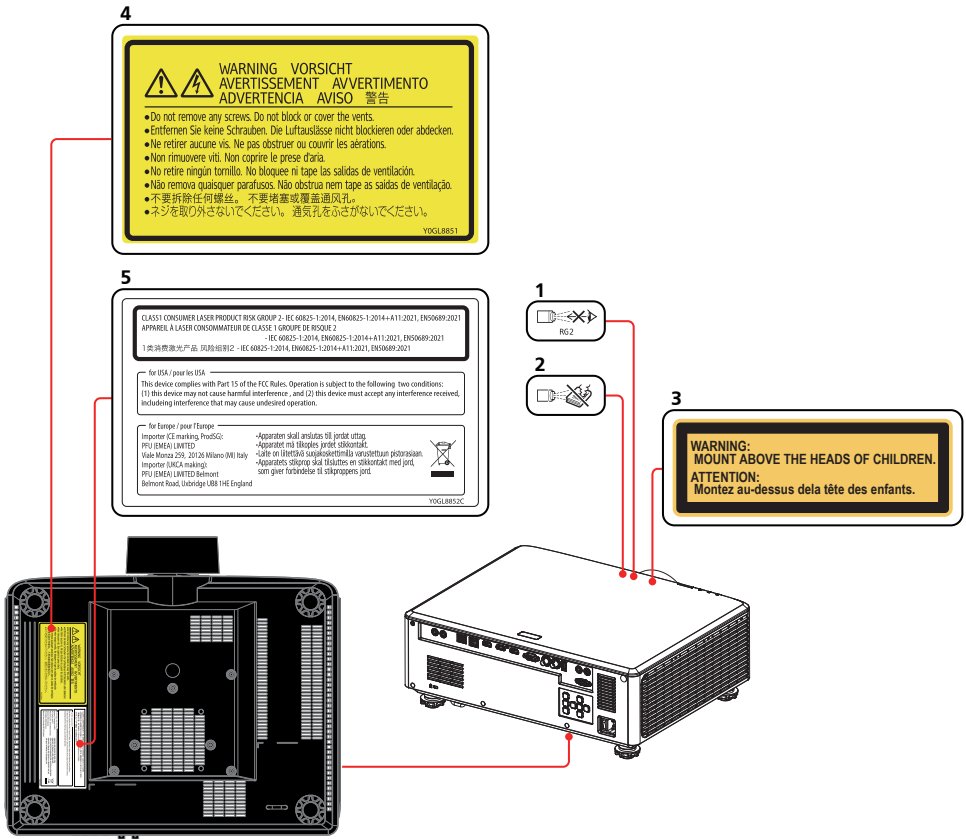

Power Switch Symbols

The meaning of the symbols for the switches on this machine as follows:

 On/Standby (Off)

Usage Notice

Regulation & Safety Notices

This appendix lists the general notices of your Projector.

Notice: Users in the United States of America FCC notice

MODEL NAME: RICOH PJ WUL6670/WUL6680/WUL6690

TRADE NAME: PROJECTOR MODEL NAME: RICOH PJ WUL6670/WUL6680/WUL6690 Tested To Comply With FCC Standards FOR HOME OR OFFICE USE

This device complies with Part 15 of the FCC Rules. Operation is subject to the following two conditions:

1. This device may not cause harmful interference and
2. This device must accept any interference received, including interference that may cause undesired operation.

NOTE: This equipment has been tested and found to comply with the limits for a Class A digital device, pursuant to Part 15 of the FCC Rules. These limits are designed to provide reasonable protection against harmful interference when the equipment is operated in a commercial environment. This equipment generates, uses, and can radiate radio frequency energy and, if not installed and used in accordance with the instruction manual, may cause harmful interference to radio communications. Operation of this equipment in a residential area is likely to cause harmful interference in which case the user will be required to correct the interference at his own expense.

- **Caution-** Changes or modifications not expressly approved by the party responsible for compliance could void the user's authority to operate the equipment.

Usage Notice

RESPONSIBLE PARTY: PFU America, Inc.
3900 Freedom Circle, Suite 240, Santa Clara, CA 95054
Telephone number: (408)992-2900

Notice: Shielded cables

All connections to other computing devices must be made using shielded cables to maintain compliance with FCC regulations.

Caution

Changes or modifications not expressly approved by the manufacturer could void the user's authority, which is granted by the Federal Communications Commission, to operate this projector.

Notes to Users in the State of California

Perchlorate Material - special handling may apply, See www.dtsc.ca.gov/hazardouswaste/perchlorate.

Notes to Users in Canada

The Class A digital apparatus meets all requirements of the Canadian Interference-Causing Equipment Regulation. Interference-Causing Equipment Regulation.

Usage Notice

Declaration of Conformity for EU countries

- EMC Directive 2014/30/EU (including amendments)
- Low Voltage Directive 2014/35/EU

Notice: Users in EU countries

CE Marking Traceability Information (For EU Countries Only)

Manufacturer:

Ricoh Co., Ltd.

3-6 Nakamagome 1-chome, Ohta-ku, Tokyo. 143-8555,
Japan

Importer:

PFU (EMEA) LIMITED Viale Monza 259, 20126 Milano
(MI) Italy

Notice: Users in UK

UKCA Marking Traceability Information (For UK Only)

Manufacturer:

Ricoh Co., Ltd.

3-6 Nakamagome 1-chome, Ohta-ku, Tokyo. 143-8555,
Japan

Importer:

PFU (EMEA) LIMITED Belmont, Belmont Road, Uxbridge
UB8 1HE England

User Information on Electrical and

Electronic Equipment

Users in the countries where this symbol shown in this section has been specified in national law on collection and treatment of E-waste.

Usage Notice

Our Products contain high quality components and are designed to facilitate recycling.
Our products or product packaging are marked with the symbol below.



This product contains substances which are harmful to humans and the environment.

The symbol indicates that the product must not be treated as municipal waste. It must be disposed of separately via the appropriate return and collection systems available. By following these instructions you ensure that this product is treated correctly and help to reduce potential impacts on the environment and human health, which could otherwise result from inappropriate handling. Recycling of products helps to conserve natural resources and protect the environment.

For more detailed information on collection and recycling systems for this product, please contact the shop where you purchased it, your local dealer or sales/service representatives.

Notice: Users in Turkey

AEEE Yönetmeliğine Uygundur.

Bu sistem sarf malzemeleri ve yedek parçaları da dahil olmak üzere AEEE Yönetmeliğine Uygundur.

All Other Users

If you wish to discard this product, please contact your local authorities, the shop where you bought this product, your local dealer or sales/service representatives.

Laser Notice

IEC 60825-1:2014, EN 60825-1:2014+A11:2021: CLASS 1 LASER PRODUCT - RISK GROUP 2.

The product's intended use as a consumer laser product and compliant with EN 50689:2021.

CLASS 1 CONSUMER LASER PRODUCT
EN 50689:2021

Usage Notice

Warning

This equipment is compliant with Class A of CISPR 32. In a residential environment this equipment may cause radio interference.

Properly shielded and grounded cables and connectors must be used for connections to a host computer (and/or peripheral) in order to meet emission limits.

Usage Notice

Notice: Users in the EU and the UK

Note for the Battery and/or Accumulator Symbol



In accordance with the Battery Directive 2006/66/EC Article 20 Information for end-users Annex II, the above symbol is printed on batteries and accumulators. This symbol means that in the European Union, used batteries and accumulators should be disposed of separately from your household waste. In the EU, there are separate collection systems for not only used electrical and electronic products but also batteries and accumulators. Please dispose of them correctly at your local community waste collection/recycling centre.

COMMISSION REGULATION (EU) 2019/2020

The light source of this product is not intended for applications other than image projection.

Other Information

Copyrights to Images

When projecting images using the projector, be careful not to infringe the copyright of protected materials. The following are examples that may infringe the copyright of protected materials.

- Broadcasting images or movies for commercial purposes
- Modifying images or movies using functions such as freeze, magnify, or zoom to broadcast images for commercial purposes or public viewing
- Varying the aspect ratio of images or movies using a function that changes the screen size to broadcast images for commercial purposes or public viewing

Note to Users Viewing 3D Images

Pay attention to the following points when viewing images using 3D glasses with projector:

- How 3D images are viewed may vary according to the individual.
- Do not use 3D glasses for viewing any material other than 3D images.
- Before viewing 3D images, make sure to read the manuals provided with your 3D glasses and 3D compatible content.
- Avoid viewing 3D images for a long period of time. Take a break of 15 minutes or longer after every hour of viewing.
- If you feel sick while viewing 3D images, stop viewing them. If you continue to feel sick, consult a doctor.
- When viewing 3D image in a room where on LED lighting system or fluorescent lights are used, you may feel that the light in the room flickers. If this is the case, dim the lights until you do not notice any flickers, or turn off the lights.
- If you or any member of your family has a history of light-sensitive seizures, consult a doctor before viewing 3D images.

Package Overview

This projector comes with all the items shown below. Check to make sure your unit is complete. Contact your dealer immediately if anything is missing.

Note

- ❖ Due to the difference in applications for each country, some regions may have different accessories.
 - ❖ Models for Europe are packed with two different power codes, one for EU and one for UK.
 - ❖ Use the EU power cord in the EU, and the UK power cord in the UK.
- Do not use the excess power cord for other purposes.

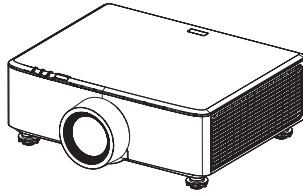

Projector



Remote Control
with Batteries, see
page 10

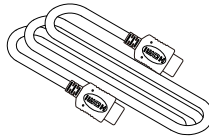

HDMI Cable (1.8m)

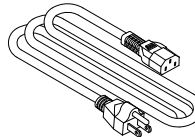

Power Cord (1.8m)

Documentation:

- Read This First

Introduction

Product Overview

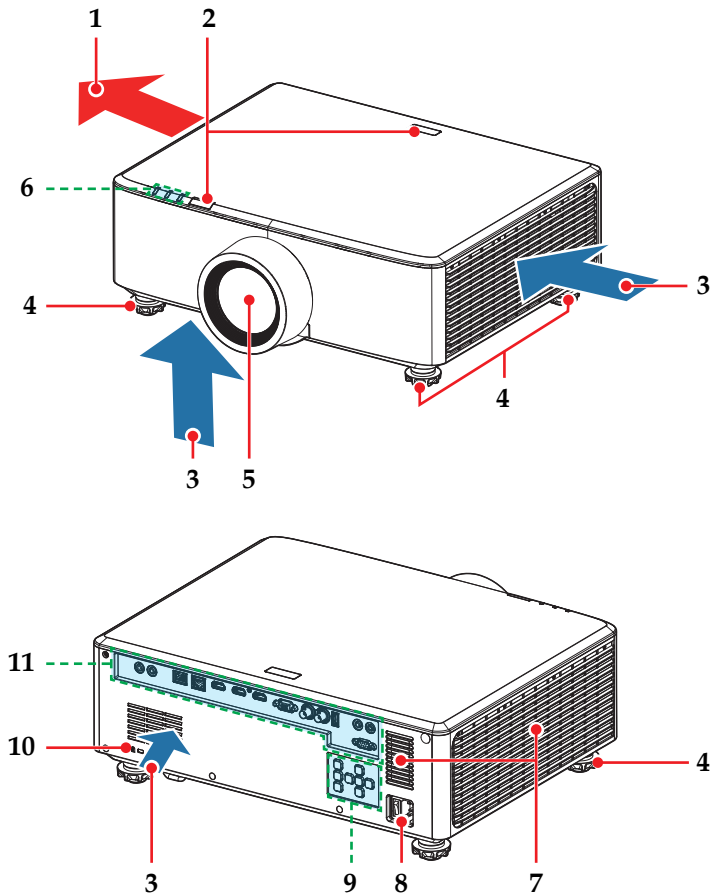

- | | |
|-------------------------|--|
| 1. Ventilation (outlet) | 7. Speakers |
| 2. Remote receiver | 8. AC In socket/Power Switch |
| 3. Ventilation (inlet) | 9. Control panel |
| 4. Adjustable feet | 10. Anti-theft lock hole
(Kensington™ lock) |
| 5. Lens | 11. Connection ports |
| 6. Indicators | |

Introduction

Connection Ports

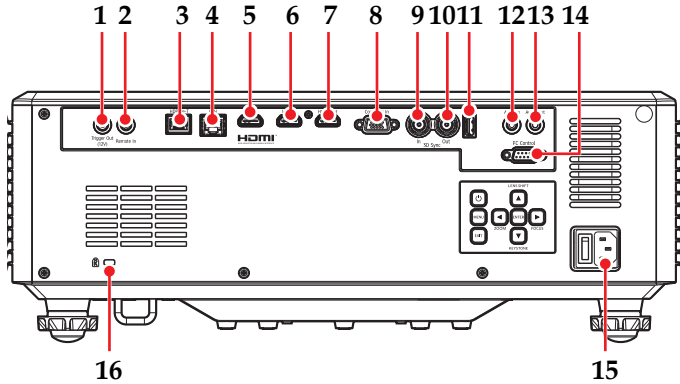

Note

❖ HDMI 1 supports v2.0 HDCP2.2 and HDMI 2 supports v1.4 HDCP1.4

- | | |
|----------------------------|--|
| 1. Screen Trigger terminal | 10. 3D Sync Out terminal |
| 2. Remote In terminal | 11. DC 5V/1.5A terminal |
| 3. HDBaseT terminal | 12. Audio In terminal |
| 4. LAN terminal | 13. Audio Out terminal |
| 5. HDMI 2 terminal | 14. PC Control terminal |
| 6. HDMI 1 terminal | 15. AC In socket |
| 7. HDMI Out terminal | 16. Anti-theft lock hole
(Kensington™ lock) |
| 8. Computer In terminal | |
| 9. 3D Sync In terminal | |

Introduction

Control Panel

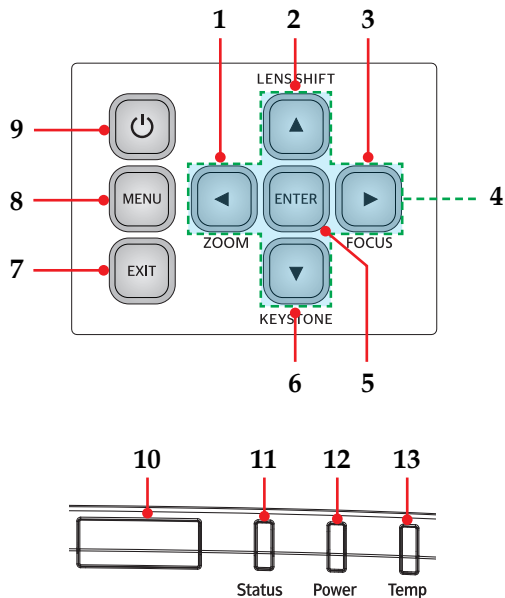

1	ZOOM	Adjust zoom.
2	LENS SHIFT	Adjust the lens vertical or horizontal offset setting.
3	FOCUS	Adjust focus.
4	Four Directional Select Keys	Use ▲, ▼, ◀, or ▶ to select items or make adjustments to your selection.
5	ENTER	Select or confirm settings.
6	KEYSTONE	Adjust keystone.
7	EXIT	Press "EXIT" to return to the previous screen.

Introduction

8	MENU	Press “MENU” to launch the on screen display (OSD), or exit the OSD menu. (See page 46)
9	Power	Refer to the “Power On/Off the Projector” section. (pages 34~35)
10	IR receiver	Receive signals from the remote controller. Keep the signal path clear between the receiver and the remote controller.
11	Status indicator	Indicate the projector’s status.
12	Power indicator	(See pages 88-89).
13	Temp indicator	

Remote Control

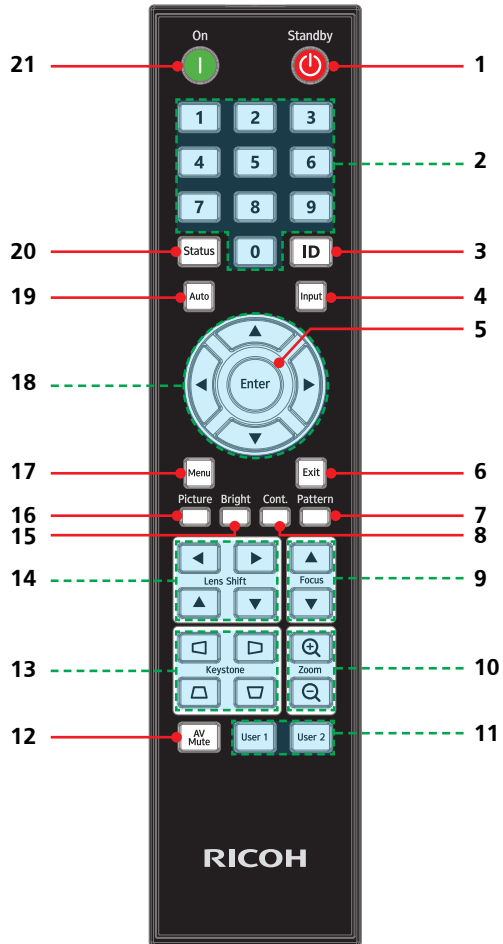

The meaning of the symbols for the switches on this machine are as follows:

1 Standby

: Standby

Refer to the "Power On/Off the Projector" section. (See pages 34~35)

Introduction

2	Number (0~9)	Input numbers.
3	ID	Change ID setting of remote control. (See page 28)
4	Input	Press "Input" to choose your desired input source.
5	Enter	Confirm your section of items in sub menu operation.
6	Exit	Press "Exit" to return to the previous screen.
7	Pattern	Display test pattern.
8	Cont.	Use this function to choose your desired contrast.
9	Focus	Use ▲ and ▼ to adjust the image focus.
10	Zoom	Zoom in ⊕/out ⊖ the projector display. Magnified area can be moved after pressing "Enter" key.
11	User 1/2	Performs the function assigned in the OSD menu. (See page 65)
12	AV Mute	Momentarily turn off/on the audio and video.
13	Keystone	Use ◀ and ▶ to adjust the image shape horizontally or use ▴ and ▾ to adjust the image position vertically.
14	Lens Shift	Use ◀ and ▶ to adjust the image position horizontally or use ▲ and ▼ to adjust the image position vertically.
15	Bright	Use this function to choose your desired brightness.
16	Picture	Select the preferred picture mode.
17	Menu	Press "Menu" to launch the On Screen Display (OSD) or exit the OSD menu. (See page 46)
18	Four Directional Select Keys	Use ▲, ▼, ◀, or ▶ to select items or make adjustments to your selection.

Introduction

19	Auto	Automatically synchronize the projector to the input source.
20	Status	Display menu "Display Status".
21	Power	 : On Refer to the "Power On/Off the Projector" section. (See pages 34~35)

Remote Control ID Setup

The IR remote allows individual addressing of projectors. The projector can be set with a specific number from "1" to "99" as its address, and it only responds to the IR remote set to the same ID code. ID code "0" is the default value of the IR remote, and all projectors will respond to the IR remote set to "0".

Follow below methods to set up the IR remote:

ID Code	Change Method
1	Press "ID" for 3 seconds, when the backlight turns on, hold "ID" and press "0", then "1".
2	Press "ID" for 3 seconds, when the backlight turns on, hold "ID" and press "0", then "2".
3	Press "ID" for 3 seconds, when the backlight turns on, hold "ID" and press "0", then "3".
...	...
10	Press "ID" for 3 seconds, when the backlight turns on, hold "ID" and press "1", then "0".
11	Press "ID" for 3 seconds, when the backlight turns on, hold "ID" and press "1", then "1".
...	...
98	Press "ID" for 3 seconds, when the backlight turns on, hold "ID" and press "9", then "8".
99	Press "ID" for 3 seconds, when the backlight turns on, hold "ID" and press "9", then "9".

To have the IR remote return to the default state where all projectors can be controlled, press "ID" for "3" seconds, when the backlight turns on, hold "ID" and press "0", then "0".

Remote Control Battery Installation

The figure below shows the procedure for installing the battery. To remove the battery, reverse the procedure.

- 1** Remove the battery cover on the back of the remote control.
- 2** Install new batteries (AAA/R03). Ensure that you have the batteries' polarity (+/-) aligned correctly.
- 3** Close the battery cover and press it down until it clicks into place. Do not mix different types of batteries or new and old batteries.

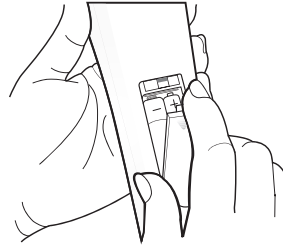
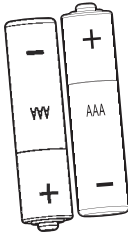

To ensure safe operation, please observe the following precautions :

- Use AAA/R03 type battery.
- Avoid contact with water or liquid.
- Do not expose the remote control to moisture or heat.
- Do not drop the remote control.
- If the battery has leaked in the remote control, carefully wipe the case clean and install new battery.
- Risk of an explosion if battery is replaced by an incorrect type.
- Dispose of used battery according to the instructions.
- Remove batteries from remote control when not using for extended periods.
- The remote control may fail to operate if the infrared remote sensor is exposed to bright sunlight or fluorescent lighting.

Remote Control Operating Range

Point the remote control toward the projector (Remote Receiver) when pressing any button.

Maximum operating range for the remote control is about 6m and $\pm 30^\circ$ in front and top of the projector.

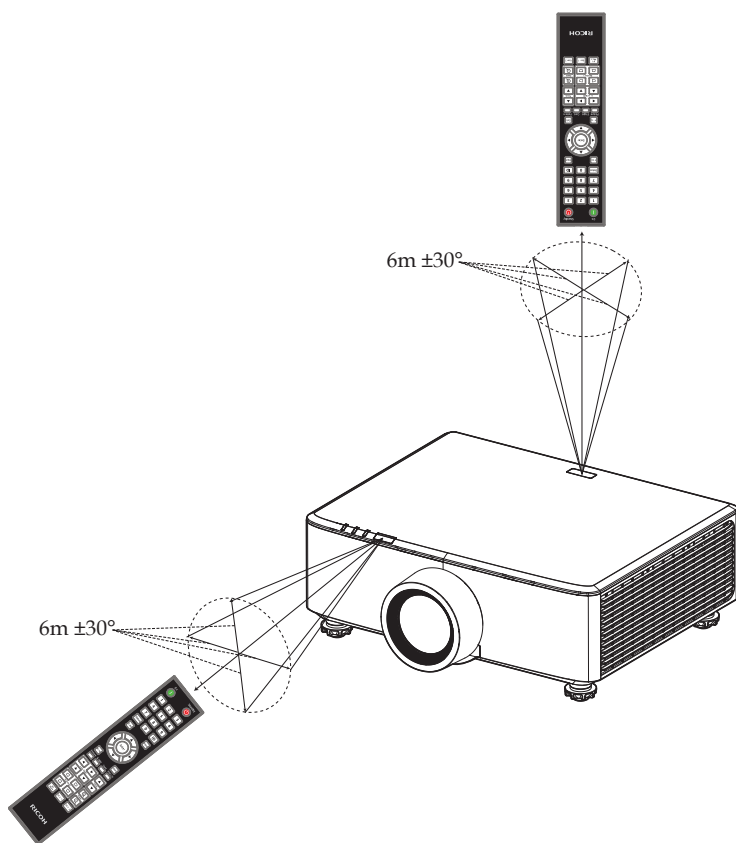

Installing the Projector

When you select a position for the projector, consider the size and shape of your screen, the location of your power outlets, and the distance between the projector and the rest of your equipment. Follow these general guidelines:

- ❖ Position the projector on a flat surface at a right angle to the screen.
- ❖ Position the projector to the desired distance from the screen. The distance from the lens of the projector to the screen, the zoom setting, and the video format determine the size of the projected image.
- ❖ When using a LAN, use the network separated by a firewall to prevent unauthorized access from the Internet.
- ❖ Pay careful attention to the installation location, management of the devices, and the network device to which the device is connected in order to prevent malicious third parties from viewing the communication data.
- ❖ 360 degree free orientation operation:

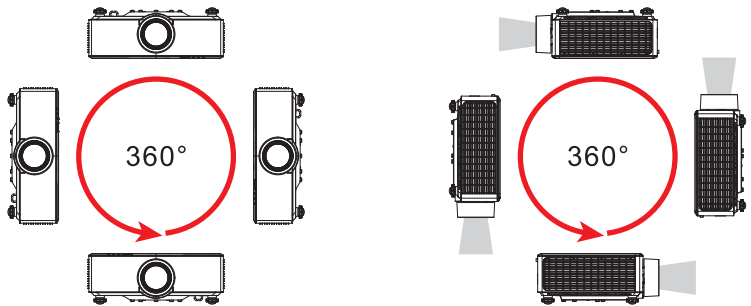

Basic Operations

Connecting the Projector

Connect to Computer/Notebook

Note

- ❖ Make sure that the power plug is fully inserted into both the projector AC inlet and the wall outlet.
- ❖ The AC outlet must be near this equipment and must be easily accessible.
- ❖ When HDMI input is selected, only audio signal with HDMI can be output.
- ❖ When Audio Out is connected, Built-in speaker doesn't sound.
- ❖ To ensure the projector works well with your computer, please make sure the timing of the display mode is compatible with your projector. (Refer to "List of Compatible Signals")
- ❖ Use the cables that come with the projector. (*)

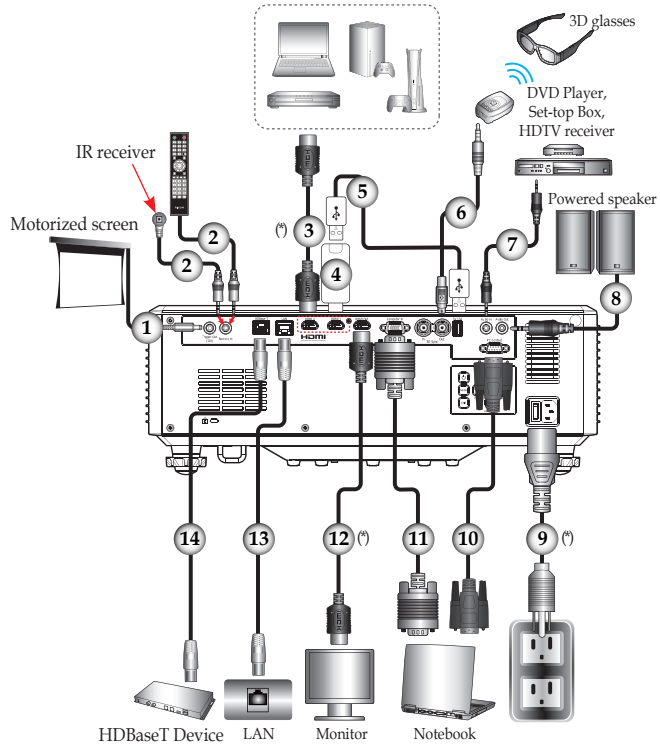

1.....Screen Trigger cable	8.....Audio cable
2.....Wired remote control cable or IR receiver cable (3.5mm TRS type)	9.....Power cord (supplied)
3.....HDMI cable (supplied)	10.....Serial cable (crossover)
4.....HDMI dongle	11.....VGA cable
5.....USB cable	12.....HDMI cable (supplied)
6.....3D Emitter cable	13.....LAN cable
7.....Audio cable	14.....LAN cable (cat.5e or above)

Connecting HDBaseT

The HDBaseT connection facilitates communication of uncompressed HD multimedia contents. Using an HDBaseT transmitter (sold separately) makes it possible to connect multiple signals to the unit over an HDBaseT connection.

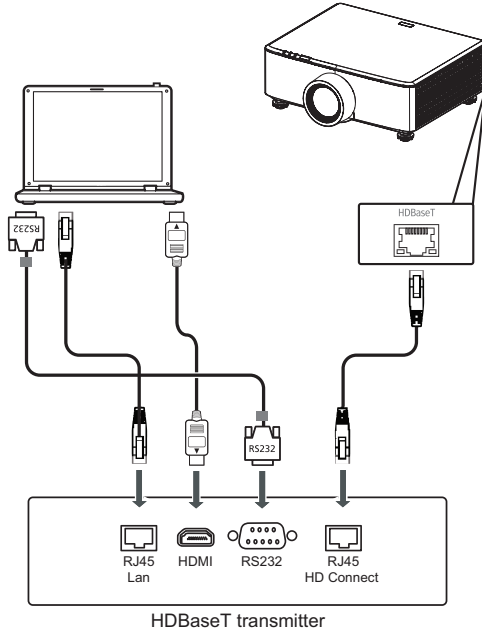

Note



❖ The illustration is for reference purpose only, and actual layout may vary.

- ❖ Use a shielded LAN cable of CAT5e or better, with a length of up to 100 meters.
- ❖ Although the maximum communication distance is specified as 100 meters, it may be shorter for practical purposes in some cases.
- ❖ Refrain from using LAN cables that are coiled or bundled.
- ❖ Removing the LAN cable from the unit while images are being projected can cause noise in some cases.
- ❖ Not all HDBaseT transmitters that are available on the market are guaranteed to connect properly with the unit.
- ❖ Proper projection may not be possible with some HDBaseT transmitters.

Basic Operations

Powering On/Off the Projector

Powering On the Projector

1. Ensure that the power cord and signal cable are securely connected. The Power indicator will turn red.
2. Turn on the projector by pressing the  button on the control panel or the  button on the remote control. The Power indicator will flash red.
The startup screen will display and the Power indicator will turn green.
3. Turn on your source (computer, notebook, video player, etc.). The projector will detect your source automatically. Make sure that the "Auto Source" has been set to "On".

Note

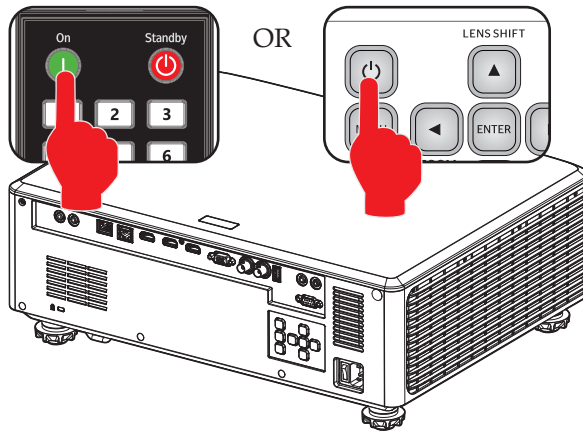

- ❖ If you connect multiple sources at the same time, press "Input" on the remote control to switch inputs.
- ❖ Turn on the projector first and then the signal sources.







CAUTION:

- Do not look into the lens while the laser is on. The strong light from the laser may cause damage to your eyesight.
- Do not block the air intake or exhaust. Doing so could cause a fire due to internal overheating.
- Do not place your hands, face, or other objects near the air exhaust, or the bottom of the unit. Doing so could result in injury and/or damage the object.

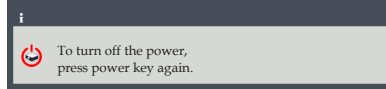
Powering Off the Projector

1. Press the  button on the control panel or the  button on the remote control and you will see a message as below on the on-screen display.



2. Press the  button on the control panel or the  button on the remote control to turn off the projector. If you do not press the  button again, the warning message will disappear after 5 seconds.
3. The cooling fan continues to operate for about 20 seconds for cooling cycle and the Power indicator will flash green. After cooling down, the Status indicator will stop flashing, the Power indicator will turn red, and the projector will enter the standby mode.
4. Disconnect the power cord from the electrical outlet of the projector.

Warning Indicator

- ❖ When the Temp indicator lights red, it indicates the projector has overheated. The projector will automatically shut itself down.



- ❖ When the Temp indicator flashes red and the Power / Status indicator lights red and the message below displays, it indicates the cooling fan failed. Stop using the projector and disconnect the power cord from the electrical outlet, then contact your local dealer or our service center.

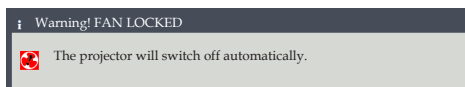

Adjusting the Projected Image

Adjusting the Position of Projector Image

The projector is equipped with rear and front adjustable feet to raise and lower the image to fill the screen.

1. Locate the adjustable foot you wish to modify on the underside of the projector.
2. Rotate the adjustable ring clockwise to raise the projector or counter clockwise to lower it. Repeat with the remaining feet as necessary.

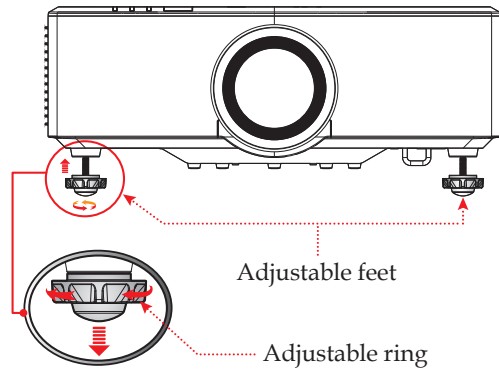

Note

❖ The projector is equipped with elevator feet for adjusting the image height. The maximum length of the feet is 13 mm (0.5 inches). The tilt angle is up to 2.5° .

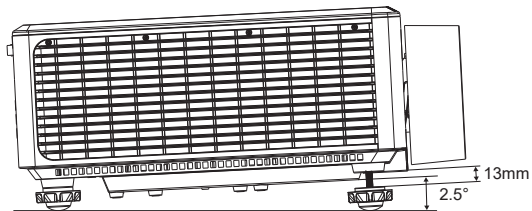

Basic Operations

Adjusting the Projector's Zoom and Lens Shift

Adjusting the Projector's Zoom / Focus is driven by electric motor, please use the remote / Keypad to adjust zoom scales, and focus until the image is clear.

Note

❖ Since the optical system is unstable after the power is turned on, wait around 30 minutes before adjusting.

CAUTION:

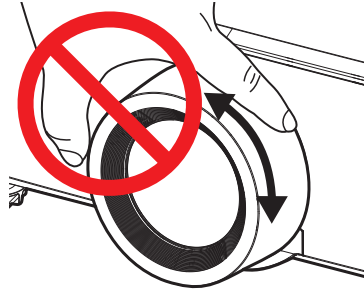

- Do not forcibly move the focus ring by hand. Doing so may cause malfunction or failure.

Basic Operations

Adjusting Projection Image Shift

The projection lens can be moved up, down, right, and left with the motor-driven lens shift function. This function makes the positioning of images easy on the screen. Lens shift is generally expressed as a percentage of the image height or width, see below illustration.

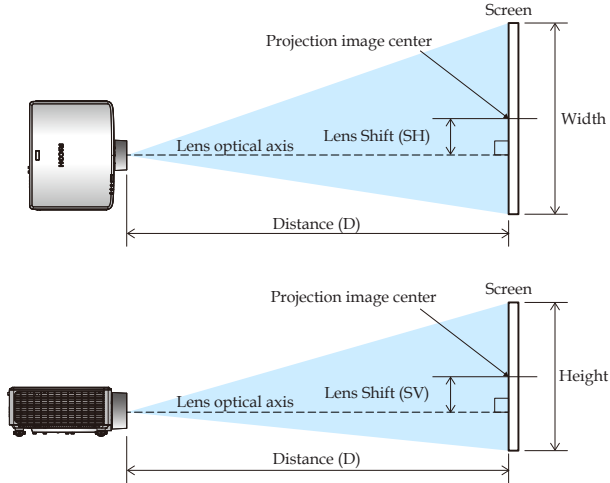

Note

❖ Distance (D) is the distance from the tip of the lens to the screen.

Shifting the lens vertically changes the range that can be shifted horizontally. For details, see "Lens Shift Range" (page 39).

Basic Operations

Lens Shift Range

WUXGA	Lens Shift Range			
	ΔH	ΔV	ΔH_0	ΔV_0
RICOH PJ WUL6670	25%	55%	5%	15%
RICOH PJ WUL6680				
RICOH PJ WUL6690				

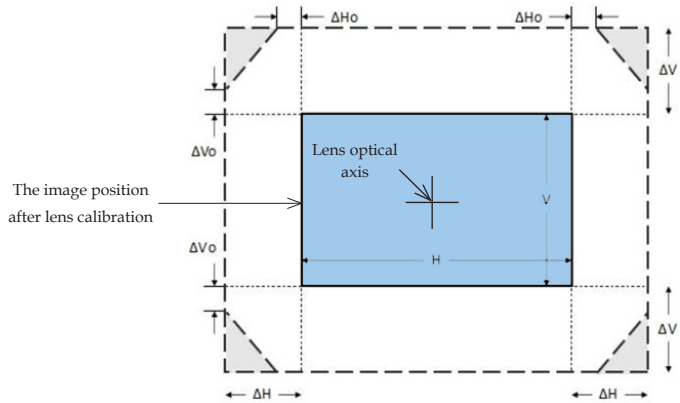

The symbols in the table and illustration have the following meaning:

- ▶ ΔH : The lens shift range in horizontal direction when the lens is at the center.
- ▶ ΔV : The lens shift range in vertical direction when the lens is at the center.
- ▶ ΔH_0 : The lens shift range without vignetting in horizontal direction when the lens is at the top center or the bottom center.
- ▶ ΔV_0 : The lens shift range without vignetting in vertical direction when the lens is at the middle right or the middle left.

Basic Operations

Adjusting Projection Image Size

Projection Image Size (Diagonal) for WUL6670:

▶ Aspect ratio = 16:10

Projection Image Size (Diagonal)			Distance (D)		Max. Lens shift (SV)	
(inch)	Width H (m)	Height V (m)	Min (m)	Max (m)	Upper (m)	Lower (m)
40	0.86	0.54	1.03	1.30	0.30	0.30
50	1.08	0.67	1.30	1.63	0.37	0.37
60	1.29	0.81	1.56	1.97	0.44	0.44
70	1.51	0.94	1.83	2.30	0.52	0.52
80	1.72	1.08	2.09	2.63	0.59	0.59
90	1.94	1.21	2.36	2.97	0.67	0.67
100	2.15	1.35	2.63	3.30	0.74	0.74
110	2.37	1.48	2.89	3.63	0.81	0.81
120	2.58	1.62	3.16	3.97	0.89	0.89
130	2.80	1.75	3.43	4.30	0.96	0.96
140	3.02	1.88	3.69	4.63	1.04	1.04
150	3.23	2.02	3.96	4.96	1.11	1.11
160	3.45	2.15	4.22	5.30	1.18	1.18
170	3.66	2.29	4.49	5.63	1.26	1.26
180	3.88	2.42	4.76	5.96	1.33	1.33
200	4.31	2.69	5.29	6.63	1.48	1.48
250	5.38	3.37	6.62	8.30	1.85	1.85
300	6.46	4.04	7.95	9.96	2.22	2.22

Basic Operations

► Aspect ratio = 4:3

Projection Image Size (Diagonal)			Distance (D)		Max. Lens shift (SV)	
(inch)	Width H (m)	Height V (m)	Min (m)	Max (m)	Upper (m)	Lower (m)
40	0.81	0.61	1.17	1.47	0.34	0.34
50	1.02	0.76	1.47	1.85	0.42	0.42
60	1.22	0.91	1.77	2.23	0.50	0.50
70	1.42	1.07	2.07	2.60	0.59	0.59
80	1.63	1.22	2.37	2.98	0.67	0.67
90	1.83	1.37	2.67	3.36	0.75	0.75
100	2.03	1.52	2.98	3.74	0.84	0.84
110	2.24	1.68	3.28	4.11	0.92	0.92
120	2.44	1.83	3.58	4.49	1.01	1.01
130	2.64	1.98	3.88	4.87	1.09	1.09
140	2.84	2.13	4.18	5.24	1.17	1.17
150	3.05	2.29	4.48	5.62	1.26	1.26
160	3.25	2.44	4.78	6.00	1.34	1.34
170	3.45	2.59	5.08	6.38	1.42	1.42
180	3.66	2.74	5.39	6.75	1.51	1.51
200	4.06	3.05	5.99	7.51	1.68	1.68
250	5.08	3.81	7.50	9.39	2.10	2.10
300	6.10	4.57	9.00	11.28	2.51	2.51

Basic Operations

▶ Aspect ratio = 16:9

Projection Image Size (Diagonal)			Distance (D)		Max. Lens shift (SV)	
(inch)	Width H (m)	Height V (m)	Min (m)	Max (m)	Upper (m)	Lower (m)
40	0.89	0.50	1.06	1.34	0.30	0.30
50	1.11	0.62	1.33	1.68	0.38	0.38
60	1.33	0.75	1.61	2.02	0.46	0.46
70	1.55	0.87	1.88	2.36	0.53	0.53
80	1.77	1.00	2.15	2.71	0.61	0.61
90	1.99	1.12	2.43	3.05	0.68	0.68
100	2.21	1.25	2.70	3.39	0.76	0.76
110	2.44	1.37	2.97	3.73	0.84	0.84
120	2.66	1.49	3.25	4.08	0.91	0.91
130	2.88	1.62	3.52	4.42	0.99	0.99
140	3.10	1.74	3.80	4.76	1.07	1.07
150	3.32	1.87	4.07	5.10	1.14	1.14
160	3.54	1.99	4.34	5.45	1.22	1.22
170	3.76	2.12	4.62	5.79	1.29	1.29
180	3.98	2.24	4.89	6.13	1.37	1.37
200	4.43	2.49	5.44	6.82	1.52	1.52
250	5.53	3.11	6.80	8.53	1.90	1.90
300	6.64	3.74	8.17	10.24	2.28	2.28

Note

- ❖ Vertical lens shift range ($\Delta V1/V$) is 0~55%.
- ❖ Horizontal lens shift range ($\Delta V1/H$) is 0~25%.
- ❖ When horizontal and vertical lens shifts are performed simultaneously, the corners of the screen may become dark (vignetting).
For conditions under which vignetting does not occur, see "Lens Shift Range" (page 39).

Basic Operations

Projection Image Size (Diagonal) for WUL6680/WUL6690

▶ Aspect ratio = 16:10

Projection Image Size (Diagonal)			Distance (D)		Max. Lens shift (SV)	
(inch)	Width H (m)	Height V (m)	Min (m)	Max (m)	Upper (m)	Lower (m)
30	0.65	0.40	0.77	1.26	0.22	0.22
40	0.86	0.54	1.05	1.70	0.30	0.30
50	1.08	0.67	1.33	2.14	0.37	0.37
60	1.29	0.81	1.60	2.57	0.44	0.44
70	1.51	0.94	1.88	3.01	0.52	0.52
80	1.72	1.08	2.15	3.45	0.59	0.59
90	1.94	1.21	2.43	3.88	0.67	0.67
100	2.15	1.35	2.70	4.32	0.74	0.74
110	2.37	1.48	2.98	4.76	0.81	0.81
120	2.58	1.62	3.26	5.19	0.89	0.89
130	2.80	1.75	3.53	5.63	0.96	0.96
140	3.02	1.88	3.81	6.07	1.04	1.04
150	3.23	2.02	4.08	6.51	1.11	1.11
160	3.45	2.15	4.36	6.94	1.18	1.18
170	3.66	2.29	4.64	7.38	1.26	1.26
180	3.88	2.42	4.91	7.82	1.33	1.33
190	4.09	2.56	5.19	8.25	1.41	1.41
200	4.31	2.69	5.46	8.69	1.48	1.48
250	5.38	3.37	6.84	10.87	1.85	1.85
300	6.46	4.04	8.22	13.06	2.22	2.22

Basic Operations

► Aspect ratio = 4:3

Projection Image Size (Diagonal)			Distance (D)		Max. Lens shift (SV)	
(inch)	Width H (m)	Height V (m)	Min (m)	Max (m)	Upper (m)	Lower (m)
30	0.61	0.46	0.88	1.43	0.25	0.25
40	0.81	0.61	1.19	1.93	0.34	0.34
50	1.02	0.76	1.50	2.42	0.42	0.42
60	1.22	0.91	1.81	2.91	0.50	0.50
70	1.42	1.07	2.13	3.41	0.59	0.59
80	1.63	1.22	2.44	3.90	0.67	0.67
90	1.83	1.37	2.75	4.40	0.75	0.75
100	2.03	1.52	3.06	4.89	0.84	0.84
110	2.24	1.68	3.38	5.39	0.92	0.92
120	2.44	1.83	3.69	5.88	1.01	1.01
130	2.64	1.98	4.00	6.38	1.09	1.09
140	2.84	2.13	4.31	6.87	1.17	1.17
150	3.05	2.29	4.62	7.37	1.26	1.26
160	3.25	2.44	4.94	7.86	1.34	1.34
170	3.45	2.59	5.25	8.36	1.42	1.42
180	3.66	2.74	5.56	8.85	1.51	1.51
190	3.86	2.90	5.87	9.34	1.59	1.59
200	4.06	3.05	6.19	9.84	1.68	1.68
250	5.08	3.81	7.75	12.31	2.10	2.10
300	6.10	4.57	9.31	14.78	2.51	2.51

Basic Operations

▶ Aspect ratio = 16:9

Projection Image Size (Diagonal)			Distance (D)		Max. Lens shift (SV)	
(inch)	Width H (m)	Height V (m)	Min (m)	Max (m)	Upper (m)	Lower (m)
30	0.66	0.37	0.80	1.30	0.23	0.23
40	0.89	0.50	1.08	1.75	0.30	0.30
50	1.11	0.62	1.36	2.20	0.38	0.38
60	1.33	0.75	1.65	2.65	0.46	0.46
70	1.55	0.87	1.93	3.10	0.53	0.53
80	1.77	1.00	2.21	3.54	0.61	0.61
90	1.99	1.12	2.50	3.99	0.68	0.68
100	2.21	1.25	2.78	4.44	0.76	0.76
110	2.44	1.37	3.07	4.89	0.84	0.84
120	2.66	1.49	3.35	5.34	0.91	0.91
130	2.88	1.62	3.63	5.79	0.99	0.99
140	3.10	1.74	3.92	6.24	1.07	1.07
150	3.32	1.87	4.20	6.69	1.14	1.14
160	3.54	1.99	4.48	7.14	1.22	1.22
170	3.76	2.12	4.77	7.59	1.29	1.29
180	3.98	2.24	5.05	8.03	1.37	1.37
190	4.21	2.37	5.33	8.48	1.45	1.45
200	4.43	2.49	5.62	8.93	1.52	1.52
250	5.53	3.11	7.03	11.18	1.90	1.90
300	6.64	3.74	8.45	13.42	2.28	2.28

Note

- ❖ Vertical lens shift range ($\Delta V1/V$) is 0~55%.
- ❖ Horizontal lens shift range ($\Delta V1/H$) is 0~25%.
- ❖ When horizontal and vertical lens shifts are performed simultaneously, the corners of the screen may become dark (vignetting).

For conditions under which vignetting does not occur, see "Lens Shift Range" (page 39).

Using the On Screen Display (OSD)

The Projector has a multilingual On Screen Display that allows you to make image adjustments and change a variety of settings.

How to operate

1. To open the OSD, press “Menu” on the Control Panel or Remote Control.
2. When OSD is displayed, use ▲▼ keys to select any item in the main menu. While making a selection on a particular page, press “Enter” key to enter sub menu.
3. Use ▲▼ keys to select the desired item in the sub menu and press “Enter” key to view further settings. Adjust the settings by using ◀▶ key or ▲▼ key.
4. Select the next item to be adjusted in the sub menu and adjust as described above.
5. Press “Return (Exit)”, and the screen will return to the previous menu.
6. Press “Return (Exit)” key repeatedly to return to the main menu or close the OSD menu or press “Menu” key, the OSD menu will close.

Note

❖ If no button operation is made for approximately 30 seconds, the OSD will be closed automatically.

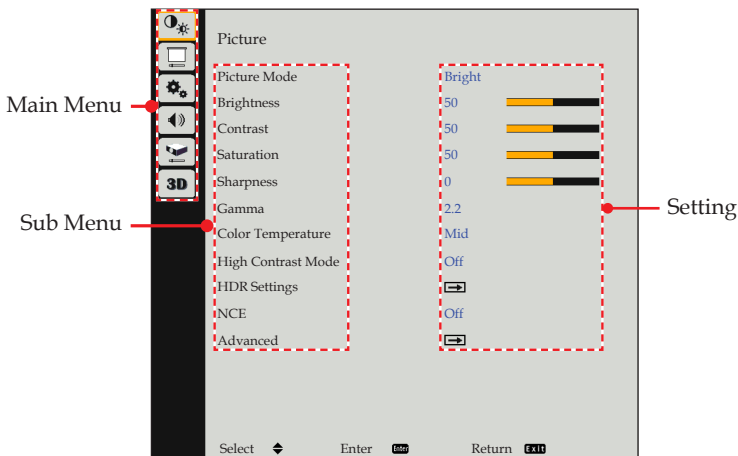

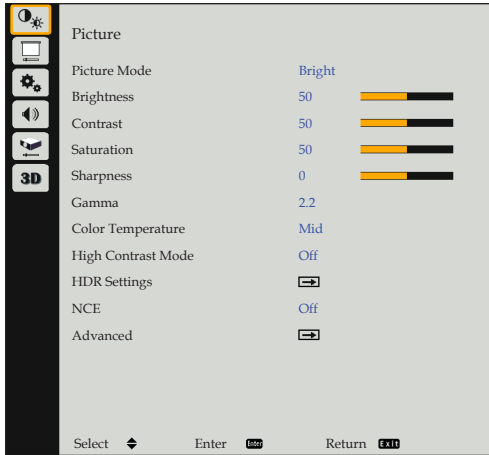

PICTURE

Picture Mode

There are factory presets optimized for various types of images. The available options are:

- ▶ Bright: Mode for emphasizing brightness.
- ▶ Standard: Mode for optimizing the balance between brightness and color reproduction.
- ▶ Vivid: Mode for emphasizing color.
- ▶ Natural: Display natural image.
- ▶ Blending: Mode that prioritizes gradation.
- ▶ DICOM SIM.: This mode is suitable for projecting a monochrome medical image.

Note

❖ Picture Mode, Color Temperature, NCE, and advanced picture functions are grayed out in 3D mode.

❖ Blending mode gives priority to gradation, so colors may look poor. If you want to give priority to color, use another picture mode.

Brightness

Adjust the brightness of the image.

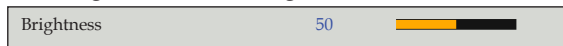

- ▶ Press the ◀ key to darken image.
- ▶ Press the ▶ key to lighten the image.

Contrast

The contrast controls the degree of difference between the lightest and darkest parts of the picture. Adjusting the contrast changes the amount of black and white in the image.

User Settings



- ▶ Press the ◀ key to decrease the contrast.
- ▶ Press the ▶ key to increase the contrast.

Saturation

Adjust the color saturation of the image.



- ▶ Press the ◀ key to decrease the amount of color in the image.
- ▶ Press the ▶ key to increase the amount of color in the image.

Note

❖ “Saturation” function is only supported under Video signal in Computer source.

Sharpness

Adjust the sharpness of the image.

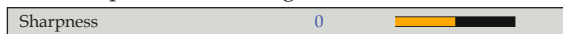

- ▶ Press the ◀ key to decrease the sharpness.
- ▶ Press the ▶ key to increase the sharpness.

Gamma

Use this function to optimize the image output.
The available options: 1.8 / 2.0 / 2.2 / 2.4 / Shine.

Color Temperature

Use this function to select the preset color temperature.
The available options are Low / Mid / High / Native.

High Contrast Mode

Use this function to enhance contrast.
The available options are Off / Mode1 / Mode2.

HDR Settings

Configure the High Dynamic Range (HDR) setting and its effect when displaying video from 4K Blu-ray players and streaming devices.

Note

❖ Only HDMI 1 supports the HDR function.

- ▶ HDR (High Dynamic Range):
 - Auto: Auto detect HDR signal.
 - Off: Turn off HDR Processing. When set to Off, the projector will NOT decode HDR content.

User Settings

- ▶ EOTF (Electro-Optical Transfer Function): Choose this mode from low to high (brighter and more saturated colors).

NCE (Natural Color Enhancer)

Use this function to enhance color and reproduce vivid colors.

- ▶ On: Enable NCE.
- ▶ Off: Disable NCE.

Advanced

Configure the advanced image settings.

- ▶ Wall Color Mode: Use this function to obtain an optimized screen image according to the wall color.
The available options are Off / Light Yellow/ Light Blue/ Pink / Dark Green.
- ▶ Gain/Offset: Adjust the white balance of the projected image via gain and offset. Gain and offset are individual controls for each RGB channels used to set greyscale. The Offset calibrates the color of the dark parts and Gain calibrates the white parts. The available options are Red Gain/ Green Gain/Blue Gain/ Red Offset/ Green Offset/Blue Offset / Restart to Default.
- ▶ NCE: Configure the image color settings.
 - When Red / Green / Blue / Cyan / Magenta/ Yellow is selected:
 - Hue: Use the ◀ or ▶ key to adjust the color balance.
 - Saturation: Use the ◀ or ▶ key to adjust the color saturation.
 - Gain: Use the ◀ or ▶ key to adjust the color brightness.
 - When White gain is selected:
 - Red: Use the ◀ or ▶ key to adjust the gain of red.
 - Green: Use the ◀ or ▶ key to adjust the gain of green.
 - Blue: Use the ◀ or ▶ key to adjust the gain of blue.
 - Restart to Default: Return the NCE settings to the factory default values.

User Settings

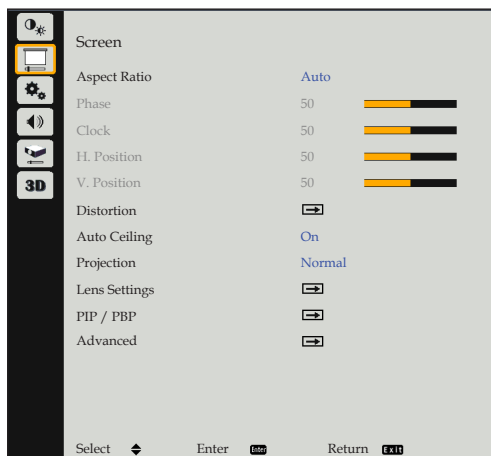

SCREEN

Aspect Ratio

Use this function to choose your desired aspect ratio.

- ▶ Auto: Automatically selects the appropriate display format.
- ▶ 4:3: Displays 4:3 aspect ratio.
- ▶ 16:9: Displays 16:9 aspect ratio.
- ▶ 16:10: Displays 16:10 aspect ratio.

Note

❖ “Phase” and “Clock” functions are only supported under Computer Signal source.

Phase

Eliminate flicker from the image displayed. Use the ◀ or ▶ key to adjust the value.



Clock

Adjust the number of total dots in one horizontal period. Use the ◀ or ▶ key to adjust number to match your PC image.



User Settings

Note

❖ “H. Position” and “V. Position” functions are only supported under Computer Signal source.

H. Position (Horizontal Position)

Shift the projected image position horizontally.



- ▶ Press the ◀ key to move the image left.
- ▶ Press the ▶ key to move the image right.

V. Position (Vertical Position)

Shift the projected image position vertically.

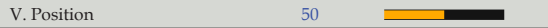

- ▶ Press the ◀ key to move the image down.
- ▶ Press the ▶ key to move the image up.

Distortion

Configure the geometric settings to reshape the image for different projection surfaces.

- ▶ Mode: Select the distortion mode.
The available options are:
 - Keystone: Adjust the horizontal and vertical keystone, four corners, and curved screen.
 - Geometric: Adjust the grid and Blending functions (See pages 54-55).
- ▶ H/V. Keystone: Adjust the images in asymmetric rectangle shape.
- ▶ Four Corner: Compensate for image distortion by adjusting one corner at a time.
- ▶ Curved Screen: Adjust the curved screen horizontally and vertically.
- ▶ Grid Adjustment: Configure the grid settings.
 - Grid Points: Set the grid points of warp pattern.
The available options are 2x2 (default) / 3x3 / 5x5 / 9x9 / 17x17.
 - Warp Inner: Turn on to adjust the inner grid.
 - Warp Sharpness: Adjust sharpness when warping.
 - Grid Color: Select a grid color for warp and blend pattern.
The available options are Green / Magenta / Red / Cyan.
 - Grid Background: Select the grid background.
The available options are Black / None.

Note

❖ Keystone and Geometric mode gives priority to gradation, so colors may look poor.

User Settings

- ▶ **Memory:** The projector allows the user to save up to five geometry memories, including the ones set directly on the projector and the ones configured via external software tools. The available options are Load (Memory 1~5) / Save (Memory 1~5) / Clear.
- ▶ **Reset:** Return Distortion to the factory default values.

Auto Ceiling

Use this function to determine the image orientation when the projector is ceiling mounted.

- ▶ **On:** Automatically detect the image orientation.
- ▶ **Off:** Disable the “Auto Ceiling” function.

Projection

Change the image direction by selecting a proper projection mode. The available options are Normal / Rear / Ceiling / Rear Ceiling.

Note

❖ Performing a lens centering will clear the saved lens records. When the lens calibration is not completed, the lens shift memory will be unavailable.

Note

❖ The PIP/PBP function does not support 3D, 2D High Speed mode, Aspect Ratio, Digital Zoom, and Image Shift.

❖ The same signal cannot be set for Main and Sub.

Lens Settings

Configure the lens settings to adjust the image quality and position.

- ▶ **Focus:** Adjust the focus of the projected image.
- ▶ **Zoom:** Adjust the size of the projected image.
- ▶ **Shift:** Adjust the lens position to shift the projected area.
- ▶ **Lens Memory:** This projector can save and load up to five lens settings, which records the lens position, zoom and focus.
- ▶ **Lens Lock:** This projector can lock up lens position.
- ▶ **Lens Centering:** Process the lens calibration before setup lens shift memory. The lens moves to the center and calibrate at the same time.

PIP / PBP

PIP/PBP (picture in picture/picture by picture) allows simultaneously displaying two images from two input sources.

- ▶ **PIP/PBP Enable:** Select the appropriate PIP/PBP mode or disable the function.

User Settings

- ▶ **Main Source:** Select an input source for the main image. The available input sources are VGA (Computer) / HDMI1 / HDMI2 / HDBaseT.
- ▶ **Sub Source:** Select an input source for the sub image. The available input sources are VGA / HDMI1 / HDMI2 / HDBaseT.
- ▶ **Location:** Adjust the location of the sub image. In the layout chart below, the "P" indicates the main image:

- PBP layout

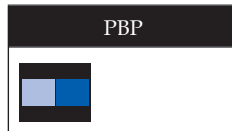

- PIP layout

PIP Layout	PIP Size		
	Small	Medium	Large
PIP, Bottom Right			
PIP, Bottom Left			
PIP, Top Left			
PIP, Top Right			

User Settings

Note

- ❖ Flashing lines may occur if the bandwidth of both inputs are too high, please try to reduce the resolution.
- ❖ Frame tearing may occur due to a difference in frame rate between the Main and the Sub picture.

Note

- ❖ Blending mode must be used with geometric of distortion.
- ❖ Magnify and Blending mode gives priority to gradation, so colors may look poor.

- ▶ Size: Change the display size of the sub source in PIP mode. The available options are Large / Medium / Small.
- ▶ Swap: Swap the main source and sub source.

Advanced

Configure the advanced screen settings.

- ▶ Magnify: Choose from H.Magnify, V.Magnify, H. Shift, and V. Shift.
- ▶ Blending: When using multiple projectors, this mode can eliminate the visible banding and create a single, seamless image across the screen.
 - Blend Width: Set the blend area width. There are 4 options on Blend width, and the range is from 0% and 10%~50%, and adjusting unit is 4 pixels.
 - Left: 0(0%) and 192(10%)~960(50%).
 - Right: 0(0%) and 192(10%)~960(50%).
 - Top: 0(0%) and 120(10%)~600(50%).
 - Bottom: 0(0%) and 120(10%)~600(50%).

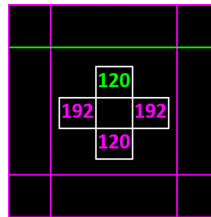

Use the "Blend Width" function as follows:

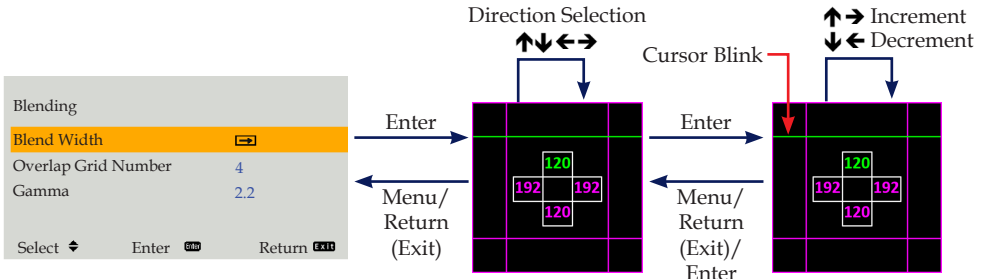

User Settings

- Overlap Grid Number: Setting the Blending function switches the number of grids displayed during “Grid Adjustment” to “Blend Width”. Select the number of grid lines per Blend Width from 4 / 6 / 9 / 10 / 12.
- Gamma: Select the gamma value of the overlapped portions from 1.8 / 1.9 / 2 / 2.1 / 2.2 / 2.3 / 2.4. Overlapped portions become smooth.
- ▶ RGB Input Range: Switches the RGB Input Range of the input signals. Perform adjustments to match the settings for the input signals. (Outputs are in full range when initiated from a PC.)
 - Auto: Automatically detect the range.
 - Limited Range: Process the input image with a limited range.
 - Full Range: Process the input image with a full range.
- ▶ Logo: The logo, displayed during startup and when there is no signal, is switched.
 - Standard: Ricoh logo is displayed.
 - Custom Logo: The logo registered by the customer is displayed. Custom logo can be loaded by the web page of this machine. (Refer to page 73)
- ▶ Power Off Message: Select “Off” to turn off power directly by pressing the Power button without having a confirmation message displayed.
- ▶ Background Color: Select the screen that displays when there is no signal.
 - Logo: Display logo screen when no signal is available.
 - Blue: Display blue screen when no signal is available.
 - Black: Display black screen when no signal is available.
- ▶ Delete Custom Logo: The logo registered by the customer is deleted.
- ▶ Test Pattern: Test pattern is displayed.
Select the displayed pattern from Off / Green Grid / Magenta Grid / White Grid / White / Black / Red / Green / Blue / Yellow / Magenta / Cyan / ANSI Contrast 4x4 / Color Bar / Characters String.

Using Blending function

Step 1

Using the Blending function can reduce the distinct appearance of joining portions between two screens when connecting images from multiple projectors.

Note

- ❖ Blending reduces the sharpness of the image when compared to before compensating.

Horizontally connecting images from two projectors positioned to the left and right, shown within the red frame, for image signals described below, is explained.

The same signal will be input to the two projector units. As shown below, this is useful when the HDMI signal from the HDMI input signal source is connected to terminal of Projector 1 and the HDMI output terminal of Projector 1 is connected to the HDMI input terminal of Projector 2. A signal distributor can also be used to input the same signal.

The overlapping portion of the two images must be at least 10% of image width of one unit. (Approximately 20% is recommended.)

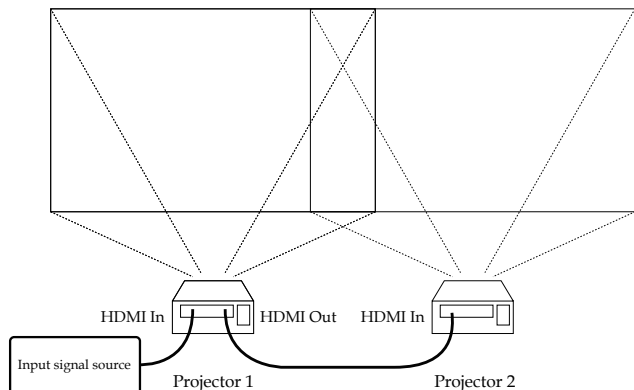
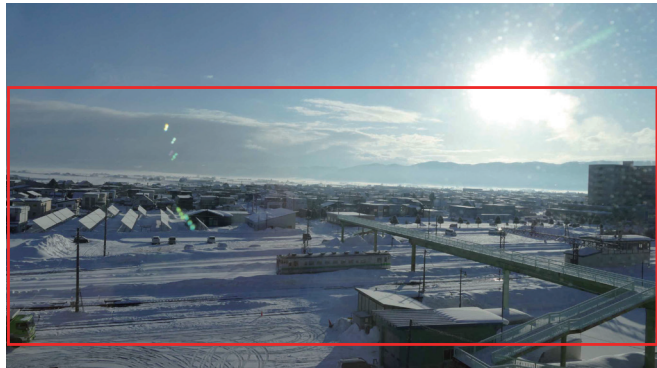

User Settings

Step 2

Set the magnification ratio of Projector 1. In the OSD menu, select [Screen] → [Advanced] → [Magnify] → [H.Magnify] and set the magnification ratio for the horizontal direction. The magnification ratio is set with a percentage value (%), therefore the adjustment must be made to ensure “number of horizontal units x 100 - overlapped portions (%)”.

Similarly, [V.Magnify] must be set to ensure that the value is same as that of [H.Magnify] so that images are not displayed with an unnatural vertical and horizontal ratio.

Also, in the OSD menu, select [Screen] → [Advanced] → [Magnify] → [V. Position] and adjust the image to ensure that the left side of the projected image is displayed.

The image from Projector 2 will be as shown below.



Step 3

Set [H.Magnify], [V.Magnify] and [V. Shift] of Projector 2 to values that are identical to those of Projector 1.

Next, in the OSD menu, select [Screen] → [Advanced] → [Magnify] → [V. Position] and adjust the image to ensure that the right side of the projected image is displayed.

The image from Projector 2 will be as shown below.



User Settings

Note

- ❖ In the event the position of the overlapped portion cannot be adjusted completely and the overlapped appearance cannot be resolved, use [Grid Adjustment] to adjust positions of grid intersections. This makes it possible to reduce overlapping so that it is hardly visible.
- ❖ Displaying a screen with grids (such as an empty Excel worksheet) from a PC can make it easier to conduct adjustments to perform [Grid Adjustment]. In such instances, the entire screen is not visible and operation may become difficult, in which case connecting a monitor to the HDMI Out of Projector 2 is convenient.
- ❖ Displaying a black screen shows overlapped portions more brightly. There is no adjustment function available for black levels, so it is not possible to reduce this effect.

Step 4

Adjust the positions of the two projectors, lens shift, and zoom to ensure that the overlapped projected image from both projectors overlaps completely and the overlap is not as visible.

Once the adjustments are completed, projected images will have overlapped portions that are displayed as bright images.

Adjust the width for the Blending function next. Adjusting this feature gradually darkens the overlapped portions and makes the overlapped portions less obvious.

Adjust the right side of the screen for Projector 1 and the left side of the screen for Projector 2 to adjust the Blending Widths to the overlapped portions.



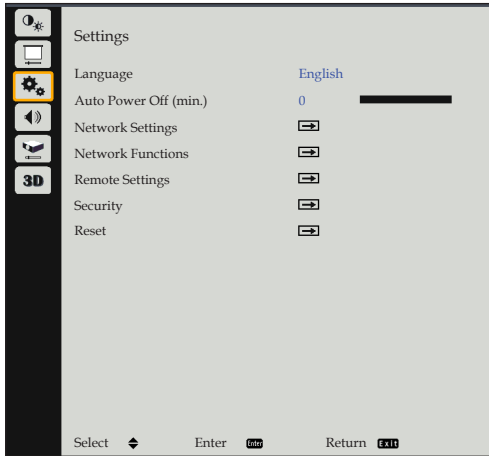

SETTINGS

Language

Choose language of the multilingual OSD. Press “Enter” to open the sub menu and then select your preferred language. Press “Enter” to finalize the selection.

Auto Power Off (min.)

Set the countdown timer interval (in minutes). The countdown timer will start, when there is no signal being sent to the projector. The projector will automatically power off when the countdown has finished. When countdown timer is selected to “Off”, auto power off is disabled. The available options are 5 min. / 10 min. / 20 min. / 30 min.



Network Settings

Configure the projector’s network settings.

▶ LAN Settings: Configure the LAN settings.

- DHCP: Select “On” to allow the projector to obtain an IP address automatically from your network. Select “Off” to manually assign IP, Subnet Mask and Gateway configuration.
- IP Address: Set an IP address or display IP address provided from server.

Note

❖ Default value of “Auto Power Off (min.)” is 20 min.

Note

❖ When DHCP is turned on, the IP Address, Subnet Mask, Gateway, and DNS will be unavailable.

User Settings

Note

- ❖ Even if not used a gateway, set an IP address within the same segment as this unit for the gateway.
- ❖ Up to 223.255.255.255 can be set for the IP address, gateway, and DNS.

Note

- ❖ To prevent unauthorized access, it is recommended to disable features that are not used.

Note

- ❖ This projector supports PjLink Class2.

- Subnet Mask: Set subnet mask number or display subnet mask number provided from server.
- Gateway: Set the default gateway of the network connected to the projector or display the default gateway of the network provided from server.
- DNS: Display the IP address of the domain name system (DNS)server.
- Apply: Apply the changes made in network configuration settings.
- MAC Address: Display MAC address.
- ▶ Reset: Reset the network settings to default factory values.
- ▶ LAN Interface: To avoid clash, specify the LAN interface to LAN port or HDBaseT.

Network Functions

- ▶ Extron: Control the projector with Extron devices (Port: 4023). For more information, please visit <http://www.extron.com>.
- ▶ PjLink: Control the projector with PjLink v2.0 commands (Port: 4352). For more information, please visit <http://pjlink.jbmia.or.jp/english>.
- ▶ PjLink Notification: Set PjLink Notification address.
- ▶ PjLink Setup Apply: Setup the address for the PjLink Notification and select PjLink Setup Apply to save the modifications.
- ▶ AMX: Control the projector with AMX devices. (Port: 9131). For more information, please visit <http://www.amx.com>.
- ▶ Telnet: Control the projector using RS232 commands though Telnet connection. (Port: 3023).
- ▶ Web Server: Control the projector with web browser.
- ▶ Reset: Reset the network functions to default factory values.

Remote Settings

Configure how to operate the projector remotely.

- ▶ Top Receiver: Enable or disable the top remote receiver.
- ▶ Front Receiver: Enable or disable the front remote receiver.
- ▶ HDBaseT Terminal: Enable or disable to use the remote signal on HDBaseT terminal.
- ▶ Remote ID: Set the remote ID to operate multiple projectors. Refer to page 28.

Note

- ❖ The ID range is from 00 to 99.

Note

- ❖ The default password is "1234".

Note

- ❖ Reset function does not include Security/
Lens Memory/
Distortion/
Network Functions/
Network Settings.

Note

- ❖ Distortion correction and blending can be reset with Reset of distortion correction.

Security

Configure the security settings.

- ▶ Startup Password: Select "On" to use the password verification when turning on the projector. Select "Off" to be able to turn on the projector without a password verification.
- ▶ Change Password: Change the password.

Reset

Reset the Setting to default factory values.

User Settings

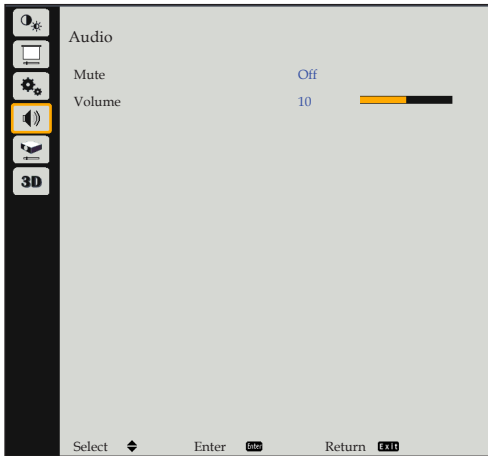

AUDIO

Mute

Temporarily turn off the sound.

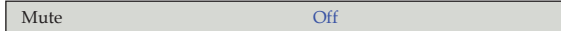

- ▶ Choose "On" to mute the sound.
- ▶ Choose "Off" to turn mute off.

Volume

Adjust the volume level.



- ▶ Press the ◀ key to decrease the volume.
- ▶ Press the ▶ key to increase the volume.

Note

❖ "Mute" function affects both internal and external speaker volume.

User Settings

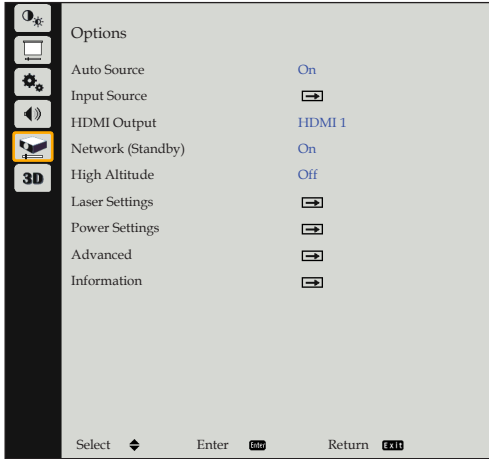

OPTIONS

Auto Source

When this function is turned “On”, the projector will search for other signals if the current input signal is lost. When this function is turned “Off”, it will only search a specified connection port.

Input Source

Use this option to enable/disable input sources. Press the “Enter” key to enter the sub menu and select which sources you require. Press “Enter” to finalize the selection. The projector will only search for inputs that are enabled. The available options are Computer /HDMI 1 /HDMI 2/ HDBaseT.

HDMI Output

Select a source of HDMI output. The available options are HDMI1/HDMI2.

Network (Standby)

Choose “On” to enable LAN connection on standby. Choose “Off” to disable LAN connection on standby.

High Altitude

When “On” is selected, the fans will spin faster. Set High Altitude mode to “On” when the projector is used over 1500m(5000ft) elevation.

User Settings

Laser Settings

Configure light source settings.

- ▶ Laser Power Mode: Set the Laser power.
 - Constant Power: Mode that lights up with constant power.
 - Constant Luminance: Mode to maintain brightness.
 - Eco.: Low power lighting mode, can reduce power consumption and extend laser life.
- ▶ Laser Power: Adjust 30%~100% power for Normal mode.

Power Settings

Use this option to configure the power settings. Press the "Enter" key to enter the sub menu and configure the desired settings.

If changes are made, they will take effect the next time the projector is powered on.

- ▶ Direct Power On: Select "On" to automatically power on the projector when the AC power is supplied. If this option is set to "Off", user needs to press the "Power" button on the control panel or the "⏻" button on the remote control to power on the projector.
- ▶ Cooling Time: Enable the function to have the projector turned on and off with a fast speed.
When "Normal" is selected, the projector will enter "Standby" mode after pressing "Power" button on the remote control or Keypad.
When "Extend" is selected, the laser will be turned off in 60 seconds. During the 60 seconds, the laser will be turned on again if the users push the "Power" button.
- ▶ Start on Input: Select "On" to automatically power on the projector when the input source is detected. If this option is set to "Off", user needs to press the "Power" button on the control panel or remote control to power on the projector.
- ▶ Date and Time: Display the date and time for the projector.
 - Clock Mode: Set the clock mode to NTP Server or Manual.
 - Date: Set a date for the projector. The date format is in Year / Month / Date.
 - Time: Set the time for the projector.
 - Daylight Saving time: Enable or disable the daylight savings function.
 - NTP Server: Select a NTP Server for the network clock mode.

Note

❖ To use the HDBaseT for Start on Input, turn on Network(Standby).

Note

❖ To use NTP Server, make sure the projector is connected to the Internet.

User Settings

Note

- ❖ When Use NTP Server of Clock Mode is selected, the Date and Time will be unavailable.
- ❖ When Manual of Clock Mode is selected, the Daylight Saving time, NTP Server, Time Zone, and Update Interval will be unavailable.

- Time Zone: Set a time zone for the network clock mode.
- Update Interval: Set the date and time update interval.
- Apply: Apply date and time modifications.
- ▶ Schedule: Schedule the projector functions to operate automatically at the set time.
 - Date and Time: Display the date and time for the projector.
 - Schedule Mode: Enable or disable the schedule function.
 - View Today: View the event list scheduled for today.
 - Monday to Sunday: Set up the schedule for days of a week. On the Schedule menu page, select a day and configure the schedule settings.
 - Schedule Enable:** Enable or disable the schedule function for the selected day.
 - Event 01-08/ Event 09-16:** Select an event record number, and set up the schedule details.
 - More Events / Previous Events (Event 01-16):** Display more event records, and select one to set up the schedule details.
 - Copy Event to:** Copy the events setup for the day to another day.
 - Reset the Day:** Reset the schedule settings for the day.
 - Reset Schedule: Reset all of the schedule settings.
- ▶ Sleep Timer: Set an interval timer for the projector to automatically turn off after operating for the specified amount of time.

Advanced

Configure the advanced settings.

- ▶ Signal Detection: Set the quick resync feature from Wide Priority or 4:3 Priority.
- ▶ User 1 / User 2: Assign a function to the User 1 and User 2 buttons on the remote control. It allows you to use the function easily without going through the OSD menus. The available functions are Aspect Ratio / Freeze / Audio Mute / Audio Volume / Display Status / No function.
- ▶ Status Display: Enable or disable the corner information messages, such as input source, IP address, and so on.
- ▶ Trigger Out: Use this function to enable or disable the trigger.
- ▶ User Data: User can save the projector settings as user data and reload the settings later.
 - Save all settings: Save all of the projector settings as user data.

User Settings

User can save up to 5 records.

- Load all settings: Load the previously saved user data.
- Clear Memory: Clear all the projector settings as user data.
- ▶ Service: For service use only.

Information

Display the projector information.

- ▶ Projector: Display total projector hours.
- ▶ System status: Display Standby Mode, Light Source Mode, Light Source Hours, Normal Mode, Eco Mode, and Temperature.
- ▶ Signal: Display Main Signal / Sub signal from Resolution, Signal Format, Pixel Clock, H. Frequency, V. Frequency and Color Space.
- ▶ Communication: Communication menu is used to configure the settings that allow the projector to communicate with other projectors or control devices.
 - Remote code
 - Ethernet: Access the following:
 - LAN Interface
 - MAC Address
 - Network Status
 - DHCP
 - IP Address
 - Subnet Mask
 - Gateway
 - DNS
 - Control: Access the following:
 - Extron
 - PJLink
 - AMX
 - Telnet
 - Web Server
- ▶ FW Version: View Main, I-Scalar, F-MCU, A-MCU, LAN, Formatter, and HDBaseT.

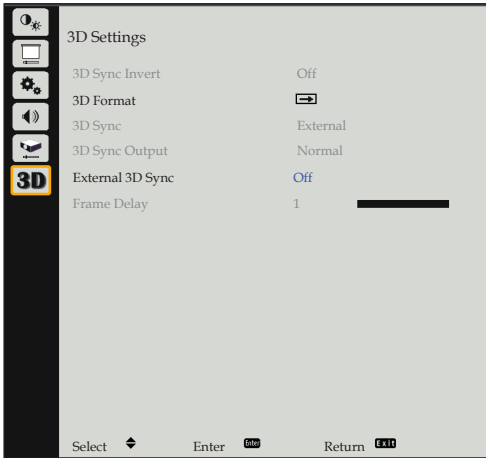

3D Settings

Note

❖ Compatible 3D source, 3D content and Optical 3D glasses are required for 3D viewing.

❖ “3D Sync Invert” is only available when 3D is enabled.

❖ This setting may need to change when re-start running 3D movie.

❖ 3D function is turned on automatically when Blu-ray 3D source is input.

3D Sync Invert

Use this option to enable/disable the 3D sync invert function.

- ▶ Off: Choose “Off” for default frame contents.
- ▶ On: Choose “On” to invert left and right frame contents.

3D Format

Use this option to select the appropriate 3D format content.

- ▶ Auto: Use this mode to let the system to automatically select the appropriate 3D format content.
- ▶ Frame Packing: Use this mode for “Frame Packing” format 3D content.
- ▶ Side-by-Side: Use this mode for “Side-by-Side” format 3D content.
- ▶ Top and Bottom: Use this mode for “Top and Bottom” format 3D content.
- ▶ Frame Sequential: Use this mode for “Frame Sequential” format 3D content.

User Settings

3D Sync

Select a proper 3D technology according to how the 3D sync signal is processed.

- ▶ DLP-Link: Select DLP-Link when the 3D sync signal is generated by the DLP Link technology built into the projector. DLP Link works only with the glasses that are compatible with DLP 3D technology and the 3D function is enabled.
- ▶ External: Select 3D Sync when the 3D sync out signal is sent to an emitter or another projector through the 3D sync out port.

3D Sync Output

Set up the transmission of the 3D sync output signal.

- ▶ Normal: Send the 3D sync signal to the emitter connected to the 3D sync out port.
- ▶ Path Through: Send the 3D sync signal to next projector when using multiple projectors.

External 3D Sync

When "On" is selected, use 3D Sync signal from "3D SYNC IN" connector. When "Off" is selected, use 3D Sync from internal source. For multiple projectors application, it's better that the first projector is selected "On" to avoid possible 3D sync loss or unstable problem.

Frame Delay

Use this option to correct asynchronous displaying of images under 3D blending.

Controlling this Device with Web Browser

Note

❖ Make sure Web server is enabled. (See page 60)

You can control this device from a PC by using a web browser.

System Requirements

To use the web control panel, make sure your devices and software meet the minimum system requirements.

- Compatible web browsers:
 - Microsoft Edge
 - Firefox
 - Chrome

Connect to network

When network is available, connect the projector and the computer to the same network. Use the projector address as the web URL to open the web control panel in a browser.

1. Check the projector address using the OSD menu.
 - Select Settings > Network Settings > LAN Settings > IP Address.
2. Open a web browser and type the projector IP address in the address bar.
3. The web page redirects to the web control panel.
4. In the Username field, type the username: "admin" (default). In the Password field, type the password.

When network is not available, refer to "Directly connect the projector to a computer" section.

Directly connect the projector to a computer

When network is not available, connect the projector to the computer directly using a LAN cable, and configure the network settings manually.

LAN Control

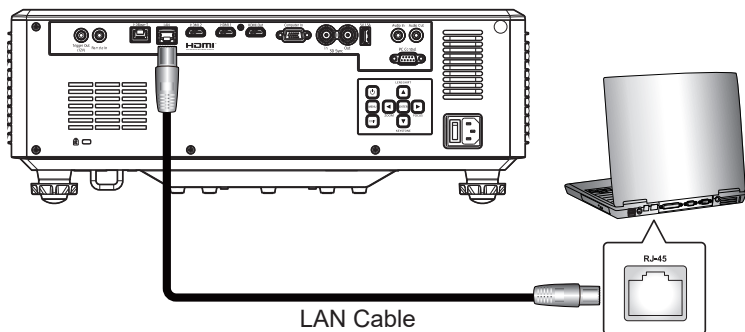

1. Assign IP address to the projector:

- From the OSD menu, select Settings > Network Settings > LAN Settings > DHCP.

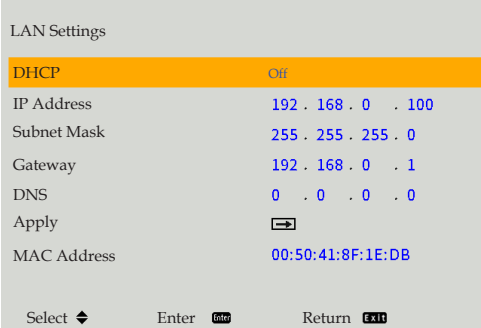

LAN Settings	
DHCP	Off
IP Address	192 . 168 . 0 . 100
Subnet Mask	255 . 255 . 255 . 0
Gateway	192 . 168 . 0 . 1
DNS	0 . 0 . 0 . 0
Apply	→
MAC Address	00:50:41:8F:1E:DB

Select ⚙ Enter **Enter** Return **EXIT**

- Turn off DHCP, and manually set the projector's IP Address, Subnet Mask, and Gateway.
 - Press "Apply" to confirm the settings.
- ## 2. Set the LAN Interface to "LAN Port":
- From the OSD menu, select Settings > Network Settings > LAN Interface. Select "LAN Port".

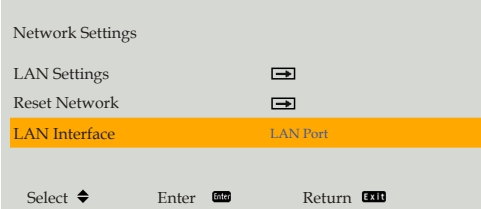

Network Settings	
LAN Settings	→
Reset Network	→
LAN Interface	LAN Port

Select ⚙ Enter **Enter** Return **EXIT**

LAN Control

3. Enable Web Server service:
 - From the OSD menu, select Settings > Network Functions > Web Server.

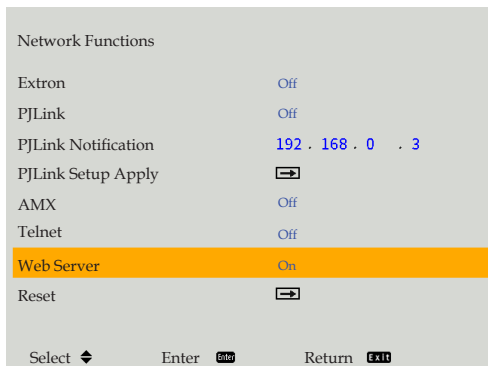

- Select "On" to enable the Web Server.
4. Open a web browser and type the projector IP address (for example, "192.168.0.100") in the address bar.
5. The web page redirects to the web control panel.
6. From the web control panel, please enter Username and Password.

Note

❖ The first login the Username is " admin" and Password is MAC Address. (From the OSD Menu,select Settings > Network Settings > LAN Settings > MAC Address).

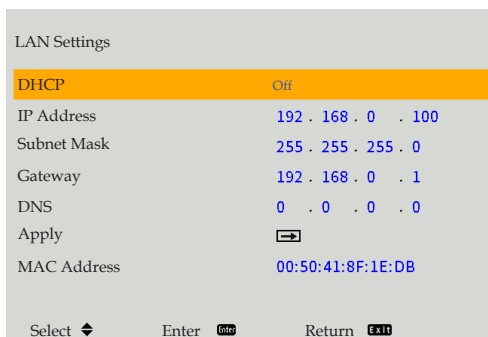

Web page of this projector

Note

❖ Details of such operations may not be reflected on the display of the browser when menu operations are performed while the unit is controlled from a web browser. Reload the browser page to update with the latest information. Reloading can be performed by pressing the F5 key on a Windows computer, or with Command + R on a Macintosh computer.

The web page described below is displayed when a user logs onto the unit as the administrator. The menu is displayed on the left side. The menu displays only Operation and Settings, Display Status and Software License when a user logs onto the unit as a user.

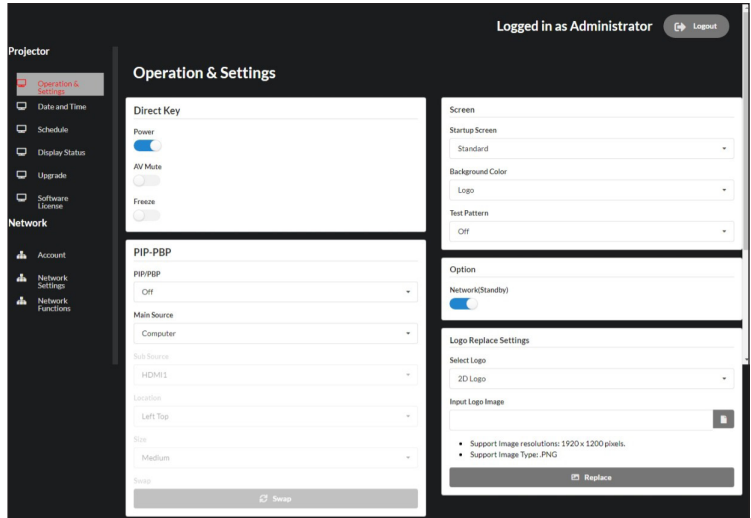

Menu	Description
Projector	
Operation and Settings	Such operations as input switching and AV mute, as well as registration of a user's logo can be performed.
Date and Time	Settings relating to the internal clock can be performed.
Schedule	Settings relating to the timer can be performed. Be sure to press the [Save] button at the right upper section after implementing any changes to settings. A confirmation message is displayed to prompt saving of settings with the [Save] button when exiting this page.
Display Status	Displays the operating status of the unit and the firmware version.
System Upgrade	The firmware can be updated. The latest firmware is available for downloading from our website.
Software License	Displays the license information of third party software used on this unit.

LAN Control

Note

❖ There are two types of accounts for this web page, namely the administrator (admin) and the user (user) accounts. The user name of the unit at the time of shipping is “admin” and the password is the MAC address. Refer to page 68 for details.

❖ The communication with the web server is not encrypted. Avoid using the same password as other information devices.

❖ Contents on the web server of the unit are displayed in English. Such display contents cannot be changed to any other language.

Menu	Description
Network	
Account	Accounts are set up for controlling the unit with a web browser. There are two types of accounts, namely the administrator (Administrator) and the user (User) accounts.
Network Settings	Network settings can be changed. Press the [Apply] button after implementing changes.
Network Functions	Each network function can be turned on and off, the PJLink password can be set and notification addresses can be set. Network functions can also be initialized.

Projector Login

Enter the user name and password. Next, click the [Login] button.

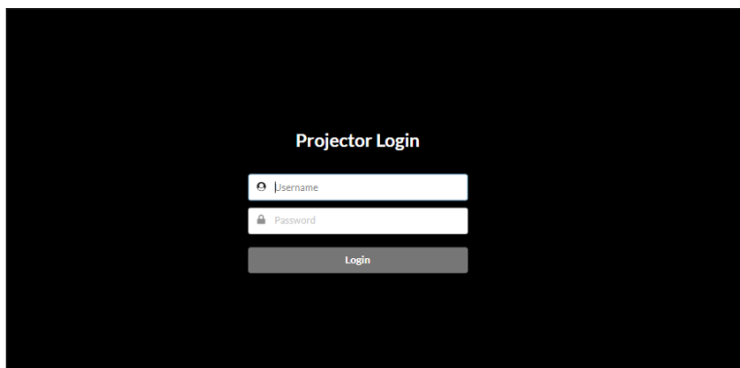

Projector Login

Username

Password

Login

Operation & Settings

On this page, you can enable or disable direct keys, configure the PIP-PBP settings, configure screen settings, enable or disable Network standby, and select Logo.

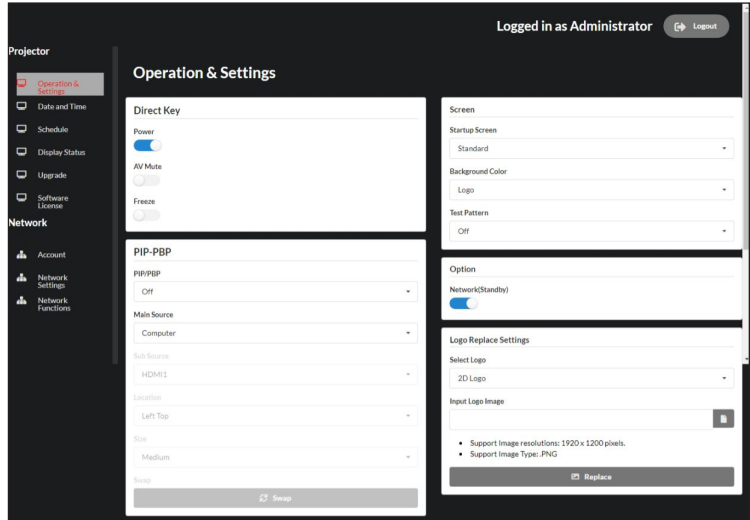

Note

❖ Logo replacement is only supported for images with the specified resolutions(1920x1200) and file format(png). If you register any other resolution image, the custom logo will not be displayed.

Date and Time

On this page, configure date and time settings.

The screenshot displays the 'Date and Time' configuration interface. At the top right, it indicates 'Logged in as Administrator' with a 'Logout' button. The left sidebar contains a 'Projector' section with options like 'Operation & Settings', 'Date and Time', 'Schedule', 'Display Status', 'Upgrade', and 'Software License', and a 'Network' section with 'Account', 'Network Settings', and 'Network Functions'. The main content area is titled 'Date and Time' and includes a 'Save' button. The configuration fields are as follows:

Date and Time		
Time Synchronization		
Manual		
Year	Month	Day
2022	09	07
Hour	Minute	Second
15	12	27
NTP Server		Update Interval
time.google.com		Hourly
Time Zone		Daylight Saving Time
UTC+0000		<input type="checkbox"/>

Schedule

On this page, configure schedule settings from Monday to Sunday.

The screenshot displays the 'Schedule' configuration interface. On the left, a navigation sidebar includes 'Projector' (with sub-items: Configuration, Display Mode, Display Status, User role, Language, System) and 'Networks' (with sub-items: Account, Network, Network, Network). The main content area is titled 'Schedule' and shows 'Logged in as Administrator'. The 'Schedule View' section includes a 'View: Today' button and a 'Wednesday' label. The interface is divided into seven panels, one for each day of the week (Monday through Sunday). Each panel contains a 'Schedule View' section with a 'View: Today' button and a 'Wednesday' label. Below this, there is a table with columns for time slots (01 to 16) and a 'N/A' status. At the bottom of each panel, there are buttons for 'Copy Events To', 'Reset the Timer for This Day', and 'Reset'.

Display Status

On this page, view the projector information about its status and settings.

Note

- ❖ The projector information is read only.

Logged in as Administrator [Logout](#)

Projector

Projector	
Model Name	PJ WXJ.6600 series
Current status	Normal
Total Projector Hours	43

System Status

Network(Standby)	On
Laser Power Mode	Constant Luminance
Laser Hours Used	
Normal	13
Eco Mode	8
Temperature	43.0C

Signal

Main Resolution	1920 x 1200
Main Signal Format	Analog
Main Pixel Clock	154.000MHz
Main H.Frequency	74.038kHz
Main V.Frequency	59.95Hz
Main Color Space	RGB
Sub Resolution	-
Sub Signal Format	-
Sub Pixel Clock	-
Sub H.Frequency	-
Sub V.Frequency	-
Sub Color Space	-

Communication

Remote ID	0
LAN Interface	LAN Port
MAC Address	00:50:41:8E:DF:46
DHCP	Off
IP Address	192.168.0.100
Subnet Mask	255.255.255.0
Gateway	192.168.0.1
DNS	0.0.0.0
Control Extron	On
Control PJ Link	On
Control AMX	On
Control Telnet	On
Control Web Server	On

Firmware Version

Main Version	R0.4.0
I-Scaler	V01.22
F-MCU Version	E00.01
A-MCU Version	A00.09
LAN Version	N01.08
Formatter Version	F01.66(060602-19)
HDDBaseT Version	H13.1471.00.00

Upgrade

On this page, upgrade the system. Select "Upgrade" to upgrade to the latest Firmware version by selecting upload file in the computer.

Logged in as Administrator [Logout](#)

System Upgrade

[Upgrade](#)

Firmware Version	
Main Firmware	R0.4.0
System Upgrade	
New Firmware	
Select upload file	<input type="button" value="Upload"/>

Software License

On this page, view software license.

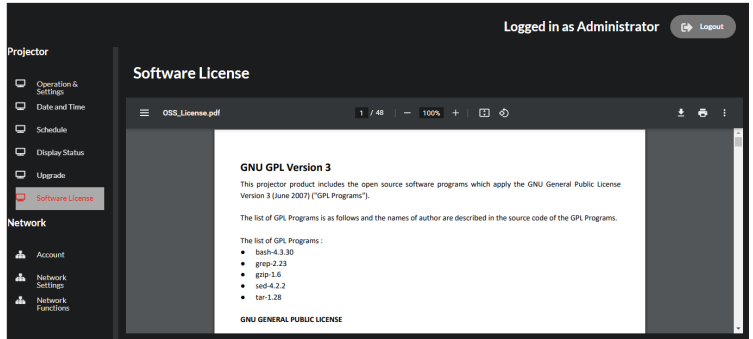

Account

On this page, setup password for Admin and User.

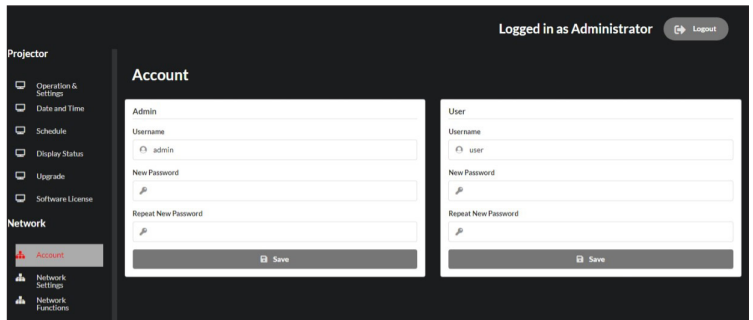

Network Settings

On this page, setup LAN interface and configure LAN settings on the projector.

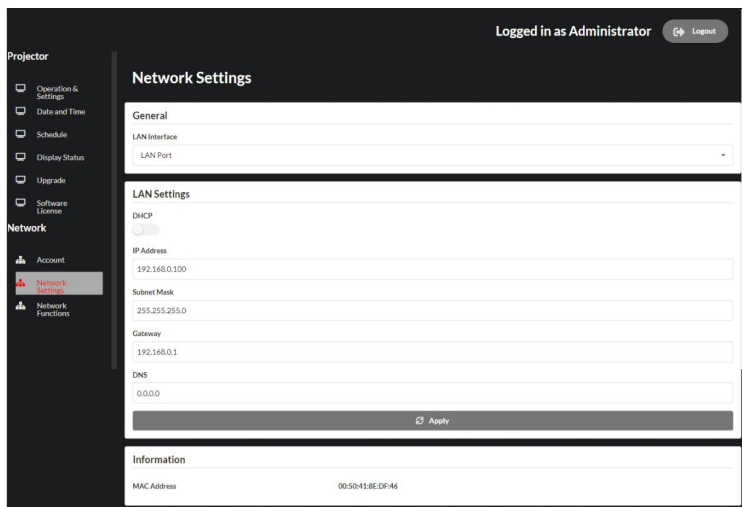

Network Functions

On this page, configure network functions and reset control settings. Setup LAN function on the projector: From the web control panel, select "Network Functions to enable LAN function from Extron / PJLink / AMX / Telnet / Web Server.

To set the PJLink password authentication on or off. If set "ON" with the PJLink menu, the password must be required. The default Password is "Projector" or enter a password onto the text box.

Note

❖ The default Password for PJLink is "Projector", and password requires 8 to 32 digitals including mixed upper, lower-case characters and number.

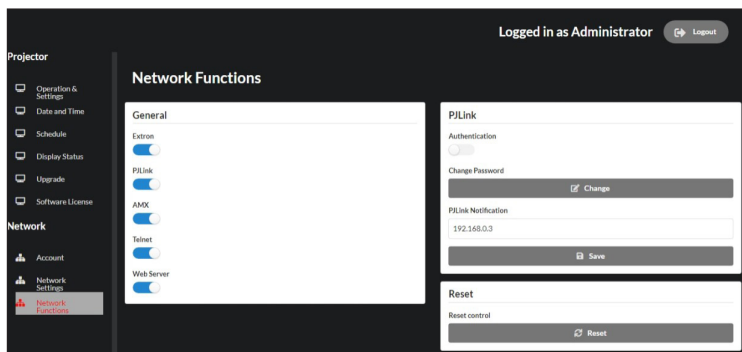

Controlling the projector with the Projector Management Utility

Note

❖ This software is a software intended for managing our projectors. Products that are not our projectors may not operate properly when managed with this software. Refer to Help of the utility for details.

❖ Delete the "Projector Management Utility" under "Programs and Features" on the "Control Panel" to uninstall the Projector Management Utility.

❖ Although the unit supports the PJLink Class 2, the software supports Class 1. Note that the utility does not support all PJLink commands that are supported by the unit.

Information on the Projector Management Utility

The Projector Management Utility complies with the PJLink Class 1 standard and supports all commands of Class 1. Up to 100 units of projectors that are connected to the network can be managed with a single personal computer.

The operating environment of the Projector Management Utility is as described below.

- Supported OS
- Windows 8.1 Pro / Enterprise (32bit / 64bit)
- Windows 10 Pro / Enterprise (32bit / 64bit)
- Memory capacity

Complies with the recommended memory capacity for the OS in use

- Display resolution
800 x 600 pixels or more

Installing the Projector Management Utility.

The Projector Management Utility can be downloaded from our web site.

https://support.rioh.com/bbv2/html/dr_ut_d/projector/

Log onto the unit with an administrator authority to install or uninstall the utility.

1. Close all applications.
2. Double click the downloaded file.
3. Execute the installation procedure according to the instruction displayed on the screen.
4. Once the installation is completed, click on the [Finish] button. A shortcut icon is prepared on the desktop.

Register projectors

1. Registers the projectors with Auto search
 - Click [Register Projector] button.

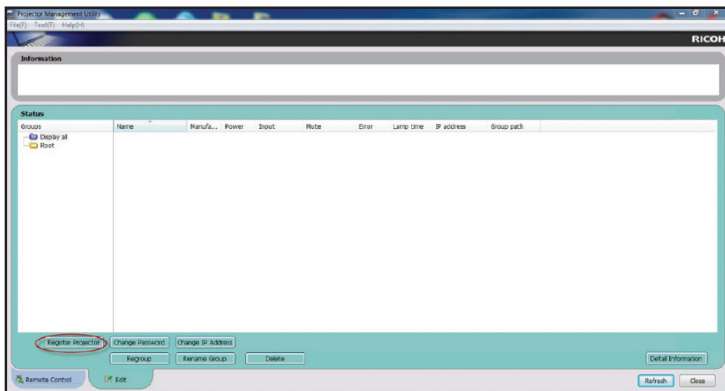

- Click [Auto Search] button.

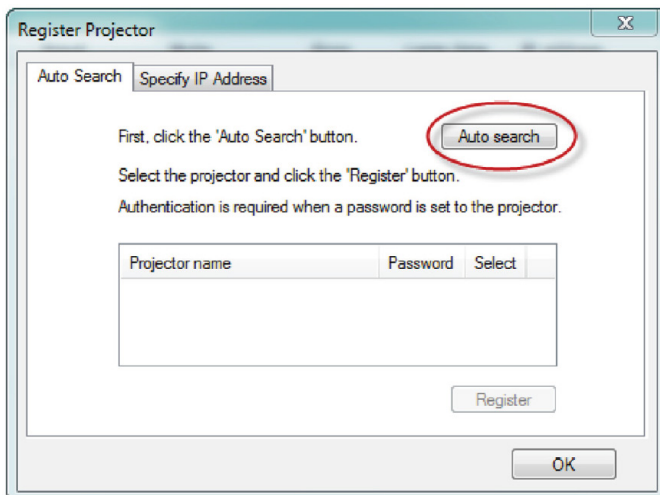

- List of projectors which support PJLink are displayed in the window. Projector name is displayed as "*****" until authorization if password is enable.

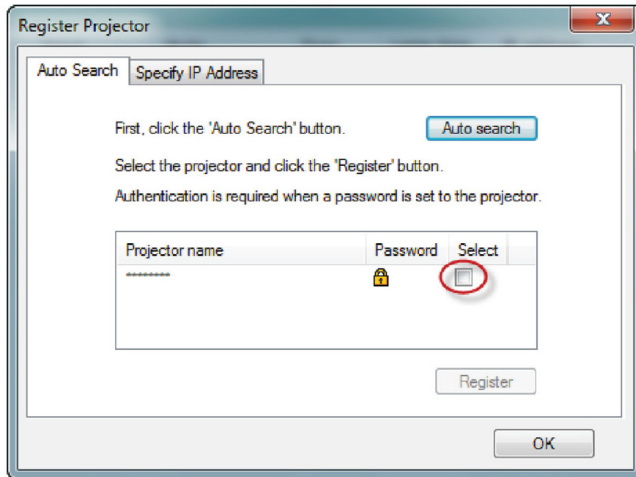

- Select the desired projector and click [Register] button. Password authorization is required if password of the projector is set to enable.

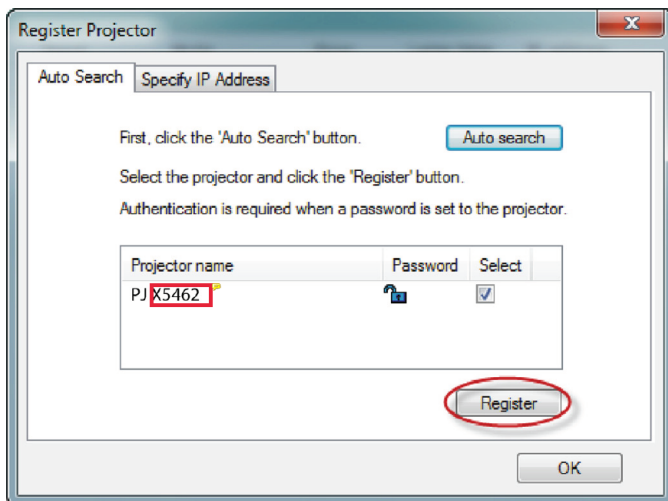

- Click [OK] button to return to the original screen.

2. Directly specifies the IP address and registers the projector.

- Enter IP address of the desired projector and click [Confirm] button then the projector name will be displayed. After confirming the projector name, click [Register] button.

Control the projector with the projector Management Utility

Click [Remote Control] tab and select the desired projector in the list. You can control the selected projector by clicking control buttons in the bottom of the window.

[Power] button

Turn "On/Off" the power of the projectors or groups selected from the Projector (/Group) List.

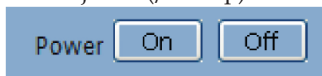

[Input] button

Switches the input source of the projectors or groups selected from the Projector (/Group) List.

Input source will not be changed if the projector doesn't support the selected input source.

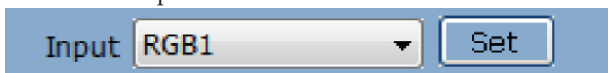

A Table of input source name in the projector and the projector management utility.

The projector	The projector Management Utility
Computer	RGB 1
HDMI1	Digital 1
HDMI2	Digital 2
HDBaseT	NETWORK 1

[Mute] button

Turn “On/Off “ the muting of the projectors or groups selected from the Projector (/Group) List. The projector only supports Video & Audio mute.

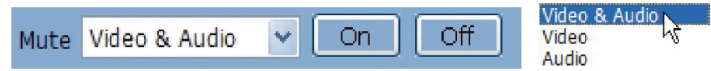

[Detail Information] button

Show detail information of the selected projector.

Troubleshooting

If you experience trouble with the projector, refer to the following information. If the problem persists, please contact your local dealer or service center.

Problem: No image appears on screen

- ▶ Ensure all the cables and power connections are correctly and securely connected as described in the “Connecting the Projector” section.
- ▶ Ensure the pins of terminals are not crooked or broken.
- ▶ Make sure the projector is switched on.
- ▶ Ensure that the “AV Mute” feature is not turned on.

Problem: Partial, scrolling or incorrectly displayed image

- ▶ Press “Auto” on the remote control.
- ▶ Adjust the computer display settings. Verify the resolution setting is less than or equal to 1600 x 1200 (3840 x 2160 for HDMI) resolution. See your operating system’s Help file.
- ▶ If you experience difficulty changing resolutions or your monitor freezes, restart all equipment including the projector.

Note

❖ The image is not stable immediately after turning on the unit. Wait at least 30 minutes after starting projection before adjusting the image.



Problem: Image is out of focus

- ▶ Press the “Focus ▲” or “Focus ▼” button on the remote control or projector keypad to adjust the focus until the image is sharp and legible.
- ▶ Make sure the projection screen is between the required distance from the projector. Refer to pages 40-42.
- ▶ If Keystone correction, 4-point correction, Magnify, etc. are performed, the image will not be clear compared to before correction. This is due to digital signal processing and is not a malfunction.

Problem: The image is stretched when displaying DVD

- ▶ Select “Screen > Aspect Ratio” from the OSD menu to show image with proper aspect ratio.

Problem: Image is too small or too large

- ▶ Press the “Zoom ” or “Zoom ” on the remote control or the “Zoom” on the projector keypad to adjust the projected image size.
- ▶ Move the projector closer to or further from the screen.
- ▶ Select “Screen > Aspect Ratio” from the OSD menu and try the different settings.

Problem: The screen of the Notebook computer is not displaying a presentation

- ▶ If you are using a Notebook PC:

Some Notebook PCs may deactivate their own screens when a second display device is in use. Each has a different way to be reactivated. Refer to your computer’s documentation for detailed information.





Problem: Image is unstable or flickering

- ▶ Adjust the “Phase” or “Clock” to correct it in the Screen menu.
- ▶ Check and reconfigure the display mode of your graphic card to make it compatible with the product.

Problem: Image is reversed

- ▶ Select “Screen > Projection” from the OSD menu to adjust the image.

Problem: Image has slanted sides

- ▶ If possible, reposition the projector so that it is centered on the screen and below the bottom of the screen.
- ▶ Press the “Keystone  /  /  /  on the remote control or the “Keystone” button on the projector keypad to adjust the screen shape.

Troubleshooting

Note

Steady light => ☀
No light => ⊗

Problem: Turns off during use

- ▶ The power will automatically turn off after 20 minutes of no signal by factory settings.
Select "Settings > No Signal Power Off" to adjust the time.
- ▶ Check if the ambient temperature is too high.
- ▶ Make sure the air intake and exhaust vents are not blocked.
- ▶ Check if the wind from the air conditioner is blowing directly on the unit.

Problem: Indicator lighting message

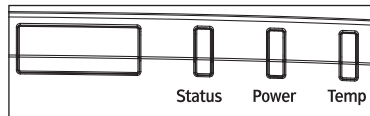

STATUS	Status indicator	Power indicator		Temp indicator
	(Red)	(Red)	(Green)	(Red)
STANDBY	⊗	☀	⊗	⊗
POWER ON	⊗	⊗	☀	⊗
WARMING UP STATE	⊗	Flashing (1 sec off/ 1sec on)	⊗	⊗
COOLING DOWN	⊗	⊗	Flashing (1 sec off/ 1sec on)	⊗
AV MUTE	Flashing (1 sec off/ 1sec on)	⊗	☀	⊗
Error Status				
POWER FAILURE	☀	⊗	⊗	☀
FAN 1 LOCK	⊗	⊗	⊗	Flashing (3 sec off/ 3 sec on)
FAN 2 LOCK	☀	⊗	⊗	Flashing (3 sec off/ 3 sec on)

Troubleshooting

Note

❖ Fan4 to 8 only support WUL6680 series/WUL6690 series.

STATUS	Status indicator	Power indicator		Temp indicator
	(Red)	(Red)	(Green)	(Red)
FAN 3 LOCK				Flashing (3 sec off/ 3 sec on)
FAN 4 LOCK				Flashing (3 sec off/ 3 sec on)
FAN 5 LOCK				Flashing (1 sec off/ 1sec on)
FAN 6 LOCK				Flashing (1 sec off/ 1sec on)
FAN 7 LOCK				Flashing (1 sec off/ 1sec on)
FAN 8 LOCK				Flashing (1 sec off/ 1sec on)
COLOR WHEEL BREAKDOWN				Flashing (0.5 sec off/ 0.5 sec on)
OVER HEAT				
LD OVER HEAT				
LD VOLTAGE FAILURE				
TEMPERATURE SENSOR DISCONNECTED	Flashing (0.5 sec off/ 0.5 sec on)	Flashing (0.5 sec off/ 0.5 sec on)		
LD FAILURE				
UPGRADE PROCESS	Flashing (3 sec off/ 3 sec on)	Flashing (3 sec off/ 3 sec on)	Flashing (3 sec off/ 3 sec on)	Flashing (3 sec off/ 3 sec on)

Troubleshooting

Note

- ❖ Operating the projector while having dust and dirt at the ventilation inlet cause of the laser units failed on event, or failure of the projector due to the excessive temperature rise inside the main body.
- ❖ Depend on the using place, there are dust and dirt apt to collect in the area of ventilation outlet. If that occurs, suck up with care.

Problem: Message Reminders

- ▶ Temperature Error - When the “Temp” indicator lights red, it indicates the projector has overheated. The projector will automatically shut itself down.



- ▶ Fan Error - If the fan fails, the cooling fan will keep working for the specified time and the LED indicator will light up. For more information on LED indicator lighting, see pages 88-89 (Indicator lighting message).

When the following message is displayed on the screen, stop using the projector and disconnect the power cord from the electrical outlet, then contact your local dealer or our service center.

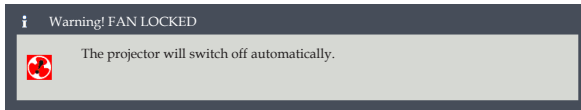

List of Compatible Signals

A. VGA Analog						
(1) PC Signal						
Modes	Resolution	Aspect Ratio		V Sync (Hz)	RGB	YPbPr
VGA	640 x 350	1.83	64:35	85	V	X
	640 x 400	1.6	16:10	85	V	X
	640 x 480	1.33	4:3	60	V	X
				72	V	X
				75	V	X
				85	V	X
	720 x 400	1.8	9:5	70	V	X
				85	V	X
SVGA	800 x 600	1.33	4:3	60	V	X
				72	V	X
				75	V	X
				85	V	X
	832 x 624			75	V	X
	848 x 480	1.77	53:30	60	V	X
XGA	1024 x 768	1.33	4:3	60	V	X
				70	V	X
				75	V	X
				85	V	X
				75	V	X
SXGA	1152 x 864			75	V	X
	1152 x 870	1.32	192:145	75	V	X
WXGA	1280 x 768	1.67	5:3	60	V	X
				75	V	X
				85	V	X
	1280 x 800	1.6	16:10	60	V	X
				75	V	X
				85	V	X

Appendices

A. VGA Analog						
SXGA	1280 x 960	1.33	4:3	60	V	X
				85	V	X
	1280 x 1024	1.25	5:4	60	V	X
				75	V	X
				85	V	X
Modes	Resolution	Aspect Ratio		V Sync (Hz)	RGB	YPbPr
WXGA	1360 x 768	1.78	16:9	60	V	X
	1366 x 768				V	X
SXGA+	1400 x 1050	1.33	4:3		V	X
WXGA+	1440 x 900	1.6	16:10		V	X
					75	V
WXGA++	1600 x 900	1.78	16:9	60	V	X
UXGA	1600 x 1200	1.33	4:3	50	V	X
				60	V	X
WSXGA+	1680 x 1050	1.6	16:10	V	X	
WUXGA RB	1920 x 1200RB			50	V	X
				60	V	X
(2) TV Signal						
SDTV (480i)	720 x 480	1.5	3:2	59.94	V	X
				60	V	X
SDTV (576i)	720 x 576	1.25	5:4	50	V	X
EDTV (480p)	720 x 480	1.5	3:2	59.94	V	X
				60	V	X

Appendices

A. VGA Analog						
EDTV (576p)	720 x 576	1.25	5:4	50	V	X
HDTV (1080i)	1920 x 1080	1.78	16:9		V	X
				59.94	V	X
				60	V	X
HDTV (720p)	1280 x 720			50	V	X
				59.94	V	X
				60	V	X
HDTV (1080p)	1920 x 1080			23.98	V	X
				24	V	X
				25	V	X
				29.97	V	X
				30	V	X
				50	V	X
				59.94	V	X
				60	V	X

❖ "V" video format is supported.

❖ "X" video format is not supported.

Appendices

B. HDMI Digital													
(1) PC Signal													
Modes	Resolution	Aspect Ratio		V Sync (Hz)	RGB			YCbCr 4:4:4			YCbCr 4:2:2		
					8 bit	10 bit	12 bit	8 bit	10 bit	12 bit	8 bit		
VGA	640 x 350	1.8	64:35	85	V	V	V	V	V	V	V		
	640 x 400	1.6	16:10	85	V	V	V	V	V	V	V		
	640 x 480	1.33	4:3	60	V	V	V	V	V	V	V	V	
				72	V	V	V	V	V	V	V	V	
				75	V	V	V	V	V	V	V	V	V
				85	V	V	V	V	V	V	V	V	V
	720 x 400	1.8	9:5	70	V	V	V	V	V	V	V	V	
				85	V	V	V	V	V	V	V	V	V
SVGA	800 x 600	1.33	4:3	60	V	V	V	V	V	V	V		
				72	V	V	V	V	V	V	V	V	
				75	V	V	V	V	V	V	V	V	
				85	V	V	V	V	V	V	V	V	
				120	V	V	V	V	V	V	V	V	
	832 x 624	1.77	53:30	75	V	V	V	V	V	V	V		
	848 x 480			60	V	V	V	V	V	V	V		
XGA	1024 x 768	1.33	4:3	60	V	V	V	V	V	V	V		
				70	V	V	V	V	V	V	V		
				75	V	V	V	V	V	V	V		
				85	V	V	V	V	V	V	V		
				120	V	V	V	V	V	V	V		
SXGA	1152 x 864	1.32	192:145	75	V	V	V	V	V	V	V		
	1152 x 870			75	V	V	V	V	V	V	V		
WXGA	1280 x 768	1.67	5:3	60	V	V	V	V	V	V	V		
				75	V	V	V	V	V	V	V		
				85	V	V	V	V	V	V	V		
	1280 x 800	1.6	16:10	60	V	V	V	V	V	V	V		
				75	V	V	V	V	V	V	V		
				85	V	V	V	V	V	V	V		
				120	V	V	V	V	V	V	V		

Appendices

B. HDMI Digital											
Modes	Resolution	Aspect Ratio		V Sync (Hz)	RGB			YCbCr 4:4:4			YCbCr 4:2:2
					8 bit	10 bit	12 bit	8 bit	10 bit	12 bit	8 bit
SXGA	1280 x 960	1.33	4:3	60	V	V	V	V	V	V	V
				85	V	V	V	V	V	V	V
	1280 x 1024	1.25	5:4	60	V	V	V	V	V	V	V
				75	V	V	V	V	V	V	V
WXGA	1360 x 768	1.78	16:9	60	V	V	V	V	V	V	V
	1366 x 768				V	V	V	V	V	V	V
SXGA+	1400 x 1050	1.33	4:3		V	V	V	V	V	V	
WXGA+	1440 x 900	1.6	16:10		V	V	V	V	V	V	V
				75	V	V	V	V	V	V	
				85	V	V	V	V	V	V	
WXGA++	1600 x 900	1.78	16:9	60	V	V	V	V	V	V	
UXGA	1600 x 1200	1.33	4:3	50	V	V	V	V	V	V	V
				60	V	V	V	V	V	V	V
WSXGA+	1680 x 1050	1.6	16:10		V	V	V	V	V	V	V
WUXGA RB	1920 x 1200RB			50	V	V	V	V	V	V	V
		60	V	V	V	V	V	V	V		
(2) TV Signal											
SDTV (480i)	720 x 480	1.5	3:2	59.94	V	V	V	V	V	V	V
				60	V	V	V	V	V	V	V
SDTV (576i)	720 x 576	1.25	5:4	50	V	V	V	V	V	V	
EDTV (480p)	720 x 480	1.5	3:2	59.94	V	V	V	V	V	V	V
				60	V	V	V	V	V	V	V

Appendices

B. HDMI Digital												
EDTV (576p)	720 x 576	1.25	5:4	50	V	V	V	V	V	V	V	V
HDTV (1080i)	1920 x 1080	1.78	16:9		V	V	V	V	V	V	V	V
					59.94	V	V	V	V	V	V	V
					60	V	V	V	V	V	V	V
HDTV (720p)	1280 x 720				50	V	V	V	V	V	V	V
					59.94	V	V	V	V	V	V	V
					60	V	V	V	V	V	V	V
120	V				V	V	V	V	V	V	V	
	Modes			Resolution	Aspect Ratio	V Sync (Hz)	RGB			YCbCr 4:4:4		
					8 bit	10 bit	12 bit	8 bit	10 bit	12 bit	8 bit	
HDTV (1080p)	1920 x 1080	1.78	16:9	23.98	V	V	V	V	V	V	V	
				24	V	V	V	V	V	V	V	
				25	V	V	V	V	V	V	V	
				29.97	V	V	V	V	V	V	V	
				30	V	V	V	V	V	V	V	
				50	V	V	V	V	V	V	V	
				59.94	V	V	V	V	V	V	V	
				60	V	V	V	V	V	V	V	
(3) Mandatory 3D Signal												
Frame Packing (1080p)	1920 x 1080	1.78	16:9	23.98	V	V	V	V	V	V	V	
	Frame Packing (720p)			1280 x 720	24	V	V	V	V	V	V	V
50					V	V	V	V	V	V		
59.94					V	V	V	V	V	V		
60					V	V	V	V	V	V		
Side by Side (1080i)					1920 x 1080	50	V	V	V	V	V	V
						59.94	V	V	V	V	V	V
Top and Bottom (720p)	1280 x 720			60	V	V	V	V	V	V		
		50	V	V	V	V	V	V				
		59.94	V	V	V	V	V	V				
Top and Bottom (1080p)	1920 x 1080	60	V	V	V	V	V	V				
		23.98	V	V	V	V	V	V				
24	V	V	V	V	V	V						

Appendices

B. HDMI Digital

(4) Frame Sequential 3D Signal

SVGA	800 x 600	1.33	4:3	120	V	V	V	V	V	V	V	
XGA	1024 x 768				V	V	V	V	V	V	V	
HDTV	1280 x 720	1.78	16:9		60	V	V	V	V	V	V	V
WXGA	1280 x 800	1.60				V	V	V	V	V	V	V
1080p	1920 x 1080	1.78				V	V	V	V	V	V	V
WUXGA	1920 x 1200	1.6	16:10			V	V	V	V	V	V	V
Modes	Resolution			Aspect Ratio		V Sync (Hz)	RGB			YCbCr 4:4:4		
					8 bit	10 bit	12 bit	8 bit	10 bit	12 bit	8 bit	

(5) 4K (*) Signal

3840 x 2160	3840 x 2160	1.78	16:9	24	V	V	V	V	V	V	V
				25	V	V	V	V	V	V	V
				30	V	V	V	V	V	V	V
				50	V	X	X	V	X	X	V
				60	V	X	X	V	X	X	V
4096 x 2160 SMPTE	4096 x 2160	1.90	256:135	24	V	V	V	V	V	V	V
				25	V	V	V	V	V	V	V
				30	V	V	V	V	V	V	V
				50	V	X	X	V	X	X	V
				60	V	X	X	V	X	X	V

- ❖ "V" video format is supported.
- ❖ "X" video format is not supported.
- ❖ "*" 4K is not supported if the source is HDMI 2.

Appendices

C. HDBaseT Digital														
(1) PC Signal														
Modes	Resolution	Aspect Ratio		V Sync (Hz)	RGB			YCbCr 4:4:4			YCbCr 4:2:2			
					8 bit	10bit	12 bit	8 bit	10 bit	12 bit	8 bit			
VGA	640 x 350	1.8	64:35	85	V	V	V	V	V	V	V	V		
	640 x 400	1.6	16:10	85	V	V	V	V	V	V	V	V		
	640 x 480	1.33	4:3	60	V	V	V	V	V	V	V	V	V	
				72	V	V	V	V	V	V	V	V	V	
				75	V	V	V	V	V	V	V	V	V	V
				85	V	V	V	V	V	V	V	V	V	V
	720 x 400	1.8	9:5	70	V	V	V	V	V	V	V	V	V	
				85	V	V	V	V	V	V	V	V	V	V
SVGA	800 x 600	1.33	4:3	60	V	V	V	V	V	V	V	V		
				72	V	V	V	V	V	V	V	V	V	
				75	V	V	V	V	V	V	V	V	V	
				85	V	V	V	V	V	V	V	V	V	
				120	V	V	V	V	V	V	V	V	V	
	832 x 624			75	V	V	V	V	V	V	V	V		
848 x 480	1.77	53:30	60	V	V	V	V	V	V	V	V			
XGA	1024 x 768	1.33	4:3	60	V	V	V	V	V	V	V	V		
				70	V	V	V	V	V	V	V	V		
				75	V	V	V	V	V	V	V	V		
				85	V	V	V	V	V	V	V	V		
				120	V	V	V	V	V	V	V	V		
SXGA	1152 x 864			75	V	V	V	V	V	V	V	V		
	1152 x 870	1.32	192:145	75	V	V	V	V	V	V	V	V		
WXGA	1280 x 768	1.67	5:3	60	V	V	V	V	V	V	V	V		
				75	V	V	V	V	V	V	V	V		
				85	V	V	V	V	V	V	V	V		
	1280 x 800	1.6	16:10	60	V	V	V	V	V	V	V	V		
				75	V	V	V	V	V	V	V	V		
				85	V	V	V	V	V	V	V	V		
			120	V	V	V	V	V	V	V	V			

Appendices

C. HDBaseT Digital											
Modes	Resolution	Aspect Ratio		V Sync (Hz)	RGB			YCbCr 4:4:4			YCbCr 4:2:2
					8 bit	10bit	12bit	8 bit	10bit	12bit	8 bit
SXGA	1280 x 960	1.33	4:3	60	V	V	V	V	V	V	V
				85	V	V	V	V	V	V	V
	1280 x 1024	1.25	5:4	60	V	V	V	V	V	V	V
				75	V	V	V	V	V	V	V
				85	V	V	V	V	V	X	V
WXGA	1360 x 768	1.78	16:9	60	V	V	V	V	V	V	V
	1366 x 768				V	V	V	V	V	V	V
SXGA+	1400 x 1050	1.33	4:3	60	V	V	V	V	V	V	V
WXGA+	1440 x 900	1.6	16:10		V	V	V	V	V	V	V
					75	V	V	V	V	V	V
				85	V	V	V	V	V	V	V
WXGA++	1600 x 900	1.78	16:9	60	V	V	V	V	V	V	V
UXGA	1600 x 1200	1.33	4:3	50	V	V	V	V	V	V	V
				60	V	V	V	V	V	X	V
WSXGA+	1680 x 1050	1.6	16:10	60	V	V	V	V	V	V	V
WUXGA RB	1920 x 1200RB				50	V	V	V	V	V	V
			60	V	V	V	V	V	X	V	
(2) TV Signal											
SDTV (480i)	720 x 480	1.5	3:2	59.94	V	V	V	V	V	V	V
				60	V	V	V	V	V	V	V
SDTV (576i)	720 x 576	1.25	5:4	50	V	V	V	V	V	V	V
EDTV (480p)	720 x 480	1.5	3:2	59.94	V	V	V	V	V	V	V
				60	V	V	V	V	V	V	V

Appendices

C. HDBaseT Digital												
EDTV (576p)	720 x 576	1.25	5:4	50	V	V	V	V	V	V	V	V
HDTV (1080i)	1920 x 1080	1.78	16:9		V	V	V	V	V	V	V	V
HDTV (720p)	1280 x 720			59.94	V	V	V	V	V	V	V	V
		60	V	V	V	V	V	V	V	V	V	
		50	V	V	V	V	V	V	V	V	V	
		59.94	V	V	V	V	V	V	V	V	V	
HDTV (720p)	1280 x 720	60	V	V	V	V	V	V	V	V	V	
		120	V	V	V	V	V	V	V	V	V	
Modes	Resolution	Aspect Ratio		V Sync (Hz)	RGB			YCbCr 4:4:4			YCbCr 4:2:2	
					8 bit	10bit	12 bit	8 bit	10 bit	12 bit	8 bit	
HDTV (1080p)	1920 x 1080	1.78	16:9	23.98	V	V	V	V	V	V	V	
				24	V	V	V	V	V	V	V	
				25	V	V	V	V	V	V	V	
				29.97	V	V	V	V	V	V	V	
				30	V	V	V	V	V	V	V	
				50	V	V	V	V	V	V	V	
				59.94	V	V	V	V	V	V	V	
				60	V	V	V	V	V	V	V	
(3) Mandatory 3D Signal												
Frame Packing (1080p)	1920 x 1080	1.78	16:9	23.98	V	V	V	V	V	V	V	V
				24	V	V	V	V	V	V	V	V
Frame Packing (720p)	1280 x 720			50	V	V	V	V	V	V	V	
				59.94	V	V	V	V	V	V	V	
				60	V	V	V	V	V	V	V	
Side by Side (1080i)	1920 x 1080			50	V	V	V	V	V	V	V	
				59.94	V	V	V	V	V	V	V	
				60	V	V	V	V	V	V	V	
Top and Bottom (720p)	1280 x 720			50	V	V	V	V	V	V	V	
				59.94	V	V	V	V	V	V	V	
				60	V	V	V	V	V	V	V	
Top and Bottom (1080p)	1920 x 1080			23.98	V	V	V	V	V	V	V	
				24	V	V	V	V	V	V	V	

Appendices

C. HDBaseT Digital

(4) Frame Sequential 3D Signal

SVGA	800 x 600	1.33	4:3	120	V	V	V	V	V	V	V
XGA	1024 x 768				V	V	V	V	V	V	V
HDTV	1280 x 720	1.78	16:9		V	V	V	V	V	V	V
WXGA	1280 x 800	1.60	16:10		V	V	V	V	V	V	V
1080p	1920 x 1080	1.78	16:9	60	V	V	V	V	V	V	V
WUXGA	1920 x 1200	1.6	16:10		V	V	V	V	V	V	V

❖ "V" video format is supported.

❖ "X" video format is not supported.

Configurations of Terminals

Terminal: Computer In (D-sub 15 pin)



1	Red (R) Input [R Output]	9	DDC 5V [NC*]
2	Green (G) Input [G Output]	10	Ground (Ver. sync.)
3	Blue (B) Input [B Output]	11	NC*
4	NC*	12	DDC Data [NC*]
5	Ground (Horiz.sync.)	13	Horiz. sync. Input [Output] (Composite H/V sync. Input)
6	Ground (Red)		
7	Ground (Green)	14	Vert. sync. Input [Output]
8	Ground (Blue)	15	DDC CLK [NC*]

* Do not connect anything.

Terminal: PC Control (D-sub 9 pin)

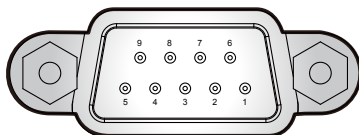

1	NC*	6	NC*
2	TXD (Sending Data)	7	NC*
3	RXD (Receiving Data)	8	NC*
4	NC*	9	NC*
5	GND	* Do not connect anything.	

Note

- ❖ Contact your dealer for control cable and commands.

Appendices

PC Control Terminal Setting

Items	Method
Communication Method	Asynchronous Communication
Baud Rate	9600
Data Bits	8 bits
Parity	None
Stop Bits	1
Flow Control	None

PC Control Terminal Signals Connection

Computer COM Port (D-Sub 9-pin connector) Projector PC Control Terminal (D-Sub 9-pin connector)

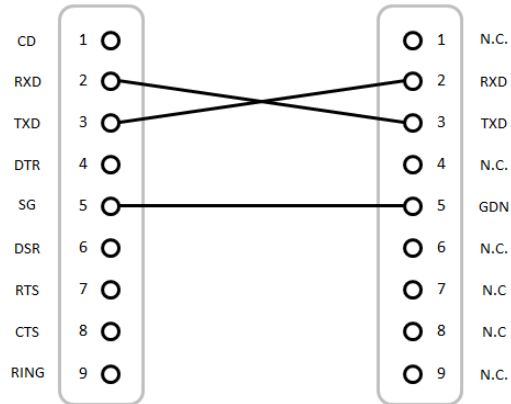

Note

- ❖ D-sub 9p shell is grounded. Use a crossover cable sold in the market.

Terminal: AUDIO IN/ AUDIO OUT

Note

- ❖ Plug-in power is not supported.

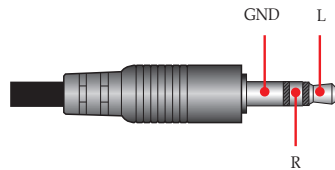

Appendices

Specifications

■ List of general specifications

Item	WUL6670	WUL6680	WUL6690
Type (Resolution)	DLP® (WUXGA)		
Dimension (WxDxH)	486 x 376 x 150 mm (W/O feet)		
Weight (projector)	Approx. 12kg	Approx. 13.5kg	
Inputs	<ul style="list-style-type: none"> • HDMI 1 v2.0 HDCP2.2 • HDMI 2 v1.4 HDCP1.4 • Computer In • 3D Sync In • Audio In (3.5mm stereo mini jack) • HDBaseT In 		
Outputs	<ul style="list-style-type: none"> • HDMI Out • 3D Sync Out • Audio Out (3.5mm stereo mini jack) • DC 5V/1.5A (USB-Type A) • Trigger Out (12V)(Phone jack) 		
Control	<ul style="list-style-type: none"> • Remote In (3.5mm mini jack) • LAN (support web control) • PC-Control (D-sub 9pin (RS232)) 		
Speaker	2x 10W		
Laser diode life	20,000h		
Image size	40" - 300"	30" - 300"	
Projection distance	Tele	1.30 - 9.96m	1.26 - 13.06m
	Wide	1.03 - 7.95m	0.77 - 8.22m
Throw Ratio (distance/width)	1.22-1.53	1.25-2.0	
Zoom Ratio	1.25x	1.6x	
Zoom/Focus	Power	Power	
Noise Level (typ.) (Normal/Eco)	30dB(A) / 25dB(A)	34dB(A) / 27dB(A)	36dB(A) / 27dB(A)
Environment	<ul style="list-style-type: none"> • Operational Temperatures: 0° to 40°C (32° to 104°F); up to 85% humidity (noncondensing) • Storage Temperatures: -10° to 60°C (14° to 140°F); up to 90% humidity (noncondensing) 		
Power Consumption	<ul style="list-style-type: none"> • Normal: 470W Max. • Eco: 235W Max. 	<ul style="list-style-type: none"> • Normal: 620W Max. • Eco: 310W Max. 	
Power Supply	100-240Vac; 50-60Hz		
Standby Power	0.5W or less / less than 8W (Network standby)		

NOTE

- This model complies with the above specifications.
- Designs and specifications are subject to change without notice.
- This model may not be compatible with features and/or specifications that may be added in the future.

Cabinet Dimensions

Unit: mm

RICOH PJ WUL6670

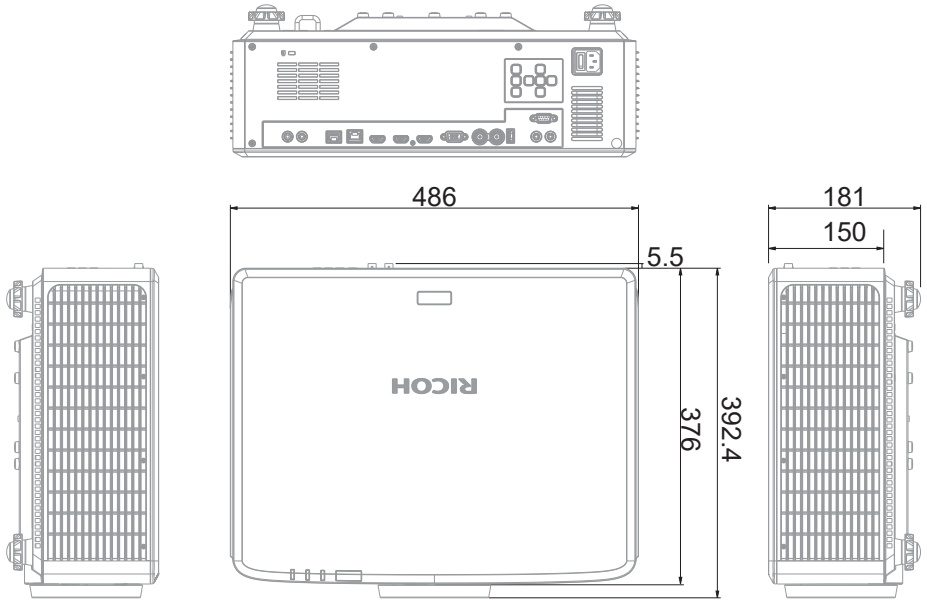

Appendices

Unit: mm

RICOH PJ WUL6680/WUL6690

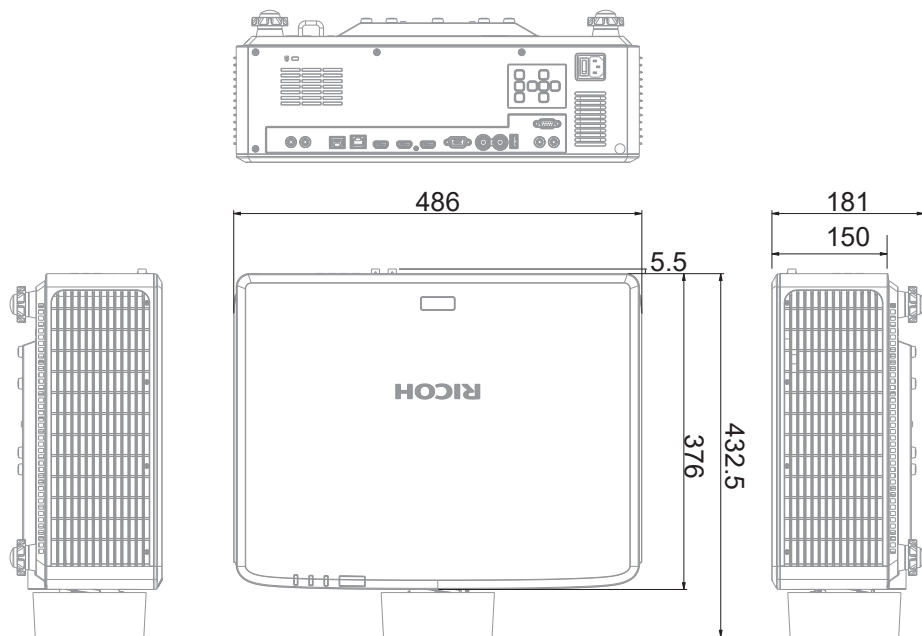

Ceiling Mount Installation

Unit: mm

Note

- ❖ Mounting holes for ceiling mount.
- ❖ Please note that damage resulting from incorrect installation will void the warranty.

1. To prevent damage to your projector, please use the RICOH ceiling mount.
2. If you wish to use a third party ceiling mount kit, please ensure the screws used to attach a mount to the projector meet the following specifications:
 - Screw type: M4*4 pcs;
 - Maximum screw length: 8 mm

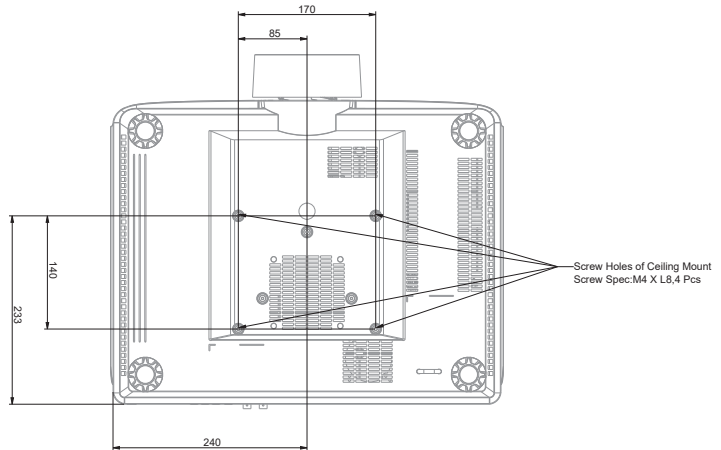
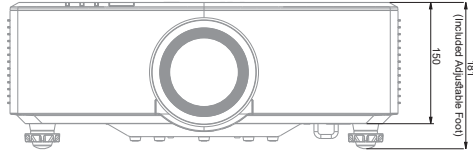

Copyrights

This projector uses open source and/or third party software. To check the information about software copyrights, see “Software License” in the web control panel. You can also view and download the source code from: http://www.support-download.com/bb/html/dr_ut_e/oss/index.htm

Trademarks

- DLP is trademarks or registered trademark of Texas Instruments.
- Chrome is trademark or registered trademark of Google LLC.
- Microsoft, Windows, and Microsoft Edge are either a registered trademark or trademark of Microsoft Corporation in the United States and/or other countries.
- Firefox is a trademark of the Mozilla Foundation in the U.S. and other countries.
- HDMI, the HDMI Logo and High-Definition Multimedia Interface are trademarks or registered trademarks of HDMI Licensing Administrator, Inc.
- Kensington is a trademark or registered trademark of ACCO Brands.
- Blu-ray is a trademark of Blu-ray Association.
- Extron is a registered trademark of Extron Electronics, Inc. of the United States.
- AMX is a registered trademark of AMX LLC of the United States.
- Trademark PJLink is a trademark applied for trademark rights in Japan, the United States of America and other countries and areas.
- Other product and company names mentioned in this user’s manual may be the trademarks or registered trademarks of their respective holders.

