

# User's Guide

## XGS1210-12 / XGS1250-12

### Default Login Details

Management IP Address	http://192.168.1.3
Password	1234

Version 2.00 Edition 1, 8/2023

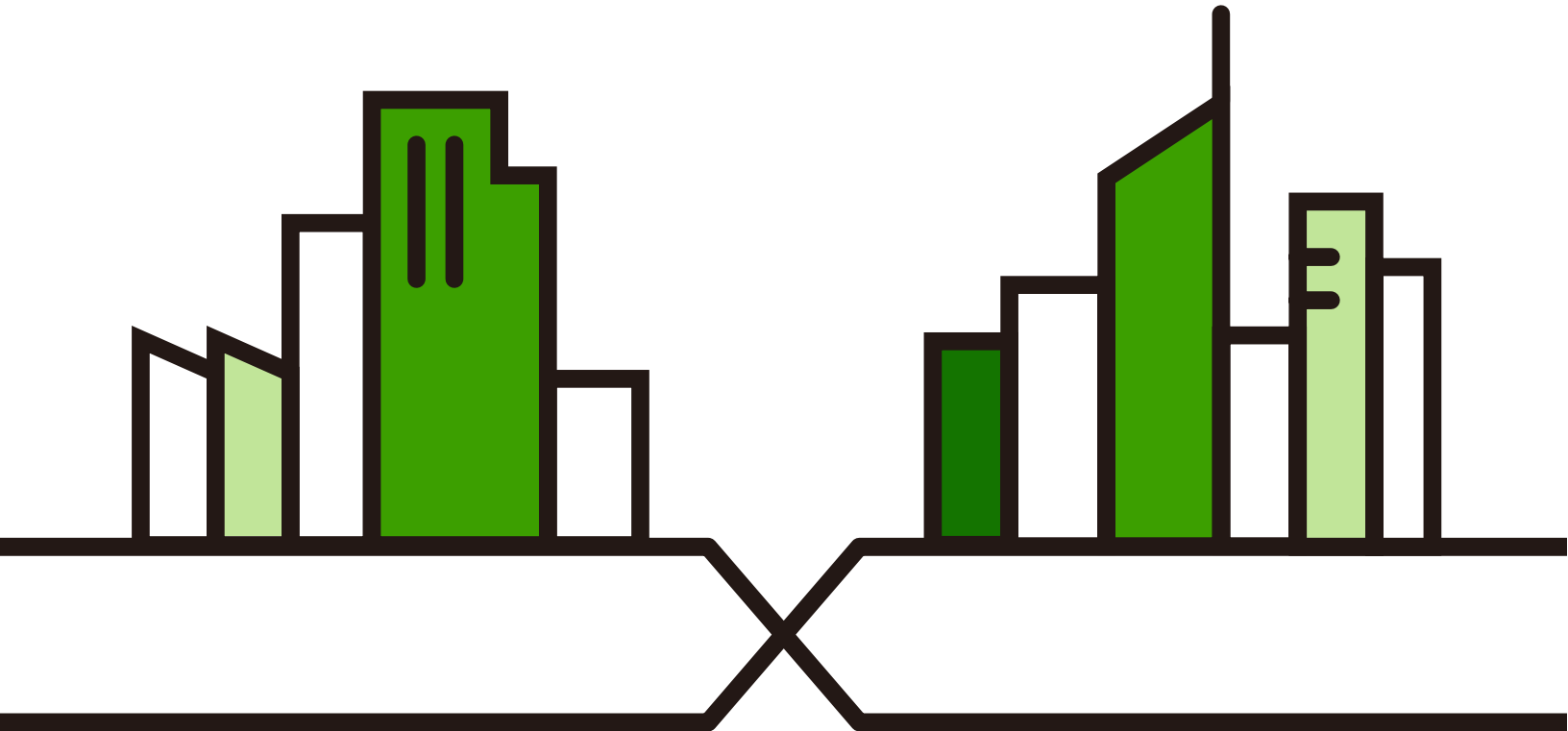

---

**IMPORTANT!**

**READ CAREFULLY BEFORE USE.**

**KEEP THIS GUIDE FOR FUTURE REFERENCE.**

Screenshots and graphics in this book may differ slightly from your product due to differences in your product firmware or your computer operating system. Every effort has been made to ensure that the information in this manual is accurate.

### **Related Documentation**

- Quick Start Guide

The Quick Start Guide shows how to connect the Switch and access the Web Configurator.

- More Information

Go to [support.zyxel.com](http://support.zyxel.com) to find other information on the Switch.



# Document Conventions

## Warnings and Notes

These are how warnings and notes are shown in this guide.

**Warnings tell you about things that could harm you or your device.**









Note: Notes tell you other important information (for example, other things you may need to configure or helpful tips) or recommendations.

## Syntax Conventions

- The XGS1210-12 and XGS1250-12 may be referred to as the “Switch” in this guide.
- Product labels, screen names, field labels and field choices are all in **bold** font.
- A right angle bracket ( > ) within a screen name denotes a mouse click. For example, **QoS > Port-Based QoS** means you first click **QoS** in the navigation panel, then the **Port-Based QoS** sub menu to get to that screen.

## Icons Used in Figures

Figures in this user guide may use the following generic icons. The Switch icon is not an exact representation of your device.

Switch 	Generic Switch 	Generic Router 
IP Camera 	Firewall 	Cell Tower 
Printer 	Server 	

# Contents Overview

<b>User's Guide</b> .....	<b>8</b>
Getting to Know Your Switch .....	9
Hardware Installation .....	14
Hardware Panels .....	17
Web Configurator .....	21
Initial Setup Example .....	30
Tutorials .....	33
<b>Technical Reference</b> .....	<b>37</b>
System .....	38
Port .....	42
VLAN .....	47
Link Aggregation .....	50
Mirroring .....	52
QoS .....	54
IGMP Snooping .....	58
Management .....	60
Troubleshooting .....	65

# Table of Contents

<b>Document Conventions .....</b>	<b>3</b>
<b>Contents Overview .....</b>	<b>4</b>
<b>Table of Contents .....</b>	<b>5</b>
<b>Part I: User's Guide.....</b>	<b>8</b>
<b>Chapter 1</b>	
<b>Getting to Know Your Switch .....</b>	<b>9</b>
1.1 Overview .....	9
1.1.1 Model Feature Differences .....	9
1.1.2 Hardware Version Information .....	9
1.2 Applications .....	10
1.2.1 Multi-Gigabit .....	10
1.2.2 Backbone Application .....	11
1.2.3 Bridging Application .....	12
1.2.4 VLAN Application Example .....	12
1.3 Way to Manage the Switch .....	13
1.4 Good Habits for Managing the Switch .....	13
<b>Chapter 2</b>	
<b>Hardware Installation .....</b>	<b>14</b>
2.1 Installation Scenarios .....	14
2.2 Safety Precautions .....	14
2.2.1 Freestanding Installation Procedure .....	14
2.2.2 Wall Mounting .....	15
<b>Chapter 3</b>	
<b>Hardware Panels.....</b>	<b>17</b>
3.1 Hardware Overview .....	17
3.2 Front Panel .....	17
3.3 Rear Panel .....	17
3.3.1 Power Connector .....	18
3.3.2 Smart Fan (for XGS1250-12) .....	18
3.4 LEDs .....	19
<b>Chapter 4</b>	
<b>Web Configurator.....</b>	<b>21</b>

4.1 Overview .....	21
4.2 System Login .....	21
4.3 Zyxel One Network (ZON) Utility .....	22
4.3.1 Requirements .....	22
4.3.2 Run the ZON Utility .....	23
4.4 Web Configurator Layout .....	26
4.4.1 Change Your Password .....	28
4.5 Switch Lockout/Resetting the Switch .....	28
4.6 Logging Out of the Web Configurator .....	29
<b>Chapter 5</b>	
<b>Initial Setup Example .....</b>	<b>30</b>
5.1 Overview .....	30
5.1.1 Change the IP Address .....	30
5.1.2 Change the Password .....	31
<b>Chapter 6</b>	
<b>Tutorials .....</b>	<b>33</b>
6.1 Overview .....	33
6.2 Creating a VLAN .....	33
6.3 Setting Port VID .....	35
<b>Part II: Technical Reference .....</b>	<b>37</b>
<b>Chapter 7</b>	
<b>System .....</b>	<b>38</b>
7.1 Overview .....	38
7.2 System Settings .....	38
<b>Chapter 8</b>	
<b>Port .....</b>	<b>42</b>
8.1 Overview .....	42
8.1.1 What You Need to Know .....	42
8.2 Port Settings .....	43
<b>Chapter 9</b>	
<b>VLAN .....</b>	<b>47</b>
9.1 Overview .....	47
9.1.1 What You Need to Know .....	47
9.2 VLAN Settings .....	48

---

<b>Chapter 10</b>	
<b>Link Aggregation</b> .....	<b>50</b>
10.1 Overview .....	50
10.2 Link Aggregation .....	50
<b>Chapter 11</b>	
<b>Mirroring</b> .....	<b>52</b>
11.1 Overview .....	52
11.2 Mirroring Settings .....	52
<b>Chapter 12</b>	
<b>QoS</b> .....	<b>54</b>
12.1 Overview .....	54
12.2 What You Need to Know .....	54
12.2.1 Port-Based QoS .....	54
12.2.2 IEEE 802.1p QoS .....	54
12.2.3 Weighted Round Robin Scheduling (WRR) .....	55
12.3 Port-Based QoS .....	55
12.4 IEEE 802.1p QoS .....	56
<b>Chapter 13</b>	
<b>IGMP Snooping</b> .....	<b>58</b>
13.1 Overview .....	58
13.2 IGMP Snooping Settings .....	58
<b>Chapter 14</b>	
<b>Management</b> .....	<b>60</b>
14.1 Overview .....	60
14.1.1 What You Need to Know .....	60
14.2 Management Settings .....	61
14.2.1 Firmware Upgrade .....	63
<b>Chapter 15</b>	
<b>Troubleshooting</b> .....	<b>65</b>
15.1 Power, Hardware Connections, and LEDs .....	65
15.2 Switch Access and Login .....	66
15.3 Switch Configuration .....	67
Appendix A Customer Support .....	68
Appendix B Legal Information .....	73
<b>Index</b> .....	<b>77</b>

---

# PART I

## User's Guide

---



# CHAPTER 1

## Getting to Know Your Switch

### 1.1 Overview

Switch refers to these models as outlined below.

- XGS1210-12
- XGS1250-12

#### 1.1.1 Model Feature Differences

Note the following differences between the Switch models:

Table 1 Model Feature Comparison

FEATURE/MODEL	XGS1210-12	XGS1250-12
VLAN (Virtual Local Area Network)	YES	YES
QoS (Quality of Service)	YES	YES
Switch Management	YES	YES
Link Aggregation	YES	YES
Port Mirroring	YES	YES
IGMP Snooping	YES	YES
IEEE 802.3az (Energy Efficient Ethernet Standard)	YES	YES
Management VLAN	YES	YES
HTTP or HTTPS enable	YES	YES
Save configuration	YES	YES
Upload stored device configuration file	YES	YES
1G, 10G SFP+ interface	2	1
100M, 1000M, 2.5G Ethernet Ports	2	NO
100M, 1000M, 2.5G, 5G, 10G Ethernet Ports	NO	3
10M, 100M, 1000M Ethernet Ports	8	8
Multi-Gigabit Ethernet	Up to 2.5G	Up to 10G

#### 1.1.2 Hardware Version Information

The XGS1210-12/1250-12 series have hardware revisions. To find out the hardware version of your Switch, see the back label on the Switch.

Figure 1 Example Back Label

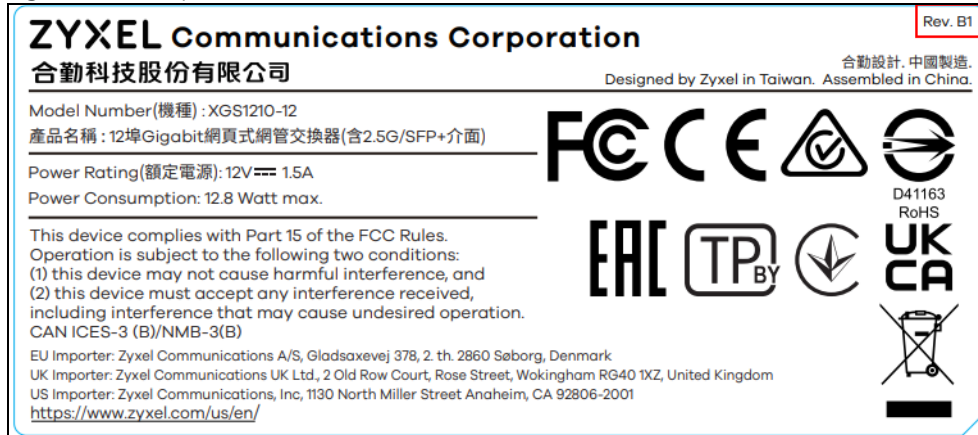

Note: The **Rev.** information is not shown on the back label of the **A1** hardware version of XGS1210-12/1250-12 series models.

## 1.2 Applications

This section shows a few examples of using the Switch in various network environments.

### 1.2.1 Multi-Gigabit

Multi-Gigabit Ethernet ports automatically allow connections up to the speed of the connected network device (100M, 1G, 2.5G, 5G, or 10G), and you just need to use a CAT 5e or CAT 6 Ethernet cable. You must use CAT 6A or better Ethernet cables to achieve 10G speeds.

Figure 2 Multi-Gigabit Application (XGS1210-12)

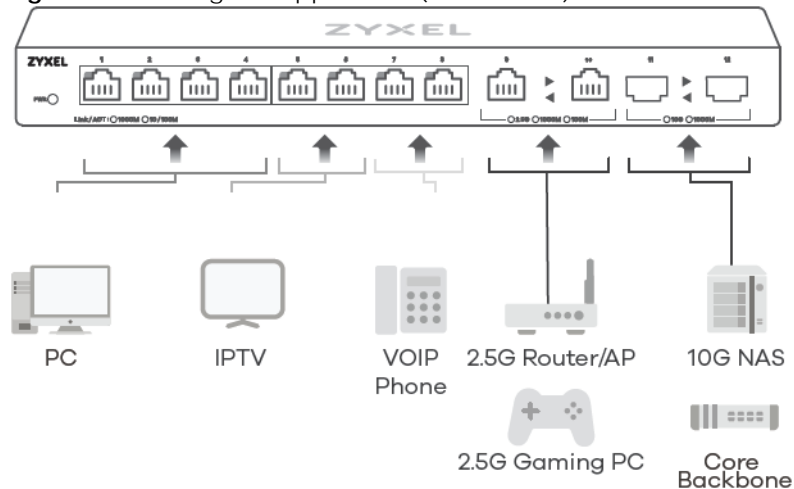
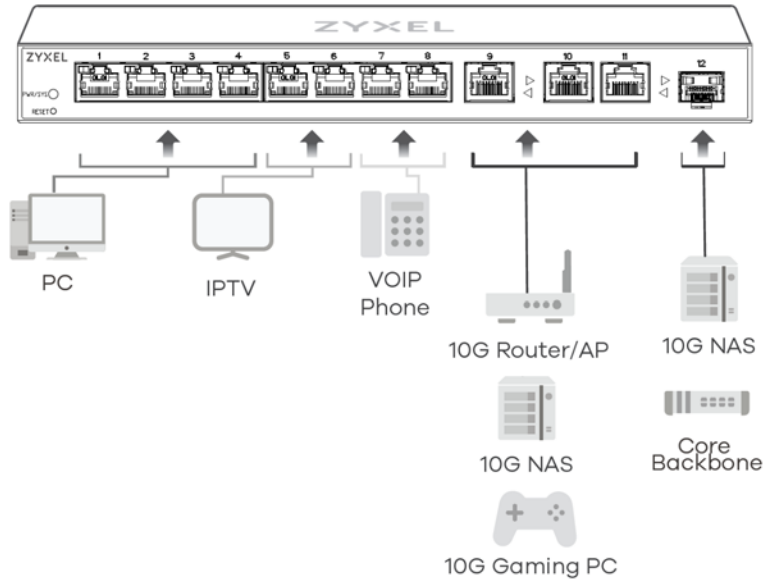

Figure 3 Multi-Gigabit Application (XGS1250-12)



See the following table for the cables required and distance limitation to attain the corresponding speed. Make sure to select the correct speed for the port in **Port > Port Setting**.

Table 2 Cable Types

CABLE	TRANSMISSION SPEED	MAXIMUM DISTANCE	BANDWIDTH CAPACITY
Category 5	100M	100 m	100 MHz
Category 5e	1G / 2.5G / 5G*	100 m	100 MHz
Category 6	5G / 10G	100 m / 55 m	250 MHz
Category 6a	10G	100 m	500 MHz
Category 7	10G	100 m	600 MHz

\*In good quality and no interference, the category 5e cable can support 5Gbp speed and maximum distances up to 100m.

## 1.2.2 Backbone Application

The Switch is an ideal solution for small networks where rapid growth can be expected in the near future. The Switch can be used standalone for a group of heavy traffic users. You can connect computers and servers directly to the Switch's port or connect other switches to the Switch.

In this example, all computers can share high-speed applications on the server. To expand the network, simply add more networking devices such as switches, routers, computers, print servers, and so on.

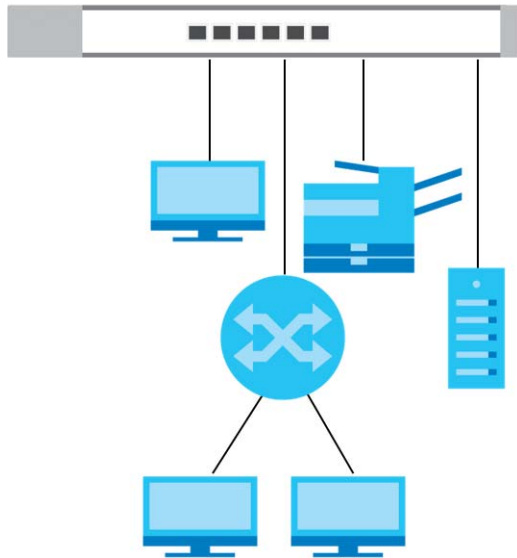
**Figure 4** Backbone Application

### 1.2.3 Bridging Application

In this example the Switch connects different company departments (**RD** and **Sales**) to the corporate backbone. It can alleviate bandwidth contention and eliminate server and network bottlenecks. All users that need high bandwidth can connect to high-speed department servers via the Switch.

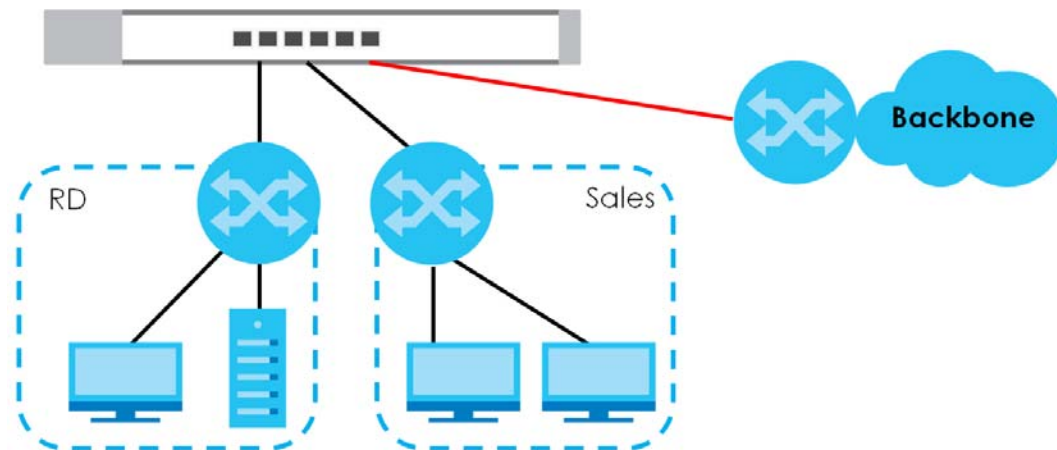
**Figure 5** Bridging Application

### 1.2.4 VLAN Application Example

A VLAN (Virtual Local Area Network) allows a physical network to be partitioned into multiple logical networks. Stations on a logical network belong to one or more groups. With VLAN, a station cannot directly talk to or hear from stations that are not in the same groups unless such traffic first goes through a router.

### 1.2.4.1 Tag-based VLAN Example

Ports in the same VLAN group share the same frame broadcast domain, thus increasing network performance by reducing broadcast traffic. VLAN groups can be modified at any time by adding, moving or changing ports without any re-cabling.

Shared resources such as a server can be used by all ports in the same VLAN as the server. In the following figure only ports that need access to the server need to be part of VLAN1. Ports can belong to other VLAN groups too.

**Figure 6** Shared Server Using VLAN Example

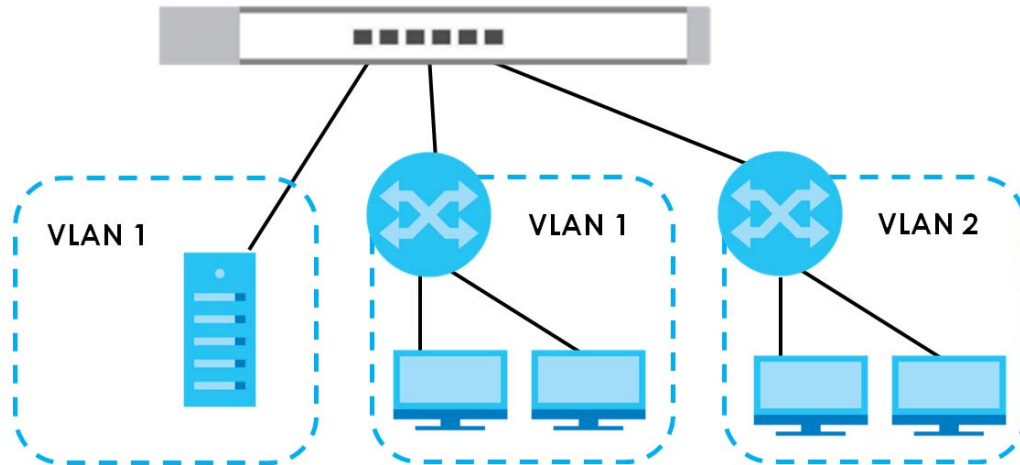

## 1.3 Way to Manage the Switch

Use the Web Configurator to manage the Switch. This allows easy Switch setup and management using a (supported) web browser. See [Chapter 4 on page 21](#).

## 1.4 Good Habits for Managing the Switch

Do the following things regularly to make the Switch more secure and to manage the Switch more effectively.

- Change the password. Use a password that is not easy to guess and that consists of different types of characters, such as numbers and letters.
- Write down the password and put it in a safe place.
- Back up the configuration (and make sure you know how to restore it). Restoring an earlier working configuration may be useful if the device becomes unstable or even crashes. If you forget your password, you will have to reset the Switch to its factory default settings. If you backed up an earlier configuration file, you would not have to totally re-configure the Switch. You could simply restore your last configuration.

# CHAPTER 2

## Hardware Installation

### 2.1 Installation Scenarios

This chapter shows you how to install and connect the Switch.

### 2.2 Safety Precautions

Please observe the following before using the Switch:

- Do NOT stack Switches with fans (for XGS1250-12).
- It is recommended to ask an authorized technician to attach the Switch on a desk or to the rack or wall. Use the proper screws to prevent damage to the Switch. See the **Screw Specifications** figures in this chapter to know the types of screws and screw drivers for each model.
- Make sure there is at least 2 cm of clearance on the top and bottom of the Switch, and at least 5 cm of clearance on all four sides of the Switch. This allows air circulation for cooling.
- Do NOT block the ventilation holes nor store cables or power cords on the Switch. Allow clearance for the ventilation holes to prevent your Switch from overheating. This is especially crucial when your Switch does not have fans. Overheating could affect the performance of your Switch, or even damage it.
- The surface of the Switch could be hot when it is functioning. Do NOT put your hands on it. You may get burned. This could happen especially when you are using a fanless Switch.
- The Switches with fans are not suitable for use in locations where children are likely to be present.

To start using the Switch, simply connect the power cables and turn it on.

#### 2.2.1 Freestanding Installation Procedure

- 1 Make sure the Switch is clean and dry.
- 2 Attach the rubber feet as shown if they are not already attached – see [Figure 7 on page 15](#).
- 3 Set the Switch on a smooth, level surface strong enough to support the weight of the Switch and the connected cables. Make sure there is a power outlet nearby.
- 4 Make sure there is enough space around the Switch to allow the attachment of cables and the power cord, and sufficient air circulation.

Note: Make sure you are using the correct type of Ethernet cable (CAT 5e, 6UTP/STP, or better Ethernet cable). See [Table 2 on page 11](#) for more information.

Figure 7 Attach Rubber Feet

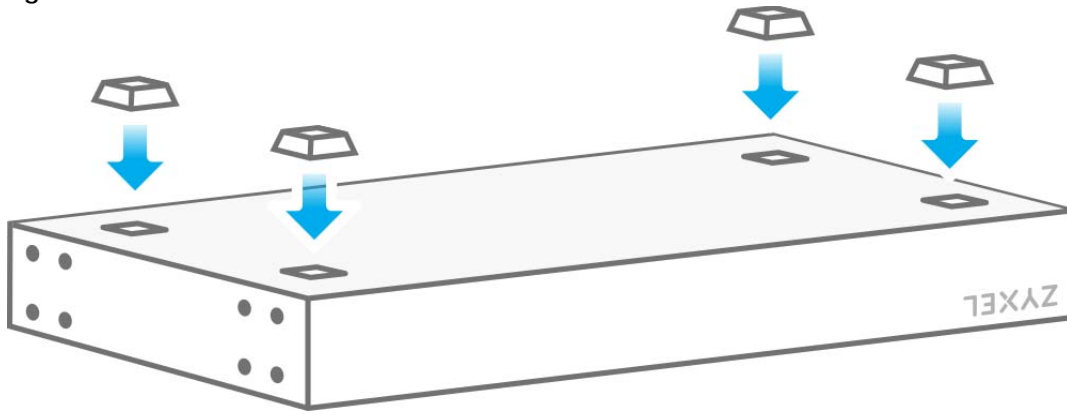

## 2.2.2 Wall Mounting

Table 3 Wall Mounting Distance

DISTANCE 'D' BETWEEN MOUNTING HOLES
180 mm / 7.09 in

Do the following to mount your Switch on a wall.

- 1 Drill two holes on the wall at the distance of 'D' – see [Figure 8 on page 15](#).
- 2 Insert screw anchors and screws (not provided) into the holes. Leave a small gap between the head of the screw and the wall.
- 3 The gap must be big enough for the screws to slide into the wall mount holes and the power cord to run down the back of the Switch.

Note: Make sure the screws are securely fixed to the wall and strong enough to hold the weight of the Switch with the connection cables.

- 4 Place the Switch so the wall mount holes line up with the screws. Slide the Switch down gently to fix it into place.

**Wall-mount the Switch with the Ethernet ports facing down and the ventilation holes on the side.**

Figure 8 Wall Mounting

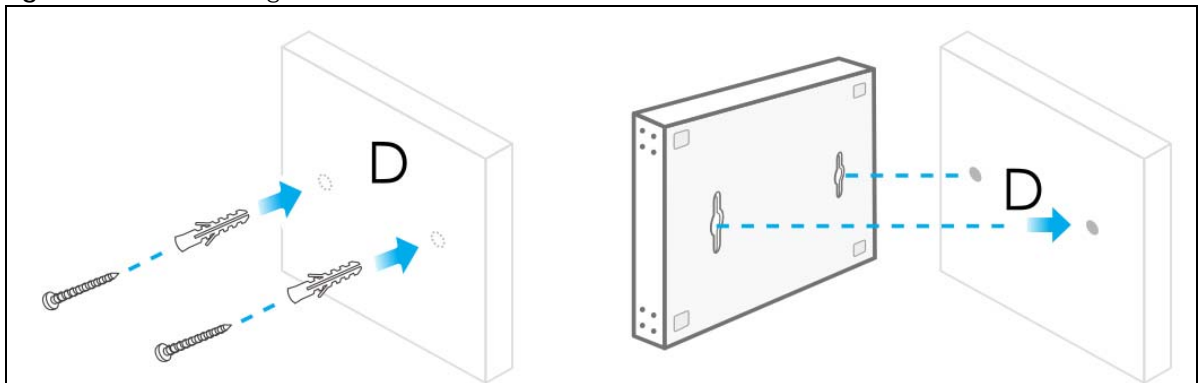

**Figure 9** Screw Specifications (XGS1210-12)

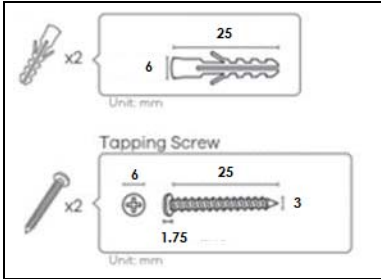

**Figure 10** Screw Specifications (XGS1250-12)

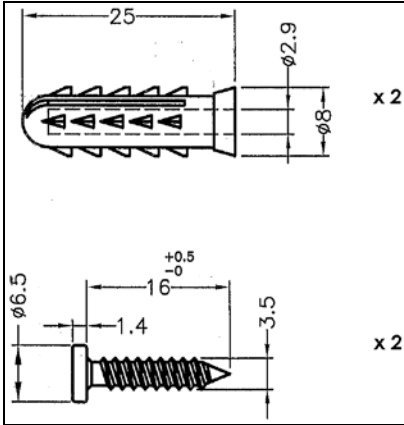



# CHAPTER 3

## Hardware Panels

### 3.1 Hardware Overview

This section describes the front and rear panels for each model.

The following table summarizes the port features of the Switch by model.

Table 4 Port Comparison Table

MODELS	XGS1210-12	XGS1250-12
10M / 100M / 1000M Ethernet Ports	8	8
100M / 1000M / 2.5G Ethernet Ports	2	–
100M / 1000M / 2.5G / 5G / 10G Ethernet Ports	–	3
10G SFP+ interface	2	1

### 3.2 Front Panel

The following figure shows the front panel of the Switch.

Figure 11 Front Panel: XGS1210-12 (A1)

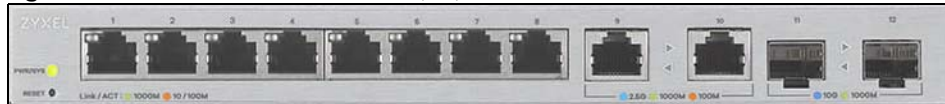

Figure 12 Front Panel: XGS1210-12 (B1)

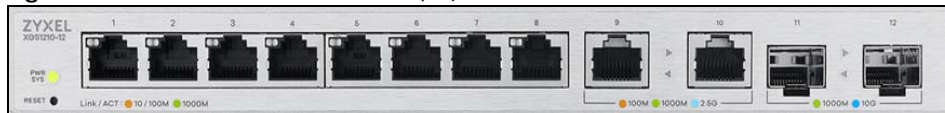
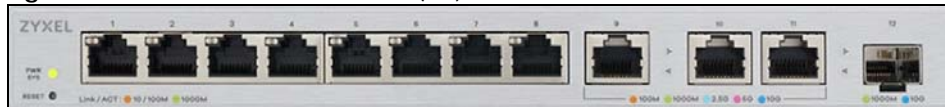

Figure 13 Front Panel: XGS1250-12 (A1)



### 3.3 Rear Panel

The following figure shows the rear panel of the Switch.

**Figure 14** Rear Panel: XGS1210-12 (A1/B1)



**Figure 15** Rear Panel: XGS1250-12 (A1)



### 3.3.1 Power Connector

Note: Make sure you are using the correct power source as shown on the panel.

To connect power to the Switch, insert the female end of the power cord to the AC power receptacle on the rear panel. Connect the other end of the supplied power cord to a power outlet. Make sure that no objects obstruct the airflow.

### 3.3.2 Smart Fan (for XGS1250-12)

A properly functioning fan is essential, along with a sufficiently ventilated and cool operating environment, to prevent the Switch from overheating.

With Smart Fan, the fan in the Switch automatically adjust its speed according to the internal temperature. This prevents overheating, minimizes noise, and reduces power consumption.

## 3.4 LEDs

After you connect the power to the Switch, view the LEDs to ensure proper functioning of the Switch and as an aid in troubleshooting.

Table 5 LED Descriptions (XGS1210-12)

LED	COLOR	STATUS	DESCRIPTION
PWR/SYS	Green	On	The Switch power is on.
		Blinking	The Switch is starting up.
		Off	The Switch power is off.
Ports 1-8 LINK/ACT	Green	On	The port has a successful 1000M connection.
		Blinking	The Switch is transmitting data through the port.
	Amber	On	The port has a successful 10M / 100M connection.
		Blinking	The Switch is transmitting data through the port.
		Off	The port is disconnected or disabled.  If you enable <b>Loop Prevention</b> in the <b>Port</b> screen, and a loop happens on two ports, the higher-numbered port will be off.
	Port 9 (Left LED) ◁  Port 10 (Right LED) ▷	Sky Blue	On
Blinking			The Switch is transmitting data through the port.
Green		On	The port has a successful 1000M connection.
		Blinking	The Switch is transmitting data through the port.
Amber		On	The port has a successful 100M connection.
		Blinking	The Switch is transmitting data through the port.
	Off	The port is disconnected or disabled.	
Port 11 (Left LED) ◁  Port 12 (Right LED) ▷	Blue	On	The port has a successful 10G connection.
		Blinking	The Switch is transmitting data through the port.
	Green	On	The port has a successful 1000M connection.
		Blinking	The Switch is transmitting data through the port.
		Off	The port is disconnected or disabled.

Table 6 LED Descriptions (XGS1250-12)

LED	COLOR	STATUS	DESCRIPTION
PWR/SYS	Green	On	The Switch power is on.
		Blinking	The Switch is starting up.
		Off	The Switch power is off.
Ports 1-8 LINK/ACT	Green	On	The port has a successful 1000M connection.
		Blinking	The Switch is transmitting data through the port.
	Amber	On	The port has a successful 10M / 100M connection.
		Blinking	The Switch is transmitting data through the port.
		Off	The port is disconnected or disabled.  If you enable <b>Loop Prevention</b> in the <b>Port</b> screen, and a loop happens on two ports, the higher-numbered port will be off.

Table 6 LED Descriptions (XGS1250-12) (continued)

LED	COLOR	STATUS	DESCRIPTION
Port 9 (Left LED) ▷	Blue	On	The port has a successful 10G connection.
		Blinking	The Switch is transmitting data through the port.
Port 10 (Right LED) ▷	Purple	On	The port has a successful 5G connection.
		Blinking	The Switch is transmitting data through the port.
Port 11 (Left LED) ▷	Sky Blue	On	The port has a successful 2.5G connection.
		Blinking	The Switch is transmitting data through the port.
Port 12 (Right LED) ▷	Green	On	The port has a successful 1000M connection.
		Blinking	The Switch is transmitting data through the port.
	Amber	On	The port has a successful 100M connection.
		Blinking	The Switch is transmitting data through the port.
		Off	The port is disconnected or disabled.
Port 12 (Right LED) ▷	Blue	On	The port has a successful 10G connection.
		Blinking	The Switch is transmitting data through the port.
Port 12 (Right LED) ▷	Green	On	The port has a successful 1000M connection.
		Blinking	The Switch is transmitting data through the port.
		Off	The port is disconnected or disabled.

# CHAPTER 4

## Web Configurator

### 4.1 Overview

This section introduces the configuration and functions of the Web Configurator.

The Web Configurator is an HTML-based management interface that allows easy system setup and management through Internet browser. Use a browser that supports HTML5, such as Microsoft Edge, Internet Explorer 11, Mozilla Firefox, or Google Chrome. The recommended minimum screen resolution is 1024 by 768 pixels.

In order to use the Web Configurator you need to allow:

- Web browser pop-up windows from your device.
- JavaScript (enabled by default).
- Java permissions (enabled by default).

### 4.2 System Login

- 1 Start your web browser.
- 2 Type "http://" and the IP address of the Switch (for example, the default management IP address is 192.168.1.3) in the **Location** or **Address** field. Press [ENTER]. Your computer must be in the same subnet in order to access this website address.
- 3 The login screen appears. The default password is **1234**.

**Figure 16** Web Configurator: Log In

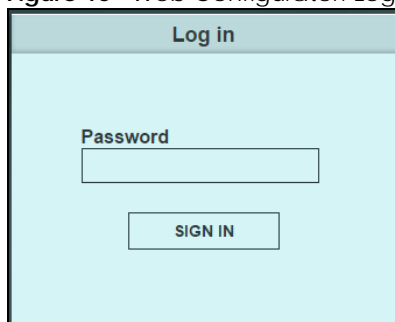

- 4 The following screen displays if you log into the Switch for the first time. Enter a new password using the keyboard characters ("a - z", "A - Z", "0 - 9", "~!@#\$\$%^&\*()\_+^`=}{[]:;<>./\"). The password must be 8 to 15 characters long. Retype it to confirm and click **Apply** to view the first Web Configurator screen.

Figure 17 Web Configurator: Change Password

**Change Password**

**New Password**

**Confirm Password**

Password can use:  
 "a-z", "A-Z", "0-9", "~!@#\$%^&\*()\_+`-='  
 {}|:;<>.^ Needs to be between 8 to 15  
 characters.

Note: Make sure to log out of the Switch from a computer before logging in again on another computer. By default, the Web Configurator automatically logs out after 5 minutes of inactivity. You can change this setting in **Management > Timeout**.

## 4.3 Zyxel One Network (ZON) Utility

ZON Utility is a program designed to help you deploy and manage a network more efficiently. It detects devices automatically and allows you to do basic settings on devices in the network without having to be near it.

The ZON Utility issues requests through Zyxel Discovery Protocol (ZDP) and in response to the query, the device responds back with basic information including IP address, firmware version, location, system and model name in the same broadcast domain. The information is then displayed in the ZON Utility screen and you can perform tasks like basic configuration of the devices and batch firmware upgrade in it. You can download the ZON Utility at [www.zyxel.com](http://www.zyxel.com) and install it in a computer (Windows operating system).

### 4.3.1 Requirements

Before installing the ZON Utility in your computer, please make sure it meets the requirements listed below.

#### Operating System

At the time of writing, the ZON Utility is compatible with:

- Windows 7 (both 32-bit / 64-bit versions)
- Windows 8 (both 32-bit / 64-bit versions)
- Windows 8.1 (both 32-bit / 64-bit versions)
- Windows 10 (both 32-bit / 64-bit versions)
- Windows 11 (both 32-bit / 64-bit versions)

Note: To check for your Windows operating system version, right-click on **My Computer > Properties**. You should see this information in the **General** tab.

## Hardware

Here are the minimum hardware requirements to use the ZON Utility on your computer.

- Core i3 processor
- 2 GB RAM
- 100 MB free hard disk
- WXGA (Wide XGA 1280 by 800)

### 4.3.2 Run the ZON Utility

- 1 Double-click the ZON Utility to run it.
- 2 The first time you run the ZON Utility, you will see if your device and firmware version support the ZON Utility. Click the **OK** button to close this screen.

**Figure 18** Supported Devices and Versions

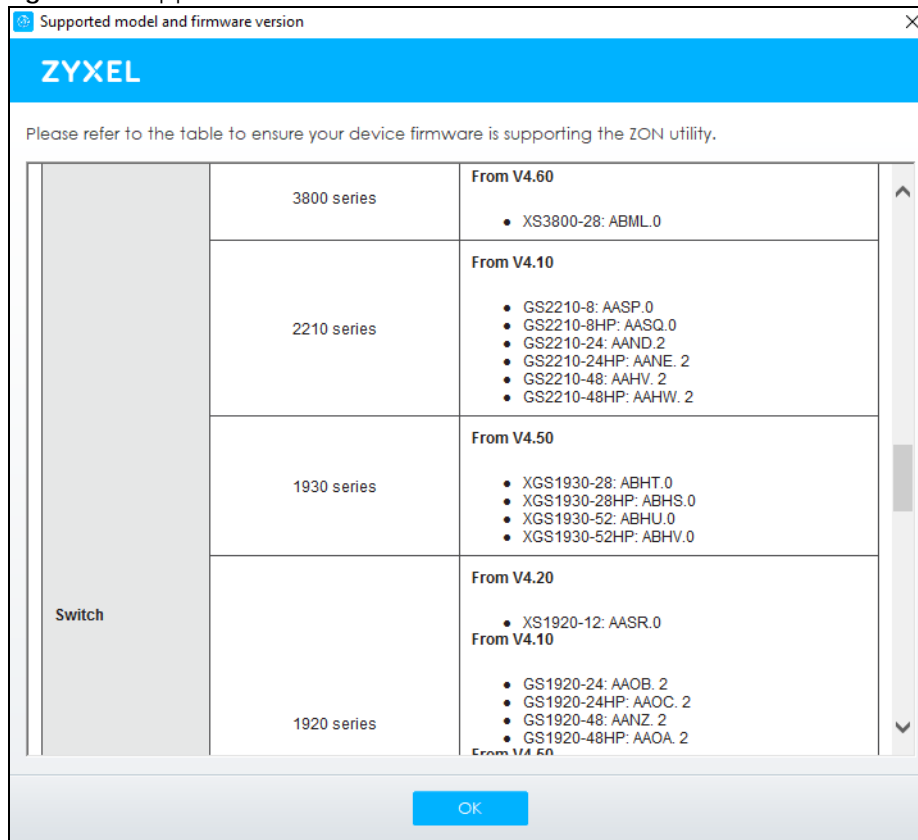

If you want to check the supported models and firmware versions later, you can click the **Show information about ZON** icon in the upper right hand corner of the screen. Then select the **Supported model and firmware version** link. If your device is not listed here, see the device release notes for ZON Utility support. The release notes are in the firmware zip file on the Zyxel web site.

Figure 19 ZON Utility Screen

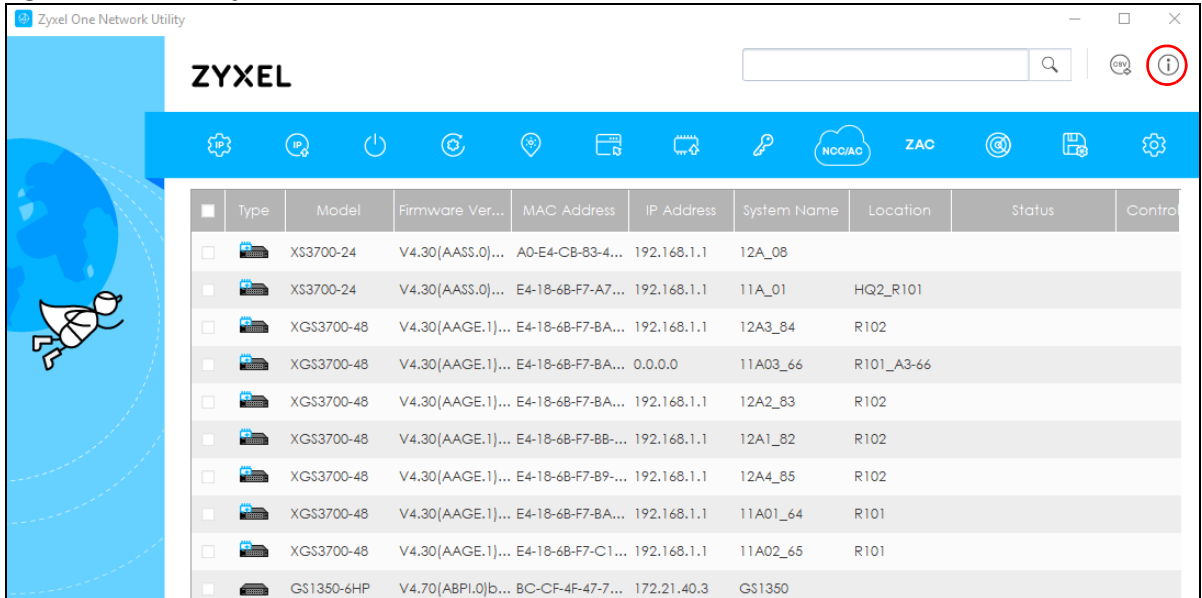

- 3 Select a network adapter to which your supported devices are connected.

Figure 20 Network Adapter

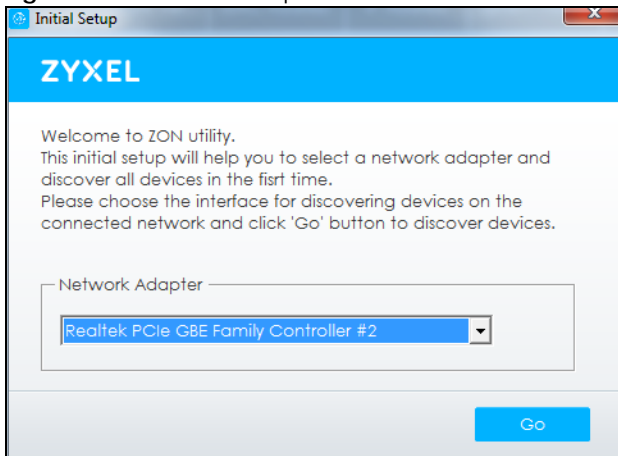

- 4 Click the **Go** button for the ZON Utility to discover all supported devices in your network.

Figure 21 Discovery

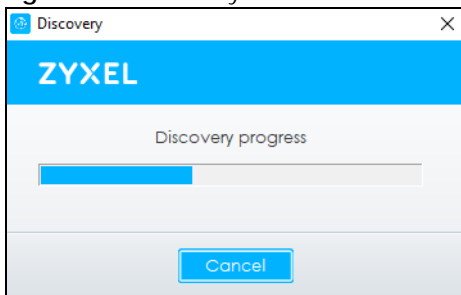

- 5 The ZON Utility screen shows the devices discovered.



Figure 22 ZON Utility Screen

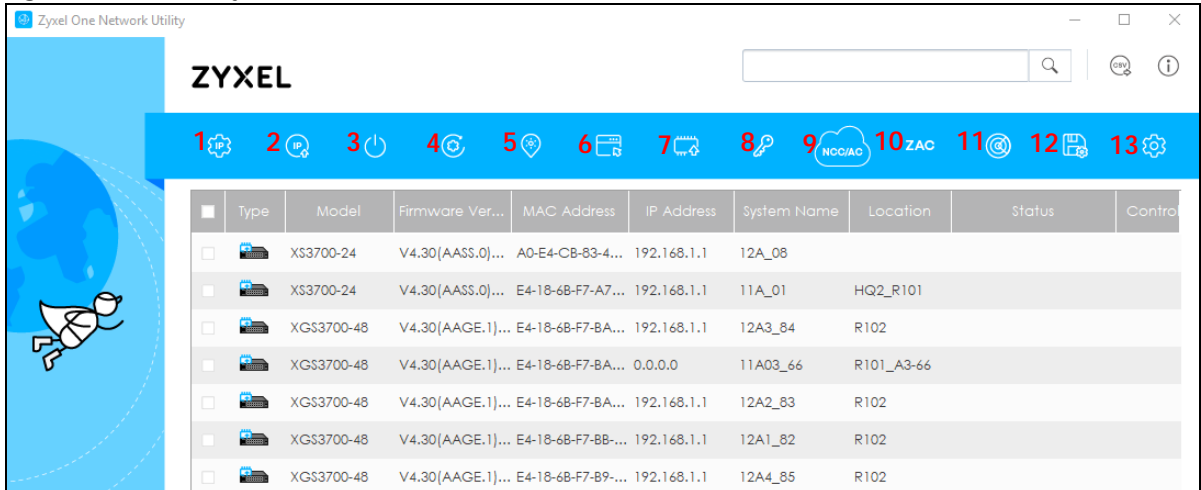

- 6 Select a device and then use the icons to perform actions. Some functions may not be available for your devices.

Note: You must know the selected device admin password before taking actions on the device using the ZON Utility icons.

Figure 23 Password Prompt

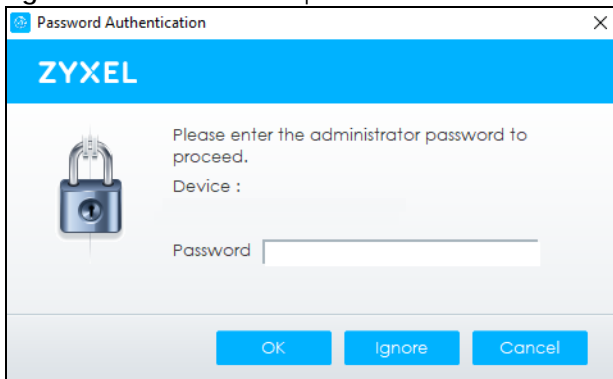

The following table describes the icons numbered from left to right in the ZON Utility screen.

Table 7 ZON Utility Icons

ICON	DESCRIPTION
1 IP Configuration	Change the selected device's IP address.
2 Renew IP Address	Update a DHCP-assigned dynamic IP address.
3 Reboot Device	Use this icon to restart the selected devices. This may be useful when troubleshooting or upgrading new firmware.
4 Reset Configuration to Default	Use this icon to reload the factory-default configuration file. This means that you will lose all previous configurations.
5 Locator LED	Use this icon to locate the selected device by causing its <b>Locator</b> LED to blink.
6 Web GUI	Use this to access the selected device Web Configurator from your browser. You will need a user name and password to log in.
7 Firmware Upgrade	Use this icon to upgrade new firmware to selected devices of the same model. Make sure you have downloaded the firmware from the Zyxel website to your computer and unzipped it in advance.

Table 7 ZON Utility Icons (continued)

ICON	DESCRIPTION
8 Change Password	Use this icon to change the admin password of the selected device. You must know the current admin password before changing to a new one.
9 Configure NCC Discovery	You must have Internet access to use this feature. Use this icon to enable or disable the Nebula Control Center (NCC) discovery feature on the selected device. If it is enabled, the selected device will try to connect to the NCC. Once the selected device is connected to and has registered in the NCC, it will go into the Nebula cloud management mode.
10 ZAC	Use this icon to run the Zyxel AP Configurator of the selected AP.
11 Clear and Rescan	Use this icon to clear the list and discover all devices on the connected network again.
12 Save Configuration	Use this icon to save configuration changes to permanent memory on a selected device.
13 Settings	Use this icon to select a network adapter for the computer on which the ZON utility is installed, and the utility language.

The following table describes the fields in the ZON Utility main screen.

Table 8 ZON Utility Fields

LABEL	DESCRIPTION
Type	This field displays an icon of the kind of device discovered.
Model	This field displays the model name of the discovered device.
Firmware Version	This field displays the firmware version of the discovered device.
MAC Address	This field displays the MAC address of the discovered device.
IP Address	This field displays the IP address of an internal interface on the discovered device that first received a ZDP discovery request from the ZON Utility.
System Name	This field displays the system name of the discovered device.
Location	This field displays where the discovered device is.
Status	This field displays whether changes to the discovered device have been done successfully. As the Switch does not support <b>IP Configuration</b> , <b>Renew IP address</b> and <b>Flash Locator LED</b> , this field displays "Update failed", "Not support Renew IP address" and "Not support Flash Locator LED" respectively.
Controller Discovery	This field displays if the discovered device supports the Nebula Control Center (NCC) discovery feature. If it is enabled, the selected device will try to connect to the NCC. Once the selected device is connected to and has registered in the NCC, it will go into the Nebula cloud management mode.
Serial Number	Enter the admin password of the discovered device to display its serial number.
Hardware Version	This field displays the hardware version of the discovered device.

## 4.4 Web Configurator Layout

The **System** screen is the first screen that displays when you access the Web Configurator.

The following figure shows the navigating components of the Web Configurator screen.

Figure 24 Web Configurator Layout

**ZYXEL XGS1210-12**

System Port VLAN Link Aggregation Mirroring QoS IGMP Snooping Management

**A**

### System Information

Model Name	Device Name	Firmware Version	Loop Status	System Up Time
XGS1210-12	XGS1210-12	V2.00(ABTY.0)B0	Normal	0 h 2 m 29 s

MAC Address	IP Address	Subnet Mask	Gateway
00:E0:4C:00:00:00	192.168.1.3	255.255.255.0	0.0.0.0

### Per Port Status

Port	Link Status	PVID	VLAN Status	TX(Pkts)	RX(Pkts)	CRC error(Pkts)	Loop Status
1	Down	1	U: 1,7 T: 7	0	0	0	Normal
2	1G-Full	1	U: 1 T: 7	128	503	0	Normal
3	Down	1	U: 1 T: 7	0	0	0	Normal
4	Down	1	U: 1,7 T: 7	0	0	0	Normal
5	Down	1	U: 1 T: 7	0	0	0	Normal
6	Down	1	U: 1,7 T: 7	0	0	0	Normal
7	Down	1	U: T:	0	0	0	Normal
8	Down	1	U: 1 T: 7	0	0	0	Normal
9	Down	1	U: 1 T: 7	0	0	0	Normal
10	Down	1	U: 1 T: 7	0	0	0	Normal
11	Down	1	U: 1 T: 7	0	0	0	Normal
12	Down	1	U: 1 T: 7	0	0	0	Normal

Refresh Clear Counters

**A** – Click the menu items to open the screen in the main window.

**B** – Click this link to log out of the Web Configurator.

The following table describes the links in the navigation panel.

Table 9 Navigation Panel Links

LINK	DESCRIPTION
System	This link takes you to a screen that displays general system information, loop status, and individual port statistics.
Port	This link takes you to a screen to enable <b>Broadcast Storm Control</b> and <b>Loop Detection/Loop Prevention</b> . You can also configure advanced settings, such as transmission speed and flow control on a port.

Table 9 Navigation Panel Links (continued)

LINK	DESCRIPTION
VLAN	This link takes you to a screen where you can set the PVID (Port VLAN ID) on a port and create/modify/delete IEEE 802.1Q VLAN for the Switch.
Link Aggregation	This link takes you to screens where you can logically aggregate physical links to form one logical and higher-bandwidth link.
Mirroring	This link takes you to a screen where you can copy traffic from one port or ports to another port so that you can examine the traffic from the first port without interference.
QoS	This link takes you to a screen where you can configure port-based or IEEE 802.1p QoS. The Switch can put packets into the queues according to the port on which the packet is received or the priority tag in the packet.
IGMP Snooping	This link takes you to a screen where you can configure IGMP snooping. You must enable IGMP snooping to use the IPTV service. It checks the IGMP packets passing through it, picks out the group registration information, and configures multicasting accordingly.
Management	This link takes you to screens where you can change the system login password, perform firmware upgrade and configuration file maintenance as well as reset/reboot the system. You can also configure the IP address and subnet mask, set management VID, and enable HTTP/HTTPS and IEEE 802.3az EEE.

### 4.4.1 Change Your Password

After you log in for the first time, you must enter a new password using the keyboard characters ("a – z", "A – Z", "0 – 9", ~!@#\$%^&\*()\_+`-={}|:;<>./\). The password must be 8 to 15 characters long. To change it, click **Management** to display the next screen to change your login password.

**Figure 25** Change Administrator Login Password

**Change Password**

Old Password

New Password

Confirm Password

Password can use:  
 "a-z", "A-Z", "0-9", ~!@#\$%^&\*()\_+`-={}|:;<>./\ Needs to be between 8 to 15 characters.

Apply

## 4.5 Switch Lockout/Resetting the Switch

You could block yourself (and all others) from managing the Switch if you remove all ports from VLAN1 and you do not configure other VLAN groups.

Note: Be careful not to lock yourself and others out of the Switch.

Make sure to log out of the Switch from a computer before logging in again on another computer.

If you forget the administrator password or cannot access the Web Configurator, you will need to use the **RESET** button at the front panel of the Switch to reset it back to the factory defaults.

This means that you will lose all configurations that you had previously and the password will be reset to "1234". IP address will also be reset to 192.168.1.3.

- 1 Make sure the **PWR/SYS** LED is on (not blinking).
- 2 To set the device back to the factory default settings, press the **RESET** button for more than 6 seconds or until the **PWR/SYS** LED begins to blink and then release it. When the **PWR/SYS** LED begins to blink, the defaults have been restored and the device restarts.

## 4.6 Logging Out of the Web Configurator

Click the logout icon  in a screen to exit the Web Configurator. You have to log in with your password again after you log out. This is recommended after you finish a management session for security reasons.

Note: By default, you are automatically logged out of the Web Configurator after 5 minutes of inactivity. You can change this setting in **Management > Timeout**.

# CHAPTER 5

## Initial Setup Example

### 5.1 Overview

This chapter shows how to set up the Switch for use.

The following lists the configuration steps for the initial setup:

- [Change the IP Address](#)
- [Change the Password](#)

#### 5.1.1 Change the IP Address

If you do not wish to set your Switch as a DHCP client (**DHCP client** field is **Disable**), assign an IP address for the Switch. The IP address makes it accessible from an outside network. It is used by the Switch to communicate with other devices in other networks.

In this example, you want to change the IP address to 192.168.1.5.

- 1 Click **Management** in the navigation panel to open the following screen.

**Figure 26** Change the IP Address

DHCP client		
Disable		
IP Address	Subnet Mask	Gateway
192.168.1.5	255.255.252.0	0.0.0.0
Apply		

- 2 Enter the new IP address **192.168.1.5** in the **IP Address** field.
- 3 Click **Apply**.
- 4 The following screen appears. Click **OK** to save the setting. Connection to the Web Configurator will be lost.

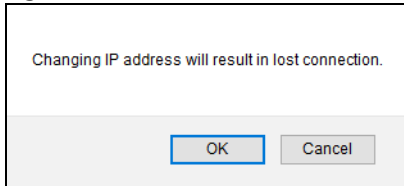
**Figure 27** Lost Connection Warning

- 5 On your web browser, go to <http://192.168.1.5>.
- 6 A **Log in** screen appears. Enter the existing password and click **SIGN IN** to log in through the new IP address.

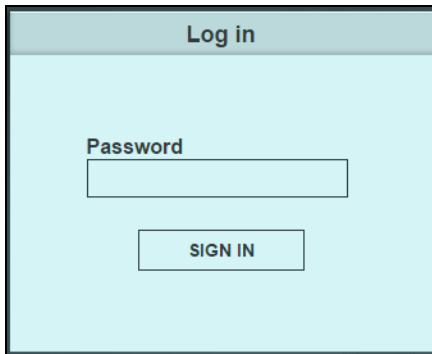

## 5.1.2 Change the Password

The first time you log in to the Web Configurator, you will be asked to change the default password 1234. If you wish to change the password again, perform the following steps:

- 1 Click **Management** in the navigation panel to open the following screen.

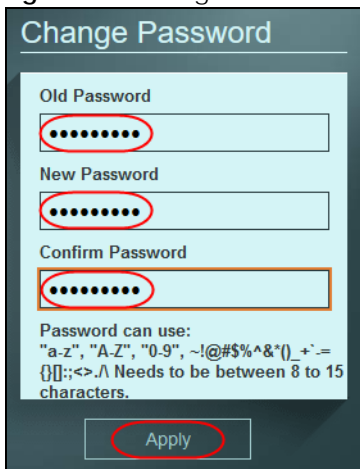
**Figure 28** Change the Password

- 2 Enter the existing password in the **Old Password** field.
- 3 Enter the new system password in the **New Password** field using the keyboard characters (a – z, A – Z, 0 – 9, and ~!@#\$\$%^&\*()\_+`-={}|:;<>./\). The password must be 8 to 15 characters long.

- 4 Enter the new password again to in the **Confirm Password** field for confirmation.
- 5 Click **Apply**. You will automatically be logged out of the Web Configurator.
- 6 A **Log in** screen appears. Enter the new password and click **SIGN IN** to log in using the new password.

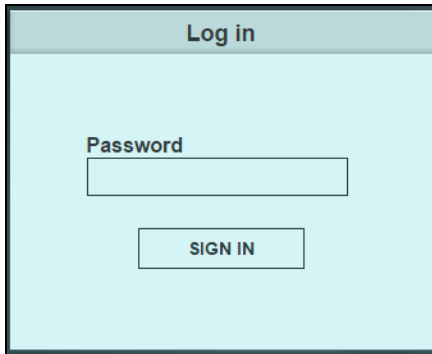

The screenshot shows a light blue rectangular window with a dark border. At the top, there is a dark grey header bar with the text "Log in" in white. Below the header, the word "Password" is displayed in a dark font. Underneath "Password" is a white rectangular input field with a thin black border. Below the input field is a white rectangular button with a thin black border and the text "SIGN IN" in dark, uppercase letters.



# CHAPTER 6

## Tutorials

### 6.1 Overview

This chapter shows you how to use the Switch's various features.

- [Creating a VLAN](#), see [page 33](#)
- [Setting Port VID](#), see [page 35](#)

### 6.2 Creating a VLAN

By default, all ports on the Switch are in VLAN 1.

VLANs confine broadcast frames to the VLAN group in which the ports belongs. You can create a VLAN group with fixed port members to do this.

If you want to have a port (for example port 1) belong to another VLAN as well, say VLAN 2, you need to create a VLAN first, and then add the port to the VLAN.

**Figure 29** Initial Setup Network Example: VLAN

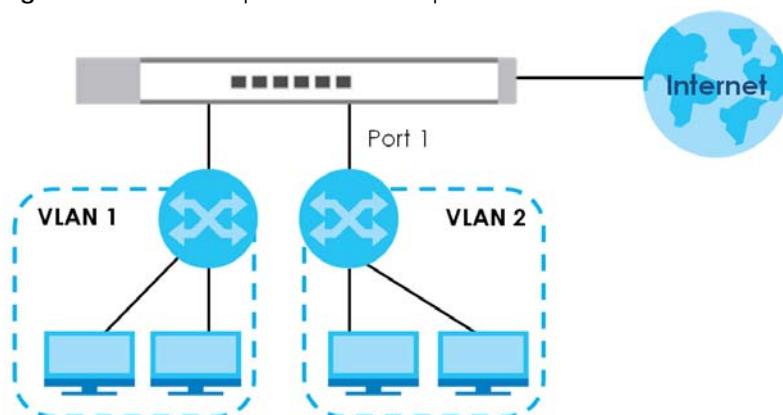

- 1 Click **VLAN** in the navigation panel and click **Create New VLAN**.

**ZYXEL**

System Port **VLAN** Link Aggregation Mirroring QoS IGMP Snooping Management

**PVID**

Port	01	02	03	04	05	06	07	08	09	10	11	12
PVID	1	1	1	1	1	1	1	1	1	1	1	1

Apply

**Maximum number of IEEE 802.1Q VLAN: 32**

VLAN ID	01	02	03	04	05	06	07	08	09	10	11	12	Modify	Delete
1	<input checked="" type="checkbox"/>	<input checked="" type="checkbox"/>	<input checked="" type="checkbox"/>	<input checked="" type="checkbox"/>	<input checked="" type="checkbox"/>	<input checked="" type="checkbox"/>	<input checked="" type="checkbox"/>	<input checked="" type="checkbox"/>	<input checked="" type="checkbox"/>	<input checked="" type="checkbox"/>	<input checked="" type="checkbox"/>	<input checked="" type="checkbox"/>	Modify	N/A

Non-Member 
  Tag Egress Member 
  Untag Egress Member

Click on button to change member state or remove VLAN.

Create New VLAN

- 2 Enter 2 in the **VLAN ID** field for the VLAN2 network.
- 3 Since the VLAN2 network is connected to port 1 on the Switch, configure port 1 to be a permanent member of the VLAN. To ensure that VLAN-unaware devices (such as computers and hubs) can receive frames properly, click the port's box color to green to set the Switch to remove VLAN tags before sending. Clicking the port's check box loops between untagging, non-member, and tagging.
- 4 Change the box color of other ports not a member of the VLAN group to gray.
- 5 Click **Apply** to save the settings.

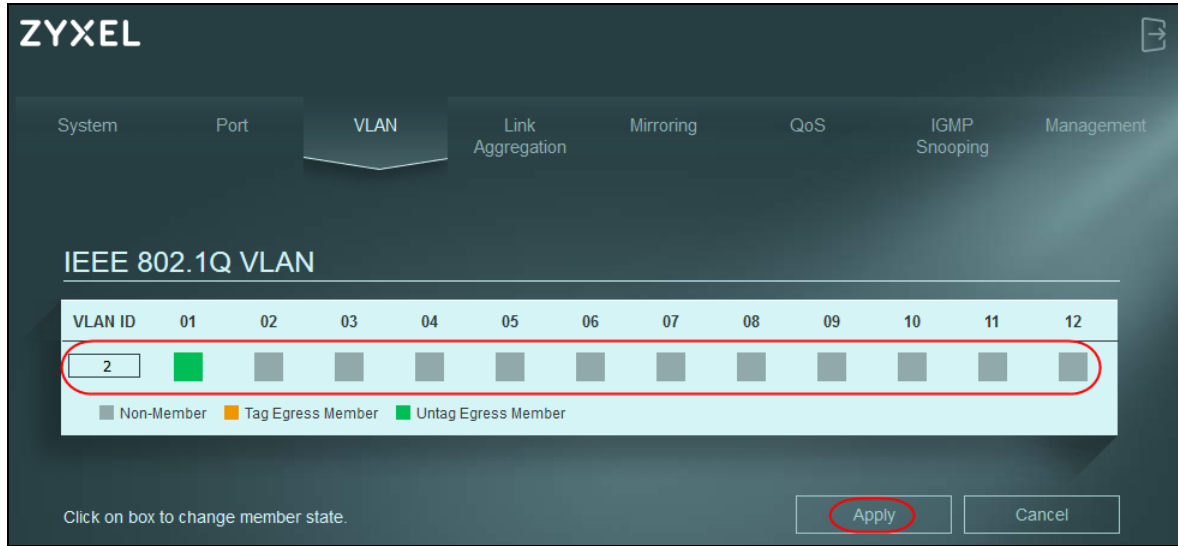

## 6.3 Setting Port VID

Use PVID to add a tag to incoming untagged frames received on that port so that the frames are forwarded to the VLAN group that the tag defines.

In the example network, configure 2 as the port VID on port 1 so that any untagged frames received on that port get sent to VLAN 2.

**Figure 30** Initial Setup Network Example: Port VID

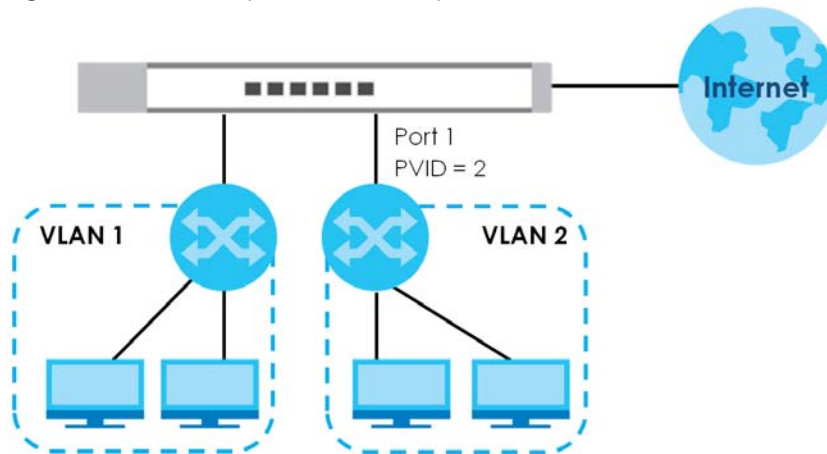

- 1 Click **VLAN** in the navigation panel.
- 2 Enter 2 in the **PVID** field for port 2 and click **Apply** to save your changes back to the Switch.

**ZYXEL**

System Port **VLAN** Link Aggregation Mirroring QoS IGMP Snooping Management

### PVID

Port	01	02	03	04	05	06	07	08	09	10	11	12
PVID	2	1	1	1	1	1	1	1	1	1	1	1

[Apply](#)

### Maximum number of IEEE 802.1Q VLAN: 32

VLAN ID	01	02	03	04	05	06	07	08	09	10	11	12	Modify	Delete
1	■	■	■	■	■	■	■	■	■	■	■	■	Modify	N/A
2	■	■	■	■	■	■	■	■	■	■	■	■	Modify	Delete

Non-Member  
  Tag Egress Member  
  Untag Egress Member

Click on button to change member state or remove VLAN. [Create New VLAN](#)

---

# PART II

## Technical Reference

---

# CHAPTER 7

# System

## 7.1 Overview

This chapter describes the screens for system status, and port details.

## 7.2 System Settings

The **System** screen displays when you log into the Switch or click **System** at the top of the Web Configurator. The **System** screen displays the Switch's general device information, and the port statistics.

Figure 31 System

The screenshot shows a network management interface with a top navigation bar containing tabs for System, Port, VLAN, Link Aggregation, Mirroring, QoS, IGMP Snooping, and Management. The 'System' tab is active.

**System Information**

Model Name	Device Name	Firmware Version	Loop Status	System Up Time
XGS1210-12	XGS1210-12	V2.00(ABTY.0)B2	Normal	0 h 0 m 43 s

MAC Address	IP Address	Subnet Mask	Gateway
00:E0:4C:00:00:00	192.168.1.3	255.255.255.0	0.0.0.0

**Per Port Status**

Port	Link Status	PVID	VLAN Status	TX(Pkts)	RX(Pkts)	CRC error(Pkts)	Loop Status
1	1G-Full	1	U: 1,7 T: 7	324	315	0	Normal
2	Down	1	U: 1 T: 7	0	0	0	Normal
3	Down	1	U: 1 T: 7	0	0	0	Normal
4	Down	1	U: 1,7 T: 7	0	0	0	Normal
5	Down	1	U: 1 T: 7	0	0	0	Normal
6	Down	1	U: 1,7 T: 7	0	0	0	Normal
7	Down	1	U: T: 7	0	0	0	Normal
8	Down	1	U: 1 T: 7	0	0	0	Normal
9	Down	1	U: 1 T: 7	0	0	0	Normal
10	Down	1	U: 1 T: 7	0	0	0	Normal
11	Down	1	U: 1 T: 7	0	0	0	Normal
12	Down	1	U: 1 T: 7	0	0	0	Normal

Buttons: Refresh, Clear Counters

The following table describes the labels in this screen.

Table 10 System

LABEL	DESCRIPTION
System Information	
Model Name	This field displays the model name of this Switch.

Table 10 System (continued)

LABEL	DESCRIPTION
Device Name	<p>This field displays the name used to identify the Switch on any network.</p> <p>The device name is a link that you can click to open a screen where you can change the name. Enter a descriptive name of up to 14 characters. Also, spaces and the following special characters listed in the brackets [ " ' &lt; &gt; ^ \$   &amp; ; \ / : * ? ' ] are not allowed.</p> <p>Note: You must enter a descriptive name to identify the Switch.</p> 
Firmware Version	This field displays the version number and date of the firmware the Switch is currently running.
Loop Status	This field displays whether the Switch is in a loop state. It displays <b>Loop</b> when the Switch detects a loop on one of the ports. Otherwise, it displays <b>Normal</b> .
System Up Time	This field displays how long the Switch has been running since it last restarted or was turned on.
MAC Address	This field displays the MAC address of the Switch.
IP Address	<p>The Switch needs an IP address for it to be managed over the network. The factory default IP address is 192.168.1.3.</p> <p>This field displays the Switch's current IPv4 address.</p>
Subnet Mask	<p>The subnet mask specifies the network number portion of an IP address. The factory default subnet mask is 255.255.255.0.</p> <p>This field displays the Switch's subnet mask.</p>
Gateway	The field displays the gateway that allows you to send or receive data traffic to or from a different network than the one the Switch is on.
Per Port Status	
Port	This identifies the Ethernet port on the Switch.
Link status	<p>This field displays the current status or speed of each port. Otherwise, it displays <b>Down</b>.</p> <p>For XGS1210-12:</p> <ul style="list-style-type: none"> <li>• either 10M, 100M, 1000M for ports 1 – 8</li> <li>• either 100M, 1000M, 2.5G for ports 9 – 10</li> <li>• either 1000M or 10G for port 11 – 12</li> </ul> <p>For XGS1250-12:</p> <ul style="list-style-type: none"> <li>• either 10M, 100M, 1000M for ports 1 – 8</li> <li>• either 100M, 1000M, 2.5G, 5G, 10G for ports 9 – 11</li> <li>• either 1000M or 10G for port 12</li> </ul>
PVID	<p>This field displays the port's PVID.</p> <p>A PVID (Port VLAN ID) is a tag that adds to incoming untagged frames received on a port so that the frames are forwarded to the VLAN group that the tag defines.</p>



Table 10 System (continued)

LABEL	DESCRIPTION
VLAN Status	This field displays: <ul style="list-style-type: none"> <li>• The corresponding VLAN identification number configured for each port.</li> <li>• Whether a port is participating in a VLAN. A port's tagged VLAN ID is displayed after <b>T</b>. A port's untagged VLAN ID is displayed after <b>U</b>. A port that does not participate in a VLAN is marked as <b>U:/T</b>.</li> </ul>
TX(Pkts)	This field shows the number of transmitted frames on this port.
RX(Pkts)	This field shows the number of received frames on this port.
CRC error (Pkts)	This field displays the number of transmitted or received error frames on this port. A CRC error is caused by damaged cables or transceivers. Check the cable connected to the port.
Loop Status	It displays <b>Loop</b> when the Switch detects a loop on the port. Otherwise, it displays <b>Normal</b> .
Refresh	Click this button to update the information in this screen.
Clear Counters	Click this button to clear the statistics in the <b>TX(Pkts)</b> and <b>RX(Pkts)</b> fields.

# CHAPTER 8

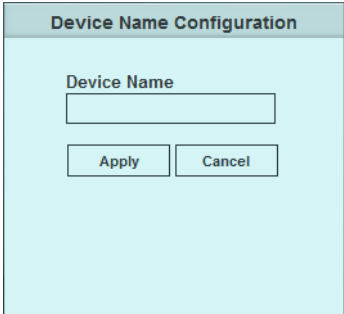
## Port

### 8.1 Overview

This chapter introduces and shows you how to configure the broadcast storm control feature and use loop prevention or loop detection to prevent loops in your network. In addition, you can configure the transmission speed and flow control on a port.

#### 8.1.1 What You Need to Know

Read this section to know more about **Loop Detection**, **Loop Prevention**, and **Broadcast Storm Control**.

##### 8.1.1.1 Loop Detection and Loop Prevention

A switch loop happens if there is more than one connection between two ports on the same switch or between two switches connected together. If this happens, broadcasts are continually rebroadcast and could flood the network. You must break the loop by stopping multiple paths between two switch ports.

**Figure 32** The Switch has Two Ports Connected with the Same Cable

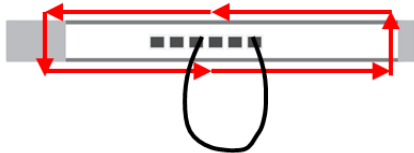

**Figure 33** The Connected Switch has Two Ports Connected with the Same Cable

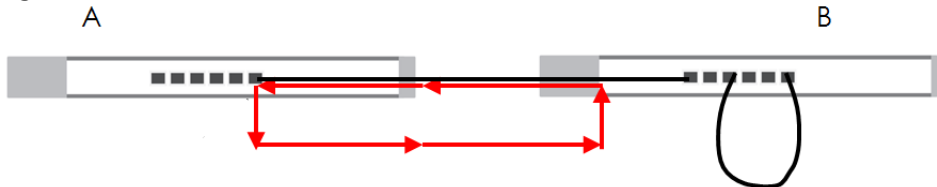

**Figure 34** Two Connections between Switches Without Using the Spanning Tree Protocol (STP)

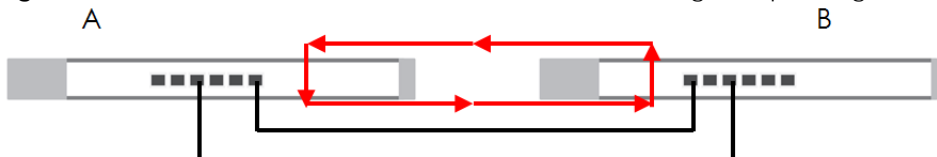

**Loop Detection** allows the Switch to discover a loop if it happens, and create a log. **Loop Prevention** allows the Switch to shut down a port automatically if it discover a loop on that port. See [Section 3.4 on page 19](#) for more information about LEDs.

### 8.1.1.2 Broadcast Storm Control

Broadcast storm control limits the number of broadcast packets the Switch receives per second on the ports. When the maximum number of allowable broadcast packets is reached per second, the subsequent packets are discarded. Enable this feature to reduce broadcast packets in your network. You can specify limits on each port.

## 8.2 Port Settings

Click **Port** in the navigation panel to open the following screen. See [Section 1.2.1 on page 10](#) for information on Multi-Gigabit.

Figure 35 Port

**ZYXEL**

System **Port** VLAN Link Aggregation Mirroring QoS IGMP Snooping Management

### Storm Control

**Broadcast Storm Control**

Enable  pps (Range 1~500,000)

**Loop Detection / Prevention**

Loop Prevention

Apply

### Port Setting

Port	State	Speed/Type	Flow Control
1	Enable	Auto	Disable
2	Enable	Auto	Disable
3	Enable	Auto	Disable
4	Enable	Auto	Disable
5	Enable	Auto	Disable
6	Enable	Auto	Disable
7	Enable	Auto	Disable
8	Enable	Auto	Disable
9	Enable	Auto	Disable
10	Enable	Auto	Disable
11	Enable	Auto	Disable
12	Enable	Auto	Disable

Apply

The following table describes the labels in this screen.

Table 11 Port

LABEL	DESCRIPTION
Storm Control	
Broadcast Storm Control	Enable traffic storm control on the Switch by specifying how many broadcast packets a port receives per second.

Table 11 Port (continued)

LABEL	DESCRIPTION
Loop Detection / Prevention	<p>Select <b>Loop Detection</b> to allow the Switch to detect a loop on the port. The port becomes active when the loop disappears.</p> <p>Select <b>Loop Prevention</b> to allow the Switch to shut down a port automatically when it detects a loop on the port. The port becomes active when the loop disappears.</p> <p>Select <b>Off</b> to disable this feature.</p>
Apply	Click this button to save your changes to the Switch.
Port Setting	
Port	This identifies the Ethernet port on the Switch.
State	Select <b>Enable</b> to enable the port or <b>Disable</b> to disable it.
Speed/Type	<p>Select the speed of the Ethernet connection on this port.</p> <p>The choices for XGS1210-12 are:</p> <ul style="list-style-type: none"> <li>• <b>Auto</b> for all ports</li> <li>• <b>10M-Full Duplex</b> for ports 1-8</li> <li>• <b>10M-AN</b> (10M/auto-negotiation) for ports 1-8</li> <li>• <b>100M-Full Duplex</b> for ports 1-8</li> <li>• <b>100M-AN</b> (100M/auto-negotiation) for ports 1-10</li> <li>• <b>1G-Full Duplex</b> (Gigabit connections only) for ports 1-10</li> <li>• <b>1G-AN</b> for ports 9-10</li> <li>• <b>2.5G-Full Duplex</b> for ports 9-10</li> <li>• <b>DAC</b> for ports 11-12, when using the DAC (Direct Attach Copper) cable</li> <li>• <b>SFP 1000M</b> for ports 11-12</li> <li>• <b>SFP+ 10G</b> for ports 11-12</li> </ul> <p>The choices for XGS1250-12 are:</p> <ul style="list-style-type: none"> <li>• <b>Auto</b> for all ports</li> <li>• <b>10M-Full Duplex</b> for ports 1-8</li> <li>• <b>10M-AN</b> (10M/auto-negotiation) for ports 1-8</li> <li>• <b>100M-Full Duplex</b> for ports 1-11</li> <li>• <b>100M-AN</b> (100M/auto-negotiation) for ports 1-11</li> <li>• <b>1G-Full Duplex</b> (Gigabit connections only) for ports 1-11</li> <li>• <b>1G-AN</b> for ports 9-11</li> <li>• <b>2.5G-Full Duplex</b> for ports 9-11</li> <li>• <b>5G-Full Duplex</b> for ports 9-11</li> <li>• <b>10G-Full Duplex</b> for ports 9-11</li> <li>• <b>DAC</b> for port 12, when using the DAC (Direct Attach Copper) cable</li> <li>• <b>SFP 1000M</b> for port 12</li> <li>• <b>SFP+ 10G</b> for port 12</li> </ul> <p>Select <b>Auto</b> (auto-negotiation) to allow one port to negotiate with a peer port automatically to obtain the connection speed that both ends support. When auto-negotiation is turned on, a port on the Switch negotiates with the peer automatically to determine the connection speed. If the peer port does not support auto-negotiation or turns off this feature, the Switch determines the connection speed by detecting the signal on the cable. When the Switch's auto-negotiation is turned off, a port uses the pre-configured speed when making a connection, therefore requiring you to make sure that the settings of the peer port are the same in order to connect.</p> <p>XGS1210-12 obtains the following speeds when you select <b>Auto</b>:</p> <ul style="list-style-type: none"> <li>• ports 1-8 connection speed of up to 1G</li> <li>• ports 9-10 connection speed of up to 2.5G, and ports 11-12 connection speed of up to 10G</li> </ul> <p>XGS1250-12 obtains the following speeds when you select <b>Auto</b>:</p> <ul style="list-style-type: none"> <li>• ports 1-8 connection speed of up to 1G</li> <li>• ports 9-12 connection speed of up to 10G</li> </ul>

Table 11 Port (continued)

LABEL	DESCRIPTION
Flow Control	<p>A concentration of traffic on a port decreases port bandwidth and overflows buffer memory causing packet discards and frame losses. <b>Flow Control</b> is used to regulate transmission of signals to match the bandwidth of the receiving port.</p> <p>The Switch uses IEEE802.3x flow control in full duplex mode and back pressure flow control in half duplex mode.</p> <p>IEEE802.3x flow control is used in full duplex mode to send a pause signal to the sending port, causing it to temporarily stop sending signals when the receiving port memory buffers fill.</p> <p>Back pressure flow control is typically used in half duplex mode to send a "collision" signal to the sending port (mimicking a state of packet collision) causing the sending port to temporarily stop sending signals and resend later. Select the check box to enable it.</p>
Apply	Click this button to save your changes to the Switch.

# CHAPTER 9

# VLAN

## 9.1 Overview

This chapter shows you how to configure VLAN settings.

### 9.1.1 What You Need to Know

Read this section to know more about VLAN and how to configure the screens.

#### 9.1.1.1 IEEE 802.1Q Tagged VLANs

A tagged VLAN uses an explicit tag (VLAN ID) in the MAC header to identify the VLAN membership of a frame across bridges – they are not confined to the switch on which they were created. The VLANs can be created statically by hand or dynamically through GVRP. The VLAN ID associates a frame with a specific VLAN and provides the information that switches need to process the frame across the network. A tagged frame is 4 bytes longer than an untagged frame and contains 2 bytes of TPID (Tag Protocol Identifier, residing within the type or length field of the Ethernet frame) and 2 bytes of TCI (Tag Control Information, starts after the source address field of the Ethernet frame).

The CFI (Canonical Format Indicator) is a single-bit flag, always set to zero for Ethernet switches. If a frame received at an Ethernet port has a CFI set to 1, then that frame should not be forwarded as it is to an untagged port. The remaining 12 bits define the VLAN ID, giving a possible maximum number of 4,096 VLANs. Note that user priority and VLAN ID are independent of each other. A frame with VID (VLAN Identifier) of null (0) is called a priority frame, meaning that only the priority level is significant and the default VID of the ingress port is given as the VID of the frame. Of the 4096 possible VIDs, a VID of 0 is used to identify priority frames and value 4095 (FFF) is reserved, so the maximum possible VLAN configurations are 4,094.

TPID	User Priority	CFI	VLAN ID
2 Bytes	3 Bits	1 Bit	12 bits

### Forwarding Tagged and Untagged Frames

Each port on the Switch is capable of passing tagged or untagged frames. To forward a frame from an 802.1Q VLAN-aware switch to an 802.1Q VLAN-unaware switch, the Switch first decides where to forward the frame and then strips off the VLAN tag. To forward a frame from an 802.1Q VLAN-unaware switch to an 802.1Q VLAN-aware switch, the Switch first decides where to forward the frame, and then inserts a VLAN tag reflecting the ingress port's default VID. The default PVID is VLAN 1 for all ports, but this can be changed.

A broadcast frame (or a multicast frame for a multicast group that is known by the system) is duplicated

only on ports that are members of the VID (except the ingress port itself), thus confining the broadcast to a specific domain.

## 9.2 VLAN Settings

Use this screen to view and configure VLAN settings for the Switch. Click **VLAN** in the navigation panel to open the following screen.

Note: You could block yourself (and all others) from managing the Switch if you remove all ports from VLAN1 and you do not configure other VLAN groups. In case this happens, reset the Switch to the default settings (see [Section 4.5 on page 28](#) for more information).

Figure 36 VLAN

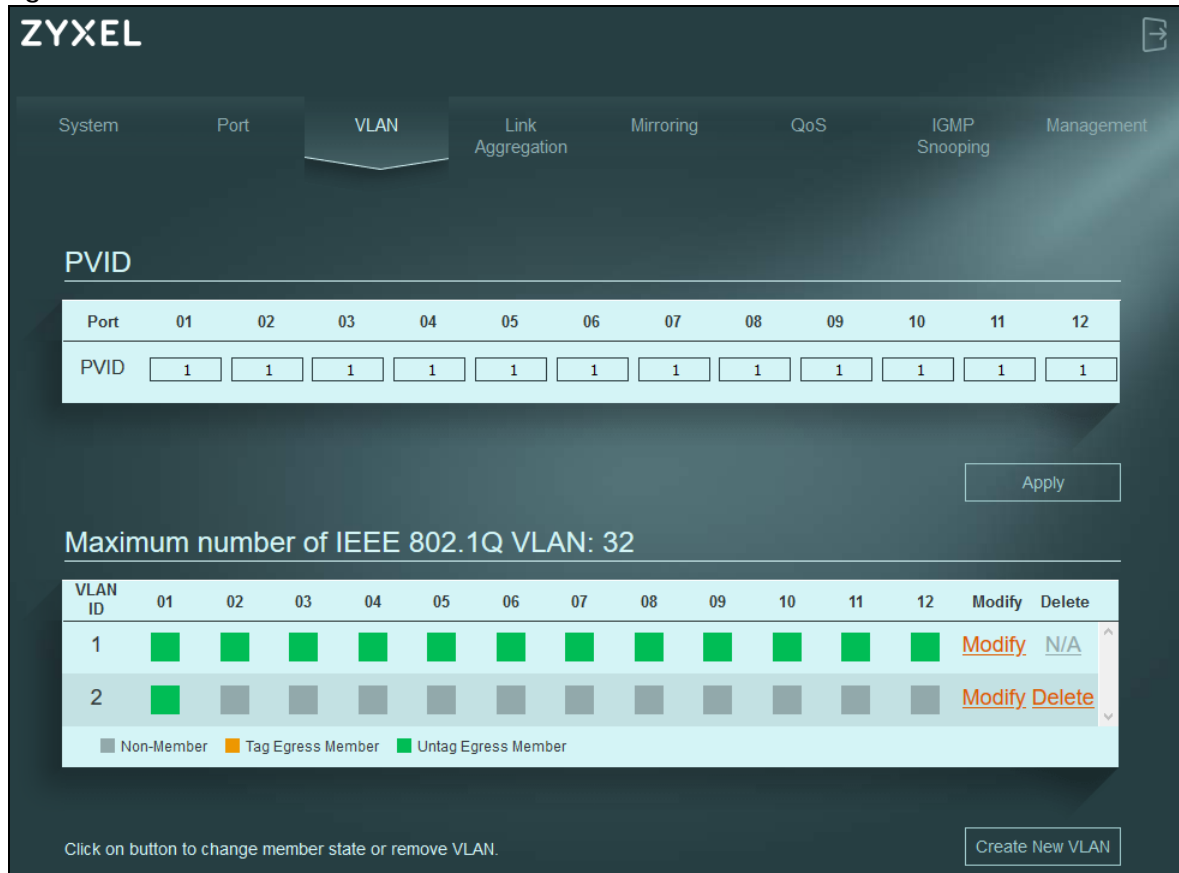

The following table describes the labels in this screen.

Table 12 VLAN

LABEL	DESCRIPTION
PVID	
Port	This field displays the port number.
PVID	A PVID (Port VLAN ID) is a tag that adds to incoming untagged frames received on a port so that the frames are forwarded to the VLAN group that the tag defines. Enter a number between 1 and 4094 as the port VLAN ID.
Apply	Click this button to save your PVID settings to the Switch.



Table 12 VLAN (continued)

LABEL	DESCRIPTION
Maximum number of IEEE 802.1Q VLAN	This shows the maximum number of IEEE 802.1Q VLANs you can have on the Switch.
VLAN ID	This is the ID number of the VLAN group. Enter a number between 1 and 4094 as the VLAN ID.
01 – 12	This displays the ports that are participating in a VLAN. A tagged port is orange, an untagged port is green and ports not participating in a VLAN are gray. Multiple ports in a VLAN can be configured as tagged or untagged or not participating.  A port is a 'tagged port' when the interface is expecting frames containing VLAN tags. An example of this is when two switches are connected, and pass tagged traffic.
Modify	Click <b>Modify</b> to edit the VLAN settings.
Delete	Click <b>Delete</b> to remove the VLAN group. You cannot delete the default VLAN.
Create New VLAN	Click this button to configure a new IEEE 802.1Q VLAN for the Switch.

# CHAPTER 10

## Link Aggregation

### 10.1 Overview

This chapter shows you how to logically aggregate physical links to form one logical and higher bandwidth link.

Link aggregation is the grouping of physical ports into one logical higher-capacity link. You may want to trunk ports if for example, it is cheaper to use multiple lower-speed links than to under-utilize a high-speed, but more costly, single-port link.

### 10.2 Link Aggregation

Use this screen to configure static link aggregation.

**Figure 37** Link Aggregation (XGS1210-12)

**Link Aggregation**

Link Aggregation Algorithm

MAC SA & DA

Link Aggregation Group

- LAG 1: Port 1 and Port 2 and Port 3 and Port 4
- LAG 2: Port 5 and Port 6
- LAG 3: Port 7 and Port 8
- LAG 4: Port 9 and Port 10
- LAG 5: Port 11 and Port 12

Apply

**Figure 38** Link Aggregation (XGS1250-12)

**Link Aggregation**

Link Aggregation Algorithm

MAC SA & DA

Link Aggregation Group

- LAG 1: Port 1 and Port 2 and Port 3 and Port 4
- LAG 2: Port 5 and Port 6
- LAG 3: Port 7 and Port 8
- LAG 4: Port 9 and Port 10 and Port 11
- LAG 5: Port 9 and Port 10

Apply

The following table describes the labels in this screen.

Table 13 Link Aggregation

LABEL	DESCRIPTION
Link Aggregation	
Link Aggregation Algorithm	<p>Select the outgoing traffic distribution type. Packets from the same source and/or to the same destination are sent over the same link within the trunk. By default, the Switch uses the <b>MAC SA &amp; DA</b> distribution type. If the Switch is behind a router, the packet's destination or source MAC address will be changed. In this case, set the Switch to distribute traffic based on its IP address to make sure port trunking can work properly.</p> <p>Select <b>MAC SA</b> to distribute traffic based on the packet's source MAC address.</p> <p>Select <b>MAC DA</b> to distribute traffic based on the packet's destination MAC address.</p> <p>Select <b>MAC SA &amp; DA</b> to distribute traffic based on a combination of the packet's source and destination MAC addresses.</p>
Link Aggregation Group	<p>The field identifies the default link aggregation groups the Switch supports. Select which link aggregation group supports your choice in the previous field <b>Link Aggregation Algorithm</b>. For example, enabling <b>LAG 1: Port 1 and Port 2 and Port 3 and Port 4</b> will allow packets from the same source and/or to the same destination to go through ports 1 – 4 for a maximum throughput of 8G. This allows for faster speed compared to passing packets through ports 1 – 4 individually (maximum 2G).</p> <p>Note: Make sure the ports in a link aggregation group have the same PVID and VLAN ID.</p>
Apply	Click this button to save your changes to the Switch.

# CHAPTER 11

## Mirroring

### 11.1 Overview

This chapter discusses the port mirroring setup screens.

Port mirroring allows you to copy a traffic flow to a monitor port (the port you copy the traffic to) to examine the traffic from the monitor port without interference.

### 11.2 Mirroring Settings

Use this screen to select a monitor port and specify the traffic flow to be copied to the monitor port.

Note: A port cannot be the monitor port and the mirrored port at the same time.

Figure 39 Mirroring

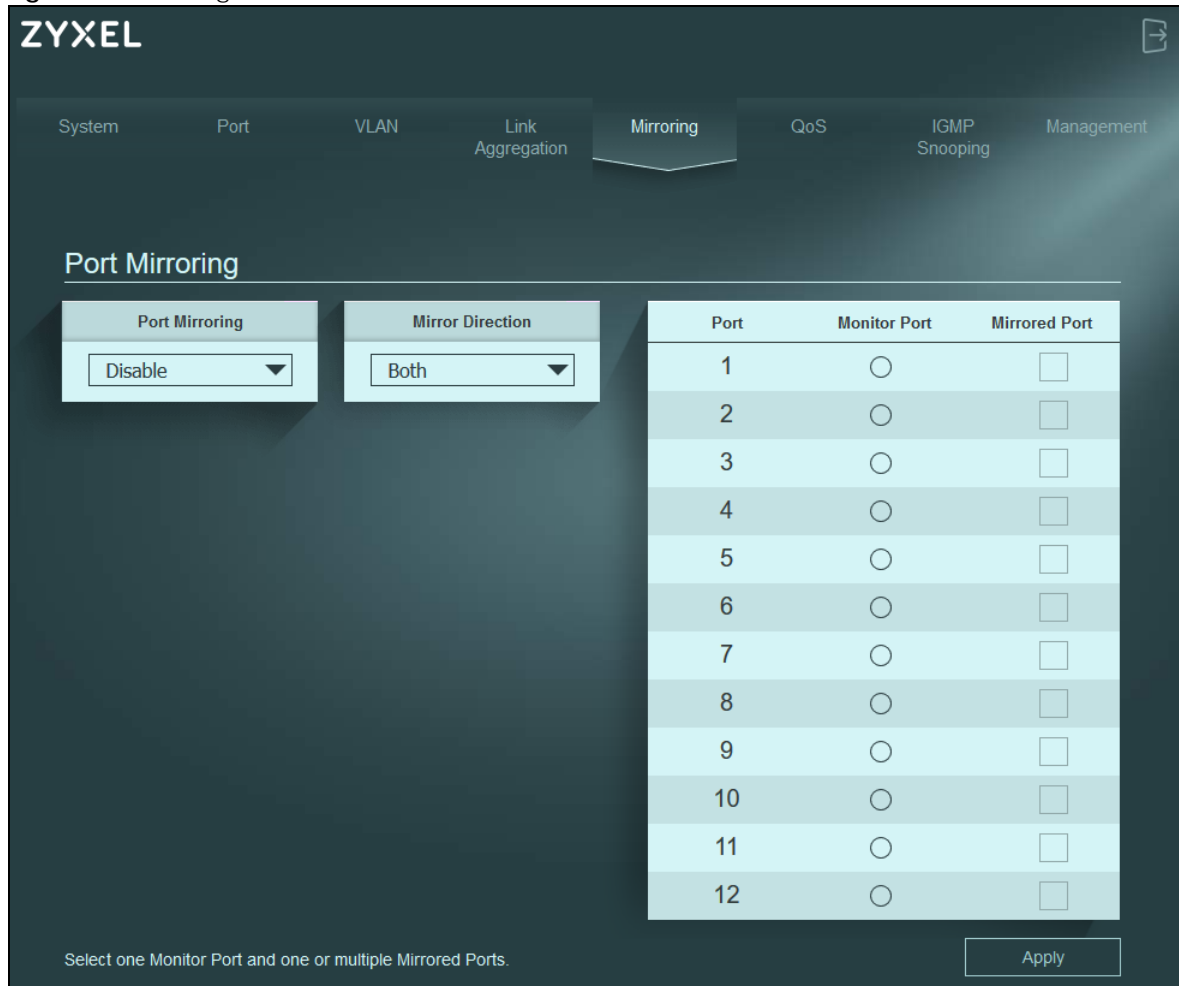

**ZYXEL**

System Port VLAN Link Aggregation **Mirroring** QoS IGMP Snooping Management

### Port Mirroring

Port Mirroring: Disable

Mirror Direction: Both

Port	Monitor Port	Mirrored Port
1	<input type="radio"/>	<input type="checkbox"/>
2	<input type="radio"/>	<input type="checkbox"/>
3	<input type="radio"/>	<input type="checkbox"/>
4	<input type="radio"/>	<input type="checkbox"/>
5	<input type="radio"/>	<input type="checkbox"/>
6	<input type="radio"/>	<input type="checkbox"/>
7	<input type="radio"/>	<input type="checkbox"/>
8	<input type="radio"/>	<input type="checkbox"/>
9	<input type="radio"/>	<input type="checkbox"/>
10	<input type="radio"/>	<input type="checkbox"/>
11	<input type="radio"/>	<input type="checkbox"/>
12	<input type="radio"/>	<input type="checkbox"/>

Select one Monitor Port and one or multiple Mirrored Ports.

Apply

The following table describes the labels in this screen.

Table 14 Mirroring

LABEL	DESCRIPTION
Port Mirroring	Select <b>Enable</b> to activate port mirroring on the Switch, or <b>Disable</b> to disable the feature.
Mirror Direction	Specify the direction of the traffic to mirror by selecting from the drop-down list box. Choices are <b>Egress</b> (outgoing), <b>Ingress</b> (incoming) and <b>Both</b> .
Port	This displays the port number.
Monitor Port	The monitor port is the port you copy the traffic to in order to examine it in more detail without interfering with the traffic flow on the original ports. Note: Select one monitor port.
Mirrored Port	Select this option to mirror the traffic on a port. Note: Select one or multiple mirrored ports.
Apply	Click this button to save your changes to the Switch.

# CHAPTER 12

## QoS

### 12.1 Overview

This chapter introduces the configuration and functions of the **QoS** (Quality of Service) screen.

The QoS (Quality of Service) feature allows you to prioritize the flow of data passing through the Switch. Occasionally, data might be delayed, depending on the volume of traffic and the capacity of the equipment. Numeric and text data are usually not affected by delays, because they are reassembled at the destination. However, when VoIP and streaming videos are reassembled, they might have some troublesome gaps. Without QoS, all traffic data is equally likely to be dropped when the network is congested. This can cause a reduction in network performance and make the network inadequate for time-critical applications such as VOD (Video on Demand).

You can enable QoS to have the Switch assign each packet a priority and then queues the packet accordingly. Packets assigned a high priority are processed more quickly than those with low priority if there is congestion, allowing time-sensitive applications to flow more smoothly. Time-sensitive applications include both those that require a low level of latency (delay) and a low level of jitter (variations in delay) such as Voice over IP (VoIP) or Internet gaming, and those for which jitter alone is a problem such as Internet radio or streaming video.

### 12.2 What You Need to Know

The Switch can put packets into the queues according to the port on which the packet is received or the priority tag in the packet.

#### 12.2.1 Port-Based QoS

The Port-Based QoS feature assigns priority to data transmitted through a particular port. When the data arrives to a port it begins a queue. Therefore, the Switch has a queue for each port. If data arrives at the same time to all ports, ports with higher priority will be first to transmit the data received. The higher the priority of the port, the less delays the data passing through will have.

#### 12.2.2 IEEE 802.1p QoS

IEEE 802.1p defines a 3-bit field called PCP (Priority Code Point) within the IEEE 802.1Q VLAN tag, which is also referred to as a CoS (Class of Service) value and indicates the frame priority level. IEEE 802.1p QoS uses the priority value (from 0 to 7) to define up to 8 traffic types. That is, each priority level defines a class of service. The table below shows the IEEE recommendations for traffic types, these may vary or be

reassigned.

Table 15 IEEE Priority to Traffic Type Mapping Recommendations

PCP	PRIORITY	ACRONYM	TRAFFIC TYPES
1	0 (lowest)	BK	Background
0	1 (default)	BE	Best Effort
2	2	EE	Excellent Effort
3	3	CA	Critical Applications
4	4	VI	Video, <100 ms latency and jitter
5	5	VO	Voice, <10 ms latency and jitter
6	6	IC	Internetwork Control
7	7 (highest)	NC	Network Control

Note: Frames without an explicit priority tag are treated as system traffic and assigned to **Queue0**.

### 12.2.3 Weighted Round Robin Scheduling (WRR)

Round Robin Scheduling services queues on a rotating basis and is activated only when a port has more traffic than it can handle. A queue is a given amount of bandwidth irrespective of the incoming traffic on that port. This queue then moves to the back of the list. The next queue is given an equal amount of bandwidth, and then moves to the end of the list; and so on, depending on the number of queues being used. This works in a looping fashion until a queue is empty.

Weighted Round Robin Scheduling (WRR) uses the same algorithm as round robin scheduling, but services queues based on their priority and queue weight (the number you select in the queue **Weight** field) rather than a fixed amount of bandwidth. WRR is activated only when a port has more traffic than it can handle. The bandwidth is divided across the different traffic queues according to their weights. Queues with larger weights get more service than queues with smaller weights. This queuing mechanism is highly efficient in that it divides any available bandwidth across the different traffic queues and returns to queues that have not yet emptied.

Figure 40 WRR Application Example

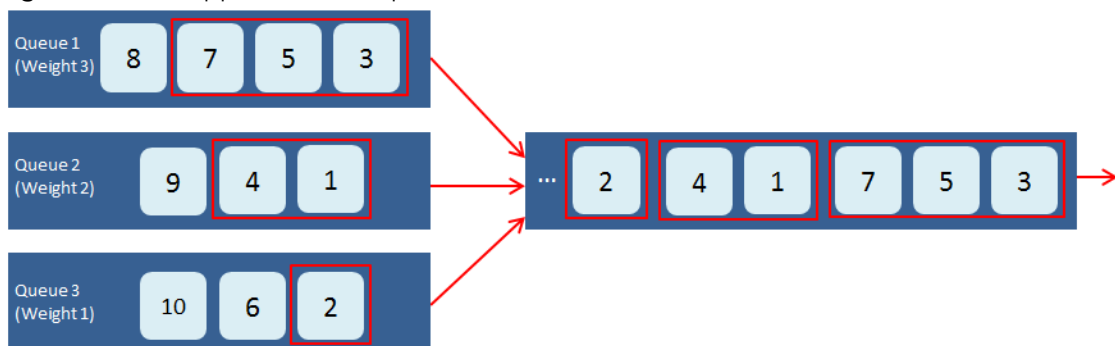

## 12.3 Port-Based QoS

The Switch's default settings for Port-Based QoS are shown in the next figure.

Figure 41 QoS > Port-Based QoS



The following table describes the labels in this screen.

Table 16 QoS > Port-Based QoS

LABEL	DESCRIPTION
Port-Based QoS	
Port 1 – 12	Select which ports will carry the sensitive data, using the priority queuing levels given. Click on each port's radio button to assign a priority queue.
Weight	Assign the weight (the number you select in the queue <b>Weight</b> field) to each priority. Remember the weight is based on WRR Scheduling, explained in <a href="#">Section 12.2.3 on page 55</a> . Bandwidth is divided across the different traffic queues according to their weights. Queues with larger weights get more service than queues with smaller weights.
Apply	Click <b>Apply</b> to save your changes to the Switch.

## 12.4 IEEE 802.1p QoS

Both Port-Based QoS and IEEE 802.1p QoS use the same priority queuing levels. Remember the difference amongst both features relies on how the priority queuing is assigned. Let us recap, Port-Based QoS assigns priority queuing by port, whereas IEEE 802.1p QoS assigns queuing by PCP priority tags.

The Switch's default settings for IEEE 802.1p QoS are shown in the next figure. The numbers from 0 to 7 refer to the priority tags for each traffic type. Refer to [Table 15 on page 55](#).



Figure 42 QoS &gt; IEEE 802.1p QoS

System Port VLAN Link Aggregation Mirroring **QoS** IGMP Snooping Management

Port-Based QoS  IEEE 802.1p QoS

### IEEE 802.1p QoS

Priority	0	1	2	3	4	5	6	7	Weight
Queue 0	<input type="radio"/>	<input checked="" type="radio"/>	<input type="radio"/>	<input type="radio"/>	<input type="radio"/>	<input type="radio"/>	<input type="radio"/>	<input type="radio"/>	1 ▼
Queue 1	<input checked="" type="radio"/>	<input type="radio"/>	<input type="radio"/>	<input type="radio"/>	<input type="radio"/>	<input type="radio"/>	<input type="radio"/>	<input type="radio"/>	2 ▼
Queue 2	<input type="radio"/>	<input type="radio"/>	<input checked="" type="radio"/>	<input type="radio"/>	<input type="radio"/>	<input type="radio"/>	<input type="radio"/>	<input type="radio"/>	3 ▼
Queue 3	<input type="radio"/>	<input type="radio"/>	<input type="radio"/>	<input checked="" type="radio"/>	<input type="radio"/>	<input type="radio"/>	<input type="radio"/>	<input type="radio"/>	4 ▼
Queue 4	<input type="radio"/>	<input type="radio"/>	<input type="radio"/>	<input type="radio"/>	<input checked="" type="radio"/>	<input type="radio"/>	<input type="radio"/>	<input type="radio"/>	5 ▼
Queue 5	<input type="radio"/>	<input type="radio"/>	<input type="radio"/>	<input type="radio"/>	<input type="radio"/>	<input checked="" type="radio"/>	<input type="radio"/>	<input type="radio"/>	9 ▼
Queue 6	<input type="radio"/>	<input type="radio"/>	<input type="radio"/>	<input type="radio"/>	<input type="radio"/>	<input type="radio"/>	<input checked="" type="radio"/>	<input type="radio"/>	13 ▼
Queue 7	<input type="radio"/>	<input type="radio"/>	<input type="radio"/>	<input type="radio"/>	<input type="radio"/>	<input type="radio"/>	<input type="radio"/>	<input checked="" type="radio"/>	15 ▼

Apply

The following table describes the labels in this screen.

Table 17 QoS &gt; IEEE 802.1p QoS

LABEL	DESCRIPTION
IEEE 802.1p QoS	
Priority 0 – 7	Select which priority tags will carry the sensitive data, using the priority queuing levels given. Click each priority tag's radio button to assign a priority queue.
Weight	Assign the weight (the number you select in the queue <b>Weight</b> field) to each priority. Remember the weight is based on WRR Scheduling, explained in <a href="#">Section 12.2.3 on page 55</a> . Bandwidth is divided across the different traffic queues according to their weights. Queues with larger weights get more service than queues with smaller weights.
Apply	Click <b>Apply</b> to save your changes to the Switch.

# CHAPTER 13

## IGMP Snooping

### 13.1 Overview

This chapter shows you how to configure the various multicast features.

Traditionally, IP packets are transmitted in one of either two ways – Unicast (one sender to one recipient) or Broadcast (one sender to everybody on the network). Multicast delivers IP packets to just a group of hosts on the network.

IGMP (Internet Group Management Protocol) is a network-layer protocol used to establish membership in a multicast group – it is not used to carry user data. Refer to RFC 1112, RFC 2236 and RFC 3376 for information on IGMP versions 1, 2, and 3 respectively.

Note: You must enable IGMP snooping to use the IPTV service.

IGMP snooping is enabled, and the **IGMP Static Router Port** is set to **Auto** by default. The port can be used as an IGMP router port.

#### IGMP Snooping

The Switch can passively snoop on IGMP packets transferred between IP multicast routers or switches and IP multicast hosts to learn the IP multicast group membership. It checks the IGMP packets passing through it, picks out the group registration information, and configures multicasting accordingly. IGMP snooping allows the Switch to learn multicast groups without you having to manually configure them.

The Switch forwards multicast traffic destined for multicast groups (that it has learned from IGMP snooping or that you have manually configured) to ports that are members of that group. IGMP snooping generates no additional network traffic, allowing you to significantly reduce multicast traffic passing through your Switch.

### 13.2 IGMP Snooping Settings

Click **IGMP Snooping** in the navigation panel to display the screen as shown next.

Figure 43 IGMP Snooping

IGMP Snooping

Enable IGMP Snooping

Unknown Multicast Drop

IGMP Static Router Port

Auto

Note : While link aggregation is enabled, the LAG ports can't be set to a static router port. (LAG 1: port 1, 2, 3 and 4; LAG 2: port 5 and 6; LAG 3: port 7 and 8; LAG 4: port 9 and 10; LAG 5: port 11 and 12)

Apply

The following table describes the labels in this screen.

Table 18 IGMP Snooping

LABEL	DESCRIPTION
IGMP Snooping	
Enable IGMP Snooping	Select this option to enable IGMP Snooping to forward group multicast traffic only to ports that are members of that group.
Unknown Multicast Drop	Select this option to discard the frame when the Switch receives an unknown multicast frame. Otherwise, the Switch sends the frame to all ports.
IGMP Static Router Port	<p>Select a port (<b>Port 1 – 12</b>) to be used as an IGMP router port.</p> <p>Select <b>Auto</b> to allow any port to be used as an IGMP router port upon receiving an IGMP query.</p> <p>The Switch treats an IGMP query port as being connected to an IGMP multicast router (or server). The Switch forwards IGMP join or leave packets to an IGMP router port.</p> <p>Note: If link aggregation is enabled, the ports in a link aggregation group will not be available in this field.</p>
Apply	Click <b>Apply</b> to save your changes to the Switch.

# CHAPTER 14

# Management

## 14.1 Overview

This chapter explains how to use the **Management** screens to configure settings on the Switch, such as login password change, firmware upgrade, system reset or reboot, IP address change, and so on.

### 14.1.1 What You Need to Know

Read this section to know more about IEEE 802.3az Energy Efficient Ethernet (EEE) and HTTPS (HyperText Transfer Protocol over Secure Socket Layer, or HTTP over SSL).

#### 14.1.1.1 IEEE 802.3az Energy Efficient Ethernet (EEE)

If EEE is enabled, both sides of a link support EEE and there is no traffic, the port enters Low Power Idle (LPI) mode. LPI mode turns off some functions of the physical layer (becomes quiet) to save power. Periodically the port transmits a REFRESH signal to allow the link partner to keep the link alive. When there is traffic to be sent, a WAKE signal is sent to the link partner to return the link to active mode.

#### 14.1.1.2 Introduction to HTTPS

HTTPS (HyperText Transfer Protocol over Secure Socket Layer, or HTTP over SSL) is a web protocol that encrypts and decrypts web pages. Secure Socket Layer (SSL) is an application-level protocol that enables secure transactions of data by ensuring confidentiality (an unauthorized party cannot read the transferred data), authentication (one party can identify the other party) and data integrity (you know if data has been changed).

It relies upon certificates, public keys, and private keys.

HTTPS on the Switch is used so that you may securely access the Switch using the Web Configurator. The SSL protocol specifies that the SSL server (the Switch) must always authenticate itself to the SSL client (the computer which requests the HTTPS connection with the Switch), whereas the SSL client only should authenticate itself when the SSL server requires it to do so. Authenticating client certificates is optional and if selected means the SSL-client must send the Switch a certificate. You must apply for a certificate for the browser from a Certificate Authority (CA) that is a trusted CA on the Switch.

Please refer to the following figure.

- 1 HTTPS connection requests from an SSL-aware web browser go to port 443 (by default) on the Switch's WS (web server).
- 2 HTTP connection requests from a web browser go to port 80 (by default) on the Switch's WS (web server).

**Figure 44** HTTPS Implementation

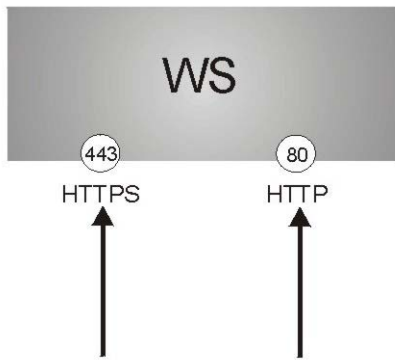

Note: If you disable HTTP in the **Management** screen, then the Switch blocks all HTTP connection attempts.

## 14.2 Management Settings

An administrator is someone who can both view and configure Switch changes. The default administrator password is **1234**.

Note: It is highly recommended that you change the default administrator password (**1234**).

Click **Management** in the navigation panel to open the following screen.

Figure 45 Switch Management

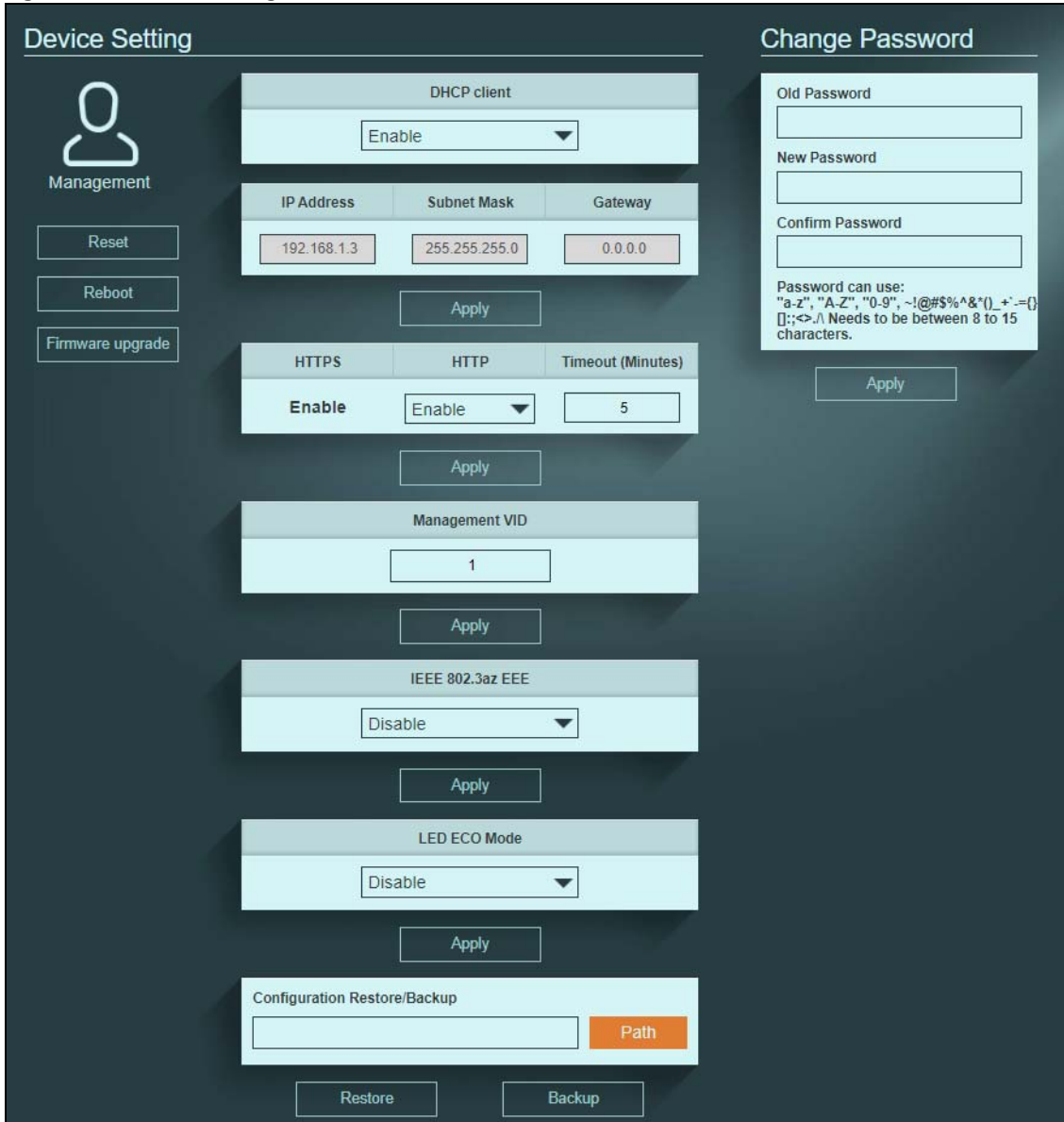

The following table describes the labels in this screen.

Table 19 Switch Management

LABEL	DESCRIPTION
Device Setting	
Reset	Click this button to clear all Switch configuration information you configured and return to the factory defaults.  If you want to access the Switch Web Configurator again, you may need to change the IP address of your computer to be in the same subnet as that of the default Switch IP address (192.168.1.3).
Reboot	Click this button to restart the Switch without physically turning the power off.
Firmware upgrade	Click this button to upgrade the Switch to the latest firmware.

Table 19 Switch Management (continued)

LABEL	DESCRIPTION
DHCP Client	Select <b>Enable</b> if you have a DHCP server that can assign the Switch an IP address, subnet mask, a default gateway IP address and a domain name server IP address automatically. Otherwise, select <b>Disable</b> .
IP Address	Enter the IP address of your Switch in dotted decimal notation, for example, 192.168.1.3. This is the IP address of the Switch in an IP routing domain.
Subnet Mask	Enter the IP subnet mask of an IP routing domain in dotted decimal notation, for example, 255.255.255.0.
Gateway	Enter the IP address of the default outgoing gateway in dotted decimal notation, for example, 192.168.1.254.
Apply	Click this button to save your changes to the Switch.
HTTPS / HTTP	Select <b>Enable</b> to allow for HTTP or HTTPS services that may be used for managing the Switch from the specified trusted computers.  Select <b>Disable</b> to allow for HTTPS service only. This ensures that connection request to the Web Configurator is from an SSL-aware web browser only.
Timeout	Enter how many minutes (from 1 to 30) a session can be left idle before the session times out. After it times out, you have to log in with your password again. A very long timeout setting may have security risks.
Management VID	This is the ID number of the management VLAN. Enter a number between 1 and 4094 as the management VLAN ID.  Any ports assigned to this VLAN are considered management ports and should be secured to control which devices can connect to these ports. See <a href="#">Section 9.2 on page 48</a> for details on creating VLANs.  Note: Changing the <b>Management VID</b> may cause the Switch to lose its network connection.
IEEE 802.3az EEE	Select <b>Enable</b> to activate Energy Efficient Ethernet globally. Otherwise, select <b>Disable</b> .
LED ECO Mode	Select <b>Enable</b> to turn off all the Switch LINK/ACT port LEDs.  Select <b>Disable</b> to turn on all the Switch LINK/ACT port LEDs.
Apply	Click this button to save your changes to the Switch.
Configuration Restore/Backup	Type the path and file name of the configuration file you wish to restore in the text box or click <b>path</b> to locate it.
Restore	Click <b>Restore</b> to restore a previously saved configuration from your computer to the Switch.  Note: "config" is the name of the configuration file on the Switch, so your backup configuration file is automatically renamed when you restore using this screen.
Backup	Click <b>Backup</b> to save and store your current device settings.
Change Password	
Old Password	Type the existing system password.
New Password	Enter your new system password using the keyboard characters (a - z, A - Z, 0 - 9, and ~!@#\$%^&*()_+`-={}[]:;<>./\). The password must be 8 to 15 characters long.
Confirm Password	Retype your new system password for confirmation.
Apply	Click this button to save your changes to the Switch.

## 14.2.1 Firmware Upgrade

Firmware upgrades contain bug fixes and fixes for security vulnerabilities. It is recommended to keep the Switch's firmware up to date.

Make sure you have downloaded (and unzipped) the correct model firmware and version to your computer before uploading to the Switch.

**Be sure to upload the correct model firmware as uploading the wrong model firmware may damage your device.**

**Do NOT disconnect power to the Switch while firmware upload is in progress!**

The following screen will appear after you click the **Firmware Upgrade** button. You will not be able to configure other settings during the firmware upgrade process to avoid system crashes on the Switch.

**Figure 46** Firmware Upgrade Path

The screenshot shows a dialog box titled "Firmware Upgrade". It features a text input field with a "Path" button to its right. Below the input field are two buttons: "Upgrade" and "Cancel". At the bottom of the dialog, there is a message: "Please wait 120 seconds. Please do not power off, or unplug Ethernet cable during the upgrade..."

Type the path and file name of the firmware file you wish to upload to the Switch in the text box or click **Path** to locate it. After you select the firmware file, click the **Upgrade** button to load the new firmware.

**Figure 47** Firmware Upgrade Confirmation

The screenshot shows a confirmation dialog box. The text inside reads: "172.21.40.19 says" followed by "It must reboot your device for the upgrade to take effect, continue?". At the bottom right, there are two buttons: "OK" and "Cancel".

**Figure 48** Firmware Uploading

The screenshot shows a dialog box titled "Firmware Upgrade". The text input field now contains the path "C:\fakepath\XGS12\_0\_V1.00(A)" and the "Path" button is highlighted. Below the input field are two buttons: "Upgrade" and "Cancel". At the bottom of the dialog, there is a message: "Please wait 89 seconds. The system is rebooting now ...."

After a successful upload, the system will reboot, and you will need to log into the Switch again.

Note: XGS1210-12/XGS1250-12 rev.B1 only support firmware version V2.00 or later. See [Section 1.1.2 on page 9](#) for more information on hardware version.



# CHAPTER 15

## Troubleshooting

This chapter offers some suggestions to solve problems you might encounter. The potential problems are divided into the following categories.

- [Power, Hardware Connections, and LEDs](#)
- [Switch Access and Login](#)
- [Switch Configuration](#)

### 15.1 Power, Hardware Connections, and LEDs

---

[The Switch does not turn on. None of the LEDs turn on.](#)

---

- 1 Make sure you are using the power adapter or cord included with the Switch.
- 2 Make sure the power adapter or cord is connected to the Switch and plugged in to an appropriate power source. Make sure the power source is turned on.
- 3 Disconnect and re-connect the power adapter or cord to the Switch.
- 4 If the problem continues, contact the vendor.

[One of the LEDs does not behave as expected.](#)

---

- 1 Make sure you understand the normal behavior of the LED. See [Section 3.4 on page 19](#).
- 2 Check the hardware connections. See [Section 1.2.1 on page 10](#) on using the correct cable type.
- 3 Inspect your cables for damage. Contact the vendor to replace any damaged cables.
- 4 Disconnect and re-connect the power adapter or cord to the Switch.
- 5 If the problem continues, contact the vendor.

[A loop is detected.](#)

---

- 1 To restore a port in a loop state, disconnect it, check the network connections, and reconnect it.
- 2 You can log into the Web Configurator. Go to **System** in the Web Configurator to check your port status. Note that you can do this when you enable **Loop Prevention** (default) in the **Port** screen. If **Loop Detection** is enabled, you cannot log into the Switch.

## 15.2 Switch Access and Login

---

### I forgot the IP address for the Switch.

---

- 1 The default IP address is **192.168.1.3**.
  - 2 If this does not work, you have to reset the device to its factory defaults. See [Section 4.5 on page 28](#).
- 

### I forgot the password.

---

- 1 The default password is **1234**.
  - 2 If this does not work, you have to reset the device to its factory defaults. See [Section 4.5 on page 28](#).
- 

### I cannot see or access the **Login** screen in the Web Configurator.

---

- 1 Make sure you are using the correct IP address.
    - The default IP address is [192.168.1.3](#).
    - If you changed the IP address, use the new IP address.
    - If you changed the IP address and have forgotten it, see the troubleshooting suggestions for [I forgot the IP address for the Switch](#).
  - 2 Check the hardware connections, and make sure the LEDs are behaving as expected. See [Section 3.4 on page 19](#).
  - 3 Make sure your Internet browser does not block pop-up windows and has JavaScripts and Java enabled.
  - 4 Make sure your computer is in the same subnet as the Switch. (If you know that there are routers between your computer and the Switch, skip this step.)
  - 5 Reset the device to its factory defaults, and try to access the Switch with the default IP address. See [Section 4.5 on page 28](#).
  - 6 If the problem continues, contact the vendor.
-

---

I can see the [Login](#) screen, but I cannot log in to the Switch.

---

- 1 Make sure you have entered the password correctly. The default password is **1234**.
- 2 Disconnect and re-connect the cord to the Switch.
- 3 If this does not work, you have to reset the device to its factory defaults. See [Section 4.5 on page 28](#).

---

[Pop-up Windows, JavaScripts and Java Permissions](#)

---

In order to use the Web Configurator you need to allow the following:

- Web browser pop-up windows from your device.
- JavaScripts (enabled by default).
- Java permissions (enabled by default).

## 15.3 Switch Configuration

---

[After upgrading the firmware on the Switch, the login screen does not display.](#)

---

When any of the following should happen during the firmware upgrade process, a failure may occur.

During the firmware upgrade process:

- The Switch loses power.
- The computer from where you upload the firmware file to the Switch is turned off.
- The Ethernet cable connecting the Switch and the computer comes loose. This is the computer from where you uploaded the firmware file to the Switch.

When any of the above occurs, and you are directed to the **Firmware Upgrade** screen, follow the steps below:

- 1 Make sure the power supply is sufficient in your environment.
- 2 Make sure your computer's Ethernet cable is securely connected to the Switch.
- 3 Select the firmware file that you tried to upload to the Switch before and try upgrading the firmware again in the **Firmware Upgrade** screen.
- 4 Wait for the firmware upgrade process to complete. After a successful upload, the system will reboot, and you will need to log into the Switch again.

# APPENDIX A

## Customer Support

In the event of problems that cannot be solved by using this manual, you should contact your vendor. If you cannot contact your vendor, then contact a Zyxel office for the region in which you bought the device.

For Zyxel Communication offices, see <https://service-provider.zyxel.com/global/en/contact-us> for the latest information.

For Zyxel Network offices, see <https://www.zyxel.com/index.shtml> for the latest information.

Please have the following information ready when you contact an office.

### Required Information

- Product model and serial number.
- Warranty Information.
- Date that you received your device.
- Brief description of the problem and the steps you took to solve it.

### Corporate Headquarters (Worldwide)

#### Taiwan

- Zyxel Communications (Taiwan) Co., Ltd.
- <https://www.zyxel.com>

### Asia

#### China

- Zyxel Communications Corporation–China Office
- <https://www.zyxel.com/cn/sc>

#### India

- Zyxel Communications Corporation–India Office
- <https://www.zyxel.com/in/en-in>

#### Kazakhstan

- Zyxel Kazakhstan
- <https://www.zyxel.com/ru/ru>

## **Korea**

- Zyxel Korea Co., Ltd.
- <http://www.zyxel.kr/>

## **Malaysia**

- Zyxel Communications Corp.
- <https://www.zyxel.com/global/en>

## **Philippines**

- Zyxel Communications Corp.
- <https://www.zyxel.com/global/en>

## **Singapore**

- Zyxel Communications Corp.
- <https://www.zyxel.com/global/en>

## **Taiwan**

- Zyxel Communications (Taiwan) Co., Ltd.
- <https://www.zyxel.com/tw/zh>

## **Thailand**

- Zyxel Thailand Co., Ltd.
- <https://www.zyxel.com/th/th>

## **Vietnam**

- Zyxel Communications Corporation–Vietnam Office
- <https://www.zyxel.com/vn/vi>

## **Europe**

### **Belarus**

- Zyxel Communications Corp.
- <https://www.zyxel.com/ru/ru>

### **Belgium (Netherlands)**

- Zyxel Benelux
- <https://www.zyxel.com/nl/nl>
- <https://www.zyxel.com/fr/fr>

### **Bulgaria**

- Zyxel Bulgaria

- <https://www.zyxel.com/bg/bg>

## **Czech Republic**

- Zyxel Communications Czech s.r.o.
- <https://www.zyxel.com/cz/cs>

## **Denmark**

- Zyxel Communications A/S
- <https://www.zyxel.com/dk/da>

## **Finland**

- Zyxel Communications
- <https://www.zyxel.com/fi/fi>

## **France**

- Zyxel France
- <https://www.zyxel.com/fr/fr>

## **Germany**

- Zyxel Deutschland GmbH.
- <https://www.zyxel.com/de/de>

## **Hungary**

- Zyxel Hungary & SEE
- <https://www.zyxel.com/hu/hu>

## **Italy**

- Zyxel Communications Italy S.r.l.
- <https://www.zyxel.com/it/it>

## **Norway**

- Zyxel Communications A/S
- <https://www.zyxel.com/no/no>

## **Poland**

- Zyxel Communications Poland
- <https://www.zyxel.com/pl/pl>

## **Romania**

- Zyxel Romania
- <https://www.zyxel.com/ro/ro>

## Russian Federation

- Zyxel Communications Corp.
- <https://www.zyxel.com/ru/ru>

## Slovakia

- Zyxel Slovakia
- <https://www.zyxel.com/sk/sk>

## Spain

- Zyxel Iberia
- <https://www.zyxel.com/es/es>

## Sweden

- Zyxel Communications A/S
- <https://www.zyxel.com/se/sv>

## Switzerland

- Studerus AG
- <https://www.zyxel.com/ch/de-ch>
- <https://www.zyxel.com/fr/fr>

## Turkey

- Zyxel Turkey A.S.
- <https://www.zyxel.com/tr/tr>

## UK

- Zyxel Communications UK Ltd.
- <https://www.zyxel.com/uk/en-gb>

## Ukraine

- Zyxel Ukraine
- <https://www.zyxel.com/ua/uk-ua>

## South America

### Argentina

- Zyxel Communications Corp.
- <https://www.zyxel.com/co/es-co>

### Brazil

- Zyxel Communications Brasil Ltda.

- <https://www.zyxel.com/br/pt>

## **Colombia**

- Zyxel Communications Corp.
- <https://www.zyxel.com/co/es-co>

## **Ecuador**

- Zyxel Communications Corp.
- <https://www.zyxel.com/co/es-co>

## **South America**

- Zyxel Communications Corp.
- <https://www.zyxel.com/co/es-co>

## **Middle East**

### **Israel**

- Zyxel Communications Corp.
- <https://il.zyxel.com>

## **North America**

### **USA**

- Zyxel Communications, Inc. – North America Headquarters
- <https://www.zyxel.com/us/en-us>



# APPENDIX B

## Legal Information

### Copyright

Copyright © 2023 by Zyxel and/or its affiliates.

The contents of this publication may not be reproduced in any part or as a whole, transcribed, stored in a retrieval system, translated into any language, or transmitted in any form or by any means, electronic, mechanical, magnetic, optical, chemical, photocopying, manual, or otherwise, without the prior written permission of Zyxel and/or its affiliates.

Published by Zyxel and/or its affiliates. All rights reserved.

### Disclaimer

Zyxel does not assume any liability arising out of the application or use of any products, or software described herein. Neither does it convey any license under its patent rights nor the patent rights of others. Zyxel further reserves the right to make changes in any products described herein without notice. This publication is subject to change without notice.

### Regulatory Notice and Statement

#### UNITED STATES of AMERICA



The following information applies if you use the product within USA area.

#### FCC Statement

- The device complies with Part 15 of the FCC Rules. Operation is subject to the following two conditions:
  - (1) This device may not cause harmful interference, and
  - (2) This device must accept any interference received, including interference that may cause undesired operation.
- Changes or modifications not expressly approved by the party responsible for compliance could void the user's authority to operate the device.
- This equipment has been tested and found to comply with the limits for a Class B digital device, pursuant to Part 15 of the FCC Rules. These limits are designed to provide reasonable protection against harmful interference in a residential installation.
- This equipment generates, uses, and can radiate radio frequency energy and, if not installed and used in accordance with the instructions, may cause harmful interference to radio communications. However, there is no guarantee that interference will not occur in a particular installation.
- If this equipment does cause harmful interference to radio or television reception, which can be determined by turning the equipment off and on, the user is encouraged to try to correct the interference by one or more of the following measures:
  - Reorient or relocate the receiving antenna
  - Increase the separation between the equipment and receiver
  - Connect the equipment into an outlet on a circuit different from that to which the receiver is connected
  - Consult the dealer or an experienced radio/TV technician for assistance

#### EUROPEAN UNION and UNITED KINGDOM



The following information applies if you use the product within the European Union or United Kingdom.

List of national codes

COUNTRY	ISO 3166 2 LETTER CODE	COUNTRY	ISO 3166 2 LETTER CODE
Austria	AT	Liechtenstein	LI
Belgium	BE	Lithuania	LT
Bulgaria	BG	Luxembourg	LU
Croatia	HR	Malta	MT
Cyprus	CY	Netherlands	NL
Czech Republic	CZ	Norway	NO
Denmark	DK	Poland	PL
Estonia	EE	Portugal	PT
Finland	FI	Romania	RO
France	FR	Serbia	RS
Germany	DE	Slovakia	SK
Greece	GR	Slovenia	SI
Hungary	HU	Spain	ES
Iceland	IS	Switzerland	CH
Ireland	IE	Sweden	SE
Italy	IT	Turkey	TR
Latvia	LV	United Kingdom	GB

Safety Warnings

- Do not put the device in a place that is humid, dusty, has extreme temperatures, or that blocks the device ventilation slots. These conditions may harm your device.
- Please refer to the device back label, datasheet, box specifications or catalog information for power rating of the device and operating temperature.
- There is a remote risk of electric shock from lightning: (1) Do not use the device outside, and make sure all the connections are indoors. (2) Do not install or service this device during a thunderstorm.
- Do not expose your device to dampness, dust or corrosive liquids.
- Do not store things on the device.
- Do not obstruct the device ventilation slots as insufficient airflow may harm your device. For example, do not place the device in an enclosed space such as a box or on a very soft surface such as a bed or sofa.
- Do not install or service this device during a thunderstorm. There is a remote risk of electric shock from lightning.
- Connect ONLY suitable accessories to the device.
- Do not open the device. Opening or removing the device covers can expose you to dangerous high voltage points or other risks.
- Only qualified service personnel should service or disassemble this device. Please contact your vendor for further information.
- Make sure to connect the cables to the correct ports.
- Place connected cables carefully so that no one will step on them or stumble over them.
- Disconnect all cables from this device before servicing or disassembling.
- Do not remove the plug and connect it to a power outlet by itself; always attach the plug to the power adaptor first before connecting it to a power outlet.
- Do not allow anything to rest on the power adaptor or cord and do NOT place the product where anyone can walk on the power adaptor or cord.
- Please use the provided or designated connection cables/power cables/ adaptors. Connect the power adaptor or cord to the right supply voltage (for example, 120V AC in North America or 230V AC in Europe). If the power adaptor or cord is damaged, it might cause electrocution. Remove the damaged power adaptor or cord from the device and the power source. Do not try to repair the power adaptor or cord by yourself. Contact your local vendor to order a new one.
- CAUTION: There is a risk of explosion if you replace the device battery with an incorrect one. Dispose of used batteries according to the instructions. Dispose them at the applicable collection point for the recycling of electrical and electronic devices. For detailed information about recycling of this device, please contact your local city office, your household waste disposal service or the store where you purchased the device.
- Do not leave a battery in an extremely high temperature environment or surroundings since it can result in an explosion or the leakage of flammable liquid or gas.
- Do not subject a battery to extremely low air pressure since it may result in an explosion or the leakage of flammable liquid or gas.
- The following warning statements apply, where the disconnect device is not incorporated in the device or where the plug on the power supply cord is intended to serve as the disconnect device.
  - For a permanently connected device, a readily accessible method to disconnect the device shall be incorporated externally to the device;
  - For a pluggable device, the socket-outlet shall be installed near the device and shall be easily accessible.
- Complies with 21 CFR 1040.10 and 1040.11 except for conformance with IEC 60825-1 Ed. 3., as described in Laser Notice No. 56, dated May 8, 2019.
- Conforme à 21 CFR 1040.10 et 1040.11 sauf pour la conformité à la norme CEI 60825-1 Ed. 3., comme décrit dans la notice laser Numéro 56 du 8 mai 2019.
- Ce produit laser est un produit laser de classe 1 conforme à la norme CEI 60825-1: 2014
- CLASS 1 LASER PRODUCT & "IEC 60825-1:2014"
- CLASS 1 CONSUMER LASER PRODUCT & "EN 50689:2021"

## Environment Statement

### ErP (Energy-related Products) (for XGS1210-12)

European Parliament and the Council published Directive 2009/125/EC and UK regulation establishing a framework for the setting of ecodesign requirements for energy-related products (recast), the so called "ErP Directive (Energy-related Products directive), as well as ecodesign requirements laid down in applicable implementation measures. Power consumption has satisfied the regulation requirements which are:

- Network standby power consumption < 8 W (watts), and/or
- Off mode power consumption < 0.5 W (watts), and/or
- Standby mode power consumption < 0.5 W (watts).

### Disposal and Recycling Information

The symbol below means that according to local regulations your product and/or its battery shall be disposed of separately from domestic waste. If this product is end of life, take it to a recycling station designated by local authorities. At the time of disposal, the separate collection of your product and/or its battery will help save natural resources and ensure that the environment is sustainable development.

Die folgende Symbol bedeutet, dass Ihr Produkt und/oder seine Batterie gemäß den örtlichen Bestimmungen getrennt vom Hausmüll entsorgt werden muss. Wenden Sie sich an eine Recyclingstation, wenn dieses Produkt das Ende seiner Lebensdauer erreicht hat. Zum Zeitpunkt der Entsorgung wird die getrennte Sammlung von Produkt und/oder seiner Batterie dazu beitragen, natürliche Ressourcen zu sparen und die Umwelt und die menschliche Gesundheit zu schützen.

El símbolo de abajo indica que según las regulaciones locales, su producto y/o su batería deberán depositarse como basura separada de la doméstica. Cuando este producto alcance el final de su vida útil, llévelo a un punto limpio. Cuando llegue el momento de desechar el producto, la recogida por separado éste y/o su batería ayudará a salvar los recursos naturales y a proteger la salud humana y medioambiental.

Le symbole ci-dessous signifie que selon les réglementations locales votre produit et/ou sa batterie doivent être éliminés séparément des ordures ménagères. Lorsque ce produit atteint sa fin de vie, amenez-le à un centre de recyclage. Au moment de la mise au rebut, la collecte séparée de votre produit et/ou de sa batterie aidera à économiser les ressources naturelles et protéger l'environnement et la santé humaine.

Il simbolo sotto significa che secondo i regolamenti locali il vostro prodotto e/o batteria deve essere smaltito separatamente dai rifiuti domestici. Quando questo prodotto raggiunge la fine della vita di servizio portarlo a una stazione di riciclaggio. Al momento dello smaltimento, la raccolta separata del vostro prodotto e/o della sua batteria aiuta a risparmiare risorse naturali e a proteggere l'ambiente e la salute umana.

Symbolen innebär att enligt lokal lagstiftning ska produkten och/eller dess batteri kastas separat från hushållsavfallet. När den här produkten når slutet av sin livslängd ska du ta den till en återvinningsstation. Vid tiden för kasseringen bidrar du till en bättre miljö och mänsklig hälsa genom att göra dig av med den på ett återvinningsställe.



## 台灣

安全警告 – 為了您的安全，請先閱讀以下警告及指示：





- 請勿將此產品接近水、火焰或放置在高溫的環境。
- 避免設備接觸：
  - 任何液體 - 切勿讓設備接觸水、雨水、高濕度、污水腐蝕性的液體或其他水份。
  - 灰塵及污物 - 切勿接觸灰塵、污物、沙土、食物或其他不適合的材料。
- 雷雨天氣時，不要安裝或維修此設備。有遭受電擊的風險。
- 切勿重摔或撞擊設備，並勿使用不正確的電源變壓器。
- 若接上不正確的電源變壓器會有爆炸的風險。
- 請勿隨意更換產品內的電池。
- 如果更換不正確之電池型式，會有爆炸的風險，請依製造商說明書處理使用過之電池。
- 請將廢電池丟棄在適當的電器或電子設備回收處。
- 請勿將設備解體。
- 請勿阻礙設備的散熱孔，空氣對流不足將會造成設備損害。
- 請使用隨貨提供或指定的連接線 / 電源線 / 電源變壓器，將其連接到合適的供應電壓（如：台灣供應電壓 110 伏特）。
- 假若電源變壓器或電源變壓器的纜線損壞，請從插座拔除，若您還繼續插電使用，會有觸電死亡的風險。
- 請勿試圖修理電源變壓器或電源變壓器的纜線，若有毀損，請直接聯絡您購買的店家，購買一個新的電源變壓器。
- 請勿將此設備安裝於室外，此設備僅適合放置於室內。
- 請勿隨一般垃圾丟棄。
- 請參閱產品背貼上的設備額定功率。
- 請參考產品型錄或是彩盒上的作業溫度。

- 產品沒有斷電裝置或者採用電源線的插頭視為斷電裝置的一部分，以下警語將適用：
  - 對永久連接之設備，在設備外部須安裝可觸及之斷電裝置；
  - 對插接式之設備，插座必須接近安裝之地點而且是易於觸及的。

## About the Symbols

Various symbols are used in this product to ensure correct usage, to prevent danger to the user and others, and to prevent property damage. The meaning of these symbols are described below. It is important that you read these descriptions thoroughly and fully understand the contents.

### Explanation of the Symbols

SYMBOL	EXPLANATION
	Alternating current (AC): AC is an electric current in which the flow of electric charge periodically reverses direction.
	Direct current (DC): DC is the unidirectional flow or movement of electric charge carriers.
	Earth, ground: A wiring terminal intended for connection of a Protective Earthing Conductor.
	Class II equipment: The method of protection against electric shock in the case of class II equipment is either double insulation or reinforced insulation.

## Viewing Certifications

Go to <http://www.zyxel.com> to view this product's documentation and certifications.

## Zyxel Limited Warranty

Zyxel warrants to the original end user (purchaser) that this product is free from any defects in material or workmanship for a specific period (the Warranty Period) from the date of purchase. The Warranty Period varies by region. Check with your vendor and/or the authorized Zyxel local distributor for details about the Warranty Period of this product. During the warranty period, and upon proof of purchase, should the product have indications of failure due to faulty workmanship and/or materials, Zyxel will, at its discretion, repair or replace the defective products or components without charge for either parts or labor, and to whatever extent it shall deem necessary to restore the product or components to proper operating condition. Any replacement will consist of a new or re-manufactured functionally equivalent product of equal or higher value, and will be solely at the discretion of Zyxel. This warranty shall not apply if the product has been modified, misused, tampered with, damaged by an act of God, or subjected to abnormal working conditions.

### Note

Repair or replacement, as provided under this warranty, is the exclusive remedy of the purchaser. This warranty is in lieu of all other warranties, express or implied, including any implied warranty of merchantability or fitness for a particular use or purpose. Zyxel shall in no event be held liable for indirect or consequential damages of any kind to the purchaser.

To obtain the services of this warranty, contact your vendor. You may also refer to the warranty policy for the region in which you bought the device at <https://www.zyxel.com/global/en/support/warranty-information>.

## Registration

Register your product online at [www.zyxel.com](http://www.zyxel.com) to receive email notices of firmware upgrades and related information.

## Trademarks

ZyNOS (Zyxel Network Operating System) and ZON (Zyxel One Network) are registered trademarks of Zyxel Communications, Inc. The trademarks mentioned in this publication are used for identification purposes only and may be properties of their respective owners.

## Numerics

1 Gbps [10](#)  
10 Gbps [10](#)  
100 Mbps [10](#)  
2.5 Gbps [10](#)  
5 Gbps [10](#)  
802.1Q VLAN-aware [47](#)  
802.1Q VLAN-unaware [47](#)

## A

aggregate physical link [50](#)  
air circulation  
  for cooling [14](#)  
airflow [18](#)  
application  
  backbone [11](#)  
  bridging [12](#)  
authorized technician  
  install the Switch [14](#)

## B

back pressure flow control [46](#)  
bandwidth capacity  
  cable types [11](#)  
bandwidth link [50](#)  
bridging application [12](#)  
broadcast [58](#)  
broadcast frame [47](#)  
broadcast packets [43](#)  
broadcast storm control [43](#)  
button  
  RESET [29](#)

## C

cable types [11](#)  
CAT 5 cable [11](#)  
CAT 5e cable [10](#)  
CAT 6 cable [10](#)  
CAT 6a cable [10](#)  
CAT 7 cable [11](#)  
Certificate Authority (CA) [60](#)  
certifications [74](#)  
  viewing [76](#)  
CFI (Canonical Format Indicator) [47](#)  
changing the password [28](#)  
clear counters [41](#)  
clearance  
  Switch installation [14](#)  
collision signal [46](#)  
contact information [68](#)  
copyright [73](#)  
CoS (Class of Service) [54](#)  
counters  
  clear [41](#)  
customer support [68](#)

## D

default IP [21](#)  
device name  
  configuration [40](#)  
DHCP server [63](#)  
disclaimer [73](#)  
disposal information [75](#)  
distance limitation  
  cable types [11](#)  
distribution type [51](#)

**E**

Energy Efficient Ethernet Standard **9**

ErP (Energy-related Products) **75**

Ethernet

connection speed **45**

Ethernet cable

type **14**

**F**

FCC EMC statement **73**

firmware upgrade **62**

process **63**

firmware version **40**

flow control **46**

frames

received **41**

tagged **47**

transmitted **41**

untagged **35, 47, 48**

front panel **17**

full duplex mode **46**

**G**

gateway **40, 63**

**H**

half duplex mode **46**

hardware installation **14**

hardware overview **17**

higher-capacity link **50**

HTTP service

enable **63**

HTTPS

certificates **60**

implementation **60**

public keys, private keys **60**

HTTPS introduction **60**

HTTPS service

enable **63**

**I**

icon

logout **29**

IEEE **9**

IEEE 802.1p QoS

apply **57**

IEEE 802.1Q VLAN **54**

add ports **33**

maximum number **49**

IEEE 802.3az EEE

enable **63**

IEEE 802.3az Energy Efficient Ethernet (EEE) **60**

IEEE priority **55**

IEEE802.3x flow control **46**

IGMP (Internet Group Management Protocol) **58**

IGMP join packet **59**

IGMP leave packet **59**

IGMP query port **59**

IGMP snooping **58**

overview **58**

settings **58**

IGMP Snooping screen **58**

IGMP static router port **59**

inactivity timeout

Web Configurator **22**

ingress port **48**

initial setup

example **30**

installation

air circulation **14**

desktop **14**

installation scenarios **14**

Internet browser

pop-up window **21**

supported **21**

IP address **40**

change **30**

default management **21**

manage **63**

IP packet

transmission method [58](#)  
IPTV service [58](#)

## J

Java permissions [21](#)  
JavaScript [21](#)  
jitter (variations in delay) [54](#)

## L

latency (delay) [54](#)  
LED  
    left [19, 20](#)  
    LINK/ACT [19](#)  
    PWR/SYS [19, 29](#)  
    right [19, 20](#)  
LEDs [19](#)  
    behavior [19](#)  
link aggregation [50, 59](#)  
    algorithm [51](#)  
    group [51](#)  
link status [40](#)  
login [21](#)  
    password [28](#)  
login account  
    administrator [61](#)  
logout icon [29](#)  
loop detection [42](#)  
loop prevention [42](#)  
    LED [19](#)  
loop state [40](#)  
loop status [40, 41](#)  
Low Power Idle (LPI) mode [60](#)  
lower-speed link [50](#)

## M

MAC address [40](#)  
Management screen [30, 31, 61](#)  
Management settings [61](#)

management VLAN  
    enable [63](#)  
managing the Switch  
    good habits [13](#)  
maximum distance  
    cable types [11](#)  
mirrored port [52, 53](#)  
model name [39](#)  
monitor port [52, 53](#)  
mounting  
    wall [15](#)  
mounting holes  
    distance [15](#)  
multicast [58](#)  
multicast drop [59](#)  
multicast frame [47](#)  
multicast group [47](#)  
Multi-Gigabit [10](#)  
Multi-Gigabit application [11](#)

## N

network applications [10](#)  
network flooded [42](#)

## O

overheating  
    prevention [14](#)

## P

packet collision [46](#)  
password [28](#)  
    administrator [61](#)  
    change [28, 63](#)  
    default [21](#)  
    default administrator [28](#)  
    set [31](#)  
PCP (Priority Code Point) [54](#)  
port  
    untagged [49](#)

port mirroring  
  direction [53](#)  
  overview [52](#)  
port number [48, 53](#)  
Port screen [43](#)  
port settings [45](#)  
port statistics [38](#)  
Port VID  
  set [35](#)  
port VLAN ID, see PVID [48](#)  
power connector [18](#)  
product registration [76](#)  
PVID [35, 47](#)  
PVID (Port VLAN ID) [48](#)

## Q

QoS  
  IEEE 802.1p [54](#)  
  port-based [54](#)  
QoS (Quality of Service) [54](#)  
QoS screen [54](#)  
queue  
  weight [56](#)

## R

rear panel [17](#)  
rear panel connections [18](#)  
reboot the Switch [62](#)  
recycling information [75](#)  
registration  
  product [76](#)  
RESET button [29](#)  
reset the Switch [62](#)  
resetting [28](#)  
restart the Switch [62](#)  
restoring configuration [28](#)  
rubber feet  
  attach [14](#)

## S

safety warnings [74](#)  
screen resolution  
  recommended [21](#)  
screw specifications  
  wall mount [16](#)  
single-port link [50](#)  
Spanning Tree Protocol (STP) [42](#)  
SSL (Secure Socket Layer) [60](#)  
status [26](#)  
subnet mask [40, 63](#)  
Switch  
  fanless-type usage precaution [14](#)  
  fan-type usage precaution [14](#)  
  general information [38](#)  
  IPv4 address [40](#)  
  lock [28](#)  
  managing [13](#)  
  model name [39](#)  
  reset [28](#)  
Switch lockout [28](#)  
System screen [38](#)

## T

tagged VLAN [47](#)  
TCI (Tag Control Information) [47](#)  
TPID (Tag Protocol Identifier) [47](#)  
trademarks [76](#)  
traffic distribution [51](#)  
traffic type mapping [55](#)  
transmission speed  
  cable types [11](#)  
Troubleshooting [65](#)

## U

unicast [58](#)



**V**

ventilation holes [14](#)  
VID [49](#)  
    number of possible VIDs [47](#)  
    priority frame [47](#)  
VID (VLAN IDentifier) [47](#)  
VLAN  
    creation [33](#)  
    ID [47](#)  
    introduction [47](#)  
    PVID [48](#)  
    settings [47](#)  
    shared server example [13](#)  
    tag-based example [13](#)  
    tagged [47](#)  
VLAN application  
    example [12](#)  
VLAN ID [47](#), [49](#)  
VLAN tags [34](#)  
VLAN-unaware devices [34](#)  
VOD (Video on Demand) [54](#)  
Voice over IP (VoIP) [54](#)

**W**

wall-mounting [15](#)  
warranty  
    note [76](#)  
Web Configurator  
    home [26](#)  
    inactivity timeout [22](#)  
    layout [26](#)  
    log out link [27](#)  
    login [21](#)  
    logout [29](#)  
    main window [27](#)  
    overview [21](#)  
Weighted Round Robin Scheduling (WRR) [55](#)  
Windows OS version  
    check [22](#)  
WRR application  
    example [55](#)  
WRR scheduling [56](#)  
WS (web server) [60](#)

**Z**

ZDP [22](#)  
ZON Utility [22](#)  
    compatible OS [22](#)  
    fields description [26](#)  
    icon description [25](#)  
    installation requirements [22](#)  
    introduction [22](#)  
    minimum hardware requirements [23](#)  
    network adapter select [24](#)  
    password prompt [25](#)  
    run [23](#)  
    supported firmware version [23](#)  
    supported models [23](#)  
Zyxel AP Configurator (ZAC) [26](#)  
Zyxel Discovery Protocol (ZDP) [22](#)  
Zyxel limited warranty [76](#)  
Zyxel One Network (ZON) Utility [22](#)