

# VC-TR60/ VC-TR60, Dante AV-H

## Auto Tracking Camera

(PTZ Video Camera)

## User Manual - English

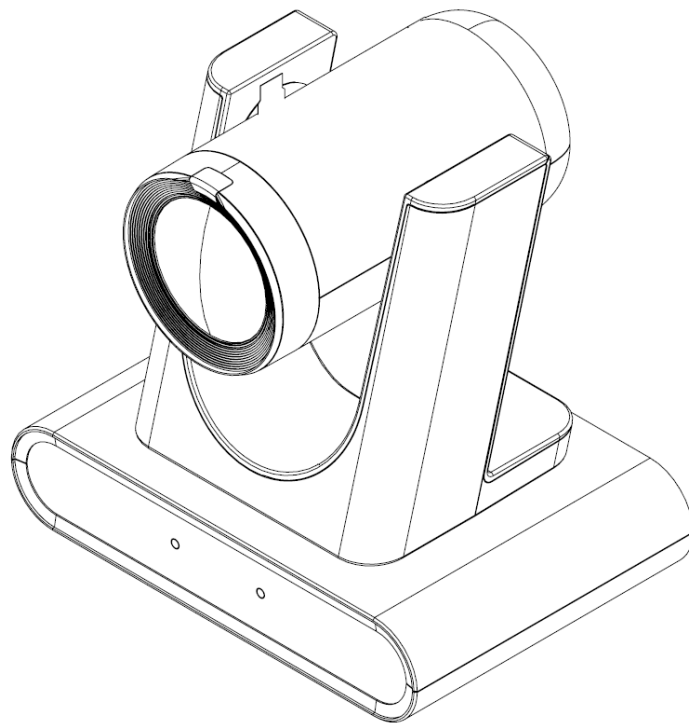

Version VXY020X

**[Important]**





To download the latest version of Quick Start Guide, multilingual user manual, software, or driver, etc., please visit Lumens  
<https://www.MyLumens.com/support>

# Table of Contents

<b>Chapter 1</b>	<b>Package Contents.....</b>	<b>2</b>
<b>Chapter 2</b>	<b>Product Overview .....</b>	<b>3</b>
2.1	I/O functions Introduction.....	3
2.2	Description of LED indicator .....	3
<b>Chapter 3</b>	<b>Instruction for installation.....</b>	<b>4</b>
3.1	Scenario.....	4
3.2	Preparation before installation .....	4
3.3	Instruction for installation .....	4
3.4	Connecting devices.....	7
<b>Chapter 4</b>	<b>Remote Control and Setting Menu .....</b>	<b>9</b>
4.1	Remote Control .....	9
4.2	Setting Menu .....	10
<b>Chapter 5</b>	<b>Network Function Settings Description .....</b>	<b>14</b>
5.1	Connecting Camera to Network .....	14
5.2	Web Page Menu Function Description .....	16
<b>Chapter 6</b>	<b>Troubleshooting .....</b>	<b>36</b>
<b>Chapter 7</b>	<b>Safety Instructions .....</b>	<b>37</b>
	<b>Copyright Information.....</b>	<b>38</b>

# Chapter 1 Package Contents

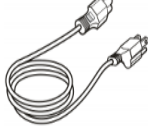
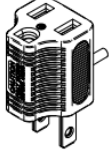
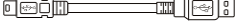
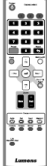
---

<b>Camera</b>	<b>Power Adapter</b>	<b>Power Cord</b>	<b>3-PIN to 2-PIN connector</b>
		 <p>Appearance may vary depending on country/region</p>	 <p>(For Japan only)</p>
<b>USB cable - 2M (Type B to Type A)</b>	<b>Remote Control</b>	<b>RS232/RS422 Connection Instruction</b>	
			

# Chapter 2 Product Overview

## 2.1 I/O functions Introduction

Front View

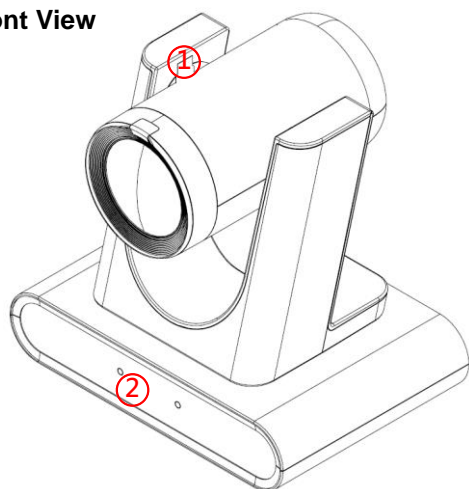

Back View

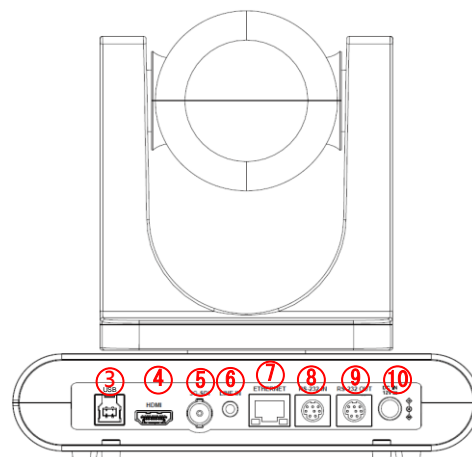

NO.	Item	Function Descriptions
1.	Main camera lens	HD camera lens
2.	Power/Standby LED indicator	Displaying the status of the camera, please refer to <a href="#">2.2 Description of LED indicator</a>
3.	USB Port	The USB port is for connecting to the USB port of the computer and providing USB signal images
4.	HDMI output	HDMI output (Audio output supported)
5.	3G-SDI output	3G-SDI output (Audio output supported)
6.	Audio In	3.5 mm LINE IN
7.	Network port	Network cable port, supporting PoE (IEEE802.3at) power supply
8.	RS-232 input	RS-232 input port, at most 7 cameras can be connected in a serial connection
9.	RS-232 output	RS-232 output port, at most 7 cameras can be connected in a serial connection
10.	DC 12 V power Port	DC supply connecting port

## 2.2 Description of LED indicator

Status	Power	Standby
Startup in progress	Green light	Orange light
In use	Green light	No indicator
In standby mode	No indicator	Orange light
Tracking / Auto Framing mode	Flickering green light	Flickering green light

# Chapter 3 Instruction for installation

## 3.1 Scenario

3.1.1 Best tracking target distance recommended: 8 m

3.1.2 Best height recommended: 2.5 m

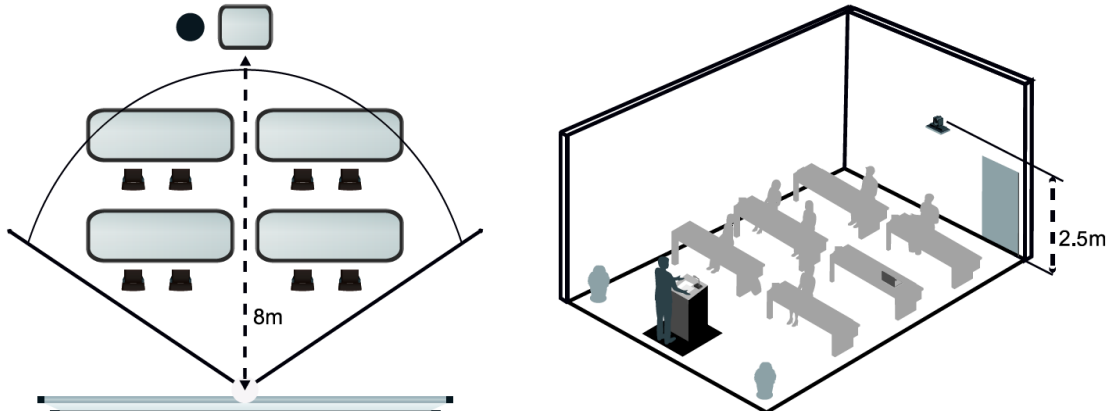

<Note> For maintaining the best tracking results, please avoid images of people on posters, screens, monitors, TVs in the background

## 3.2 Preparation before installation

Installation and connection of HD camera requires special skills. To install by yourself, please follow necessary steps, ensure steady and tight installation of the device, and pay attention to your safety to avoid any accident.

3.2.1 Ensure the safety of the installation environment. Please do not install the device on unstable ceiling or in a place where the device is in danger of falling to avoid any accident.

3.2.2 Please check whether accessories in the box are complete or not. Please contact the supplier for any shortage, and make sure to keep the accessories in the box intact.

3.2.3 Please choose a proper place for installation of camera in advance. Please determine an installation place according to the following requirements

- Confirm the position for the object to be captured.
- Confirm whether the camera is set at a proper distance from other light sources.

## 3.3 Instruction for installation

3.3.1 I would like to install camera on the desk

3.3.1.1 Precautions for installation

- Please install the machine on a flat desk
- Do not grab the camera head by hand when handling the device
- Do not rotate the camera head by hand. Improper rotation may result in breakdown of the camera

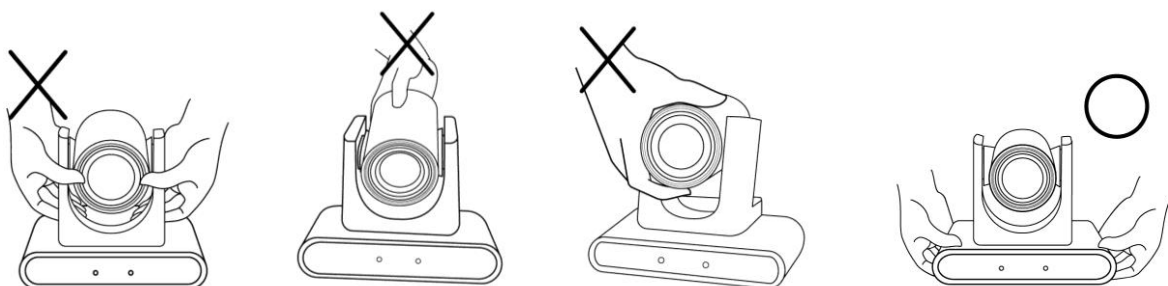

### 3.3.2 I would like to install the camera on the ceiling/wall/TV stand

Lumens can provide the following optional accessories. Please contact your Lumens distributor if needed for purchase

- VC-WM14 3 in 1 Folding Bracket
- VC-WM15 Ceiling Mounted Bracket

For installation of brackets, please download [VC-WM14/VC-WM15 Quick Installation Guide](#) from the Lumens website

#### ◆ Install on the TV

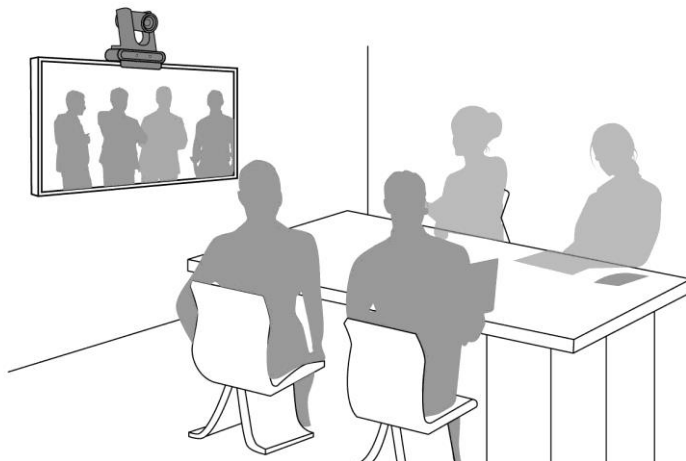

#### ◆ Install on the ceiling

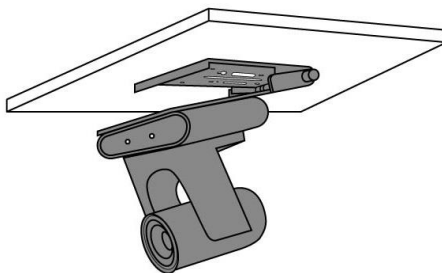

#### ◆ Install on the wall

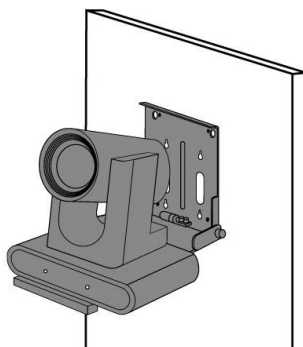

### 3.3.3 Camera Size

- Length x Width x Height: 190 x 149 x 185 mm
- Weight: 1.6 Kg

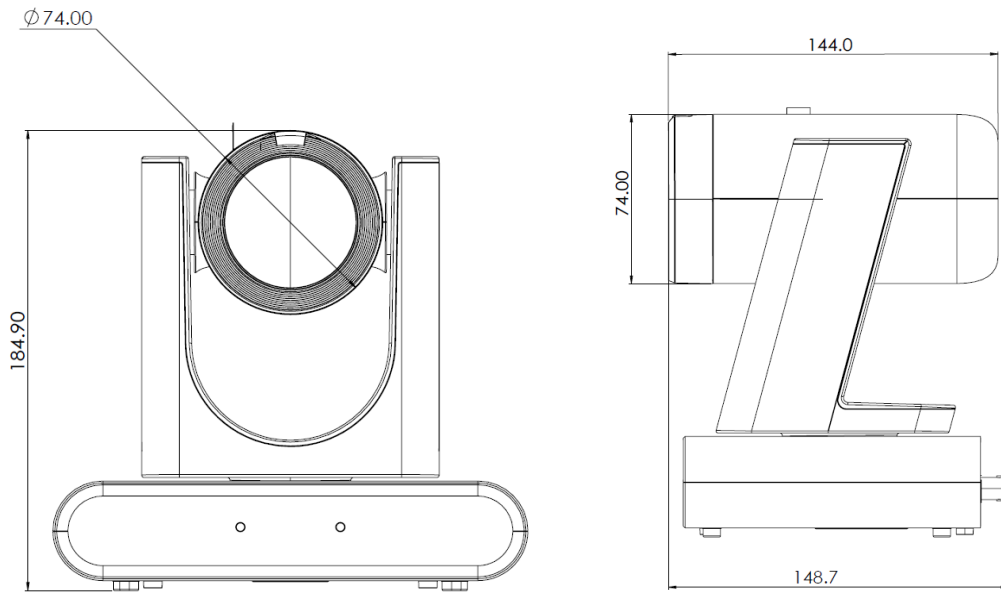

### 3.3.4 Dimensions of the bottom of the machine

The camera can be mounted on a 1/4" - 20 UNC PTZ tripod deck by using the lock holes on the bottom for the tripod

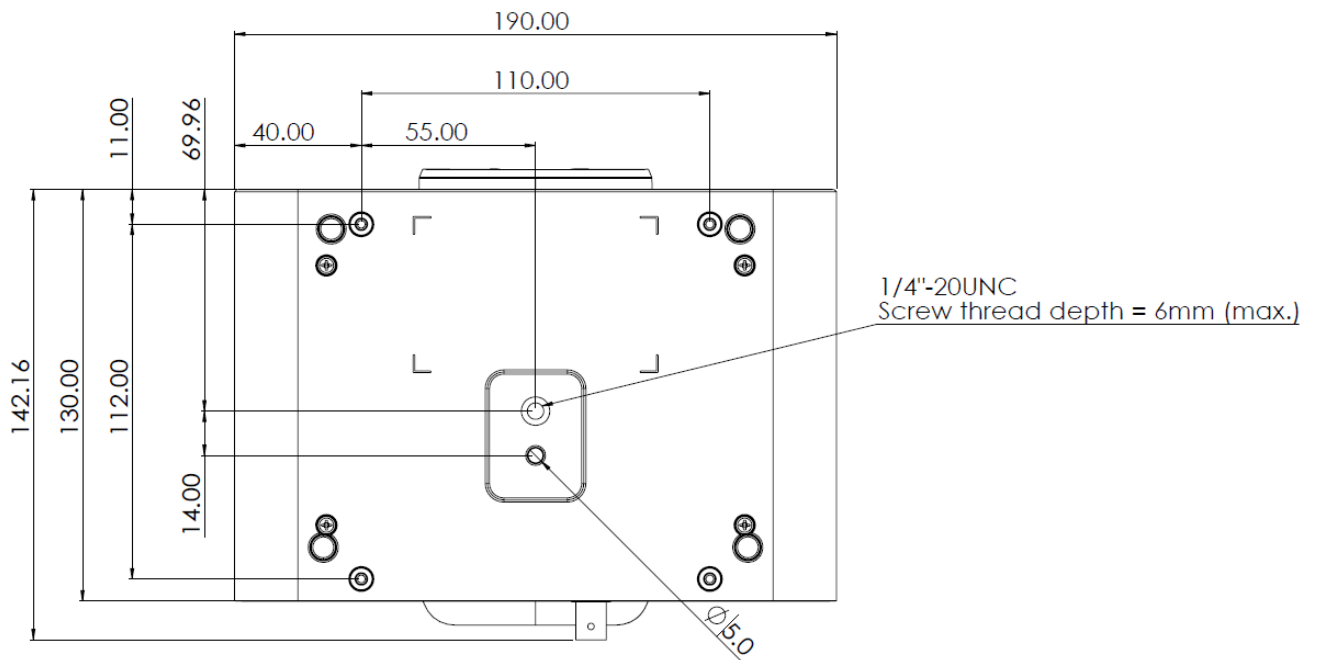

### 3.4 Connecting devices

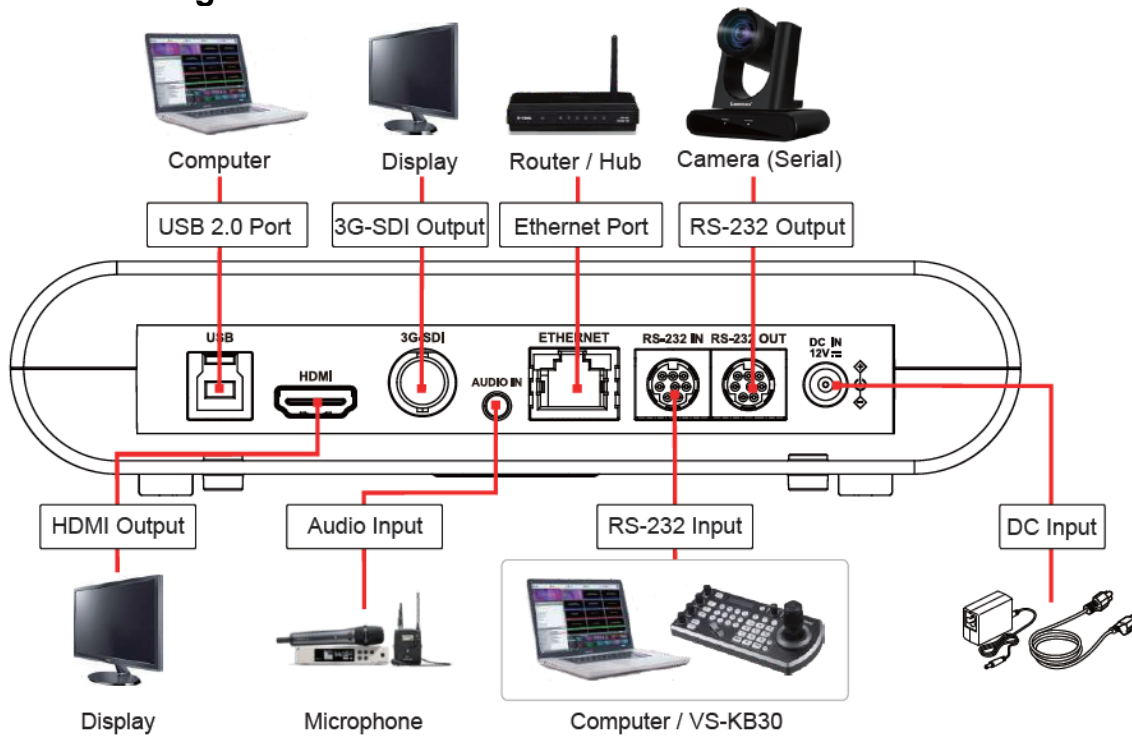

<Remark> Network cable port, supporting PoE (IEEE802.3at) power supply

#### 3.4.1 RS-232 connection (at most 7 Lumens cameras can be connected)

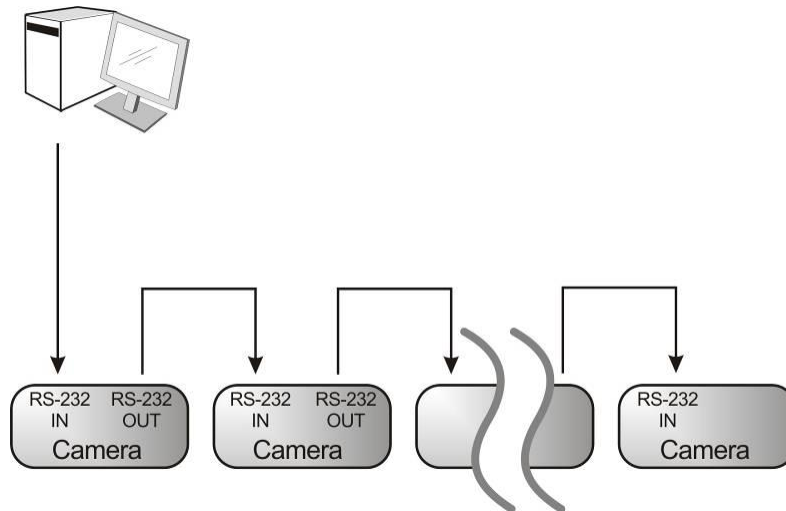



## ■ RS-232 pins definition instructions

### ▼ RS-232 IN Pins Instructions

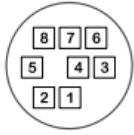

NO	Pins	Signals
1	DTR	Data Transmission Reade
2	DSR	Data Set Reade
3	TXD	Transmit Data
4	GND	Ground
5	RXD	Receive Data
6	GND	Ground
7	IR OUT	IR Commander Signal
8	N.C.	No Connection

### ▼ RS-232 OUT Pins Instructions

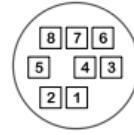

NO	Pins	Signals
1	DTR	Data Transmission Reade
2	DSR	Data Set Reade
3	TXD	Transmit Data
4	GND	Ground
5	RXD	Receive Data
6	GND	Ground
7	OPEN	Reserved
8	OPEN	Reserved

### ▼ RS-232 Connection Instructions

#### RS-232 IN of VC

1. DTR
2. DSR
3. TXD
4. GND
5. RXD
6. GND
7. IR OUT
8. N.C.

#### RS-232 of PC

1. CD
2. RXD
3. TXD
4. DTR
5. GND
6. DSR
7. RTS
8. CTS
9. RI

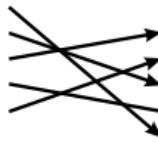

### ▼ RS-232 Connection Instructions

#### RS-232 IN of Next Camera

1. DTR
2. DSR
3. TXD
4. GND
5. RXD
6. GND
7. IR OUT
8. N.C.

#### RS-232 OUT of Last Camera

1. DTR
2. DSR
3. TXD
4. GND
5. RXD
6. GND
7. OPEN
8. OPEN

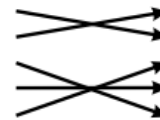

# Chapter 4 Remote Control and Setting Menu

## 4.1 Remote Control

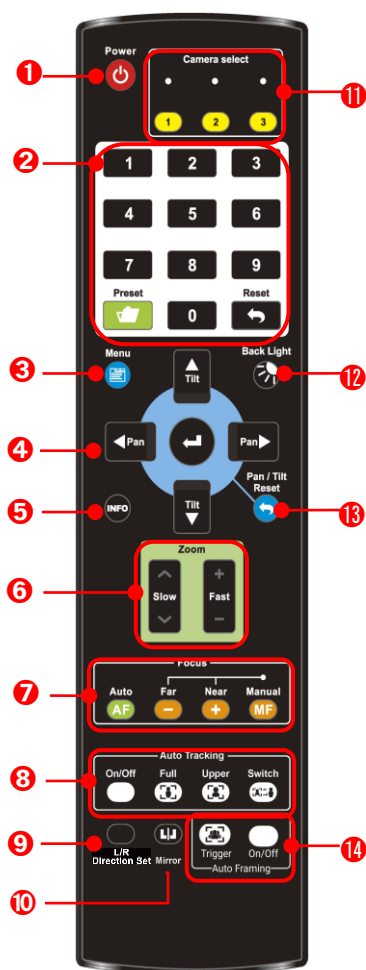

No.	Item	Description
1.	Power	Power Switch
2.	Preset	<ul style="list-style-type: none"> <li>Numeric Keys 0 - 9: Click to call the preset</li> <li>Preset: Appoint an ID (0 ~ 9) to save the current position data</li> <li>Reset: Appoint an ID (0 ~ 9) to delete the current position data</li> </ul>
3.	Menu	Display OSD menu
4.	Pan/Tilt/Enter	<ul style="list-style-type: none"> <li>Pan/Tilt: Move the lens</li> <li>Home-Enter: Go back to the main page / Execute</li> </ul>
5.	Info	Status information
6.	Zoom	<ul style="list-style-type: none"> <li>Fast: Adjust image size</li> <li>Slow: Fine-tune image size</li> </ul>
7.	Focus	<ul style="list-style-type: none"> <li>Auto: Auto focus</li> <li>Manual: Enable Manual Focus</li> <li>Far/Near: Adjust the focal length in Manual</li> </ul>
8.	Auto Tracking	<ul style="list-style-type: none"> <li>On/Off: Enable/Disable Auto Tracking</li> <li>Full: Full body tracking</li> <li>Upper: Half body tracking</li> <li>Switch: Switch tracking object</li> </ul>
9.	L/R Direction Set	L/R Direction / Normal
10.	Mirror	Rotate the image (OFF / Mirror / Flip / Rotate)
11.	Camera select	Choose camera ID 1 ~ 3
12.	Back Light	Turn on/off back light compensation
13.	Pan/Tilt Reset	Clear the Pan/Tilt setting
14.	Auto Framing	<ul style="list-style-type: none"> <li>On/Off: Enable/Disable Auto Framing</li> <li>Trigger: Manual framing correction</li> </ul>

## 4.2 Setting Menu

<Remark> Press [**Menu**] on the **remote control** to enter the setting menu; the **bold underlined** values in the following table are defaults.

1 <sup>st</sup> Level Major Items	2 <sup>nd</sup> Level Minor Items	3 <sup>rd</sup> Level Adjustment Values	Function Descriptions
Exposure	Mode	<u>Full Auto</u> / Shutter Pri / Iris Pri / Manual / White Board	Exposure mode setting
	Exposure Comp.	On / <u>Off</u>	Turn on/off Exposure Comp.
	Exposure Comp. Level	-6~ <u>C</u> ~4	The value can be adjusted after <b>Exposure Comp.</b> is activated
	Shutter Speed	1/10000~1/1	Adjustable when the <b>Exposure mode</b> is set to <b>Shutter Pri</b> or <b>Manual</b>
	Iris Level	F1.8~ <u>C</u> ~F11 / Close	Adjustable when the <b>Exposure mode</b> is set to <b>Iris Pri</b> or <b>Manual</b>
	Gain Limit	8~ <u>30</u> dB	Max. limit value of electron gain
	Gain Level	<u>0</u> ~45dB	Adjustable when the <b>Exposure mode</b> is set to <b>Manual</b>
	WDR	<u>Off</u> / 1 / 2 / 3	WDR settings
White Balance	Mode	<ol style="list-style-type: none"> <li>1. <u>Auto</u></li> <li>2. Indoor</li> <li>3. Outdoor</li> <li>4. One Push WB</li> <li>5. ATW</li> <li>6. Manual</li> <li>7. Sodium Lamp</li> </ol>	Select the color temperature mode <ol style="list-style-type: none"> <li>1. 4000k ~ 7000k</li> <li>2. 3200k</li> <li>3. 5800k</li> <li>4. 1700k ~ 10000k</li> <li>5. 1700k ~ 10000k</li> <li>6. Custom</li> <li>7. 2800k</li> </ol>
	One Push Trigger	<u>ENTER</u>	One push trigger
	Manual Red	0~ <u>C</u> ~128	Adjustable when the white balance mode is set to <b>Manual</b>
	Manual Blue	0~ <u>C</u> ~128	Adjustable when the white balance mode is set to <b>Manual</b>
Tracking	Type	<u>Auto Tracking</u> / Auto Framing	
Picture	3D NR	Off / Low / <u>Standard</u> / Highest	3D noise reduction
	Image Mode	<u>Default</u> / Custom	The user may customize his/her desired image mode
	Gamma	0~ <u>C</u> ~3	Adjustable when the <b>Image mode</b> is set to <b>Custom</b>
	Brightness	0~ <u>C</u> ~25	Adjustable when the <b>Image mode</b> is set to <b>Custom</b>
	Contrast	0~ <u>C</u> ~25	Adjustable when the <b>Image mode</b> is set to <b>Custom</b>

1 <sup>st</sup> Level Major Items	2 <sup>nd</sup> Level Minor Items	3 <sup>rd</sup> Level Adjustment Values	Function Descriptions
	Saturation	0~ <u>C</u> ~25	Adjustable when the <i>Image mode</i> is set to <b>Custom</b>
	Sharpness	0~ <u>C</u> ~11	Adjustable when the <i>Image mode</i> is set to <b>Custom</b>
Pan Tilt Zoom	Pan/Tilt Limit	On / <u>Off</u>	Turn on/off the angle limit setting
	Pan Right Limit	0~ <u>170</u>	Limit the right angle
	Pan Left Limit	<u>-170</u> ~0	Limit the left angle
	Tilt UP Limit	0~ <u>90</u>	Limit the upward angle
	Tilt Down Limit	<u>-30</u> ~0	Limit the downward angle
	Pan Flip	On / <u>Off</u>	After it is activated, the Pan command will be reverse
	Tilt Flip	On / <u>Off</u>	After it is activated, the Tilt command will be reverse
	Preset Speed	5 / 25 / 50 / 80 / <u>120</u> deg/sec	Set the PTZ rotation speed when <b>Preset</b> is performed
	PTZ Speed Comp	On / <u>Off</u>	Set the Pan/Tilt moving speed to vary from the zoom position
	D-Zoom Mode	<b>Digital Zoom</b> / Sensor Zoom	Set the zoom mode
D-Zoom/Sensor Zoom Limit	Digital Zoom: <u>x1</u> ~ x8 Sensor Zoom: <u>x1</u> ~ x3	Select the zoom mode to set the zoom limit	
D-Effect	Mirror	<u>Off</u> / Mirror / Flip / Mirror + Flip	Set the mode at which the image is turned
Auto Focus	AF Sensitivity	Low / <u>Mid</u> / High	For AF triggering speed, the higher the speed is, the faster AF is triggered
	AF Frame	Center / <u>Full Frame</u>	AF frame setting, when <b>Central</b> was set as AF frame, focusing will be on the center of the screen. When Full Frame was set as AF frame, focusing will be calculated based on the full screen
	Zoom Tracking	On / <u>Off</u>	This function can be set in the Manual Focus (MF) mode In Manual Focus mode, check whether focus is enabled during lens zooming
	PTZ Assist	On / <u>Off</u>	This function can only be enabled in the Manual Focus (MF) mode When PTZ Assist is enabled and PTZ control is in operation, the focus will be triggered. The focus will not be triggered when the scene changes
Ethernet	DHCP	<u>On</u> / Off	Enable/disable the dynamic host configuration

1 <sup>st</sup> Level Major Items	2 <sup>nd</sup> Level Minor Items	3 <sup>rd</sup> Level Adjustment Values	Function Descriptions
	IP Address	<u>192.168.100.100</u>	Configurable when <b>DHCP</b> is set to <b>Off</b>
	Subnet Mask	<u>255.255.255.0</u>	
	Gateway	<u>192.168.100.254</u>	
Audio	Audio Enable	On / <u>Off</u>	Turn on/off audio output
	Audio In	<u>Line In</u>	
	Audio Volume	0~ <u>C</u> ~10	Audio Volume Setting
	Audio Delay	On / <u>Off</u>	When the audio is not synchronized with the video, enable this function to set the audio delay time
	Audio Delay Time (ms)	<u>-10</u> ~-500ms	Set audio delay time
	Encode Sample Rate	<u>48</u> KHz (AAC)	Set the encode type and sample rate
System	Prompt	On / <u>Off</u>	Turn on/off the prompt information on the display
	IR Receive	<u>On</u> / Off	Turn on/off the infrared reception When it is Off, the remote control will not be able to control the camera. At this moment, turn off and then turn on the power to restore control of the remote control.
	IR Select	<u>1</u> / 2 / 3	Camera IR Select setting must be the same setting as the Camera Select of the remote control to control the camera
	Tally Lamp	On / <u>Off</u>	Select to enable or disable Tally Lamp function.
	Tally CMMD Mode	Normal / <u>Link</u>	Set whether the indicator light is linked with RS232 command <ul style="list-style-type: none"> <li>▪ <b>Normal</b> (Not linked): The indicator light switch and mode shall be set separately. <ul style="list-style-type: none"> <li>· When the indicator light is on and the default mode is off, additional command is required to set the indicator light mode</li> <li>· Setting indicator light mode when the indicator light is off will not trigger the indicator light</li> </ul> </li> <li>▪ <b>Link:</b> <ul style="list-style-type: none"> <li>· When the indicator light is on, the default mode is red light</li> <li>· Setting indicator light mode when the indicator light is off will turn on the indicator light</li> </ul> </li> </ul>
	Language	<u>English</u> / Chinese	
	Initial Position	<u>Last MEM</u> / 1st Preset	Select the camera lens to return to the

1 <sup>st</sup> Level Major Items	2 <sup>nd</sup> Level Minor Items	3 <sup>rd</sup> Level Adjustment Values	Function Descriptions
			<b>Last MEM position</b> or the <b>1st Preset position</b> after POWER ON <b>&lt;Remark&gt;</b> 1 <sup>st</sup> Preset = Preset 0
	<b>Motionless Preset</b>	On / <b>Off</b>	When the function is enabled, the screen will Freeze when <b>Preset</b> is executed. Freeze will be released after <b>Preset</b> is completed
	<b>Privacy Mode</b>	On / <b>Off</b>	Enable/Cancel Privacy Mode After the function is enabled, when the camera is turned off via the remote control or software, the lens will automatically turn to the bottom right to ensure the user's privacy
	<b>Protocol</b>	<b>VISCA</b>	VISCA/PELCO D protocol is supported
	<b>Baud Rate</b>	<b>9600</b> /38400	Choose the transmission speed of the control signal
	<b>VISCA Address</b>	<b>0</b> ~7	The camera ID address can be assigned. Select 0 for automation.
	<b>HDMI</b>	<b>2160P 59.94</b> /50/29.97/25 1080p 59.94/50/29.97/25 720p 59.94/50/29.97/25 1080i 59.94/50	Select the HDMI output resolution
	<b>SDI</b>	<b>1080p/59.94</b> /50/29.97/25 720p 59.94/50 1080i/59.94/50	Select the SDI output resolution
	<b>Factory Reset</b>	On / <b>Off</b>	Resume the factory default setting
<b>Status</b>			Display the current setting status

# Chapter 5 Network Function Settings Description

## 5.1 Connecting Camera to Network

### 5.1.1 Connecting to Internet

Two common connection methods are shown below

1. Connecting via switch or router

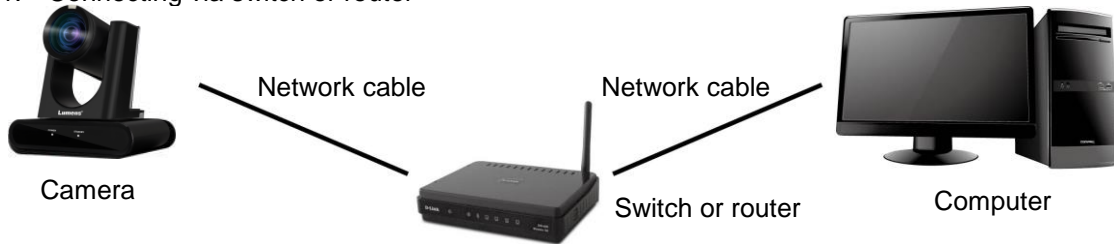

2. To connect directly through network cable, the IP address of the computer should be changed so that it is on the same network segment as the camera

**E.g.:** The factory-preset default IP address of the camera is 192.168.100.100. The computer IP address must be set with the same network segment, such as 192.168.100.101, so that the computer can be connected correctly with the camera

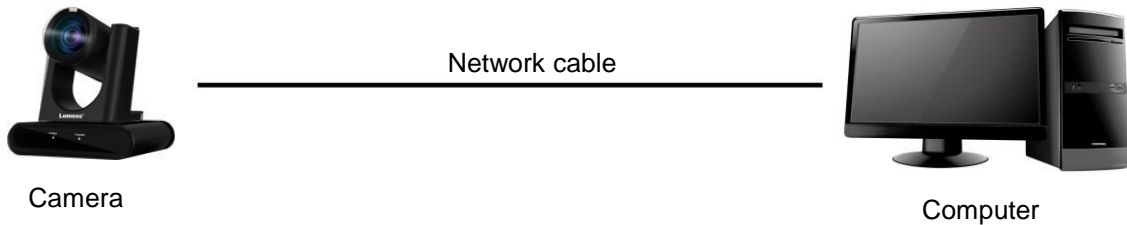

- Change network settings

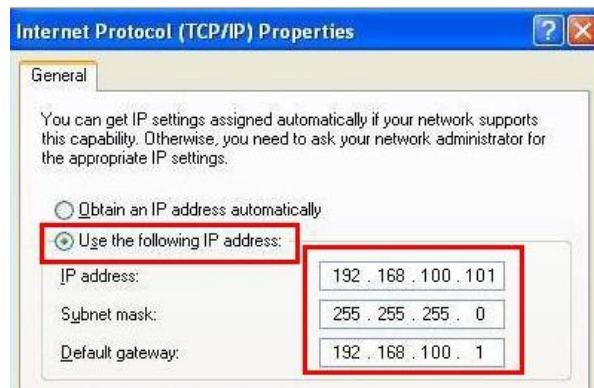

### 5.1.2 Using the Browser to View the Images

- Open the browser, and enter the IP address of the camera in the address bar

E.g.: <http://192.168.100.100> (default IP address)

- Enter administrator's account and password

<Remark> For the first-time login, please refer to [5.2.10 System Settings - User](#) to change the default password

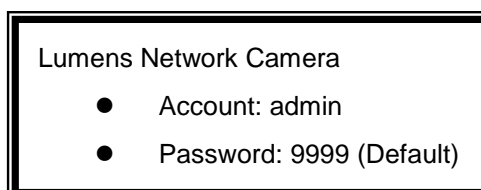

### 5.1.3 Using RTSP Player to View the Images

RTSP connections can be made using free software, e.g.: VLC, Quick Time, PotPlayer, etc.

RTSP connection address formats are as follows:

- RTSP Stream 1 => <rtsp://camera IP:8557/stream1>
- RTSP Stream 2 => <rtsp://camera IP:8557/stream2>

If password authentication is enabled, the RTSP connection address is as follows:

- [rtsp://Username:Password@VC IP address:8557/stream1 \(or stream2\)](rtsp://Username:Password@VC IP address:8557/stream1 (or stream2))
- To enable password authentication function, please refer to [5.2.8 System Setting - Network](#)

#### Example:

Open the VLC software, click [Open Network Streaming], and enter the URL:

<rtsp://192.168.100.150:8557/stream1>

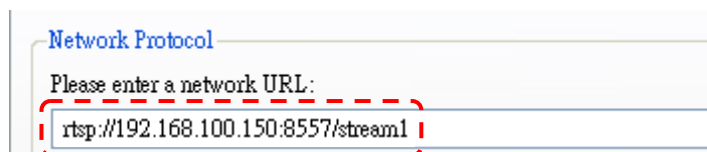
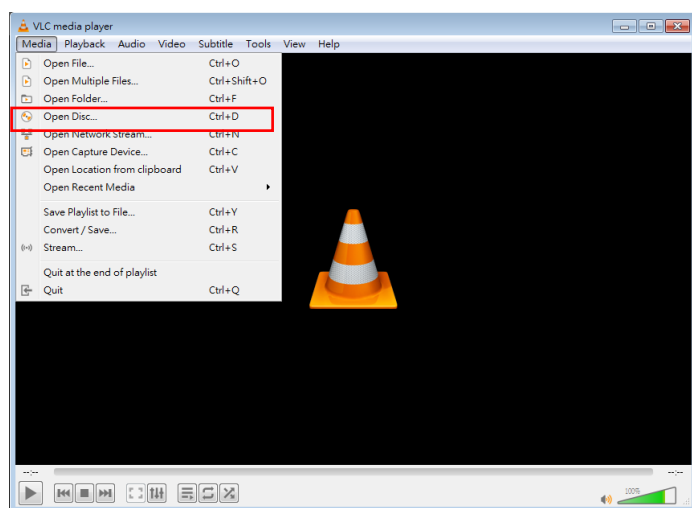



## 5.2 Web Page Menu Function Description

### 5.2.1 Login Screen

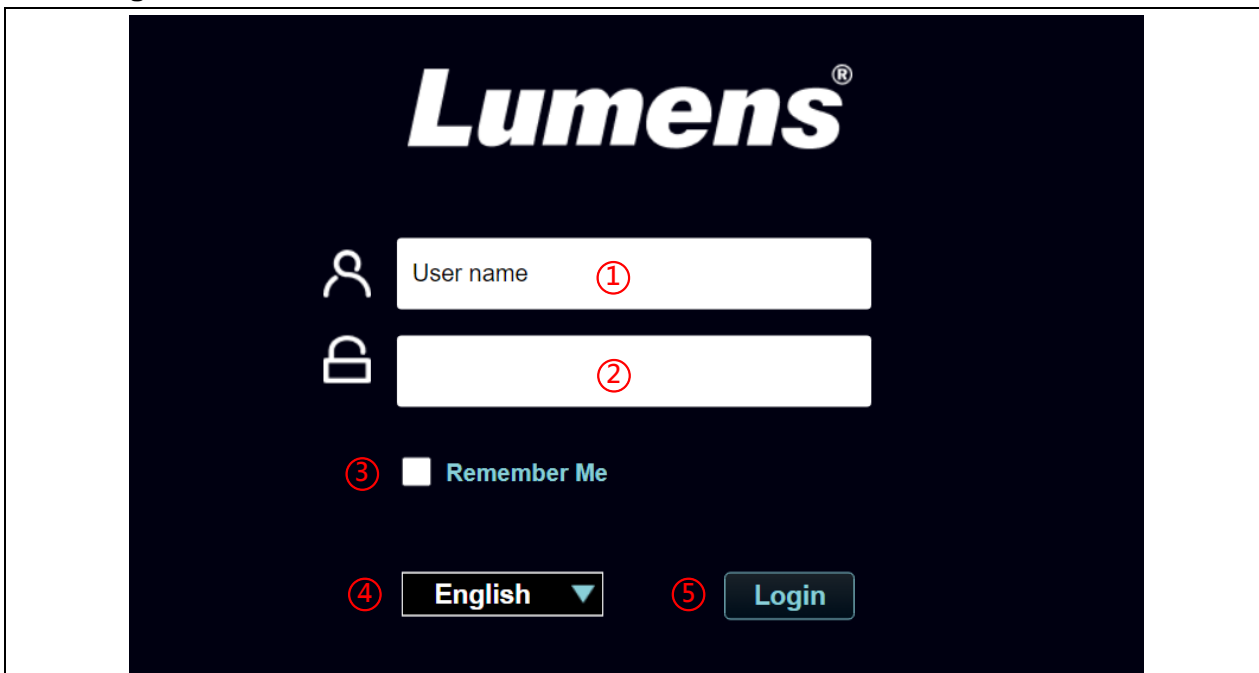

No	Item	Function Descriptions
1	User Login Account	Enter user login account (default: admin)
2	User Password	Enter user password (default: 9999) <Remark> For the first-time login, please refer to <a href="#">5.2.11 System Settings - User</a> to change the default password
3	Remember user account and password	Save user login account and password to the browser. When you log in next time, there is no need to re-enter them
4	Language	Supporting English/Traditional Chinese/Simplified Chinese
5	Login	Log in to the administrator screen on the website

## 5.2.2 Live Viewer - PTZ Control

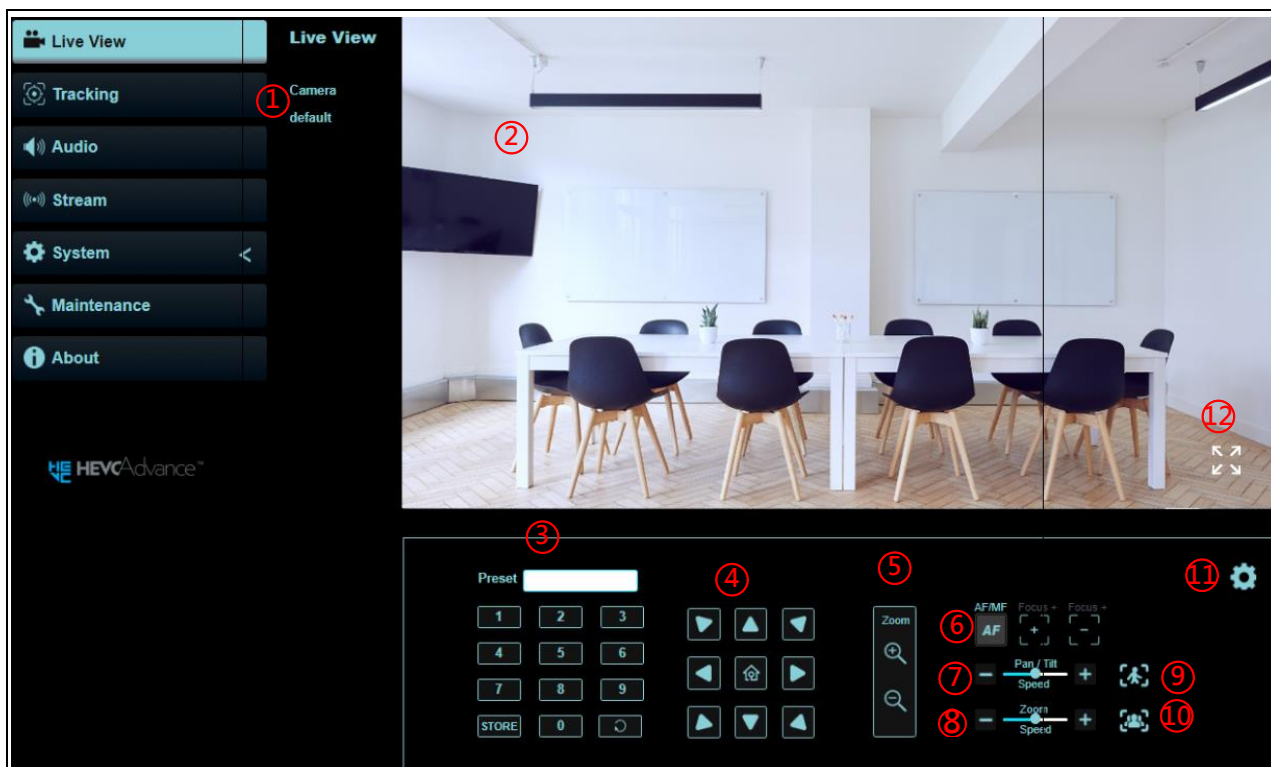

No	Item	Function Descriptions
1	Camera ID/location	Display camera ID/location Please refer to <a href="#">5.2.7 System - Device</a>
2	Preview window	Display the screen currently captured by the camera
3	Preset setting	Select the number first and then select SAVE or LOAD
4	Pan/Tilt setting	Adjust the Pan/Tilt position of the camera screen
5	Zoom	Zoom In/Zoom Out ratio
6	AF/MF	Switch to Auto Focus/Manual Focus. Focus can be adjusted in Manual Focus
7	Horizontal/Vertical Speed	Adjust the horizontal/vertical moving speed of the lens
8	Zoom speed	Adjust the zoom speed
9	Auto Tracking	Enable/Disable Auto Tracking
10	Auto Framing	Enable/Disable Auto Framing
11	Camera Setting	Please refer to <a href="#">5.2.3 Live Viewer - Camera Setting</a> for related settings
12	Enlarge the preview window	Zooming in/out the preview image

### 5.2.3 Live Viewer - Camera Setting



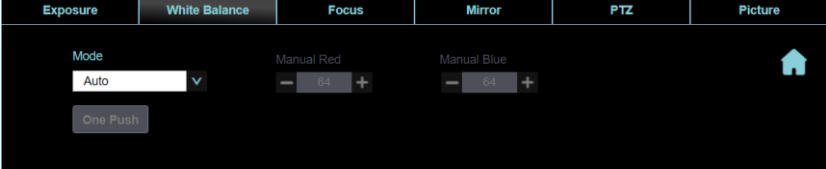
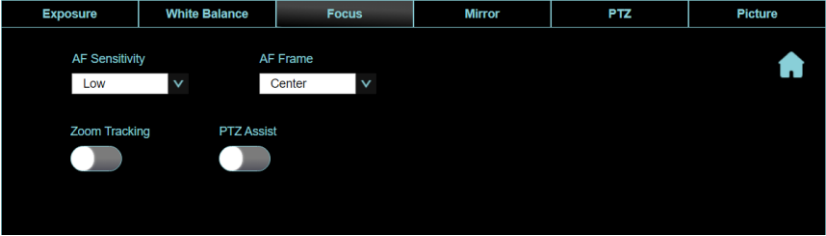
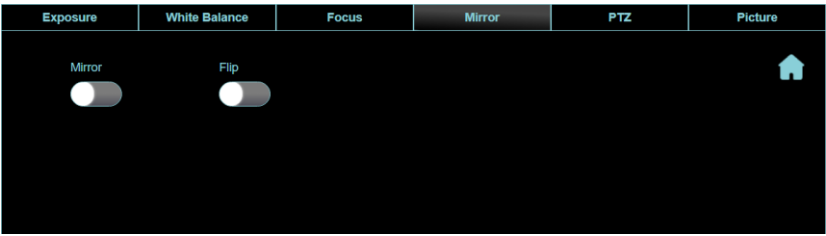

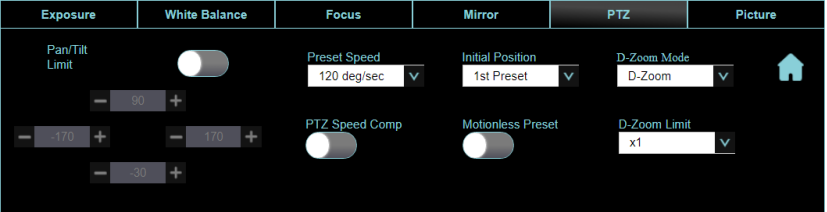
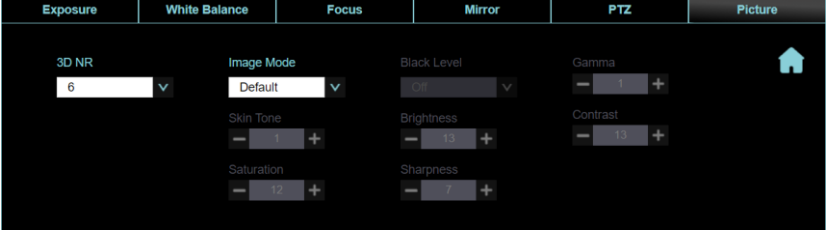

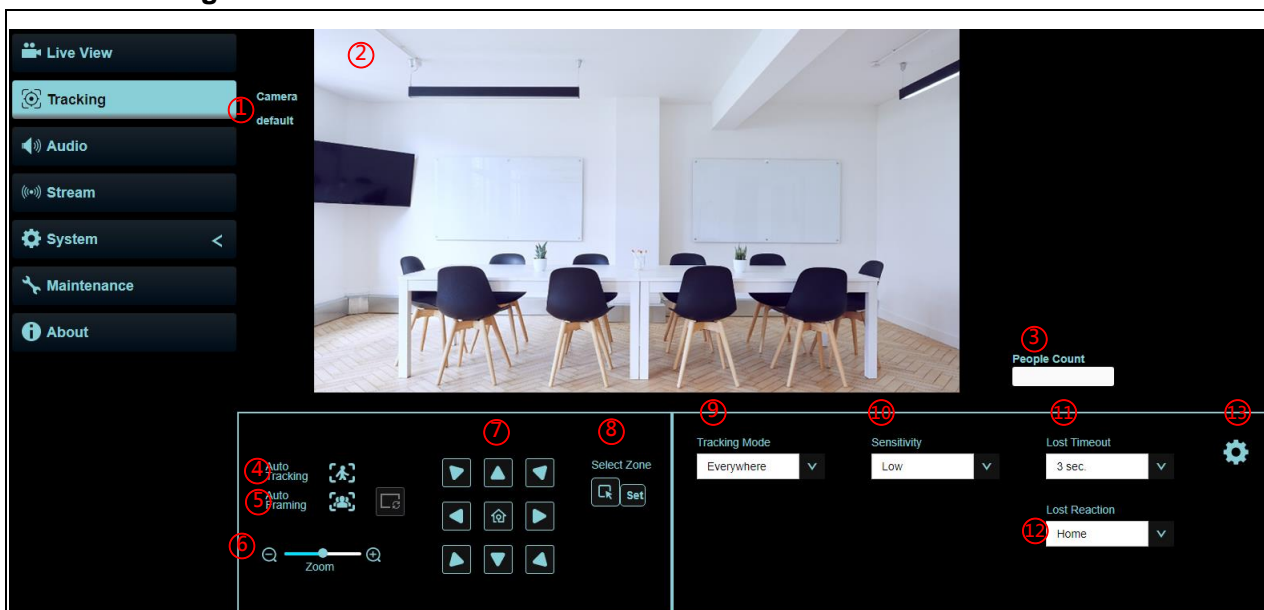

No	Item	Function Descriptions
1.	Exposure	<ul style="list-style-type: none"> <li>■ Mode: Select exposure mode (Full Auto/Shutter Pri/Iris Pri/Manual/White Board)</li> <li>■ WDR: Set the level of wide dynamic range (WDR) in order to obtain better images</li> <li>■ HDR: Set the On/ Off of high dynamic range (HDR) in order to obtain better images</li> <li>■ Exposure Comp. Level: Select exposure compensation level</li> <li>■ Gain Level: Adjust the gain level (adjustable under the “Manual”)</li> <li>■ Iris Level: Adjust the size of iris (adjustable under the “Manual” or “Iris Priority”)</li> <li>■ Shutter Speed: Adjust the shutter speed (adjustable under the “Manual” or “Shutter Priority”)</li> </ul>
2.	White Balance	 <ul style="list-style-type: none"> <li>■ Mode: Select the color temperature mode</li> <li>■ Manual Red/Blue: Adjust blue/red color temperature (adjustable under the “Manual”)</li> <li>■ One Push WB: Single color temperature execution adjustment (adjustable only under the “One Push WB”)</li> </ul>
3.	Focus	 <ul style="list-style-type: none"> <li>■ AF Sensitivity: Set automatic focus sensitivity</li> <li>■ AF Frame: Set automatic focus range</li> <li>■ Zoom Tracking: The focus mode during lens zooming (can be set in “Manual”)</li> <li>■ PTZ Assist: Check whether auto focus is enabled if there is any changes of PTZ (can be set in “Manual”)</li> </ul> <p>&lt;Remark&gt; When PTZ Assist is enabled and PTZ control is in operation, the focus will be triggered. The focus will not be triggered when the scene changes</p>
4.	Mirror	 <ul style="list-style-type: none"> <li>■ Mirror: Set image mirroring</li> <li>■ Flip: Set the mode at which the image is turned</li> </ul>

5.	Pan Tilt Zoom (PTZ)	 <ul style="list-style-type: none"> <li>■ Pan/Tilt limit: Enable, and set the pan/tilt limit</li> <li>■ Preset Speed: Set the rotation speed of the cradle head when Preset is executed</li> <li>■ Initial Position: Set the camera lens to return to the <b>last MEM</b> or the <b>1st Preset</b> after POWER ON  <b>&lt;Remark&gt; 1st Preset= Preset 0</b></li> <li>■ D-Zoom Mode: Select D-Zoom/Sensor Zoom Limit</li> <li>■ D-Zoom/Sensor Zoom Limit: Set the zoom limit</li> <li>■ PTZ Speed Comp: After it is activated, the Pan/Tilt moving speed will vary from the zoom position</li> <li>■ Motionless Preset: When the function is enabled, the screen will Freeze when Preset is executed. Freeze will be released after Preset is completed</li> </ul>
6.	Photo	 <ul style="list-style-type: none"> <li>■ 3D noise reduction: 3D noise reduction settings</li> <li>■ Image Mode: The user may customize his/her desired image mode</li> <li>■ Gamma: Gamma Level adjustment; Adjustable when the image mode is set to Custom</li> <li>■ Brightness: Brightness adjustment of the image; Adjustable when the image mode is set to Custom</li> <li>■ Contrast: Image contrast adjustment; Adjustable when the image mode is set to Custom</li> <li>■ Saturation: Saturation adjustment of the image; Adjustable when the image mode is set to Custom</li> <li>■ Sharpness: Sharpness adjustment of the image; Adjustable when the image mode is set to Custom</li> </ul>
7.	PTZ Control	Go back to PTZ Control page

## 5.2.4 Tracking



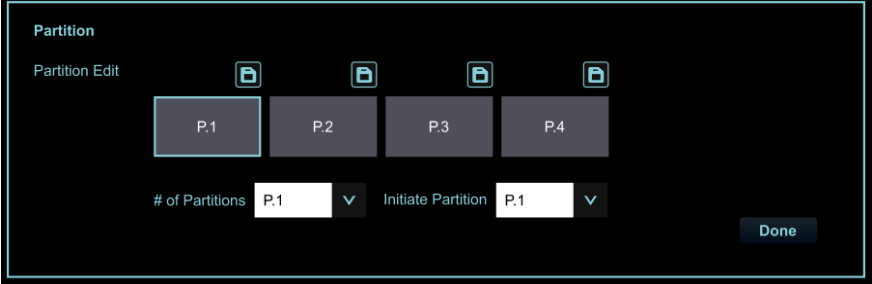

No	Item	Function Descriptions
1.	Camera ID/location	Please refer to <a href="#">5.2.7 System - Device</a> to display camera ID/location
2.	Preview window	Display the screen currently captured by the camera lens
3.	People Count	Display the number of people in the screen automatically calculated by the system
4.	Auto Tracking	Start/Stop Auto Tracking <b>&lt;Remark&gt;</b> Auto Tracking / Auto Framing (Select one only)
5.	Auto Framing	Start/Stop Auto Framing The camera will automatically detect the locations of people, and automatically adjust the zoom to the most appropriate size to accommodate all the participants according to change of the number of people in conference. <b>&lt;Remark&gt;</b> Auto Tracking / Auto Framing (Select one only) ※If the image is not zoomed according to the actual number of people, please click  to perform framing correction.
6.	Zoom ratio	Zoom In/Zoom Out ratio
7.	Pan/Tilt setting	Adjust the Pan/Tilt position of the camera screen <b>&lt;Remark&gt;</b> When Auto Tracking / Auto Framing is enabled, PTZ settings are not supported
8.	Select Zone	Click  and drag the mouse to select an area and then click  , the screen will be enlarged to the selected zone Click  again to cancel enlarging the selected zone
9.	Tracking Mode	Set the Tracking Mode (Everywhere/Stage/Partition/Auto Framing)
10.	Sensitivity	Set tracking sensitivity
11.	Target Lost Time	Set a delay for taking action after a tracking object is lost
12.	Target Lost Action	Set the action after a tracking object is lost
13.	Advanced Setting of Tracking Mode	Advanced Setting of Everywhere / Stage / Partition Tracking

13.1	Settings - Everywhere	 <p>Please refer to <a href="#">5.2.4.1 Everywhere</a> for the setting steps</p> <ul style="list-style-type: none"> <li>■ Body Size: Set Full/Half Body</li> <li>■ Body in Frame: Set the position of the person in the screen</li> <li>■ Border Limitation Enable: Check to set the left/right border</li> <li>■ Custom Home: When “Lost Reaction” is set as “Return”, you can customize the return position (only Pan/Tilt is memorized)</li> </ul>
13.2	Settings - Stage	 <ul style="list-style-type: none"> <li>■ Set the left/right border of the stage. Please refer to <a href="#">5.2.4.2 Stage</a> for the setting steps</li> <li>■ Custom Home: When “Lost Reaction” is set as “Return”, you can customize the return position (only Pan is memorized)</li> </ul>
13.3	Settings - Partition	<p>Set Partition. Up to 4 zones can be set.</p> <p>When a person enters the zone of a partition, the camera switches to the partition. Tracking is not performed in the zone, but everywhere outside the partition</p> <p>Please refer to <a href="#">5.2.4.3 Partition</a> for the setting steps</p>  <ul style="list-style-type: none"> <li>■ Partition Settings: Edit, save partition positions and preview the partition image Click to enlarge the partition image, and then click the enlarge icon to cancel the preview.</li> <li>■ Number of Partitions: Set the number of partitions</li> <li>■ Starting Partition: Set the initiate partition position (First tracking position when camera start tracking.)</li> </ul>

### 5.2.4.1 Everywhere

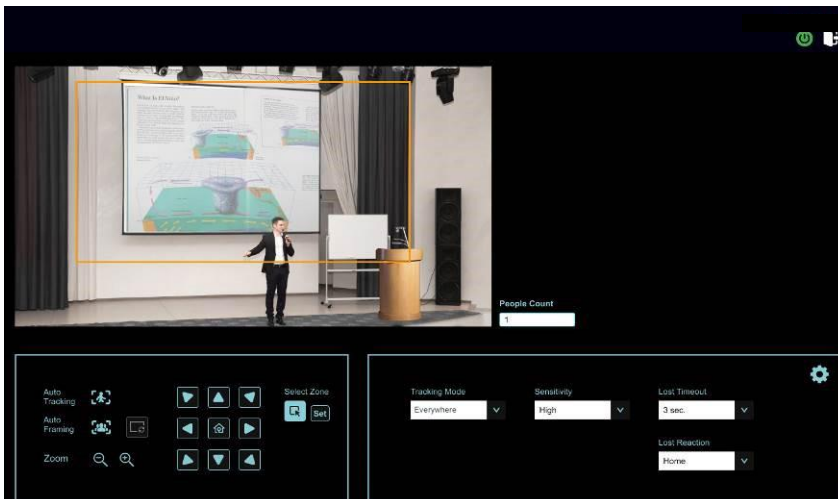



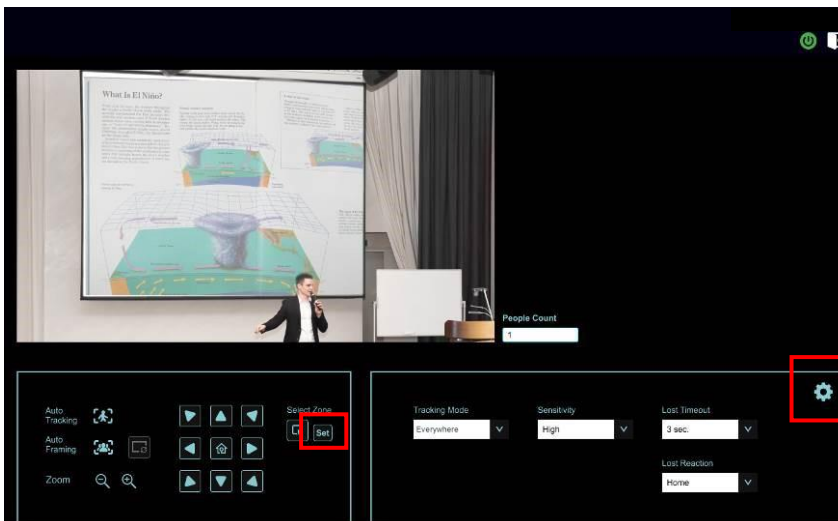

1. Select [Everywhere] for Tracking Mode, and click  box to select an area (orange box)



2. After the selection, click  to set, and the preview screen will display the selected area, then click  to access the settings



### 3. Set the Left/Right Border

- Left Border: Click   to move the position and click  when finished
- Right Border: Click   to move the position and click  when finished
- Click **Done** to complete the settings after setting the left/right border

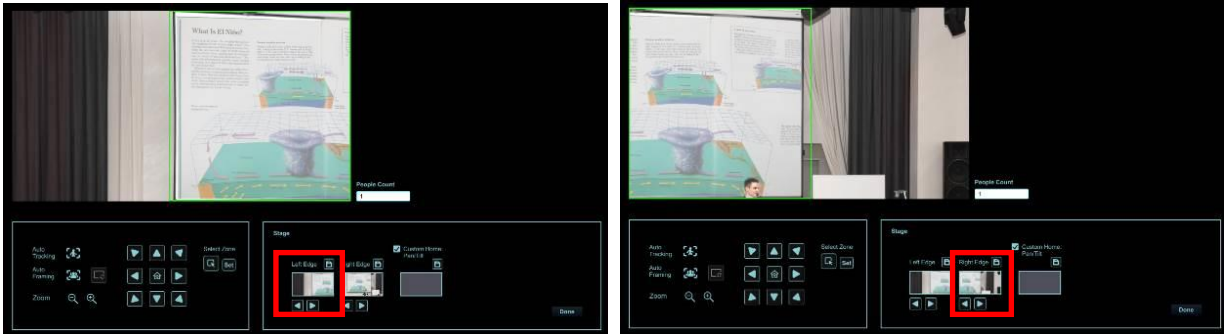

### 4. Click to enable the Everywhere feature

#### 5.2.4.2 Stage

### 5. Select [Stage] for Tracking Mode, and click box to select an area (orange box)

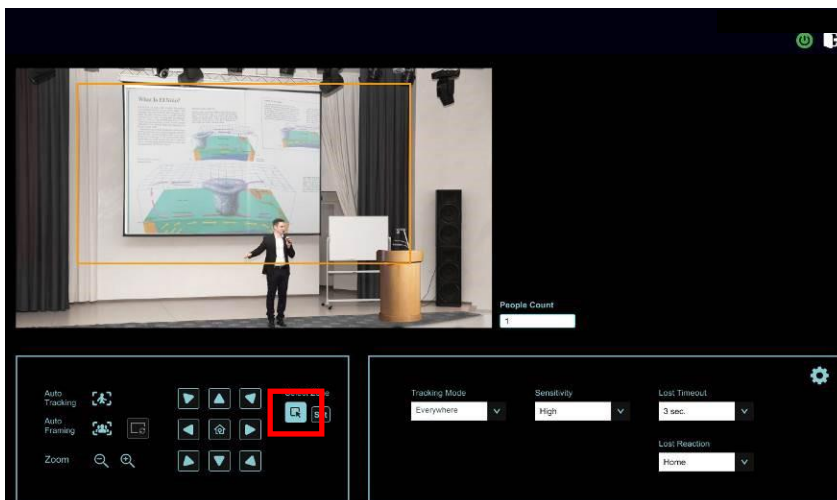

### 6. After the selection, click **Set** to set, and the preview screen will display the selected area, then click to access the settings

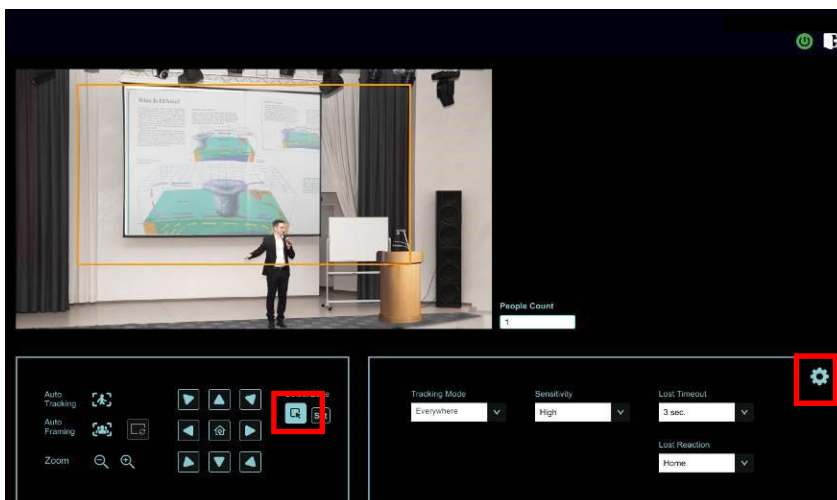



## 7. Set the Left/Right Border

- Left Border: Click to move the position and click when finished
- Right Border: Click to move the position and click when finished
- Click to complete the settings after setting the left/right border



## 8. Click to enable the Stage feature

### 5.2.4.3 Partition

1. Select [Partition] for Tracking Mode, and click to access the settings

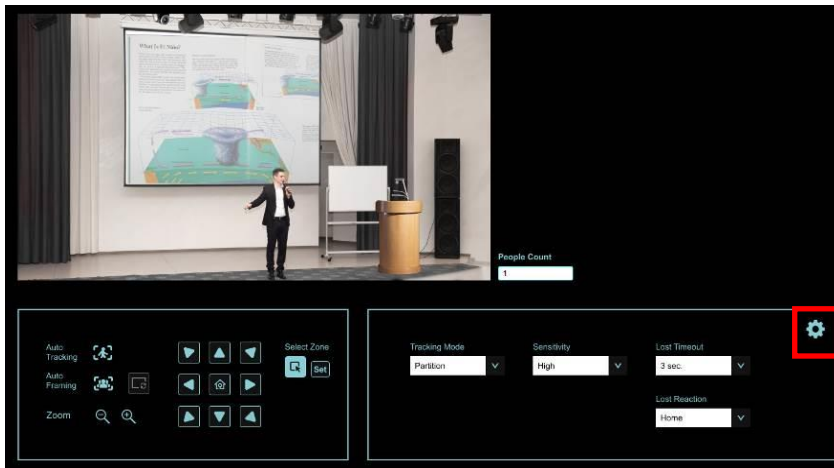

2. Use PTZ function to adjust to the screen to be partitioned, and then click to save. The partition icon below will be changed to the saved position

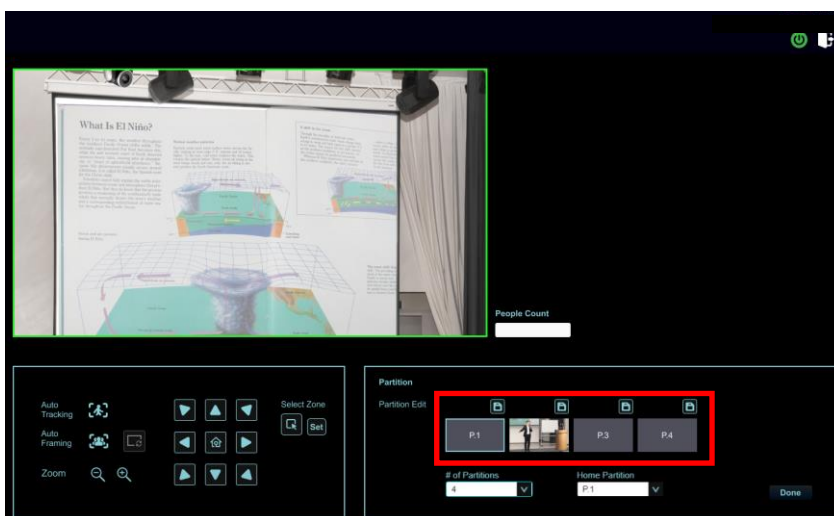

3. If you need to set other partitions, please continue using PTZ function to adjust the screen, and then click  to save

<Remark> If a red box is displayed when adjusting the screen, it means that the position overlaps with that of other partitions. Please adjust the screen again and save it when a green box is displayed

<Remark> Overlapping partition positions may cause abnormal tracking behavior

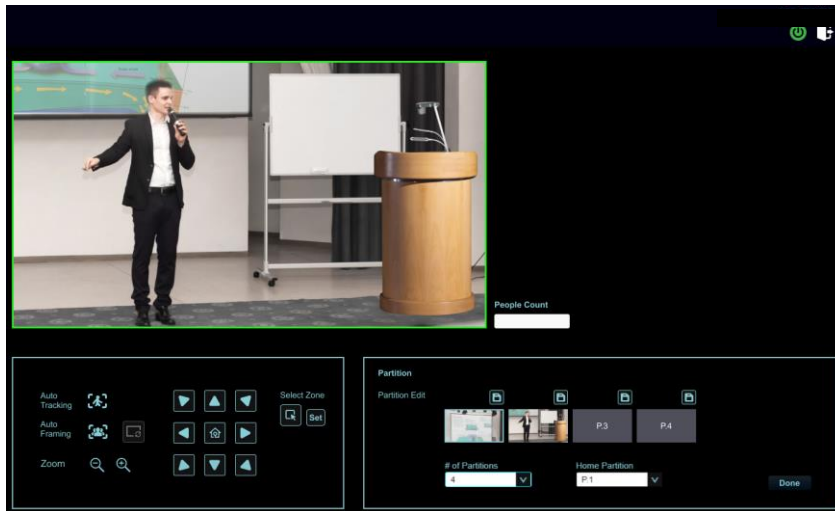

4. Click  to enable the Partition feature

### 5.2.5 Audio

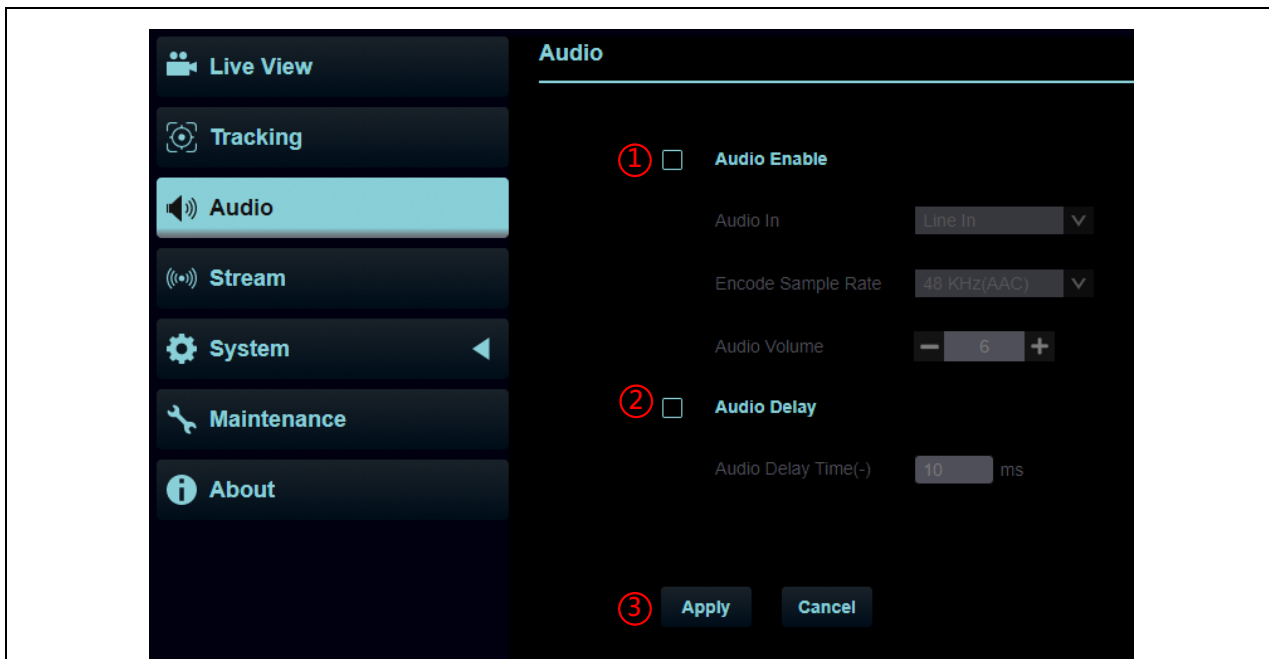

No	Item	Function Descriptions
1	Audio Enable	Select to enable Audio function <ul style="list-style-type: none"> <li>■ Audio In: Line In</li> <li>■ Encode Type: AAC</li> <li>■ Encode sample rate: Encode type and sample rate (48KHz)</li> <li>■ Audio Volume: Adjust Audio Volume</li> </ul>
2	Audio Delay	After checking the box, set the audio delay time (-10 ~ -500 ms)
3	Apply/Cancel	Apply/Cancel Audio Setting

## 5.2.6 Streaming

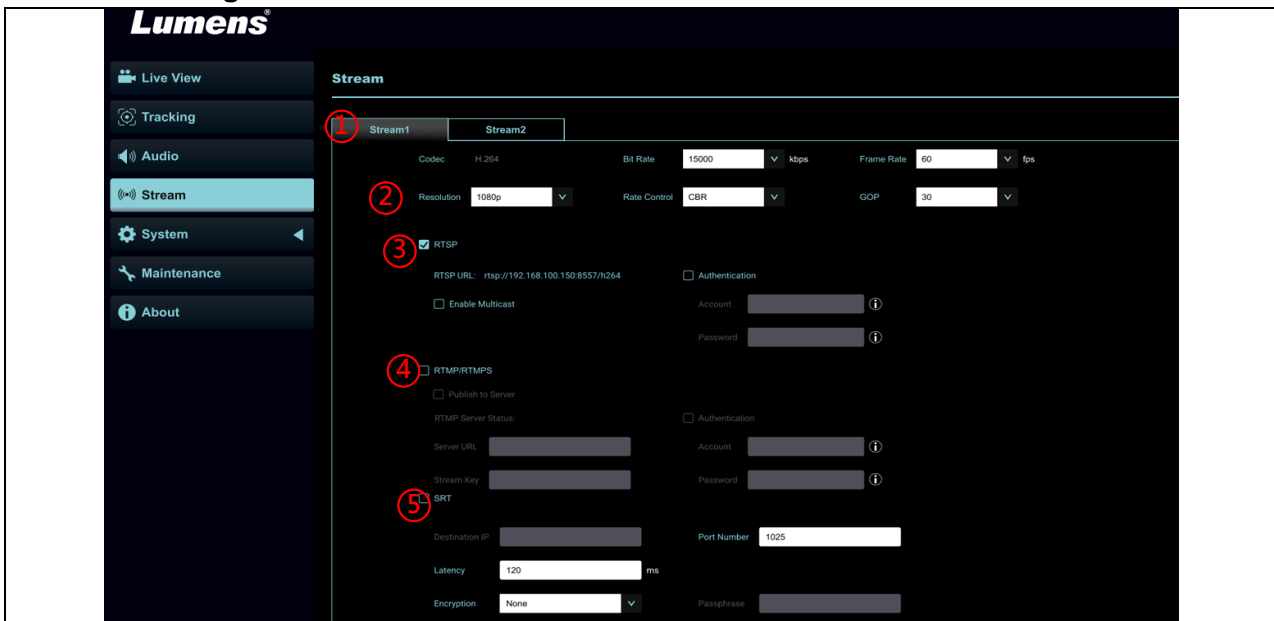

No	Item	Function Descriptions
1	Streaming 1/ Streaming 2	Supporting 2-way streaming output
2	Streaming parameter setting	Please refer to <a href="#">5.2.6.1 Streaming Parameter Setting</a> for relevant settings
3	RTSP	<p>Select to enable RTSP</p> <ul style="list-style-type: none"> <li>■ Enable/Disable Multicast It is suggested to enable Multicast when the number of users online watching the live image simultaneously is more than 4</li> <li>■ Enable/Disable Username/Password Authentication <ul style="list-style-type: none"> <li>➢ RTSP connection format can be found in <a href="#">5.1.3 Using RTSP Player to View the Images</a></li> <li>➢ The username/password is the same as the web login password of the camera, please refer to <a href="#">5.2.10 System Settings - User</a> to add/modify account information</li> </ul> </li> </ul>
4	RTMP/RTMPS	<p>Copy the RTMP web address provided by the RTMP service platform and paste it to the RTMP connection address to publish the camera images on the RTMP service platform</p> <p>To upload to YouTube for live streaming, please refer to <a href="#">5.2.5 Audio</a> to turn on the audio function</p>
5	SRT	<ul style="list-style-type: none"> <li>■ Check to enable and set SRT streaming After the SRT streaming is opened, it will be connected automatically upon startup</li> <li>■ The port number must be set in the range above 1024 with a maximum value of 9999 <b>&lt;Remark&gt;</b> The following ports are used by the camera. Setting of the port may not connect correctly 8554, 8556, 8557, 8080, 9090, 1935</li> <li>■ Delay time is for 20 to 8,000 microseconds. The default value is 120 microseconds</li> </ul>

### 5.2.6.1 Streaming parameter setting

Function	Streaming 1	Streaming 2
Encode Format	HEVC / H.264	H.264
Resolution	2160 / 1080p / 720p	720p / 480p / 360p
Bit rate	Range	2,000~20,000
	Factory Default	15,000
Rate Control	CBR / VBR	
Frame Rate	Setting according to the supported resolution	
Group of Pictures	Setting according to the supported resolution	

## 5.2.7 System - Device

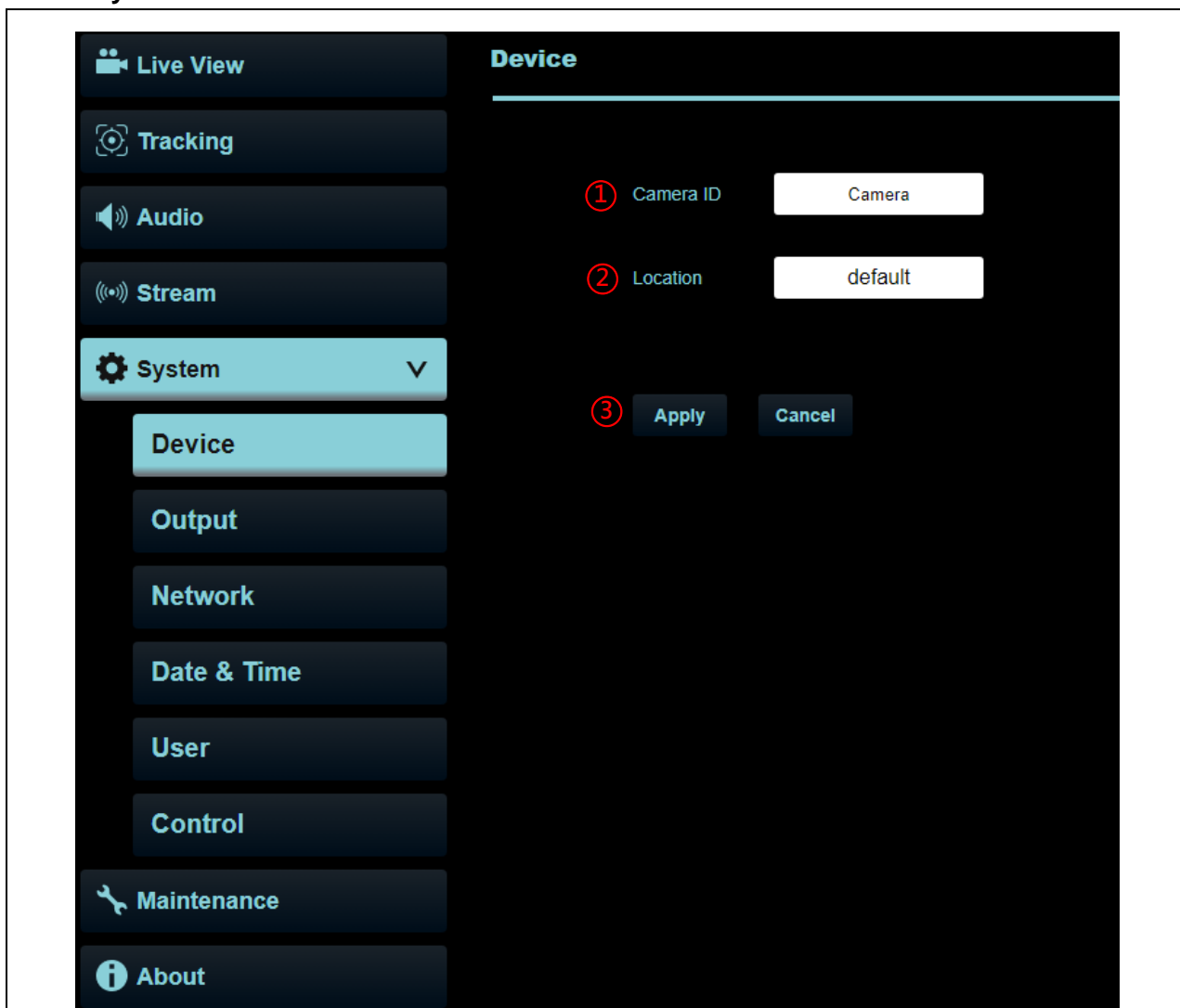

No	Item	Function Descriptions
1	Camera ID	<p>Change camera ID here</p> <ul style="list-style-type: none"> <li>■ Supporting 1 - 15 characters for the camera ID</li> <li>■ Please mix uppercase and lowercase letters or numbers for characters. Special symbols such as “/” and “space” cannot be used</li> </ul> <p>&lt;Remark&gt; Modifying this field will modify the Onvif device name synchronously</p>
2	Camera Location	<p>Modify the location of the camera, such as Room 1</p> <ul style="list-style-type: none"> <li>■ Supporting 1 - 30 characters for the camera location</li> <li>■ Please mix uppercase and lowercase letters or numbers for characters. Special symbols such as “/” and “space” cannot be used</li> </ul> <p>&lt;Remark&gt; Modifying this field will modify the Onvif device location synchronously</p>
3	Apply/Cancel	Apply/Cancel Setting

## 5.2.8 System - Output

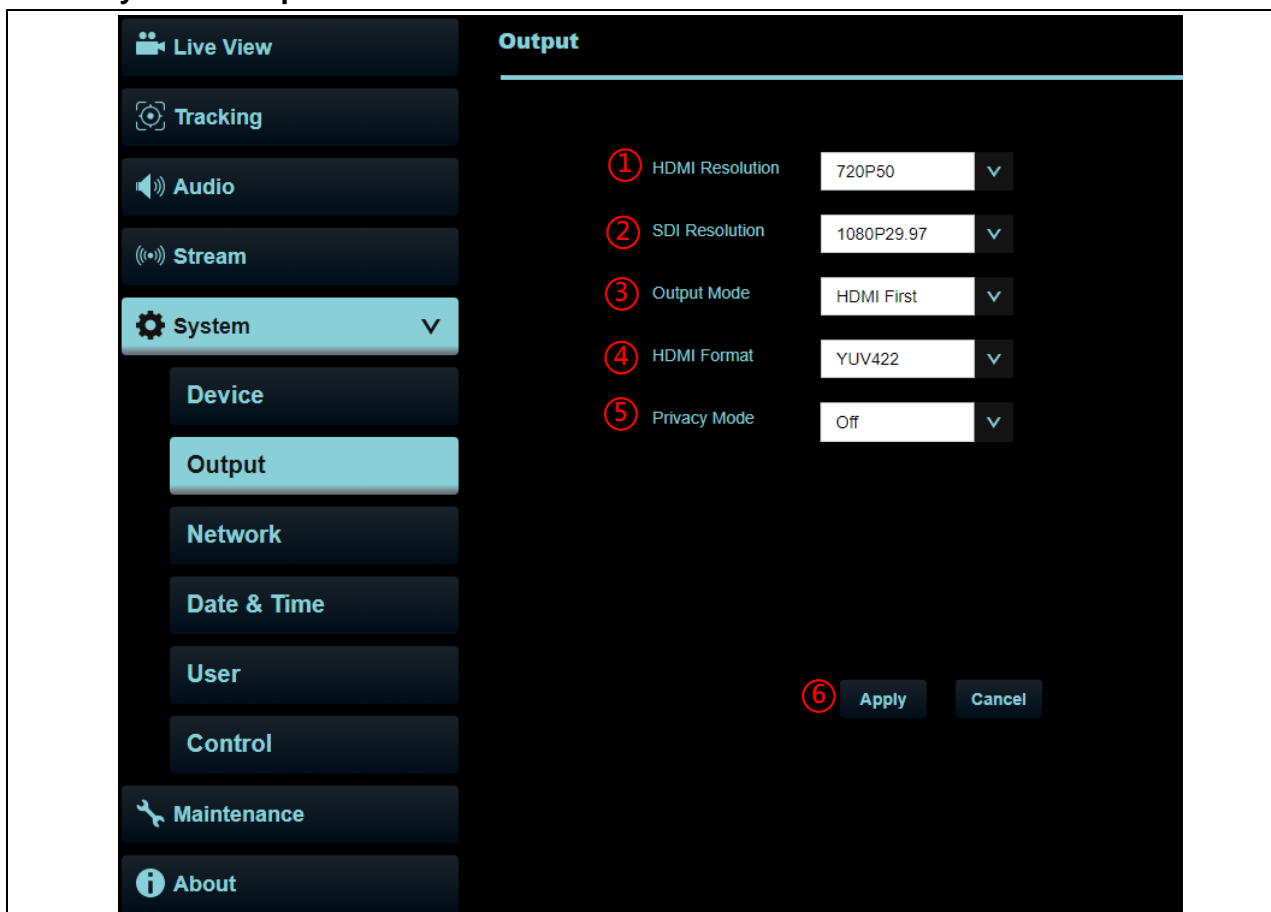

No	Item	Function Descriptions
1	HDMI Resolution	Set the HDMI output resolution After switching the resolution, the camera will restart. Please refresh the browser
2	SDI Resolution	Set the SDI output resolution After switching the resolution, the camera will restart. Please refresh the browser
3	Output Mode	Set HDMI First or UVC First HDMI First: HDMI Output 1080P@60, UVC Up to 1080P@30 UVC First: UVC Output 1080P@60, HDMI Up to 1080P@30
4	HDMI format	Select YUV422/RGB
5	Privacy Mode (UVC)	On/ Off Privacy Mode After the function is enabled, when the camera is turned off via the remote control or software, the lens will automatically turn to the bottom right to ensure the user's privacy
	Dante AV-H	<Remark> Applicable to VC-TR60, Dante AV-H only Turn on/ off Dante AV-H
6	Apply/Cancel	Apply/Cancel Setting

## 5.2.9 System - Network

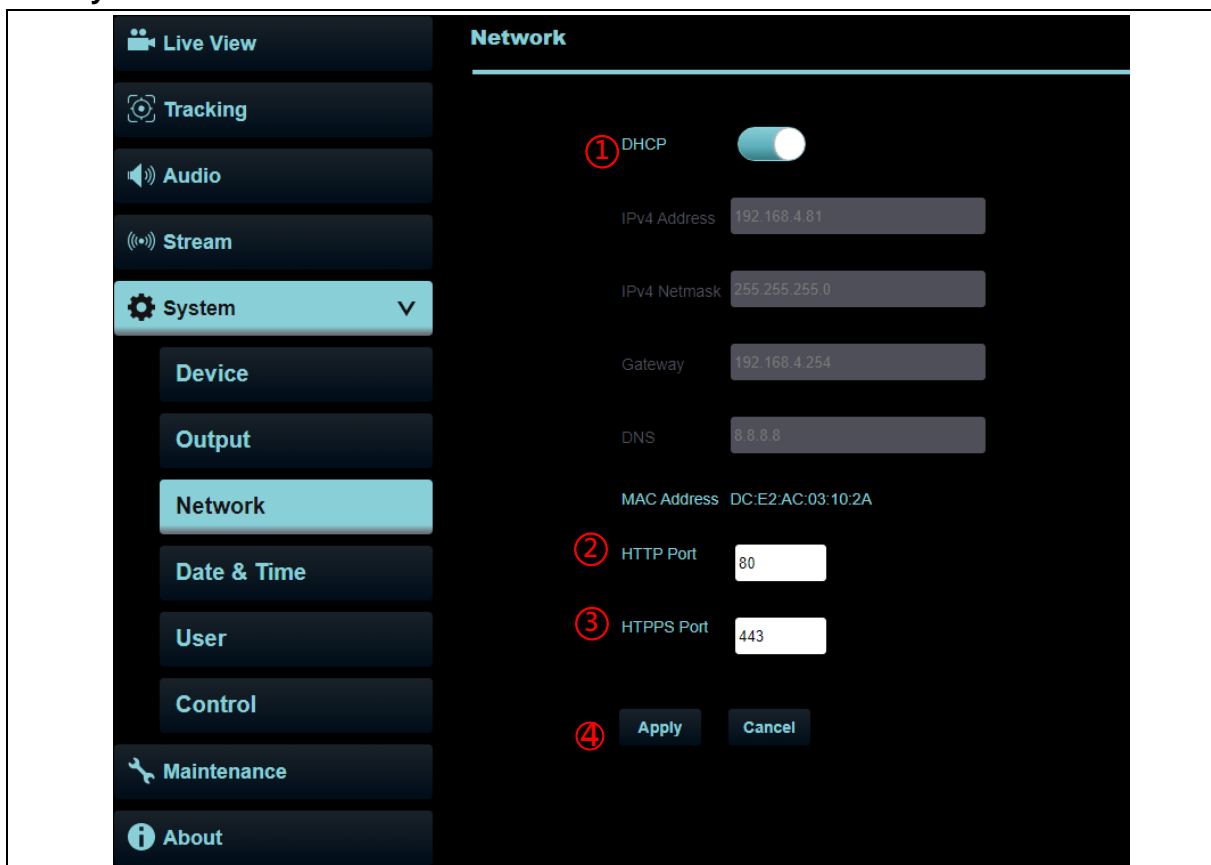

No	Item	Function Descriptions
1	DHCP	Network setting of camera. Change of setting is available when DHCP function is closed
2	HTTP port	Set HTTP port. The default Port value is 80
3	HTTPS port	Set HTTPS port. The default Port value is 81
4	Apply/Cancel	Apply/Cancel Setting

## 5.2.10 System - Date & Time

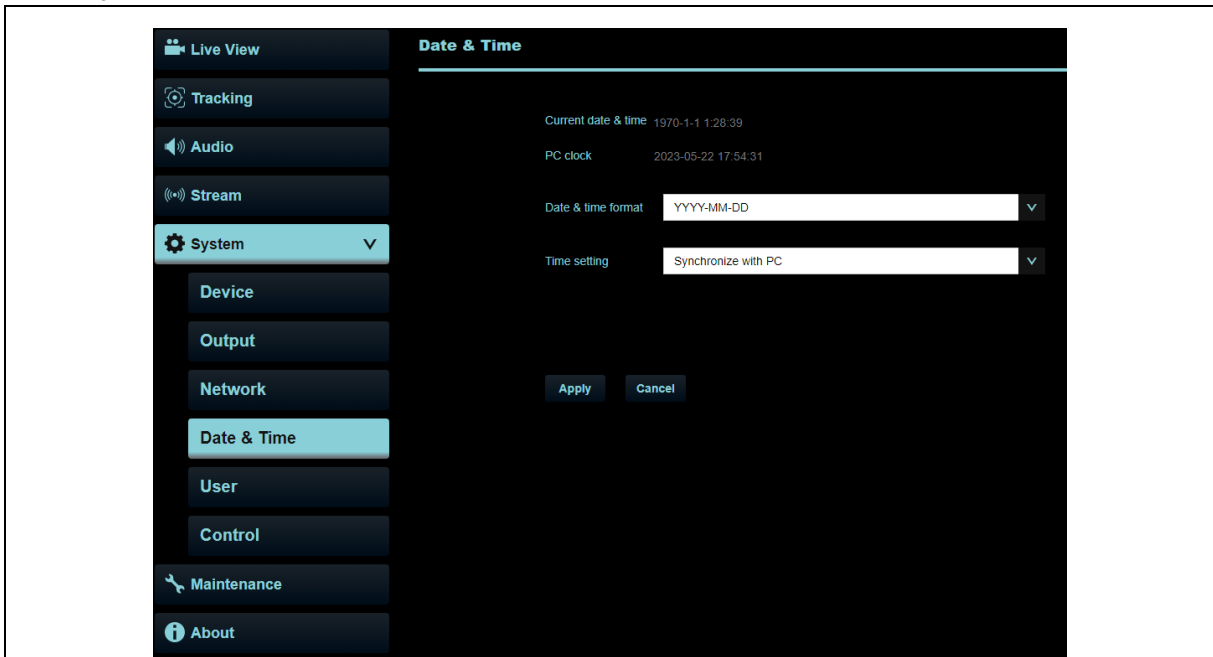

### Function Descriptions

Display the current camera/PC date and time, and set the display format and synchronization way  
When Manually Set is selected for [Time Settings], Date & Time can be customized



## 5.2.11 System - User

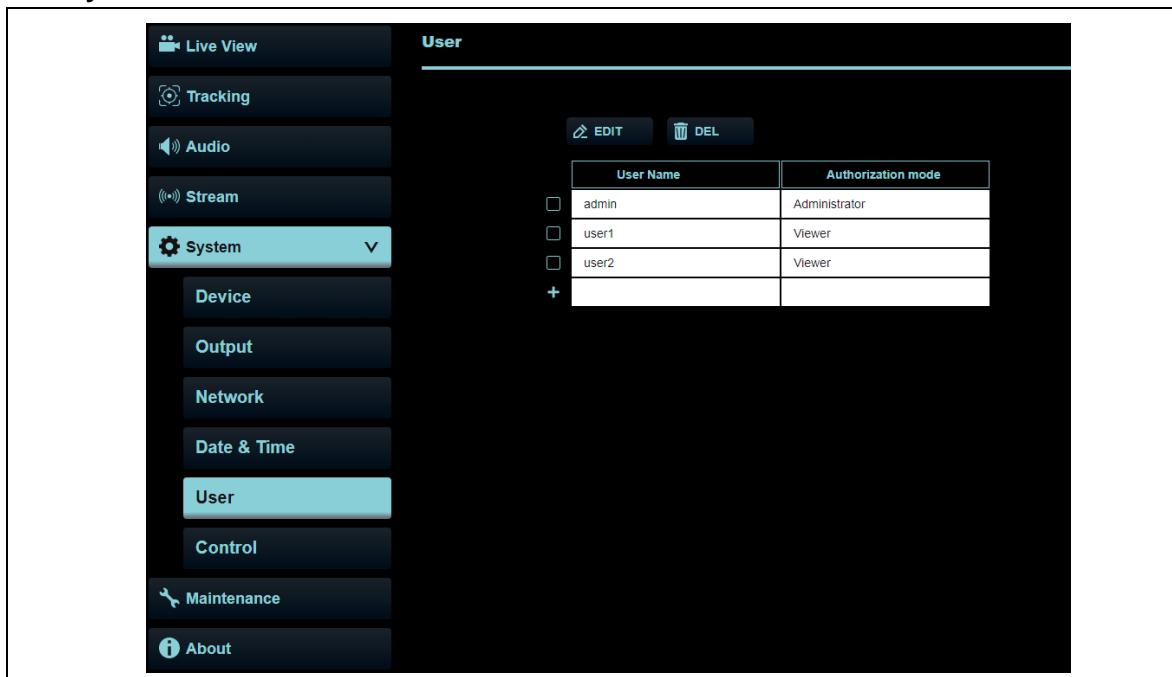

### Function Descriptions

Add/Modify/Delete user account

- Supporting 4 - 32 characters for user name and password
- Please mix uppercase and lowercase letters or numbers for characters. Special symbols or the underlined cannot be used
- Authentication Mode: Set the new account management permissions

User Type	Admin	Operator	Viewer
View images	V	V	V
Settings	V	V	X
Account management	V	X	X

※When Factory Reset is executed, it will clear the user's data

## 5.2.12 System - Control

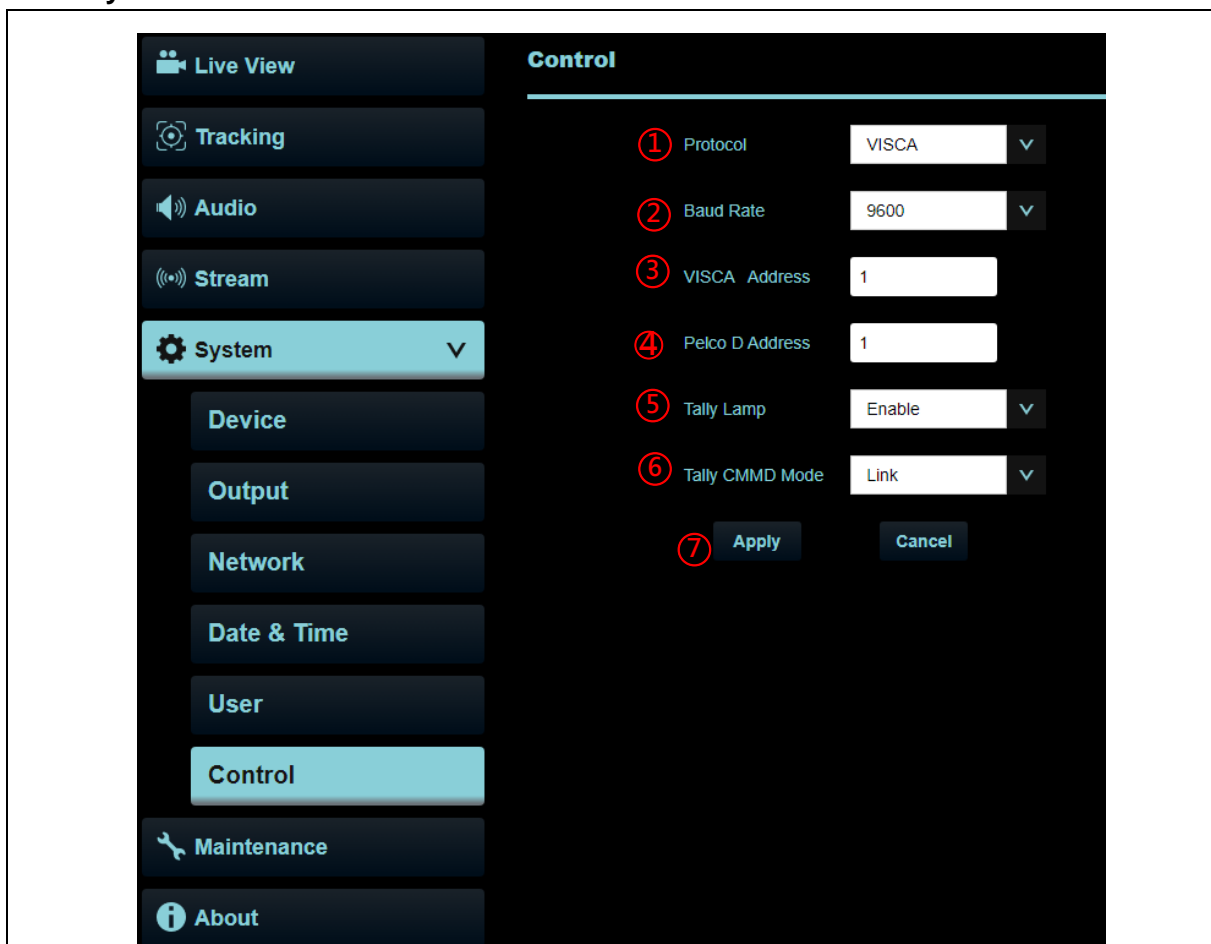

No	Item	Function Descriptions
1	Protocol	VISCA protocol is supported
2	Baud Rate	Choose the transmission speed of the control signal as 9600/38400
3	VISCA address	The camera ID address 0 ~ 7 can be assigned
4	Tally Lamp	Enable/Disable Tally Lamp
5	Tally CMMD Mode	<p>Set whether the indicator light is linked with RS232 command</p> <ul style="list-style-type: none"> <li>➤ General (Not linked): The indicator light switch and mode shall be set separately. <ul style="list-style-type: none"> <li>-When the indicator light is on and the default mode is off, additional command is required to set the indicator light mode</li> <li>-Setting the indicator light mode when the indicator light is off will not trigger the indicator light</li> </ul> </li> <li>➤ Link: <ul style="list-style-type: none"> <li>-When the indicator light is on, the default mode is red light</li> <li>-Setting the indicator light mode when the indicator light is off will turn on the indicator light</li> </ul> </li> </ul>
6	Apply/Cancel	Apply/Cancel Setting

### 5.2.13 Maintenance

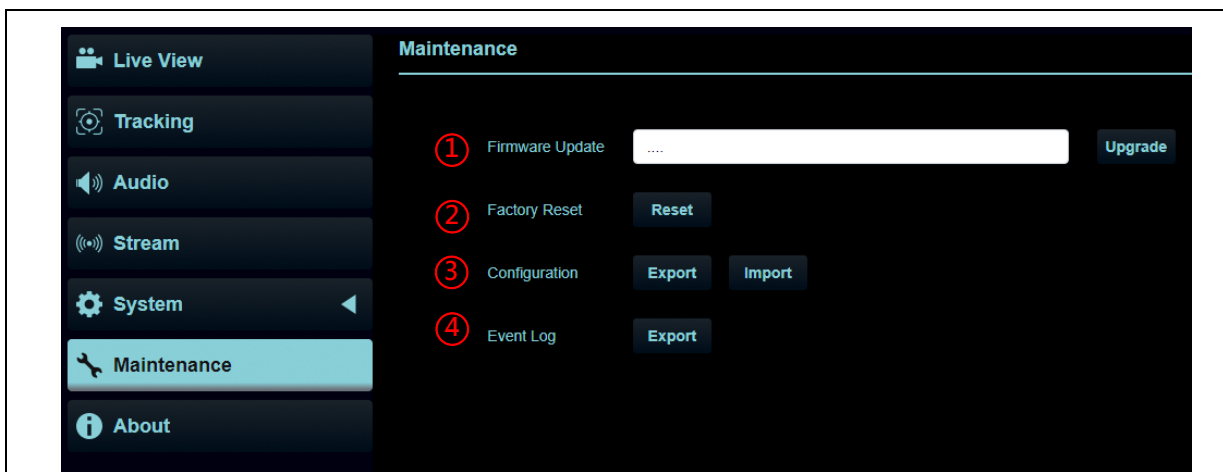

No	Item	Function Descriptions
1	Firmware Update	Select the firmware file, and click [Upgrade] to update the firmware <b>&lt;Remark&gt;</b> Update takes about 2 - 3 minutes <b>&lt;Remark&gt;</b> Please do not operate or turn off the power of the device during the update to avoid firmware update failure
2	Factory Reset	Reset all configurations to factory default settings
3	System Settings	Save setup parameters as a Profile, and users can download and upload camera setup parameters
4	Error Log	If the camera operates abnormally, please export error log and provide it to Lumens for confirmation

## 5.2.14 About



### Function Descriptions

Display the firmware version, serial number, and other related information of the camera

For technical support, please scan the QRcode at the bottom right for assistance

## Chapter 6 Troubleshooting

This chapter describes problems you may encounter while using VC-TR60. If you have questions, please refer to related chapters and follow all the suggested solutions. If the problem still occurred, please contact your distributors or the service center.

No.	Problems	Solutions
1.	<b>Boot without power signal</b>	<ol style="list-style-type: none"> <li>1. Make sure you have plugged in the power cord.</li> <li>2. When using a PoE connection, ensure that the power supply supports PoE (IEEE802.3at) hubs</li> </ol>
2.	<b>There is no image output from camera</b>	<ol style="list-style-type: none"> <li>1. Check the power supply or PoE supply functions.</li> <li>2. Confirm the output signals are in streaming output.</li> <li>3. Confirm whether the camera resolution can be used together with the monitor equipment</li> <li>4. Replace the cables and make sure they are not faulty.</li> </ol>
3.	<b>Camera image is severely delayed</b>	Please use 1080p or 720p 60/50 fps rather than 25/30 fps signals
4.	<b>RS-232 cannot be controlled</b>	<ol style="list-style-type: none"> <li>1. Confirm the connection is correct (RS-232 In/ Out)</li> <li>2. Please make sure the VISCA setting is the same as the control equipment</li> </ol>
5.	<b>Whether the Internet can be used for operation</b>	Please refer to <a href="#">Chapter 5 Network Function Setting Description</a> for the Internet usage
6.	<b>The ONVIF software cannot find the machine</b>	Please make sure that [System] > [Device] > [Camera ID] / [Camera Location] on the web page uses only English letters or numbers. The ONVIF software cannot find the machine if you use special characters and the space
7.	<b>The camera does not save the relevant parameters (PTZ, AWB...) after reboot</b>	<p>Please make sure if the Initial Position is set to Last Operated Position from the setting menu or web page</p> <p>Setting Menu: [System] &gt; [Initial Position]</p> <p>Web page: [Live Viewer] &gt; [Camera Setting  </p>
8.	<b>How to log in the portal when you forget your account password</b>	Please contact your Lumens distributor or service center

# Chapter 7 Safety Instructions

Always follow these safety instructions when setting up and using VC-TR60:

## 1 Operation

- 1.1 Please use the product in the recommended operating environment, away from water or source of heat.
- 1.2 Do not place the product on a tilted or unstable trolley, stand or table.
- 1.3 Please clean the dust on the power plug prior to usage. Do not insert the product's power plug into a multiplug to prevent sparks or a fire.
- 1.4 Do not block the slots and openings in the case of the product. They provide ventilation and prevent the product from overheating.
- 1.5 Do not open or remove covers, otherwise it may expose you to dangerous voltages and other hazards. Refer all servicing to licensed service personnel.
- 1.6 Unplug the product from the wall outlet and refer servicing to licensed service personnel when the following situations happen:
  - If the USB port becomes damaged or frayed.
  - If liquid is spilled into the product or the product has been exposed to rain or water.

## 2 Installation

- 2.1 For security considerations, please make sure the standard mount you use is in line with UL or CE safety approvals and installed by technician personnel approved by agents.

## 3 Storage

- 3.1 Do not place the product where the cord can be stepped on as this may result in fraying or damage to the lead or the plug.
- 3.2 Unplug this product during thunderstorms or if it is not going to be used for an extended period.
- 3.3 Do not place this product or accessories on top of vibrating equipment or heated objects.

## 4 Cleaning

- 4.1 Disconnect all the cables prior to cleaning and wipe the surface with a dry cloth. Do not use alcohol or volatile solvents for cleaning.

## 5 Batteries (for products or accessories with batteries)

- 5.1 When replacing batteries, please only use similar or the same type of batteries.
- 5.2 When disposing of batteries or products, please adhere to the relevant instructions in your country or region for disposing of batteries or products.

## ■ Precautions



This symbol indicates that this equipment may contain dangerous voltage which could cause electric shock. Do not remove the cover (or back). No user-serviceable parts inside. Refer servicing to licensed service personnel.



This symbol indicates that there are important operating and maintenance instructions in this User Manual with this unit.

## ■ FCC Warning

This equipment has been tested and found to comply with the limits for a Class A digital device, pursuant to part 15 of the FCC Rules. These limits are designed to provide reasonable protection against harmful interference when the equipment is operated in a commercial environment.

Notice :

The changes or modifications not expressly approved by the party responsible for compliance could void the user's authority to operate the equipment..

This equipment has been tested and found to comply with the limits for a Class A digital device, pursuant to part 15 of the FCC Rules. These limits are designed to provide reasonable protection against harmful interference when the equipment is operated in a commercial environment.

## ■ IC Warning

This digital apparatus does not exceed the Class A limits for radio noise emissions from digital apparatus as set out in the interference-causing equipment standard entitled "Digital Apparatus," ICES-003 of Industry Canada.

Cet appareil numérique respecte les limites de bruits radioélectriques applicables aux appareils numériques de Classe A prescrites dans la norme sur le matériel brouilleur: "Appareils Numériques," NMB-003 édictée par l'Industrie.

## ■ EN55032 CE Warning

Operation of this equipment in a residential environment could cause radio interference.

Warning: Operation of this equipment in a residential environment may cause radio interference.

# Copyright Information

---

Copyrights © Lumens Digital Optics Inc. All rights reserved.

Lumens is a trademark that is currently being registered by Lumens Digital Optics Inc.

Copying, reproducing or transmitting this file is not allowed if a license is not provided by Lumens Digital Optics Inc. unless copying this file is for the purpose of backup after purchasing this product.

In order to keep improving the product, the information in this file is subject to change without prior notice.

To fully explain or describe how this product should be used, this manual may refer to names of other products or companies without any intention of infringement.

Disclaimer of warranties: Lumens Digital Optics Inc. is neither responsible for any possible technological, editorial errors or omissions, nor responsible for any incidental or related damages arising from providing this file, using, or operating this product.