

Hisense

3.1.2CH Soundbar with Wireless Subwoofer
Model: AX3120G



- ✓ Simple setup
- ✓ One remote
- ✓ Quick settings

360W
Max Audio Power

 **Dolby Atmos**



HDMI™
HIGH-DEFINITION MULTIMEDIA INTERFACE

 **Bluetooth®**  

USER MANUAL



Before using the soundbar, please read this manual thoroughly and retain it for future reference.

Contents

1. Important Safety Instructions	3
1.1 Safety.....	3
1.2 Warning.....	4
1.3 Supported Input Audio Formats.....	6
2. What's in the Box	7
3. Identifying the Parts	8
3.1 Main Unit	8
3.2 Wireless Subwoofer.....	8
3.3 Remote Control	9
4. Preparations	10
4.1 Prepare the Remote Control	10
4.2 Replace the Remote Control Battery	10
4.3 Placement and Mounting.....	10
4.4 Mounting the Soundbar on the Wall.....	11
5. Connections	12
5.1 Dolby Atmos®.....	12
5.2 DTS: X	12
5.3 Use the HDMI Socket	12
5.4 Use the OPTICAL Socket	12
5.5 Connect to AUX Socket	13
5.6 Connect Power	13
5.7 Pair up with the Subwoofer	14
6. Basic Operation	14
6.1 Standby/On	14
6.2 Auto-Standby / Auto-Wake Feature	14
6.3 Select Modes	15
6.4 Adjust the Bass/Treble Level.....	15
6.5 Turn the Surround Sound ON/OFF.....	15
6.6 Adjust the Soundbar's Volume	15
6.7 Adjust the Brightness	15
6.8 Select Equalizer (EQ) Effect	15
6.9 Set the Audio Delay (AV SYNC)	15
7. DTS: X Operation	16
7.1 DRC / Dialog Control / Neural:X / Virtual:X Features.....	16
8. HDMI eARC/HDMI ARC, HDMI IN, OPTICAL, AUX Operation	16
9. Bluetooth Operation	17
9.1 Pair Bluetooth-enabled Devices.....	17
9.2 Listen to Music from Bluetooth Device.....	17
10. USB Operation	18
11. Setup Menu	19
12. Troubleshooting	19
13. Specifications	21

1. Important Safety Instructions



The lightning flash with arrowhead symbol, within an equilateral triangle, is intended to alert the user to the presence of uninsulated “dangerous voltage” within the product’s enclosure that may be of sufficient magnitude as to constitute a risk of electric shock to persons.



The exclamation point within an equilateral triangle is intended to alert the user to the presence of important operating and maintenance (servicing) instructions in the literature accompanying the appliance.

1.1 Safety

- 1 Read these instructions** – All the safety and operating instructions should be read before this unit is operated.
- 2 Keep these instructions** – The safety and operating instructions should be retained for future reference.
- 3 Heed all warnings** – All warnings on the appliance and in the operating instructions should be adhered to.
- 4 Follow all instructions** – All operating and usage instructions should be followed.
- 5 Do not use this unit near water** – The appliance should not be used near water or moisture – for example, in a wet basement or near a swimming pool or similar location.
- 6 Clean only with a dry cloth.**
- 7 Do not block any ventilation openings.** Install in accordance with the manufacturer’s instructions.
- Do not install near any heat sources such as radiators, heaters, stoves, or other apparatus (including amplifiers) that produce heat.
- The unit is supplied with a standard mains lead and moulded plug which for safety reason must not be modified. If the provided plug does not fit into your wall socket, consult an electrician for replacement of the obsolete mains socket.
- Protect the power cord from being walked on or pinched particularly at plugs, convenience receptacles, and the point where they exit from the apparatus.
- Only use attachments/accessories specified by the manufacturer.
-  Use only with the cart, stand, tripod, bracket or table specified by the manufacturer, or sold with the unit. When a cart or rack is used, use caution when moving the cart/unit combination to avoid injury from tip-over.
- Unplug the unit during lightning storms or when unused for long periods of time.
- Refer all servicing to qualified personnel. Servicing is required when the unit has been damaged in any way, such as power supply cord or plug is damaged, liquid has been spilled or objects have fallen into the unit, the unit has been exposed to rain or moisture, does not operate normally, or has been dropped.
- This equipment is a Class II or double insulated electrical appliance. It has been designed in such a way that it does not require a safety connection to electrical earth.
- Do not place liquid filled objects such as vases on the unit.
- Minimum distance around the unit for sufficient ventilation is 5cm.
- The ventilation should not be impeded by covering the ventilation openings with items, such as newspapers, table-cloths, curtains, etc.
- No naked flame sources, such as lighted candles, should be placed on the unit.
- Batteries should be recycled or disposed of as per state and local guidelines.
- The unit can be used in moderate or tropical climates.

Caution:

- Use of controls or adjustments or performance of procedures other than those described herein, may result in hazardous radiation exposure or other unsafe operation.
- To reduce the risk of fire or electric shock, do not expose this unit to rain or moisture. The unit must not be exposed to dripping or splashing and objects filled with liquids, such as vases, must not be placed on unit.
- The mains plug/appliance coupler is used as the disconnect device, the disconnect device must remain readily operable.
- Danger of explosion if battery is incorrectly replaced. Replace only with the same or equivalent type.
- Install all batteries correctly, + and - as marked on the apparatus.
- Do not mix old and new batteries.
- Do not mix alkaline, standard (Carbon-Zinc) or rechargeable (Ni-Cd, Ni-MH, etc.) batteries.
- Remove batteries when the unit is not used for a long time.

1.2 Warning

- The battery (batteries or battery pack) shall not be exposed to excessive heat such fires, or other direct heat sources.
- Before operating this unit, check the voltage of this unit to see if it is identical to the voltage of your local power supply.
- Do not place this unit close to strong magnetic fields.
- Do not place this unit on the amplifier or receiver.
- If any solid object or liquid falls into the system, unplug the system and have it checked by qualified personnel before operating it any further.
- Do not attempt to clean the unit with chemical solvents as this may damage the finish. Use a clean, dry or slightly damp cloth.
- When removing the power plug from the wall outlet, always pull directly on the plug, never yank on the cord.
- Changes or modifications to this unit not expressly approved by the party responsible for compliance will void the user's authority to operate the equipment.
- The rating label is pasted on the bottom or back of the equipment.
- This equipment should be installed and operated with minimum distance 20cm between the radiator&your body.



Battery usage CAUTION

To prevent battery leakage which may result in bodily injury, property damage, or damage to the apparatus:



Correct Disposal of this product. This marking indicates that this product should not be disposed with other household wastes throughout the EU.

To prevent possible harm to the environment or human health from uncontrolled waste disposal, recycle it responsibly to promote the sustainable reuse of material resources. To return your used device, please use the return and collection systems or contact the retailer where the product was purchased. They can take this product for environmental safe recycling.



We hereby declares that this product is in compliance with the essential requirements and other relevant provisions of Directive 2014/53/EU.



The Bluetooth® word mark and logos are registered trademarks owned by Bluetooth SIG, Inc. and any use of such marks by Hisense is under license. Other trademarks and trade names are those of their respective owners.



The terms HDMI and HDMI High-Definition Multimedia Interface, and the HDMI Logo are trademarks or registered trademarks of HDMI Licensing Administrator, Inc.



Dolby, Dolby Atmos, and the double-D symbol are registered trademarks of Dolby Laboratories Licensing Corporation. Manufactured under license from Dolby Laboratories. Confidential unpublished works. Copyright © 2012-2021 Dolby Laboratories. All rights reserved.





- ✓ Simple setup
- ✓ One remote
- ✓ Quick settings

Roku, the Roku logo, Roku TV, Roku TV Ready, and the Roku TV Ready logo are trademarks and/or registered trademarks of Roku, Inc. This product is Roku TV Ready-supported in the United States, United Kingdom, Mexico and Canada. Countries are subject to change. For the most current list of countries in which this product is Roku TV Ready-supported, please email rokutvready@roku.com.



For DTS patents, see <http://patents.dts.com>. Manufactured under license from DTS, Inc. or DTS Licensing Limited. DTS, DTS:X, Virtual:X, and the DTS:X logo are registered trademarks or trademarks of DTS, Inc. in the United States and other countries. © 2021 DTS, Inc. ALL RIGHTS RESERVED.

1.3 Supported Input Audio Formats

Format	Function			
	OPTICAL	HDMI ARC	HDMI eARC	HDMI IN
LPCM 2ch	●	●	●	●
LPCM 5.1ch	--	--	●	●
LPCM 7.1ch	--	--	●	●
Dolby Atmos - Dolby TrueHD	--	--	●	●
Dolby Atmos - Dolby Digital Plus	--	●	●	●
Dolby TrueHD	--	--	●	●
Dolby Digital Plus	--	●	●	●
Dolby Digital	●	●	●	●
DTS	●	●	●	●
DTS-ES Discrete 6.1	●	●	●	●
DTS-ES Matrix 6.1	●	●	●	●
DTS 96/24	●	●	●	●
DTS-HD High Resolution Audio	--	--	●	●
DTS-HD Master Audio	--	--	●	●
DTS-HD LBR	--	--	●	●
DTS:X	--	--	●	●

● : Supported format.

-- : Unsupported format.

2. What's in the Box



Main Unit

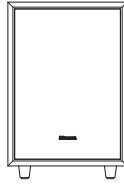

Wireless Subwoofer



AC Power Cord x 2

For Main Unit / Wireless Subwoofer

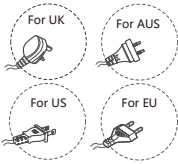

* Plug type varies by region

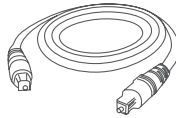

Optical Cable



HDMI Cable

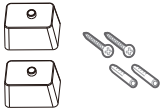

Brackets (x2) /Bracket Screw (x2)
/ Wall Anchors (x2)

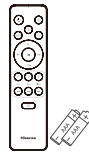

Remote Control /
AAA Batteries x 2

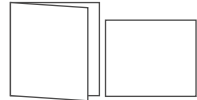

User Manual /
Quick Start Guide

- * Power cord quantity and plug type vary by regions.
- Images, illustrations and drawings shown on this User Manual are for reference only. Actual product may vary in appearance.
- Design and specifications are subject to change without notice.

3. Identifying the Parts

3.1 Main Unit

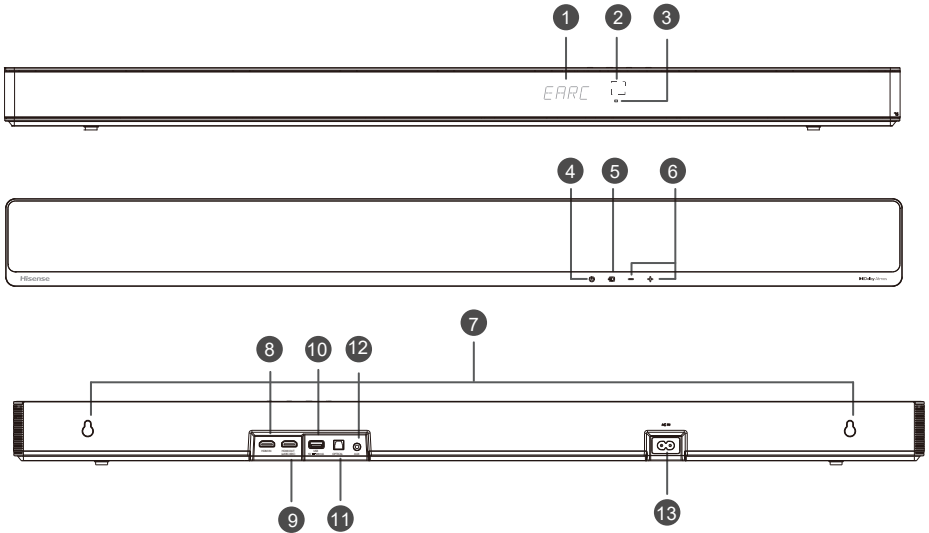

- | | | | |
|--|---|-----------------|---|
| ① Display Window
Show the current status. | ⑧ HDMI IN Socket
For connecting HDMI source devices, such as a DVD player, Blu-ray Disc™ player, or gaming console. | | |
| ② Remote Control Sensor
Receive signal from the remote control. | ⑨ HDMI OUT (TV eARC/ARC) Socket
The port for connecting a TV. The port supports the eARC/ARC HDMI feature, which allows the soundbar to play audio that originates on the connected TV. | | |
| ③ Red Standby Indicator | ⑩ USB Socket
Insert the USB device to play music. | | |
| <table border="1"> <tr> <td>• Constant on</td> <td>In Standby mode</td> </tr> </table> | • Constant on | In Standby mode | ⑪ OPTICAL Socket
Connect to the OPTICAL OUT socket on an external device. |
| • Constant on | In Standby mode | | |
| ④ ⏻ (ON/OFF) Button
Switch the unit between ON and STANDBY mode. | ⑫ AUX Socket
Connect to an external audio device. | | |
| ⑤ ↔ (SOURCE) Button
Select the play mode. | ⑬ AC IN Socket
Connect to the power supply. | | |
| ⑥ +/- (VOL+/VOL-) Button
Increase/decrease the volume level. | | | |
| ⑦ Wall Mount
Install the wall mounting screws into the wall mount of the unit. | | | |

3.2 Wireless Subwoofer

① Indicator

• Fast blink	The subwoofer in pairing mode
• Constant on	Connected / Paired successfully
• Slow blink	Connection / Pairing failed

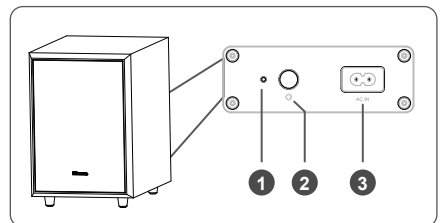









② PAIR Button

2 seconds	Clear the pairing record and enter to pairing mode
-----------	--

③ AC IN Socket

Connect to power supply.

3.3 Remote Control

- ①  Switch the unit between ON and STANDBY mode.
- ②  (SOURCE) Select the play mode.
- ③ **SURR** Adjust the surround ON/OFF.
- ④  (Bluetooth) Select the Bluetooth mode. Press and hold the  (Bluetooth) button to activate the pairing function in Bluetooth mode or disconnect the existing paired Bluetooth device.
- ⑤ **EQ** Select MOVIE/MUSIC/GAME/NEWS/SPORT/NIGHT/AI
- ⑥  /  Skip to previous/next track in Bluetooth / USB mode.
- ⑦ **VOL+ / VOL-** Increase/decrease the volume level.
- ⑧  Play/pause/resume playback in Bluetooth / USB mode. Press and hold the  button for 3s to enter setup menu. Confirm a selection.
- ⑨ **BASS+/-** Adjust bass level.
- ⑩ **TREBLE+/-** Adjust treble level.
- ⑪ **DIMMER+/-** Adjust display brightness.
- ⑫  (MUTE) Mute or resume the sound.

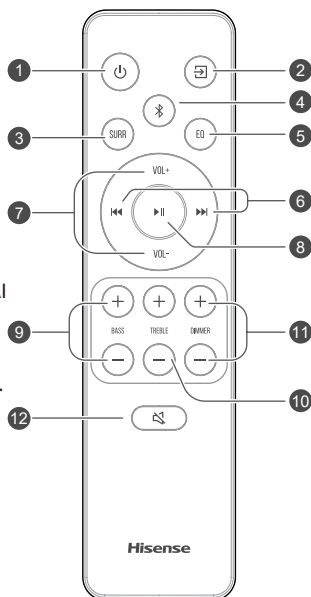

4. Preparations

4.1 Prepare the Remote Control

The provided Remote Control allows the unit to be operated from a distance.

- Even if the Remote Control is operated within the effective range 19.7 feet (6m), remote control operation may be disrupted if there are any obstacles between the unit and the remote control.
- If the Remote Control is operated near other products which generate infrared rays, or if other remote control devices using infrared rays are used near the unit, it may operate incorrectly. Conversely, the other products may operate incorrectly.

4.2 Replace the Remote Control Battery

- 1 Press and slide the back cover to open the battery compartment of the remote control.
- 2 Insert two **AAA** size batteries. Make sure the (+) and (-) ends of the batteries match the (+) and (-) ends indicated in the battery compartment.
- 3 Close the battery compartment cover.

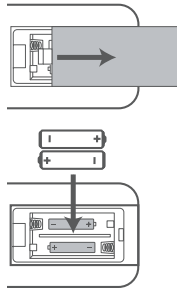

- Do not use any batteries other than those specified.
- Do not mix new batteries with old ones.
- Never recharge a battery unless it is confirmed to be a rechargeable type.

4.3 Placement and Mounting

Placement

- A If your TV is placed on a table, you can place the unit on the table directly in front of the TV stand, centered with the TV screen.
- B If your TV is attached to a wall, you can mount the unit on the wall directly below the TV screen.

Note: The unit should be placed to avoid covering the signal receiver of the TV or the remote of TV can not work.

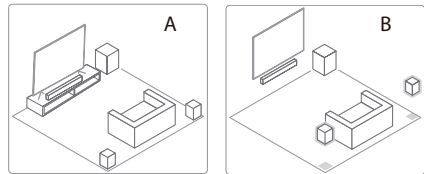

Precautions Concerning Batteries

- Be sure to insert the batteries with correct positive “ \oplus ” and negative “ \ominus ” polarities.
- Use batteries of the same type. Never use different types of batteries together.
- Either rechargeable or non-rechargeable batteries can be used. Refer to the precautions on their labels.
- Be aware of your fingernails when removing the battery cover and the battery.
- Do not drop the remote control.
- Do not allow anything to impact the remote control.
- Do not spill water or any liquid on the remote control.
- Do not place the remote control on a wet object.
- Do not place the remote control under direct sunlight or near sources of excessive heat.
- Remove the battery from the remote control when not in use for a long period of time, as corrosion or battery leakage may occur and result in physical injury, and/or property damage, and/or fire.

4.4 Mounting the Soundbar on the Wall

Note:

- Installation must be carried out by qualified personnel only. Incorrect assembly can result in severe personal injury and property damage (if you intend to install this product yourself, you must check for installations such as electrical wiring and plumbing that may be buried inside the wall). It is the installer's responsibility to verify that the wall will safely support the total load of the unit and wall brackets.
- Additional tools (not included) are required for the installation.
- Do not overtighten screws.
- Keep this instruction manual for future reference.
- Use an electronic stud finder to check the wall type before drilling and mounting.

WARNING

- To prevent injury, this unit must be securely attached to the floor/wall in accordance with the installation instructions.
- Suggested wall mounting height: ≤ 1.5 meters.

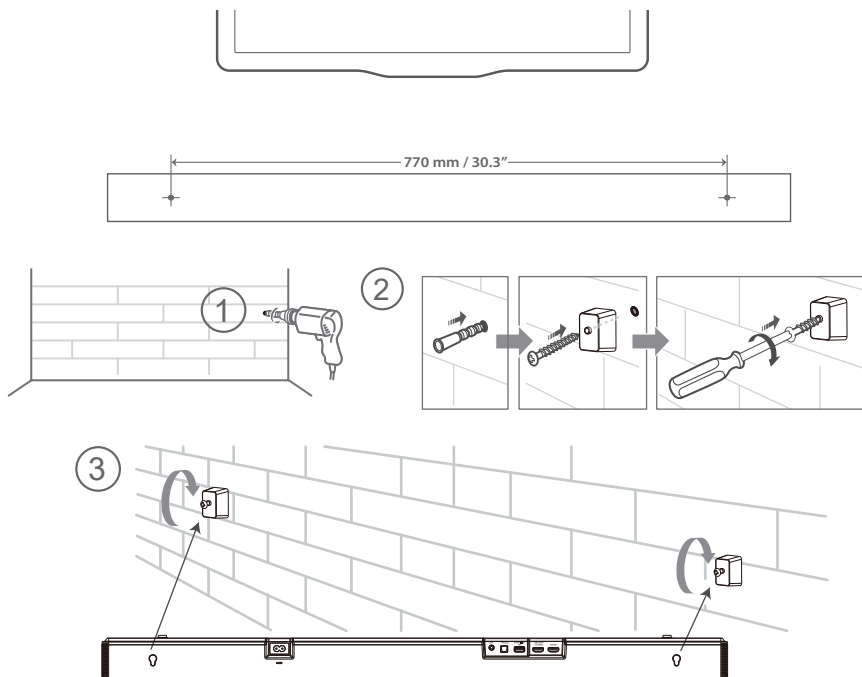

5. Connections

5.1 Dolby Atmos®

Dolby Atmos® gives you immersive listening experience by delivering sound in three dimensional space, and all the richness, clarity, and power of Dolby sound. For more information, please visit dolby.com/technologies/dolby-atmos

5.2 DTS: X

DTS: X, the border sound is no longer constrained by fixed-position speaker placement or specific channel signals.

For using Dolby Atmos® / DTS: X

Dolby Atmos® / DTS: X is available in HDMI eARC / ARC mode. For the details of the connection, please refer to “**HDMI Connection**”. **HDMI eARC / ARC**

1. To use Dolby Atmos® / DTS: X mode, Your TV has to support Dolby Atmos® / DTS: X or HDMI audio passthrough.
2. Make sure that “Bitstream”, “RAW” or “No Encoding” is selected for bitstream in the audio output of the connected external device (e.g. Blu-ray DVD player, TV etc.).
3. While entering Dolby Atmos / DTS: X / Dolby Digital / PCM format, the soundbar will show DOLBY ATMOS / DTS: X / DOLBY AUDIO / PCM AUDIO.

5.3 Use the HDMI Socket

Some 4K HDR TVs require the HDMI input or picture settings to be set for HDR content reception. For further setup details on HDR display, please refer to the instruction manual of your TV.

Using HDMI to connect the soundbar, AV equipment and TV:

Method 1: Standard HDMI

- If your TV is not HDMI ARC-compliant, connect your soundbar to the TV through a standard HDMI connection.
1. Use an HDMI cable to connect the soundbar's **HDMI OUT (eARC/ARC)** socket to the TV's HDMI IN socket.
 2. Use an HDMI cable to connect the soundbar's **HDMI IN** socket to your external devices (e.g. games consoles, DVD players and blu-ray).

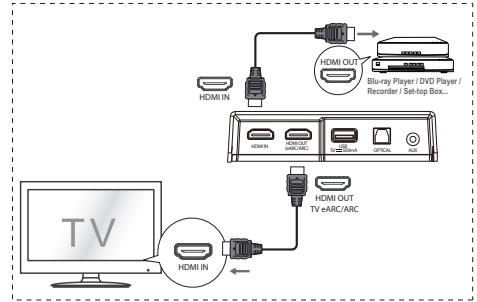

Method 2:

eARC / ARC (Audio Return Channel)

The eARC / ARC (Audio Return Channel) function allows you to send audio from your ARC-compliant TV to your soundbar through a single HDMI connection. To enjoy the ARC function, please ensure your TV is both HDMI-CEC and ARC compliant and set up accordingly. When correctly set up, you can use your TV remote control to adjust the volume output (VOL +/- and MUTE) of the soundbar.

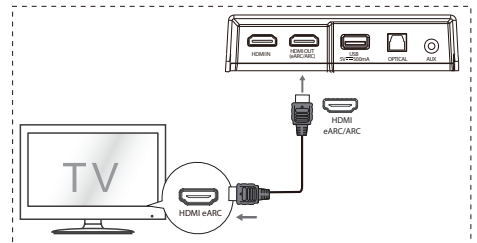

Connect the HDMI cable from unit's **HDMI OUT (TV eARC/ARC)** socket to the HDMI (ARC) socket on your ARC compliant TV. Then press the remote control to select **HDMI eARC**.

Tips:

- Your TV must support the HDMI-CEC and ARC function. HDMI-CEC and ARC must be set to On.
- The setting method of HDMI-CEC and ARC may differ depending on the TV. For details about ARC function, please refer to the owner's manual.
- ARC only works with devices that are HDMI ARC capable as well as with an HDMI 1.4 cable (and higher).

5.4 Use the OPTICAL Socket

- Connect an OPTICAL cable to the TV's OPTICAL OUT socket and the **OPTICAL** socket on the unit.

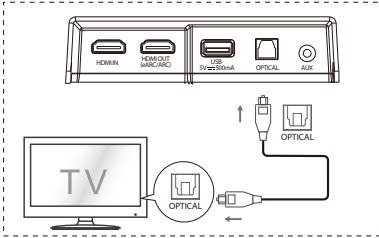

5.5 Connect to AUX Socket

- A Use a RCA to 3.5mm audio cable to connect the TV's audio output sockets to the **AUX** socket on the unit.
- B Use a 3.5mm to 3.5mm audio cable to connect the TV's or external audio device **AUX** socket to the **AUX** socket on the unit.

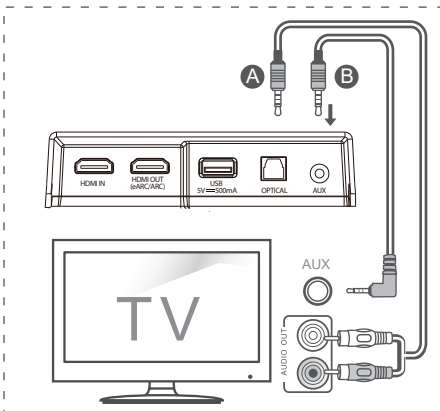

5.6 Connect Power

- **Risk of product damage!**
Ensure that the power supply voltage corresponds to the voltage printed on the back or the underside of the unit.
- Before connecting the AC power cord, ensure you have completed all other connections.
- **Soundbar**
Connect the mains cable to the AC IN socket of the main unit and then into a mains socket.
- **Subwoofer**
Connect the mains cable to the AC IN socket of the subwoofer and then into a mains socket.

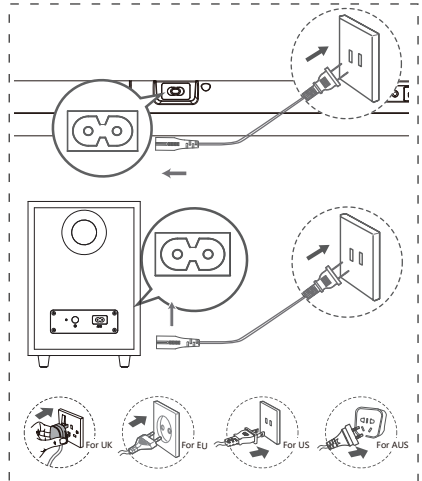

* Power cord quantity and plug vary by regions.

5.7 Pair up with the Subwoofer

Automatic pairing

The subwoofer soundbar will automatically pair when they are plugged into the mains sockets and turned on.

No cable is needed for connecting the two units.



- The status of the indicator on the wireless subwoofer.

LED State	Status
Fast blink	Subwoofer in pairing mode
Constant on	Connected / Pairing successfully
Slow blink	Connection / Pairing failed

NOTE:

- Do not press the PAIR button on the rear of the subwoofer, except for manual pairing.
- If the automatic pairing fails, pair the subwoofer with the main unit manually.

Manual pairing

1. Ensure that all cables are well connected and the main unit is in Standby mode.
2. Press the  button on the main unit or on the remote control to switch the main unit on.
3. Press the  button on the main unit or on the remote control for 3 seconds to enter Pairing mode. The display will scroll "SW Pairing".
4. Press and hold the PAIR button on the rear of the subwoofer for 2 seconds. The subwoofer will enter the pairing mode and the indicator on the subwoofer will blink quickly.
5. After the wireless connection succeeded, the Pair indicator will light up and the display on main unit will scroll "SW IN".
6. If the Pair indicator blink slowly, the wireless connection has failed. Unplug the cable of the subwoofer reconnect the main cables after 3 minutes. Repeat step 1 ~ 4.

NOTE:



- If the wireless connection fails again, check if there is conflict or strong interference (for example, interference from an electronic device) around your location. Remove these conflicts or strong interferences and repeat the above procedures.

- The subwoofer should be within 6m (18 feet) of the soundbar in an open area.
- If the main unit is in On mode, and not connected with the subwoofer, the indicator on the subwoofer will flash slowly. Follow step 1~4 above to pair the subwoofer to the main unit.

6. Basic Operation

6.1 Standby/On



When you first connect the main unit to the mains socket, the main unit will be in STANDBY mode.

- Press the  button on the unit or on the remote control to switch the unit ON.
- Press the  button again to switch the unit back to STANDBY mode.
- Disconnect the mains plug from the mains socket if you want to switch the unit OFF completely.

6.2 Auto-Standby / Auto-Wake Feature



- **[Auto-Standby]** During Auto Standby On mode, the soundbar would standby automatically when no audio is detected for 15 minutes. For example, this would happen when pausing playback, or should the soundbar be left on accidentally.
- **[Auto-Wake]** If a TV or an external device is connected (HDMI IN/HDMI ARC/HDMI eARC/OPTICAL/AUX mode), the unit will switch on automatically when the TV or the external device is switched on.

To disable this feature, please follow the steps below:

1. During ON mode, pointing the remote at the soundbar, press and hold the  button for 3 seconds to open the menu.
 - The unit's display will scroll "MENU".
2. Press the  button 6 times in succession: the display shows: **Auto Wake [ON / OFF]**.
or Press the  button 7 times in succession, the display shows: **Auto Standby [ON / OFF]**.

- Select the content with **VOL +/-** button on the remote control, and then press **▶▶** to confirm your selection and exit the settings.
- Repeating these steps will toggle the feature "**ON**" and "**OFF**".

6.3 Select Modes

- Press the  (SOURCE) button repeatedly on the unit or on the remote control to select the **HDMI eARC/HDMI ARC, HDMI IN, OPTICAL, AUX, USB, BT**(Bluetooth) mode.
- Press the  button on the remote control to select the **BT** (Bluetooth) mode.
- The selected mode will show on the display.

Display	Mode
E ARC	HDMI eARC
ARC	HDMI ARC
HDMI	HDMI IN
OPT	OPTICAL
AUX	AUX
USB NO USB NO FILE	USB No USB connected No Music Or No File Supported
BT_IN NO BT	Bluetooth Connected Not Connected



6.4 Adjust the Bass/Treble Level

- Press the **BASS +/-** buttons on the remote control to adjust bass level (bass +5 / bass -5).
- Press the **TREBLE +/-** buttons on the remote control to adjust treble level (treble +5 / treble -5).

6.5 Turn the Surround Sound ON/OFF

- Press the **SURR** button on the remote control to turn on the surround sound. Press this button again to turn off the surround sound.

6.6 Adjust the Soundbar's Volume

- Press the **+ / -** buttons on the unit or the **VOL+ / VOL-** buttons on the remote control to adjust the volume.
- If you wish to turn the sound off, press the  (MUTE) button on the remote control. Press the  (MUTE) button again or press the **VOL+ / VOL-** buttons to resume normal listening.

- In USB mode, press **▶▶** button or **◀◀/▶▶** to resume normal listening.

In BT mode, only press **VOL+/VOL-** buttons on the connected phone can resume normal listening.

6.7 Adjust the Brightness

- Press the **DIMMER +/-** button on the remote control to select brightness level.

6.8 Select Equalizer (EQ) Effect

- While playing, press the **EQ** button on the remote control to select desired preset equalizers: **MUSIC, MOVIE, NEWS, SPORT, NIGHT, GAME, AI EQ**.

6.9 Set the Audio Delay (AV SYNC)

- Video image processing, sometimes longer than the time required to process the audio signal. This is called "delayed." Audio Delay feature is designed to remedy this delay.
 - Set the audio delay, provided only for the current playback mode. (As provided in the HDMI ARC audio delay mode, the delay mode is valid only for the HDMI ARC).
 - By default, the audio delay is set to 00.
- During ON mode, press and hold the **▶▶** button for 3 seconds to open the menu, then press the **▶▶** button 9 times in succession. The unit's display will scroll "**LT 00**".
 - Press the **VOL+/-** buttons to initiate a 10 ms frequency hopping to adjust the delay time. Set 200 ms maximum delay.
 - Press the **▶▶** button or wait 10 seconds to exit.

Tips:

- Adjustment range: **[00~200ms]**
- The audio delay setting is only valid for digital audio (eg, HDMI IN, HDMI ARC, HDMI eARC, OPTICAL).

7. DTS: X Operation

7.1 DRC / Dialog Control / Neural:X / Virtual:X Features

DTS:X® technologies provide users with virtual multi-channel virtual surround effects, creating an immersive audio volume.

- During ON mode, pointing the remote at the soundbar, press and hold the ►|| button for 3 seconds to open the menu.
- The unit's display will scroll "MENU".

DRC Level Setting:

- Press the ►|| button 10 times in succession, the display shows: DRC 0/1/2

Adjust the Dialog Control Level:

- Press the ►|| button 11 times in succession, the display shows: **DCL 0/1/2/3/4/5/6**

Neural:X Setting:

- Press the ►|| button 12 times in succession: the display shows: **Neural X ON / OFF.**

Virtual:X Setting

- Press the ►|| button 13 times in succession, the display shows: **VIRTUAL X ON/OFF.**

Note:

Above operations are mainly for DTS compliance requirement and only Virtual:X Setting is open for consumer.

8. HDMI eARC/HDMI ARC, HDMI IN, OPTICAL, AUX Operation

- 1 Ensure that the unit is connected to the TV or audio device.
- 2 Press the  button repeatedly on the unit or on the remote control to select the **HDMI eARC/HDMI ARC, HDMI IN, OPTICAL, AUX, USB, BT(Bluetooth)** mode.
- 3 Operate your audio device directly for playback features.
- 4 Press the **VOL +/-** button to adjust the volume to your desired level.

Tips:

- The unit may not be able to decode all digital audio formats from the input source. In this case, the unit will mute. This is NOT a defect. Ensure that the audio setting of the input source (e.g. TV, game console, DVD player, etc.) is set to **PCM** or **Dolby Digital** (Refer to the user manual of the input source device for its audio setting details) with HDMI eARC / OPTICAL / input.
- When selecting a different audio format, the unit will display the following as follows:



Input Format	Display
PCM	PCM
Dolby Digital	DOLBY AUDIO/ DOLBY SURROUND
Dolby Digital Plus	DOLBY AUDIO/ DOLBY SURROUND
Dolby TrueHD	DOLBY AUDIO/ DOLBY SURROUND
Dolby MAT	MPCM
Dolby Digital Plus-Atmos	DOLBY ATMOS
Dolby TrueHD-Atmos	DOLBY ATMOS
Dolby MAT-Atmos	DOLBY ATMOS
DTS	DTS
DTS Discrete Surround	DTS
DTS-ES 6.1 Matrix	DTS
DTS-ES 6.1 Discrete	DTS
DTS 96/24	DTS
DTS 96/24 ES Matrix	DTS
DTS Express	DTS
DTS-ES 8-Channel Discrete	DTS
DTS-HD High Resolution	DTS-HD
DTS-HD Master Audio	DTS-HD
DTS:X	DTS-X
DTS:X Master Audio	DTS-X

9. Bluetooth Operation

9.1 Pair Bluetooth-enabled Devices

The first time you connect your bluetooth device to this unit, you need to pair your device to this unit.

Note:

- The operational range between this unit and a Bluetooth device is approximately 26 feet (8m) (without any object between the Bluetooth device and the unit).
 - Before you connect a Bluetooth device to this unit, ensure you know the device's capabilities.
 - Compatibility with all Bluetooth devices is not guaranteed.
 - Any obstacle between this unit and a Bluetooth device can reduce the operational range.
 - If the signal strength is weak, the unit may disconnect, but it will re-enter pairing mode automatically.
- 1 During ON mode, press the  button repeatedly on the unit or the  button on the remote control to select Bluetooth mode. "NO BT" will show on the display if the unit is not paired to any Bluetooth device.
 - 2 Activate your Bluetooth device and select the search mode. "Hisense AX3120G" will appear on your Bluetooth device list.
 - If you cannot find the unit, press and hold the  button in BT mode for 2 seconds make it searchable. The display will show "BT Pairing" and you will hear the prompt sound from the unit.
 - 3 Select "Hisense AX3120G" in the pairing list. After successful pairing, you will hear the prompt sound from the unit, and the display panel shows "BT_IN".
 - 4 Play music from the connected Bluetooth device.

To disconnect the Bluetooth function, you can :



- Switch to another mode on the unit.
- Disable the BT function from your Bluetooth device. The Bluetooth device will be disconnected from the unit after the voice prompt.
- Press and hold the  button 2 seconds.

Tips:

- Enter "0000" for the password if necessary.
- If no other Bluetooth device pairs with this unit within two minutes, the unit will recover its previous connection.
- The unit will also be disconnected when your device is moved beyond the operational range.
- If you want to reconnect your device to this unit, place it within the operational range.
- If the device is moved beyond the operational range, when it is brought back, please check if the device is still connected to the unit.
- If the connection is lost, follow the instructions above to pair your device to the unit again.

9.2 Listen to Music from Bluetooth Device

- If the connected Bluetooth device supports Advanced Audio Distribution Profile (A2DP), you can listen to the music stored on the device through the unit.
- If the device also supports Audio Video Remote Control Profile (AVRCP), you can use the unit's remote control to play music stored on the device.
 1. Pair your device with the unit.
 2. Play music via your device (if it supports A2DP).
 3. Use supplied remote control to control play (if it supports AVRCP).

	Start, pause or resume play.
	Skip to the previous or next track.

10. USB Operation

1 Insert the USB device.

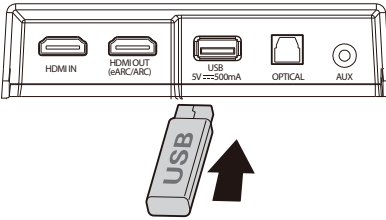

- 2 Press the button repeatedly on the unit or on the remote control to select **USB** mode.
- 3 During playback:

	Start, pause or resume play.
	Skip to the previous or next track.

Tips:

- The unit can support USB devices with up to 32 GB of memory.
- This product may not be compatible with certain types of USB storage devices.
- If you use a USB extension cable, USB hub, or USB Multifunctional card reader, the USB storage device may not be recognized.
- Do not remove the USB storage device while reading files.
- Embedded USB full speed host for USB applications should not exceed 6.5 Mbps.
- For the files in FLAC format, the max blocksize 8107/8109 can support 4608 as the maximum.

Supported USB formats:

Extension	Codec	Sampling Rate	Bit Rate
*.mp3	MPEG - 1 Layer1/2/3	32kHz~48kHz	32kbps~320kbps
	MPEG - 2 Layer1/2/3	16kHz~24kHz	8kbps~160kbps
	MPEG - 2.5 Layer3	8kHz~12kHz	
*.wma	WMA7/8/9/STD	8kHz~48kHz	≤ 320kbps
*.aac	AAC	8kHz~96kHz	≤ 1728kbps
	AAC-LC		
	HE-AAC		
*.ogg	Vorbis codec	8kHz~48kHz	≤ 500kbps
*.flac	-	8kHz~192kHz	≤ 9Mbps
*.wav	PCM、LPCM、IMA_ADPCM、MPEG、ALAW、MULAW、	8kHz~192kHz	≤ 9Mbps
*.AIFF	PCM、ALAW、MULAW	8kHz~192kHz	≤ 9Mbps

- Only USB Format Type FAT 32 is supported for USB storage device connection.
- for *.ogg audio files, below are unsupported formats:
 1). block size 0 < 64 block size 0 > 2048; 2). block size 1 < 64 , block size 1 > 4096; 3). codebook counter > 64; 4). codebook entry > 640; 5). floor counter > 4; 6). floor type 0; 7). residua counter > 4; 8). dimension != 2; 9). mapping counter > 2; 10). mode counter > 2.
- For the file in FLAC format, the max blocksize 8107/8109 can support 4608 as the maximum.

11. Setup Menu

1. During ON mode, press and hold the ►► button for 3 seconds to open the menu.
 2. Select the content with ◀◀/►► buttons.
 3. Change the initial values for each of the settings with VOL +/- buttons.
 4. Press the ►► button to confirm your selection and exit the settings.
- If no button is pressed within 10 seconds, the system will automatically exit the menu.

Display (press ◀◀/►►)	Description (press VOL +/-)
1 MOVIE	Select Equalizer (EQ) Effect. (MOVIE,MUSIC,GAME,NEWS, SPORT,NIGHT,AI)
2 SUR OFF	Switch Surround Sound [ON / OFF]
3 BAS 0	Adjust the Bass Level
4 TRE 0	Adjust the Treble Level
5 DIM 0	Adjust the Brightness (Dimmer Level: DIM 0/1/2/3, exit menu to take effect)
6 AUTO WAKE OFF	Switch Auto Wake [ON / OFF]
7 AUTO STANDBY OFF	Switch Auto Standby [ON / OFF]
8 BEEP ON	Switch Beep [ON / OFF]
9 L T 00	Set the Audio Delay (AV SYNC)
10 DRC 0	Adjust DTS DRC Level: DRC 0/1/2
11 DCL 0	Adjust DTS Dialog Control Level: DCL 0/1/2/3/4/5/6
12 NEURAL ON	Switch: DTS Neural [ON / OFF]
13 VIRTUAL X	Switch: DTS Virtual:X [ON / OFF]
14 BASS BOOST ON	Switch: BassBoost [ON / OFF]

12. Troubleshooting

To keep the warranty valid, never try to repair the system yourself. If you encounter problems when using this unit, check the following points before requesting service.



No power

- Ensure that the AC cord of the unit is properly connected.
- Ensure that there is power at the AC outlet.
- Press standby button to turn the unit on.

Remote control does not work

- Before you press any playback control button, first select the correct source.
- Reduce the distance between the remote control and the unit.
- Insert the battery with its polarities (+/-) aligned as indicated.
- Replace the battery.
- Aim the remote control directly at the sensor on the front of the unit.

No sound

- Make sure that the unit is not muted. Press  or VOL +/- button to resume normal listening.
- Press  button on the unit or on the remote control to switch the soundbar to standby mode. Then press the  button again to switch the soundbar on.
- Unplug both the soundbar and the subwoofer from the mains socket, then plug them again. Switch on the soundbar.
- Ensure the audio setting of the input source (e.g. TV, game console, DVD player, etc.) is set to PCM or Dolby Digital mode while using digital (e.g. HDMI, OPTICAL,) connection.
- The subwoofer is out of range, please move the subwoofer closer to the soundbar. Make sure the subwoofer is within 5 m of the soundbar (the closer the better).
- The soundbar may have lost connection with the subwoofer. Re-pair the units by following the steps on the section "Pairing the Wireless Subwoofer with the Soundbar".
- The unit may not be able to decode all digital audio formats from the input source. In this case, the unit will mute. This is NOT a defect. The device is not muted.

I can't find the Bluetooth name of this unit on my Bluetooth device for Bluetooth pairing

- Ensure the Bluetooth function is activated on your Bluetooth device.
- Ensure you have paired the unit with your Bluetooth device.

This is a 15 mins power off function, one of the ERPII standard requirement for saving power

- When the unit's external input signal level is too low, the unit will be turned off automatically in 15 minutes. Please increase the volume level of your external device.
- For more networked equipment information, see <https://hisense.fr/cat-produit/barres-de-son/>

The subwoofer is idle or the indicator of subwoofer does not light up.

- Please unplug power cord from the mains socket, and plug it in again after 4 minutes to reset the subwoofer.

13. Specifications

Model Name	AX3120G
Soundbar	
Power Supply	AC 100-240V~ 50/60Hz
Power Consumption	20 W
Standby Power	< 0.50 W
USB port for playback USB Compatibility USB Playback support / file formats	5V === 500mA Hi-Speed USB (2.0) / FAT32 / FAT16 32G (max) , WAV/WMA/MP3/FLAC/ALAC
Dimension (WxHxD)	920 x 60 x 90 mm / 36.2" x 2.4" x 3.5"
Net weight	2.9 kg
Frequency Response	150Hz~20KHz
Operating Temperature	0°C - 45°C
Wireless Specification	
Bluetooth version / profiles Bluetooth frequency range Bluetooth Max. transmitting power (EIRP)	V5.3 2400 MHz ~ 2483.5 MHz ≤10 dBm
Modulation Type	GFSK, $\pi/4$ DQPSK, 8DPSK
Subwoofer	
Power Supply	AC 100-240V~ 50/60Hz
Power Consumption	15 W
Standby Power	< 0.50 W
Dimension (WxHxD)	214 x 294 x 304 mm / 8.4" x 11.6" x 12"
Net weight	5.27kg
Frequency Response	40Hz~180Hz
Amplifier (Max Audio Power)	
Total	360 W
Main Unit	240W
Subwoofer	120 W
Remote Control	
Distance/Angle	19.7 feet (6m) / 30°
Battery type	AAA (1.5V X 2)



WARNING: This product can expose you to chemicals including lead, which is known to the State of California to cause cancer. For more information, go to www.P65Warnings.ca.gov.



FR

EN

FCC INFORMATION (for US customers)

NOTE:

- This equipment has been tested and found to comply with the limits for a Class B digital device, pursuant to Part 15 of the FCC Rules. These limits are designed to provide reasonable protection against harmful interference in a residential installation. This equipment generates, uses and can radiate radio frequency energy and, if not installed and used in accordance with the instructions, may cause harmful interference to radio communications.
- However, there is no guarantee that interference will not occur in a particular installation. If this equipment does cause harmful interference to radio or television reception, which can be determined by turning the equipment off and on, the user is encouraged to try to correct the interference by one or more of the following measures:
 - Reorient or relocate the receiving antenna.
 - Increase the separation between the equipment and receiver.
 - Connect the equipment into an outlet on a circuit different from that to which the receiver is connected.
 - Consult the dealer or an experienced radio / TV technician for help.

This device complies with Part 15 of the FCC Rules. Operation is subject to the following two conditions:

- (1) this device may not cause harmful interference, and
 - (2) this device must accept any interference received, including interference that may cause undesired operation.
- Shielded cables must be used with this unit to ensure compliance with the Class B FCC limits.

IC Notice: CAN ICES-3(B)/NMB-3(B)

This device contains licence-exempt transmitter(s)/receiver(s) that comply with Innovation, Science and Economic Development Canada's licence-exempt RSS(s). Operation is subject to the following two conditions:

1. This device may not cause interference.
2. This device must accept any interference, including interference that may cause undesired operation of the device.

Warning:

- This equipment should be installed and operated with minimum distance 20cm between the radiator & your body.
- Changes or modifications to this unit not expressly approved by the party responsible for compliance could void the user's authority to operate the equipment."

Règlement de la FCC (pour les clients américains)

REMARQUE :

- Ce dispositif a été testé et déclaré conforme aux limites d'un dispositif numérique de classe B, conformément à la partie 15 des règles de la FCC.
Ces limites ont pour but d'assurer une protection raisonnable contre le brouillage nuisible dans une installation résidentielle. Cet équipement produit, utilise et peut émettre de l'énergie en radio fréquence et, s'il n'est pas installé et utilisé conformément aux directives, il peut causer un brouillage nuisible dans les communications radio.
- Cependant, il n'est pas garanti que des interférences ne se produiront pas dans une installation particulière. Si cet appareil provoque des interférences nuisibles à la réception radio ou de télévision, ce qui peut être déterminé en mettant l'appareil hors tension, l'utilisateur est encouragé à essayer de corriger l'interférence par une ou plusieurs des mesures suivantes :
 - Réorienter ou déplacer l'antenne de réception.
 - Augmenter la distance entre l'appareil et le récepteur.
 - Brancher l'appareil à une prise sur un circuit différent de celui sur lequel le récepteur est branché.
 - Consulter le revendeur ou un technicien radio/TV expérimenté.

Cet appareil est conforme à la partie 15 des règles de la FCC. Son fonctionnement est soumis aux deux conditions suivantes :

- (1) ce dispositif ne peut pas causer d'interférences nuisibles et
 - (2) cet appareil doit accepter toute interférence reçue, y compris les interférences qui peuvent causer un mauvais fonctionnement.
- Des câbles blindés doivent être utilisés avec cet appareil pour assurer la conformité avec les limites de la classe B de la FCC. fonctionnement de l'appareil.

Avis d'Industrie Canada: CAN ICES-3(B)/NMB-3(B)

L'émetteur/récepteur exempt de licence contenu dans le présent appareil est conforme aux CNR d'Innovation, Sciences et Développement économique Canada applicables aux appareils radio exempts de licence. L'exploitation est autorisée aux deux conditions suivantes :

1. L'appareil ne doit pas produire de brouillage;
2. L'appareil doit accepter tout brouillage radioélectrique subi, même si le brouillage est susceptible d'en compromettre le fonctionnement.

Avvertimento :

- Pour rester en conformité avec les consignes d'exposition aux RF, placez le produit à au moins 20 cm des personnes proches.
- Les changements ou modifications de cet appareil non expressément approuvées par la partie responsable de la conformité pourraient annuler l'autorisation de l'utilisateur à utiliser l'équipement.

Hisense

AX3120G



Made in China

		料号	12.005.0004.06562		尺寸(mm)	展开尺寸: 290x210, 成型尺寸: 145x210		环保要求	说明书类说明: 1. 公差 (mm): 0<a≤50 (+0.3/-0.2), 50<a≤150 (+1/-0.5), >150 (+1.5/-1。有特殊要求的, 按标示公差执行。 2. 要求图文清晰可辨, 内容完整, 折叠正确, 无重影, 墨屎、杂点、脏点、异物、粉点、套印不准。 3. 尺寸按展开尺寸及成型外尺寸测量计算。
项目名称	HS312H项目		产品型号	AX3120G	材质	80g书写纸		<input checked="" type="checkbox"/> RoHS2.0、Reach	
日期	2023.02.21		部件名称	说明书	页码P数	24/p		<input type="checkbox"/> 包装指令94/62/EC	
包装工程师	李小明		平面工程师	刘梅红	颜色	单色印刷		<input type="checkbox"/> 大豆油墨印刷	
设计版本	变更提出人	变更原因		是否有可参考	表面处理	<input checked="" type="checkbox"/> 无 <input type="checkbox"/> 光油 <input type="checkbox"/> 哑油 <input type="checkbox"/> 水性光油 <input type="checkbox"/> 水性哑油 <input type="checkbox"/> UV油 <input type="checkbox"/> 光胶 <input type="checkbox"/> 哑膜 <input type="checkbox"/> 防刮花哑膜		<input type="checkbox"/> 无氯漂白工艺	
A0				<input type="checkbox"/> 刀模 <input checked="" type="checkbox"/> 颜色	工艺	<input checked="" type="checkbox"/> 无 <input type="checkbox"/> 烫金 <input type="checkbox"/> 烫银 <input type="checkbox"/> 击凸 <input type="checkbox"/> 击凹 <input type="checkbox"/> 压网 <input type="checkbox"/> 局部UV <input type="checkbox"/> 其它		<input type="checkbox"/> 粘合剂为非石油基	
				<input type="checkbox"/> 无	条码要求	<input type="checkbox"/> 无条码 <input checked="" type="checkbox"/> 有条码 (清晰易扫描)		<input type="checkbox"/> 油墨中禁止使用矿物油 (法国)	
				<input checked="" type="checkbox"/> 有: 12.005.0004.010982	装订方式	<input type="checkbox"/> 风琴折 <input type="checkbox"/> 包心折 <input checked="" type="checkbox"/> 骑马钉 <input type="checkbox"/> 胶装 <input type="checkbox"/> 线装 <input type="checkbox"/> 其它		<input type="checkbox"/> TPCH (美国)	