



# **Cubi Series**

## **Personal Computer**

Cubi B0A9

User Guide

# Contents

Getting Started.....	3
Package Contents.....	3
Safety & Comfort Tips .....	3
System Overview.....	4
Hardware Setup.....	7
Windows 11 System Operations.....	10
Power Management .....	10
Network Connections .....	14
System Recovery .....	22
F3 Hotkey Recovery (Optional) .....	24
Safety Instructions.....	25
Regulatory Notices.....	27

## Revision

V1.0, 2023/02

# Getting Started

This chapter provides you with the information on hardware setup procedures. While connecting devices, be careful in holding the devices and use a grounded wrist strap to avoid static electricity.

## Package Contents

<b>Personal Computer</b>	Cubi B0A9
<b>Documentation</b>	User Guide (Optional)
	Quick Start Guide (Optional)
	Warranty Book (Optional)
<b>Accessories</b>	Power Cord
	External Power Supply
	Power Button Switch Cable (Optional)
	VESA Plate (Optional)
	VESA Mount Screws (Optional)



### **Important**



- Contact your place of purchase or local distributor if any of the items is damaged or missing.
- Package contents may vary by country.
- The included power cord is exclusively for this personal computer and should not be used with other products.

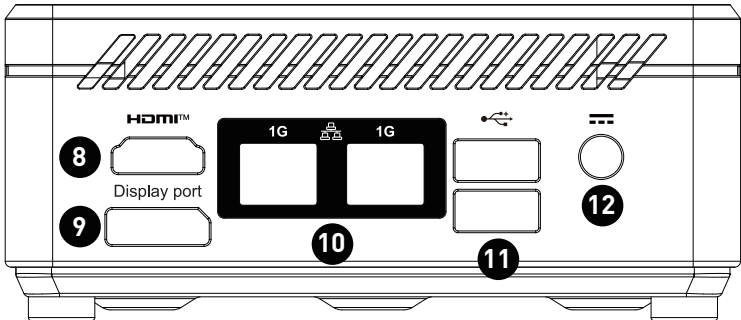
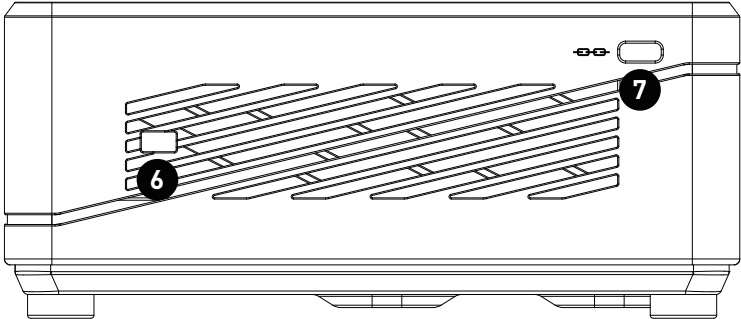
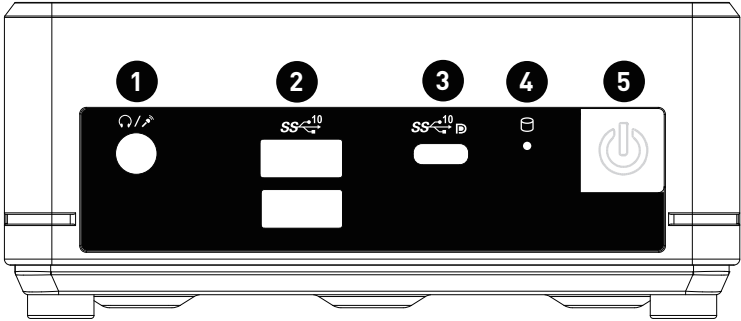

## Safety & Comfort Tips

- Choosing a good workspace is important if you have to work with your PC for a long period of time.
- Your work area should have enough illumination.
- Choose the proper desk and chair and adjust their height to fit your posture when operating.
- When sitting on the chair, sit straight and keep a good posture. Adjust the chair's back (if available) to support your back comfortably.
- Place your feet flat and naturally on the floor, so that your knees and elbows have the proper position (about 90-degree) when operating.
- Put your hands on the desk naturally to support your wrists.
- Avoid using your PC in a place where discomfort may occur (such as on the bed).
- The PC is an electrical device. Please treat it with great care to avoid personal injury.

# System Overview

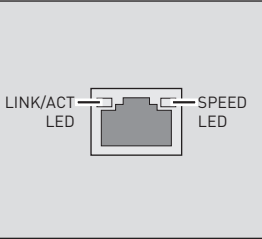

<p><b>1</b></p>	<p><b>Combo Audio Jack</b></p> <p>This connector is provided for headphones or speakers or microphones.</p>
<p><b>2</b></p>	<p><b>USB 3.2 Gen 2 Port</b></p> <p>This connector is provided for USB peripheral devices. (Speed up to 10 Gbps)</p>
<p><b>3</b></p>	<p><b>USB 3.2 Gen 2 Type-C Port (DisplayPort Alternate)</b></p> <p>This connector is provided for USB peripheral devices. This connector can provide up to 5V/3A of power (Speed up to 10 Gbps). This connector supports 4K@60Hz as specified in DisplayPort 1.4.</p>
<p><b>4</b></p>	<p><b>Hard Disk Drive LED</b></p> <p>This indicator shows the activity status of the HDD. It flashes when the system is accessing data on the HDD and remains off when no disk activity is detected.</p>
<p><b>5</b></p>	<p><b>Power Button</b></p> <p>Press the power button to turn the system on and off.</p>
<p><b>6</b></p>	<p><b>Power Button Switch Cable Connector (Optional)</b></p> <p>With a power button switch cable, you can power on/ off the device easier. Remove the cover from the connector and connect the power button switch cable to this connector.</p>
<p><b>7</b></p>	<p><b>Kensington Lock Port</b></p> <p>This PC provides a Kensington lock port, which allows users to secure the PC in place with a key or some mechanical PIN device and attached through a rubberised metal cable. The end of the cable has a small loop which allows the whole cable to be looped around a permanent object, such as a heavy table or other similar equipment, thus securing the PC in place.</p>
<p><b>8</b></p>	<p><b>HDMI™ Connector</b>  <small>HIGH-DEFINITION MULTIMEDIA INTERFACE</small></p> <p>Supports 4K@60Hz as specified in HDMI™ 2.1.</p> <p> <b>Important</b></p> <ul style="list-style-type: none"> <li>• Graphics specifications may vary depending on the installed CPU.</li> <li>• For processors without integrated graphics, connect your monitor to the discrete graphics card.</li> </ul>

<p><b>9</b></p>	<p><b>DisplayPort</b></p> <p>Supports 4K@60Hz as specified in DisplayPort 1.4.</p> <p> <b>Important</b></p> <ul style="list-style-type: none"> <li>• Graphics specifications may vary depending on the installed CPU.</li> <li>• For processors without integrated graphics, connect your monitor to the discrete graphics card.</li> </ul>																	
<p><b>10</b></p>	<p><b>1 Gbps LAN Jack</b></p> <p>The standard RJ-45 LAN jack is provided for connection to the Local Area Network (LAN). You can connect a network cable to it.</p> <div data-bbox="229 488 912 727">  <table border="1" data-bbox="503 488 912 727"> <thead> <tr> <th>LED</th> <th>Status</th> <th>Description</th> </tr> </thead> <tbody> <tr> <td rowspan="3">Link/ Activity LED</td> <td>Off</td> <td>No link</td> </tr> <tr> <td>Yellow</td> <td>Linked</td> </tr> <tr> <td>Blinking</td> <td>Data activity</td> </tr> <tr> <td rowspan="3">Speed LED</td> <td>Off</td> <td>10 Mbps</td> </tr> <tr> <td>Green</td> <td>100 Mbps</td> </tr> <tr> <td>Orange</td> <td>1 Gbps</td> </tr> </tbody> </table> </div>	LED	Status	Description	Link/ Activity LED	Off	No link	Yellow	Linked	Blinking	Data activity	Speed LED	Off	10 Mbps	Green	100 Mbps	Orange	1 Gbps
LED	Status	Description																
Link/ Activity LED	Off	No link																
	Yellow	Linked																
	Blinking	Data activity																
Speed LED	Off	10 Mbps																
	Green	100 Mbps																
	Orange	1 Gbps																
<p><b>11</b></p>	<p><b>USB 2.0 Port</b></p> <p>This connector is provided for USB peripheral devices. (Speed up to 480 Mbps)</p> <p> <b>Important</b></p> <p><i>High-speed devices are recommended for USB 3.2 ports whereas low-speed devices, such as mouse or keyboard, are suggested to be plugged into the USB 2.0 ports.</i></p>																	
<p><b>12</b></p>	<p><b>Power Jack</b></p> <p>Power supplied through this jack supplies power to your system.</p>																	

## Hardware Setup

Connect your peripheral devices to suitable ports.

 **Important**

- For detailed instructions on how to connect, please refer to the manuals of your peripheral devices.

Connect the power cord to the system and electrical outlet.

External Power Supply: 65W, 19V

- Input: 100~240Vac, 50/60Hz
- Output: 19V  3.42A

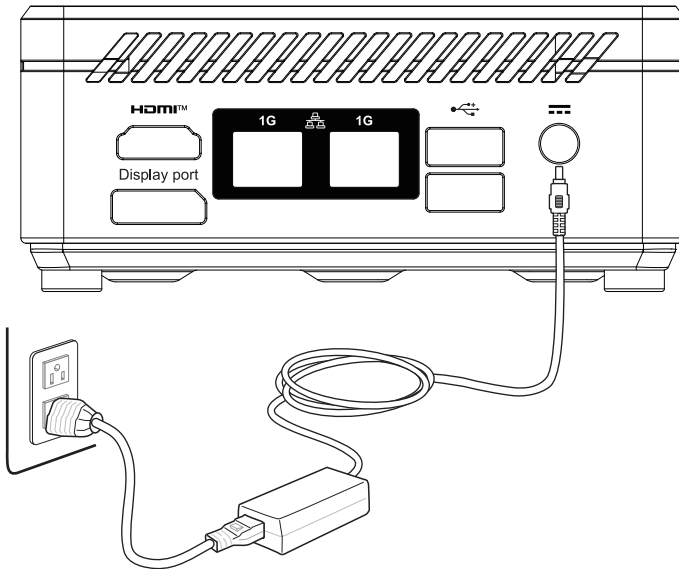

 **Important**

When unplugging the AC power cord, always hold the connector part of the cord. Never pull the cord directly.

Press the power button to power on the system.

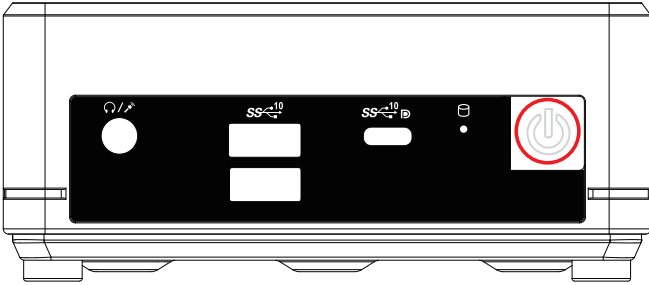

 **Important**

Reference image only. Appearance will vary.

**Connect the power button switch cable. (Optional)**

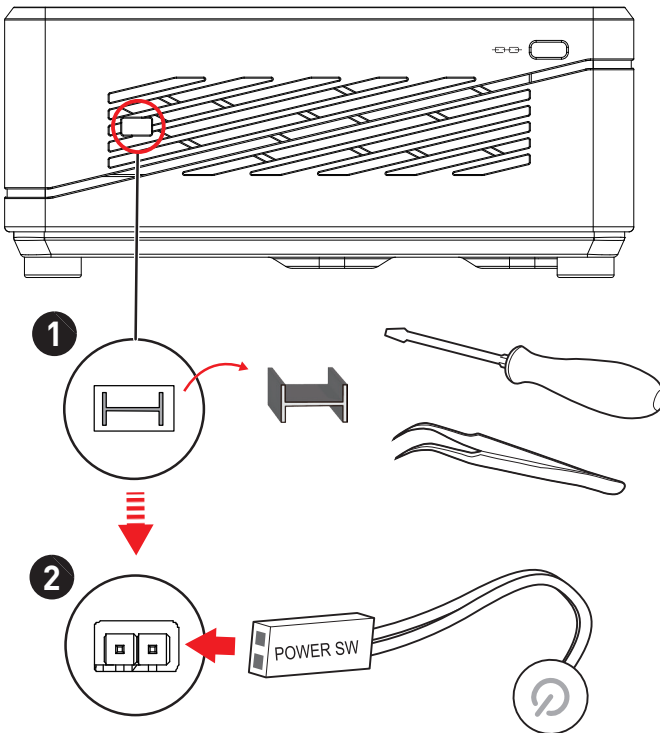



## Place the Device

Users can place the device horizontally or wall mount it.

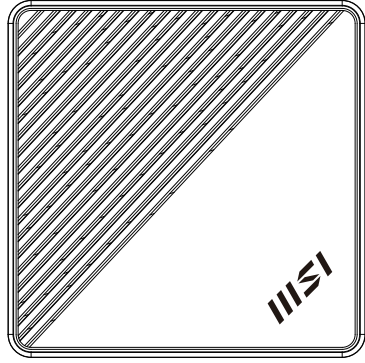
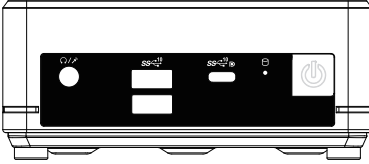

# Windows 11 System Operations



All information and Windows screenshots are subject to change without prior notice.

## Power Management

Power management of personal computers (PCs) and monitors has the potential to save significant amounts of electricity as well as deliver environmental benefits.

To be energy efficient, turn off your display or set your PC to sleep mode after a period of user inactivity.

1. Right-click [Start] and select [Power Options] from the list.
2. Adjust [Screen and sleep] settings and select a power mode from the list.
3. To choose or customize a power plan, type control panel in the search box and select [Control Panel].
4. Open up [All Control Panel Items] window. Select [Large icons] under [View by] drop-down menu.
5. Select [Power Options] to continue.
6. Select a power plan and fine-tune the settings by clicking [Change plan settings].
7. To create your own power plan, select [Create a power plan].
8. Select an existing plan and give it a new name.
9. Adjust settings for your new power plan.
10. The [Shut down or sign out] menu also presents power saving options for rapid and easy management of your system power.

## Energy Savings

The power management feature allows the computer to initiate a low-power or “Sleep” mode after a period of user inactivity. To take advantage of these potential energy savings, the power management feature has been preset to behave in the following ways when the system is operating on AC power:

- Turn off the display after 10 minutes
- Initiate Sleep after 30 minutes

## Waking the System Up

The computer shall be able to wake up from power saving mode in response to a command from any of the following:

- the power button,
- the network (Wake On LAN),
- the mouse,
- the keyboard.



### Energy Saving Tips:

- Turn off the monitor by pressing the monitor power button after a period of user inactivity.

- Tune the settings in Power Options under Windows OS to optimize your PC's power management.
- Install power saving software to manage your PC's energy consumption.
- Always disconnect the AC power cord or switch the wall socket off if your PC would be left unused for a certain time to achieve zero energy consumption.

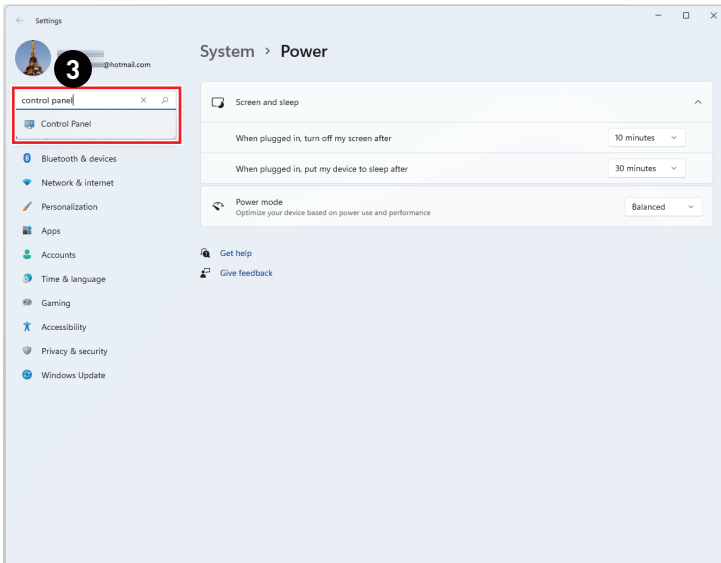
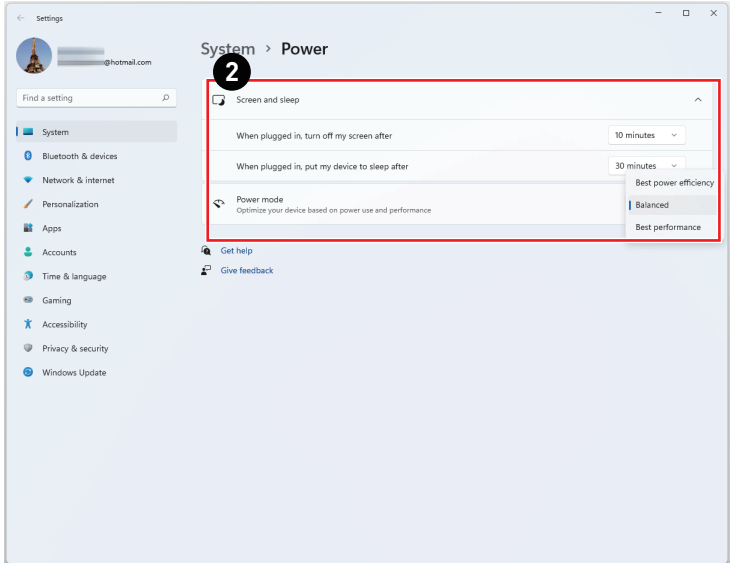
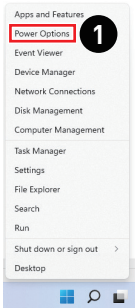

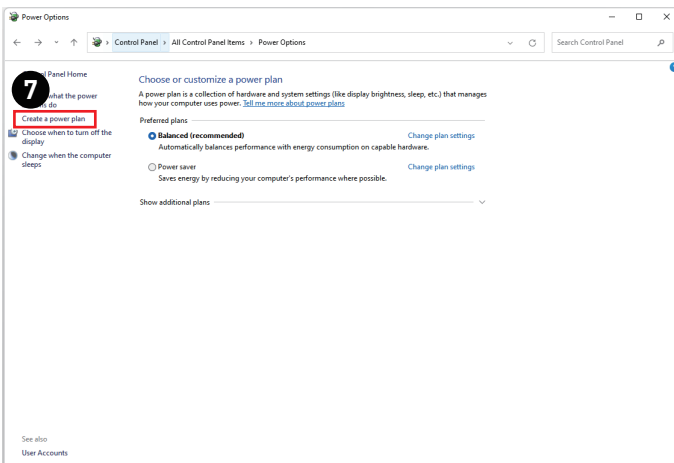
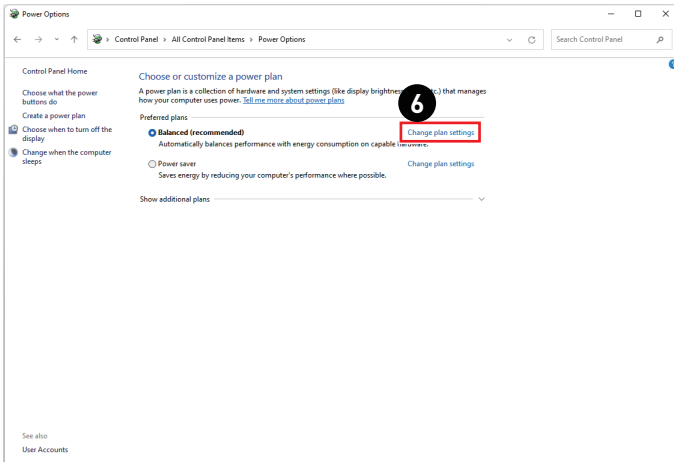
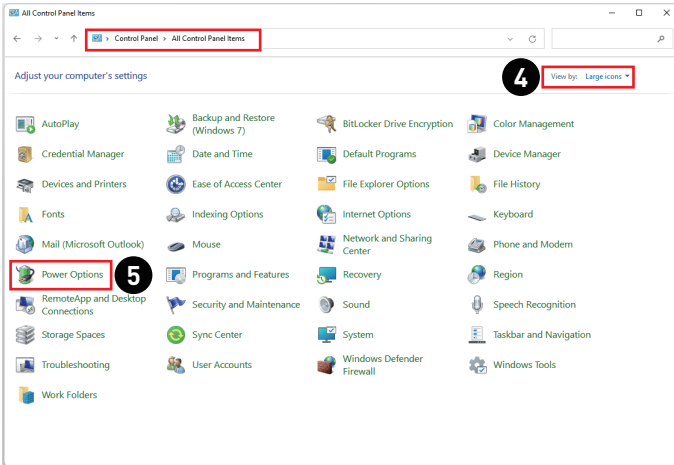

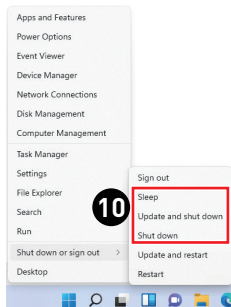
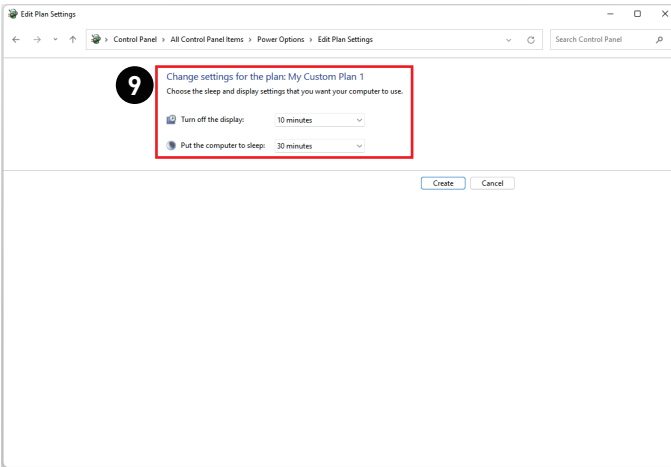
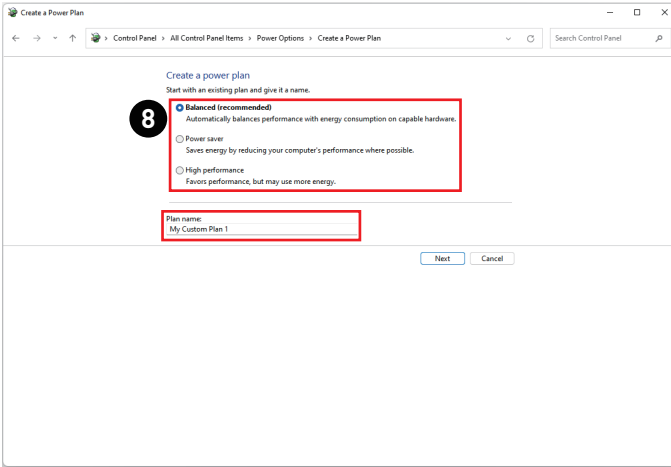

# Network Connections

## Wi-Fi

1. Right-click [Start] and select [Network Connections] from the list.
2. Select and turn on [Wi-Fi].
3. Select [Show available networks]. A list of available wireless networks pops up. Choose a connection from the list.
4. To establish a new connection, select [Manage known networks].
5. Select [Add network].
6. Enter information for the wireless network you intend to add and click [Save] to establish a new connection.

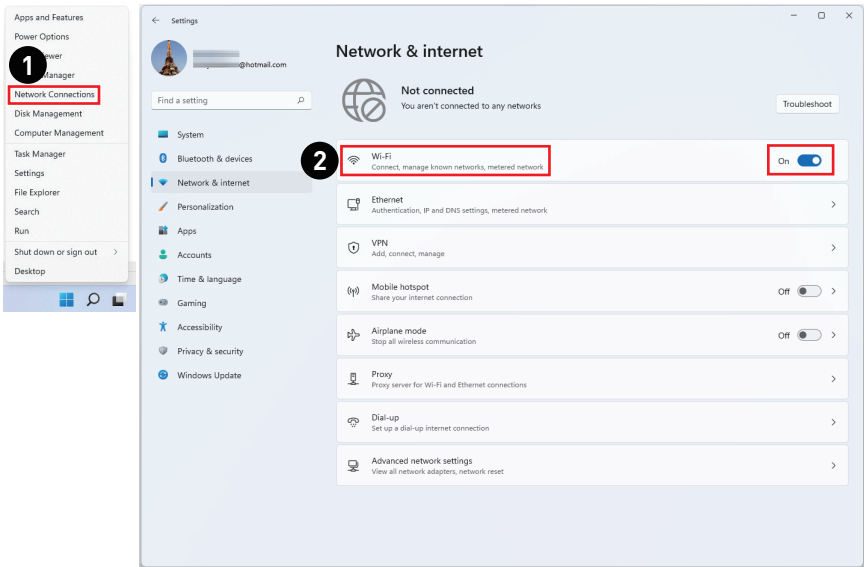

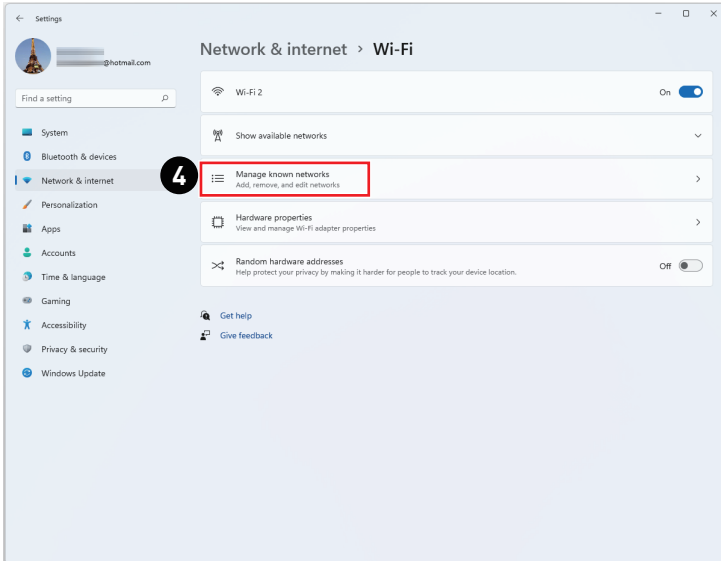
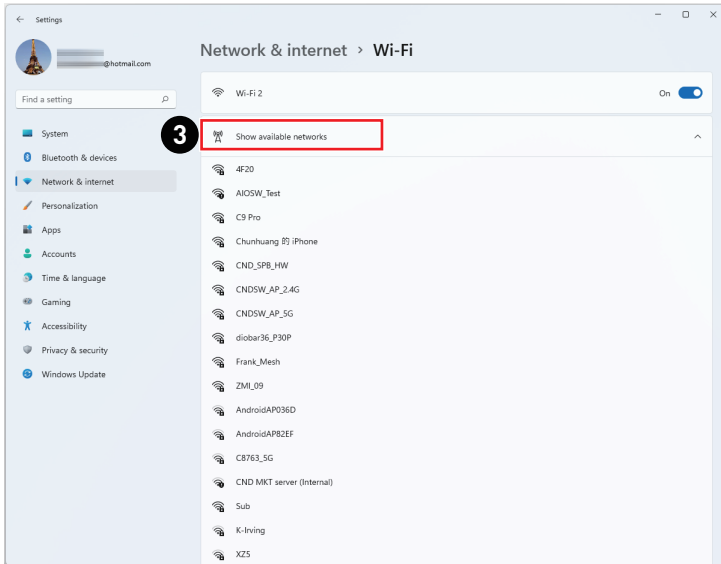

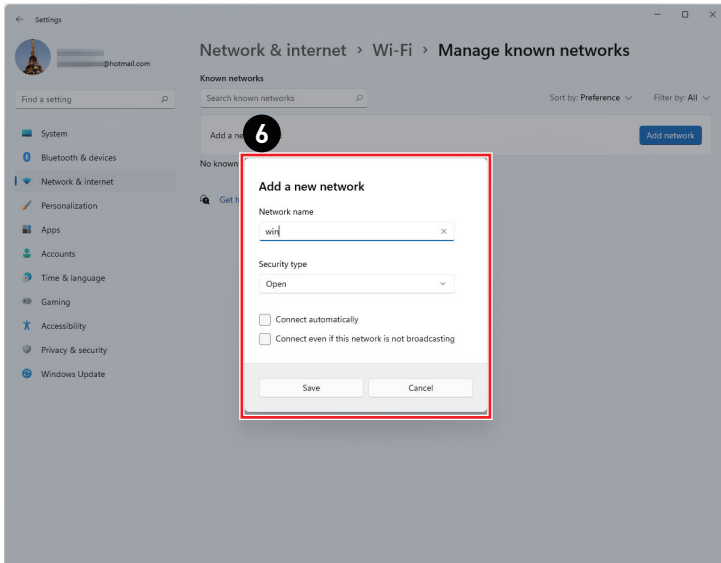
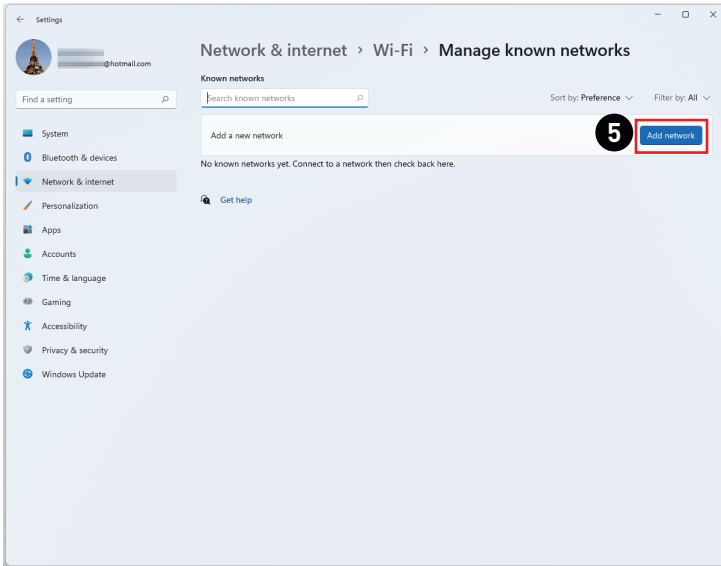



## Ethernet

1. Right-click [Start] and select [Network Connections] from the list.
2. Select [Ethernet].
3. The [IP assignment] and [DNS server assignment] are automatically set as [Automatic (DHCP)].
4. For a Static IP connection, click [Edit] of [IP assignment].
5. Select [Manual].
6. Switch on the [IPv4] or [IPv6].
7. Type the information from your Internet Service Provider and click [Save] to establish a Static IP connection.

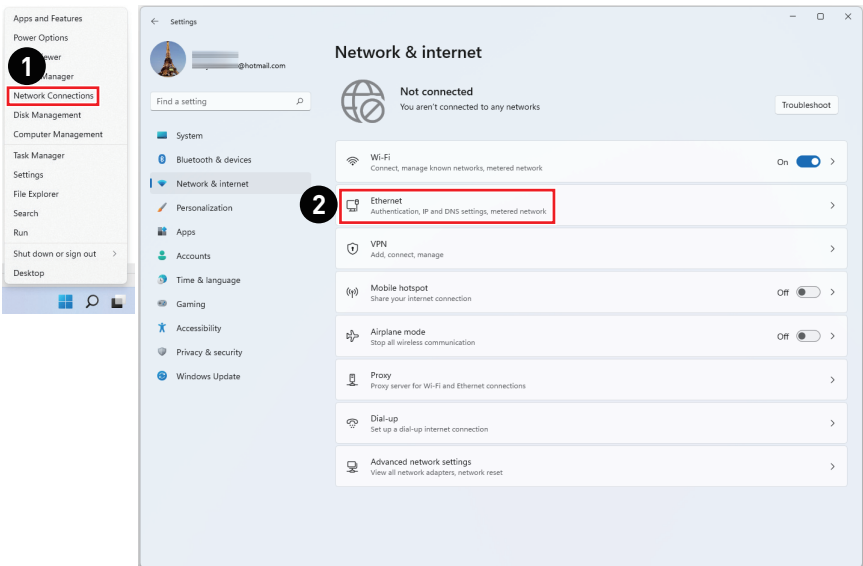

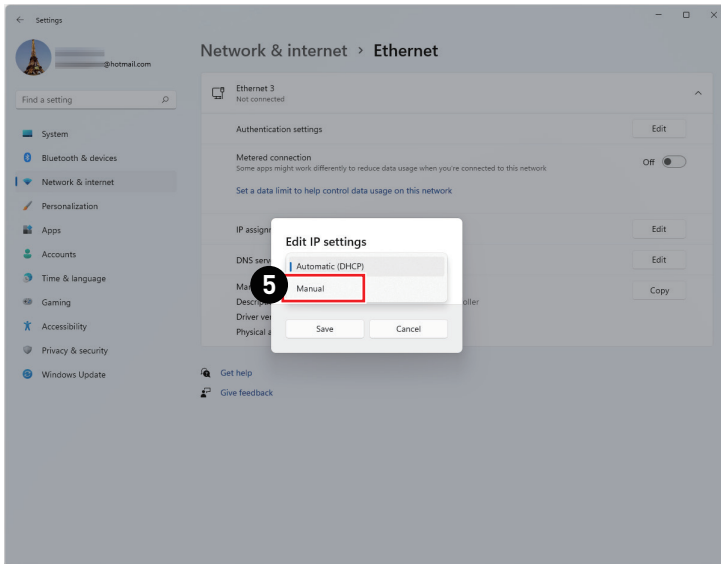
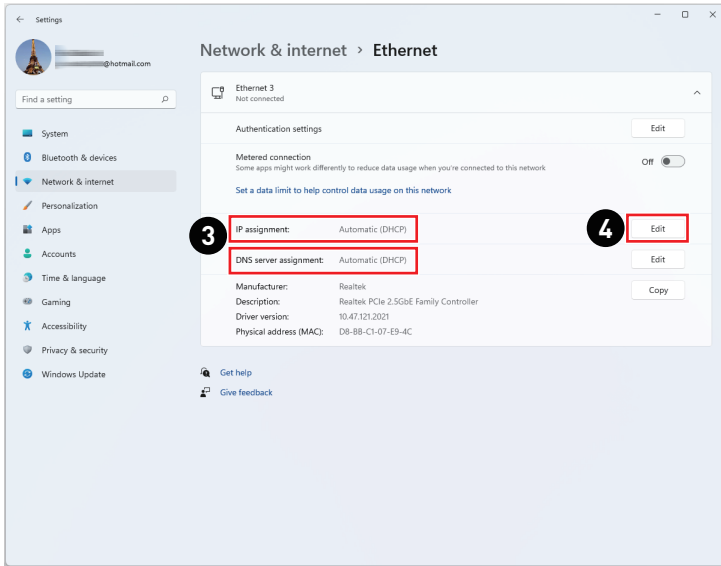

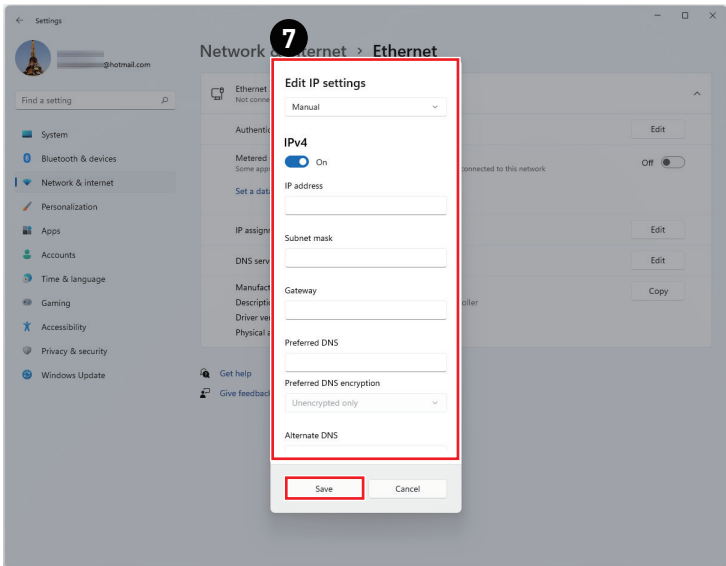
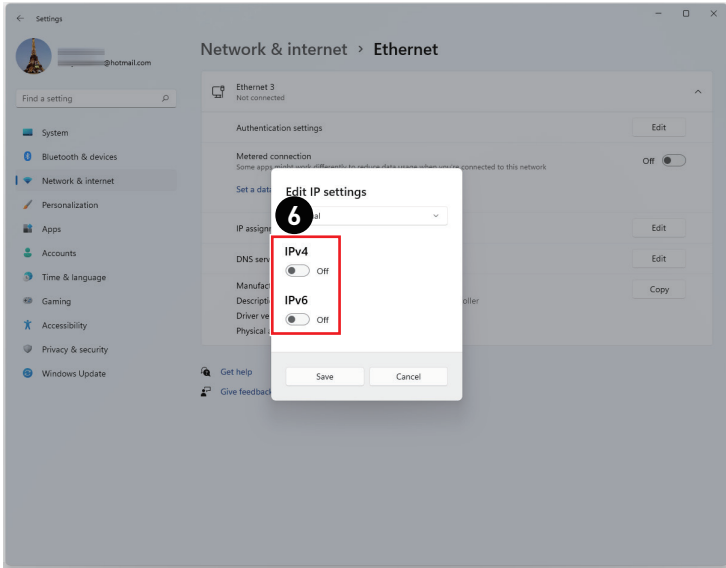

# Dial-up

1. Right-click [Start] and select [Network Connections] from the list.
2. Select [Dial-up].
3. Select [Set up a new connection].
4. Choose [Connect to the Internet] and click [Next].
5. Select [Broadband (PPPoE)] to connect using DSL or cable that requires a user name and password.
6. Type the information from your Internet Service Provider (ISP) and click [Connect] to establish your LAN connection.

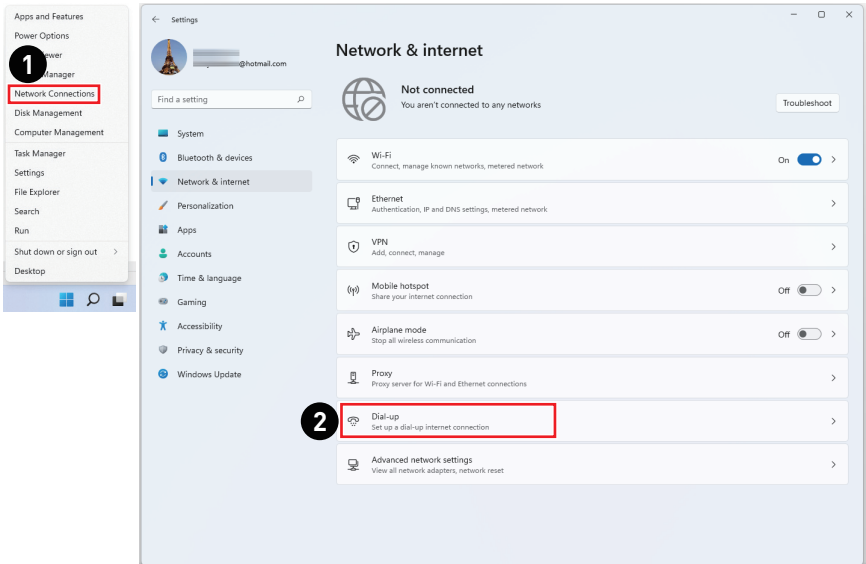

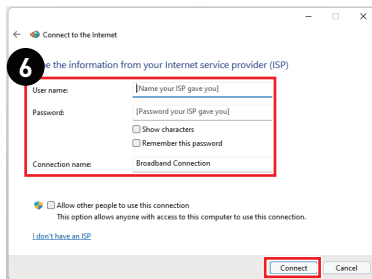
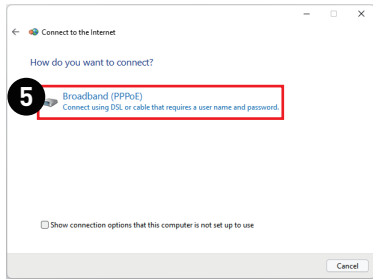
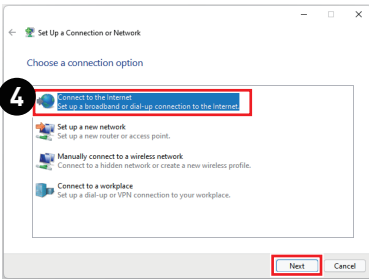
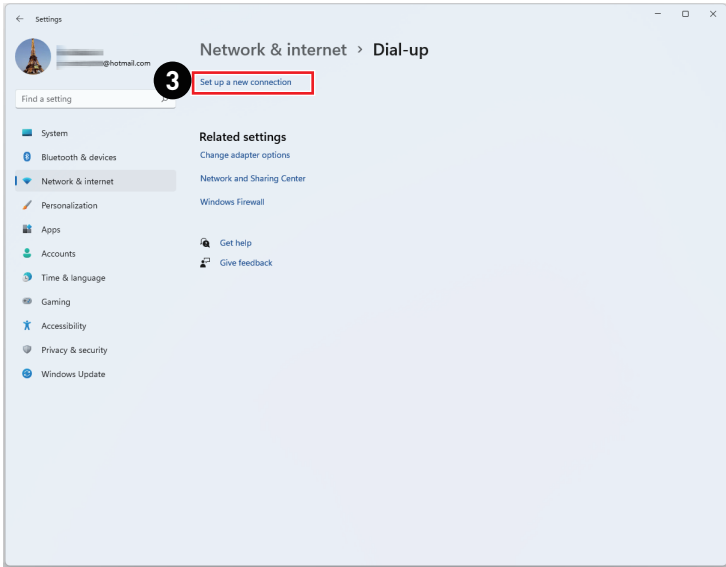

# System Recovery

The purposes for using the System Recovery Function may include:

- Restore the system back to the initial status of original manufacturer's default settings.
- When some errors have occurred to the operating system in use.
- When the operating system is affected by virus and is not able to work normally.
- When you want to install the OS with other built-in languages.

Before using the System Recovery Function, please back up the important data saved on your system drive to other storage devices.

If the following solution fails to recover your system, please contact the authorized local distributor or service center for further assistance.

## Reset this PC

1. Right-click [Start] and select [Settings] from the list.
2. Select [Recovery] under [System].
3. Click [Reset PC] to start the system recovery.
4. The [Choose an option] screen pops up. Choose between [Keep my files] and [Remove everything] and follow the on-screen instructions to complete your system recovery.

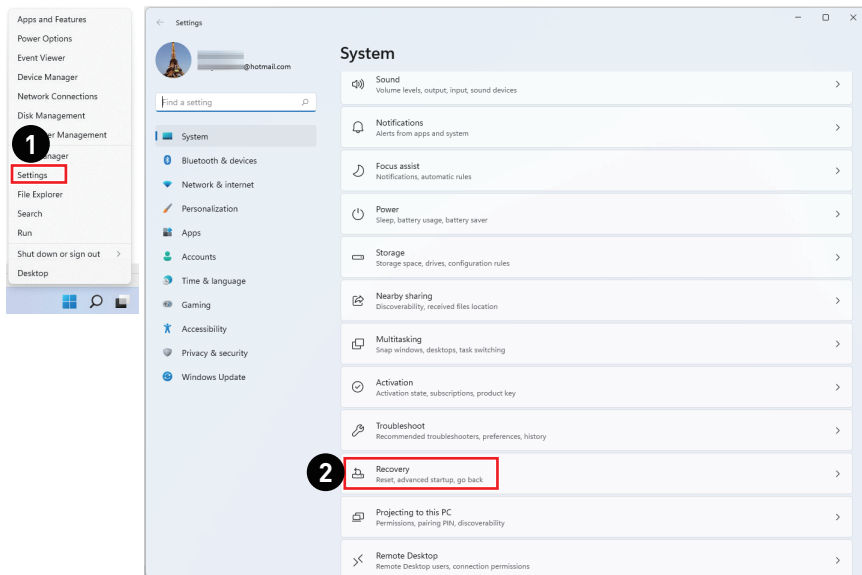

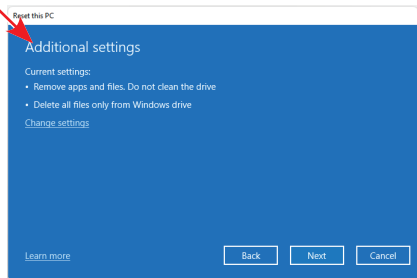
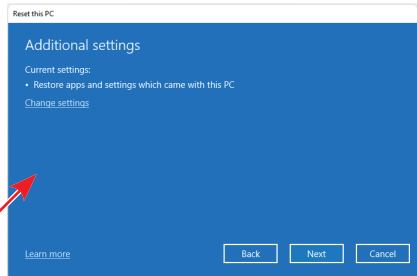
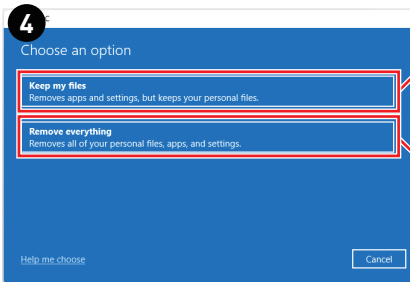
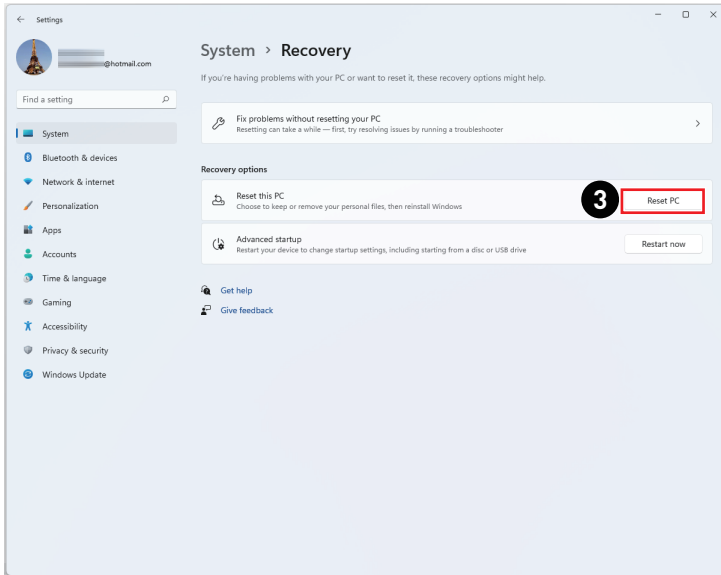

# F3 Hotkey Recovery (Optional)

## Precautions for Using the System Recovery Function

1. If your hard drive and system encountered non-recoverable problems, please use the F3 Hotkey recovery from the Hard Drive first to perform the System Recover Function.
2. Before using the System Recovery Function, please back up the important data saved on your system drive to other storage devices.

## Recovering the system with the F3 Hotkey

Follow the instructions below to continue:

1. Restart the PC.
2. Press the F3 hotkey on the keyboard promptly when the MSI greeting appears on the display.
3. On the [Choose an option] screen, select [Troubleshoot].
4. On the [Troubleshoot] screen, select [Restore MSI factory settings] to reset the system to the default settings.
5. On the [RECOVERY SYSTEM] screen, select [System Partition Recovery].
6. Follow the on-screen instructions to continue and complete the Recovery Function.



# Safety Instructions

- Read the safety instructions carefully and thoroughly.
- All cautions and warnings on the device or User Guide should be noted.
- Refer servicing to qualified personnel only.

## Power

- Make sure that the power voltage is within its safety range and has been adjusted properly to the value of 100~240V before connecting the device to the power outlet.
- If the power cord comes with a 3-pin plug, do not disable the protective earth pin from the plug. The device must be connected to an earthed mains socket-outlet.
- Please confirm the power distribution system in the installation site shall provide the circuit breaker rated 120/240V, 20A (maximum).
- Always unplug the power cord before installing any add-on card or module to the device.
- Always disconnect the power cord or switch the wall socket off if the device would be left unused for a certain time to achieve zero energy consumption.
- Place the power cord in a way that people are unlikely to step on it. Do not place anything on the power cord.
- If this device comes with an adapter, use only the MSI provided AC adapter approved for use with this device.

## Battery

Please take special precautions if this device comes with a battery.

- Danger of explosion if battery is incorrectly replaced. Replace only with the same or equivalent type recommended by the manufacturer.
- Avoid disposal of a battery into fire or a hot oven, or mechanically crushing or cutting of a battery, which can result in an explosion.
- Avoid leaving a battery in an extremely high temperature or extremely low air pressure environment that can result in an explosion or the leakage of flammable liquid or gas.
- Do not ingest battery. If the coin/button cell battery is swallowed, it can cause severe internal burns and can lead to death. Keep new and used batteries away from children.

### European Union:



Batteries, battery packs, and accumulators should not be disposed of as unsorted household waste. Please use the public collection system to return, recycle, or treat them in compliance with the local regulations.

### BSMI:



廢電池請回收

For better environmental protection, waste batteries should be collected separately for recycling or special disposal.

## California, USA:



The button cell battery may contain perchlorate material and requires special handling when recycled or disposed of in California. For further information please visit: <https://dtsc.ca.gov/perchlorate/>

## Environment

- To reduce the possibility of heat-related injuries or of overheating the device, do not place the device on a soft, unsteady surface or obstruct its air ventilators.
- Use this device only on a hard, flat and steady surface.
- To prevent fire or shock hazard, keep this device away from humidity and high temperature.
- Do not leave the device in an unconditioned environment with a storage temperature above 60°C or below 0°C, which may damage the device.
- The maximum operating temperature is around 35°C.
- When cleaning the device, be sure to remove the power plug. Use a piece of soft cloth rather than industrial chemical to clean the device. Never pour any liquid into the opening; that could damage the device or cause electric shock.
- Always keep strong magnetic or electrical objects away from the device.
- If any of the following situations arises, get the device checked by service personnel:
  - The power cord or plug is damaged.
  - Liquid has penetrated into the device.
  - The device has been exposed to moisture.
  - The device does not work well or you can not get it working according to the User Guide.
  - The device has dropped and damaged.
  - The device has obvious sign of breakage.

# Regulatory Notices

## CE Conformity

Products bearing the CE marking comply with one or more of the following EU Directives as may be applicable:



- RED 2014/53/EU
- Low Voltage Directive 2014/35/EU
- EMC Directive 2014/30/EU
- RoHS Directive 2011/65/EU
- ErP Directive 2009/125/EC

Compliance with these directives is assessed using applicable European Harmonized Standards.

The point of contact for regulatory matters is MSI-Europe: Eindhoven 5706 5692 ER Son.

## Products with Radio Functionality (EMF)

This product incorporates a radio transmitting and receiving device. For computers in normal use, a separation distance of 20 cm ensures that radio frequency exposure levels comply with EU requirements. Products designed to be operated at closer proximities, such as tablet computers, comply with applicable EU requirements in typical operating positions. Products can be operated without maintaining a separation distance unless otherwise indicated in instructions specific to the product.

## Restrictions for Products with Radio Functionality (select products only)



**CAUTION:** IEEE 802.11x wireless LAN with 5.15~5.35 GHz frequency band is restricted for indoor use only in all European Union member states, EFTA (Iceland, Norway, Liechtenstein), and most other European countries (e.g., Switzerland, Turkey, Republic of Serbia). Using this WLAN application outdoors might lead to interference issues with existing radio services.



### Radio frequency bands and maximum power levels

- Features: Wi-Fi 6E, BT
- Frequency Range:
  - 2.4 GHz: 2400~2485MHz
  - 5 GHz: 5150~5350MHz, 5470~5725MHz, 5725~5850MHz
  - 6 GHz: 5955~6415MHz
- Max Power Level:
  - 2.4 GHz: 20dBm
  - 5 GHz: 23dBm
  - 6 GHz: 23dBm

## FCC-B Radio Frequency Interference Statement

This equipment has been tested and found to comply with the limits for a Class B digital device, pursuant to Part 15 of the FCC Rules. These limits are designed to provide reasonable protection against harmful interference in a residential installation. This equipment generates, uses and can radiate radio frequency energy and, if not installed and used in accordance with the instruction manual, may cause harmful interference to radio communications. However, there is no guarantee that interference will not occur in a particular installation. If this equipment does cause harmful interference to radio or television reception, which can be determined by turning the equipment off and on, the user is encouraged to try to correct the interference by one or more of the measures listed below:



- Reorient or relocate the receiving antenna.
- Increase the separation between the equipment and receiver.
- Connect the equipment into an outlet on a circuit different from that to which the receiver is connected.
- Consult the dealer or an experienced radio/television technician for help.

#### **Notice 1**

The changes or modifications not expressly approved by the party responsible for compliance could void the user's authority to operate the equipment.

#### **Notice 2**

Shielded interface cables and AC power cord, if any, must be used in order to comply with the emission limits.

This device complies with Part 15 of the FCC Rules. Operation is subject to the following two conditions:

- this device may not cause harmful interference, and
- this device must accept any interference received, including interference that may cause undesired operation.

#### **MSI Computer Corp.**

901 Canada Court, City of Industry, CA 91748, USA

(626) 913-0828

[www.msi.com](http://www.msi.com)

## **WEEE Statement**

Under the European Union ("EU") Directive on Waste Electrical and Electronic Equipment, Directive 2012/19/EU, products of "electrical and electronic equipment" cannot be discarded as municipal waste anymore and manufacturers of covered electronic equipment will be obligated to take back such products at the end of their useful life.



## **Chemical Substances Information**

In compliance with chemical substances regulations, such as the EU REACH Regulation (Regulation EC No. 1907/2006 of the European Parliament and the Council), MSI provides the information of chemical substances in products at: <https://csr.msi.com/global/index>

## **RoHS Statement**

### **Japan JIS C 0950 Material Declaration**

A Japanese regulatory requirement, defined by specification JIS C 0950, mandates that manufacturers provide material declarations for certain categories of electronic products offered for sale after July 1, 2006.

<https://csr.msi.com/global/Japan-JIS-C-0950-Material-Declarations>

### **India RoHS**

This product complies with the “India E-waste (Management and Handling) Rule 2016” and prohibits use of lead, mercury, hexavalent chromium, polybrominated biphenyls or polybrominated diphenyl ethers in concentrations exceeding 0.1 weight % and 0.01 weight % for cadmium, except for the exemptions set in Schedule 2 of the Rule.

### **Turkey EEE Regulation**

Conforms to the EEE Regulations of the Republic Of Turkey

### **Ukraine Restriction of Hazardous Substances**

The equipment complies with requirements of the Technical Regulation, approved by the Resolution of Cabinet of Ministry of Ukraine as of 10 March 2017, № 139, in terms of restrictions for the use of certain dangerous substances in electrical and electronic equipment.

### **Vietnam RoHS**

As from December 1, 2012, all products manufactured by MSI comply with Circular 30/2011/TT-BCT temporarily regulating the permitted limits for a number of hazardous substances in electronic and electric products.

## Green Product Features

- Reduced energy consumption during use and stand-by
- Limited use of substances harmful to the environment and health
- Easily dismantled and recycled
- Reduced use of natural resources by encouraging recycling
- Extended product lifetime through easy upgrades
- Reduced solid waste production through take-back policy

## Environmental Policy

- The product has been designed to enable proper reuse of parts and recycling and should not be thrown away at its end of life.
- Users should contact the local authorized point of collection for recycling and disposing of their end-of-life products.
- Visit the MSI website and locate a nearby distributor for further recycling information.
- Users may also reach us at [gpcontdev@msi.com](mailto:gpcontdev@msi.com) for information regarding proper disposal, take-back, recycling, and disassembly of MSI products.



## Upgrade and Warranty

Please note that certain components preinstalled in the product may be upgradable or replaceable by user's request. For any further information about the product users purchased, please contact the local dealer. Do not attempt to upgrade or replace any component of the product if you are not an authorized dealer or service center, since it may cause the warranty void. It is strongly recommended that you contact the authorized dealer or service center for any upgrade or replace service.

## Acquisition of Replaceable Parts

Please be noticed that the acquisition of replaceable parts (or compatible ones) of the product users purchased in certain countries or territories may be fulfilled by the manufacturer within 5 years at most since the product has been discontinued, depending on the official regulations declared at the time. Please contact the manufacturer via <https://www.msi.com/support/> for the detailed information about the acquisition of spare parts.

## Copyright and Trademarks Notice

Copyright © Micro-Star Int'l Co., Ltd. All rights reserved. The MSI logo used is a registered trademark of Micro-Star Int'l Co., Ltd. All other marks and names mentioned may be trademarks of their respective owners. No warranty as to accuracy or completeness is expressed or implied. MSI reserves the right to make changes to this document without prior notice.

## Technical Support

If a problem arises with your system and no solution can be obtained from the user's manual, please contact your place of purchase or local distributor. Alternatively, please try the following help resources for further guidance. Visit the MSI website for technical guide, BIOS updates, driver updates and other information via

<https://www.msi.com/support/>