



User Guide

Outdoor Pan/Tilt Security Wi-Fi Camera

Contents

About This Guide	1
Introduction	2
Appearance	3
Set Up Your Camera	5
Set Up Using Amazon Frustration-Free Setup	6
Install a microSD Card	10
Mount Your Camera	11
Install Waterproof Items	13
How to Reset Your Camera	14
Authentication	15

About This Guide

This guide provides a brief introduction to the Outdoor Pan/Tilt Security Wi-Fi Camera and the Tapo app, as well as regulatory information.

Please note that features available in Tapo may vary by model and software version. Tapo availability may also vary by region. All images, steps, and descriptions in this guide are only examples and may not reflect your actual Tapo Camera experience.

Conventions

In this guide, the following convention is used:

Convention	Description
Blue	Key information appears in blue, including management page text such as menus, items, buttons and so on.
<u>Underline</u>	Hyperlinks are in blue and underlined. You can click to redirect to a website.
📌Note:	Ignoring this type of note might result in a malfunction or damage to the device.

More Info

- Specifications can be found on the product page at <https://www.tapo.com>.
- Our Technical Support and troubleshooting information can be found at <https://www.tapo.com/support/>.

Introduction

Tapo C500 is a full-featured weatherproof security camera that you can access from anywhere. Receive instant notifications and check feeds when the motion is detected. Moreover, the automatic siren system will trigger light and sound to frighten away unwanted visitors after the camera detects motion.

Day or night, rain or shine, the Tapo camera protects what you love most.

- **Smart Person Detection and Motion Tracking** – Smart AI identifies a person while tracking motion with high-speed rotation, notifying users as needed.
- **1080p Full HD** – Reveal clear and sharp images while ensuring high network speed.
- **360° Visual Coverage** – Provide 360° horizontal & 130° vertical range to cover every corner.
- **Customizable Alarm** – Record your customized audio as an alarm to extend your usages.
- **Flexible Storage Options** – Save recorded videos to an installed microSD card (up to 512 GB)*, or use Tapo Care** cloud storage service.
*microSD card must be purchased separately.
**Subscribe for cloud storage at <https://www.tapo.com/tapocare/>
- **IP65 Water & Dust Resistant** – Offer excellent waterproof and dustproof performance for outdoor scenarios.
- **Physical Privacy Mode** – Maintain your privacy with the lens physically blocked by the housing.
- **Night Vision (up to 98 ft)** – Ensure your safety by providing a clear visual distance of up to 98 ft even in total darkness.
- **Two-Way Audio** – Communicate remotely with a delivery person in real time.
- **Position Anywhere You Need** – Use the mounting screws, template and loops* to install on any wall, ceiling or pole for the perfect view—wherever you want.
*Loops (purchased separately) are needed for pole mounting.

Appearance

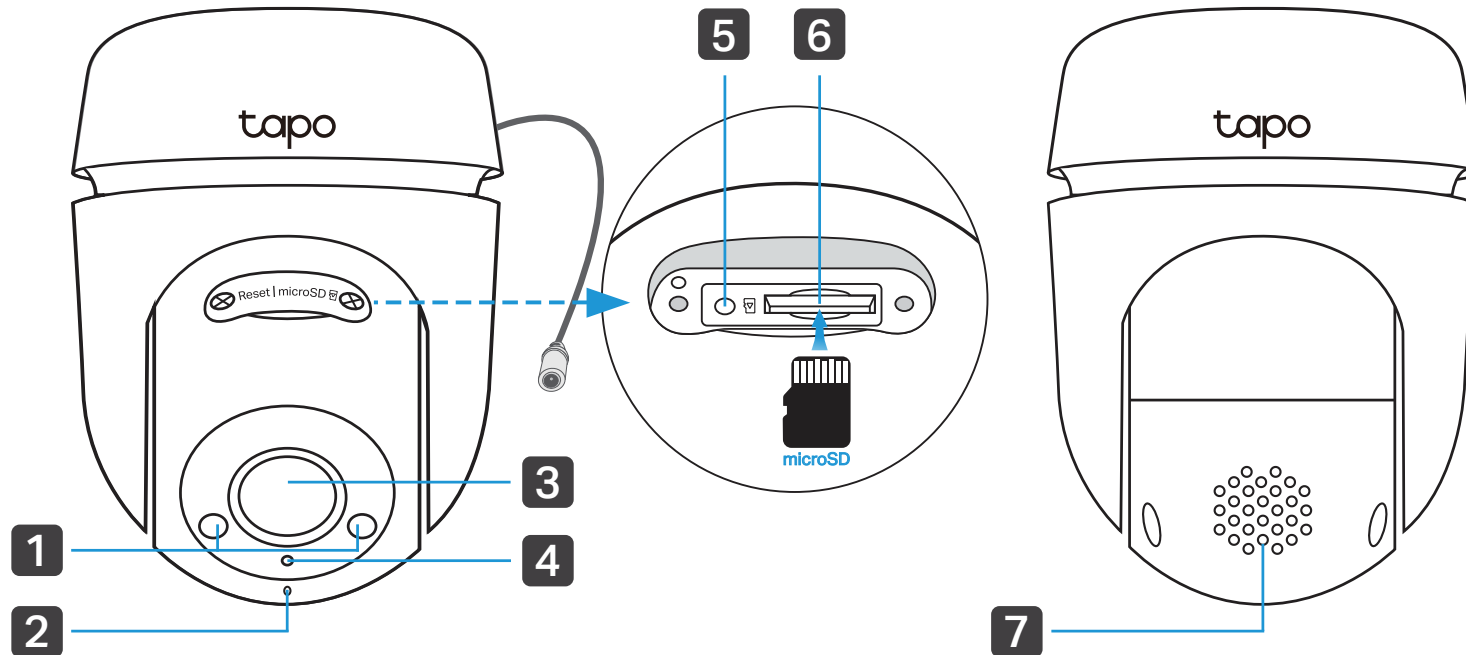

1 IR LEDs

2 Microphone

3 Lens

4 System LED

5 Reset

Use a pin to press and hold for 5 seconds to reset the camera.

6 microSD Card Slot

Insert a microSD card* for local recording.

*microSD card not included.

7 Speaker

System LED Indication

Solid red	Starting up
Blinking red and green	Ready for setup
Blinking red slowly	Connecting to Wi-Fi
Solid amber	Connected to Wi-Fi
Solid green	Connected to the cloud
Blinking red quickly	Camera resetting
Blinking green quickly	Camera updating

Set Up Your Camera

Follow the steps below to get started with your new camera.

Step 1. Download Tapo App

Get the Tapo app from the App Store or Google Play, or by scanning the QR code below.



OR



Step 2. Log In

Open the app, and log in with your TP-Link ID. If you don't have an account, create one first.

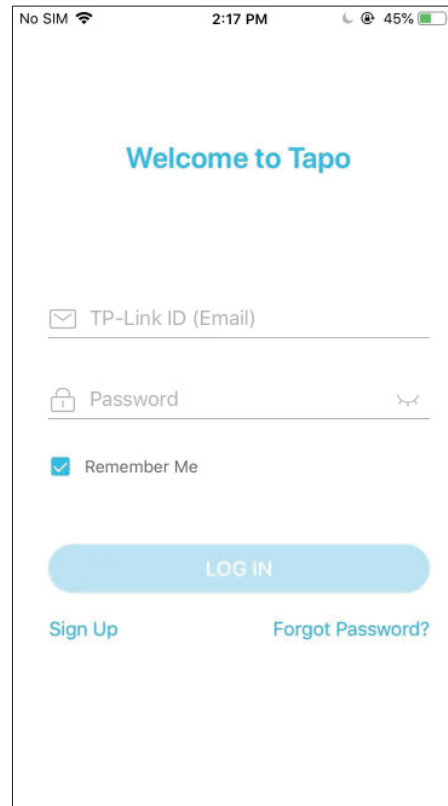

Step 3. Add Your Camera

Tap the ⊕ button in the app and select your model. Follow app instructions to complete the setup.

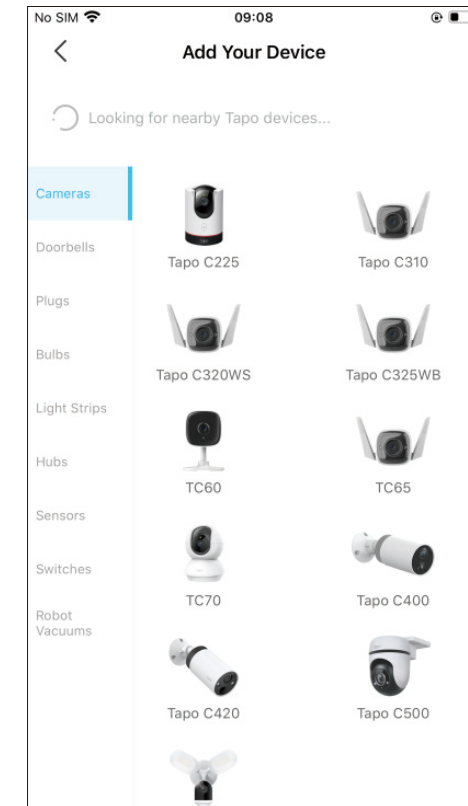

Set Up Using Amazon Frustration-Free Setup

What is Amazon Frustration-Free Setup?

Amazon Frustration-Free Setup can help connect and set up Tapo smart devices in fewer steps, without having to remember and re-enter your Wi-Fi password on each device.

To use this feature, confirm the following:

- The new Tapo device supports Amazon FFS.
- The new Tapo device is purchased from Amazon.
- You have an Amazon FFS enabled Alexa device or router.
- You have saved your Wi-Fi information to Amazon by using Alexa echo.
- Your Tapo device and router are on the same network as your Alexa echo.

LED Indications during Amazon Frustration-Free Setup

LED	Status
Blinking red and green	Ready for setup
Blinking amber	FFS setup in progress
Solid green	Working properly

If the LED does not turn solid green after a long time, you can try to add the Tapo device manually. (Press the Reset button on your Tapo device once. Then open the Tapo app, tap the + button on the page, select your device model, and follow the app instructions.)

How to use Amazon Frustration-Free Setup with Tapo devices

1. Open the Amazon Alexa app. Then tap [More](#) and select [Skills & Games](#).

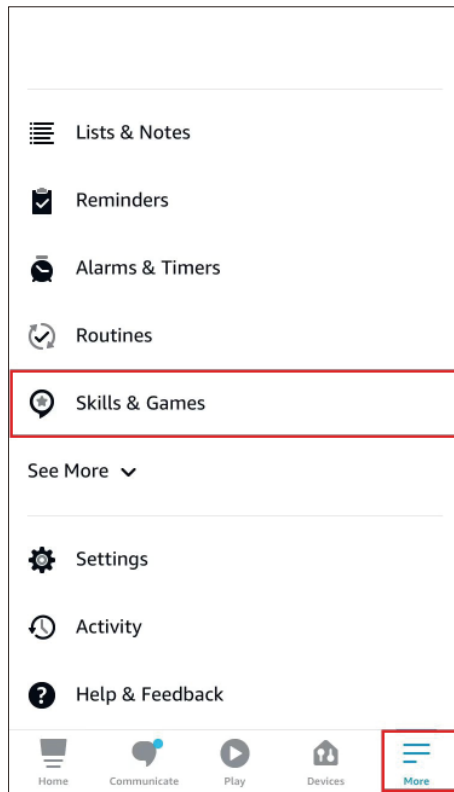

2. Enter [Tapo](#) in the search bar and choose [Tapo](#).

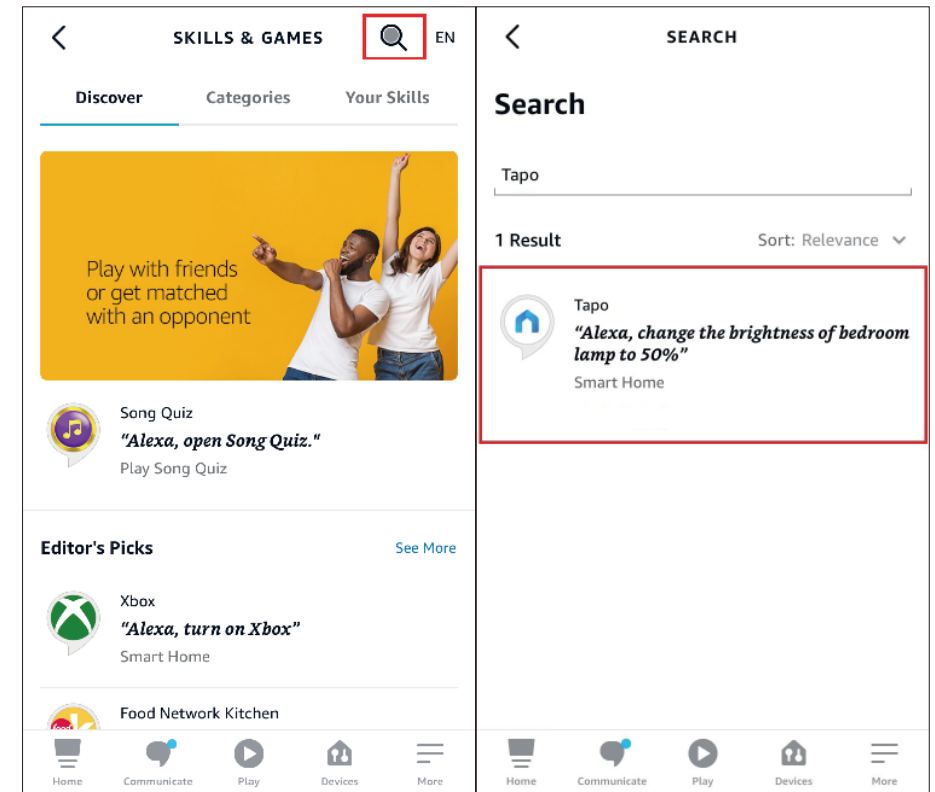

3. Tap the **ENABLE TO USE** button.

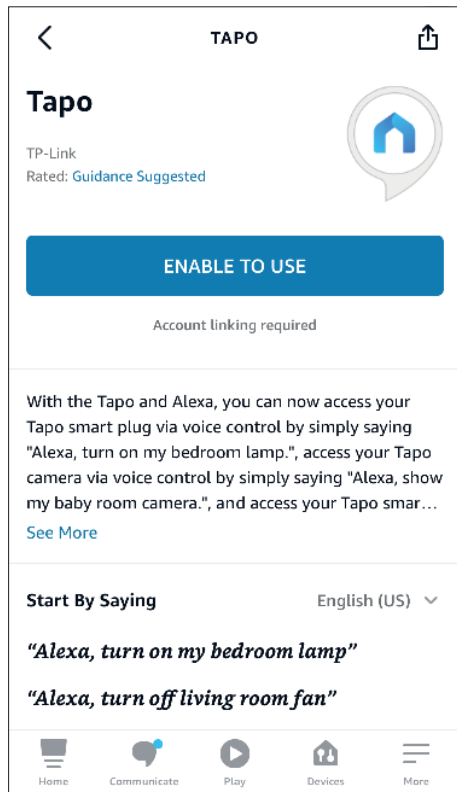

4. Log in with your TP-Link ID that has bound to your Tapo device, and tap **Authorize**. After authorized successfully, the message **Tapo has been successfully linked** will come up.

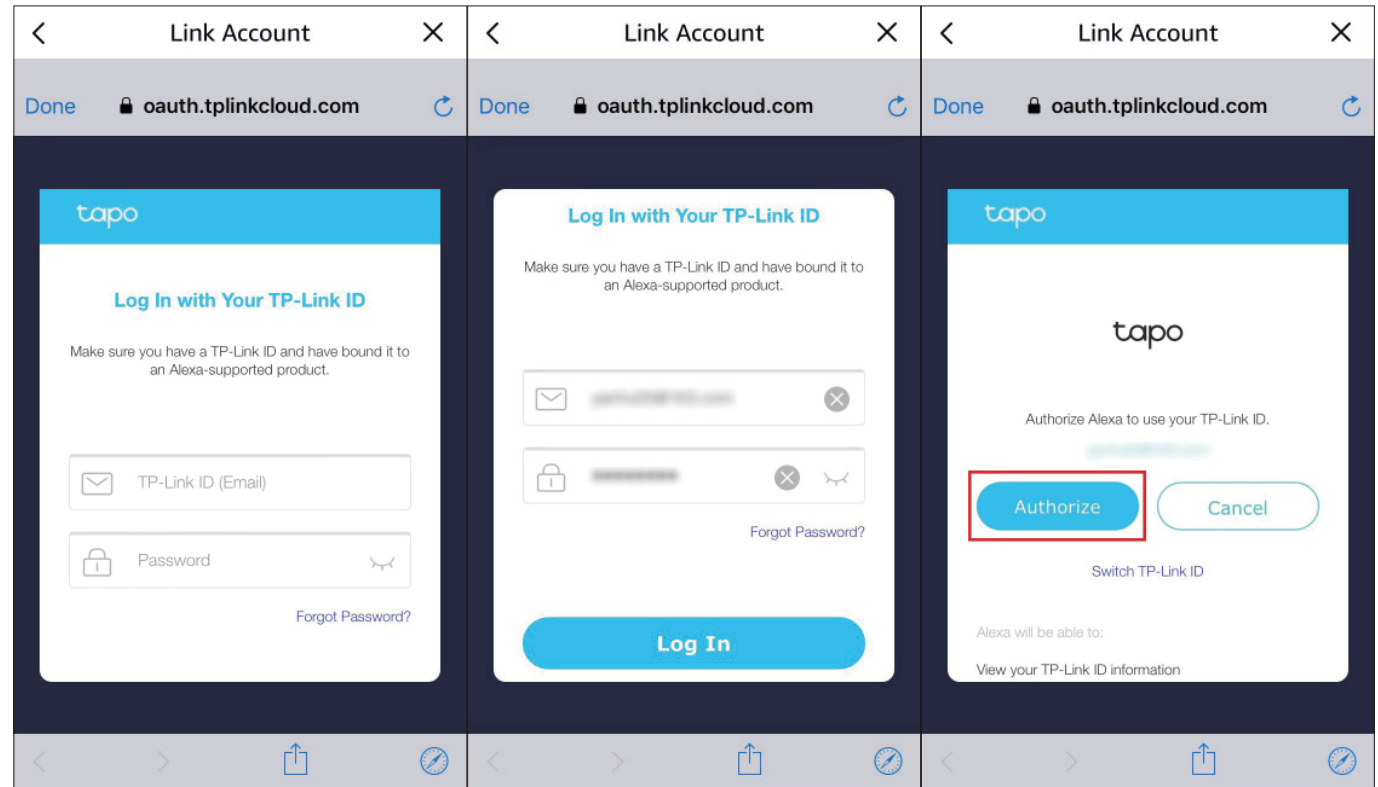

5. Plug in your Tapo device and the setup will complete automatically in two minutes.

For setting up more Tapo devices, just plug in and enjoy!

Done!

If this device displays on the Home page in the Tapo app, it indicates this device has been successfully associated with your Amazon account and joined your Wi-Fi network automatically.

If this device does not display on the Home page in the Tapo app, try setting it up manually. (Tap the + button on the page, select your device model, and then follow the app instructions.)

Install a microSD Card

Follow the steps below to install the microSD card for local recording.

You can go to [Camera Settings](#) > [microSD Card](#) in the Tapo app to check the card status or format your card.

1. Manually rotate the camera downwards. Loosen the screws on the panel and remove the cover.

2. Identify the direction of the microSD card and carefully insert the card into the slot. Push in the card until you hear a clicking sound.

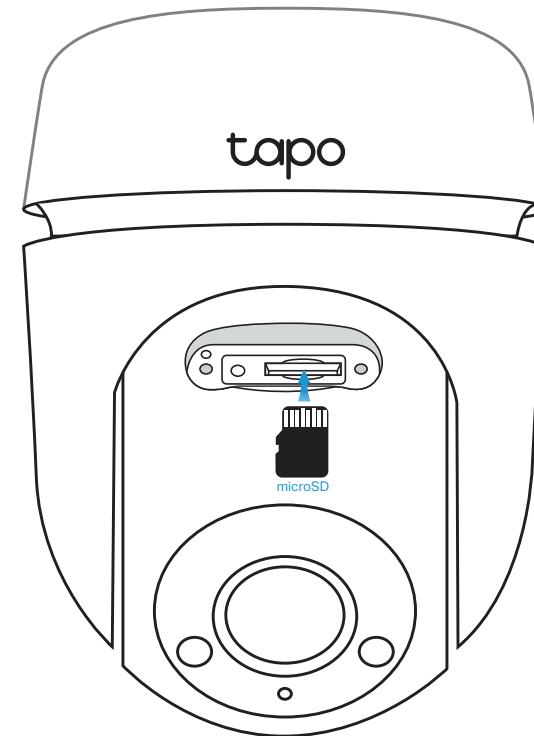
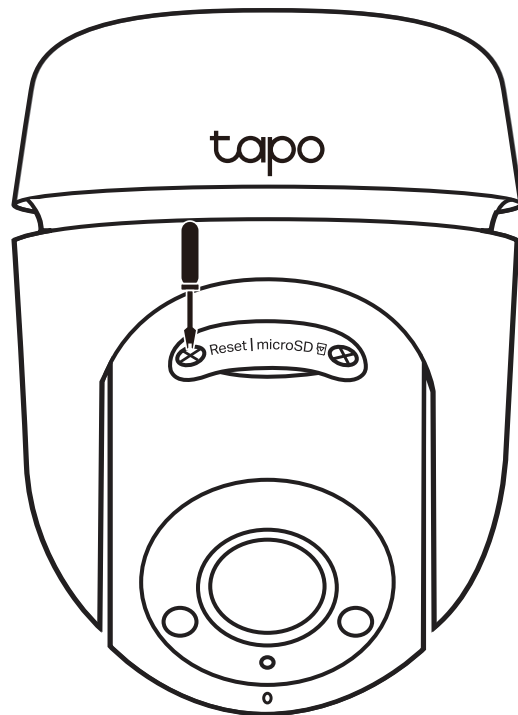

Mount Your Camera

When you finish adding your camera in the Tapo app, you can mount it on a wall or ceiling with the provided mounting template and screws. You can also mount it on the pole with mounting loops. Follow the steps below to mount your new camera.

■Note: The camera is not waterproof when set on a table or shelf. Mount the camera via Option 1 or Option 2 when installing outdoors.

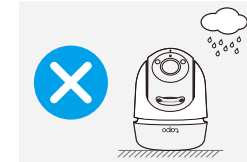

Option 1: Wall Mount or Overhang Mount

1. Drill Holes

Stick the mounting template to the desired mounting place. Drill four screw holes according to the template.

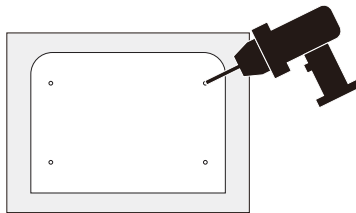

2. Mount Camera Bracket

Route the power cord through the opening of the camera bracket. Insert four mounting anchors into the holes and use the mounting screws to affix the bracket over the anchors.

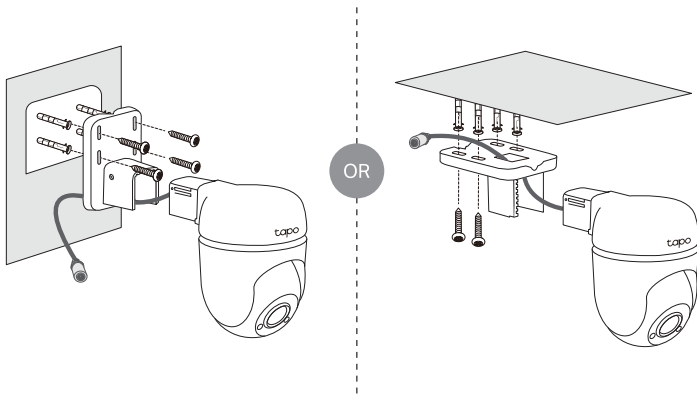

3. Install Camera

Install the camera on the bracket. Use two bracket screws to affix the bracket and the camera.

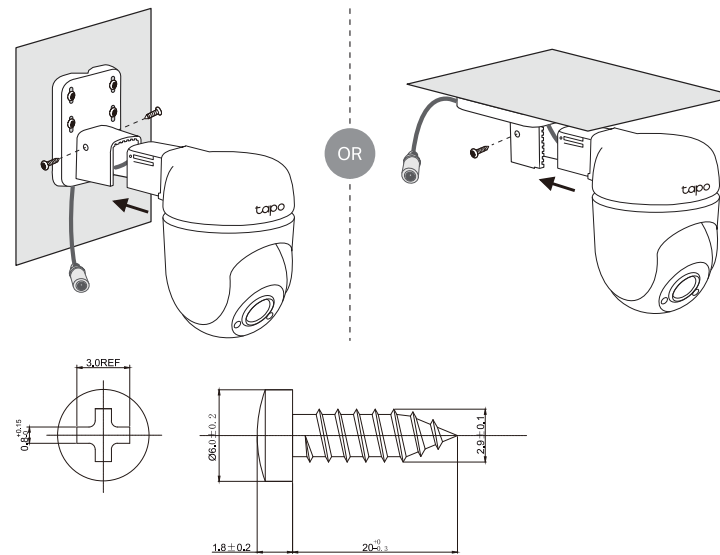

4. Connect to Power

Connect the camera to a power outlet using the provided power adapter. Install the waterproof seal for the power connectors.

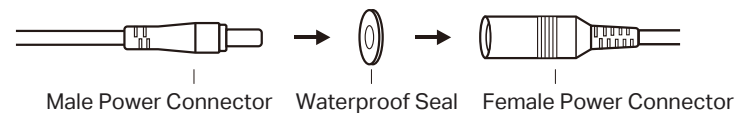

Option 2: Pole Mount

1. Mount Camera Bracket

Route the power cord through the opening of the camera bracket. Mount the camera on the pole using two pole-mounting loops* (loop width $\leq 12\text{mm}$).

*Pole-mounting loops are not included. Prepare the required accessories for pole mounting in advance.

2. Install Camera

Install the camera on the bracket. Use two bracket screws to affix the bracket and the camera.

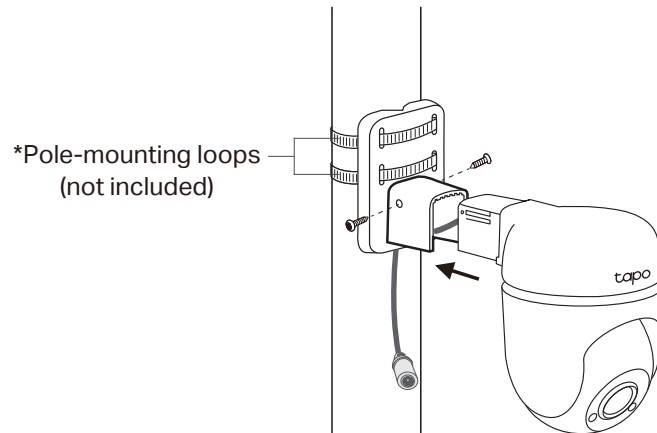

3. Connect to Power

Connect the camera to a power outlet using the provided power adapter. Install the waterproof seal for the power connectors.

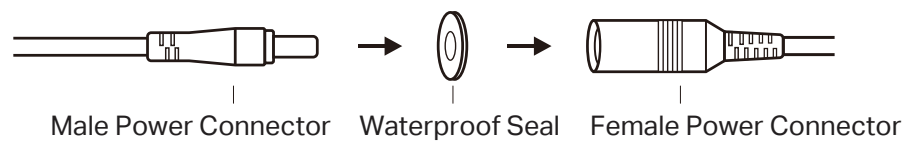

Install Waterproof Items

When the camera is installed outdoors, please install waterproof items to waterproof your camera. Make sure each part is securely attached and the water-proofing rings are flush to keep out water.

Follow the steps below to install waterproof items.

Install Waterproof Seal for Power Connectors

Connect the camera to a power outlet using the provided power adapter. Install the waterproof seal for the power connectors when the camera is installed outdoors.

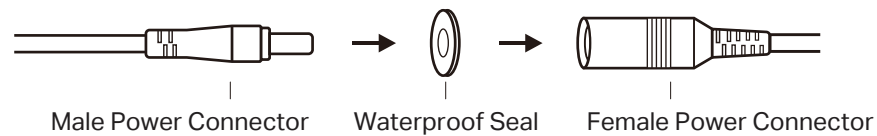

How to Reset Your Camera

Follow the steps below to reset your camera via the Reset button.

You can also go to [Camera Settings](#) in the Tapo app and tap [Remove Device](#) at the bottom to factory reset your camera.

1. Manually rotate the camera downwards. Loosen the screws on the panel and remove the cover.

2. Press and hold the Reset button for at least 5 seconds until the LED blinks red.

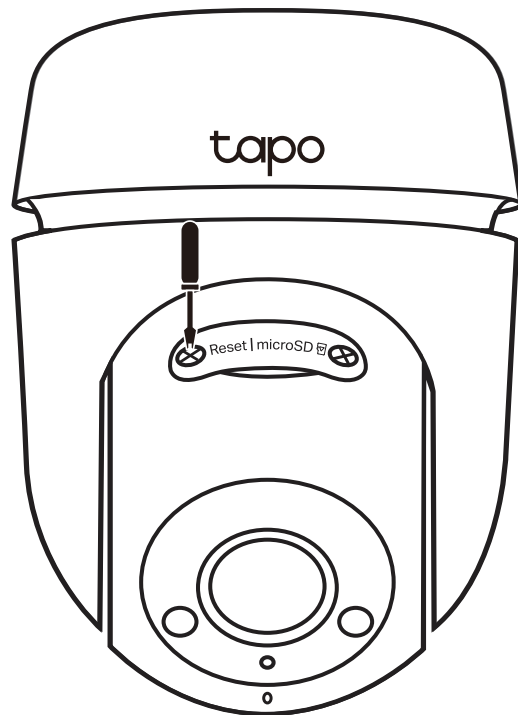

Authentication

FCC compliance information statement



Product Name: Outdoor Pan/Tilt Security Wi-Fi Camera

Model Number: Tapo C500

Component Name	Model
I.T.E. Power Supply	T120100-2B1

Responsible Party:

TP-Link USA Corporation

Address: 10 Mauchly, Irvine, CA 92618

Website: <http://www.tp-link.com/us/>

Tel: +1 626 333 0234

Fax: +1 909 527 6804

E-mail: sales.usa@tp-link.com

This equipment has been tested and found to comply with the limits for a Class B digital device, pursuant to part 15 of the FCC Rules. These limits are designed to provide reasonable protection against harmful interference in a residential installation. This equipment generates, uses and can radiate radio frequency energy and, if not installed and used in accordance with the instructions, may cause harmful interference to radio communications. However, there is no guarantee that interference will not occur in a particular installation. If this equipment does cause harmful interference to radio or television reception, which can be determined by turning the equipment off and on, the user is encouraged to try to correct the interference by one or more of the following measures:

- Reorient or relocate the receiving antenna.
- Increase the separation between the equipment and receiver.
- Connect the equipment into an outlet on a circuit different from that to which the receiver is connected.
- Consult the dealer or an experienced radio/ TV technician for help.

This device complies with part 15 of the FCC Rules. Operation is subject to the following two conditions:

1. This device may not cause harmful interference.
2. This device must accept any interference received, including interference that may cause undesired operation.

Any changes or modifications not expressly approved by the party responsible for compliance could void the user's authority to operate the equipment.

Note: The manufacturer is not responsible for any radio or TV interference caused by unauthorized modifications to this equipment. Such modifications could void the user's authority to operate the equipment.

FCC RF Radiation Exposure Statement

This equipment complies with FCC RF radiation exposure limits set forth for an uncontrolled environment. This device and its antenna must not be co-located or operating in conjunction with any other antenna or transmitter.

"To comply with FCC RF exposure compliance requirements, this grant is applicable to only Mobile Configurations. The antennas used for this transmitter must be installed to provide a separation distance of at least 20 cm from all persons and must not be co-located or operating in conjunction with any other antenna or transmitter."

We, **TP-Link USA Corporation**, has determined that the equipment shown as above has been shown to comply with the applicable technical standards, FCC part 15. There is no unauthorized change is made in the equipment and the equipment is properly maintained and operated.

Issue Date: 2023-01-11

FCC compliance information statement

Product Name: I.T.E. Power Supply

Model Number: T120100-2B1

Responsible Party:

TP-Link USA Corporation

Address: 10 Mauchly, Irvine, CA 92618

Website: <http://www.tp-link.com/us/>

Tel: +1 626 333 0234

Fax: +1 909 527 6804

E-mail: sales.usa@tp-link.com

This equipment has been tested and found to comply with the limits for a Class B digital device, pursuant to part 15 of the FCC Rules. These limits are

designed to provide reasonable protection against harmful interference in a residential installation. This equipment generates, uses and can radiate radio frequency energy and, if not installed and used in accordance with the instructions, may cause harmful interference to radio communications. However, there is no guarantee that interference will not occur in a particular installation. If this equipment does cause harmful interference to radio or television reception, which can be determined by turning the equipment off and on, the user is encouraged to try to correct the interference by one or more of the following measures:

- Reorient or relocate the receiving antenna.
- Increase the separation between the equipment and receiver.
- Connect the equipment into an outlet on a circuit different from that to which the receiver is connected.
- Consult the dealer or an experienced radio/ TV technician for help.

This device complies with part 15 of the FCC Rules. Operation is subject to the following two conditions:

1. This device may not cause harmful interference.
2. This device must accept any interference received, including interference that may cause undesired operation.

Any changes or modifications not expressly approved by the party responsible for compliance could void the user's authority to operate the equipment.

We, **TP-Link USA Corporation**, has determined that the equipment shown as above has been shown to comply with the applicable technical standards, FCC part 15. There is no unauthorized change is made in the equipment and the equipment is properly maintained and operated.

Issue Date: 2023-01-11

CE Mark Warning



This is a class B product. In a domestic environment, this product may cause radio interference, in which case the user may be required to take adequate measures.

OPERATING FREQUENCY (the maximum transmitted power)

2412MHz—2472MHz (20dBm)

EU Declaration of Conformity

TP-Link hereby declares that the device is in compliance with the essential requirements and other relevant provisions of directives 2014/53/EU, 2009/125/EC, 2011/65/EU and (EU)2015/863.

The original EU Declaration of Conformity may be found at <https://www.tapo.com/en/support/ce/>.

RF Exposure Information

This device meets the EU requirements (2014/53/EU Article 3.1a) on the limitation of exposure of the general public to electromagnetic fields by way of health protection.

The device complies with RF specifications when the device used at 20 cm from your body.

UKCA Mark



UK Declaration of Conformity

TP-Link hereby declares that the device is in compliance with the essential requirements and other relevant provisions of the Radio Equipment Regulations 2017.

The original UK Declaration of Conformity may be found at <https://www.tapo.com/support/ukca/>.

Canadian Compliance Statement

This device contains licence-exempt transmitter(s)/receiver(s) that comply with Innovation, Science and Economic Development Canada's licence-exempt RSS(s). Operation is subject to the following two conditions:

1. This device may not cause interference.
2. This device must accept any interference, including interference that may cause undesired operation of the device.

L'émetteur/récepteur exempt de licence contenu dans le présent appareil est conforme aux CNR d'Innovation, Sciences et Développement économique Canada applicables aux appareils radio exempts de licence. L'exploitation est autorisée aux deux conditions suivantes :

1. l'appareil ne doit pas produire de brouillage;
2. l'utilisateur de l'appareil doit accepter tout brouillage radioélectrique subi, même si le brouillage est susceptible d'en compromettre le fonctionnement

Radiation Exposure Statement:

This equipment complies with IC radiation exposure limits set forth for an uncontrolled environment. This equipment should be installed and operated with minimum distance 20cm between the radiator & your body.

Déclaration d'exposition aux radiations:

Cet équipement est conforme aux limites d'exposition aux rayonnements IC établies pour un environnement non contrôlé. Cet équipement doit être installé et utilisé avec un minimum de 20 cm de distance entre la source de rayonnement et votre corps.

Industry Canada Statement

CAN ICES-3 (B)/NMB-3(B)



Korea Warning Statements:

당해 무선설비는 운용중 전파혼신 가능성이 있음.

NCC Notice & BSMI Notice

注意!

取得審驗證明之低功率射頻器材，非經核准，公司、商號或使用者均不得擅自變更頻率、加大功率或變更原設計之特性及功能。

低功率射頻器材之使用不得影響飛航安全及干擾合法通信；經發現有干擾現象時，應立即停用，並改善至無干擾時方得繼續使用。

前述合法通信，指依電信管理法規定作業之無線電通信。

低功率射頻器材須忍受合法通信或工業、科學及醫療用電波輻射性電機設備之干擾。

安全諮詢及注意事項

- 請使用原裝電源供應器或只能按照本產品注明的電源類型使用本產品。
- 清潔本產品之前請先拔掉電源線。請勿使用液體、噴霧清潔劑或濕布進行清潔。
- 注意防潮，請勿將水或其他液體潑灑到本產品上。
- 插槽與開口供通風使用，以確保本產品的操作可靠並防止過熱，請勿堵塞或覆蓋開口。
- 請勿將本產品置放於靠近熱源的地方。除非有正常的通風，否則不可放在密閉位置中。
- 不要私自拆開機殼或自行維修，如產品有故障請與原廠或代理商聯繫。
- 電源供應器應使用在環境溫度低於或等於40°C的室內。

限用物質含有情況標示聲明書

設備名稱：Outdoor Pan/Tilt Security Wi-Fi Camera		型號（型式）：Tapo C500				
Equipment name		Type designation (Type)				
單元 Unit	限用物質及其化學符號 Restricted substances and its chemical symbols					
	鉛 Lead (Pb)	汞 Mercury (Hg)	鎘 Cadmium (Cd)	六價鉻 Hexavalent chromium (Cr ⁺⁶)	多溴聯苯 Polybrominated biphenyls (PBB)	多溴二苯醚 Polybrominated diphenyl ethers (PBDE)
PCB	○	○	○	○	○	○
外殼	○	○	○	○	○	○

電源供應器	—	○	○	○	○	○
其他及其配件	—	○	○	○	○	○

備考 1. “超出 0.1 wt %” 及 “超出 0.01 wt %” 係指限用物質之百分比含量超出百分比含量基準值

Note 1: “Exceeding 0.1 wt %” and “exceeding 0.01 wt %” indicate that the percentage content of the restricted substance exceeds the reference percentage value of presence condition.

備考 2. “○” 係指該項限用物質之百分比含量未超出百分比含量基準值。

Note 2: “○” indicates that the percentage content of the restricted substance does not exceed the percentage of reference value of presence.

備考 3. “—” 係指該項限用物質為排除項目。

Note 3: The “—” indicates that the restricted substance corresponds to the exemption.



Продукт сертифіковано згідно с правилами системи УкрСЕПРО на відповідність вимогам нормативних документів та вимогам, що передбачені чинними законодавчими актами України.









EAC

Safety Information

- Keep the device away from fire or hot environments. DO NOT immerse in water or any other liquid.
- Do not attempt to disassemble, repair, or modify the device. If you need service, please contact us.
- Do not use damaged charger or USB cable to charge the device.
- Do not use any other chargers than those recommended
- Do not use the device where wireless devices are not allowed.
- Adapter shall be easily accessible.
- Use only power supplies which are provided by manufacturer and in the original packing of this product. If you have any questions, please don't hesitate to contact us.
- Adapter should be used indoors where the ambient temperature is lower than or equal to 40°C.
- This product uses radios and other components that emit electromagnetic fields. Electromagnetic fields and magnets may interfere with pacemakers and other implanted medical devices. Always keep the product and its power adapter more than 15 cm (6 inches) away from any pacemakers or other implanted medical devices. If you suspect your product is interfering with your pacemaker or any other implanted medical device, turn off your product and consult your physician for information specific to your medical device.
- Operating Temperature: -30 °C ~ 60 °C (-22°F ~ 140°F)

Please read and follow the above safety information when operating the device. We cannot guarantee that no accidents or damage will occur due to improper use of the device. Please use this product with care and operate at your own risk.

Explanation of the symbols on the product label

Symbol	Explanation
	Alternating current
	DC voltage
	Caution
	Operator's manual
	Class II equipment
	Polarity of output terminals
	Energy efficiency Marking
	Indoor use only
	<p>RECYCLING</p> <p>This product bears the selective sorting symbol for Waste electrical and electronic equipment (WEEE). This means that this product must be handled pursuant to European directive 2012/19/EU in order to be recycled or dismantled to minimize its impact on the environment.</p> <p>User has the choice to give his product to a competent recycling organization or to the retailer when he buys a new electrical or electronic equipment.</p>