

User Manual

English

6165 Money Counting Scale

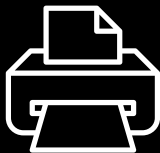

Print version

[Click here](#) to open a printable version of the manual in the selected language.

1. Package content

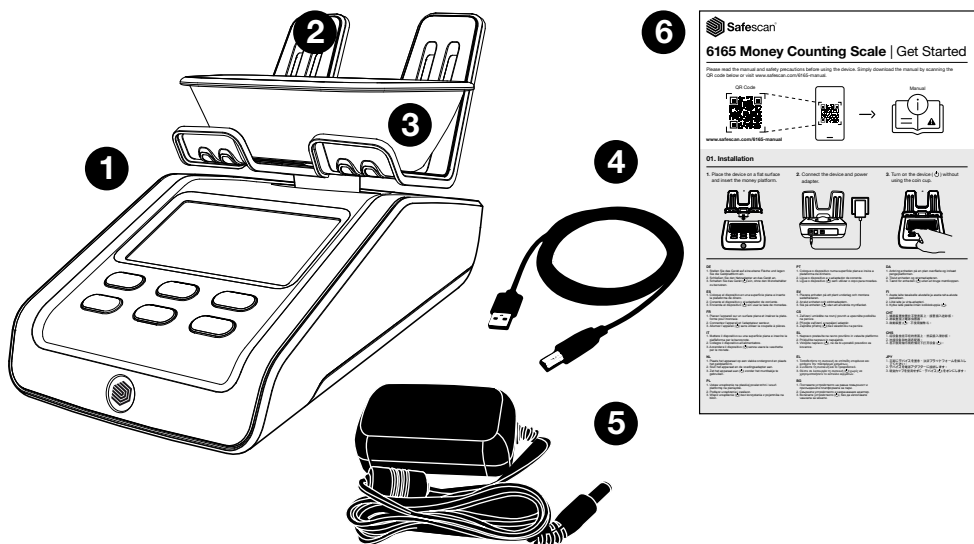

1. Safescan 6165 Money Counting Scale
2. Money platform
3. Coin cup
4. USB PC connection cable
5. Power adapter (12V/0.5A, 6 Watt)
6. Get started leaflet/Safety instructions

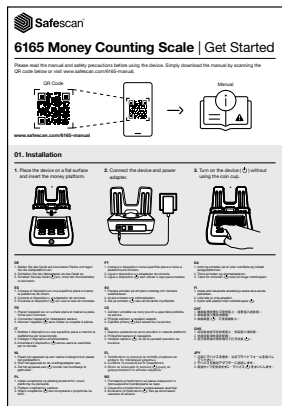

2. Device

Front

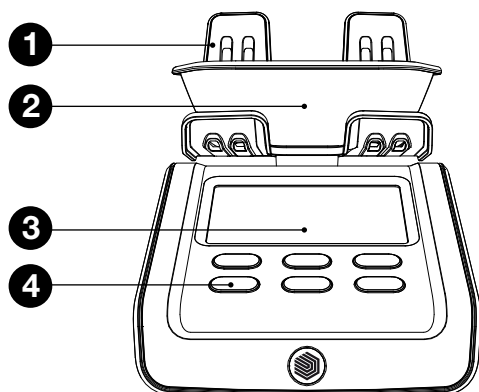

Bottom

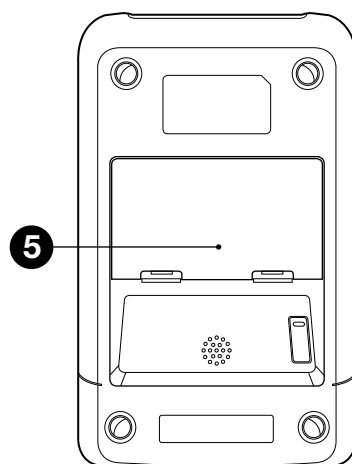

Back

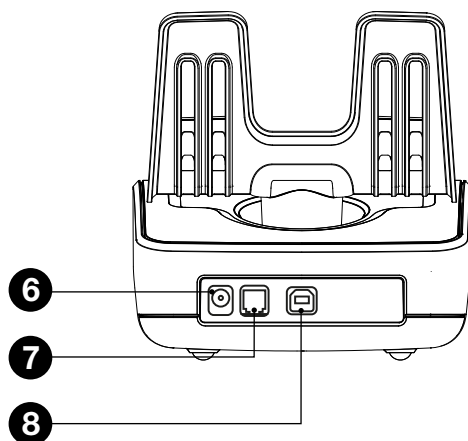

1. Money platform
2. Coin cup
3. LCD display
4. Control keys
5. Battery compartment
6. Power connector
7. Printer connector
8. USB port for connection to PC

3. Display and buttons

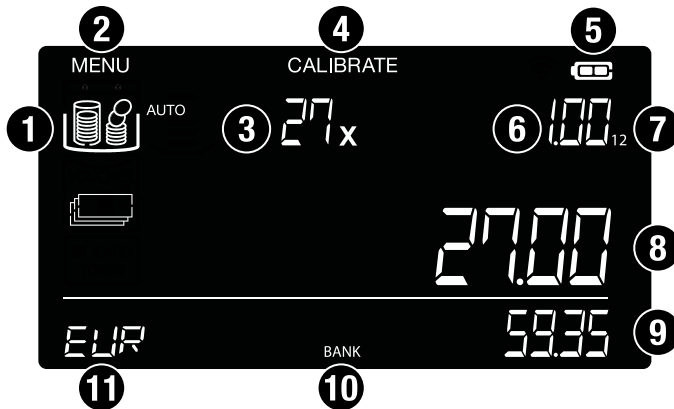

1. Cash value items (coins, banknotes and other count items)
2. Settings menu
3. Quantity
4. Calibration menu
5. Battery level indicator
6. Denomination
7. Denomination version
8. Current value / value on platform
9. Total value
10. Active bank
11. Currency

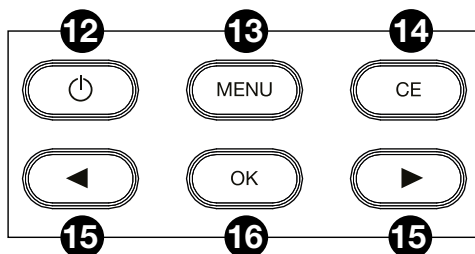

12. Power ON / OFF
13. Open settings menu
14. Clear entry / back
15. Navigation
16. Confirm selection / Add value to total

4. First time use

4.1. Installation

1. Place the device on a flat surface and insert the money platform.

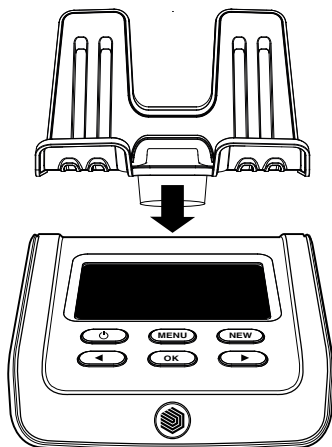

2. Connect the device and power adapter.

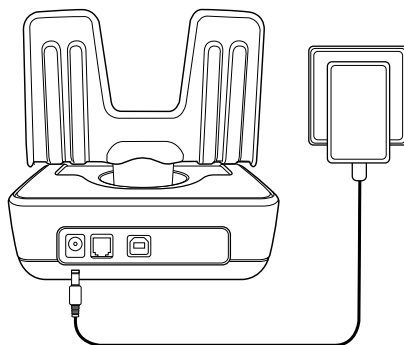

3. Turn on the device (⏻) without using the coin cup.

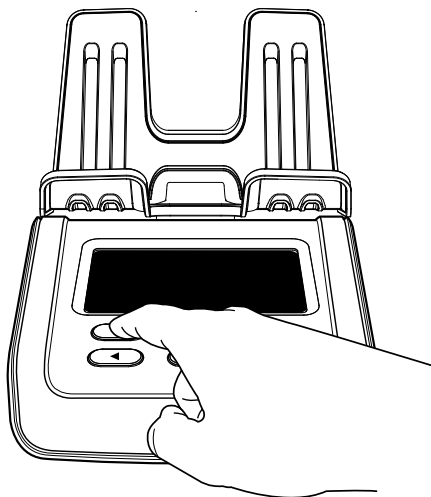

4.2. Set region (location of use)

1. Once your device is powered on, please select the region / location where it will be used.
2. Use the arrow keys (◀ ▶) to switch between the different available regions (**EUROPE**, **UK**, **USA**, **S-E ASIA** and **AUSTRALIA**).

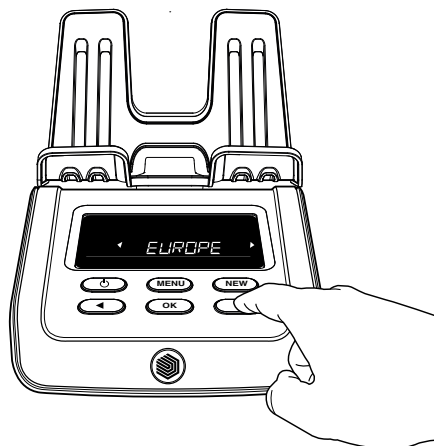

3. Once you have selected the correct region, press **“OK”**.

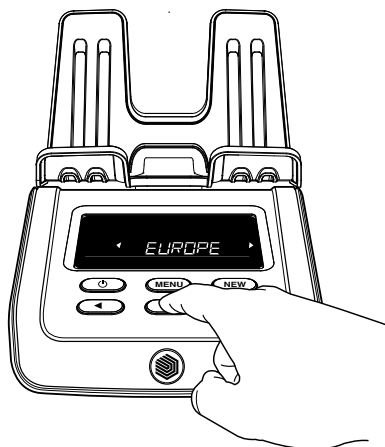

4.3. Select currency

1. Next, use the arrow keys (◀▶) to select your default currency and press “OK” to save your preference.
2. The device will now activate the counting mode so you can start counting, starting with the smallest denomination.

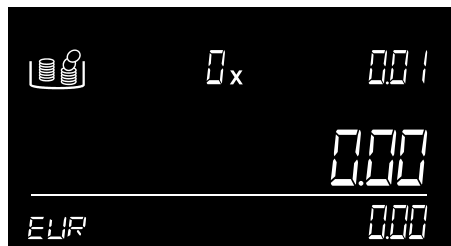
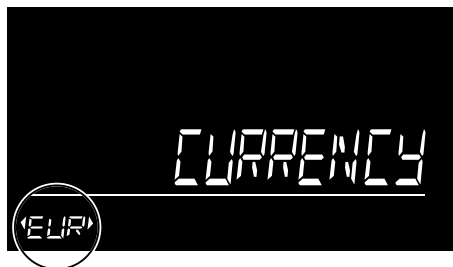

5. Counting instructions

Note: Count one denomination at a time. For efficient counting, please make sure that coins and banknotes have been sorted beforehand. Always use the coin cup when counting coins.

5.1. Counting coins

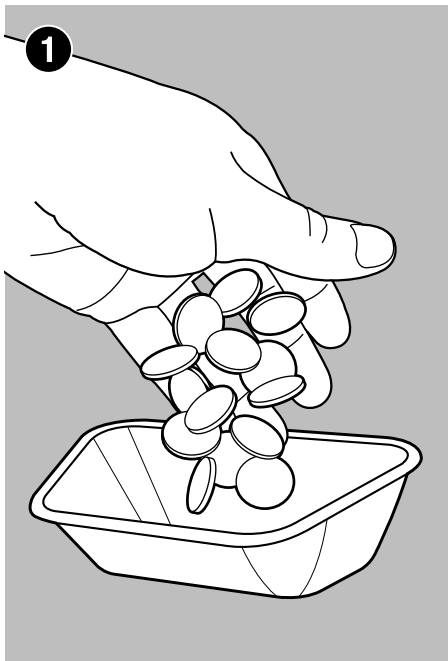

Place the coins in the supplied coin cup.



Place the coin cup onto the platform.



The quantity and value of the coins will be displayed. When the device has finished the count, you will hear a beep to confirm.

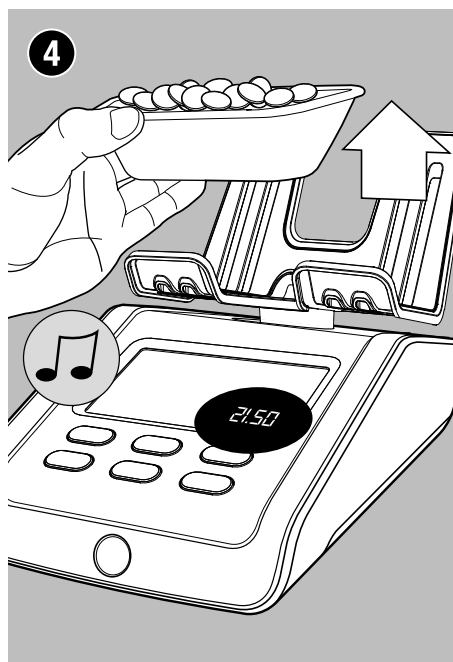

Take the coin cup from the platform. The counting result will be added to the total, you will hear a beep to confirm.

The 6165 will automatically switch to the next coin denomination. Alternatively, use the (◀▶) buttons to select a denomination. After the highest value coin denomination has been counted, the 6165 will automatically switch to the lowest value banknote denomination.

5.2. Counting banknotes

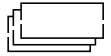

Place the banknotes in small batches (max. 25 notes) on the money platform.

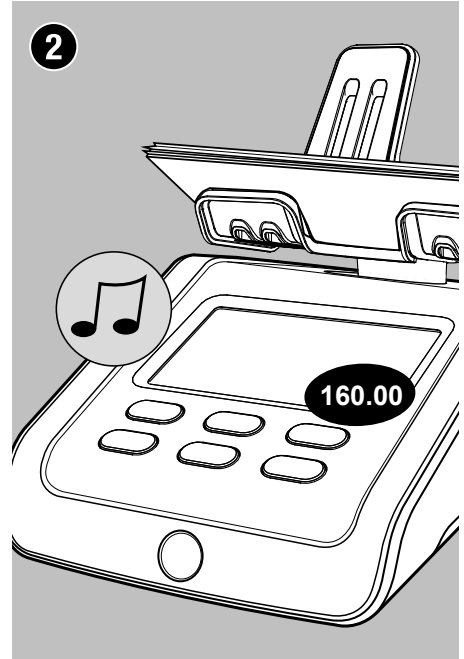

You will hear a beep to confirm that the banknotes have been counted. The display then shows the total number and value of banknotes and adds the value to the total.



Leave the first stack on the money platform and add the next stack of the same denomination. Continue adding stacks until all banknotes of the selected denomination have been counted.



Remove all banknotes simultaneously from the platform. You will hear a beep to confirm that the banknotes have been counted. Their value will be added to the total. The 6165 will automatically switch to the next banknote denomination.

1. Too many banknotes on the platform



Too many banknotes have been placed on the platform. The display shows “**Remove** ..-.. pcs”. Remove as many banknotes as suggested until the 6165 has been able to determine the amount of banknotes. Continue to add more banknotes on the platform in small batches.

2. Illogical weight detected



Illogical weight detected: the 6165 is not able to determine the correct amount of banknotes on the platform. The display shows “**Remove Some**”. Remove a few banknotes (max. 5 notes at a time) until the 6165 has been able to determine the amount of banknotes. Continue to add more banknotes on the platform in small batches.

5.3. Counting old and new versions of the same denomination

If the weight difference between an old and new version of a banknote is within a certain limit, the versions can be counted together. There is no need to sort them first. Please do note the following:

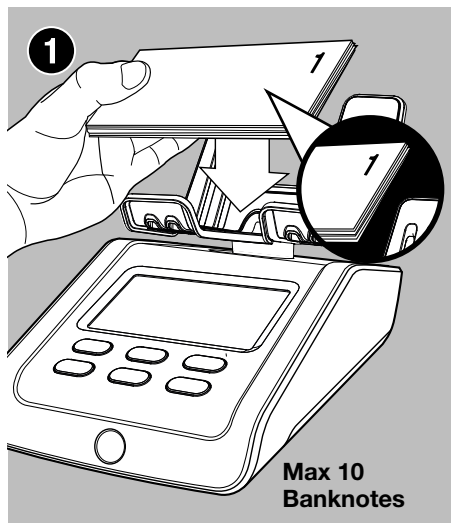

The first stack of mixed notes (old & new version together) that is placed on the platform should not exceed 10 banknotes.

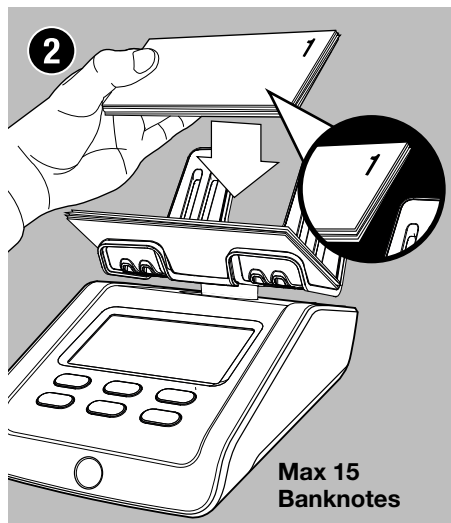

Following stacks should not exceed 15 banknotes.

If the weight difference between the different versions is not within the limit, the Safescan 6165 may ask you to count them separately.

The versions are indicated on the display.

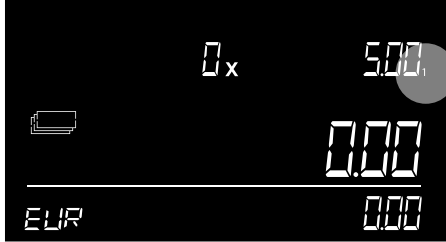

Version 1 is the old version

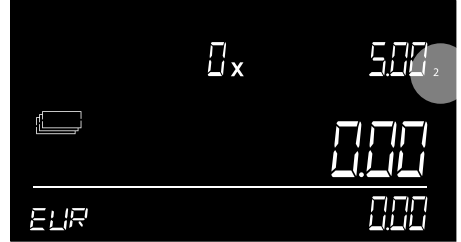

Version 2 is the new version.

Whenever a new version or denomination of a pre-installed currency is released, you can update the Safescan 6165 for free by downloading a currency update from **www.safescan.com**.

5.4. Counting coin rolls

Only place complete coin rolls on the money platform. This means that the coinroll contains the correct amount of coins and that these coins are all from the same denomination and currency.

Coin roll weights of **EUR**, **GBP** and **USD** are pre-calibrated on the device. Coin roll weights for other currencies can be calibrated manually. Please see chapter 4.2.6. how to calibrate coin rolls.

5.4.1. Counting coin rolls/bags with automatic coin roll recognition 'AUTO'

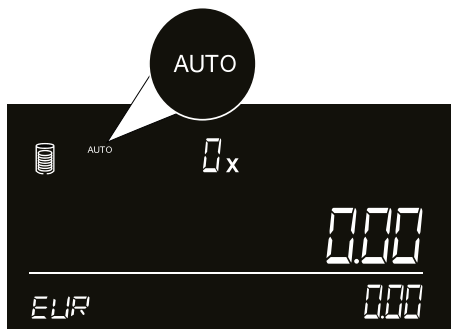

Automatic coin roll recognition will start directly after counting loose banknotes. In the screen the '**AUTO**' icon is shown.

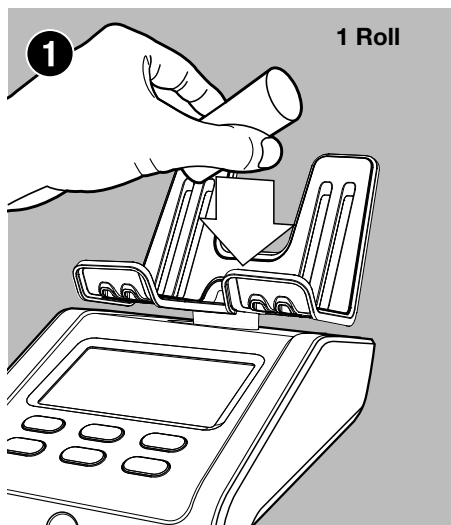

Place one complete coin roll of the selected currency on the money platform.

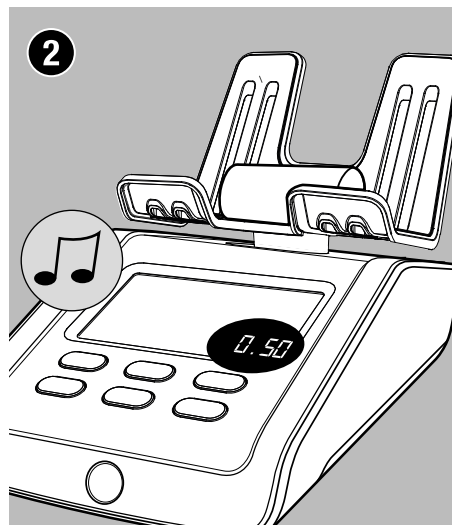

A beep sounds after confirming the coin roll. The quantity, value and roll-denomination will shortly be displayed (2 sec). After that, the total quantity and value of coin rolls will be shown.

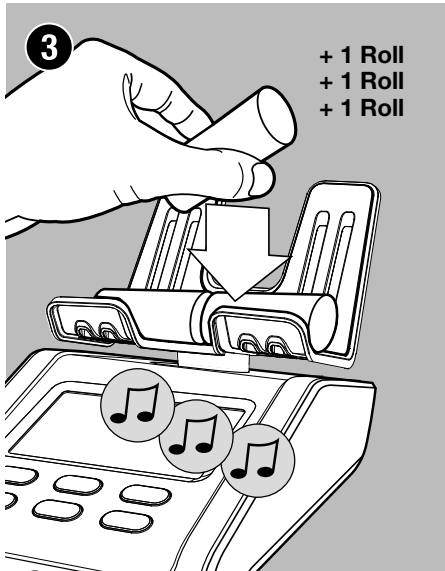

Add another coin roll on the platform and wait for the confirmation beep sound before you add the next coin roll. Repeat this process by adding coin rolls one by one until all coin rolls are on the platform and counted.

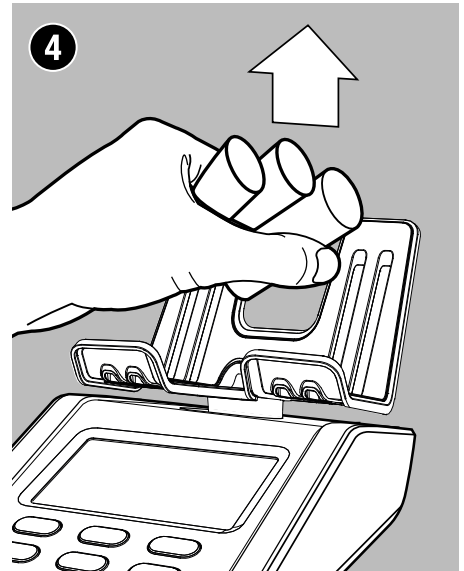

Remove all coin rolls from the money platform. The counting result will be added to the total.

5.4.2. Counting coin rolls / bags that are similar in weight

Some currencies have coin packages that are different in denomination but similar in weight. When such a package is detected the Safescan 6165 will give you the opportunity to select the correct denomination. Please see an example below of how to operate this function.



1. The device has detected a denomination package with a common weight. The message **"SELECT"** is shown and the arrows are blinking.



2. Use the (◀ ▶) buttons to select the denomination of the coin roll/bag which is placed on the platform.

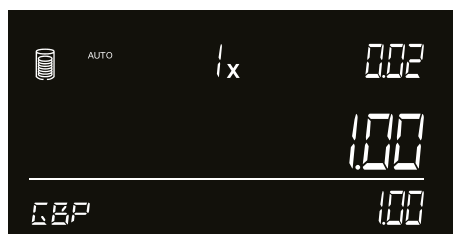

3. Press **"OK"** to confirm the coin roll/bag denomination. The device will add the counting results to the total.



4. After 2 seconds the denomination indication disappears. The device is ready to receive a next coin roll/bag.

5.4.3. Counting coin rolls/bags per denomination

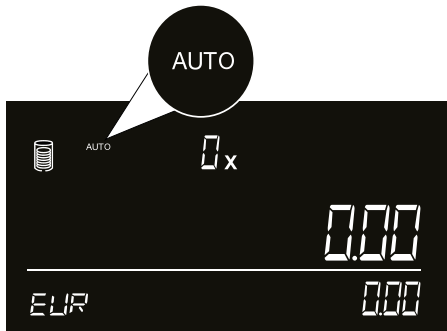

To count coin rolls per denomination, use (◀▶) buttons to select 'AUTO' coin rolls. Press "OK".

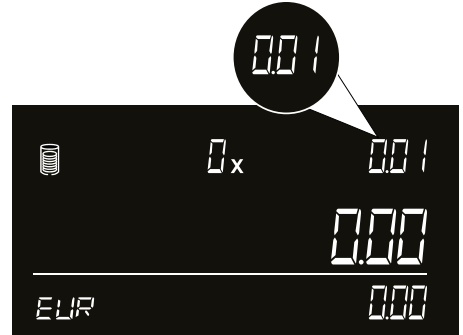

Use the (▶) button to select the first available coin roll denomination.

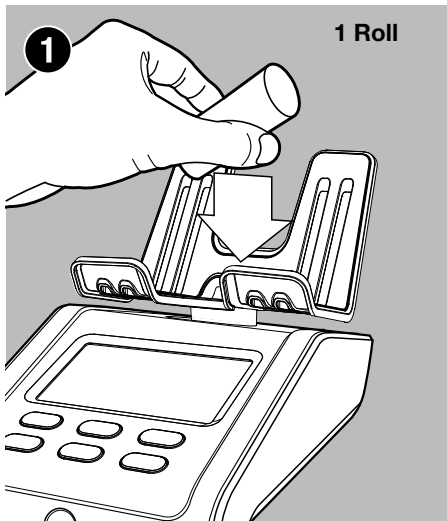

Place one complete coinroll of the selected denomination on the money platform.

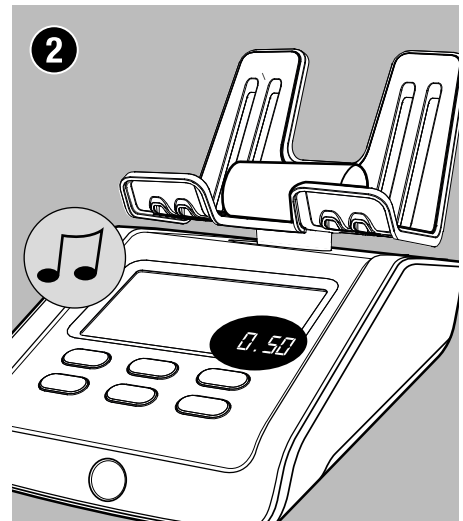

A beep sounds after confirming the coin roll. The quantity, value and roll-denomination is shown.

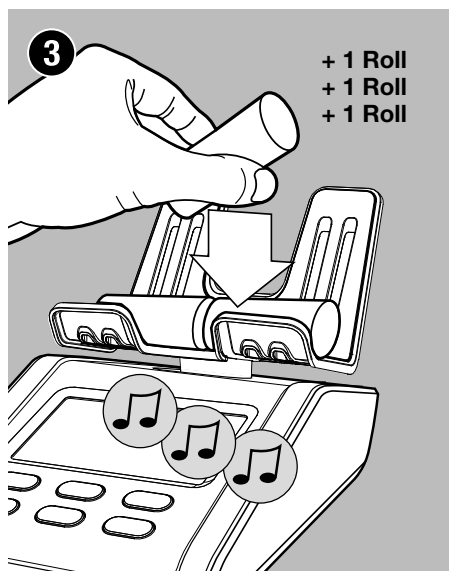

Add another coin roll of the selected denomination on the money platform and wait for the confirmation beep sound before you add the next coin roll. Repeat this process by adding coin rolls one by one until all coin rolls of this denomination are on the platform and counted.

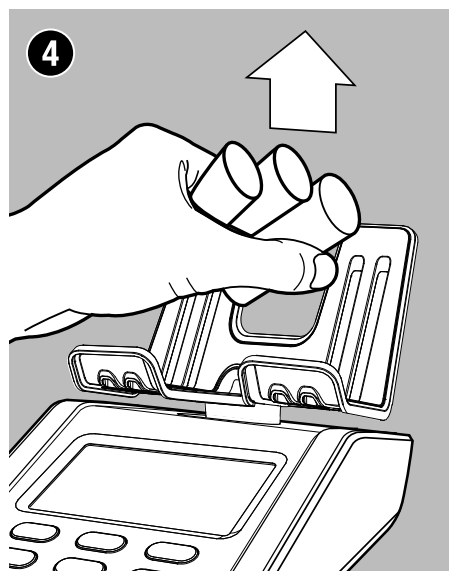

Remove all coin rolls from the money platform. The counting result will be added to the total. The device will automatically switch to the next coin roll denomination.

5.5. Ending a count

View current count results

To view the counting results of the coin rolls, use the (◀ ▶) buttons to select '**AUTO**' coin rolls and press "**OK**" to view the separate coin roll results.

Clear / Correct count results

At any time during a count you can clear or add counting results to a count item. Simply toggle to the item which needs to be changed using the (◀ ▶) buttons. From this point you can:

- Press "**CE**" to clear the count results of the selected count item.
When you want to clear the complete count, start a new count as described in the **MENU** items.
 - Add more of the selected count item to complete the counting.
-

Print count results

When you finished counting, you can print the results on the optional Safescan TP-230 printer, as described in the **MENU** items.

Export count results to Safescan MCS

Run the Money Counting Software on your PC and click on the Count Data icon to download the count data from the 6165 to the software. For more details, see the user manual of the Safescan Money Counting Software, which can be found on www.safescan.com

Start a new count

To start a new count, press **"MENU"**. The display will show **"NEW COUNT"**. Press **"OK"** to confirm.

6. Device menu and operation

This chapter describes the operation of the Safescan 6165, as well as the menu structure of the device.

6.1. General operation

When a certain action is required or when several options are possible, the (◀▶) buttons can be used to navigate. When navigation is possible or when a choice has to be made in the menu, the screen will show 2 blinking arrows. For example:

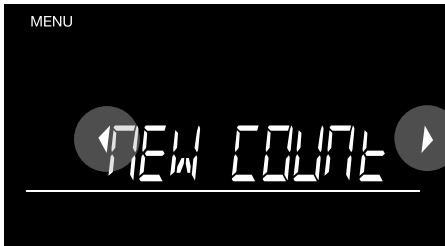

The 2 blinking arrows indicate that you can navigate between available menu items



The 2 blinking arrows indicate that you have to select a number.

A selection can be confirmed by pressing the “OK” button. To go 1 step back in the menu, press the “OK” button.

6.2. Menu structure

You can enter the device menu by pressing the **“MENU”** button. To navigate through the items, use the (◀▶) buttons. To enter a option, press **“OK”**. The structure of the menu is as follows:

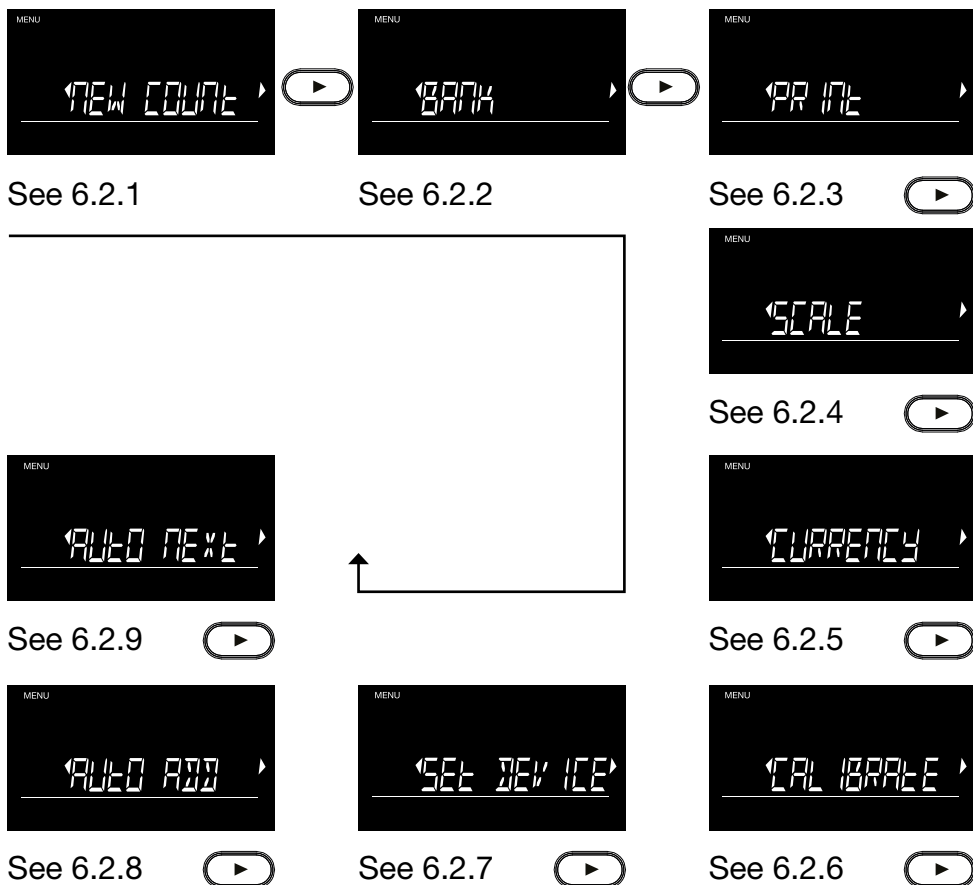

6.2.1. New count



When you want to start a new count and erase all existing results, press “OK” when the “NEW COUNT” screen is shown.

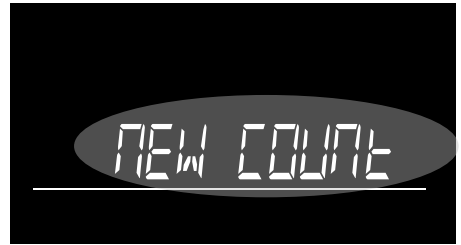

The text will start blinking. Press “OK” again to confirm.

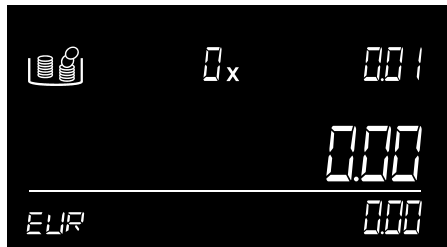

The machine will go back to the count screen, which is fully set back to zero.

6.2.2. Bank

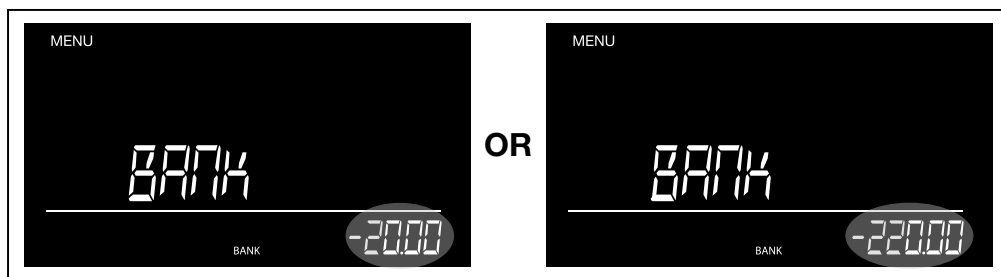

You can choose from the pre-set bank amounts by using (◀▶). Press **“OK”** to confirm.

For entering larger bank amounts, Press and hold (◀▶) buttons, the amount will go up automatically. Press **“OK”** to confirm.

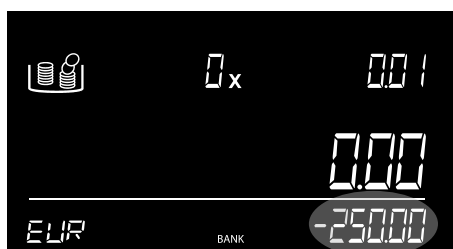

The count screen will show the set amount as negative start result.

6.2.3. Print



When you connect a Safescan TP-230 printer*, you can print your results by pressing “OK”.

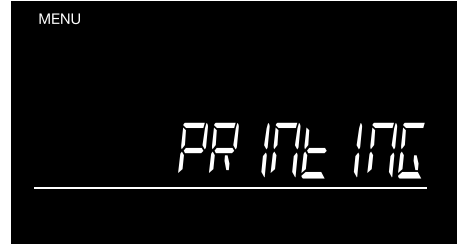

The screen will show “**PRINTING**”, while the printout is created.

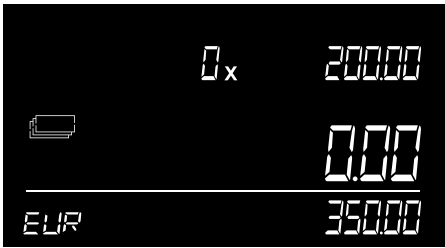

The machine will go back to the count screen.

6.2.4. Scale



To activate the weighing scale function, press “**OK**” .



The screen will now change to weighing mode.



You can now weigh items with an accuracy of 0.05 gram.

You can tare the weighing scale by pressing “**OK**” when the default item, like a cup, has been placed. A “*” will show in the screen and the value will change back to zero. Once the default item is removed, it's weight will show as a negative value.

6.2.5. Currency

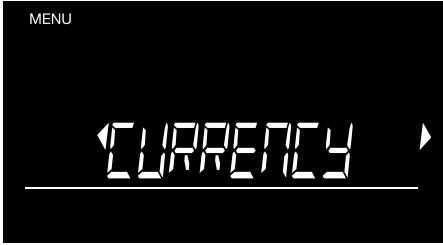

When you want to change the currency, press “OK” when the “CURRENCY” screen is shown.

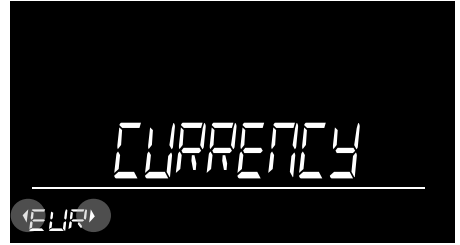

The active currency is now shown, with 2 blinking arrows. Use (◀ ▶) to navigate to the desired currency.

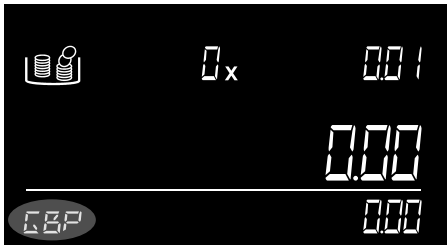

After pressing “OK”, the machine will now go back to the count screen, showing the chosen currency.

6.2.6. Calibrate coin rolls/bags, banknote bundles, second coin cup



The Safescan 6165 is also able to count coin rolls/bags, banknote bundles and a second coin cup. These first have to be calibrated on the 6165. To enter the calibration mode, press **“OK”** when the **“CURRENCY”** screen is shown. When in calibration mode, use the (◀▶) buttons to navigate to the desired denomination. If you want to switch to the next calibration item, press **“OK”**. The sequence is Coin Rolls - Banknote Bundles - Coin Cup.

The calibration process for each bundled item (coin rolls/bags or banknote bundles) is the same, and goes as follows:

Calibrate coin rolls/bags and banknote bundles

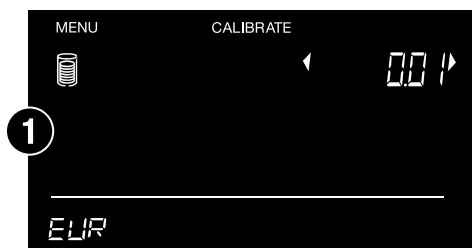

Example: For coin rolls. Move to the desired denomination with (◀▶) and confirm by pressing **“OK”**.



Now place 5 empty coin rolls onto the platform.



The machine will now ask you to confirm. Press **“OK”** to do so.



Remove the coin rolls to go to the next calibration step.



Select the number of coins that the rolls will contain by using the (◀▶) buttons and press **“OK”**.



Press **“OK”** to save. The roll has now been calibrated and is saved in the machine.

The calibration menu will now move to the next denomination. Repeat the process by selecting the desired denomination as shown above, or leave the calibration mode by pressing **“OK”**. If you want to switch to the next calibration item, use the **“OK”** button.

Calibrate a second coin cup

The Safescan 6165 is configured to count with standard 33.5 gr coin cups. Some cash drawer manufacturers however may have coin cups with a different weight. You can configure your Safescan 6165 to count using a second coin cup.

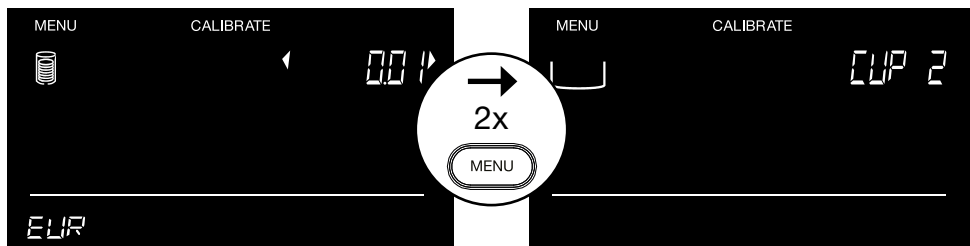

When pressing “OK”, you will be prompted to place the cup.



The machine will show that the cup weight has been processed.



Press “OK” to confirm the calibration.



The cup has now been calibrated.

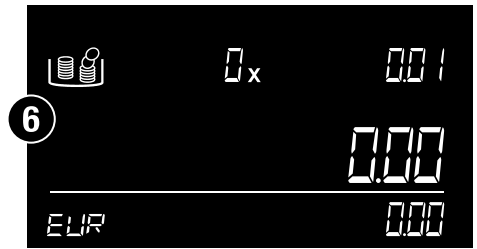
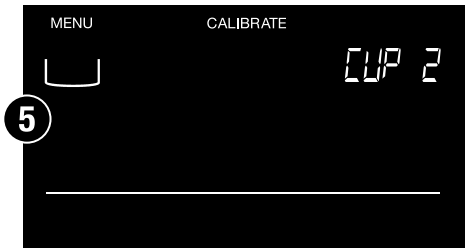

Press “OK” to return to the count screen.

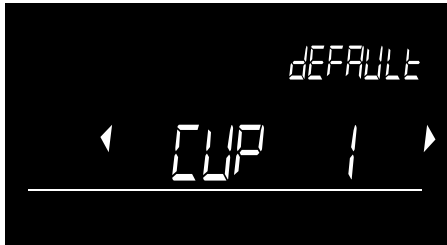

From now on, once you start up the Safescan 6165, you will be asked to confirm which cup has to be set as preference: the cup that comes with the device as a default (CUP 1) or the cup that was calibrated (CUP 2). Use the (◀ ▶) buttons to select the cup you want to set as preferred. The selection will be saved automatically.

6.2.7. Set device

When the **"SET DEVICE"** screen is shown, you can change several device settings. Press **"OK"** to enter this menu item. When in the **"SET DEVICE"** mode, use the (◀ ▶) buttons to navigate through the sub-items.

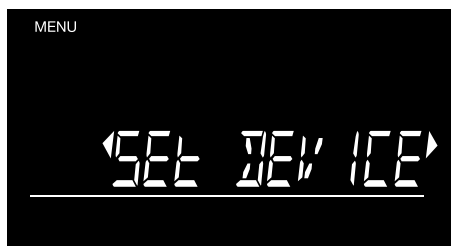

Submenu - structure

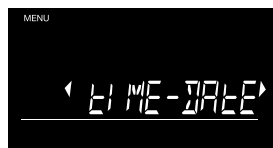

See 6.2.7 - A



See 6.2.7 - B

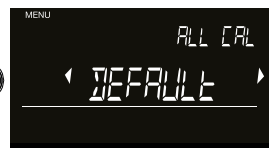

See 6.2.7 - C

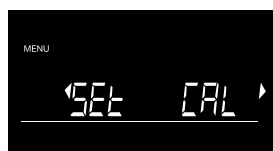

See 6.2.7 - E

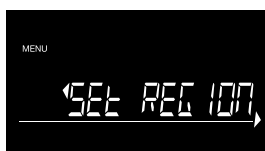

See 6.2.7 - D

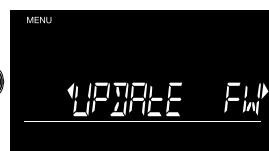

See 6.2.7 - C

A. Time and date setting



Press **“OK”** to start the **”TIME-DATE”** setting process.



Switch between 12 hour and 24 hour format by using (◀ ▶), and press **“OK”** to confirm.

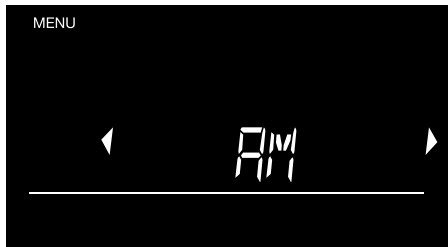

Switch between AM and PM by using (◀ ▶), and press **“OK”** to confirm.

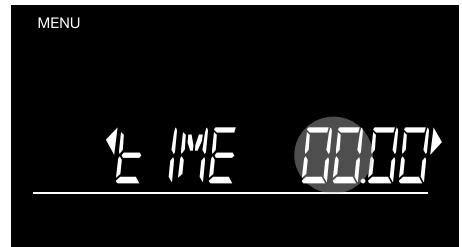

The HOURS now start blinking. Short press (◀ ▶) to go 1 hour up or down or press and hold to run through the hours. Press **“OK”** to confirm.



The MINUTES now start blinking. Short press(◀▶) to go 1 minute up or down or press and hold to run through the minutes. Press “OK” to confirm.



Navigate through the date formats by using (◀▶). Press “OK” to confirm the desired format. Now set year, month and day in the same way.

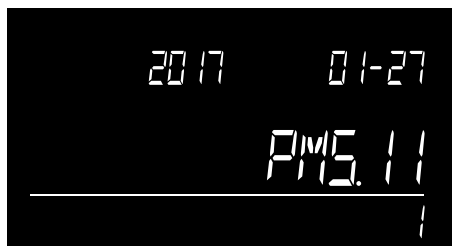

A short preview of the set time and date will be shown. The 6165 then returns to the submenu.

B. Back to factory default setting



Press “OK” to start resetting the machine. If you want to start fresh with your Safescan 6165, you can reset the device back to its factory default settings. Default: Reset to default settings while keeping user calibrations of coin packages. Default ‘All Cal’: Reset to default settings including user calibrations of coin packages.

WARNING: By selecting the Default ‘ALL CAL’ reset option, all customized settings such as calibrated items will be deleted and all basic settings will apply from the restart.

C. Update firmware



Press “OK” to set the device in firmware-update mode. Firmware updates (when applicable) are available via www.safescan.com. Download the firmware update package and follow the included instructions to update your 6165.

D. Region setting



Select the region where you will be using your Safescan 6165. Use the (◀ ▶) buttons to toggle between “**EUROPE**”, “**UK**”, “**USA**”, “**S-E ASIA**” and “**AUSTRALIA**”. Press “**OK**” to confirm.

E. Recalibrate loadcell

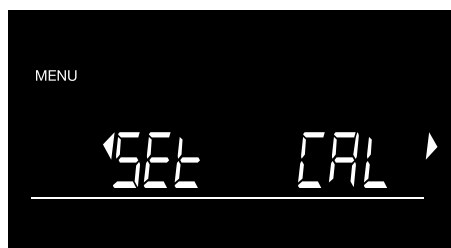

If because of an overload or impact on the money platform the function of the 6165 loadcell (weighing element) is damaged. Then a recalibration of the load cell could help to recover the function.

1. Press “**OK**” to start the recalibration process.
2. The device will start ‘taring’ and will proceed to ask to place a 500 gram weight* on the platform.
3. After placing the 500 gram weight the device will automatically start the calibration process. In the screen the text: “Sampling” is blinking.
4. When the process is done the device will display: Finished. Please remove the weight from the money platform. The device is now ready for usage.

* You can purchase a calibration weight of 500 grams on www.safescan.com. If you cannot find it on the website, please contact us.

6.2.8. Auto ADD

By activating the **AUTO ADD** function, the amount of a counted denomination is automatically added to the total counting result once the items are removed from the platform. When this function is switched off, you have to press “**OK**” to add the amount to the total. By default the **AUTO ADD** setting is ON.



To activate or de-activate the function, press “**OK**” when the **AUTO ADD** screen is shown.



Switch between **ON** and **OFF** by using (◀ ▶) and press “**OK**” to confirm.

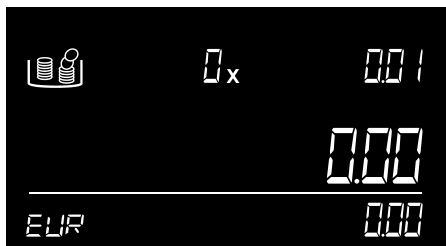

The machine will move back to the count screen.

6.2.9. Auto NEXT

By activating the **AUTO NEXT** function, the machine automatically switches to the next denomination once the items are removed from the platform. When this function is switched off, you have to use (▶) to move to the next denomination. By default the Auto Next setting is ON.



To activate or de-activate the function, press “OK” when the **AUTO NEXT** screen is shown.



Switch between **ON** and **OFF** by using (◀▶) and press “OK” to confirm.

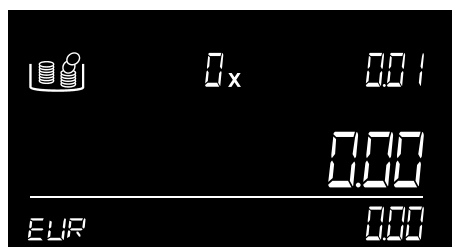

The machine will move back to the count screen.

7. Troubleshooting

This chapter describes the operation of the Safescan 6165, as well as the menu structure of the device.

Error message



Description

SUSPECT - CHECK ITEM

Incorrect number of coins detected in a coin roll / incorrect number of banknotes detected in a banknote bundle.



Solution:

Check the coin roll / banknote bundle for any missing or excess coins / notes. Correct this and count again. Due to the high weight tolerance of banknotes, the 6165 is not able to detect incomplete banknote bundles.



REMOVE ALL

There are still items present on the platform after "OK" has been pressed - or the money platform was not empty during taring.

Error message



Description

Solution:

Clear the platform of all items before pressing “OK” or entering a new command. Ensure there are no objects on the platform while the 6165 tares itself.

Counted quantity is not correct

Counted quantity is not correct.

Check if the coin cup was already placed on the device during start up. In that case the weight of the cup is automatically tared which will cause an incorrect count (valid for coins only). Check if the money platform has been removed and placed during counting

Solution:

- Remove the cup from the platform and place it on the platform again, or restart the device. Make sure the cup is not on the platform when powering on the 6165.
- Never (re)move the money platform during counting

Error message



Description

OVERLOAD

Too much weight has been placed on the money platform

Solution:

Remove all weight from the platform. If the message disappears: continue using your 6165 as normal. If the message remains: switch off the 6165 and switch it back on. If the message appears frequently or doesn't go away, contact the Safescan Customer Success Team.

Error message

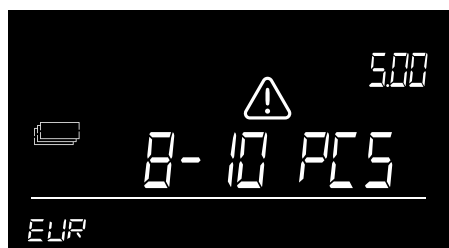

Description

Remove .. - .. PCS

The weight on the scale is too high for the 6165 to determine the exact amount of coins or banknotes.

Solution:

Remove as many coins or banknotes from the money platform as indicated, until the 6165 has been able to determine the number. Continue counting. Banknotes should always be placed on the platform in stacks of max. 25 pcs at a time. The counting of 2 versions of the same denomination is possible when:

The first stack of banknotes on the money platform does not exceed 10 pcs.

The subsequent stacks of banknotes do not exceed 15 pcs.

Error message

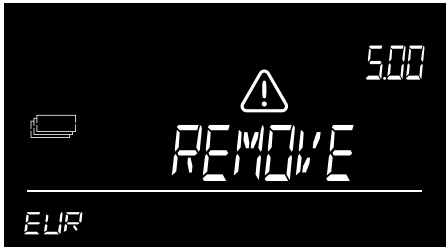

Description

REMOVE SOME

Valid for banknote counting only. The weight on the scale is illogical caused by the weight tolerance of the banknote - the 6165 can not determine the exact amount of banknotes on the platform.

Solution:

Remove a small amount of banknotes until the 6165 has been able to determine the number. Continue counting. Banknotes should always be placed on the platform in stacks of max. 25 pcs at a time. The counting of 2 versions of the same denomination is possible when:

The first stack of banknotes on the money platform does not exceed 10 pcs.

The subsequent stacks of banknotes do not exceed 15 pcs.

Error message



Description

BATTERY LOW

Battery power is lower than 5%.



Solution:

Connect the power adapter to recharge the battery. This message can only appear when the Safescan LB-205 battery is inserted.



DEFECT

The loadcell is defect, no weighing / counting possible.

Solution:

Contact the Safescan Customer Success Team

8. Rechargeable battery (Optional accessory)

8.1. Installing the Safescan LB-205 rechargeable battery

1. Disconnect the power adapter.
2. Remove the money platform from the scale.
3. Turn the device upside down and open the battery lid (see chapter 3.1).
4. Place the battery in the battery compartment, connect the wire and close the lid.
5. Place the money platform on the scale.
6. Connect the power adapter to charge the battery.

8.2. Rechargeable battery status indication

- At start up: Inner segments are blinking for 5 seconds -> Battery is being charged.
- At start up: All segments are blinking for 5 seconds after this the battery icon remains on -> Battery is 100% charged.



Device is powered by the battery only:
- Full battery is on -> Battery power is 100%



- Half the battery indicator is filled* -> Battery power more than 50%
- Half the battery is blinking continuously -> Battery power less than 20%



- Empty battery indicator is blinking* -> Battery is empty (battery power less than 5%)
In the screen the message Battery Low will be blinking, connect the power adapter to recharge the battery.

Note: battery life may deteriorate after many load cycles - this is common when using rechargeable batteries.

9. Updates

For more information about device and currency updates see **www.safescan.com** for details.

Firmware updates are loaded to the device via the Update FW option in the menu, see 6.2.7 - C.

Weight table updates are done via the free currency update software tool. This software will automatically check for firmware updates and load the latest weight table file to your 6165.

Update instructions can be found within the update package, which can be downloaded from **www.safescan.com**.

13. Safety precautions

Safescan 6165

WARNING! Failure to follow these precautions can lead to short-circuits and serious injuries such as burns, electrical shocks and fire hazards.



- Never use a damaged power adapter/power cord.
- Always and only use the supplied power adapter.
- Never subject the device, power adapter or cords to liquids or moisture, or touch them with wet hands.
- Never touch and (dis)connect the power adapter with wet hands.
- Always unplug the device from the mains socket if you want to move it to another position.
- Always hold the plug when unplugging the device from the mains socket, never pull the cord.
- Never spill any liquids or chemical (cleaning) detergents on the device.
- If liquids are spilled on the device, always disconnect the power from the mains supply socket, remove the battery (when installed) and contact Safescan for assistance.

CAUTION! Damage of product or weighing element



- Please ensure that no foreign objects (coins, paper clips, staples,) fall into the machine, these may block the mechanical parts and or weighing element of the machine and damage or break them and will void your warranty.
- Always place the 6165 on a flat and stable surface and keep the area around the money platform clear.
- To avoid damaging the device or any malfunctions, clean the device with a dry cloth. Do not use a wet or damp cloth or (chemical) cleaning products.

NOTICE! Risk of malfunctioning or damaging the device

- As with any precision weighing scale, the weighing result is influenced by substantial airflow. Therefore, do not use the device near cooling fans, air conditioners, open windows etc.
- Carefully place items on the weighing platform, do not throw or drop them.
- Do not drop, hit or shake the 6165.
- Never place items weighing more than 1.5 kg on the 6165.
- The Safescan 6165 cannot identify counterfeit money.
- Never disassemble the device, this will immediately void your warranty.
- Never leave any items - not even the coin cup - on the money platform when the device is not in use or when it is stored for a longer period.
- Do not use the machine in dusty or dirty environments, as this can lead to sensor malfunctioning.
- If the machine is not used for a long period of time, remove the power plug from the wall outlet, to avoid possible damage of the equipment.
- To avoid damaging the device. Only use the optionally available Safescan LB-205 rechargeable battery.

BATTERY LB-205 (optional product)

WARNING! Burns, fire hazard and poisoning.

Risk of serious injury



- Always keep batteries away from fire, heat and water.
- Always avoid touching the battery with your bare hands when battery is corroded or when leakage has occurred.

CAUTION! Damage, leakage



- Always remove the battery from the device in case of long term non-use or storage.
- To avoid pollution, dispose of batteries in accordance with local regulations.

Optional accessories

Rechargeable battery

Safescan LB-205 battery

Thermal receipt printer

Safescan TP-230

Money Counting Software

Safescan MCS

Weighable coin cup set

Safescan 4141CC

Safescan 4617CC

14. Specifications

Features

Money Counting Scale for counting coins, banknotes, banknote bundles and coin rolls.

Can also be used as precision weighing scale (note: not “approved legal for trade”).

Currencies

Depends on region - see www.safescan.com for more information

Dimensions (LxWxH) 22.3 x 14.2 x 14.7 cm / 8.8 x 5.6 x 5.8 inch

Display 4.1 inch high contrast LCD

Interface USB-B to PC, RJ-10 to printer

Power requirements Power supply 12V/0.5A

Power consumption

Max. 2.4W in operating mode (no battery charging)

Max. 6W in operating mode (including battery charging)

Max 50mW in stand by/idle mode

Operating temperature 0 - 40°C

Storage temperature -25 ~ 55°C

Maximum load capacity 1.5 kg / 3.3 lbs

Maximum precision 0.05 gr

Net Weight 660 gr / 23 oz

Certification CE, FCC, RoHS

Safescan® is a registered trademark of Solid Control Holding B.V.

No part of this manual may be reproduced in any form, by print, copy or in any other way without prior written permission of Solid Control Holding B.V. Solid Control Holding B.V. reserves all intellectual and industrial property rights such as any and all of their patent, trademark, design, manufacturing, reproduction, use and sales rights. All information in this manual is subject to change without prior notice. Solid Control Holding B.V. is not liable and/or responsible in any way for the information provided in this catalog. 221

Safescan®

www.safescan.com
info@safescan.com