

5 CHANNEL ALL-IN-ONE
STREAMING SWITCHER
iCast 10NDI
Instruction Manual

www.datavideo.com

Table of Contents

FCC COMPLIANCE STATEMENT	6
WARNINGS AND PRECAUTIONS	6
WARRANTY	7
<i>STANDARD WARRANTY</i>	7
<i>THREE YEAR WARRANTY</i>	7
DISPOSAL	8
CHAPTER 1 INTRODUCTION	9
1.1 <i>FEATURES</i>	9
1.2 <i>SYSTEM DIAGRAM</i>	10
CHAPTER 2 CONNECTIONS AND CONTROLS	12
2.1 <i>REAR PANEL</i>	12
2.2 <i>FRONT PANEL</i>	15
2.3 <i>DISK ASSEMBLY</i>	16
CHAPTER 3 PREPARATIONS	18
3.1 <i>POWER</i>	18
3.2 <i>CONNECTING INPUT DEVICES</i>	18
3.3 <i>CONNECTING OUTPUT DEVICES</i>	19
3.4 <i>NETWORK CONNECTIONS</i>	19
3.5 <i>MULTIVIEW</i>	20
CHAPTER 4 OSD MENU	21
4.1 <i>SYSTEM</i>	23
<i>Network Settings</i>	23
<i>FW & FPGA Version</i>	23
<i>Factory Default</i>	24
4.2 <i>STORAGE SETTINGS</i>	24
<i>Format Type</i>	24
<i>Storage Capacity</i>	24
4.3 <i>PROGRAM CG</i>	24
4.4 <i>PROGRAM OUTPUT FPS</i>	25
4.5 <i>PROGRAM LAYOUT</i>	25
<i>Quad View</i>	25
<i>Full Screen</i>	26
<i>POP</i>	26
<i>Side by Side</i>	26
<i>PIP</i>	27
4.6 <i>GENERAL SETTINGS</i>	27
<i>Channel 1</i>	27

Channel 2.....	28
Channel 3.....	29
Channel 4.....	30
Channel 5.....	30
Program.....	31
CHAPTER 5 WEB USER INTERFACE.....	33
5.1 NETWORK CONNECTION AND DEVICE SEARCH	33
Default Fixed IP.....	33
Connecting to a DHCP Network.....	36
Connecting to a NON-DHCP Network (Static IP)	37
Troubleshooting the Network Connection	38
Advanced Troubleshooting.....	40
5.2 SOURCE.....	40
SDI.....	41
HDMI.....	42
IP Stream	43
NDI.....	44
WebRTC	45
UVC.....	46
5.3 ENCODER	47
Type	47
Resolution.....	48
Frame Rate	48
Profile	48
Level.....	49
Entropy	49
GOP.....	49
Video Bitrate (bps).....	50
Audio Bitrate (bps).....	50
5.4 RECORD	51
5.5 STREAMING	51
RTSP (Real Time Streaming Protocol).....	52
RTMP (Real-Time Messaging Protocol).....	53
TS (Transport Stream).....	53
SRT (Secure Reliable Transport).....	53
NDI (Network Device Interface).....	54
DV Cloud	54
5.6 CG.....	56
News.....	56
Graphic	57
Logo	58
Animation	59

5.7	<i>MULTIVIEW</i>	60
5.8	<i>PGM</i>	61
	<i>Quad View</i>	61
	Scale	62
	Background Color	62
	<i>Full Screen</i>	62
	Window 01 Location X/Y	63
	Window 01 Width/Height	63
	Scale	63
	Background Color	64
	<i>POP</i>	64
	Window 01/02/03/04 Location X/Y	65
	Window 01/02/03/04 Width/Height	65
	Scale	66
	Background Color	66
	<i>Side By Side</i>	66
	Window 01/02 Location X/Y	67
	Window 01/02 Width/Height	67
	Scale	67
	Background Color	68
	<i>PIP</i>	68
	Window 01/02 Location X/Y	69
	Window 01/02 Width/Height	69
	Scale	69
	Background Color	70
5.9	<i>MIXER</i>	70
	<i>Volume</i>	71
	<i>Delay</i>	71
5.10	<i>MONITOR</i>	72
5.11	<i>SYSTEM</i>	72
	<i>Network Setting</i>	74
	LAN Port	74
	Host IP Address	74
	DHCP	74
	Static IP Address	74
	Subnet Mask	74
	Default Gateway	74
	Primary DNS (Optional)	74
	Secondary DNS (Optional)	74
	<i>Account and Password</i>	74
	<i>Time Setting</i>	75
	Type	75
	Time Zone	75

<i>Firmware Update</i>	75
<i>Disk Information</i>	76
<i>Device Name Setting</i>	76
<i>Other Option</i>	76
Timeout Period.....	76
Auto Streaming Restart.....	76
<i>System Control</i>	76
Restore to Default.....	76
System Reboot.....	76
5.12 <i>STATUS</i>	76
5.13 <i>ADVANCED</i>	78
CHAPTER 6 VIDEO STREAMING AND RECORDING	79
6.1 <i>VIDEO STREAMING</i>	79
<i>RTSP/TS/HLS</i>	79
<i>RTMP</i>	84
<i>SRT</i>	85
<i>NDI</i>	86
6.2 <i>RECORD/STREAM BUTTONS</i>	87
6.3 <i>RESTORE FACTORY DEFAULTS</i>	87
CHAPTER 7 APPENDICES	88
<i>APPENDIX 1 PINOUT INFORMATION FOR RS-232 CONNECTORS</i>	88
<i>APPENDIX 2 FIRMWARE UPGRADE</i>	89
<i>APPENDIX 3 FREQUENTLY-ASKED QUESTIONS</i>	90
<i>APPENDIX 4 DIMENSIONS</i>	91
<i>APPENDIX 5 SPECIFICATIONS</i>	92
SERVICE AND SUPPORT	96

Disclaimer of Product & Services

The information offered in this instruction manual is intended as a guide only. At all times, Datavideo Technologies will try to give correct, complete and suitable information. However, Datavideo Technologies cannot exclude that some information in this manual, from time to time, may not be correct or may be incomplete. This manual may contain typing errors, omissions or incorrect information. Datavideo Technologies always recommend that you double check the information in this document for accuracy before making any purchase decision or using the product. Datavideo Technologies is not responsible for any omissions or errors, or for any subsequent loss or damage caused by using the information contained within this manual. Further advice on the content of this manual or on the product can be obtained by contacting your local Datavideo Office or dealer.

FCC Compliance Statement

This device complies with part 15 of the FCC rules. Operation is subject to the following two conditions:

- (1) This device may not cause harmful interference, and
- (2) This device must accept any interference received, including interference that may cause undesired operation.

Warnings and Precautions

1. Read all of these warnings and save them for later reference.
2. Follow all warnings and instructions marked on this unit.
3. Unplug this unit from the wall outlet before cleaning. Do not use liquid or aerosol cleaners. Use a damp cloth for cleaning.
4. Do not use this unit in or near water.
5. Do not place this unit on an unstable cart, stand, or table. The unit may fall, causing serious damage.
6. Slots and openings on the cabinet top, back, and bottom are provided for ventilation. To ensure safe and reliable operation of this unit, and to protect it from overheating, do not block or cover these openings. Do not place this unit on a bed, sofa, rug, or similar surface, as the ventilation openings on the bottom of the cabinet will be blocked. This unit should never be placed near or over a heat register or radiator. This unit should not be placed in a built-in installation unless proper ventilation is provided.
7. This product should only be operated from the type of power source indicated on the marking label of the AC adapter. If you are not sure of the type of power available, consult your Datavideo dealer or your local power company.
8. Do not allow anything to rest on the power cord. Do not locate this unit where the power cord will be walked on, rolled over, or otherwise stressed.
9. If an extension cord must be used with this unit, make sure that the total of the ampere ratings on the products plugged into the extension cord do not exceed the extension cord rating.
10. Make sure that the total amperes of all the units that are plugged into a single wall outlet do not exceed 15 amperes.
11. Never push objects of any kind into this unit through the cabinet ventilation slots, as they may touch dangerous voltage points or short out parts that could result in risk of fire or electric shock. Never spill liquid of any kind onto or into this unit.
12. Except as specifically explained elsewhere in this manual, do not attempt to service this product yourself. Opening or removing covers that are marked "Do Not Remove" may expose you to dangerous voltage points or other risks, and will void your warranty. Refer all service issues to qualified service personnel.
13. Unplug this product from the wall outlet and refer to qualified service personnel under the following conditions:
 - a. When the power cord is damaged or frayed;



- b. When liquid has spilled into the unit;
- c. When the product has been exposed to rain or water;
- d. When the product does not operate normally under normal operating conditions. Adjust only those controls that are covered by the operating instructions in this manual; improper adjustment of other controls may result in damage to the unit and may often require extensive work by a qualified technician to restore the unit to normal operation;
- e. When the product has been dropped or the cabinet has been damaged;
- f. When the product exhibits a distinct change in performance, indicating a need for service.

Warranty

Standard Warranty

- Datavideo equipment are guaranteed against any manufacturing defects for one year from the date of purchase.
- The original purchase invoice or other documentary evidence should be supplied at the time of any request for repair under warranty.
- The product warranty period begins on the purchase date. If the purchase date is unknown, the product warranty period begins on the thirtieth day after shipment from a Datavideo office.
- All non-Datavideo manufactured products (product without Datavideo logo) have only one year warranty from the date of purchase.
- Damage caused by accident, misuse, unauthorized repairs, sand, grit or water is not covered under warranty.
- Viruses and malware infections on the computer systems are not covered under warranty.
- Any errors that are caused by unauthorized third-party software installations, which are not required by our computer systems, are not covered under warranty.
- All mail or transportation costs including insurance are at the expense of the owner.
- All other claims of any nature are not covered.
- All accessories including headphones, cables, and batteries are not covered under warranty.
- Warranty only valid in the country or region of purchase.
- Your statutory rights are not affected.

Three Year Warranty

- All Datavideo products purchased after July 1st, 2017 are qualified for a free two years extension to the standard warranty, providing the product is registered with Datavideo within 30 days of purchase.
- Certain parts with limited lifetime expectancy such as LCD panels, DVD drives, Hard Drive, Solid State Drive, SD Card, USB Thumb Drive, Lighting, Camera module, PCIe Card are covered for 1 year.
- The three-year warranty must be registered on Datavideo's official website or with your local Datavideo office or one of its authorized distributors within 30 days of purchase.



Disposal

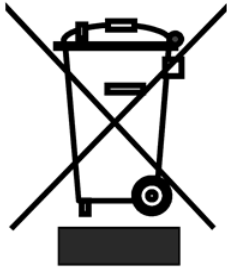

For EU Customers only - WEEE Marking

This symbol on the product or on its packaging indicates that this product must not be disposed of with your other household waste. Instead, it is your responsibility to dispose of your waste equipment by handing it over to a designated collection point for the recycling of waste electrical and electronic equipment. The separate collection and recycling of your waste equipment at the time of disposal will help to conserve natural resources and ensure that it is recycled in a manner that protects human health and the environment. For more information about where you can drop off your waste equipment for recycling, please contact your local city office, your household waste disposal service or the shop where you purchased the product.



CE Marking is the symbol as shown on the left of this page. The letters "CE" are the abbreviation of French phrase "Conformité Européene" which literally means "European Conformity". The term initially used was "EC Mark" and it was officially replaced by "CE Marking" in the Directive 93/68/EEC in 1993. "CE Marking" is now used in all EU official documents.

Chapter 1 Introduction

The iCast 10NDI five channel all-in-one streaming switcher is designed to stream and record videos with a variety of video resolutions, formats and bitrates in different scenarios. The streaming switcher features one SDI and four HDMI video inputs as well as a USB port for connecting a document camera. External audio sources can be delivered to iCast 10NDI via the XLR balanced or RCA unbalanced audio ports. In addition, it can be used as a video IP switcher allowing you to operate the device from a remote location.

The videos are recorded to an external 2.5" HDD/SSD inserted into the disk slot found on the front panel. The hard disk can be formatted to FAT or exFAT as they allow you to record the video into a single file exceeding 4 GB.

1.1 Features

- Switching the PGM view by directly pushing the buttons on the front panel
- Viewing real-time recording and streaming status on the 2" LCD display
- 6 channel ISO recording (channels 1-5 and PGM)
- Custom bitrates for streaming and recording
- H.264 Encoder
- Connection of external audio sources for audio mixing

1.2 System Diagram

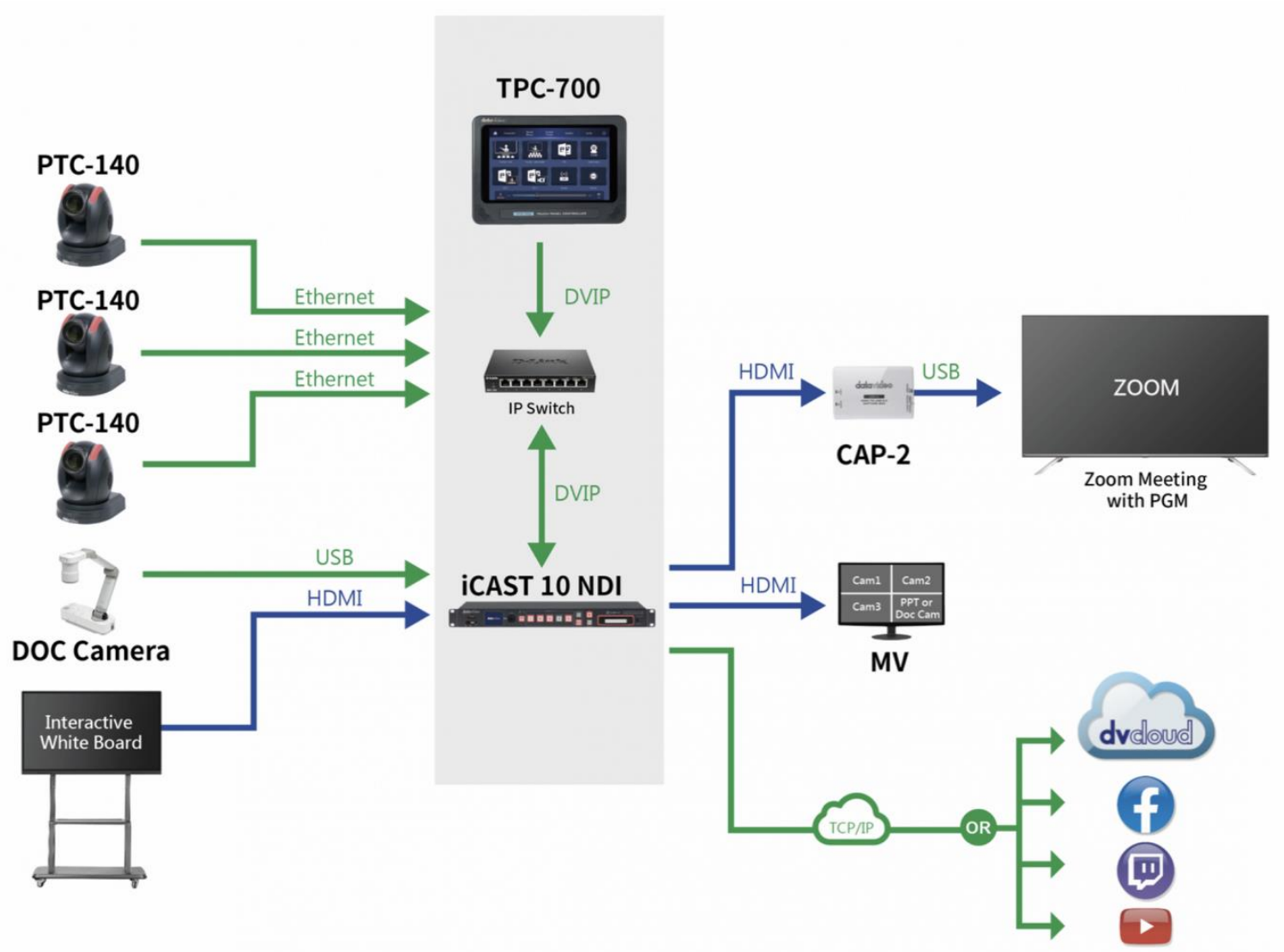

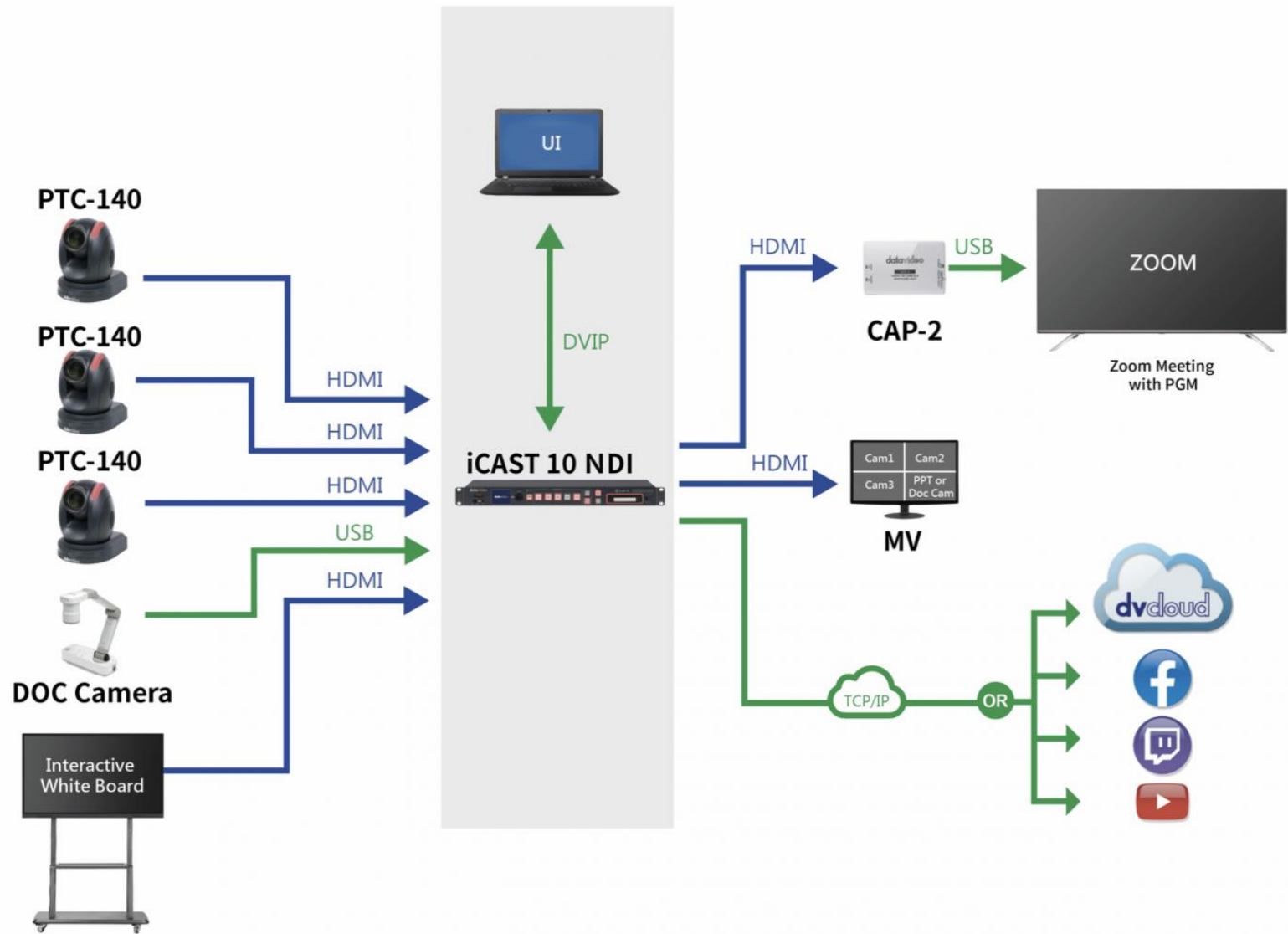

Chapter 2 Connections and Controls

In this chapter, we will discuss various port connections at the rear of the device, button functions and securing a 2.5" SSD/HDD in a disk enclosure.

2.1 Rear Panel

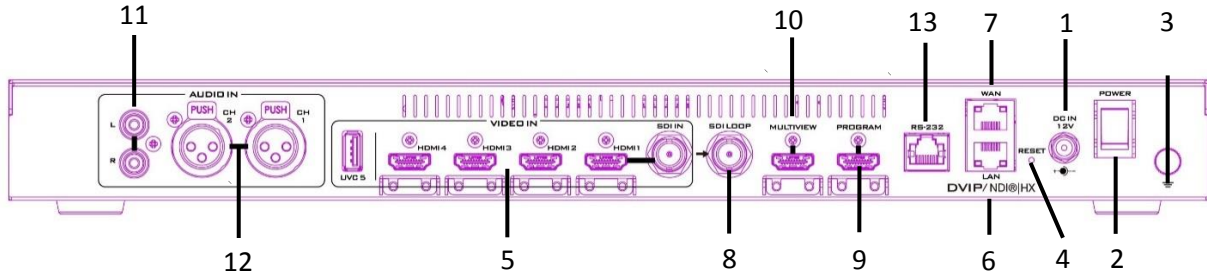

1	DC IN (12V)	8	SDI loop out
2	Power switch	9	Program out
3	Ground	10	Multiview out
4	Reset button	11	RCA unbalanced audio input
5	Video input ports	12	XLR balanced audio input
6	LAN port	13	RS-232 control port
7	WAN port		



1. DC IN (12V)

DC in socket connects the supplied 12V PSU. The connection can be secured by screwing the outer fastening ring of the DC In plug to the socket.



2. Power Switch

The power switch **ONLY** powers ON the device's LCD display on which the OSD menu will be shown after the boot is complete.

Note: After you've turned on the power switch, press the power button on the front panel to enable the button functions.



3. Ground

When connecting this unit to any other component, make sure that it is properly grounded by connecting this terminal to an appropriate point. When connecting, use the socket and be sure to use wire with a cross-sectional area of at least 1.0 mm².



4. Reset Hole

Insert a needle into the reset hole to press and hold the internal button. The device should reset itself after a few seconds.



5. Video Input Ports

The video input ports consist of one 3G/HD/SDI-SDI port, four HDMI 1.4 ports, one USB 3.0 port and two Ethernet ports (LAN and WAN ports) and can be assigned to input video channels in different combinations.

The available video source types for each input video channel are summarized below:

Input Video Channel 1: SDI, HDMI, IP Stream, NDI and WebRTC

Note: SDI is only available on Channel 1. Pressing the Input 1 button on the front panel allows you to switch between SDI and HDMI video source types.

Input Video Channel 2: HDMI, IP Stream, NDI and WebRTC

Input Video Channel 3: HDMI, IP Stream, NDI and WebRTC

Input Video Channel 4: HDMI, IP Stream, NDI and WebRTC

Input Video Channel 5: UVC

Note: The USB 3.0 port (UVC 5) is designed for connecting a document camera.

See [Section 3.5 Multiview](#) for definitions of the input video channels.

See [Section 5.2 Source](#) for assigning an appropriate video source type to input channels.



6. LAN Port

The LAN port allows you to connect your iCast 10NDI to any networks. The LAN port is a bidirectional stream port capable of accepting video streams from multiple video sources that are on the same network as iCast 10NDI or streaming videos from iCast 10NDI to local and remote client devices. Source and destination devices can be any NDI, IP or WebRTC devices.

The LAN port allows the user to establish direct connection between the PC and the iCast 10NDI in order to access the Web UI for accessing the device's internal stream and record settings.

See [Section 5.1 Network Connection and Device Search](#) for instructions on how you can establish direct connection with iCast 10NDI.

See [Section 5.2 Source](#) for assigning an NDI, IP stream or WebRTC video source type to input channels. Please note that the sum of video bitrates of all video channels should not exceed 32 Mbps when set to the NDI or IP stream video source type. This means that if the channel video bitrate is set to 10 Mbps, then up to three input

channels can be simultaneously set to the NDI or IP stream video source type; if the channel video bitrate is set to 16 Mbps, then only two input channels can be simultaneously set to the NDI or IP stream video source type. For example, if channels 1, 2 and 3 are assigned of NDI or IP stream video sources and the sum of video bitrates exceeds 32 Mbps when channel 4 is included, you can only set channel 4 to other video source types (channel 5 is designed solely for UVC input).

For output stream setup, see [Section 5.5](#) or [Chapter 6](#).



7. WAN Port

The WAN port is basically another alternative to the LAN port. The two network ports have the same functionalities but the LAN port has priority over the WAN when they are in use at the same time.



8. SDI Loop OUT

The **Loop OUT** port allows you to deliver the video source connected to the SDI IN port to the connected SDI destination device such as an SDI monitor.



9. Program OUT

The program OUT port allows you to connect an HDMI monitor for displaying the program video which can be selected using the channel buttons on the front panel.



10. Multiview OUT

The Multiview OUT port allows you to connect an HDMI monitor for displaying a Multiview of input video channels. The iCast 10NDI offers four different Multiview layouts, see [Section 5.7 PGM](#) for more information about selecting and setting these layouts.



11. RCA Unbalanced Audio Input

Connects an unbalanced analog audio source (stereo).

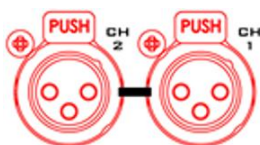

12. XLR Balanced Audio Input

Two XLR Balanced Audio Input channels.



14. RS-232 Port

Connect to the RS-232 port for remote control. See [Appendix 1](#) for RS-232 pinout information.

2.2 Front Panel

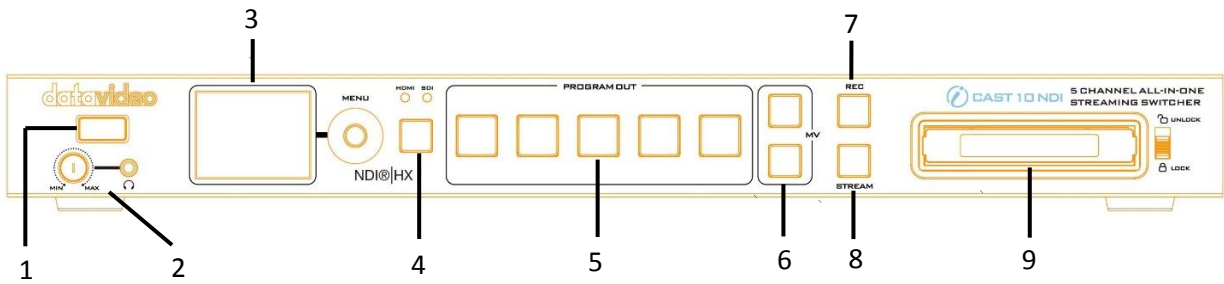

1	Power button	6	Multiview layout selection buttons
2	Headphone jack / volume control knob	7	Record button
3	LCD screen / menu browsing knob	8	Stream button
4	Input 1 button	9	Hard disk drive slot
5	Channel buttons for program OUT		



1. Power Button

Press the power button to enable the button functions after you've turned on the power switch which can be found on the rear panel.



2. Headphone Jack

Headphone jack accepts the mini jack plug of the stereo headphone type. The headphone volume can be adjusted using the volume control knob.



3. LCD Screen / Menu Browsing Knob

The OSD menu is shown on the LCD screen. Use the menu browsing knob to browse the menu and select a particular option.



4. Input 1 Button

Input source switch button for channel 1 which is an SDI/HDMI selectable input port. The LED indicators indicate the currently active port.



5. Channel Buttons for Program OUT

Depending on your program layout, press the channel buttons to select your program video sources.

Note: The available program layouts are Quad View, Full Screen, POP, Side by Side and PIP, which can be selected using the OSD menu.



6. Multiview Layout Selection Buttons

Press the corresponding button to select either a 2x2 or 4x1 Multiview layout.

The fourth quadrant of the Multiview layout is shared by channels 4 and 5 and can be changed by pressing the respective MV button.



7. Record Button

Press the record button to activate program recording. The record settings can be found on the web UI.



8. Stream Button

Press the stream button to activate program streaming. The stream settings can be found on the web UI.



9. Hard Disk Drive Slot

Insert the assembled hard disk into this slot. See the next section for disk assembly.

2.3 Disk Assembly

Instructions to assemble a 2.5" SSD/HDD in a disk enclosure will be detailed in this section.

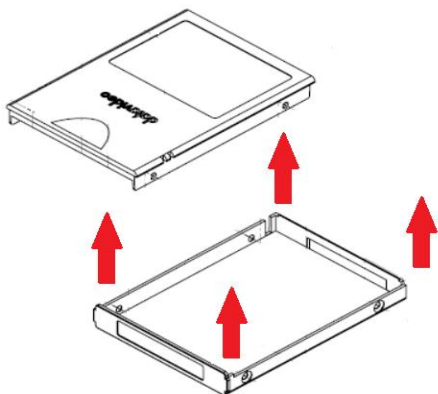

1. Lift the cover of the disk enclosure.

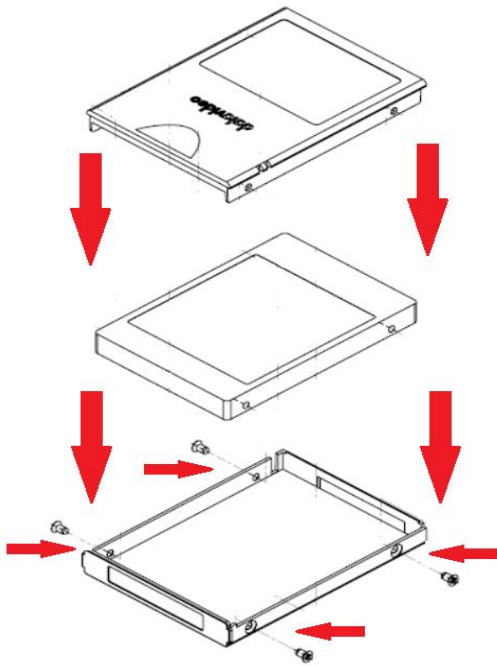

2. Reassemble the disk enclosure after placing the SSD/HDD in the enclosure tray. Insert the screws into the holes found on the two sides as shown in the diagram on the left. Fasten the screws to secure the SSD/HDD to the enclosure tray.



3. The 2.5" SSD/HDD assembled in the disk enclosure is shown in the diagram on the left.



4. Insert the assembled disk enclosure into the disk slot on the front panel then slide the LOCK/UNLOCK switch to the LOCK position. The LED indicator will illuminate as soon as the disk is inserted.

Chapter 3 Preparations

In this chapter, we will describe various essential devices to be connected to iCast 10NDI in order to complete the system setup. If you possess the skills for setting up the production system, feel free to skip this chapter and proceed to [Chapter 4: OSD MENU](#).

3.1 Power

1. Connect the supplied 12V PSU to the DC Power Input on the rear of the iCast 10NDI. The connection can be secured by screwing the outer fastening ring of the DC In plug to the socket.

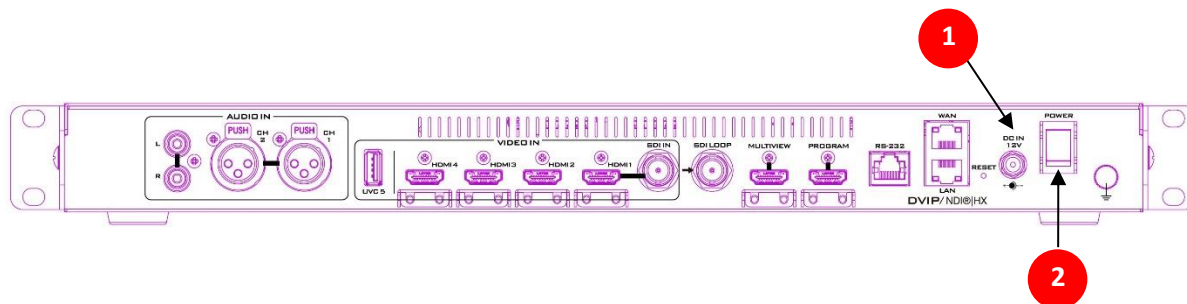

2. Turn ON the power switch to turn ON the 2" LCD screen showing device status and the OSD menu which are described in detail in [Chapter 4](#).

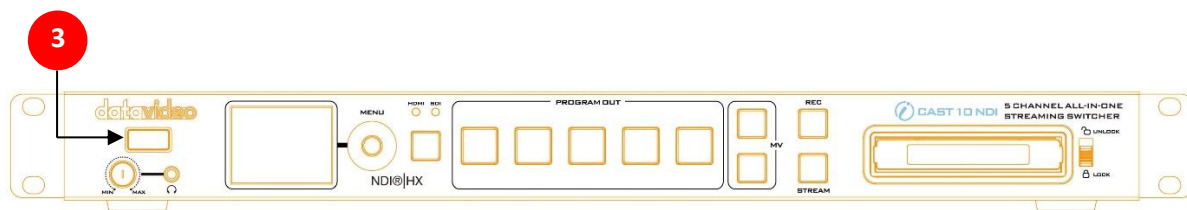

3. Press the power button to turn on the device's button functions.

3.2 Connecting Input Devices

Looking at the rear panel of the iCast 10NDI, you should find five input video channels with channel 1 being an only SDI/HDMI selectable channel. Channel 5 or the UVC channel is a USB 3.0 port designed for connecting a document camera. External audio sources such as microphones can be connected to XLR balanced audio input ports.

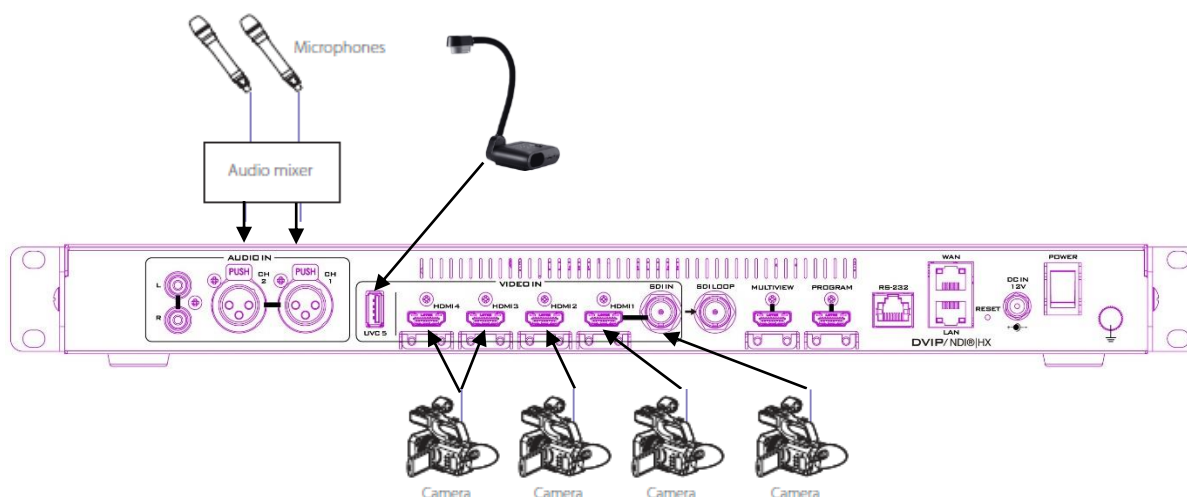

3.3 Connecting Output Devices

The iCast 10NDI has three video outputs, namely SDI Loop OUT, Program OUT, and Multiview OUT. It is possible to operate the iCast 10NDI with just one or multiple monitors connected as shown in the diagram below.

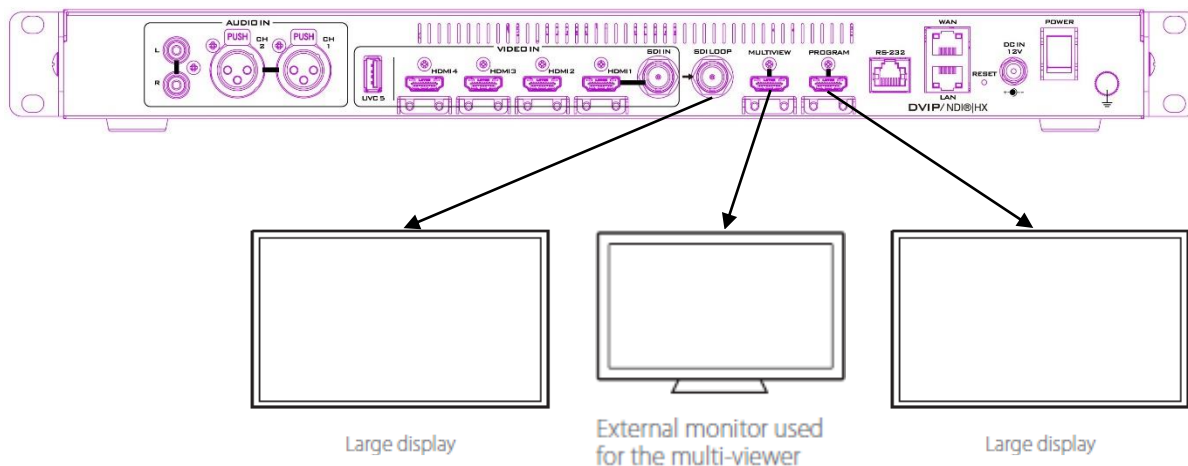

The SDI Loop OUT displays the SDI input video. The Datavideo TLM-170L/V/K/F monitors could be used. The Program OUT displays the channel video (Channels 1 – 5) selected on the front panel of the iCast 10NDI. The Program OUT can also be set to other viewing modes such as quad view, POP, PIP and side by side; see [Section 4.5 Program Layout](#) and [Section 5.7 PGM](#) for details.

The Multiview OUT displays a combination of four channel videos. You can press the corresponding buttons on the front panel to select either a 2x2 or 4x1 multiview layout. See [Section 3.5 Multiview](#) in this chapter for details.

3.4 Network Connections

With the LAN port, the iCast 10NDI can directly communicate with a PC/notebook using a static IP address. The two devices can also communicate across a DHCP network. Please seek the help of an IT specialist for network setup if necessary.

Once the network connection is set up, you will then be able to open the web UI on the PC/notebook and configure and operate the iCast 10NDI accordingly. See [Chapter 5](#) for network setup instructions and descriptions of the Web User Interface.

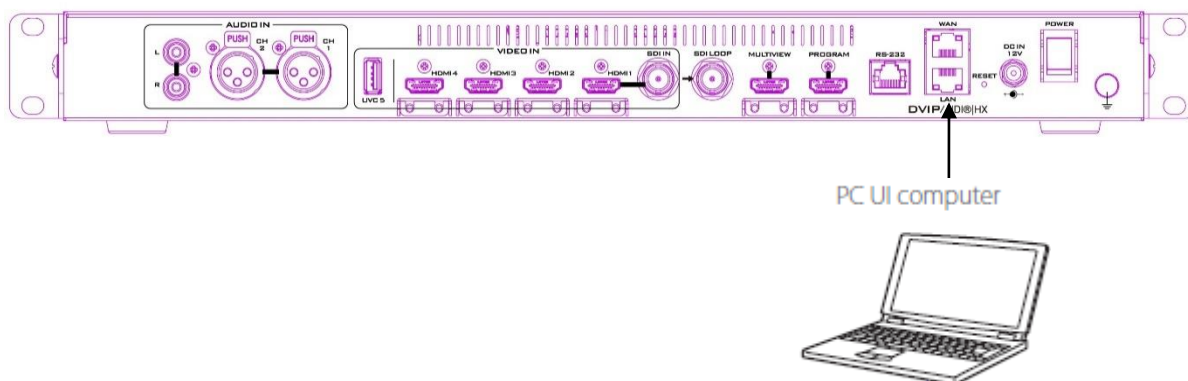

3.5 Multiview

The iCast 10NDI Multiview is supplied from the input connections on the rear panel and displayed on the HDMI monitor connected to the Multiview OUT port. The Datavideo TLM-170L/V/K/F monitors could be used. The iCast 10NDI offers two Multiview layouts. You can press the corresponding buttons on the front panel to select either a 2x2 or 4x1 Multiview layout depicted below.

2x2		4x1			
1 (HDMI/SDI)	2 (HDMI)	1 (HDMI/SDI)	2 (HDMI)	3 (HDMI)	4 (HDMI) 5 (UVC)
3 (HDMI)	4 (HDMI) / 5 (UVC)				

Note 1: Channels 4 and 5 share the fourth quadrant and can be changed by pressing the respective channel buttons on the front panel.

Note 2: Use Full Screen on the [program out](#) screen if the 4 x 1 layout is selected.

Chapter 4 OSD Menu

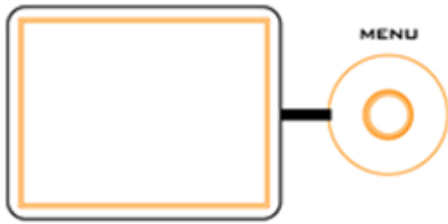

The OSD menu allows the user to access certain device settings such as the network settings, the program output frame rate, the program layout, and channel settings. You will be able to reset the device to its factory defaults and enable various program CGs. Furthermore, the stream and record status, firmware version, and disk capacity can be

viewed on the OSD menu.

As you turn on the power switch located at the rear of the iCast 10NDI, the following device information will be displayed on the 2” LCD screen after the device boots up.

iCast 10NDI IP:	192.168.001.201
Storage Capacity:	00000 MB Remaining
PGM Stream:	1080p59/12MB/RTMPS
PGM Layout:	Quad View
Multiview:	1/2/3/4

Tap the menu browsing knob up to view the record status or down to view the stream status such as the disk capacity and the encoder that each video channel is assigned to.

Record Status						
REC						
Main	CH 1	CH 2	CH 3	CH 4	CH 5	PGM
Sub	CH 1	CH 2	CH 3	CH 4	CH 5	PGM
Storage: 00000 MB Remaining						

Stream Status						
((•))						
Main	CH 1	CH 2	CH 3	CH 4	CH 5	PGM
Sub	CH 1	CH 2	CH 3	CH 4	CH 5	PGM
Storage: 00000 MB Remaining						

To access the OSD menu, simply tap the menu browsing knob right. The OSD menu is summarized in the table below.

Main Menu	Level 1	Level 2	Level 3
System	Network Settings	DHCP	Disable Enable
		Static IP	
		Subnet Mask	
		Default Gateway	
		Primary DNS	
	Secondary DNS		
	FW & FPGA Version	FW Version FPGA Version	
Storage Settings	Format Type	FAT 32 exFAT	
	Storage Capacity		
	Program CG	News	ON/OFF
Graphic		ON/OFF	
Logo		ON/OFF	

Main Menu	Level 1	Level 2	Level 3
	Animation	ON/OFF	
Program output FPS	60P		
	50P		
	30P		
	25P		
Program layout	Quad View		
	Full Screen		
	POP		
	Side by Side		
	PIP		
General Settings	Channel 1	Video Source	SDI
			HDMI
			IP Stream
			NDI
		Audio Source	Embed
			Line In
			XLR
		Audio Setting	
		Record & Stream Setting Status	Main Record
			Sub Record
			Main Streaming
			Sub Streaming
	Channel 2	Video Source	HDMI
			IP Stream
			NDI
		Audio Source	Embed
			Line In
			XLR
		Audio Setting	
		Record & Stream Setting Status	Main Record
			Sub Record
			Main Streaming
			Sub Streaming
	Channel 3	Video Source	HDMI
			IP Stream
			NDI
		Audio Source	Embed
			Line In
			XLR
		Audio Setting	
Record & Stream Setting Status		Main Record	
		Sub Record	
		Main Streaming	
		Sub Streaming	
Channel 4	Video Source	HDMI	
		IP Stream	
		NDI	
	Audio Source	Embed	
		Line In	

Main Menu	Level 1	Level 2	Level 3	
			XLR	
		Audio Setting		
		Record & Stream Setting Status	Main Record	
			Sub Record	
			Main Streaming	
			Sub Streaming	
		Channel 5	Video Source	HDMI
				IP Stream
	NDI			
	Audio Source		Embed	
			Line In	
			XLR	
	Audio Setting			
	Record & Stream Setting Status		Main Record	
		Sub Record		
		Main Streaming		
		Sub Streaming		
	Program	Audio Source	Embed	
			Line In	
			XLR	
Audio Setting				
Record & Stream Setting Status		Main Record		
		Sub Record		
		Main Streaming		
		Sub Streaming		

4.1 System

In System, you will be allowed to configure the device's network settings, view the device's firmware version and reset the device to its factory defaults.

Network Settings

The iCast 10NDI can be accessed over an existing TCP/IP LAN type network. In Network Settings, you will be allowed to gain direct access to the DHCP and Static IP modes.

Enabling **DHCP** allows the iCast 10NDI to be automatically assigned an IP address upon connection to the DHCP network. If DHCP is disabled, you will have to manually enter the network settings such as the static IP address, subnet mask, default gateway (optional), primary DNS (optional) and secondary DNS (optional).

Detailed network setup instructions can be found in [Section 5.1 Network Connection and Device Search](#).

FW & FPGA Version

In this option, you will be able to view the firmware version as well as the FPGA version on the 2" LCD screen as shown below. The firmware upgrade procedure can be found in [Appendix 2](#) or [Section 5.10 System](#).

FW & FPGA Version	
FW Version	0.1.4.6
FPGA Version	21.11.3.0
Tap [Left] to Back	

Factory Default

After you’ve selected “Factory Default”, you will see the following message prompt on the 2” LCD screen. Simply push the knob to start the reset or tap the knob left to cancel.



Are you sure you would like to reset
all settings to defaults?
(This action cannot be undone.)

4.2 Storage Settings

If you need to format the inserted hard disk, you can quickly do it from the OSD menu. You can also view the disk capacity which is displayed in MB.

Format Type

In Format Type, select FAT 32 or exFAT. Please note that formatting the disk will delete all the files.

Storage Capacity

The hard disk capacity will be displayed as shown below.

Storage Capacity
0000 MB Remaining
Tap [Left] to Back

4.3 Program CG

The iCast 10NDI allows you to place multiple textual or graphic layer on top of the video. In **Program CG**, You can enable/disable these CG layers listed as follows:

- **Text:** textual layer
- **Graphic:** still graphic layer
- **Logo:** still logo layer
- **Animation:** animated graphic layer

See [Section 5.6 CG](#) for configuring these CG layers using the Web UI.

4.4 Program Output FPS

In this option, select a frame rate for the Program OUT video. The available frame rates are 60p, 50p, 30p and 25p.

4.5 Program Layout

The iCast 10NDI's Program OUT is supplied from the input connections on the rear panel. Since a variety of multi-image layouts is available, the HDMI PGM OUT can also be used to monitor video and audio in a number of different configurations. The available Multiview layouts are described below. You can also see [Section 5.7 PGM](#) for configuring and selecting the respective layouts on Web UI.

Quad View

The quad view is either a 2x2 or 4x1 Multiview layout. The fourth quadrant is shared by channels 4 and 5 and can be changed by pressing the corresponding MV button on the front panel.

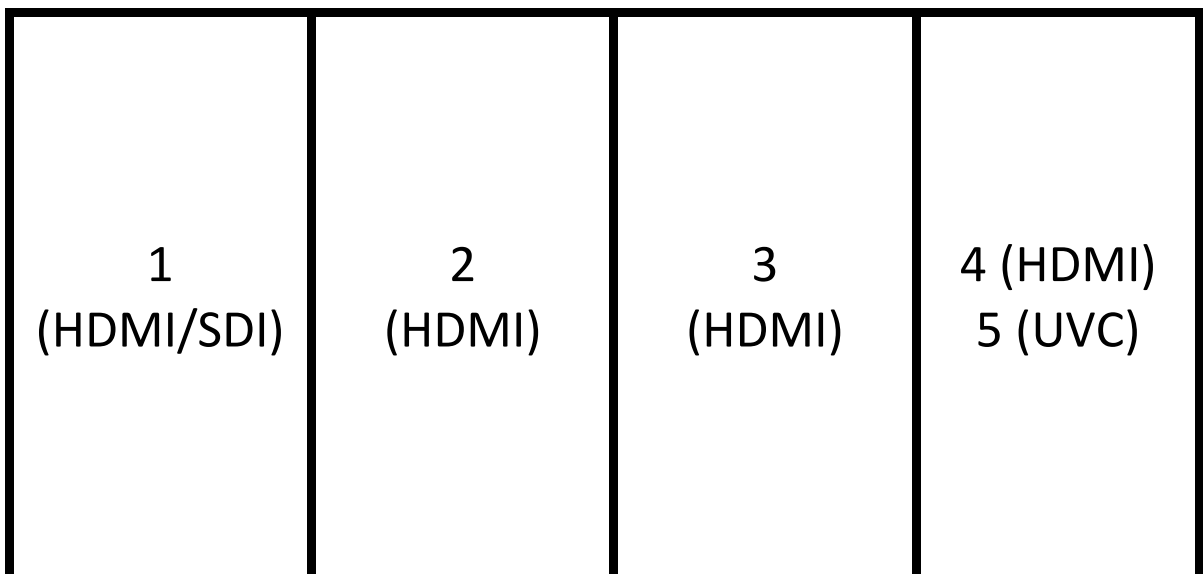
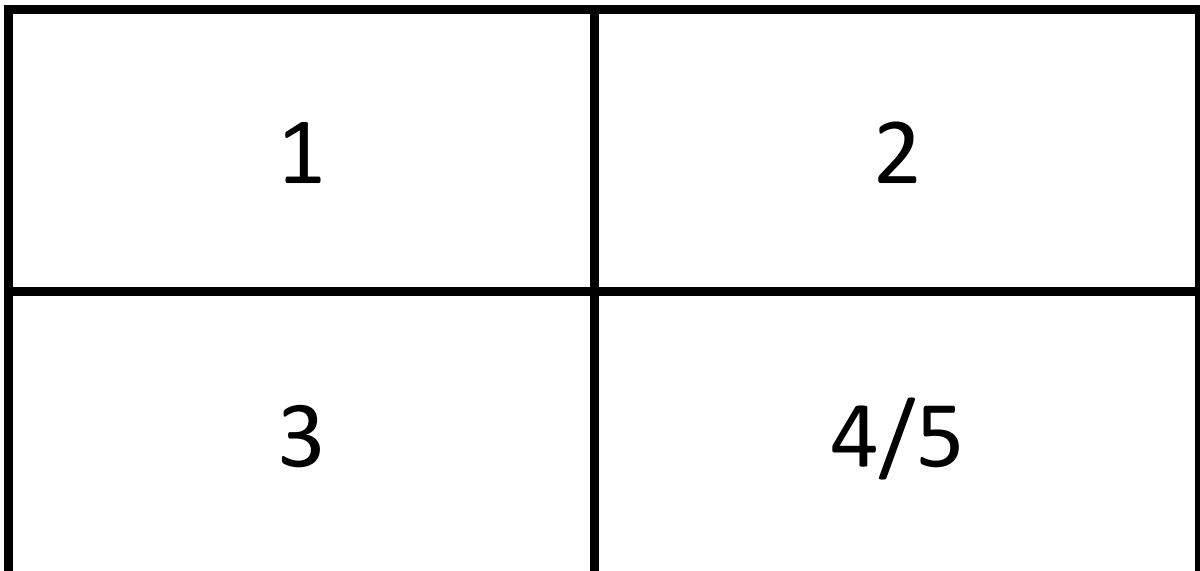

Full Screen

By selecting the full screen mode, only the selected channel video will be displayed on the monitor and the corresponding channel button on the front panel should illuminate red. Unselected channel buttons should illuminate white. You can press the channel buttons on the front panel to switch the program view. The displayed video should take up the entire screen.

POP

The POP Multiview layout is shown below. Push the channel buttons to switch between video channels.

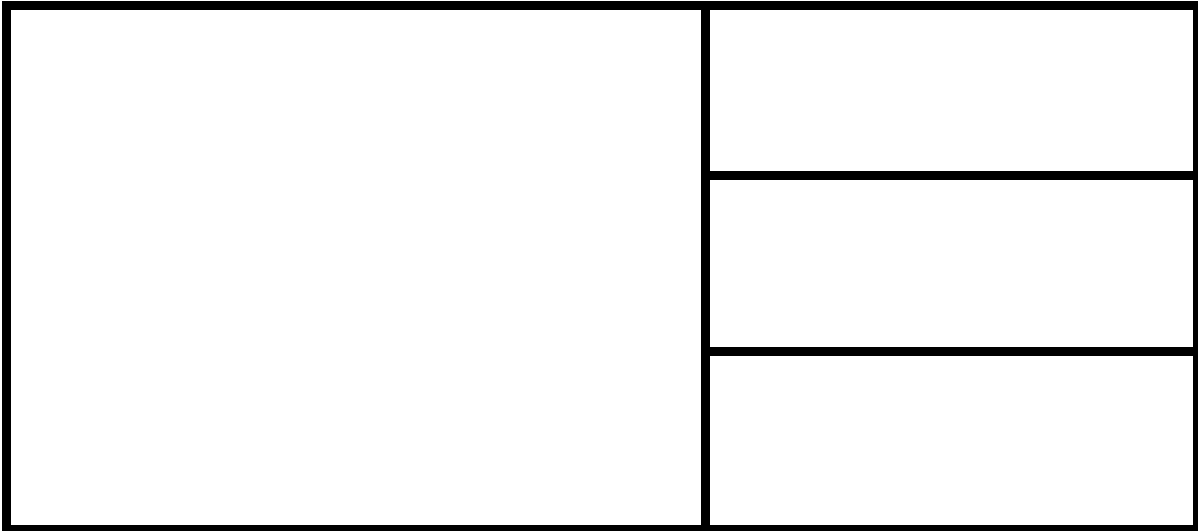

Side by Side

The Side by Side Multiview layout is shown below. Push the channel buttons to switch between video channels.

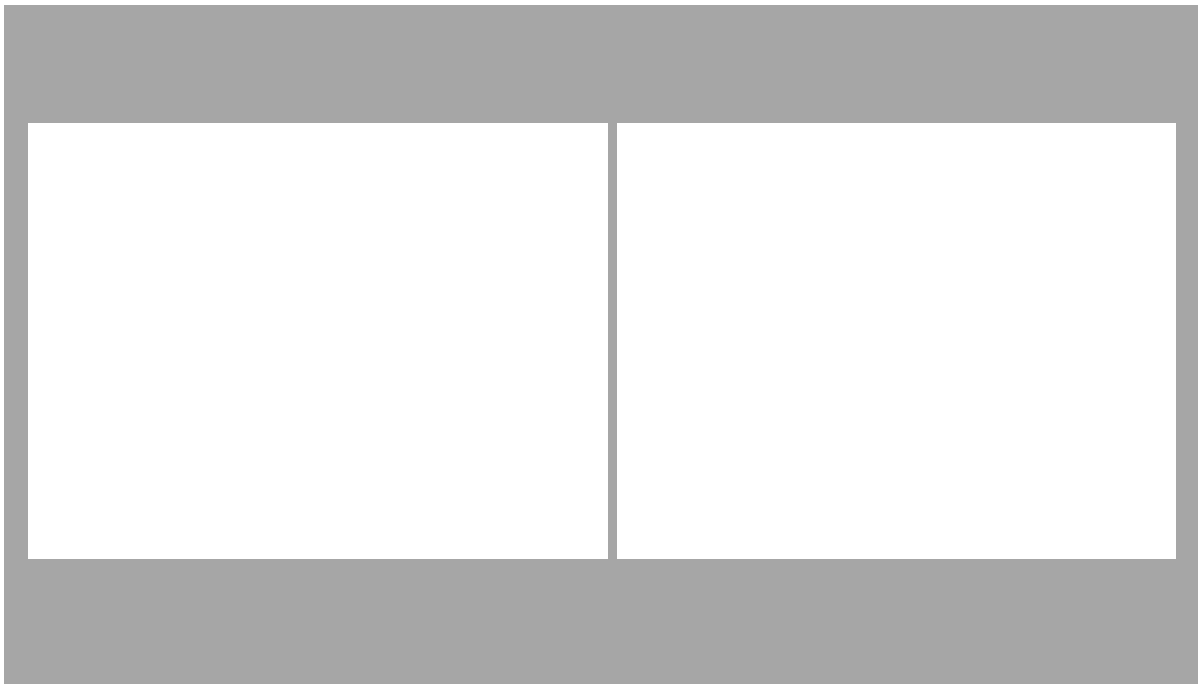

PIP

The PIP Multiview layout is shown below. Push the channel buttons to switch between video channels.

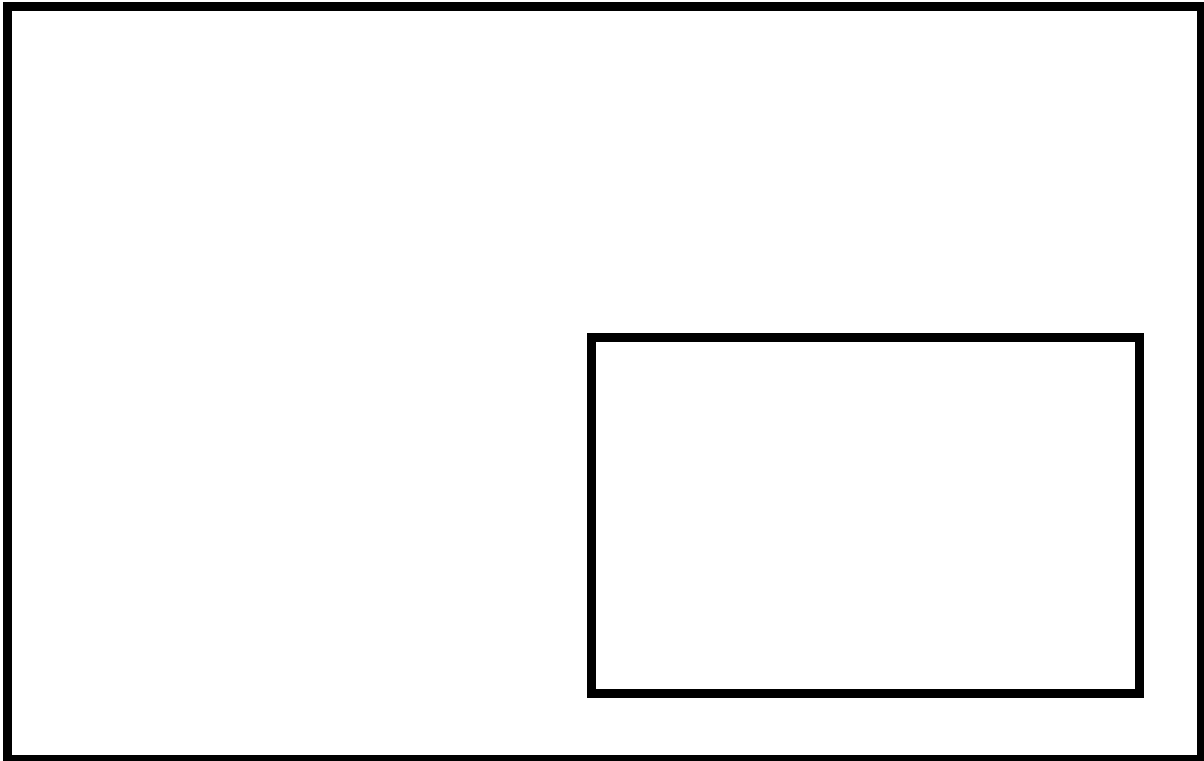

4.6 General Settings

This option gives you quick access to basic settings of input and program channels.

Channel 1

Video Source

Select the video source from the list below:

- SDI: SDI IN
- HDMI: HDMI 1
- IP Stream/NDI: LAN

Audio Source

Select the audio source from the list below:

- Embed: Embedded audio of HDMI 1 or SDI IN
- Line In: RCA unbalanced audio
- XLR: XLR balanced audio

Audio Setting

The Audio Setting adjusts the audio delay. Tap the menu browsing knob up to increase or down to decrease the delay.

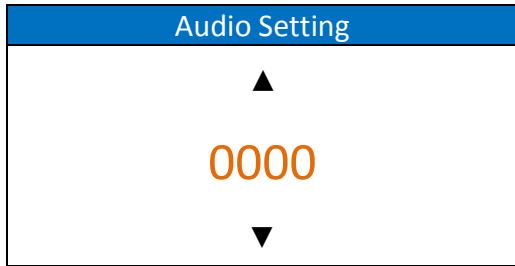

Note: See [Section 5.8 Mixer](#) for adjusting audio delay using the web UI.

Record & Stream Setting Status

Select the channel recorder or streaming server from the list below:

- Main Record
- Sub Record
- Main Streaming
- Sub Streaming

See [Section 5.3 Encoder](#), [Section 5.4 Record](#) and [Section 5.5 Streaming](#) for configurations of the respective recorders and streaming servers.

Channel 2

Video Source

Select the video source from the list below:

- HDMI: HDMI 2
- IP Stream/NDI: LAN

Audio Source

Select the audio source from the list below:

- Embed: Embedded audio of HDMI 2
- Line In: RCA unbalanced audio
- XLR: XLR balanced audio

Audio Setting

The Audio Setting adjusts the audio delay. Tap the menu browsing knob up to increase or down to decrease the delay.

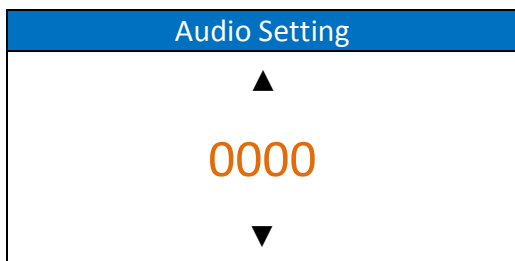

Note: See [Section 5.8 Mixer](#) for adjusting audio delay using the web UI.

Record & Stream Setting Status

Select the channel recorder or streaming server from the list below:

- Main Record
- Sub Record
- Main Streaming
- Sub Streaming

See [Section 5.3 Encoder](#), [Section 5.4 Record](#) and [Section 5.5 Streaming](#) for configurations of the respective recorders and streaming servers.

Channel 3

Video Source

Select the video source from the list below:

- HDMI: HDMI 3
- IP Stream/NDI: LAN

Audio Source

Select the audio source from the list below:

- Embed: Embedded audio of HDMI 3
- Line In: RCA unbalanced audio
- XLR: XLR balanced audio

Audio Setting

The Audio Setting adjusts the audio delay. Tap the menu browsing knob up to increase or down to decrease the delay.

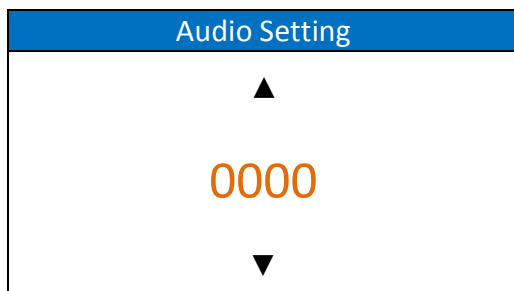

Note: See [Section 5.8 Mixer](#) for adjusting audio delay using the web UI.

Record & Stream Setting Status

Select the channel recorder or streaming server from the list below:

- Main Record
- Sub Record
- Main Streaming
- Sub Streaming

See [Section 5.3 Encoder](#), [Section 5.4 Record](#) and [Section 5.5 Streaming](#) for configurations of the respective recorders and streaming servers.

Channel 4

Video Source

Select the video source from the list below:

- HDMI: HDMI 4
- IP Stream/NDI: LAN

Audio Source

Select the audio source from the list below:

- Embed: Embedded audio of HDMI 4
- Line In: RCA unbalanced audio
- XLR: XLR balanced audio

Audio Setting

The Audio Setting adjusts the audio delay. Tap the menu browsing knob up to increase or down to decrease the delay.

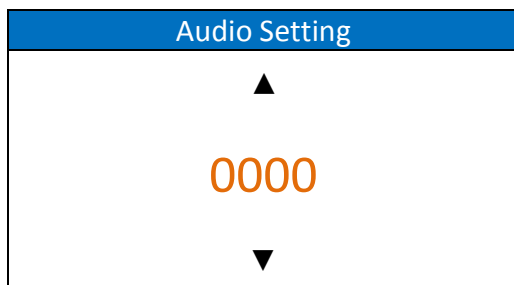

Note: See [Section 5.8 Mixer](#) for adjusting audio delay using the web UI.

Record & Stream Setting Status

Select the channel recorder or streaming server from the list below:

- Main Record
- Sub Record
- Main Streaming
- Sub Streaming

See [Section 5.3 Encoder](#), [Section 5.4 Record](#) and [Section 5.5 Streaming](#) for configurations of the respective recorders and streaming servers.

Channel 5

Video Source

Select the video source from the list below:

- UVC: USB port
- IP Stream/NDI: LAN

Audio Source

Select the audio source from the list below:

- Embed: Embedded audio of UVC

- Line In: RCA unbalanced audio
- XLR: XLR balanced audio

Audio Setting

The Audio Setting adjusts the audio delay. Tap the menu browsing knob up to increase or down to decrease the delay.

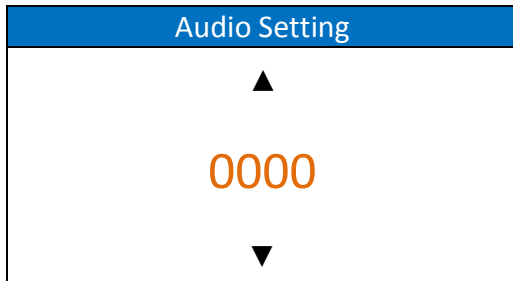

Note: See [Section 5.8 Mixer](#) for adjusting audio delay using the web UI.

Record & Stream Setting Status

Select the channel recorder or streaming server from the list below:

- Main Record
- Sub Record
- Main Streaming
- Sub Streaming

See [Section 5.3 Encoder](#), [Section 5.4 Record](#) and [Section 5.5 Streaming](#) for configurations of the respective recorders and streaming servers.

Program

Audio Source

Select the audio source from the list below:

- Embed: Embedded audio of the selected video source
- Line In: RCA unbalanced audio
- XLR: XLR balanced audio

Audio Setting

The Audio Setting adjusts the audio delay. Tap the menu browsing knob up to increase or down to decrease the delay.

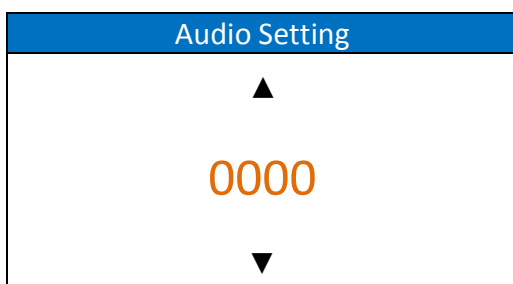

Note: See [Section 5.8 Mixer](#) for adjusting audio delay using the web UI.

Record & Stream Setting Status

Select the channel recorder or streaming server from the list below:

- Main Record
- Sub Record
- Main Streaming
- Sub Streaming

See [Section 5.3 Encoder](#), [Section 5.4 Record](#) and [Section 5.5 Streaming](#) for configurations of the respective recorders and streaming servers.

Chapter 5 Web User Interface

This chapter discusses how you can utilize the Web User Interface to configure various settings of your device.

5.1 Network Connection and Device Search

To use the web user interface, you will have to first connect iCast 10NDI to a network via the LAN port. This section shows you how to connect iCast 10NDI to the network with or without a DHCP server, and describes ways to acquire the device's IP address.

Default Fixed IP

When new from the factory, the iCast 10NDI is supplied with a default fixed IP address (**192.168.1.201**) which allows you to establish point-to-point connection with your laptop/PC. The following setup should allow you to log in to the web user interface and initially configure the device's various settings.

System Requirements:

- **An RJ-45 Ethernet cable**
- **Windows 7/8/10 laptop or PC**
- **iCast 10NDI**
- **IP Finder utility program (downloaded from the product page to the laptop)**

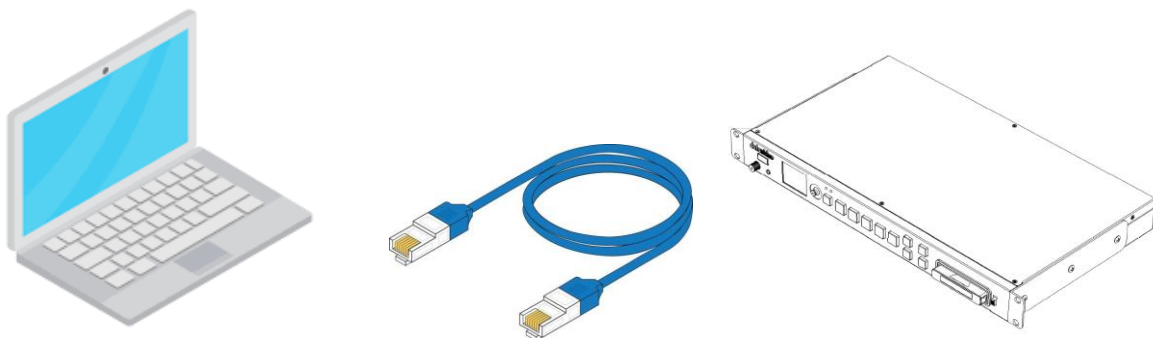

Follow the procedure below to log in to the web user interface:

1. Physically connect the Windows laptop's Ethernet port to the iCast 10NDI's LAN port via an Ethernet cable.
2. Turn on the laptop and set it to **static IP setup** within the **Windows Network and Sharing Centre**. In our example, the computer is given the following IP settings so that the computer matches the same IP range as the switcher.

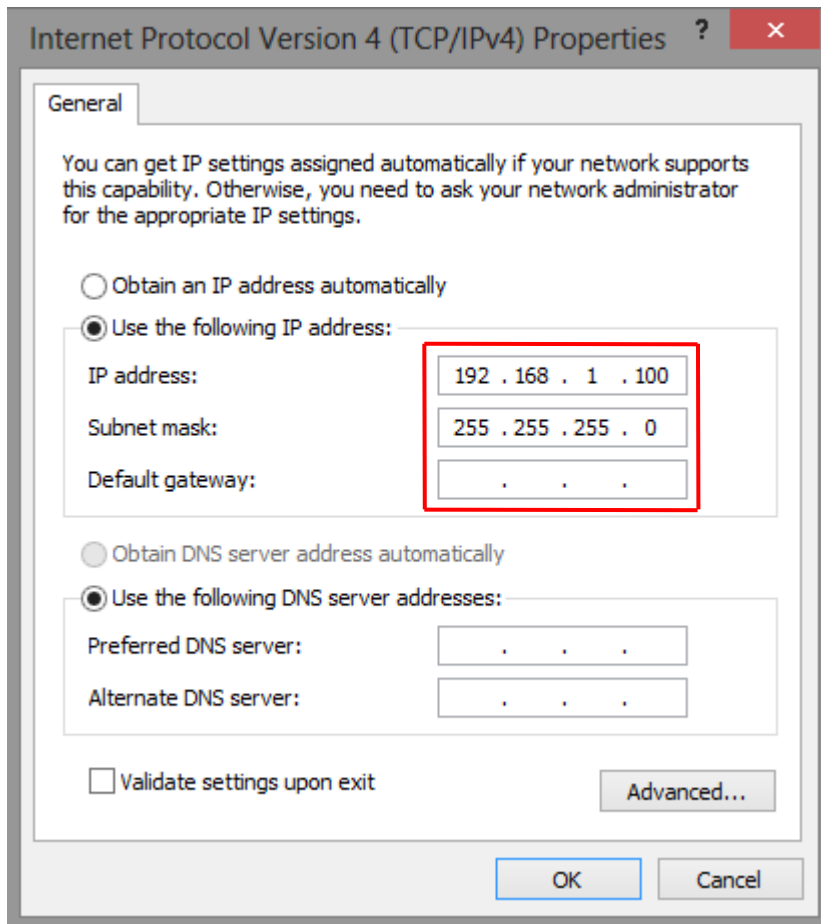

3. Turn on the iCast 10NDI's power and the device should be turned ON in Static IP mode by default (**192.168.1.201**).
4. On the laptop, double click the DVIP Network Configuration Tool icon to open the utility interface.
5. Click the **SCAN** icon at the top left corner to search for the connected iCast 10NDI.

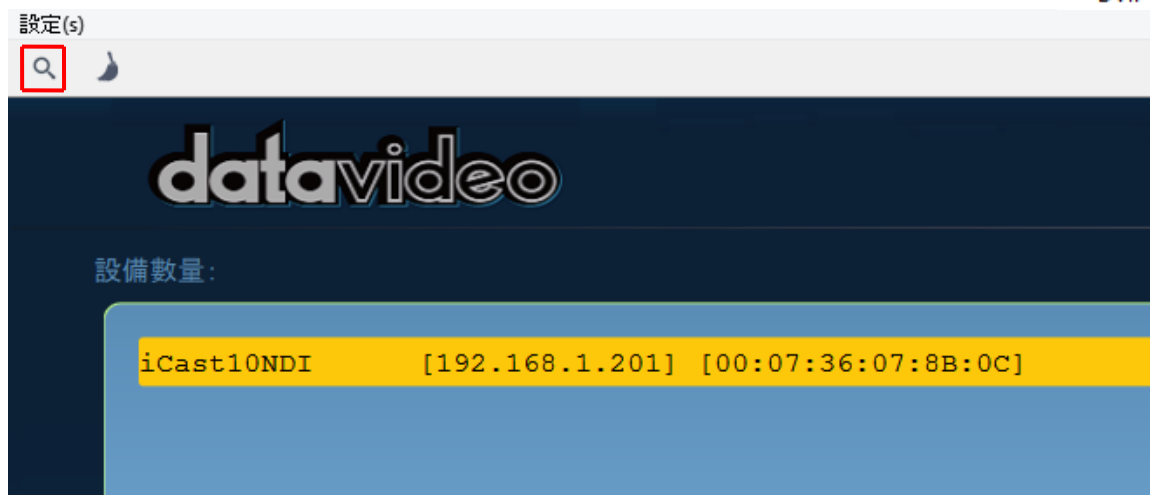

6. Manually enter the iCast 10NDI's IP address into the address bar of a browser on your laptop then hit the **ENTER** button.

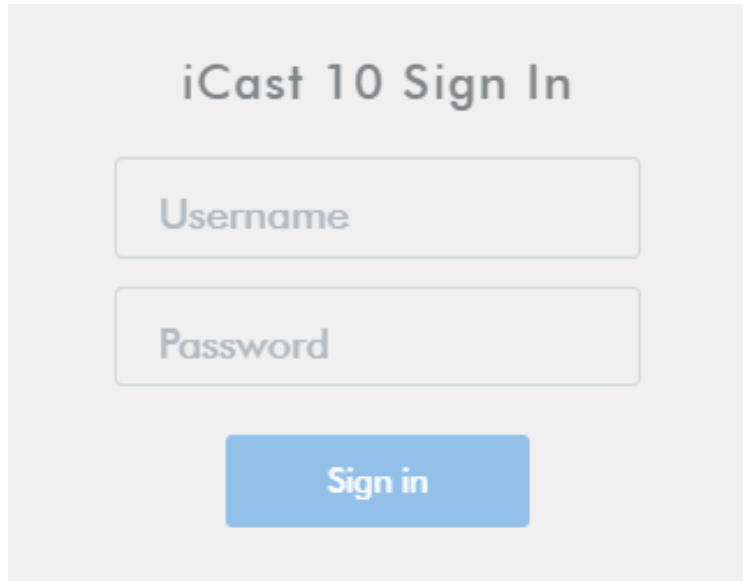

7. Enter the login credentials (Username: admin/Password: 000000) to log in to the web UI shown below.

The screenshot displays the iCast 10 NDI web interface. The top navigation bar includes the logo, the text "5 CHANNEL STREAMING ENCODER / RECORDER iCAST 10 NDI", and a language dropdown set to "English". System status indicators show "CPU : 4%", "Version : 1.0.0.8", and "Total Frame Rate Usage 120/300 fps". The main menu includes "Source", "Encoder", "Record", "Streaming", "CG", "Multiview", "PGM", "Mixer", "Monitor", "System", "Status", and "Advanced". The "Source" tab is active, showing a "Video Source" configuration area with five options: SDI, HDMI, IP Stream, NDI, and webRTC. Below these options are "Apply" and "Reset" buttons. At the bottom, a table provides input information for five channels.

Input Information	Video Source	Audio Source	Resolution	Frame Rate	Channels	Bits Per Sample	Sample Frequency
Channel 1	HDMI	Embedded	NA	NA	NA	NA	NA
Channel 2	HDMI	Embedded	NA	NA	NA	NA	NA
Channel 3	HDMI	Embedded	NA	NA	NA	NA	NA
Channel 4	HDMI	Embedded	NA	NA	NA	NA	NA
Channel 5	UVC	Embedded	NA	NA	NA	NA	NA

© iCast 10 All rights reserved Design: Doravideo

Brief descriptions of the user interface are provided as follows:

At the top right corner, you will find a drop-down menu in which you can select the interface language. The available languages are English, Traditional Chinese and Simplified Chinese.

Below the interface language drop-down menu, you will find the CPU utilization. Please note that the CPU resource used should never exceed 80%. If exceeded, you will then experience system instability, interrupted operations, audio and video becoming out of sync, and even system crash. We recommend shutting down some applications if you see any of the above-mentioned issues.

In addition, you will also find the UI version number as well as the total frame rate usage. The total frame rate usage indicates the total frame rate of all stream and record channels that are currently in use. The total frame rate usage should not exceed 300. The maximum total frame rate usage is 299 frames.

Click the tabs to gain access to various functionalities of iCast 10NDI. Brief descriptions of the tabs are provided as follows:

Source: View input channel information and configure various video sources ([SDI](#), [HDMI](#), [IP Stream](#), [NDI](#), [WebRTC](#) and [UVC](#)).

Encoder: Set the main and sub encoders.

Record: Configure the two built-in recorders.

Streaming: Configure the two built-in stream servers.

CG: Create textual or graphic layers ([News](#), [Graphic](#), [Logo](#) and [Animation](#)) on the videos.

Multiview: Set the Multiview screen layout.

PGM: Set the screen layout for PGM OUT.

Mixer: Set the volume and delay of various audio sources.

Monitor: Set the HDMI output frame rate and volume of the embedded audio.

System: System settings include [network setting](#), [login credentials](#), [time setting](#), [firmware update](#), [disk formatting](#), [device name](#), [timeout duration](#), [auto stream](#), [reset](#) and [reboot](#).

Note: In Networking Setting, you will be allowed to enable/disable DHCP; see the following sections for details on connecting in the respective modes.

Status: View input, record, stream and disk status.

Advanced: Select the video stream source and the encoder for the stream servers.

Connecting to a DHCP Network

In DHCP mode, the iCast 10NDI will be automatically assigned an IP address upon connection to the DHCP network.

Follow the procedure below to scan your DHCP network for iCast 10NDI.

1. Connect the iCast 10NDI's LAN or WAN port to the network via an Ethernet cable.
2. Turn on the iCast 10NDI's power and the device should be turned ON in DHCP.

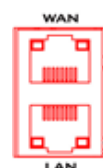



DVIP

3. Connect the laptop to the same network that the iCast 10NDI is connected to and download the free DVIP Network Configuration Tool.
4. Double click the DVIP Network Configuration Tool icon to open the utility interface.
5. Click the **SCAN** icon at the top left corner to start searching for the connected iCast 10NDI.

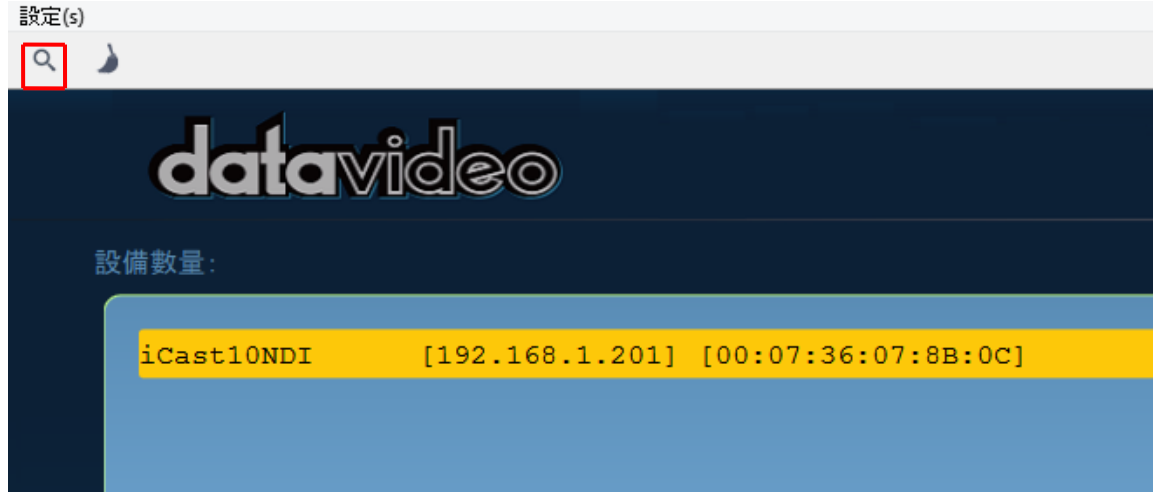

6. Manually enter the iCast 10NDI's IP address into the address bar of a browser on your PC then hit the **ENTER** button.

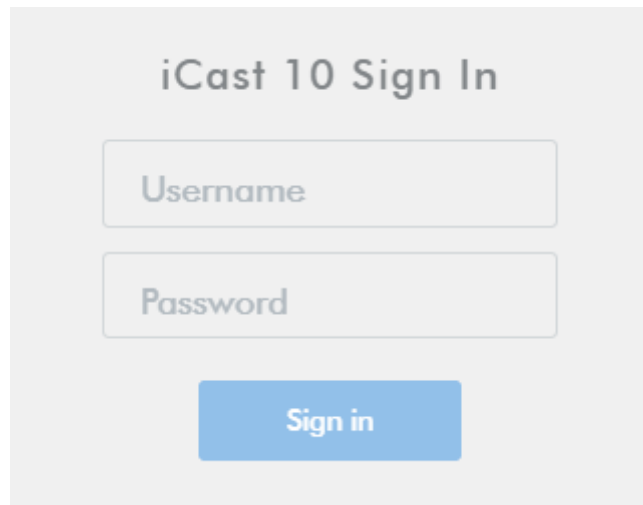

7. Enter the login credentials (Username: admin/Password: 000000) to log in to the web UI.

Connecting to a NON-DHCP Network (Static IP)

Upon connection to a non-DHCP network, the iCast 10NDI will not be assigned of any IP address. As such it is recommended that you manually assign a fixed IP address to the device or use the default IP address (**192.168.1.201**).

To configure the iCast 10NDI from DHCP to a **static IP**, please follow the steps outlined below:

1. Connect the iCast 10NDI's LAN or WAN port to the network via an Ethernet cable.
2. Turn on the iCast 10NDI's power and the device should be turned ON in DHCP.
3. Search for the iCast 10NDI device according to the method as detailed in the previous DHCP section. Once found, log in to the user interface on the web browser.

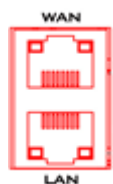

4. Open the system page by clicking the “System” tab on the home of the user interface.
5. In the “Network Setting” pane, disable the DHCP mode.
6. You will be allowed to manually enter the static IP address

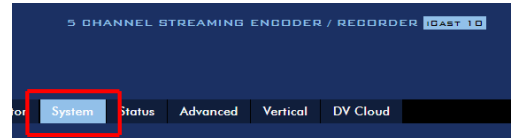

- after the DHCP mode is disabled. Please note that the static IP is 192.168.1.201 by default.
- Static IP: X.X.X.Y; the first three decimal numbers must be the same as your router or switch. The number Y must be a number not used by any devices connected to the network.
 - Subnet Mask: 255.255.255.0
 - Default Gateway: Z.Z.Z.Z; same as the gateway IP of your router or switch.
- Note: Some router may require special gateway IP setting instead of the standard 192.168.1.1. Therefore, you should check the network properties on the PC before switching to the fixed IP mode. For example, some routers have a gateway IP of 192.168.1.254 and as a result, the default gateway and primary DNS fields must also be configured to 192.168.1.254.**
- Primary DNS: Same as the default gateway IP, which, if causing issues, can be changed to 8.8.8.8 or 8.8.8.4 (Public DNS provided by Google).

7. After you’ve set the static IP, you can either establish point-to-point connection with iCast 10NDI on your computer or connect iCast 10NDI to a network with the same IP range.

Tip: If you forget or lose the IP address, you can either reset the device by inserting a needle into the reset hole at the rear panel then push and hold for several seconds until the system starts resetting itself, or you can do the following to reset the network settings.

- Turn off iCast 10NDI.
- Push the **RECORD** and **STREAM** buttons at the same time then turn ON the device power.
- Wait for about five seconds then release the buttons as soon as you see the **RECORD** and **STREAM** button LEDs light up.
- The IP address should be the default IP which is **192.168.1.201**.

Troubleshooting the Network Connection

Connect the iCast 10NDI to the network then use the IP Finder utility program to scan for the device. If not found, it is possible that your network is not assigning IP addresses. Reasons of this are outlined as follows:

- The Router or the DHCP server is not connected to the network.
- New devices are blocked by the network administrator.
- Anti-virus software or the firewall blocks the communication.

1. Solve the problem by trying the following:

- Turn off the router, wait for 10 seconds then turn on the router again.
- Reset the iCast 10NDI’s network setting to the factory default:
 - Turn off iCast 10NDI.
 - Push the **Record and Stream** buttons simultaneously while turning on the iCast 10NDI’s power.
 - Wait for about five seconds and release the buttons as soon as you see the **RECORD** and **STREAM** button LEDs light up.

- Reboot the PC.
2. If the problem still persists, try the following ways:
 - Temporarily shut down the anti-virus software or firewall.
 - Make sure no other devices are connected to the LAN (wired or wireless) because this may result in IP conflicts.
 3. After trying all methods and if the problem is still not solved, the iCast 10NDI's video streaming server offers the fixed IP feature that allows you to establish point-to-point connection to gain access to the device without a DHCP server. Please note that the iCast 10NDI's default IP address is 192.168.1.201. Follow the steps outlined below.
 - Restore the iCast 10NDI's default network settings.
 - Turn off the device.
 - Push the **Record and Stream** buttons simultaneously while turning on the device's power.
 - Wait for about five seconds then release the buttons as soon as you see the **RECORD** and **STREAM** button LEDs light up.
 - Connect your PC to iCast 10NDI directly using an Ethernet cable (not necessarily a crossover cable).
 - Click START located at the bottom left corner of your PC screen.
 - On the text bar, enter Network Connections then click the icon that appears.
 - Double click the network adapter that connects your PC or laptop to the iCast 10NDI.
 - Click the "**Properties**" button.
 - Select "**Internet Protocol Version 4 (TCP/IPv4)**" and click the "**Properties**" button.
 - Check "**Obtain an IP address automatically**".
 - Enter IPv4 settings:
 - IP Address: 192.168.1.2
 - Subnet Mask: 255.255.255.0 (System default is 255.255.255.0)
 - Default Gateway: Not required for point-to-point connection.

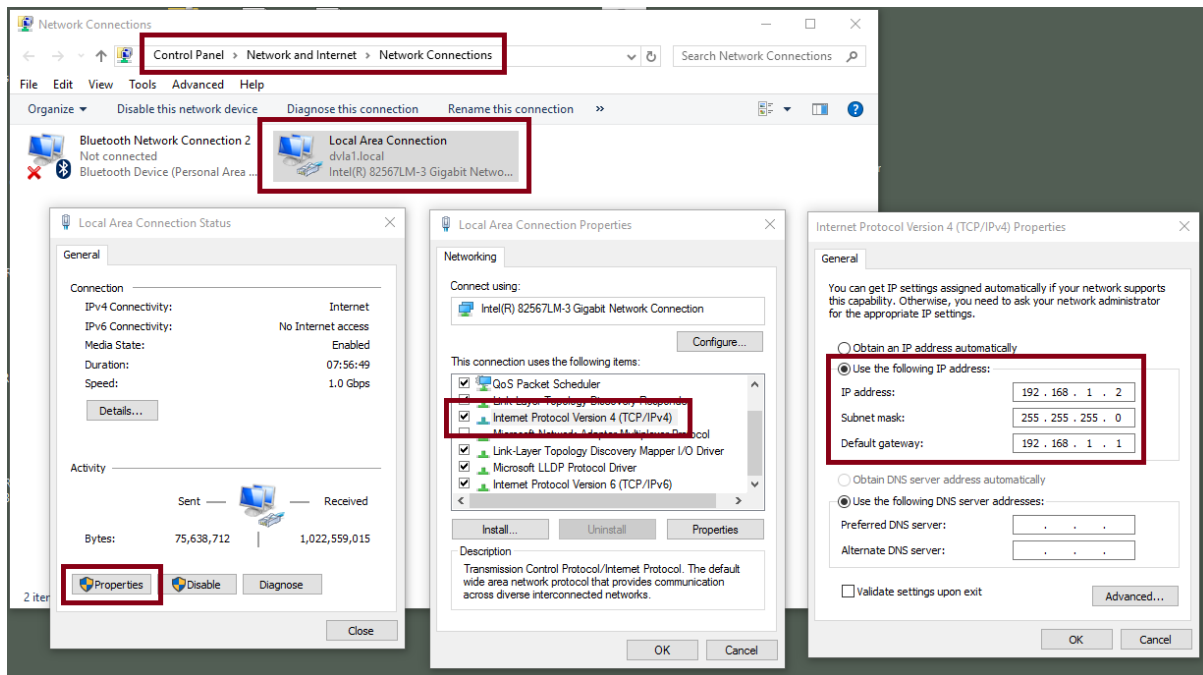

- The iCast 10NDI should now be connected with an IP address of 192.168.1.201.

Advanced Troubleshooting

Try the following if you still are unable to connect:

- Use the ARP table to search for iCast 10NDI's MAC address; the MAC address can be found on the print label at the bottom of your device.
- MAC address starts with **00:07:36:03:xx:xx**.
- On the command prompt (terminal on MAC OS), enter **"arp -a"** then press enter key to display an ARP list. See if the iCast 10NDI is successfully connected to the network.
- Execute **services.msc**, and on the right column of the **"Services"** window, locate **"DHCP Client"** then click **"Restart"**.
- On the command prompt, enter **ipconfig/flushdns** followed by **ipconfig/release** or **ipconfig/renew**.

5.2 Source

In Source, you will be able to view and select various video source types (SDI, HDMI, IP Stream, NDI, WebRTC and UVC) for each input video channel.

On each source type page, you will also be able to view information of all five input video channels such as **Input Information**, **Video Source**, **Audio Source**, **Resolution**, **Frame Rate**, **Channels**, **Bits Per Sample** and **Sample Frequency**.

Note: The iCast 10NDI web UI does not update automatically so to learn the latest device status, please refresh the page manually.

SDI

The SDI Source page is shown below. Please note that the SDI video source type is only available on input video channel 1.

The screenshot shows the CAST 10 NDI software interface. At the top, it says "5 CHANNEL STREAMING ENCODER / RECORDER | CAST 10 NDI". On the right, it shows "English", "CPU : 4%", "Version : 1.0.0.8", and "Total Frame Rate Usage: 120/300 fps". The navigation menu includes "Source", "Encoder", "Record", "Streaming", "CG", "Multiview", "PGM", "Mixer", "Monitor", "System", "Status", and "Advanced". The "Source" tab is active, and Channel 1 is selected. The "Video Source" section shows five options: SDI (selected), HDMI, IP Stream, NDI, and webRTC. Below this are "Apply" and "Reset" buttons. A table at the bottom displays input information for all channels.

Input Information	Video Source	Audio Source	Resolution	Frame Rate	Channels	Bits Per Sample	Sample Frequency
Channel 1	HDMI	Embedded	NA	NA	NA	NA	NA
Channel 2	HDMI	Embedded	NA	NA	NA	NA	NA
Channel 3	HDMI	Embedded	NA	NA	NA	NA	NA
Channel 4	HDMI	Embedded	NA	NA	NA	NA	NA
Channel 5	UVC	Embedded	NA	NA	NA	NA	NA

HDMI

For HDMI sources, you will be allowed to adjust the source video's brightness, contrast, hue and saturation by dragging the corresponding sliders as shown in the diagram below. Please note that the HDMI video source type is available across input video channels 1 – 4.

The screenshot displays the iCAST 10 NDI software interface. The top navigation bar includes 'Source', 'Encoder', 'Record', 'Streaming', 'CG', 'Multiview', 'PGM', 'Mixer', 'Monitor', 'System', 'Status', and 'Advanced'. The 'Source' tab is active, showing a 'Video Source' selection area with options for SDI, HDMI (selected), IP Stream, NDI, and webRTC. Below the selection area are four sliders for Brightness, Contrast, Hue, and Saturation, all set to 50. 'Apply' and 'Reset' buttons are located below the sliders. At the bottom, a table provides input information for five channels.

Input Information	Video Source	Audio Source	Resolution	Frame Rate	Channels	Bits Per Sample	Sample Frequency
Channel 1	HDMI	Embedded	NA	NA	NA	NA	NA
Channel 2	HDMI	Embedded	NA	NA	NA	NA	NA
Channel 3	HDMI	Embedded	NA	NA	NA	NA	NA
Channel 4	HDMI	Embedded	NA	NA	NA	NA	NA
Channel 5	UVC	Embedded	NA	NA	NA	NA	NA

IP Stream

In IP Stream, enter the URL of your video source as well as the source's account name and password if necessary. Please note that only up to three input video channels can be set to the IP stream video source type.

The screenshot displays the 'Video Source' configuration page in the iCAST 10 NDI interface. The 'IP Stream' option is selected and highlighted in blue. Below the source selection, there are input fields for 'Source URL', 'Account', and 'Password', along with a 'Decode Latency' slider set to 0. A dropdown menu is set to 'UDP'. 'Apply' and 'Reset' buttons are located below the input fields.

Input Information	Video Source	Audio Source	Resolution	Frame Rate	Channels	Bits Per Sample	Sample Frequency
Channel 1	HDMI	Embedded	NA	NA	NA	NA	NA
Channel 2	HDMI	Embedded	NA	NA	NA	NA	NA
Channel 3	HDMI	Embedded	NA	NA	NA	NA	NA
Channel 4	HDMI	Embedded	NA	NA	NA	NA	NA
Channel 5	UVC	Embedded	NA	NA	NA	NA	NA

NDI

NDI (Network Device Interface) is an open protocol developed by NewTek to enable video compatible products to share video across a local area network. The full bandwidth NDI is not supported by iCast 10NDI. Instead, iCast 10NDI only offers NDI|HX which is basically a low bandwidth version of NDI.

If your video is delivered from NDI cameras, simply select the source from the Group drop-down menu then set the delay duration. Please note that NDI cameras and iCast 10NDI must be on the same network and only up to three input video channels can be set to the NDI video source type.

The screenshot shows the iCast 10 NDI web interface. The top navigation bar includes 'Source', 'Encoder', 'Record', 'Streaming', 'CG', 'Multiview', 'PGM', 'Mixer', 'Monitor', 'System', 'Status', and 'Advanced'. The 'Source' tab is active. The main content area is titled 'Video Source' and features five selectable options: SDI, HDMI, IP Stream, NDI (highlighted in blue), and webRTC. Below these options are four sliders for 'Brightness', 'Contrast', 'Hue', and 'Saturation', each with a value of 50. At the bottom of the interface, there are 'Apply' and 'Reset' buttons, and a table with the following data:

Input Information	Video Source	Audio Source	Resolution	Frame Rate	Channels	Bits Per Sample	Sample Frequency
Channel 1	HDMI	Embedded	NA	NA	NA	NA	NA
Channel 2	HDMI	Embedded	NA	NA	NA	NA	NA
Channel 3	HDMI	Embedded	NA	NA	NA	NA	NA
Channel 4	HDMI	Embedded	NA	NA	NA	NA	NA
Channel 5	UVC	Embedded	NA	NA	NA	NA	NA

WebRTC

The WebRTC allows you to establish peer-to-peer or P2P streaming. Select WebRTC if your video is streamed directly from another WebRTC device. Then enter the receiving iCast 10NDI's IP address and leave the rest of the fields blank.

When setting the encoder, please note that the maximum allowable video resolution is 1280 x 720 and the video bitrate should be set to 2M.

The screenshot shows the iCast 10 NDI web interface. The top navigation bar includes 'Source', 'Encoder', 'Record', 'Streaming', 'CG', 'Multiview', 'PGM', 'Mixer', 'Monitor', 'System', 'Status', and 'Advanced'. The 'Source' tab is selected. The 'Video Source' section displays five options: SDI, HDMI, IP Stream, NDI, and WebRTC. The WebRTC option is highlighted. Below the WebRTC icon are four input fields: 'WebRTC Room IP', 'WebRTC Room Port', 'WebRTC User Name', and 'WebRTC User ID'. At the bottom, there are 'Apply' and 'Reset' buttons. A table at the bottom shows the following data:

Input Information	Video Source	Audio Source	Resolution	Frame Rate	Channels	Bits Per Sample	Sample Frequency
Channel 1	HDMI	Embedded	NA	NA	NA	NA	NA
Channel 2	HDMI	Embedded	NA	NA	NA	NA	NA
Channel 3	HDMI	Embedded	NA	NA	NA	NA	NA
Channel 4	HDMI	Embedded	NA	NA	NA	NA	NA
Channel 5	UVC	Embedded	NA	NA	NA	NA	NA

UVC

The UVC 5 or USB 3.0 port is designed for connecting a document camera. Simply select a device from the device list.

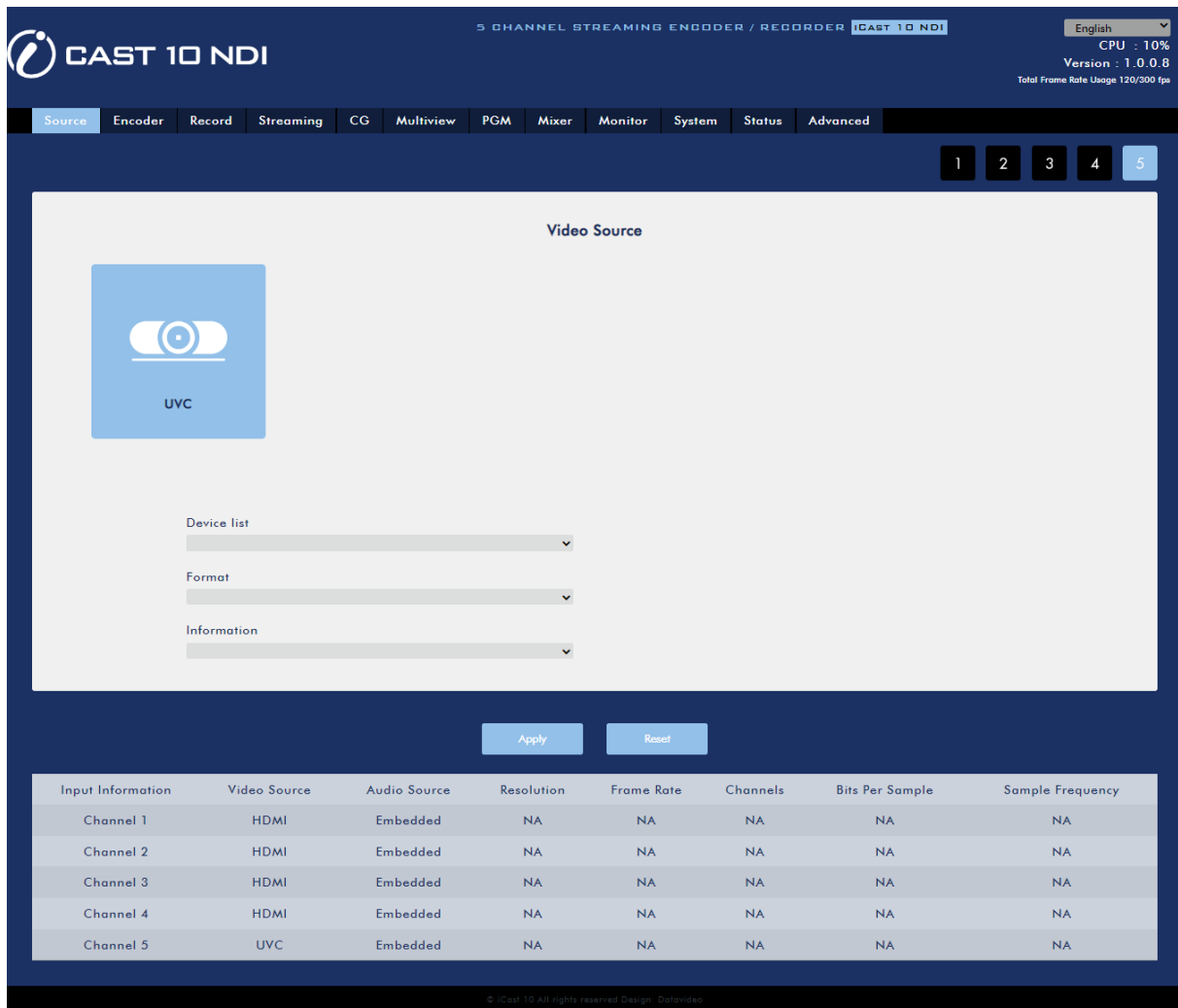

The screenshot displays the CAST 10 NDI web interface. At the top, the logo and name 'CAST 10 NDI' are visible, along with system information: '5 CHANNEL STREAMING ENCODER / RECORDER', 'English', 'CPU : 10%', 'Version : 1.0.0.8', and 'Total Frame Rate Usage 120/300 fps'. The navigation menu includes 'Source', 'Encoder', 'Record', 'Streaming', 'CG', 'Multiview', 'PGM', 'Mixer', 'Monitor', 'System', 'Status', and 'Advanced'. The 'Source' tab is active, and the 'Video Source' section is highlighted. A blue icon representing a UVC camera is shown, with the text 'UVC' below it. Below the icon are three dropdown menus labeled 'Device list', 'Format', and 'Information'. At the bottom of the configuration area are 'Apply' and 'Reset' buttons. A table at the bottom of the page provides input information for five channels.

Input Information	Video Source	Audio Source	Resolution	Frame Rate	Channels	Bits Per Sample	Sample Frequency
Channel 1	HDMI	Embedded	NA	NA	NA	NA	NA
Channel 2	HDMI	Embedded	NA	NA	NA	NA	NA
Channel 3	HDMI	Embedded	NA	NA	NA	NA	NA
Channel 4	HDMI	Embedded	NA	NA	NA	NA	NA
Channel 5	UVC	Embedded	NA	NA	NA	NA	NA

© CAST 10 All rights reserved. Design: Dolowitz

5.3 Encoder

The iCast 10NDI has two video encoding engines allowing you to concurrently stream and record to multiple destinations over different protocols. The configurable encoder settings are **Encoder Type**, **Resolution**, **Frame Rate**, **Profile**, **Level**, **Entropy**, **GOP**, **Video Bitrate (bps)** and **Audio Bitrate (bps)** which will be detailed in this section.

The screenshot displays the iCast 10 NDI Encoder configuration interface. The top navigation bar includes tabs for Source, Encoder, Record, Streaming, CG, Multiview, PGM, Mixer, Monitor, System, Status, and Advanced. The main content area is divided into two sections: Main Encoder and Sub Encoder. Both sections have a Type dropdown set to H.264. The Main Encoder settings are: Resolution 1920 x 1080, Frame Rate 60.00, Profile Main, Level High 4.2, Entropy CABAC, GOP 30, Video Bitrate 6 M, and Audio Bitrate 256 K. The Sub Encoder settings are: Resolution 1920 x 1080, Frame Rate 60.00, Profile Main, Level High 4.2, Entropy CABAC, GOP 30, and Video Bitrate 2 M. At the bottom, there are Apply and Default buttons.

Type

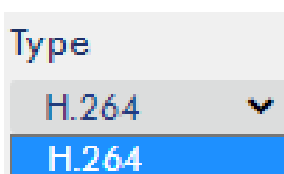

The H.264 video codec is a technology that encodes your raw footage so the file isn't massive and then decodes it for playback.

Before setting your encoder, make sure you have sufficient bandwidth. See the table below for the required bandwidth for H.264 video streaming at various resolutions.

Resolution	H.264/AVC Bandwidth Required
480p	1.5 Mbps
720p	3 Mbps
1080p	6 Mbps

Resolution

Once you've chosen your encoder, the first step of encoder setup is to adjust the image size. It is best to either match your original video source or scale it down. For example, capture at HD 720 and stream at HD 720 or capture at HD 720 and stream at 540 (high).

You should never be scaling up and streaming at a higher resolution than your original video source. For example, it does not make sense to capture at 720 and stream at 1080. Note that you will also have no gain in quality and you are using more bandwidth than is necessary for your viewers.

You should also be aware that higher resolutions require greater processing power to encode the stream. Attempting too high of a resolution on too little processing power can result in degraded image quality and corrupted or interrupted streams or recordings.

Resolutions available for your stream encoder are listed as follows:

- 1920x1080
- 1280x720
- 720x576
- 720x480
- 640x480
- 320x240

Frame Rate

Select a frame rate from the drop-down menu for video streaming. Note that frame rate should always match the frame rate of the video source.

- 60.00
- 59.94
- 50.00
- 30.00
- 29.97
- 25.00
- 24.00
- 23.98
- 20.00
- 15.00

Profile

Profile sets the H.264 encoding profile for your stream. The available options are **Baseline**, **Main**, and **High**. Typically, **High** profile provides the best image quality and is suitable in most instances.

However, depending on the decoder used when viewing the stream, such as with mobiles devices, a Main or Baseline profile may be required.

- High
- Main
- Baseline

Level

Levels specify the size of the video a decoder must be able to handle. They specify a maximum bit-rate for the video and a maximum number of macroblocks per second. Level is a hardcoded inaccessible parameter fixed at 4.2.

Level ID	Max. Video Bitrate in kbits/s	Max Frame Size in macroblocks	Max decoding speed in macroblocks per second	Resolution, Frame Rate (Max Stored Frames)
4.2 (High)	50000	8704	522240	1,280×720@145.1 (9) 1,920×1,080@64.0 (4) 2,048×1,080@60.0 (4)

Entropy

There are two coding options available for generating H.264 content:

- CAVLC (Context-Adaptive Variable Length Coding)
- CABAC (Context-based Adaptive Binary Arithmetic Coding)

CABAC encoding provides a 7-10% quality improvement over CAVLC but requires an extra 10-15% CPU. CABAC encoding is only available in H.264 Profiles Main & High. When targeting at low-powered devices, such as older cell phones and tablets, we recommend the Baseline Profile that uses CAVLC which requires less computing power.

GOP

GOP pattern with longer GOP length encodes video very efficiently. Shorter GOP lengths usually work better with video that has quick movements, but they do not compress the data rate as much. Depending on your applications, you can select 16 GOP sizes ranging from 1 to 255.

- 255
- 240
- 200
- 120
- 100
- 60
- 50
- 30
- 25
- 20
- 15
- 10
- 5

- 3
- 2
- 1

Video Bitrate (bps)

The bitrate of the video specifies the amount of information stored in the video. The higher the bitrate is, the clearer the video is. However, when choosing your encoder settings for streaming, you should first check your available upload bandwidth. A good rule of thumb is for the bitrate of your stream to use no more than 50% of your available upload bandwidth capacity on a **DEDICATED** line. For example, if the result you get from a speed test shows that you have 2Mbps of upload speed available, your combined audio and video bitrate should not exceed 1Mbps.

Available video bitrates are listed as follows:

- 32M
- 24M
- 16M
- 12M
- 8M
- 6M
- 4M
- 2M
- 1M
- 512K
- 256K

The following video bitrates are recommended:

- In record-only mode, the recommended video bitrate is 16 Mbps.
- In stream-only mode, the recommended video bitrate is 10 Mbps.
- When iCast 10NDI streams and records simultaneously, sum of the stream and record video bitrates should not exceed 12Mbps.

Audio Bitrate (bps)

iCast 10NDI offers the user the following audio bitrates at which you may want to stream the audio. It is recommended to select 128Kbps or higher.

- 384 K
- 256 K
- 128 K
- 64 K
- 32 K

Click **“Apply”** to save the new settings and **“Default”** to reset.

5.4 Record

The Record page allows you to set the two built-in recorders on iCast 10NDI. First select an encoder configured previously on the Encoder page then enter the record file name, select the file type and set the record duration.

The available file types are MP4, TS and MOV.

The available record durations in minutes are listed as follows:

- 240
- 120
- 60
- 30
- 5
- 1

Click “Apply” to save the new settings and “Default” to reset.

The screenshot shows the iCast 10 NDI web interface. At the top, there is a navigation bar with the iCast 10 NDI logo and the text "5 CHANNEL STREAMING ENCODER / RECORDER iCAST 10 NDI". On the right, there is a language dropdown set to "English", and system status indicators: "CPU : 15%", "Version : 1.0.0.8", and "Total Frame Rate Usage 120/300 fps". Below the navigation bar, there are tabs for "Source", "Encoder", "Record", "Streaming", "CG", "Multiview", "PGM", "Mixer", "Monitor", "System", "Status", and "Advanced". The "Record" tab is active. In the top right corner of the main area, there are five numbered buttons (1-5) and a "PGM" button. The main content area is divided into two sections: "Main Record" and "Sub Record". Each section has two rows of settings. The first row contains "Encoder Source" (a dropdown menu set to "Disable") and "File Name" (a text input field with a placeholder "CH01_MAIN_%Y%M%D_%h%m%ss_%i"). The second row contains "Type" (a dropdown menu set to "MP4") and "Duration (min)" (a dropdown menu set to "120"). At the bottom of the form, there are four buttons: "Apply", "Default", "Start Record", and "Stop Record".

5.5 Streaming

The Streaming page allows you to select the two built-in streaming encoders for each input video channel on iCast 10NDI to deliver the respective channel videos to client devices via various video streaming protocols such as **RTSP, RTMP, TS, HLS, NDI, SRT, and DV Cloud**. First select an encoder configured previously on the Encoder page then the stream type and configure the settings accordingly.

Various stream type settings will be discussed in this section.

Please note that each input video channel is equipped with two built-in encoders so you can deliver the channel video to two destinations using two different streaming protocols at the same time. In addition, you can also borrow encoders from other input video channels. For example, you can assign Main Encoder of Channel 3 to stream Channel 1 video via the configured streaming protocol. See [Section 5.12 Advanced](#) for more details.

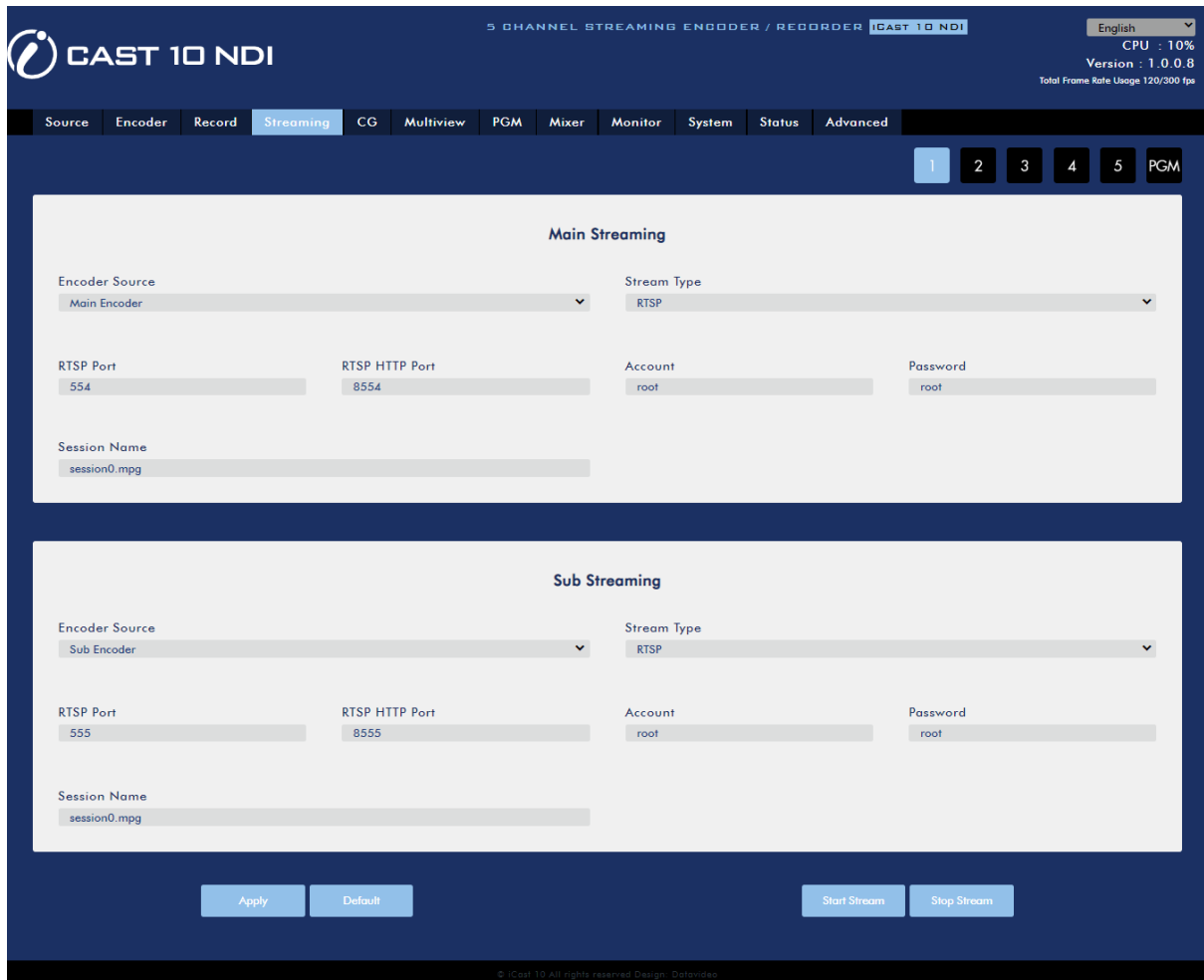

RTSP (Real Time Streaming Protocol)

Encoder Source	Main Encoder			Stream Type	RTSP			
RTSP Port	554	RTSP HTTP Port	8554	Account	root		Password	root
Session Name	session0.mpg							

- RTSP Port: The RTSP port number ranges from 554 to 562 and is 554 by default.
- RTSP HTTP Port: The RTSP HTTP port number ranges from 8553 to 8563 and is 8554 by default.
- Account / Password: The RTSP streaming account credentials which are root/root by default.
- Session Name: The default RTSP session name is session0.mpg.

See [RTSP/TS/HLS](#) for details.

RTMP (Real-Time Messaging Protocol)

Encoder Source Main Encoder	Stream Type RTMP
RTMP URL ex: rtmp://192.168.1.88/live/	Stream Name
Account	Password

- RTMP URL: Enter an RTMP URL obtained from any live streaming platform such as Ustream.
Note: The iCast 10NDI supports RTMP Publish only and not RTMP Local.
- Stream Name: Enter a stream name or key from any live streaming platform such as Ustream.
- Account / Password: Enter the account name and the password of your RTMP platform account.

See [RTMP](#) for details.

TS (Transport Stream)

When streaming videos via the TS protocol, even if some parts of the file are corrupted, the player can still play the uncorrupted parts of the video. However, because TS is a less used protocol so it is quite difficult to find TS compatible devices players.

Encoder Source Main Encoder	Stream Type TS
TS URL udp://10.10.80.169:10010	

- TS URL: Enter a URL for your transport stream.

See [RTSP/TS/HLS](#) for details.

SRT (Secure Reliable Transport)

Stream Type Caller	SRT Port 0
Caller IP Address	Passphrase
Latency (20~8000 ms) 0	

Stream Type Listener	SRT Port 1210
Latency (20~8000 ms) 0	

- Stream Type: Set the device as the caller or listener.
- SRT Port: Enter the port number designated for SRT traffic.
- Caller IP Address: Enter the IP address of the destined device.
- Passphrase: Enter a password in the Passphrase field if you would like to encrypt the SRT video stream.
- Latency (20 – 8000): Enter the amount of latency in ms to apply to the SRT stream. This field is optional and the default latency is 1000 ms.

See [SRT](#) for details.

NDI (Network Device Interface)

If you've selected NDI, make sure the NDI video players and the iCast 10NDI are on the same network. Please also note that only one encoder (main or sub) will be enabled for the input video channel if NDI is chosen.

The screenshot shows a configuration panel for NDI. At the top, there are two dropdown menus: 'Encoder Source' and 'Stream Type'. 'Encoder Source' is set to 'Main Encoder' and 'Stream Type' is set to 'NDI'. Below these, there is a text input field labeled 'NDI Name' which contains the text 'PGM-Main'.

- NDI Name: Specify a name for your NDI encoder in this field if you've selected NDI as your stream type.

See [NDI](#) for details.

DV Cloud

If you would like to stream or record an input video channel to DV Cloud via SRT protocol, select DV Cloud as the stream type then enter the DV Cloud admin login credentials. The admin login account is the account credentials entered when you sign up for a DV Cloud account.

The screenshot shows a configuration panel for DV Cloud. At the top, there are two dropdown menus: 'Encoder Source' and 'Stream Type'. 'Encoder Source' is set to 'Main Encoder' and 'Stream Type' is set to 'DV Cloud'. Below these, there are two text input fields: 'Username (email)' and 'Password', both of which are currently empty.

Once logged in, you will see the fields as shown in the diagram below.

Main Streaming

Encoder Source: Public Server:

SrtPassword: Channel Name:

Model Name:

Go to 

Enter the following information.

Encoder Source: Select either the main or sub encoder from the drop-down menu. See [Section 5.3 Encoder](#) for details of the encoder settings.

Public Server: DV Cloud server name

SRTPassword: Enter a password to encrypt the SRT stream.

Channel Name: Enter an arbitrary name of the video channel streamed to DV Cloud.

Model Name: Name of the iCast 10NDI

After entering all information, click the **Start Stream** button to view your video channel on DV Cloud as illustrated in the diagram below.



5.6 CG

The CG function allows the user to place scrolling texts (News), a still picture (Graphic), a logo and an animated image above the video layer. Various CG layers will be discussed in this section.

News

News allows you to place the scrolling text over the video.

First pre-enter the scrolling text content into a text file then upload the text file to iCast 10NDI.

Lastly, customize the following text properties.

Note: You can only enter up to 15 lines of text into the text file only and for Chinese text, please set the font type to UTF-8.

Size: Set the font size to large, medium or small.

See the table below for the corresponding English and Chinese font sizes:

Size	English	Chinese
Large	Lowercase → 23 Uppercase → 29	16
Medium	Lowercase → 37 Uppercase → 48	26
Small	Lowercase → 56 Uppercase → 72	40

Font: NotoSerifCJKtc and Open are the two available font types.

Text Color: You can set the text color to Black, Blue, Green, Orange, Red, White or Yellow.

Border Line: Select ON to enable the border line of the text entered.

Border Color: The border line color can be set to Black, White or Yellow.

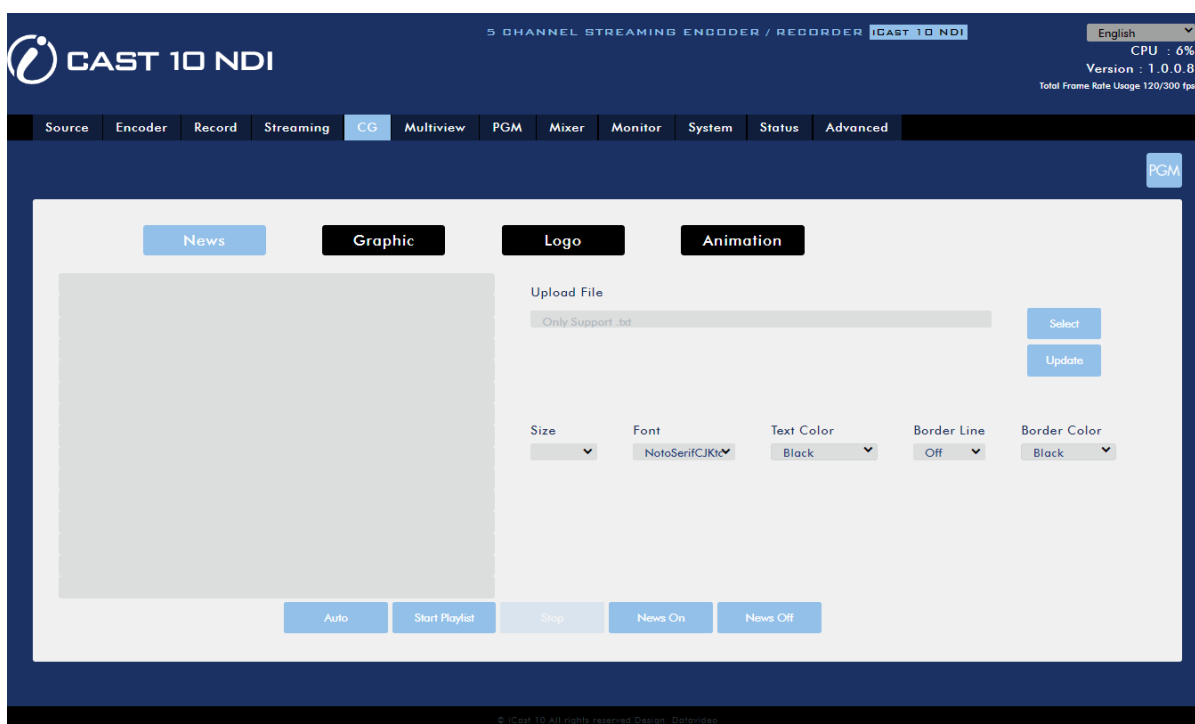

After you've entered and configured the scrolling text, you may enable them on the video using one of the three ways described below:

Click "**AUTO**" to play the scrolling text and change lines for every 6 seconds.

Click "**Start Playlist**" to play the scrolling text and change lines only when the space key is pressed. At the 15th line (last line), press the space key to return to the first line.

Click "**News On**" to select any text preview box with the mouse. When the text line turns red as the mouse cursor is hovered over, that particular line of text is too long and certain parts have been cropped on the screen.

Graphic

You can also add a picture to the video. You will be required to select a png file from your local hard disk. Click **Select** to browse the hard drive for your graphic file then click **Update** to start the upload.

After the graphic file has been successfully uploaded, you can adjust the size by entering appropriate values in the **Width** and **Height** fields.

The **Effect** drop-down list sets how the image enters the video. Select "**Cut in**" if you want the image to appear with no effect. If you want the image to enter from either side of the screen, select "**Left to Right**" or "**Right to Left**".

Lastly, set the coordinates of the image. The position of the image on the screen will be shown in the location box.

To turn on the graphic image, simply click the **Graphic ON** button which can be found at the bottom of the page.

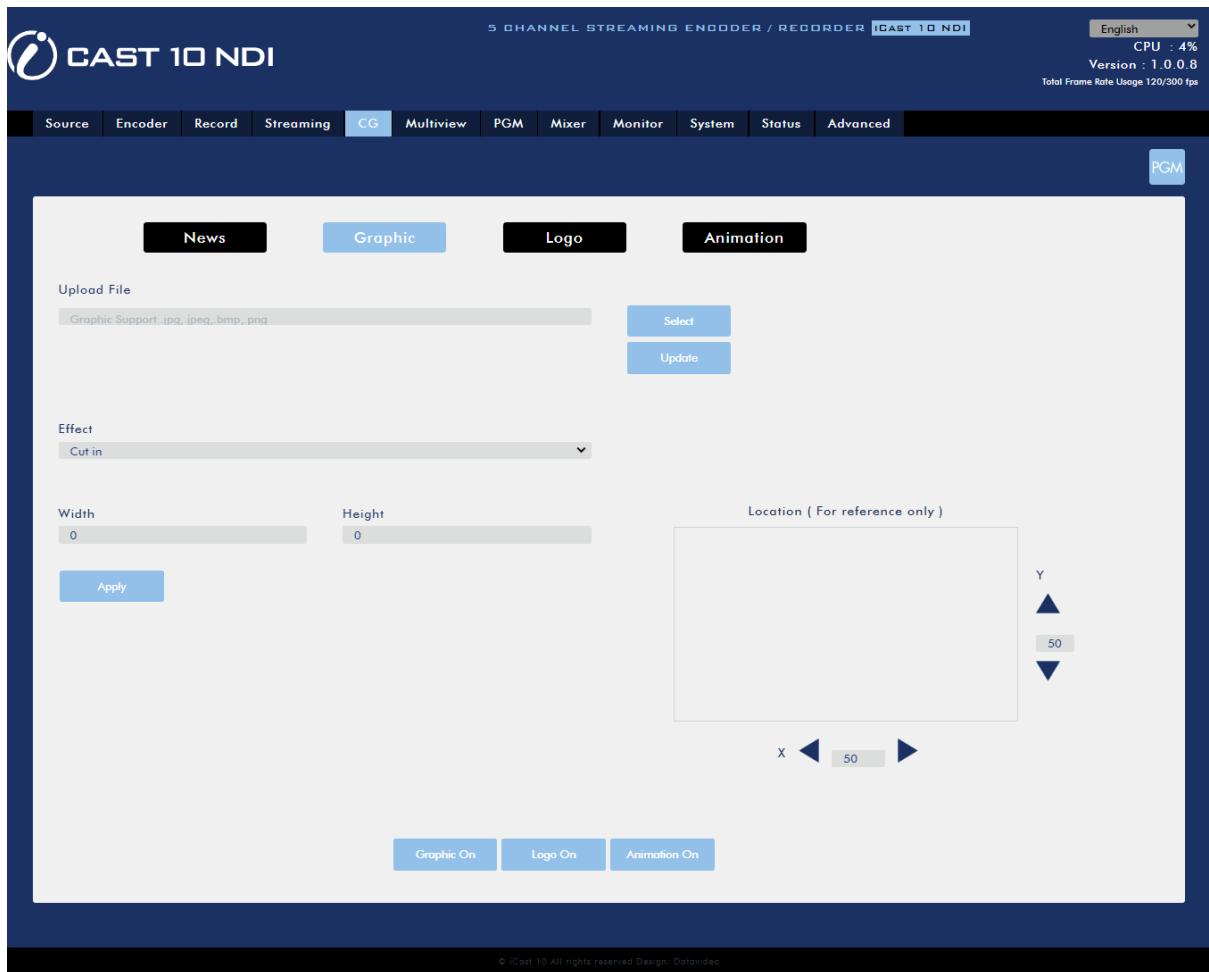

Logo

You can also add a logo to the video. You will be required to select a jpg, jpeg, bmp, png or gif file from your local hard disk. Click **Select** to browse the hard drive for your logo file then click **Update** to start the upload.

After the logo file has been successfully uploaded, you can adjust the size by entering appropriate values in the **Width** and **Height** fields.

The **Effect** drop-down list sets how the logo enters the video. Select “**Cut in**” if you want the logo to appear with no effect. If you want the logo to enter from either side of the screen, select “**Left to Right**” or “**Right to Left**”.

Lastly, set the coordinates of the logo. The position of the logo on the screen will be shown in the location box.

To enable the logo, simply click the **Logo ON** button which can be found at the bottom of the page.

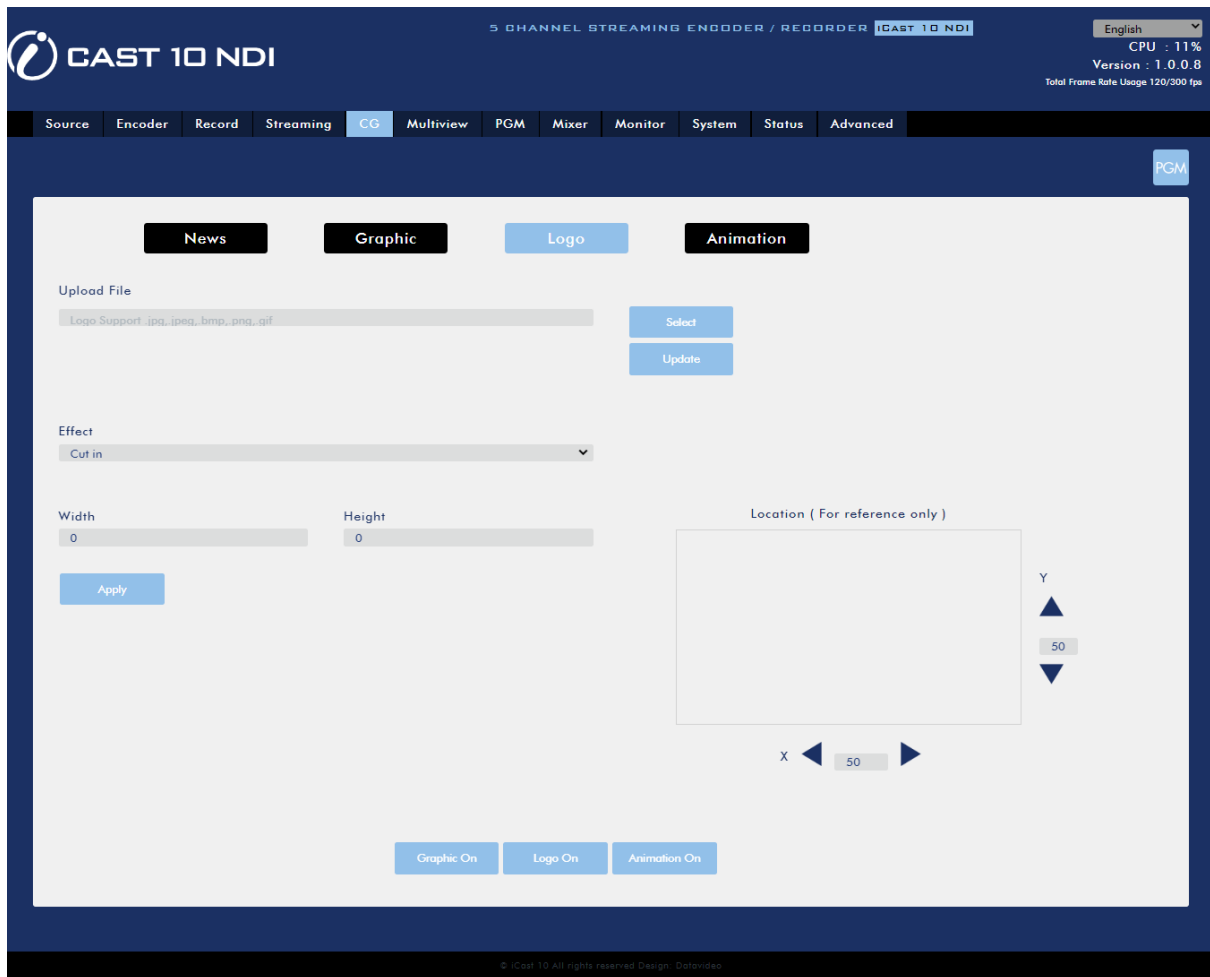

Animation

You can also add an animation to the video. You will be required to select a jpg, jpeg, bmp, png or gif file from your local hard disk. Click **Select** to browse the hard drive for your animation file then click **Update** to start the upload.

After the animation file has been successfully uploaded, you can adjust the size by entering appropriate values in the **Width** and **Height** fields.

The **Effect** drop-down list sets how the animation enters the video. Select “**Cut in**” if you want the animation to appear with no effect. If you want the animation to enter from either side of the screen, select “**Left to Right**” or “**Right to Left**”.

Lastly, set the coordinates of the animation. The position of the animation on the screen will be shown in the location box.

To enable the animation, simply click the **Animation ON** button which can be found at the bottom of the page.

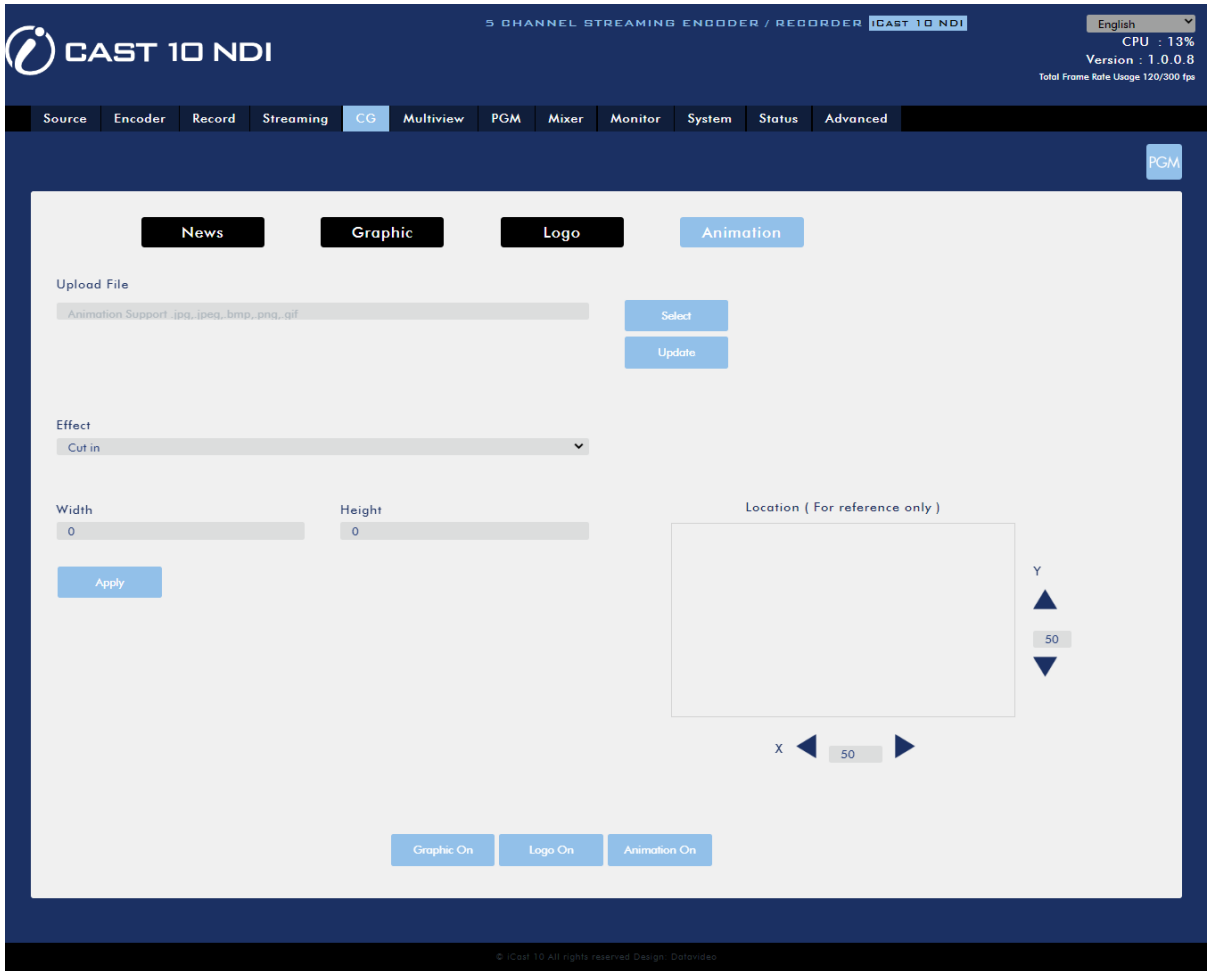

5.7 Multiview

Connect an HDMI monitor to the Multiview port then select a layout for the Multiview screen.

Note: Use Full Screen on the [program out](#) screen if the 4 x 1 layout is selected.

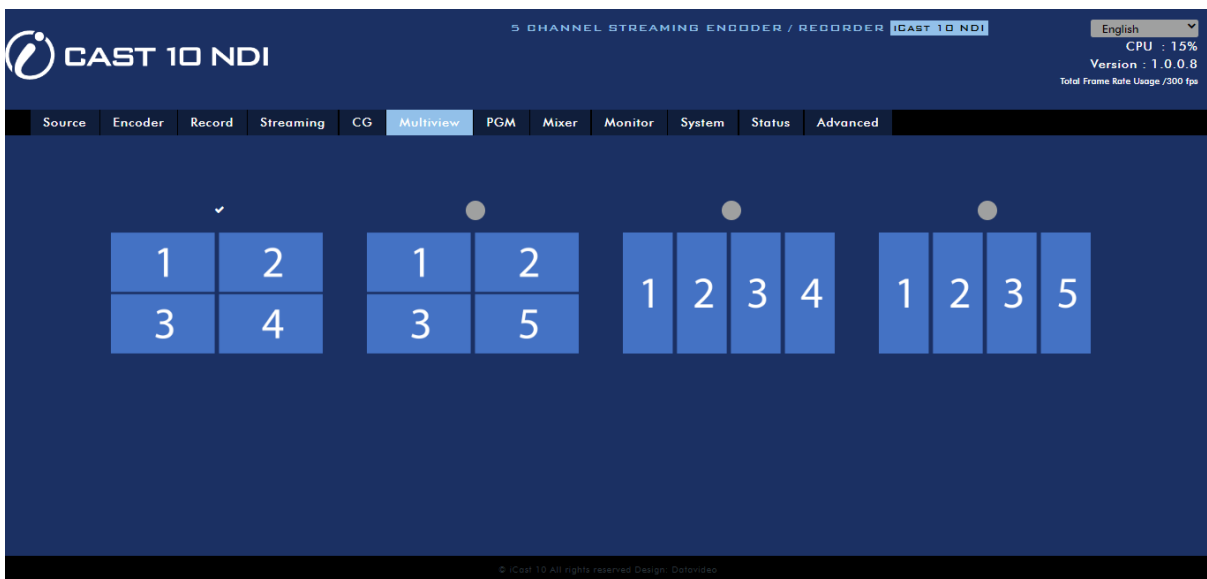

5.8 PGM

The PGM page allows you to set the Program OUT screen layout. The available layout options are Quad View, Full Screen, POP, Side By Side and PIP.

Quad View

In Quad View mode, the Program OUT screen will be switched to either a 2x2 or 4x1 Multiview layout. The corresponding program out buttons of the displayed input channels will illuminate red (1/2/3/4 or 5). Since the fourth quadrant is shared by channels 4 and 5, only the selected channel button will illuminate red and the unselected will illuminate white.



The input channel displayed in the fourth quadrant can be changed by clicking the respective layout icons as depicted in the diagram below. Alternatively, you can also press the respective MV button located on the front panel to switch between channels 4 and 5.

The screenshot shows the CAST 10 NDI PGM configuration page. The interface includes a navigation menu with options: Source, Encoder, Record, Streaming, CG, Multiview, PGM (selected), Mixer, Monitor, System, Status, and Advanced. The main content area displays five layout options: Quad View, Full Screen, POP, Side By Side, and PIP. Each layout option has a corresponding icon and a set of buttons labeled 1 through 5. The Quad View layout is highlighted with a red border, and its buttons are also highlighted with a red border. The PGM section at the bottom includes a Scale dropdown menu set to "Stretch" and a Background Color input field set to "R: 0. G: 0. B: 0". An "Apply" button is located below these settings.

Scale

The PGM OUT window can also be scaled. Click the “Scale” drop-down menu and select a scale from the list below:

- Stretch
- Fit
- Full

Background Color

You may either enter the RGB values or select a color from the color spectrum to set the screen’s background color. Then fine tune the selected color by dragging the circle cursor on the palette. Click the color wheel button at the bottom right corner to confirm the selection.

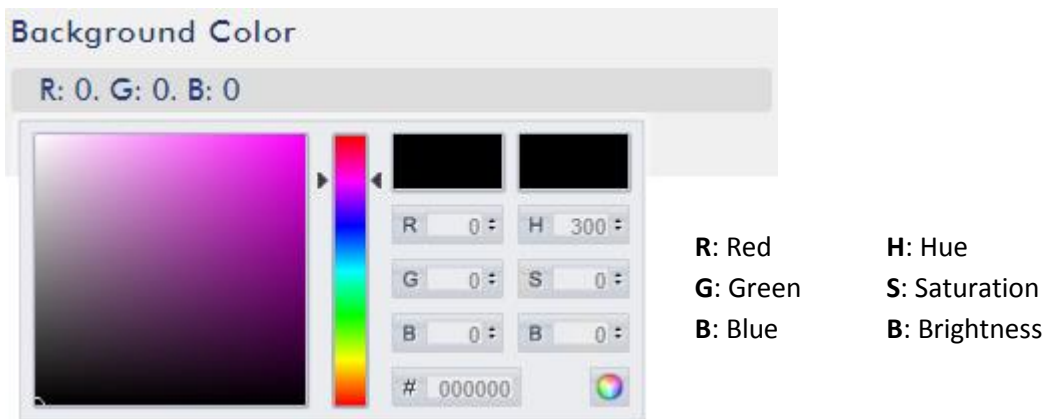

Full Screen

By selecting the full screen mode, only the selected channel video will be displayed on the monitor and the corresponding channel button on the front panel should illuminate red. Unselected channel buttons should illuminate white. You can click the channel buttons on the web UI as shown in the diagram below or press the channel buttons on the front panel to switch the program view. The displayed video should take up the entire screen.



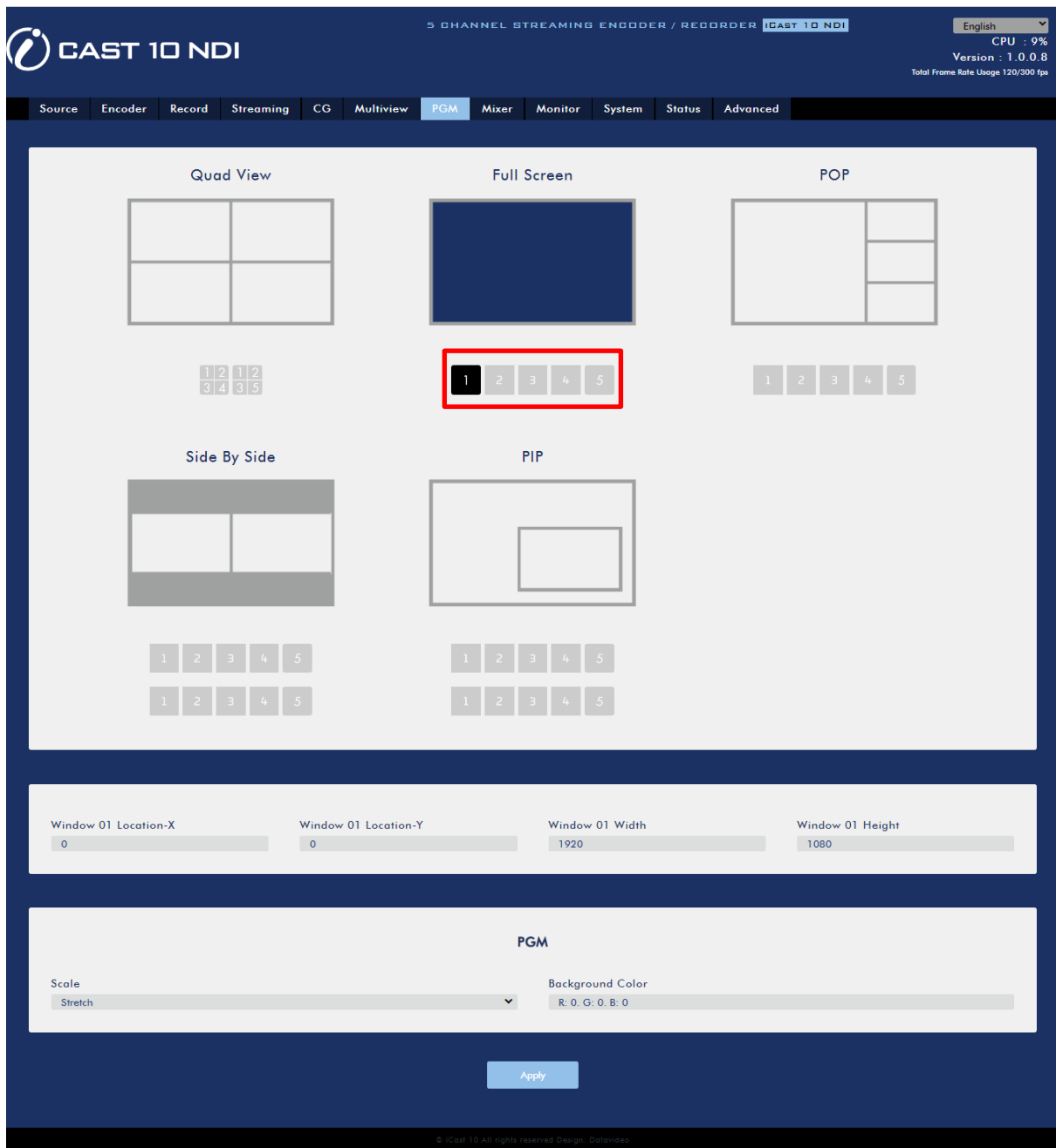

Window 01 Location X/Y

You can set the position of the PGM OUT window by setting the X/Y coordinates.

Window 01 Width/Height

Enter the appropriate width and height to set the size of the PGM OUT window.

Scale

The PGM OUT window can also be scaled by clicking a scale from the “Scale” drop-down menu below.

- Stretch
- Fit
- Full

Background Color

You may either enter the RGB values or select a color from the color spectrum to set the screen's background color. Then fine tune the selected color by dragging the circle cursor on the palette. Click the color wheel button at the bottom right corner to confirm the selection.

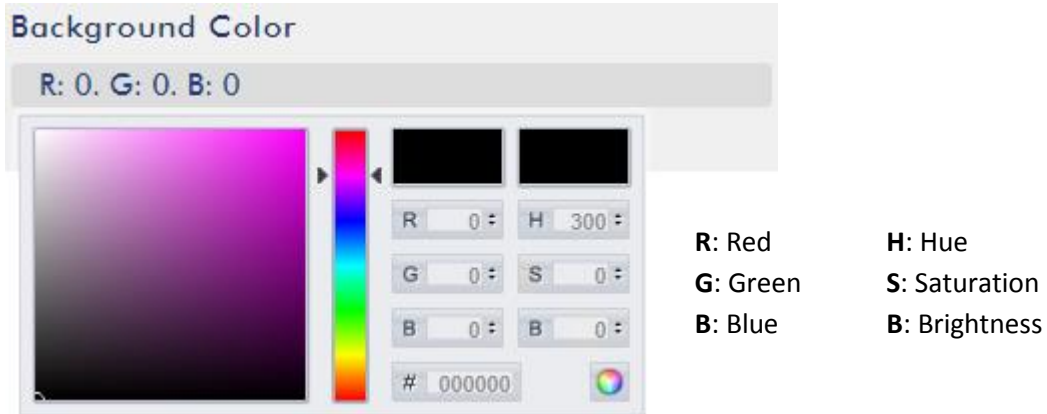

POP

The POP mode divides the program screen into two halves with only one channel video shown on the left and three channel videos shown on the right. You can click the channel buttons on the web UI as shown in the diagram



below or press the channel buttons on the front panel to switch the channel video shown on the left. The selected channel button should illuminate red with the unselected ones showing green.

CAST 10 NDI 5 CHANNEL STREAMING ENCODER / RECORDER **ICAST 10 NDI** English CPU : 9% Version : 1.0.0.8 Total Frame Rate Usage 120/300 fps

Source Encoder Record Streaming CG Multiview **PGM** Mixer Monitor System Status Advanced

Quad View

1 2 1 2
3 4 3 5

Full Screen

1 2 3 4 5

POP

1 2 3 4 5

Side By Side

1 2 3 4 5
1 2 3 4 5

PIP

1 2 3 4 5
1 2 3 4 5

Window 01 Location-X 0	Window 01 Location-Y 0	Window 01 Width 1400	Window 01 Height 1080
Window 02 Location-X 1400	Window 02 Location-Y 0	Window 02 Width 520	Window 02 Height 360
Window 03 Location-X 1400	Window 03 Location-Y 360	Window 03 Width 520	Window 03 Height 360
Window 04 Location-X 1400	Window 04 Location-Y 720	Window 04 Width 520	Window 04 Height 360

PGM

Scale: Stretch Background Color: R: 0, G: 0, B: 0

Apply

© ICast 10 All rights reserved Design: Doravidea

Window 01/02/03/04 Location X/Y

You can set positions of the PGM OUT windows by setting the X/Y coordinates.

Window 01/02/03/04 Width/Height

Enter the appropriate width and height to set the size for each PGM OUT window.

Scale

The PGM OUT window can also be scaled by clicking a scale from the “Scale” drop-down menu below.

- Stretch
- Fit
- Full

Background Color

You may either enter the RGB values or select a color from the color spectrum to set the screen’s background color. Then fine tune the selected color by dragging the circle cursor on the palette. Click the color wheel button at the bottom right corner to confirm the selection.

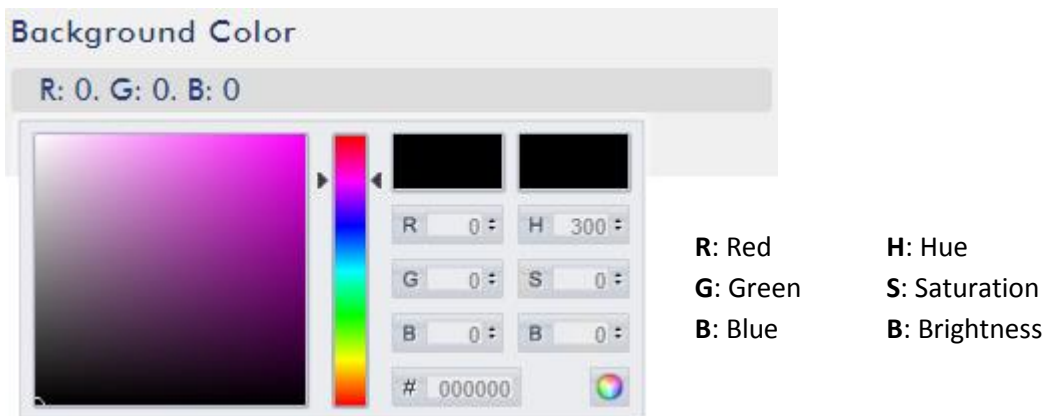

Side By Side

The Side By Side layout allows you to see two inputs next to each other. As shown in the diagram below, there are two rows of channel buttons in this mode. Click the top row of channel buttons to change the channel video shown on the left of the screen and you should see the corresponding channel button showing green on the front panel.

Click the bottom row of channel buttons to change the channel video shown on the right of the screen and you should see the corresponding channel button showing red on the front panel. If both sides of the screen display the same channel video, the corresponding channel button should show red. Buttons of the unselected channel should illuminate white.



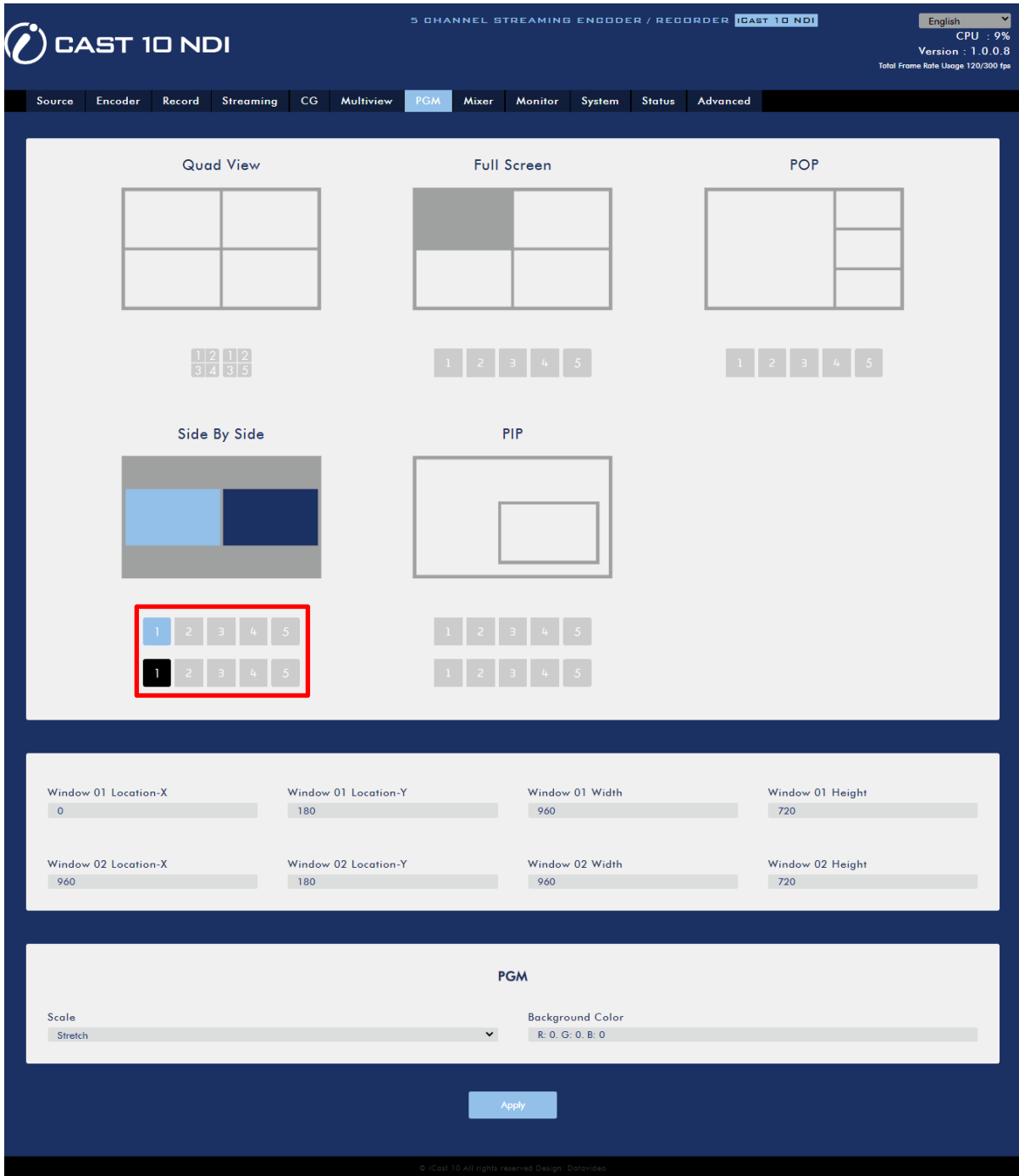

Window 01/02 Location X/Y

You can set positions of the PGM OUT windows by setting the X/Y coordinates.

Window 01/02 Width/Height

Enter the appropriate width and height to set the size for each PGM OUT window.

Scale

The PGM OUT window can also be scaled by clicking a scale from the “Scale” drop-down menu below.

- Stretch

- Fit
- Full

Background Color

You may either enter the RGB values or select a color from the color spectrum to set the screen's background color. Then fine tune the selected color by dragging the circle cursor on the palette. Click the color wheel button at the bottom right corner to confirm the selection.

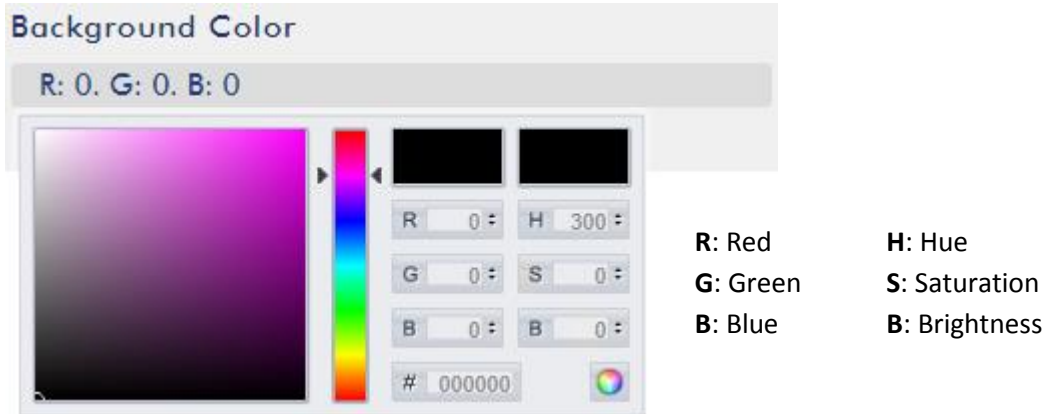

PIP

PIP stands for Picture In Picture. This allows you to be able to watch two separate inputs at one time. You will have one large picture with a smaller picture inside of it. As shown in the diagram below, there are two rows of channel buttons in PIP mode.



Click the top row of channel buttons to change the channel video shown in the background and you should see the corresponding channel button showing red on the front panel. Click the bottom row of channel buttons to change the channel video shown in the sub window and you should see the corresponding channel button showing green on the front panel. If the same channel video is shown in the background and the sub window, the corresponding channel button should show red. Buttons of the unselected channel should illuminate white.

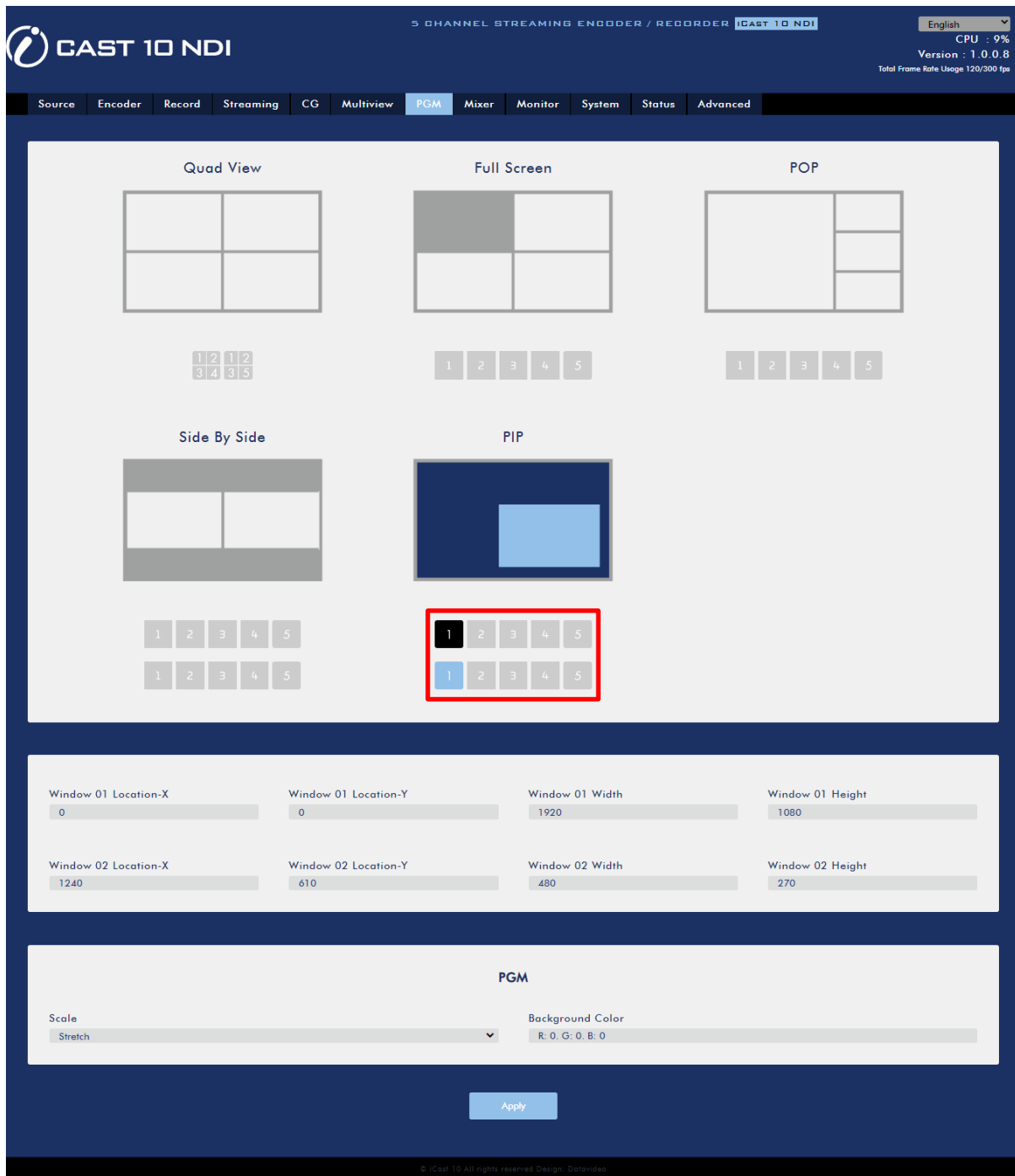

Window 01/02 Location X/Y

You can set positions of the PGM OUT windows by setting the X/Y coordinates.

Window 01/02 Width/Height

Enter the appropriate width and height to set the size for each PGM OUT window.

Scale

The PGM OUT window can also be scaled by clicking a scale from the “Scale” drop-down menu below.

- Stretch

- Fit
- Full

Background Color

You may either enter the RGB values or select a color from the color spectrum to set the screen's background color. Then fine tune the selected color by dragging the circle cursor on the palette. Click the color wheel button at the bottom right corner to confirm the selection.

The interface shows a color selection tool with a gradient palette on the left, a vertical color spectrum in the middle, and two black squares on the right. Below these are input fields for R (0), G (0), B (0), H (300), S (0), and B (0). A hex code field shows #000000. A legend to the right defines the abbreviations: R: Red, G: Green, B: Blue, H: Hue, S: Saturation, B: Brightness.

5.9 Mixer

In Mixer, you will be allowed to adjust the volume and delay of all audio channels.

Note: Volume of the UVC channel's audio cannot be adjusted (Still under development).

The screenshot shows the 'Mixer' tab in the CAST 10 NDI software. It features a 'Audio Default Settings' section and an 'Audio Source' section. The 'Audio Source' section contains 11 channels: HDMI/SDI CH1, HDMI CH2, HDMI CH3, HDMI CH4, USB CH5, XLR CH1, XLR CH2, Line-in Stereo, IP Stream1/NDI, IP Stream2/NDI, and MASTER. Each channel has a vertical volume slider with a blue knob and a 'Delay' button below it. The 'Line-in Stereo' and 'IP Stream1/NDI' channels have a 'Set' button. At the bottom, there are 'Apply' and 'Default' buttons. The top of the interface shows the 'CAST 10 NDI' logo, system status (CPU: 13%, Version: 1.0.0.8), and a navigation menu.

Volume

Use the audio sliders to adjust audio volumes of the input video channels as well as the external audio inputs.

There is an extra Stereo/Mono button for LINE-IN external audio input. When switched to mono, iCast 10NDI will automatically synchronize the left audio channel to the right.

You can assign an audio channel from four input video channels to the IP stream. Click the Set button and select from the list that opens.



Delay

Clicking the Delay button will open up a keypad shown below which allows you to enter the delay for the respective audio channels.

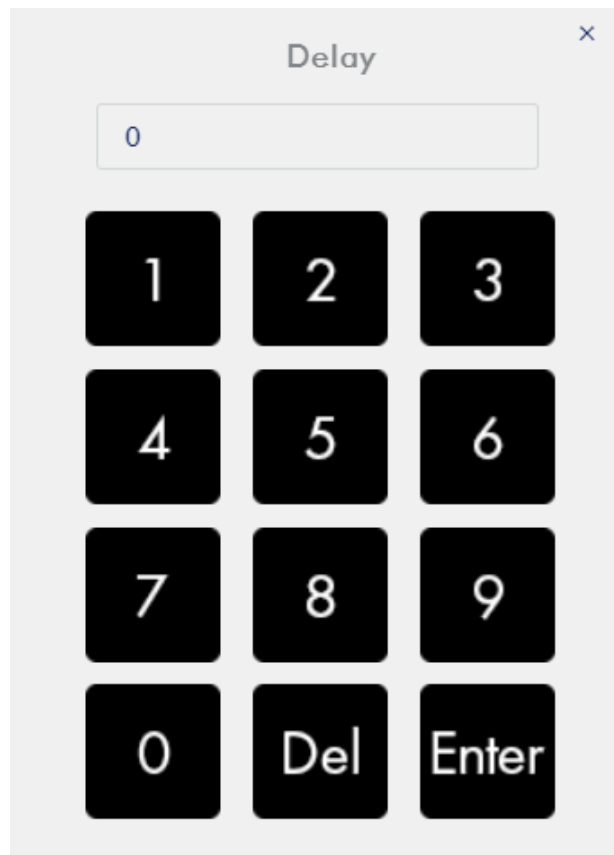

5.10 Monitor

HDMI 1 sets the frame rate of the HDMI Program output as well as the audio volume. HDMI 2 sets the volume of the HDMI Multiview output.

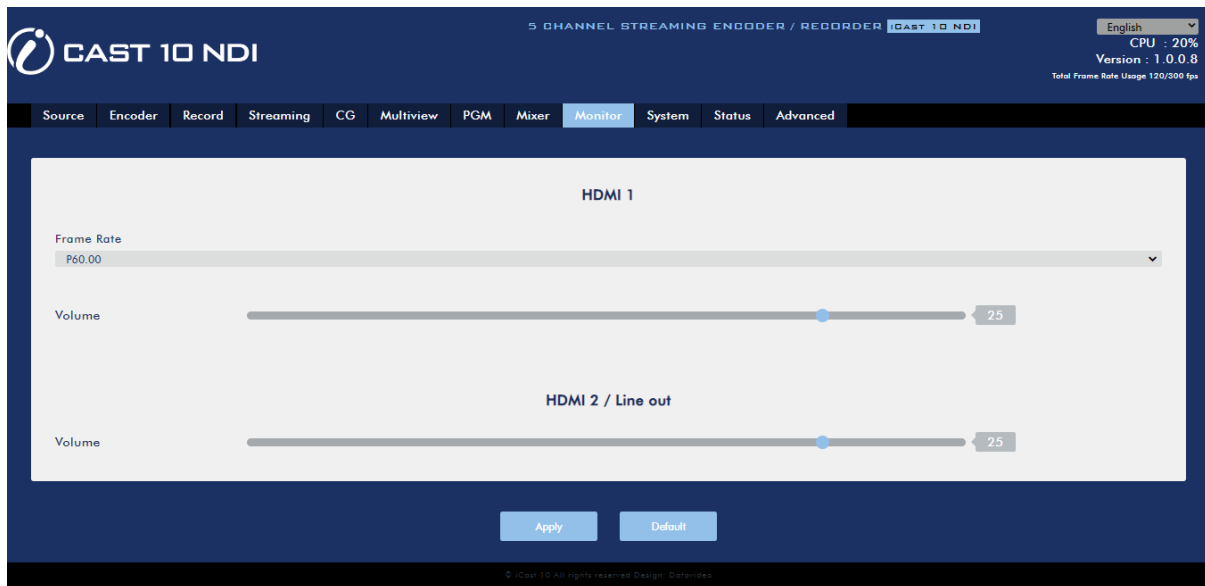

5.11 System

The system page allows the user to configure several network and system related settings.

The network settings are **DHCP enable/disable, static IP address, subnet mask, default gateway, primary and secondary DNS**, and etc.

The system settings are **account credentials, time setting, firmware update, disk format, device name, timeout period** and **auto streaming restart**.

The system page is shown in the diagram below.

Network Setting

Lan Port	eth0 LAN	Host IP Address	192.168.1.201
DHCP	Disable	Static IP	192.168.1.201
Subnet Mask	255.255.255.1	Default Gateway	192.168.1.1
Primary DNS	192.168.1.100	Secondary DNS	0.0.0.0

Apply Default

Account and Password

New Account	New Password	Apply
-------------	--------------	-------

Time Setting

Type	Automatically from the internet	Timezone	UTC+8	Apply
NTP Server	cn.pool.ntp.org			

Firmware Update

File Path	Browse
	Update

Disk Information

Device	Device0:	Apply
Format Type	FAT-32	Format

Device Name Setting

Device Name	Apply
-------------	-------

Other Option

Timeout Period	20 Min	Apply
Auto Streaming Restart	Disable	Apply

System Control

Restore to Default Reboot

Network Setting

In network settings, you can either manually enter the IP address or set the device to DHCP mode allowing the router to automatically assign the IP address to iCast 10NDI.

LAN Port

Select the Ethernet port from the list below:

- eth0: LAN
- eth1: WAN

Host IP Address

This field displays the IP address of the selected Ethernet port.

DHCP

In DHCP mode, the router automatically assigns the IP address to the device. If you want to manually configure the network settings, disable this option.

Static IP Address

If the DHCP is disabled, the static IP field will be activated for the user to manually enter the IP address. The static IP address is 192.168.1.201 by default.

Tip: If you do not know the device's IP address, you can always use the following method to reset the network settings.

- Shut down the machine
- Turn on the machine while holding down **RECORD** and **STREAM** buttons simultaneously.
- Approximately after 5 seconds, release the **RECORD** and **STREAM** buttons as soon as the button LEDs are turned **ON**.
- The default IP address should be 192.168.1.201.

Subnet Mask

Static IP address mode requires the **subnet mask**, which is 255.255.255.0 by default.

Default Gateway

Static IP address mode requires the **default gateway**, which is 192.168.1.254 by default.

Primary DNS (Optional)

Primary DNS is required in static IP mode only but is optional.

Secondary DNS (Optional)

Secondary DNS is required in static IP mode only but is optional.

Account and Password

Set the Web UI's login account name and password here. Click **Apply** to save the new login credentials.

Time Setting

In time setting, you are allowed to select the reference time source for the iCast 10NDI.

Type

In this drop-down menu, you can either select to allow the device to retrieve the time automatically from the Network Time Protocol (NTP) server by selecting “**Automatically from the Internet**” or locally by selecting “**Manual**”.

NTP Server

If you’ve selected “**Automatically from the Internet**,” you will need to enter the NTP server address here. An example of the NTP server address is time.google.com.

Manual

If you’ve selected “**Manual**”, the **Date** and **Time** fields will appear showing the device’s system date and time values. A calendar will appear after the **Date** field is clicked. Simply click a day to set the date. Set the time in the **Time** field.

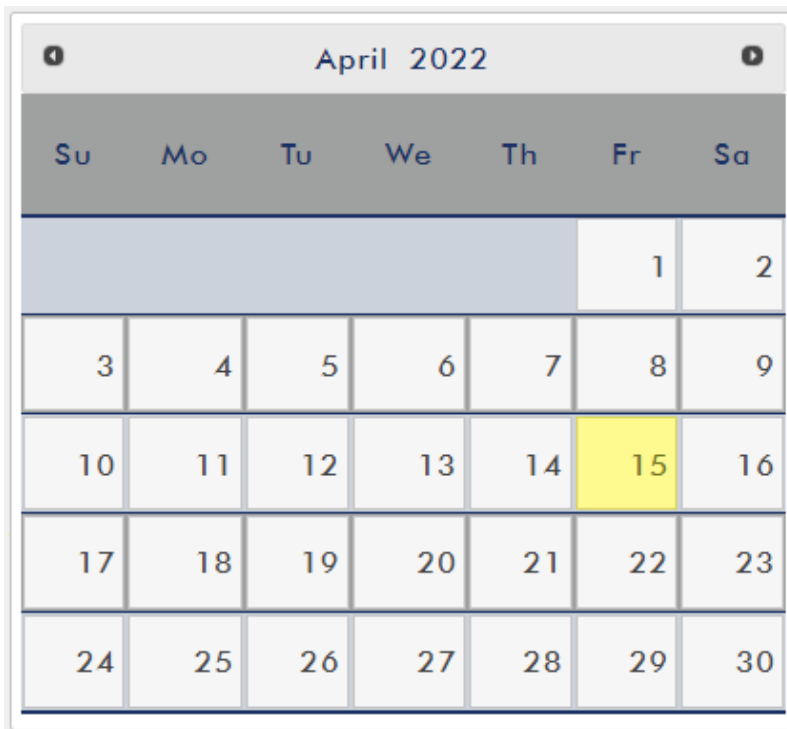

Time Zone

Click the drop-down menu to select a time zone for your device.

After you’ve configured the time settings, click **Apply** to save the new settings.

Firmware Update

Click **Browse** to search for the latest firmware file saved on the PC’s hard disk. After the latest firmware file is uploaded, click **Update** to start the firmware update. Please remove the connected UVC device before you start the firmware update.

Disk Information

In this pane, you will be allowed to view the disk information and format the inserted disk to one of the format types listed as follows:

- FAT-32
- EXFAT

Click **Format** to start formatting.

Device Name Setting

Enter a name for this device and click **Apply** to save the name.

Other Option

Set the login timeout interval and enable/disable auto stream here.

Timeout Period

This sets the timeout period for the current login. See below for available options.

- 20 Min
- 120 Min
- 1 Day
- 7 Day
- Never

Auto Streaming Restart

Enable/Disable auto stream here. Once enabled, your device will start streaming automatically as soon as it's powered up.

System Control

In System Control, you can choose to reset or reboot the device.

Restore to Default

Click to restore the system's default settings.

System Reboot

Click to reboot the iCast 10NDI.

5.12 Status

The status page shows **Input**, **Record**, **Stream** and **Disk** information as depicted in the diagram below.

Note: The iCast 10NDI web UI does not update automatically so to learn the latest device status, please refresh the page manually.

Input Information

	Video Source	Audio Source	Resolution	Frame Rate	Channels	Bits Per Sample	Sample Frequency
Channel 1	HDMI	Embedded	NA	NA	NA	NA	NA
Channel 2	HDMI	Embedded	NA	NA	NA	NA	NA
Channel 3	HDMI	Embedded	NA	NA	NA	NA	NA
Channel 4	HDMI	Embedded	NA	NA	NA	NA	NA
Channel 5	UVC	Embedded	NA	NA	NA	NA	NA

Record Status

		Encoder Source	Resolution	Frame Rate	Video Bitrate (bps)	Audio Bitrate (bps)
Channel 1	Main	NA	NA	NA	NA	NA
	Sub	NA	NA	NA	NA	NA
Channel 2	Main	NA	NA	NA	NA	NA
	Sub	NA	NA	NA	NA	NA
Channel 3	Main	NA	NA	NA	NA	NA
	Sub	NA	NA	NA	NA	NA
Channel 4	Main	NA	NA	NA	NA	NA
	Sub	NA	NA	NA	NA	NA
Channel 5	Main	NA	NA	NA	NA	NA
	Sub	NA	NA	NA	NA	NA
PGM	Main	NA	NA	NA	NA	NA
	Sub	NA	NA	NA	NA	NA

Stream Status

		Encoder Source	Resolution	Frame Rate	Video Bitrate (bps)	Audio Bitrate (bps)
Channel 1	Main	NA	NA	NA	NA	NA
	Sub	NA	NA	NA	NA	NA
Channel 2	Main	NA	NA	NA	NA	NA
	Sub	NA	NA	NA	NA	NA
Channel 3	Main	NA	NA	NA	NA	NA
	Sub	NA	NA	NA	NA	NA
Channel 4	Main	NA	NA	NA	NA	NA
	Sub	NA	NA	NA	NA	NA
Channel 5	Main	NA	NA	NA	NA	NA
	Sub	NA	NA	NA	NA	NA
PGM	Main	Main	1920x1080p	60	6M	256K
	Sub	Disable				

Disk Information

	Name	Size	Format Type	Status	Available
Device	NA	NA	NA	NA	NA

While monitoring streaming and recording, please update the page periodically regardless of how you operate the device (using the device's physical buttons only or using the device's physical buttons along with the web UI). This ensures the page is always displaying the most up-to-date information.

5.13 Advanced

In Advanced, you will be allowed to select up to 10 separate streams for an input channel.

First select the input video channel from the **Video Source** drop-down menu then check the stream servers that you would like to use to deliver the channel video to your viewers. Stream 1 corresponds to main and sub stream servers of input video channel 1, stream 2 corresponds to main and sub stream servers of input video channel 2, and so forth.

The encoders can be configured on the Encoder page. See [Section 5.3 Encoder](#) for details.

The screenshot displays the 'Advanced' configuration page for CAST 10 NDI. The top navigation bar includes tabs for Source, Encoder, Record, Streaming, CG, Multiview, PGM, Mixer, Monitor, System, Status, and Advanced. The top right corner shows system information: English, CPU: 10%, Version: 1.0.0.8, and Total Frame Rate Usage: 120/300 fps. The main content area is titled 'Advanced' and features a 'Video Source' dropdown menu set to 'CH1 Input'. Below this is an 'Encoder Source' table with 5 streams, each having 'Main' and 'Sub' options with checkboxes. At the bottom, there are 'Start Stream' and 'Stop Stream' buttons.

Stream	Encoder Source	Checkbox
Stream 1	Main	<input type="checkbox"/>
	Sub	<input type="checkbox"/>
Stream 2	Main	<input type="checkbox"/>
	Sub	<input type="checkbox"/>
Stream 3	Main	<input type="checkbox"/>
	Sub	<input type="checkbox"/>
Stream 4	Main	<input type="checkbox"/>
	Sub	<input type="checkbox"/>
Stream 5	Main	<input type="checkbox"/>
	Sub	<input type="checkbox"/>

Chapter 6 Video Streaming and Recording

The iCast 10NDI five channel all-in-one streaming switcher allows the user to stream and record your program at the same time. From any SDI/HDMI input sources, the video streaming server generates an H.264 encoded stream that is compliant with RTSP or RTMP protocols. While encoding the video at bit rates appropriate for live streaming, the video streaming server concurrently records a high-quality MP4 file to a 2.5” hard disk. **Please note that MP4 files can be played on most devices but if any parts of the file is corrupted, you will then not be able to play back the entire video.**

6.1 Video Streaming

In this section, we will discuss how you can play the video using different streaming protocols and how to place texts on your video. For configuration of the streaming encoders and information about various streaming protocols, see [Section 5.3 Encoder](#) and [Section 5.5 Streaming](#).

RTSP/TS/HLS

The stream server allows any client device to connect and playback your video stream in **RTSP, TS or HLS** mode.



The following operation procedure uses VLC media player to playback video stream. If your PC or laptop does not have VLC media player installed, please visit VideoLAN’s official homepage (<https://www.videolan.org/>) and download the installation file then install the program.

Follow the steps below to obtain the RTSP URL:

1. On the web UI, click the “**Streaming**” tab to open the stream settings page.
2. Select a stream engine then the encoder from the **Encoder Source** drop-down menu. See [Section 5.3 Encoder](#) for setup of main and sub encoders.
3. Select **RTSP** from the **Stream Type** drop-down menu.

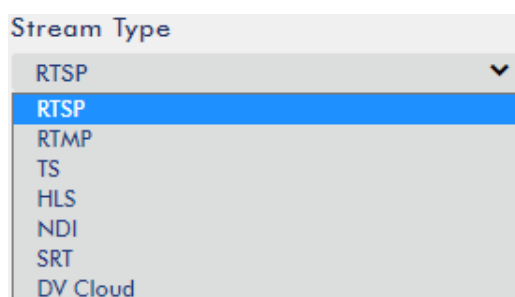

4. Click the **Start Stream** button to generate the RTSP URL.



5. Based on your settings, the device will automatically generate the RTSP URL **rtsp://root:root@192.168.1.201:556/session0.mpg**.

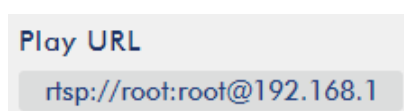

- To view the RTSP video stream, enter the RTSP URL into the client device.
- Open VLC then click **Open Network Stream** (shown in the diagram below).

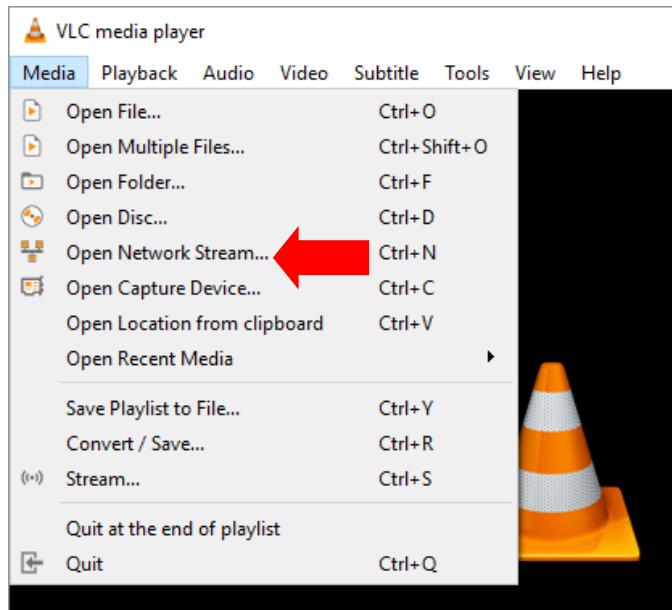

- As shown in the diagram below, enter the stream URL then click **Play** to start streaming.

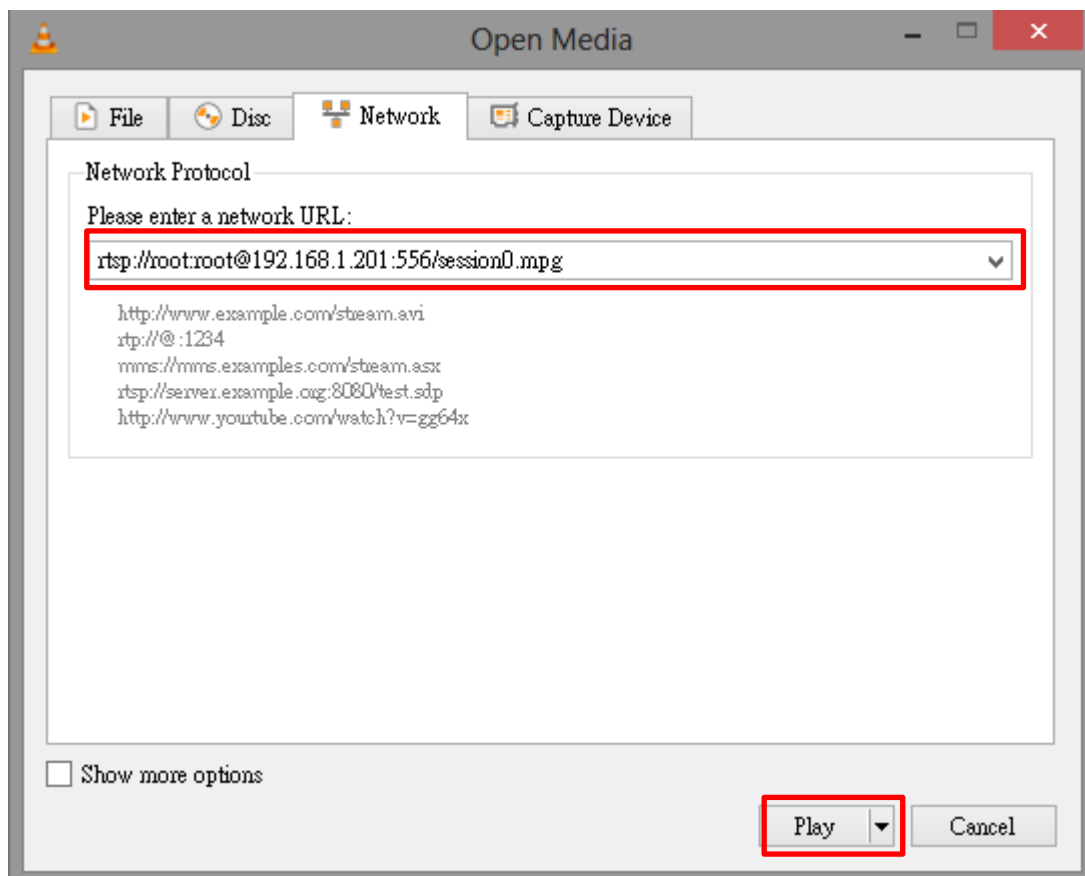

Follow the steps below to obtain the TS URL:

1. On the web UI, click the “**Streaming**” tab to open the stream settings page.
2. Select a stream engine then the encoder from the **Encoder Source** drop-down menu. See [Section 5.3 Encoder](#) for setup of main and sub encoders.
3. Select **TS** from the **Stream Type** drop-down menu.

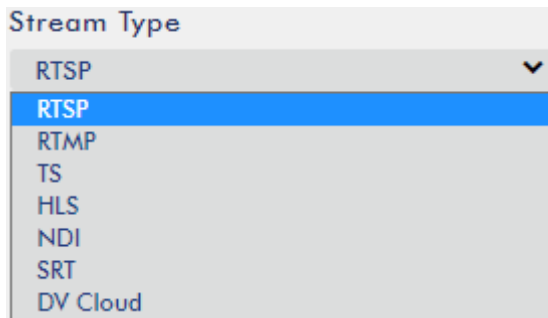

4. Enter the TS URL. Note that the TS URL shown below is only for illustration purpose.



5. Click the **Start Stream** button to start the stream and generate the TS play URL shown below.



6. Enter the TS play URL into the client device to which the video stream is delivered over the TS protocol.
7. On the computer, open VLC then click **Open Network Stream** (shown in the diagram below).

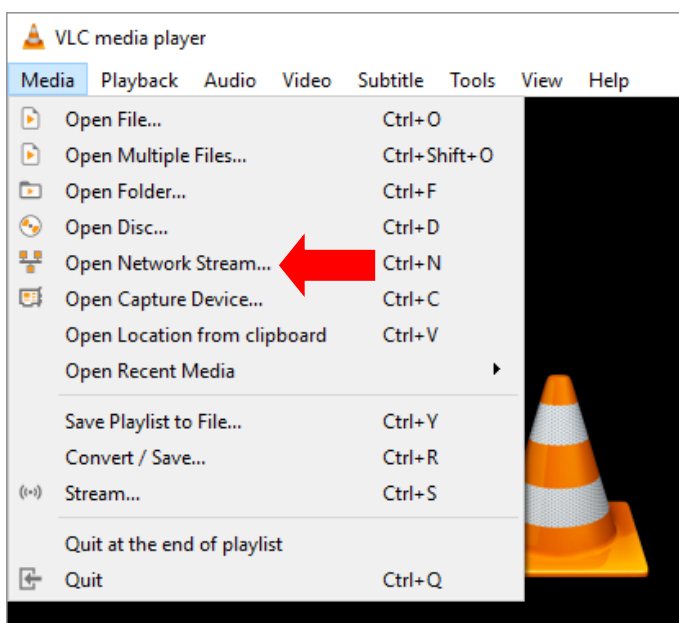

- As shown in the diagram below, enter the stream URL then click **Play** to start streaming.

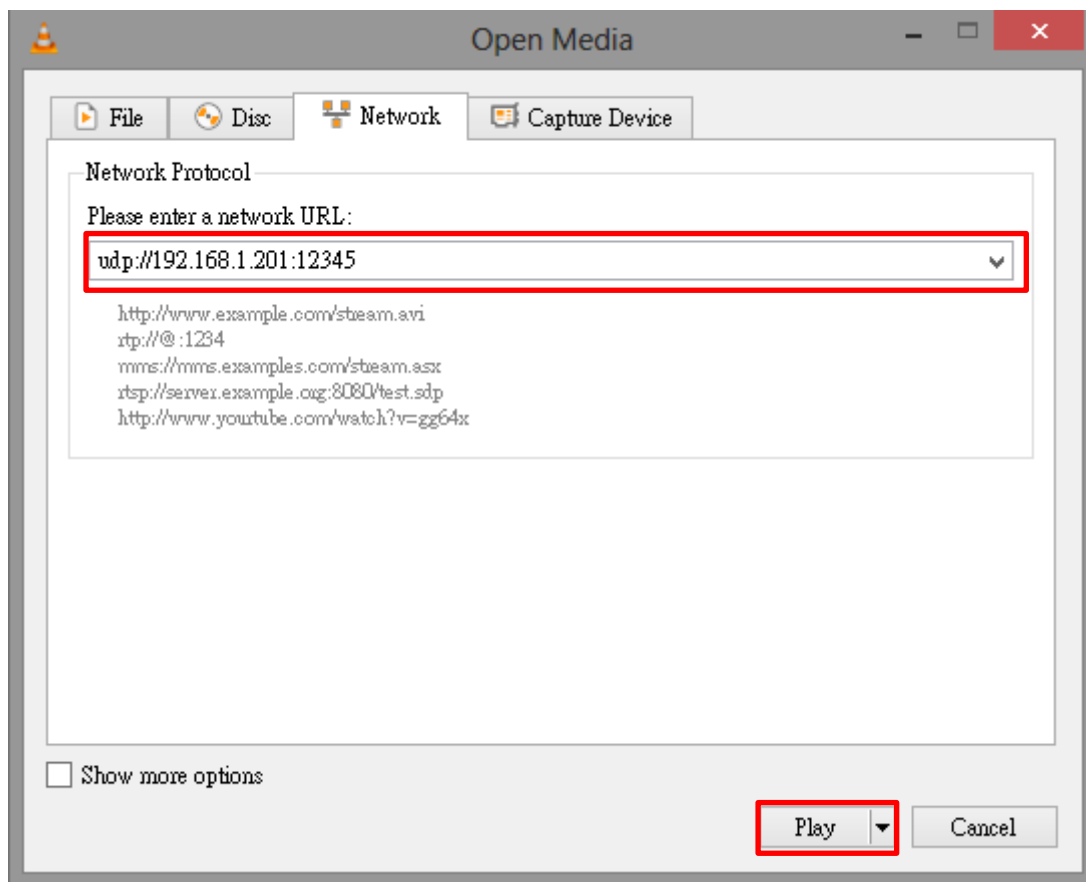

Follow the steps below to obtain the HLS URL:

- On the web UI, click the **“Streaming”** tab to open the stream settings page.
- Select a stream engine then the encoder from the **Encoder Source** drop-down menu. See [Section 5.3 Encoder](#) for setup of main and sub encoders.
- Select **HLS** from the **Stream Type** drop-down menu.

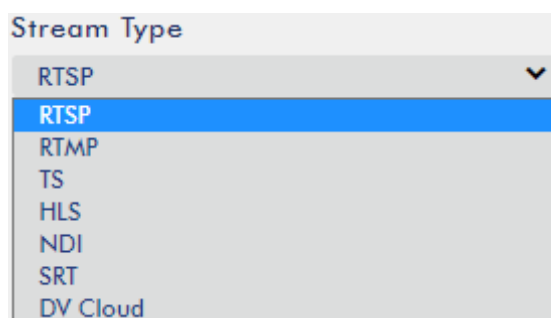

- Click the **Start Stream** button to start the stream.
- Based on your settings, the device will automatically generate a .m3u8 stream URL:
http://192.168.1.201/hls/2/session0.m3u8
- Enter the **HLS** URL into the client device.
- Open VLC then click **Open Network Stream** (shown in the diagram below).

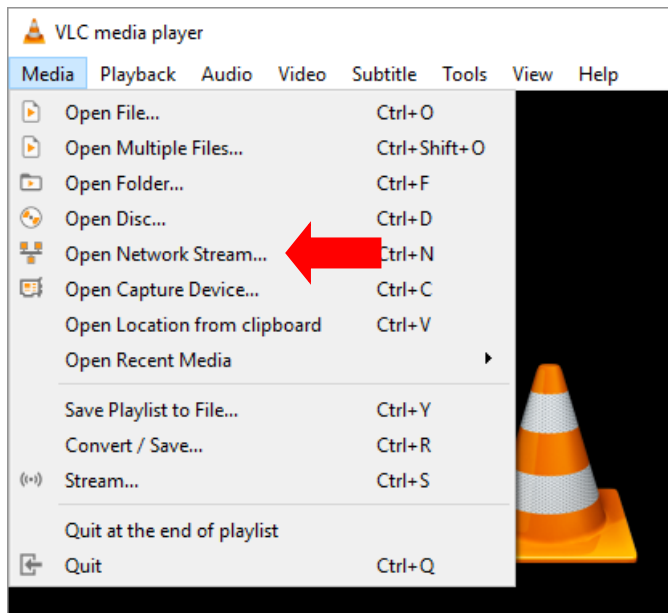

8. As shown in the diagram below, enter the stream URL then click **Play** to start streaming.

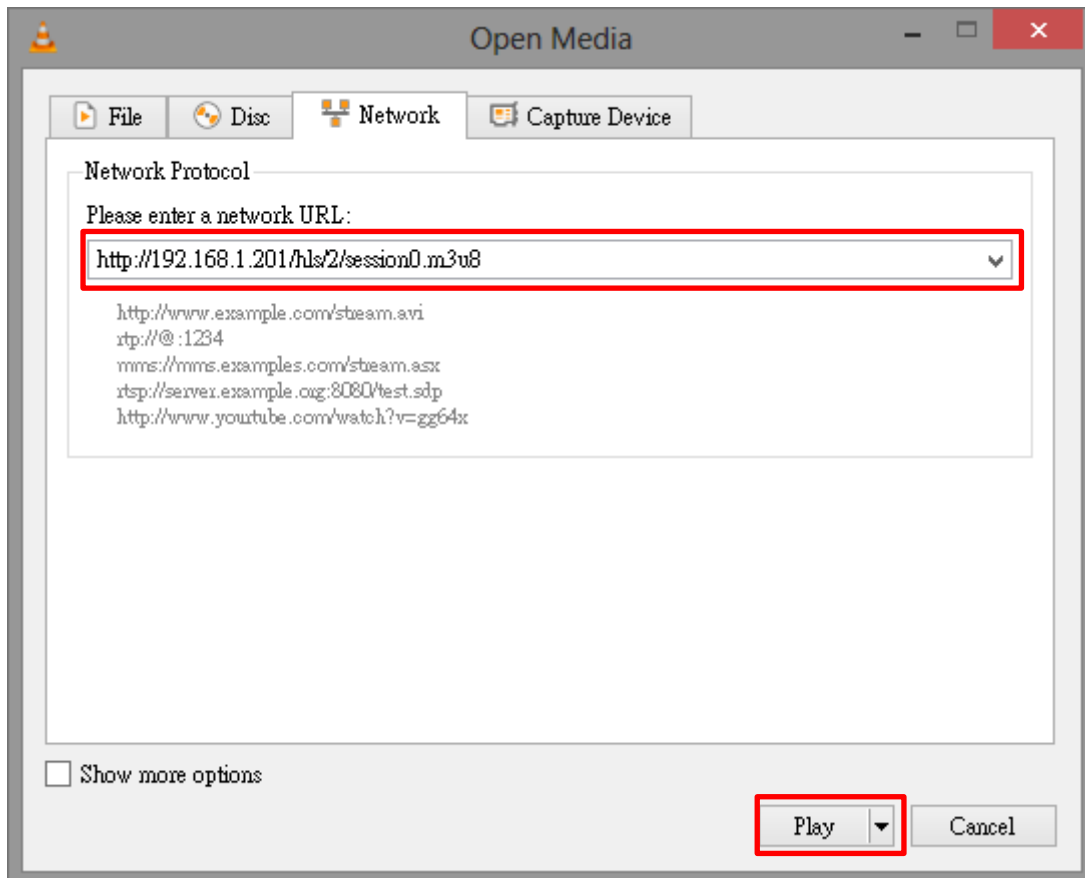

9. You can also play .m3u8 stream URL using the devices listed as follows:

- iPhone, iPad and MacBook: Use Safari to open the .m3u8 stream URL.
- Windows 10: Use Microsoft Edge to open the .m3u8 stream URL.

RTMP

In the **RTMP** mode, the iCast 10NDI can send up to two data streams to multiple CDNs or media servers that support the **Real-Time Messaging Protocol**. Examples of the **RTMP** media server are **USTREAM** and **Youtube**.

Note: The iCast 10NDI does not support RTMP local.

In this section, we will show you how to set up an **RTMP** stream to **Youtube**. The step-by-step account setup is outlined as follows:

1. First, obtain the Server URL and Stream name/key from Youtube.
2. Open the Youtube Live Dashboard https://www.youtube.com/live_dashboard
3. On the left column, locate and click “**Stream now.**”

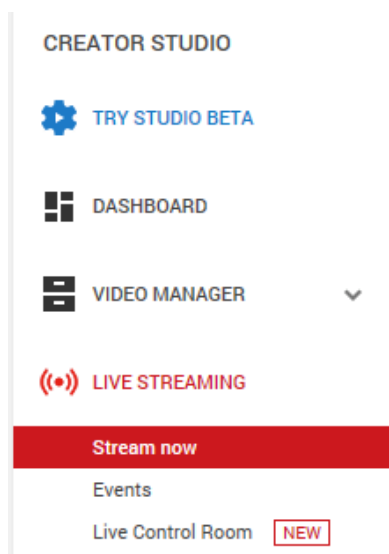

4. On the right, scroll down to the bottom where you will be able to find **Server URL** and **Stream name/key**.

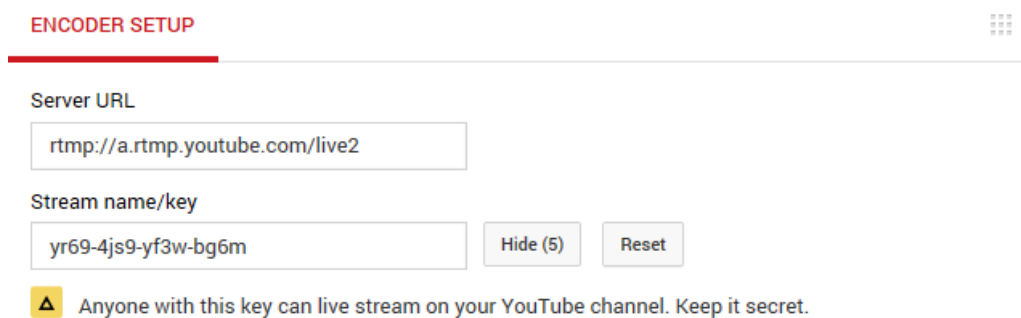

5. On the iCast 10NDI, open the **Streaming** page.
6. Select a stream engine then the encoder from the **Encoder Source** drop-down menu. See [Section 5.3 Encoder](#) for setup of main and sub encoders.
7. Select **RTMP** from the Stream Type drop-down menu.

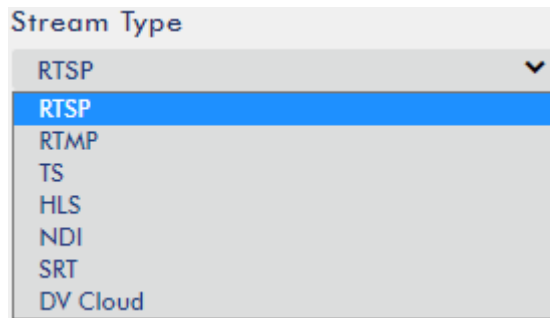

8. Enter the **Server URL** (`rtmp://a.rtmp.youtube.com/live2`) obtained from the **Youtube Live Streaming** page into the **RTMP URL** field.

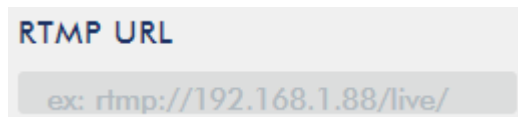

9. Enter the **Stream name/key** (`yr69-4js9-yf3w-bg6m`) obtained from the **Youtube Live Streaming** page into the **StreamName** field.



10. As required by the live streaming channel, enter your Youtube account name and password into the **Account** and **Password** fields.



11. Click the **Start Stream** button to start streaming the live video to the **Youtube Live**. You should also see an **RTMP URL** generated.

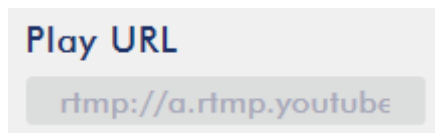

12. At this point, you should be able to view your stream video on Youtube.
13. To stop live streaming, simply click the **Stop Stream** button.

SRT

When setting up an SRT stream on iCast 10NDI, you can configure it as an SRT source encoder (caller mode) or an SRT destination decoder (listener mode).

To establish an SRT link between the source and destination devices, ensure that one device is a Listener and the other is a Caller. The device you set as the caller or listener is entirely arbitrary.

To access the device's SRT settings, log in to the web UI, select the **"Streaming"** tab, then **follow the steps below to set up the SRT traffic:**

1. Select a stream engine then the encoder from the **Encoder Source** drop-down menu. See [Section 5.3 Encoder](#) for setup of main and sub encoders.
2. Select **SRT** from the first **Stream Type** drop-down menu.



3. Locate the second **Stream Type** drop-down menu in which you will be able to set the device to the Caller (source) or Listener (destination) mode.

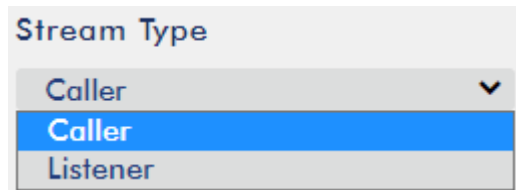

- a. If Caller is selected, do the following:
 - In the **IP Address and SRT Port** fields, enter the IP address and the port number of the destination device (decoder) respectively. If your SRT stream destination is a CDN or media server, the IP address and the port number should be provided by the service provider.
 - In the **Latency** field, enter the amount of latency to apply to the stream. The default value is 1000 ms.
 - b. If Listener is selected, simply enter a port number that you intend to use on this device for the SRT stream.
4. Click the **Start Stream** button to start the SRT stream.

NDI

NDI (Network Device Interface) is an open protocol developed by NewTek to enable video compatible products to share video across a local area network. The full bandwidth NDI is not supported by iCast 10NDI. Instead, iCast 10NDI only offers NDI|HX which is basically a low bandwidth version of NDI.

Before streaming to any NDI destination devices, you will need to first make sure the NDI video players and the iCast 10NDI are on the same network. Please also note that only one encoder (main or sub) will be enabled for the input video channel if NDI is chosen.

To access the device's NDI settings, log in to the web UI, select the **"Streaming"** tab, then **follow the steps below to set up the NDI traffic:**

1. Select a stream engine then the encoder from the **Encoder Source** drop-down menu. See [Section 5.3 Encoder](#) for setup of main and sub encoders.
2. Select **NDI** from the **Stream Type** drop-down menu. Please also note that only one encoder (main or sub) will be enabled for the input video channel if NDI is chosen.

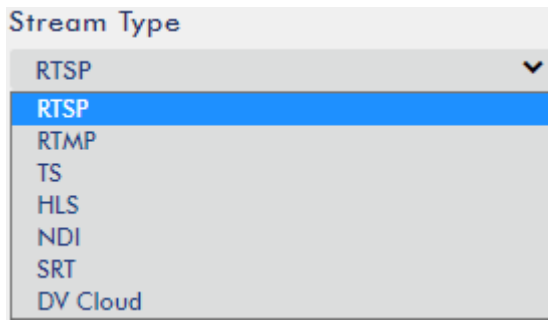

3. Specify a name for your NDI encoder in the **NDI Name** field.

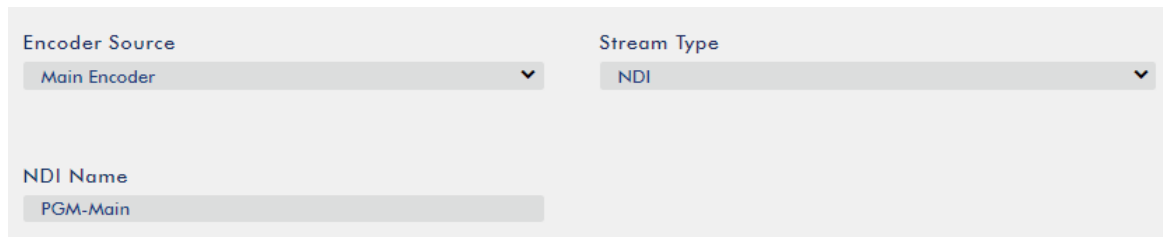

4. Click the **Start Stream** button to start the NDI stream.

6.2 Record/Stream Buttons

The **RECORD** and **STREAM** buttons on the front panel of the iCast 10NDI give the user certain controls of the record and stream functions. In this section, we will cover operations of these two buttons in detail.



Press and hold the **Record** button for at least one second to start/stop recording.

Press and hold the **Stream** button for at least one second to start/stop streaming.



Please note the following:

- If the Record or Stream button illuminates white, the function is turned off.
- If the Record or Stream button shows blinking red, the function is activating.
- If the Record or Stream button turns solid red, the device is recording or streaming.

During recording or streaming, if the **Stream** or **Record** button turns from solid red to blinking red, check the 2" LCD screen for error codes.

6.3 Restore Factory Defaults

On the system page of the web UI, scroll down to **System Control** in which you should be able to find the **Restore to Default** button. Click to restore the iCast 10NDI's factory defaults.

Chapter 7 Appendices

Appendix 1 Pinout Information for RS-232 Connectors

External devices such as remote controllers can be connected to the iCast 10NDI through the RS-232 interface using a custom Ethernet cable. The RS-232 connection wiring scheme is shown below.

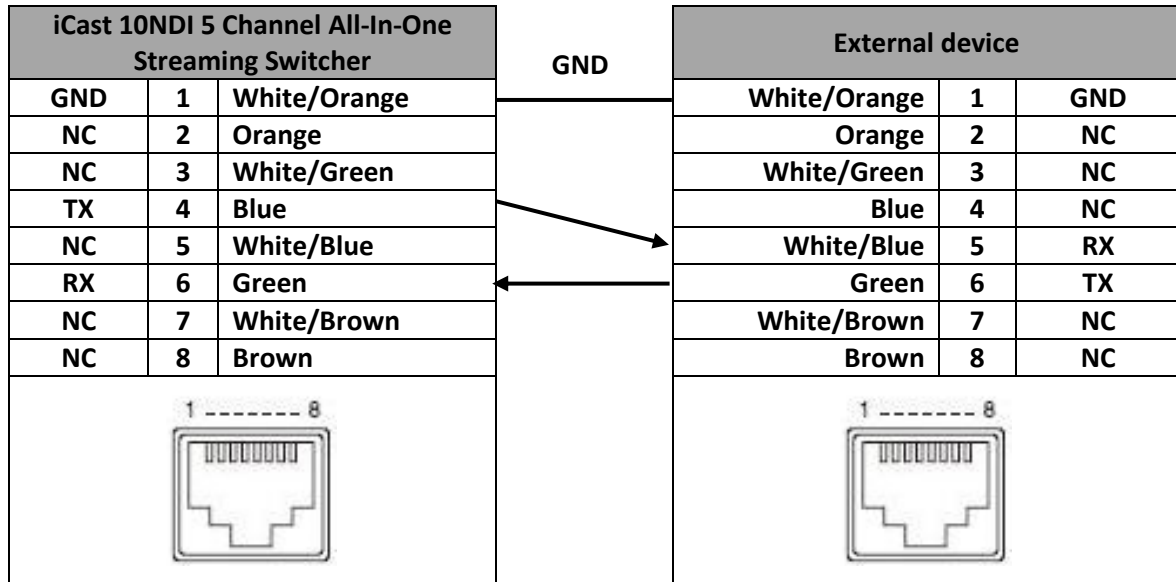

Appendix 2 **Firmware Upgrade**

Datavideo usually releases new firmware containing new features or reported bug fixes from time to time. Customers can either download the iCast 10NDI firmware as they wish or contact their local dealer or reseller for assistance.

This section outlines the firmware upgrade process which should take **approximately 10 minutes to complete**. The existing iCast 10NDI settings should persist through the **firmware upgrade process, which should not be interrupted once started** as this could result in a non-responsive unit.

Successful firmware upgrade on iCast 10NDI requires:

- iCast 10NDI x 1
- 12V Power adapter x 1
- PC x 1
- Latest firmware file

Please remove the connected UVC device before you start the firmware update.

Update Procedure

1. Download the latest firmware files from the official product page.
2. Save the files on the PC.
3. Open the web UI then select System → Firmware Update



The screenshot shows a web interface for a firmware update. At the top, the title "Firmware Update" is displayed in blue. Below the title, the label "File Path" is shown in blue. Underneath the label is a light gray text input field. To the right of the input field, there are two blue buttons: "Browse" and "Update".

4. Click **Browse** to search for the latest firmware file saved on the PC's hard disk then upload the latest firmware file to iCast 10NDI.
5. The iCast 10NDI will perform the firmware upgrade automatically and restart as soon as the upgrade is complete.

Appendix 3 **Frequently-Asked Questions**

This section describes problems that you may encounter while using iCast 10NDI. If you have any questions, please refer to related sections and follow the suggested solutions. If problem still exists, please contact your distributor or the service center.

No.	Problems	Solutions
1.		

Appendix 4 Dimensions

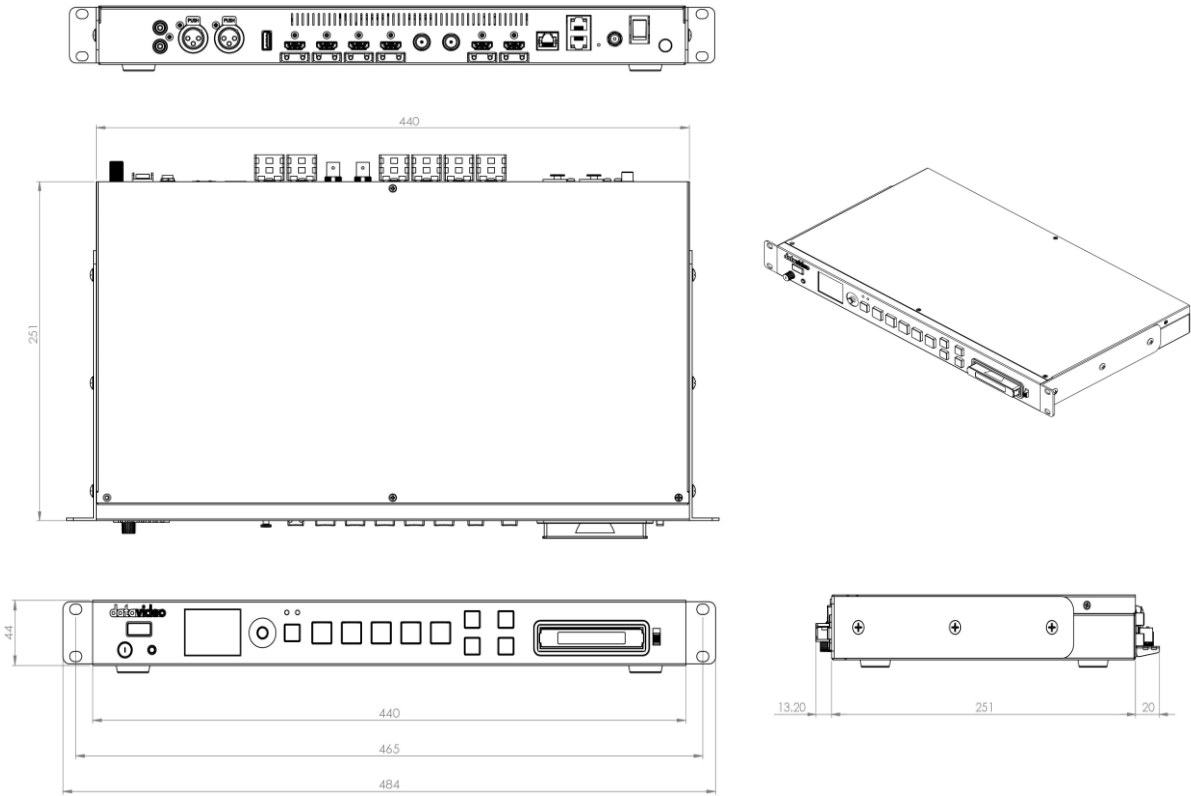

All measurements in millimeters (mm)

Appendix 5 Specifications

Model Name	iCast 10NDI
Product Name	5 Channel All-In-One Streaming Switcher
Video Standard	HD & SD
Video Format	Input: 1080p: 60/59.94/50/30/29.97/25/24/23.98 1080i: 60/59.94/50 720p: 60/59.94/50 480i59.94, 576i50 Output: 1080p60/59.94/50→1080p60/59.94/50 1080p30/29.97/25/24/23.98→1080p30/29.97/25/24/23.98 1080i60/59.94/50→1080p30/29.97/25 720p60/59.94/50→720p60/59.94/50 480i59.94, 576i50→480p29.97, 576p25 (not supporting interlace)
Video Processing	N/A
Input Routable / Crosspoint	N/A
Video Input	1 x 3G/HD/SD-SDI (BNC 75 ohm) 4 x HDMI 1.4 (Channel 1 as SDI/HDMI selectable) 1 x USB 3.0 3 x RTSP/SRT/NDI I HX via IP Stream
Mix HD & SD Source	Yes
Computer Graphic Interface	4 via HDMI
Video Output	1 x 3G/HD/SD-SDI loop-through 1 x HDMI 1.4 (PGM) 1 x HDMI 1.4 (Multiview) 2 x RJ-45 female (10/100/1000M Ethernet) (LAN & WAN)
Down-Converted Output	1080p output
Built-in Multiview Monitoring Out	HDMI x 1
Analogue Audio Input	XLR Balanced audio x 2 RCA Unbalanced audio x 1 pair SDI embedded audio HDMI embedded audio IP Audio (RTSP AAC-ADTS, PCM) (External and embedded audio mixable)
Analogue Audio Output	3.5mm x 1 (headphone, PGM audio monitoring)
Digital Embedded Audio Support	N/A
Audio Delay Calibration	Each channel delay time: 0 – 3000 ms
A+V Switching	Yes (Full Screen Mode)
Chromakey	N/A
Title Creator	Web GUI

USK	N/A
DSK	N/A
Picture in Picture	Yes (PGM)
Logo Insertion	Yes
Still Store	N/A
Effects	Cut
Transition Preview	N/A
Sync/Reference In/Out	N/A
Tally Output	N/A
PC Remote Control	Web UI for configuration and control Serial Port Control: RS-232 (RJ-45)
Built-in Audio Mixer	Yes
Storage	SATA (6 Gb/s)
Recording File System	FAT-32/exFAT
Recording File Format	MP4
Video Encode	H.264
Audio Encode	AAC-LC Sample Rate: 48 kHz, 16 bit AAC-LC Sample Rate: 48 kHz, 16 bit Configurable bit rate: 128K or 256K or 384K
Streaming Protocol	DHCP client TS over UDP (unicast & multicast) RTSP over HTTP/TCP/UDP RTMP (Publish)/RTMPS HLS SRT Caller and Listener Web RTC (encode/decode) NDI Hx
Firmware Update	Web UI (Network)
Special Features	Vertical video Vertical video Multiview
Chassis	1RU rack-mount mainframe
Dimension (LxWxH)	440 x 284 x 44 mm
Weight	2.9 kg
Power	DC 12V 24W
Operating Temperature	0°C - 40°C [32°F - 104°F]

Notes

Notes

Service & Support

It is our goal to make owning and using Datavideo products a satisfying experience. Our support staff is available to assist you to set up and operate your system. Contact your local office for specific support requests. Plus, please visit www.datavideo.com to access our FAQ section.

Please visit our website for latest manual update.

www.datavideo.com/product/iCast_10NDI



@DatavideoUSA @DatavideoIndia2016
@DatavideoEMEA @Datavideojapan
@DatavideoTaiwan @DatavideoLatam
@DatavideoAsia @DatavideoBrasil



@Datavideo
@Datavideo_EMEA
@Datavideo_Taiwan



@DatavideoUSA
@DVTWDVCN



@DatavideoUSA
@DatavideoEurope

All the trademarks are the properties of their respective owners.
Datavideo Technologies Co., Ltd. All rights reserved 2020

Jan-12.2024
Version E4