



EMC TEST REPORT
For
Shenzhen Yongjiu Precision Electronics Co.,Ltd.
Wall Charger

Model No. : YJ-N24, OPP143, OPP153, OPP063

Prepared for : Shenzhen Yongjiu Precision Electronics Co.,Ltd.

Address : 7/F, Sunjet Industrial Park, No.5 - 1,Dawangshan Industrial Rd 2nd,
Shajing, Bao'an, Shenzhen, 518104, China

Prepared By : Guangdong Lintek Certification Group Co., Ltd.

Address : 302,Building B, Xunli Science and Technology Park, No.36
Zhangge Road, Fucheng Street, Longhua District, Shenzhen,
Guangdong Province, China

Report Number	: LTR23022153E02
Receive Date	Feb. 21, 2023
Date of Test	: Feb. 21, 2023 to Feb. 27, 2023
Date of Report	: Feb. 27, 2023
Version Number	: REV0



TABLE OF CONTENTS

<u>Description</u>	<u>Page</u>
1. Summary of standards and results	6
1.1. Description of Standards and Results	6
2. GENERAL INFORMATION	7
2.1. Description of Device (EUT).....	7
2.2. Block Diagram of connection between EUT and simulators.....	8
2.3. Test Facility	8
2.4. Measurement Uncertainty	8
2.5. Test mode Description	9
3. Conducted Disturbance at Mains Terminals test	10
3.1. Test Equipments	10
3.2. Block Diagram of Test Setup	10
3.3. Conducted Disturbance at Mains Terminals Test Standard and Limit.....	10
3.4. EUT Configuration on Test	11
3.5. Operating Condition of EUT	11
3.6. Test Procedure	11
3.7. Conducted Disturbance at Mains Terminals Test Results	11
4. Radiated Disturbance test	14
4.1. Test Equipments	14
4.2. Block Diagram of Test Setup	15
4.3. Test Standard	16
4.4. Radiated Disturbance Limit	16
4.5. EUT Configuration on Test	17
4.6. Operating Condition of EUT	17
4.7. Test Procedure	17
4.8. Test result	17
5. harmonic CURRENT TEST	21
5.1. Test Equipments	21
5.2. Block Diagram of Test Setup	21
5.3. Harmonics Test Standard.....	21
5.4. Limits of Harmonic Current	21
5.5. Operating Condition of EUT	22
5.6. Test Procedure	22
5.7. Test Results	22
6. VOLTAGE FLUCTUATIONS & FLICKER TEST	23
6.1. Test Equipments	23
6.2. Block Diagram of Test Setup	23



- 6.3. Voltage Fluctuation and Flicker Test Standard..... 23
- 6.4. Limits of Voltage Fluctuation and Flick 23
- 6.5. Operating Condition of EUT 23
- 6.6. Test Procedure 23
- 6.7. Test Results 23
- 7. Immunity Performance Criteria Description 24**
- 8. Electrostatic Discharge TEST 25**
 - 8.1. Test Equipments 25
 - 8.2. Block Diagram of Test Setup 25
 - 8.3. Test Standard 25
 - 8.4. Severity Levels and Performance Criterion 25
 - 8.5. EUT Configuration 26
 - 8.6. Operating Condition of EUT 26
 - 8.7. Test Procedure 26
 - 8.8. Test Results 26
- 9. RF Field Strength susceptibility Test 28**
 - 9.1. Test Equipments 28
 - 9.2. Block Diagram of Test Setup 28
 - 9.3. Test Standard 28
 - 9.4. Severity Levels and Performance Criterion 29
 - 9.5. EUT Configuration 29
 - 9.6. Operating Condition of EUT 29
 - 9.7. Test Procedure 29
 - 9.8. Test Results 29
- 10. Electrical Fast Transient/Burst Test 31**
 - 10.1. Test Equipments 31
 - 10.2. Block Diagram of Test Setup 31
 - 10.3. Test Standard 31
 - 10.4. Severity Levels and Performance Criterion 31
 - 10.5. EUT Configuration 31
 - 10.6. Operating Condition of EUT 32
 - 10.7. Test Procedure 32
 - 10.8. Test Result..... 32
- 11. SURGE Test 34**
 - 11.1. Test Equipments 34
 - 11.2. Block Diagram of Test Setup 34
 - 11.3. Test Standard 34
 - 11.4. Severity Levels and Performance Criterion 34
 - 11.5. EUT Configuration 35
 - 11.6. Operating Condition of EUT 35
 - 11.7. Test Procedure 35



- 11.8. Test Result..... 35
- 12. Injected currents susceptibility test..... 37**
 - 12.1. Test Equipments 37
 - 12.2. Block Diagram of Test Setup 37
 - 12.3. Test Standard 37
 - 12.4. Severity Levels and Performance Criterion 37
 - 12.5. EUT Configuration 38
 - 12.6. Operating Condition of EUT 38
 - 12.7. Test Procedure 38
 - 12.8. Test Results 38
- 13. Voltage dips and interruptions test 40**
 - 13.1. Test Equipments 40
 - 13.2. Block Diagram of Test Setup 40
 - 13.3. Test Standard 40
 - 13.4. Severity Levels and Performance Criterion 40
 - 13.5. EUT Configuration 40
 - 13.6. Operating Condition of EUT 41
 - 13.7. Test Procedure 41
 - 13.8. Test Result..... 41
- 14. Photo of the EUT 44**



TEST REPORT DECLARATION

Applicant : Shenzhen Yongjiu Precision Electronics Co.,Ltd.

Manufacturer : Shenzhen Yongjiu Precision Electronics Co.,Ltd.

EUT Description : Wall Charger

(A) Model No. : YJ-N24, OPP143, OPP153, OPP063

(B) Trademark : N/A

C) Ratings Supply : Input: 100-240Va.c. 50/60Hz 1.1A
Output: 5Vd.c. 4.8A total
(2.4A+2.4A) 24W

(D) Test Voltage : AC230V, 50Hz

Measurement Standard Used:

EN 55032:2015+A11:2020,

EN 55035:2017+A11:2020,

EN IEC 61000-3-2:2019+A1:2021,

EN 61000-3-3:2013+A2:2021

The device described above is tested by Guangdong Lintek Certification Group Co., Ltd. to determine the maximum emission levels emanating from the device and the severe levels of the device can endure and its performance criterion. The test results are contained in this test report and Guangdong Lintek Certification Group Co., Ltd. is assumed full responsibility for the accuracy and completeness of test. Also, this report shows that the EUT is technically compliant with the EN 55032, EN IEC61000-3-2, EN 61000-3-3 and EN 55035 requirements.

This report applies to above tested sample only. This report shall not be reproduced in part without written approval of Guangdong Lintek Certification Group Co., Ltd.

Tested by (name + signature).....: Sunny Yuan
Test Engineer

Approved by (name + signature).....: Kevin Huang
Project Manager

Date of issue.....: Feb. 27, 2023





1. SUMMARY OF STANDARDS AND RESULTS

1.1. Description of Standards and Results

The EUT have been tested according to the applicable standards as referenced below.

EMISSION				
Description of Test Item	Standard	Limits		Results
Conducted disturbance at mains terminals test	EN 55032	Section 4.1.1 Table 1		PASS
Radiated disturbance	EN 55032	Section 4.1.2 Table 3		PASS
Harmonic current emissions	EN IEC 61000-3-2	Class A		PASS
Voltage fluctuations & flicker	EN 61000-3-3	Section 5		PASS
IMMUNITY				
Description of Test Item	Basic Standard	Performance Criteria	Observation Criteria	Results
Electrostatic discharge (ESD)	IEC 61000-4-2	B	A	PASS
Radio-frequency, Continuous radiated disturbance	IEC 61000-4-3	A	A	PASS
Electrical fast transient (EFT)	IEC 61000-4-4	B	A	PASS
Surge (Input a.c. power ports)	IEC 61000-4-54	B	A	PASS
Radio-frequency, Continuous conducted disturbance	IEC 61000-4-6	A	A	PASS
Voltage dips, Interruptions	IEC 61000-4-11	B&C	A&B&C	PASS
N/A is an abbreviation for Not Applicable.				



2. GENERAL INFORMATION

2.1. Description of Device (EUT)

Description : Wall Charger

Classification : Class II

Model Number : YJ-N24, OPP143, OPP153, OPP063

DIFF. : All models are the same except model name, color and output. The model YJ-N24 was selected to be tested.

Trademark : N/A

Applicant : Shenzhen Yongjiu Precision Electronics Co.,Ltd.

Address : 7/F, Sunjet Industrial Park, No.5 - 1,Dawangshan Industrial Rd 2nd, Shajing, Bao'an, Shenzhen, 518104, China

Manufacturer : Shenzhen Yongjiu Precision Electronics Co.,Ltd.

Address : 7/F, Sunjet Industrial Park, No.5 - 1,Dawangshan Industrial Rd 2nd, Shajing, Bao'an, Shenzhen, 518104, China

Sample Type : Prototype production



2.2. Block Diagram of connection between EUT and simulators



EUT: Wall Charger

2.3. Test Facility

2.3.1. Laboratory Name:

Guangdong Lintek Certification Group Co., Ltd.

2.3.2. Site Location :

302, Building B, Xunli Science and Technology Park, No.36
Zhangge Road, Fucheng Street, Longhua District, Shenzhen,
Guangdong Province, China

2.4. Measurement Uncertainty

(95% confidence levels, k=2)

Test Item	Uncertainty	U _{cispr}
Uncertainty for Conduction emission test	2.50dB	3.8 dB
Uncertainty for Radiation Emission test	3.04 dB (Distance: 3m Polarize: V)	5.2 dB
	3.02 dB (Distance: 3m Polarize: H)	
Uncertainty for Power Clamp Test	3.94 dB	4.5 dB
Uncertainty for Flicker test	0.05%	N/A
Uncertainty for Harmonic test	1.8%	N/A



2.5. Test mode Description

No.	Test Mode
1	output loaded 5V/4.8A(2.4A+2.4A)
Note:	



3. CONDUCTED DISTURBANCE AT MAINS TERMINALS TEST

3.1. Test Equipments

Item	Equipment	Manufacturer	Model No.	Serial No.	Last Cal.	Cal. Interval
1.	Test Receiver	Rohde & Schwarz	ESCI	100873	May 06, 22	1 Year
2.	L.I.S.N.#1	Schwarzbeck	NSLK8126	8126-466	May 06, 22	1 Year
3.	RF Cable	Schwarzbeck	Cable 2	2M	May 06, 22	1 Year
4.	Coaxial Switch	Schwarzbeck	CX-210	N/A	May 06, 22	1 Year
5.	Pulse Limiter	Schwarzbeck	9516F	9618	May 06, 22	1 Year

3.2. Block Diagram of Test Setup

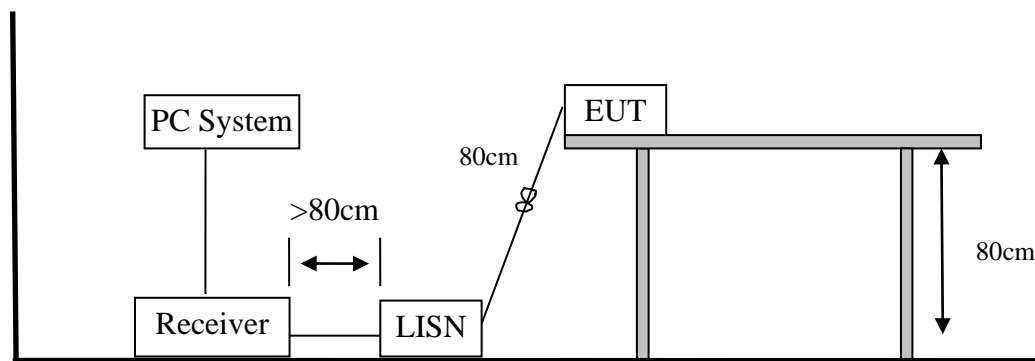

3.3. Conducted Disturbance at Mains Terminals Test Standard and Limit

3.3.1. Test Standard

EN55032, Class B

3.3.2. Test Limit

Frequency	At mains terminals (dB μ V)	
	Quasi-peak Level	Average Level
150kHz ~ 500kHz	66 ~ 56 *	56 ~ 46 *
500kHz ~ 5MHz	56	46
5MHz ~ 30MHz	60	50

Notes: 1. Emission level=Read level+LISN factor-Preamp factor+Cable loss

2* Decreasing linearly with logarithm of frequency.

3. The lower limit shall apply at the transition frequencies.



3.4. EUT Configuration on Test

The following equipments are installed on conducted disturbance at mains terminals to meet EN55032 requirement and operating in a manner which tends to maximize its emission characteristics in a normal application.

3.5. Operating Condition of EUT

3.5.1. Setup the EUT as shown in section 3.2.

3.5.2. Turned on the power of all equipments.

3.5.3. Let the EUT worked in test mode 15 minutes after taking the test.

3.6. Test Procedure

The EUT was placed on a non-metallic table, 80cm above the ground plane. The EUT Power connected to the power mains through a line impedance stabilization network (L.I.S.N. #1). The power line was checked for maximum conducted interference. In order to find the maximum emission, the relative positions of equipments and all of the interface cables were changed according to EN55032 on Conducted Disturbance at Mains Terminals test.

The bandwidth of test receiver (R & S ESCI) is set at 10kHz.

The frequency range from 150kHz to 30MHz is checked. The test result are reported on Section 3.7.

3.7. Conducted Disturbance at Mains Terminals Test Results

PASS

The test data see below.



Line

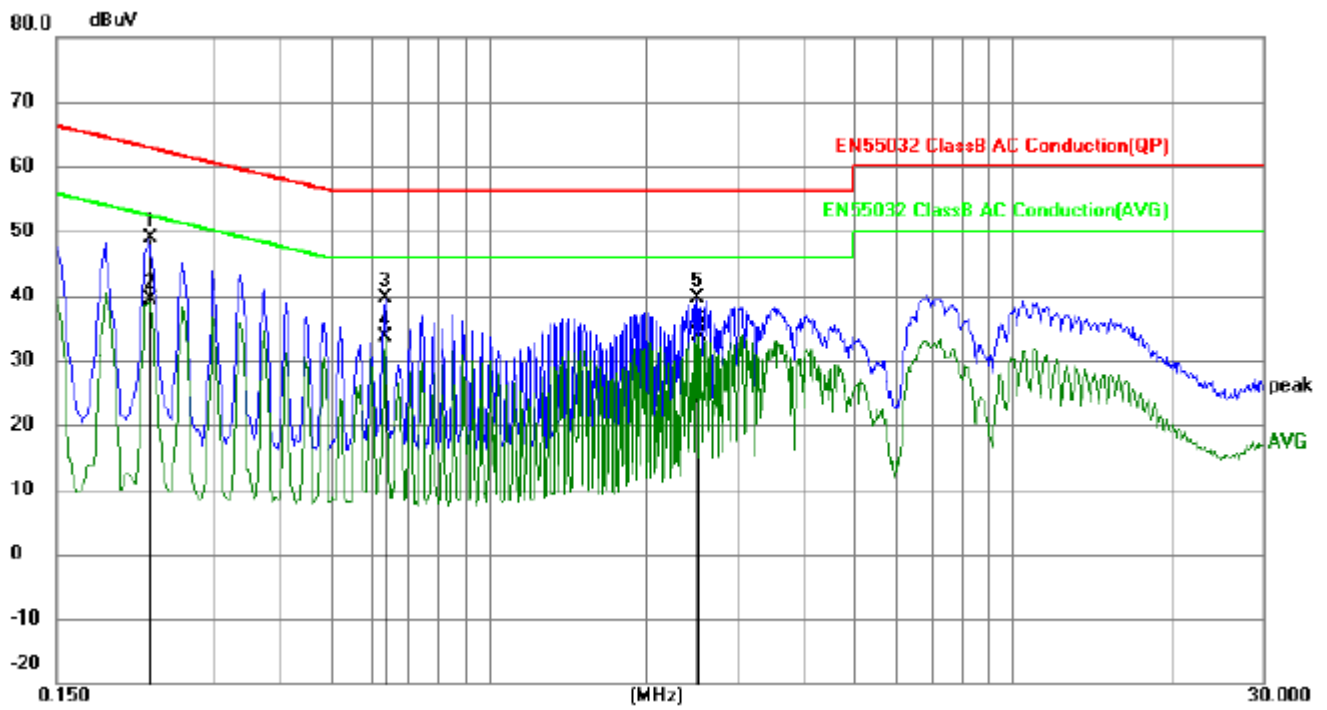

No.	Frequency (MHz)	Reading (dBuV)	Factor (dB)	Level (dBuV)	Limit (dBuV)	Margin (dB)	Detector	P/F	Remark
1	0.2265	36.37	12.44	48.81	62.58	-13.77	peak	P	
2	0.2265	26.98	12.44	39.42	52.58	-13.16	AVG	P	
3	0.6359	27.40	12.34	39.74	56.00	-16.26	peak	P	
4	0.6359	21.24	12.34	33.58	46.00	-12.42	AVG	P	
5	2.4990	27.23	12.31	39.54	56.00	-16.46	peak	P	
6	2.5035	21.54	12.31	33.85	46.00	-12.15	AVG	P	



Neutral

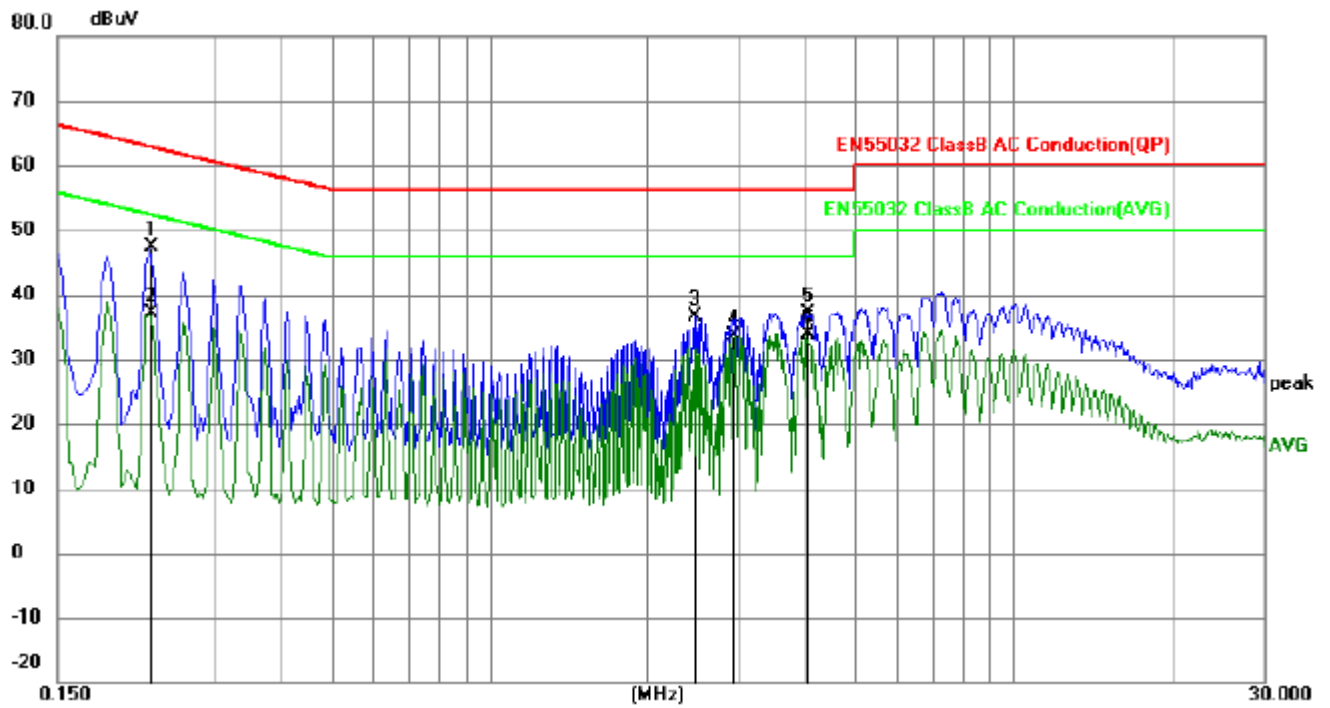

No.	Frequency (MHz)	Reading (dBuV)	Factor (dB)	Level (dBuV)	Limit (dBuV)	Margin (dB)	Detector	P/F	Remark
1	0.2265	34.92	12.44	47.36	62.58	-15.22	peak	P	
2	0.2265	24.74	12.44	37.18	52.58	-15.40	AVG	P	
3	2.4630	24.26	12.31	36.57	56.00	-19.43	peak	P	
4	2.9130	21.31	12.31	33.62	46.00	-12.38	AVG	P	
5	4.0335	24.87	12.33	37.20	56.00	-18.80	peak	P	
6	4.0335	21.61	12.33	33.94	46.00	-12.06	AVG	P	



4. RADIATED DISTURBANCE TEST

4.1. Test Equipments

4.1.1. For frequency range 30MHz~1000MHz (At Semi Anechoic Chamber)

Item	Equipment	Manufacturer	Model No.	Serial No.	Last Cal.	Cal. Interval
1	Test Receiver	Rohde&Schwarz	ESCI	101165	May 06, 22	1 Year
2	Amplifier	Quietek	AP/0100A	0506005	May 06, 22	1 Year
3	Coaxial Switch	ANRITSUCORP	MP5913	6200615651	N/A	N/A
4	Bilog Antenna	Schwarzbeck	VULB 9168	9168-438	May 06, 22	1 Year
5	Spectrum Analyzer	Agilent	E4407B	MY49510055	May 06, 22	1 Year
6	Horn Antenna	Schwarzbeck	BBHA 9120 D	BBHA 9120 D(1201)	May 06, 22	1 Year
7	Amplifier	Quietek	AP-180C	CHM-0602012	May 06, 22	1 Year



4.2. Block Diagram of Test Setup

4.2.1. In Semi Anechoic Chamber (3m) Test Setup Diagram for 30MHz~1000MHz

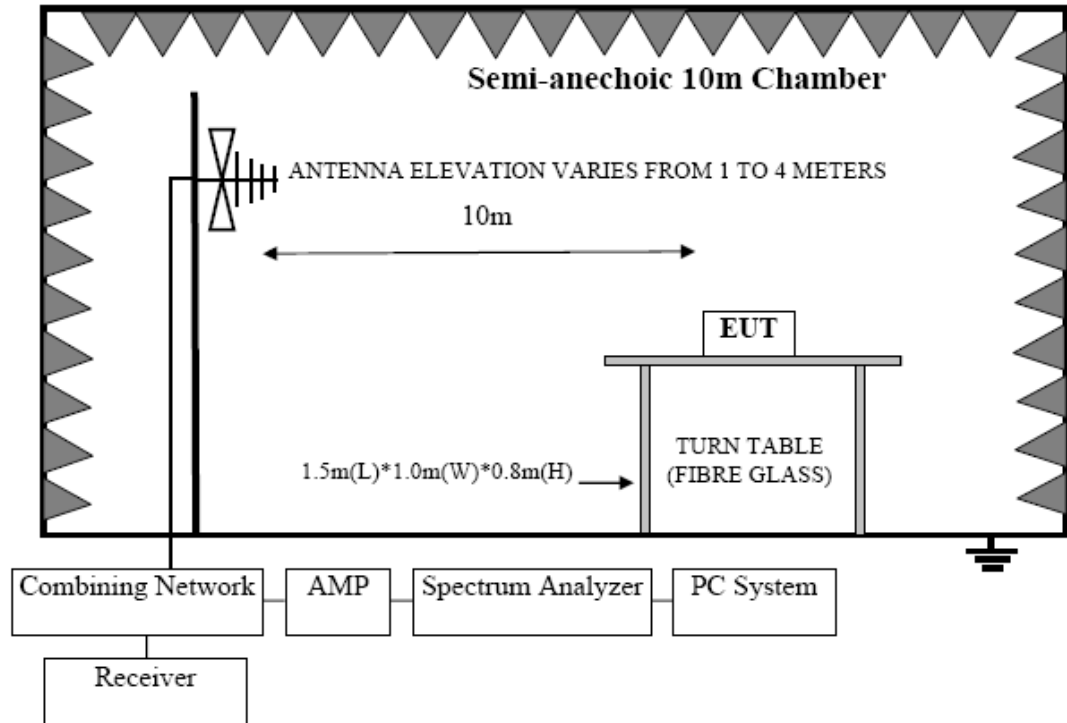



4.2.2. In Semi Anechoic Chamber (3m) Test Setup Diagram for 1000MHz~6000MHz

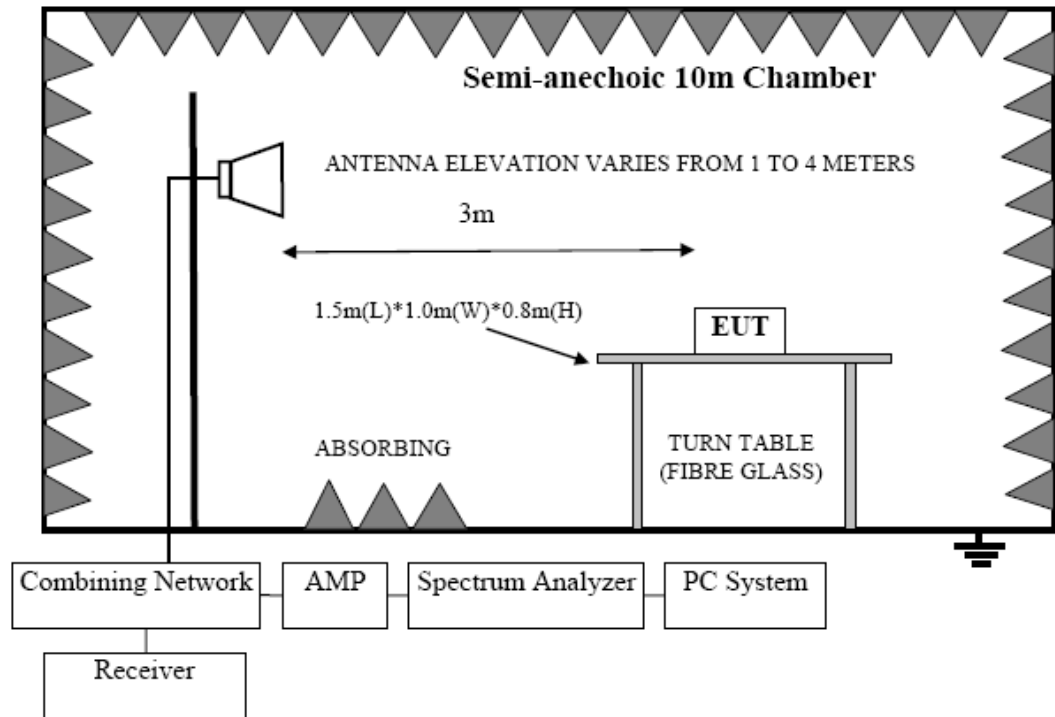

4.3. Test Standard

EN55032, Class B

4.4. Radiated Disturbance Limit

All emanations from a devices or system, including any network of conductors and apparatus connected thereto, shall not exceed the level of field strengths specified below:

Source	DISTANCE (Meters)	FREQUENCY (MHz)	Limits(dB μ V/m) Quasi-Peak
Local Oscillator	3	≤ 1000	Fundamental 60
	3	30~300	Harmonics 52
	3	300~1000	Harmonics 56
Other	3	30~230	40
	3	230~1000	47

Note: (1) Emission level = Read level+Antenna Factor-Preamp Factor +Cable Loss
 (2) The lower limit shall apply at the transition frequencies.



- (3) Distance refers to the distance in meters between the test instrument antenna and the closed point of any part of the E.U.T.

4.5. EUT Configuration on Test

The EN55032 regulations test method must be used to find the maximum emission during Radiated Disturbance test. The configuration of EUT is same as used in Conducted Disturbance test. Please refer to Section 3.5.

4.6. Operating Condition of EUT

- 4.6.1. Setup the EUT and simulator as shown as Section 5.2.
- 4.6.2. Turned on the power of all equipment.
- 4.6.3. Let the EUT work in test mode 15 minutes after taking the test.

4.7. Test Procedure

The EUT was placed on a non-metallic table, 80 cm above the ground plane inside a semi-anechoic chamber. An antenna was located 3m & 3m from the EUT on an adjustable mast. A pre-scan was first performed in order to find prominent radiated emissions. For final emissions measurements at each frequency of interest, the EUT were rotated and the antenna height was varied between 1m and 4m in order to maximize the emission. Measurements in both horizontal and vertical polarities were made and the data was recorded. In order to find the maximum emission, the relative positions of equipments and all the interface cables were changed according to EN 55032 on Radiated Disturbance test.

The bandwidth setting on the test receiver (Rohde&Schwarz Test Receiver ESCI) is 120 kHz.

4.8. Test result

PASS. (All emissions not reported below are too low against the prescribed limits. Only report the worst result for all 4 models)

The EUT with the following test mode was tested and read QP values, the test results are listed in next pages.

Temperature: 24.2°C Humidity: 54%

The details of test mode is as follows :

No.	Test Mode
-----	-----------



1	output loaded 5V/4.8A(2.4A+2.4A)
---	----------------------------------

For frequency range 1GHz~6GHz

The highest frequency of the internal sources of the EUT is less than 108 MHz, the measurement shall only be made up to 1 GHz. So the frequency rang 1GHz-6GHz radiation test not applicable.



Vertical

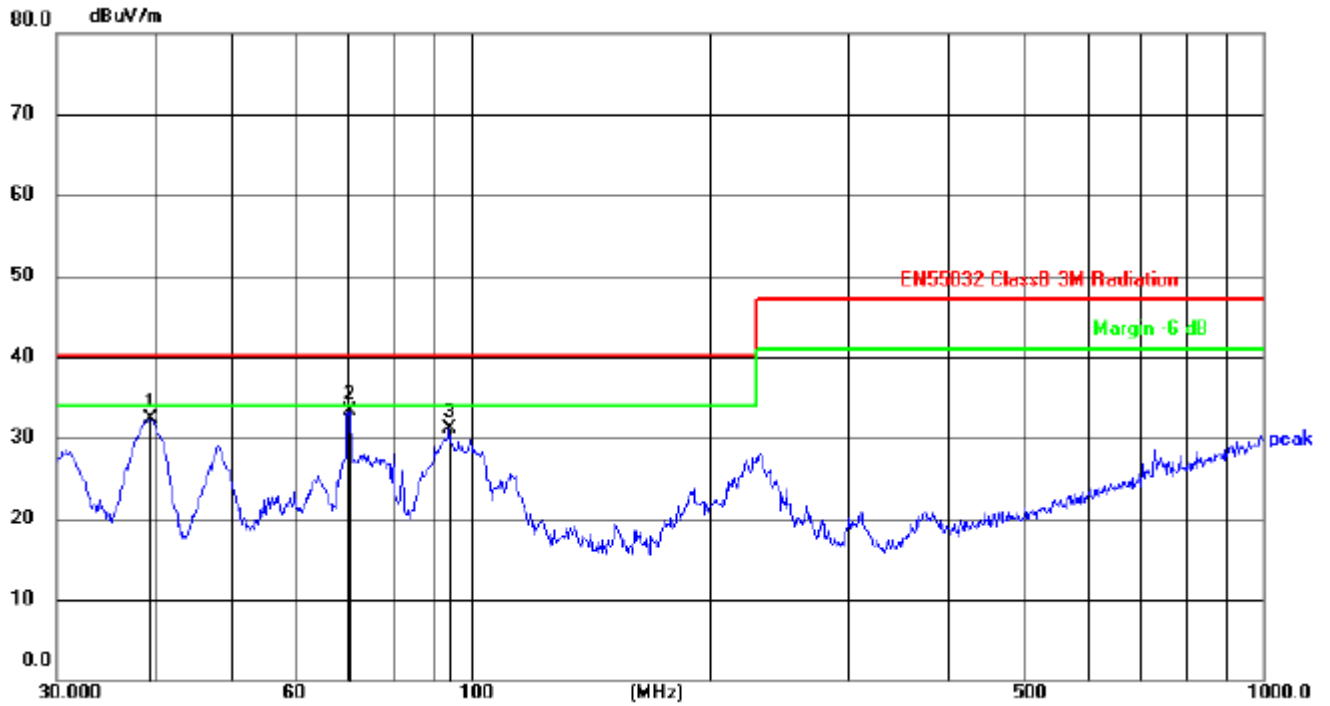

No.	Frequency (MHz)	Reading (dBuV)	Factor (dB/m)	Level (dBuV/m)	Limit (dBuV/m)	Margin (dB)	Detector	Height (cm)	Azimuth (deg.)	P/F	Remark
1	39.4371	53.04	-20.67	32.37	40.00	-7.63	peak				
2	70.3365	53.84	-20.53	33.31	40.00	-6.69	peak				
3	93.7685	51.19	-20.03	31.16	40.00	-8.84	peak				



Horizontal

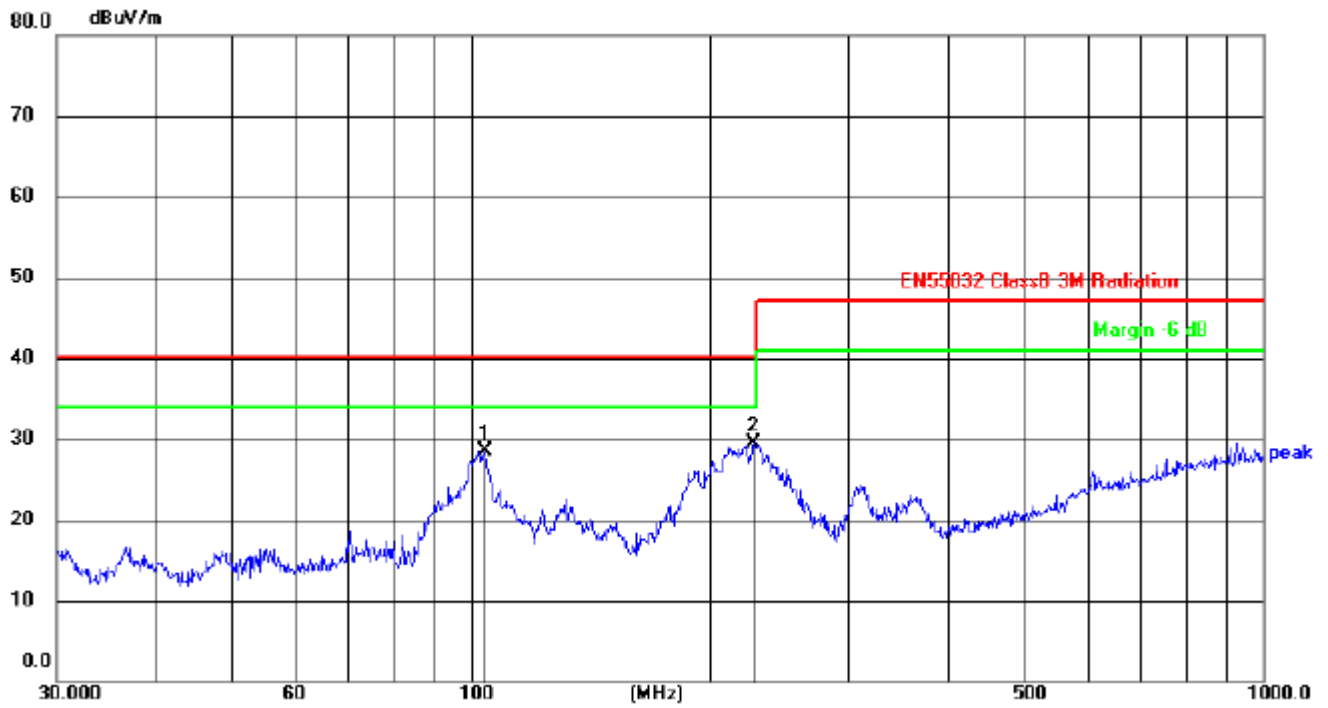

No.	Frequency (MHz)	Reading (dBuV)	Factor (dB/m)	Level (dBuV/m)	Limit (dBuV/m)	Margin (dB)	Detector	Height (cm)	Azimuth (deg.)	P/F	Remark
1	104.1701	48.55	-20.00	28.55	40.00	-11.45	peak				
2	227.6906	48.02	-18.42	29.60	40.00	-10.40	peak				



5. HARMONIC CURRENT TEST

5.1. Test Equipments

Item	Equipment	Manufacturer	Model No.	Serial No.	Last Cal.	Cal. Interval
1.	Harmonics&Flicker Analyser	Voltech	PM6000	20000670 0495	May 06, 22	1 Year

5.2. Block Diagram of Test Setup

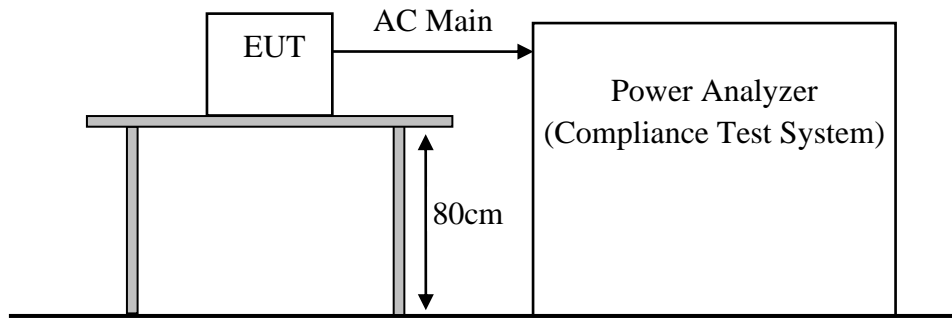

5.3. Harmonics Test Standard

EN 61000-3-2, Class A

5.4. Limits of Harmonic Current

Limits for Class A equipment	
Harmonic order n	Maximum permissible Harmonic current A
Odd harmonics	
3	2,30
5	1,14
7	0,77
9	0,40
11	0,33
13	0,21
15 ≤ n ≤ 39	0,15 $\frac{15}{n}$
Even harmonics	
2	1,08
4	0,43



6 $8 \leq n \leq 40$	0,30 $0,23 \frac{8}{n}$
-------------------------	----------------------------

5.5. Operating Condition of EUT

Same as section 3.6. except the test set up replaced by section 7.2..

5.6. Test Procedure

The EUT was placed on the top of a wooden table 0.8 meters above the ground and operated to produce the maximum harmonic components under normal operating conditions for each successive harmonic component in turn. The correspondent test program of test instrument to measure the current harmonics emanated from EUT is chosen. The measure time shall be not less than the necessary for the EUT to be exercised.

5.7. Test Results

PASS



6. VOLTAGE FLUCTUATIONS & FLICKER TEST

6.1. Test Equipments

Same as Section 7.1.

6.2. Block Diagram of Test Setup

Same as Section 7.2.

6.3. Voltage Fluctuation and Flicker Test Standard

EN 61000-3-3

6.4. Limits of Voltage Fluctuation and Flick

Test Item	Limit	Note
P_{st}	1.0	P_{st} means Short-term flicker indicator
P_{lt}	0.65	P_{lt} means long-term flicker indicator
T_{dt}	0.2	T_{dt} means maximum time that dt exceeds 3%
$d_{max}(\%)$	4%	d_{max} means maximum relative voltage change.
$d_c(\%)$	3%	d_c means relative steady-state voltage change.

6.5. Operating Condition of EUT

Same as Section 7.5.

6.6. Test Procedure

The EUT was placed on the top of a wooden table 0.8 meters above the ground and operated to produce the most unfavorable sequence of voltage changes under normal conditions. During the flick measurement, the measure time shall include that part of whole operation changes. The observation period for short-term flicker indicator is 10 minutes and the observation period for long-term flicker indicator is 2 hours.

6.7. Test Results

PASS



7. IMMUNITY PERFORMANCE CRITERIA DESCRIPTION

Performance Level

The test results shall be classified in terms of the loss of function or degradation of performance of the equipment under test, relative to a performance level by its manufacturer or the requestor of the test, or the agreed between the manufacturer and the purchaser of the product.

Definition related to the performance level:

1. Based on the used product standard
2. Based on the declaration of the manufacturer, requestor or purchaser

Criterion A:

Definition: normal performance within limits specified by the manufacturer, requestor and purchaser.

The **apparatus** shall continue to operate as intended during the test and after the test. No degradation of performance or loss of function is allowed below a performance level (or permissible loss of performance) specified by the manufacturer, when the apparatus is used as intended. If the minimum performance level or the permissible performance loss is not specified by the manufacturer, then either of these may be derived from the product description and documentation, and from what the user may reasonably expect from the apparatus if used as intended.

Criterion B:

Definition: temporary loss of function or degradation of performance which ceases after the disturbance ceases, and from which the equipment under test recovers its normal performance, without operator intervention.

The apparatus shall continue to operate as intended after the test. No degradation of performance or loss of function is allowed below a performance level (or permissible loss of performance) specified by the manufacturer, when the apparatus is used as intended. The performance level may be replaced by a permissible loss of performance. During the test, degradation of performance is allowed, however. No change of actual operation state or stored data is allowed. If the minimum performance level or the permissible performance loss is not specified by the manufacturer, then either of these may be derived from the product description and documentation, and from what the user may reasonably expect from the apparatus the apparatus if used as intended.

Criterion C:

Definition: temporary loss of function or degradation of performance, the correction of which requires operator intervention.

Temporary loss of function is allowed, provided the function is self-recoverable or can be restored by the operation of the controls, or by any operation specified in the instructions for use.



Criterion D:

Definition: loss of function or degradation of performance, which is not recoverable, owing to damage to hardware or software, or loss of data.

8. ELECTROSTATIC DISCHARGE TEST

8.1. Test Equipments

Item	Equipment	Manufacturer	Model No.	Serial No.	Last Cal.	Cal. Interval
1.	ESD Tester	HAEFELY	PESD1610	H310546	May 06, 22	1 Year

8.2. Block Diagram of Test Setup

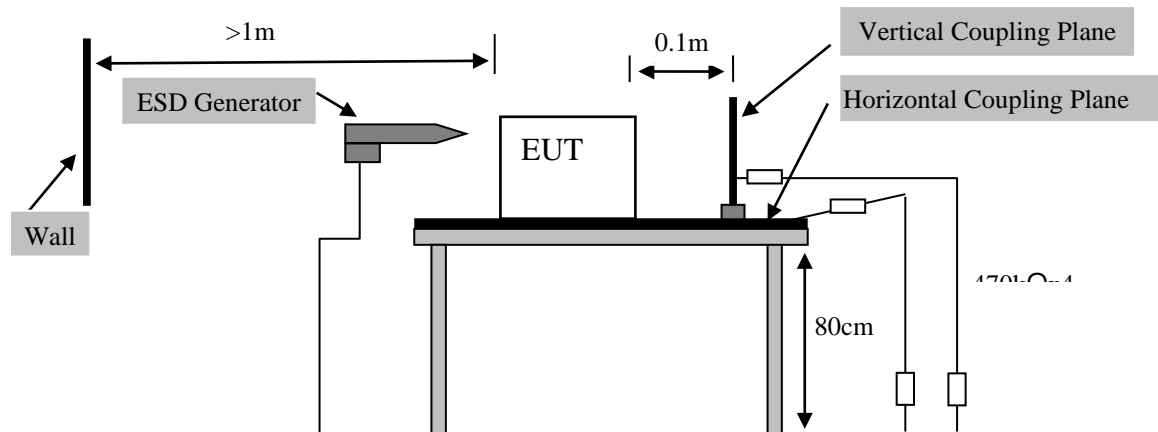

8.3. Test Standard

EN 55035(IEC61000-4-2)

(Severity Level 3 for Air Discharge at 8kV,
Severity Level 2 for Contact Discharge at 4kV)

8.4. Severity Levels and Performance Criterion

8.4.1. Severity level

Level	Test Voltage Contact Discharge (kV)	Test Voltage Air Discharge (kV)
1.	2	2
2.	4	4
3.	6	8
4.	8	15



X	Special	Special
---	---------	---------

8.4.2. Performance criterion: **B**

8.5. EUT Configuration

The configuration of EUT are listed in section 3.5.

8.6. Operating Condition of EUT

Same as conducted test which is listed in section 3.6. except the test setup replaced by section 10.2.

8.7. Test Procedure

8.7.1. Air Discharge:

The test was applied on non-conductive surfaces of EUT. The round discharge tip of the discharge electrode was approached as fast as possible to touch the EUT. After each discharge, the discharge electrode was removed from the EUT. The generator was re-triggered for a new single discharge and repeated 20 times for each pre-selected test point. This procedure was repeated until all the air discharge completed

8.7.2. Contact Discharge:

All the procedure was same as Section 10.7.1. except that the generator was re-triggered for a new single discharge for each pre-selected test point. The tip of the discharge electrode was touch the EUT before the discharge switch was operated.

8.7.3. Indirect discharge for horizontal coupling plane

At least 20 single discharges were applied to the horizontal coupling plane, at points on each side of the EUT. The discharge electrode positions vertically at a distance of 0.1m from the EUT and with the discharge electrode touching the coupling plane.

8.7.4. Indirect discharge for vertical coupling plane

At least 20 single discharge were applied to the center of one vertical edge of the coupling plane. The coupling plane, of dimensions 0.5m X 0.5m, was placed parallel to, and positioned at a distance of 0.1m from the EUT. Discharges were applied to the coupling plane, with this plane in sufficient different positions that the four faces of the EUT are completely illuminated.

8.8. Test Results

PASS.

The EUT was tested and all the test results are listed in next page.



Electrostatic Discharge Test Results

Applicant	: Shenzhen Yongjiu Precision Electronics Co.,Ltd.	Test Date	: Feb. 23, 2023
EUT	: Wall Charger	Temperature	: 23°C
M/N	: YJ-N24	Humidity	: 50%
Test Voltage	: 230V, 50Hz	Test Mode	: Max. Normal loaded
Test Engineer	: Sunny Yuan	Pressure	: 101.3KPa
Required Performance	: B	Actual Performance	: A

Air Discharge: ±8kV # For Air Discharge each Point Positive 10 times and negative 10 times discharge.

Contact Discharge: ±4kV # For Contact Discharge each point positive 25 times and negative 25 times discharge

For the time interval between successive single discharges an initial value of one second.

Discharge Voltage (kV)	Type of discharge	Dischargeable Points	Performance		Result (Pass/Fai)
			Required	Observation	
±4	Contact	1	B	A	Pass
±8	Air	2	B	A	Pass
±2,4	HCP-Bottom	Edge of the HCP	B	A	Pass
±2,4	VCP-Front	Center of the VCP	B	A	Pass
±2,4	VCP-Left	Center of the VCP	B	A	Pass
±2,4	VCP-Back	Center of the VCP	B	A	Pass
±2,4	VCP-Right	Center of the VCP	B	A	Pass

Discharge Points Description

<u>1</u>	Enclosure	<u>5</u>	
<u>2</u>	Output port	<u>6</u>	
<u>3</u>		<u>7</u>	
<u>4</u>		<u>8</u>	

Test Equipment: ESD Tester PESD1610

Remark: Class A is no function loss.

Discharge was considered on Contact and Air and Horizontal Coupling Plane (HCP) and Vertical Coupling Plane (VCP).



9. RF FIELD STRENGTH SUSCEPTIBILITY TEST

9.1. Test Equipments

Item	Equipment	Manufacturer	Model No.	Serial No.	Last Cal.	Cal. Interval
1.	Signal Generator	Marconi	2031B	11606/058	May 06, 22	1 Year
2.	Amplifier	A&R	100W/1000M1	17028	N/A	N/A
3.	Isotropic Field Monitor	A&R	FM7004	0325983	N/A	N/A
4.	Isotropic Field Probe	A&R	FL7006	0325736	May 06, 22	1 Year
5.	Laser Probe Interface	A&R	FL7000	325430	N/A	N/A
6.	Power Meter	Anritsu	ML2487A	6k00003262	May 06, 22	1 Year
7.	Power Sensor	Anritsu	MA2491A	33005	May 06, 22	1 Year
8.	Log-periodic Antenna	A&R	AT1080	16512	N/A	N/A

9.2. Block Diagram of Test Setup

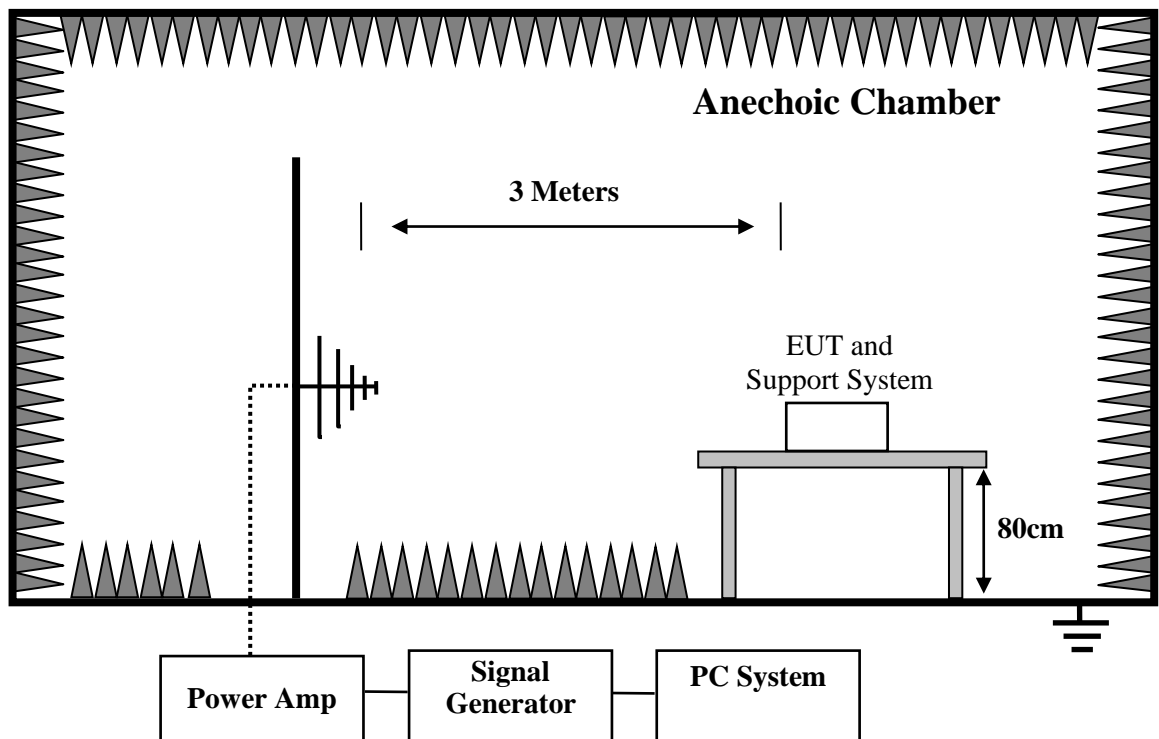

9.3. Test Standard

EN 55035 (IEC 61000-4-3)
 (Severity Level: 2 at 3V / m)



9.4. Severity Levels and Performance Criterion

9.4.1. Severity level

Level	Test Field Strength V/m
1.	1
2.	3
3.	10
X	Special

9.4.2. Performance criterion : A

9.5. EUT Configuration

The configurations of EUT are listed in Section 3.5.

9.6. Operating Condition of EUT

Same as Conducted Emission test that is listed in Section 3.6. except the test set up replaced by Section 11.2.

9.7. Test Procedure

Testing was performed in a Fully anechoic chamber as recommended by IEC 61000-4-3. The EUT was placed on an 80 cm high non-conductive table located in the area of field uniformity. The radiating antenna was placed 3m in front of the EUT and Support system, and dwell time of the radiated interference was controlled by an auSunny Yuanated, computer-controlled system. The signal source was stepped through the applicable frequency range at a rate no faster than 1% of the fundamental.

The signal was amplitude modulated 80% over the frequency range 80 MHz to 1GHz at a level of 3 V/m. The dwell time was set at 3 s. Field presence was monitored during testing via a field probe placed in close proximity to the EUT. Throughout testing, the EUT was closely monitored for signs of susceptibility. The test was performed with the antennae oriented in both a horizontal and vertical polarization.

All the scanning conditions are as follows:

Condition of Test	Remarks
1. Test Fielded Strength	3 V/m (Severity Level 2)
2. Radiated Signal	80% amplitude modulated with a 1kHz sine wave
3. Scanning Frequency	80 - 1000 MHz
4. Sweeping time of radiated	0.0015 decade/s
5. Dwell Time	1 Sec.

9.8. Test Results

PASS.

The EUT was tested and all the test results are listed in next page.



RF Field Strength Susceptibility Test Results

Applicant	: Shenzhen Yongjiu Precision Electronics Co.,Ltd.	Test Date	: Feb.23.2023		
EUT	: Wall Charger	Temperature	: 23°C		
M/N	: YJ-N24	Humidity	: 50%		
Test Voltage	: AC230V, 50Hz	Test Mode	: Max. Normal loaded		
Test Engineer	: Sunny Yuan	Pressure	: 101.3KPa		
Frequency Range	: 80 MHz -1000MHz 1800MHz, 2600MHz, 3500MHz, 5000MHz	Field Strength	: 3V/m		
Required Performance	: A	Actual Performance	: A		
Modulation: <input checked="" type="checkbox"/> AM <input type="checkbox"/> Pulse <input type="checkbox"/> none 1 kHz 80%					
Frequency Range :80 MHz -1000MHz, 1800MHz, 2600MHz, 3500MHz, 5000MHz					
Steps	1%				
	Horizontal		Vertical		Result
	Required	Observation	Required	Observation	(Pass / Fail)
Front	A	A	A	A	Pass
Right	A	A	A	A	Pass
Rear	A	A	A	A	Pass
Left	A	A	A	A	Pass
Test Equipment :					
1. Signal Generator : Marconi 2031B					
2. Power Amplifier : A&R 500A/100;100W/1000M.					
3. Power Antenna : A&R AT-1080.					
4. Field Monitor : A&R FM7004.					
Remark: Class A is no function loss.					



10. ELECTRICAL FAST TRANSIENT/BURST TEST

10.1. Test Equipments

Item	Equipment	Manufacturer	Model No.	Serial No.	Last Cal.	Cal. Interval
1.	EFT Equipment	3ctest	EFT-4001G	201007100461015	May 06, 22	1 Year

10.2. Block Diagram of Test Setup

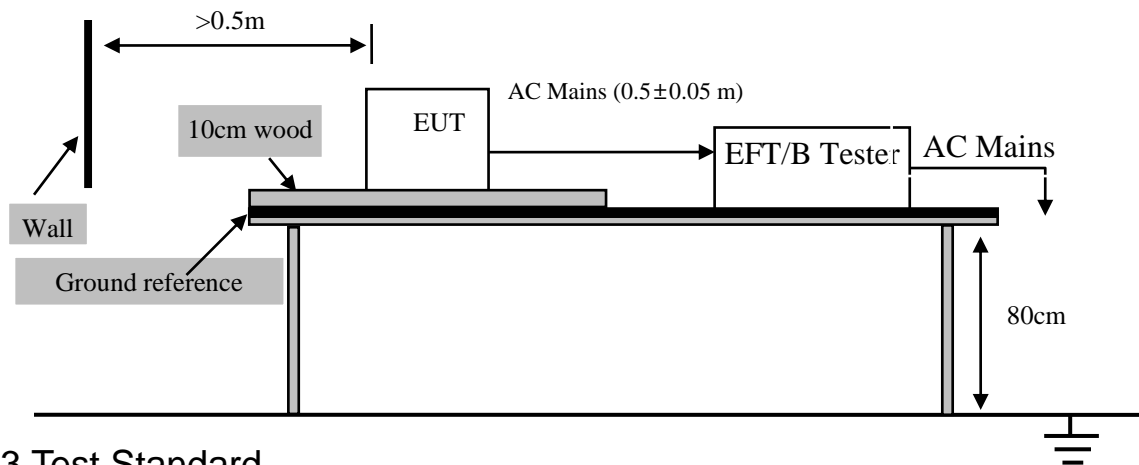

10.3. Test Standard

EN 55035 (IEC 61000-4-4)
(Severity Level 2 at 1kV)

10.4. Severity Levels and Performance Criterion

10.4.1. Severity level

Open Circuit Output Test Voltage $\pm 10\%$		
Level	On Power Supply Lines	On I/O (Input/Output) Signal data and control lines
1.	0.5 kV	0.25 kV
2.	1 kV	0.5 kV
3.	2 kV	1 kV
4.	4 kV	2 kV
X	Special	Special

10.4.2. Performance criterion : B

10.5. EUT Configuration

The configuration of EUT are listed in section 3.5.



10.6. Operating Condition of EUT

Same as conducted test which is listed in section 3.6. except the test setup replaced by section 12.2.

10.7. Test Procedure

The EUT and its simulators were placed on the ground reference plane and were insulated from it by a wood support $0.1\text{m} \pm 0.01\text{m}$ thick. The ground reference plane was $1\text{m} \times 1\text{m}$ metallic sheet with 0.65mm minimum thickness. This reference ground plane was project beyond the EUT by at least 0.1m on all sides and the minimum distance between EUT and all other conductive structure, except the ground plane was more than 0.5m. All cables to the EUT was placed on the wood support, cables not subject to EFT/B was routed as far as possible from the cable under test to minimize the coupling between the cables.

10.7.1. For input and output AC power ports:

The EUT was connected to the power mains by using a coupling device which couples the EFT interference signal to AC power lines. Both positive transients and negative transients of test voltage were applied during compliance test and the duration of the test can't less than 1min.

10.7.2. For signal lines and control lines ports:

It's not I/O ports.

It's unnecessary to measure.

10.7.3. For DC input and DC output power ports:

It's not DC ports.

It's unnecessary to measure.

10.8. Test Result

PASS.

The EUT was tested and all the test results are listed in next page.



Electrical Fast Transient/Burst Test Results

Applicant	: Shenzhen Yongjiu Precision Electronics Co.,Ltd.	Test Date	: Feb. 24, 2023
EUT	: Wall Charger	Temperature	: 23°C
M/N	: YJ-N24	Humidity	: 50%
Test Voltage	: AC230V, 50Hz	Test Mode	: Max. Normal loaded
Test Engineer	: Sunny Yuan	Pressure	: 101.3KPa
Required Performance	: B	Actual Performance	: A

Repetition Frequency : <u>5 kHz</u> Burst Duration : <u>15ms</u> Burst Period: <u>300ms</u>					
Inject Time(s): <u>120s</u> Inject Method: <u>Direct</u>					
Inject Line: <input checked="" type="checkbox"/> AC Mains <input type="checkbox"/> DC Supply <input type="checkbox"/> Signal					
Line	Test Voltage	Performance			Result
		Required	Observation(+)	Observation(-)	(Pass/Fail)
L	0.5/1kV	B	A	A	Pass
N	0.5/1kV	B	A	A	Pass
L N	0.5/1kV	B	A	A	Pass
L-PE	--	--	--	--	N/A
N-PE	--	--	--	--	N/A
L-N-PE	--	--	--	--	N/A
Signal Line	--	--	--	--	N/A
Test Equipment : Burst Tester (EFT-4001G)					
Remark: No function loss					



11.SURGE TEST

11.1.Test Equipments

Item	Equipment	Manufacturer	Model No.	Serial No.	Last Cal.	Cal. Interval
1.	Surge CDN	3ctest	SGN-5010G	EC5591004	May 06, 21	1 Year
2	Surge Generator	3ctest	SG-5006G	EC5581006	May 06, 21	1 Year

11.2.Block Diagram of Test Setup

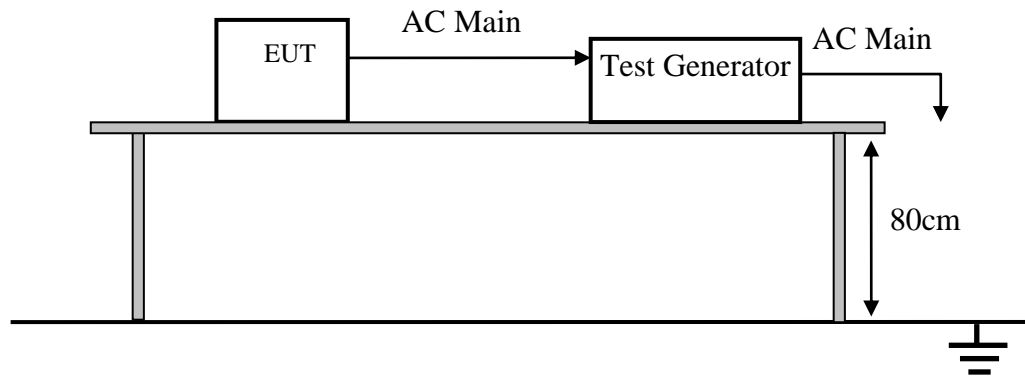

11.3.Test Standard

EN 55035 (IEC 61000-4-5)

(Severity Level: Line to Line: Level 2 at 1kV

Line to Ground: Level 3 at 2kV)

11.4.Severity Levels and Performance Criterion

11.4.1.Severity level

Severity Level	Open-Circuit Test Voltage kV
1	0.5
2	1.0
3	2.0
4	4.0
*	Special

11.4.2.Performance criterion : **B**



11.5.EUT Configuration

The configuration of EUT are listed in section 3.5.

11.6.Operating Condition of EUT

Same as conducted test which is listed in section 3.6. except the test setup replaced by section 13.2.

11.7.Test Procedure

- 1) Set up the EUT and test generator as shown on Section 13.2.
- 2) For line to line coupling mode, provide a 1kV 1.2/50us voltage surge (at open-circuit condition) and 8/20us current surge to EUT selected points, and for active line / neutral line to ground are same except test level is 2kV.
- 3) At least 5 positive and 5 negative (polarity) tests with a maximum 1/min repetition rate are applied during test.
- 4) Different phase angles are done individually.
- 5) Record the EUT operating situation during compliance test and decide the EUT immunity criterion for above each test.

11.8.Test Result

PASS.

The EUT was tested and all the test results are listed in next page.



Surge Immunity Test Results

Applicant	: Shenzhen Yongjiu Precision Electronics Co.,Ltd.	Test Date	: Feb. 24, 2023
EUT	: Wall Charger	Temperature	: 23°C
M/N	: YJ-N24	Humidity	: 50%
Test Voltage	: AC230V, 50Hz	Test Mode	: Max. Normal loaded
Test Engineer	: Sunny Yuan	Pressure	: 101.3KPa
Required Performance	: B	Actual Performance	: A

No.of pluse: 5 Times/Phase Angle		Interval:60 Seconds									
Line : <input checked="" type="checkbox"/> AC Mains <input type="checkbox"/> DC Supply <input type="checkbox"/> Signal											
Location	Volt	500V			1kV			2kV			Result (Pass/Fail)
	Phase	Performance			Performance			Performance			
		Required	+	-	Required	+	-	Required	+	-	
L-N	0°	/	/	/	/	/	/	/	/	/	Pass
	90°	B	A	/	B	A	/	/	/	/	Pass
	180°	/	/	/	/	/	/	/	/	/	Pass
	270°	B	/	A	B	/	A	/	/	/	Pass
L-PE	0°	--	--	--	--	--	--	--	--	--	N/A
	90°	--	--	--	--	--	--	--	--	--	N/A
	180°	--	--	--	--	--	--	--	--	--	N/A
	270°	--	--	--	--	--	--	--	--	--	N/A
N-PE	0°	--	--	--	--	--	--	--	--	--	N/A
	90°	--	--	--	--	--	--	--	--	--	N/A
	180°	--	--	--	--	--	--	--	--	--	N/A
	270°	--	--	--	--	--	--	--	--	--	N/A
Signal Line	--	--	--	--	--	--	--	--	--	--	N/A
Test Equipment : Surge Generator (SG-5006G)											
Remark: No function loss											



12. INJECTED CURRENTS SUSCEPTIBILITY TEST

12.1. Test Equipments

Item	Equipment	Manufacturer	Model No.	Serial No.	Last Cal.	Cal. Interval
1.	Conducted Immunity Test System	Frankonia	CIT-10/75	12681247/2013	May 06, 22	1 Year
2.	Fixed Coaxial Attenuator	CD	ATT-0675	120540086	May 06, 22	1 Year
3.	coupling-decoupling network (CDN)	CD	CDN M2/M3	2302	May 06, 22	1 Year
4.	Electromagnetic Injection Clamp (EMC-Clamp)	CD	EM-Clamp	0513A031201	May 06, 22	1 Year

12.2.B Block Diagram of Test Setup

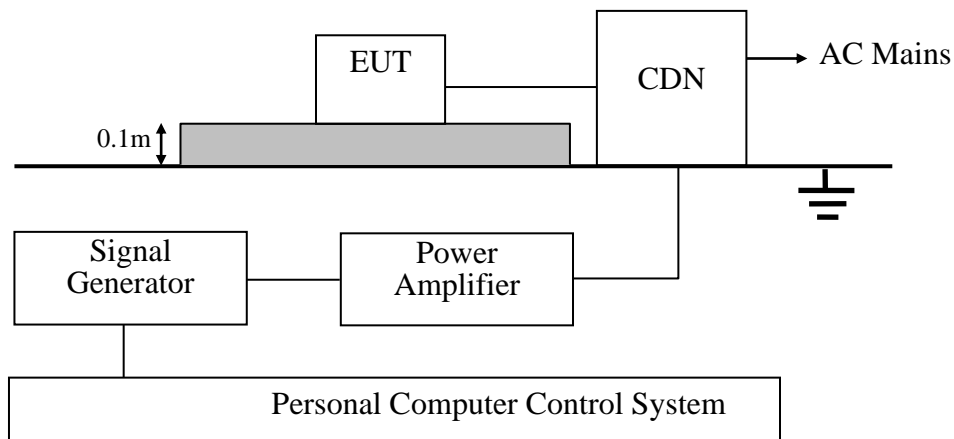

12.3. Test Standard

EN 55035 (IEC61000-4-6)

(Severity Level 2 at 3Vrms and frequency is from 0.15MHz to 230MHz)

12.4. Severity Levels and Performance Criterion

12.4.1. Severity level

Level	Voltage Level (e.m.f.) V
1.	1



2.	3
3.	10
X	Special

12.4.2. Performance criterion: A

12.5. EUT Configuration

The configuration of EUT are listed in section 3.5.

12.6. Operating Condition of EUT

Same as conducted test which is listed in section 3.6. except the test set up replaced by section 14.2.

12.7. Test Procedure

- 1) Set up the EUT, CDN and test generators as shown on section 14.2.
- 2) Let EUT work in test mode and measure.
- 3) The EUT and supporting equipments are placed on an insulating support 0.1m high above a ground reference plane. CDN (coupling and decoupling device) is placed on the ground plane at above 0.1-0.3m from EUT. Cables between CDN and EUT are as short as possible, and their height above the ground reference plane shall be between 30 and 50 mm (where possible).
- 4) The disturbance signal described below is injected to EUT through CDN.
- 5) The EUT operates within its operational mode(s) under intended climatic conditions after power on.
- 6) The frequency range is swept from 150kHz to 230MHz using 3V signal level, and with the disturbance signal 80% amplitude modulated with a 1kHz sine wave.
- 7) The rate of sweep shall not exceed 1.5×10^{-3} decades/s. Where the frequency is swept incrementally, the step size shall not exceed 1% of the start and thereafter 1% of the preceding frequency value.
- 8) Recording the EUT operating situation during compliance testing and decide the EUT immunity criterion.

12.8. Test Results

PASS.

The EUT was tested and all the test results are listed in next page.



Injected Currents Susceptibility Test Results

Applicant	: Shenzhen Yongjiu Precision Electronics Co.,Ltd.	Test Date	: Feb. 24, 2023
EUT	: Wall Charger	Temperature	: 24°C
M/N	: YJ-N24	Humidity	: 50%
Test Voltage	: AC230V, 50Hz	Test Mode	: Max. Normal loaded
Test Engineer	: Sunny Yuan	Pressure	: 101.3KPa
Required Performance	: B	Actual Performance	: A
Required Performance	: A	Actual Performance	: A

Frequency Range (MHz)	Injected Position	Voltage Level (e.m.f.)	Required	Observation	Result
					(Pass / Fail)
0.15 ~ 10	AC Mains	3V	A	A	PASS
10 ~ 30	AC Mains	3V ~ 1V	A	A	PASS
30 ~ 80	AC Mains	1V	A	A	PASS

Modulation Signal: 1kHz 80% AM

Remark: No function loss.



13. VOLTAGE DIPS AND INTERRUPTIONS TEST

13.1. Test Equipments

Item	Equipment	Manufacturer	Model No.	Serial No.	Last Cal.	Cal. Interval
1.	Voltage Dips and Up Generator	3ctest	VDG-1105G	20100429 0171002	May 06, 21	1 Year

13.2. Block Diagram of Test Setup

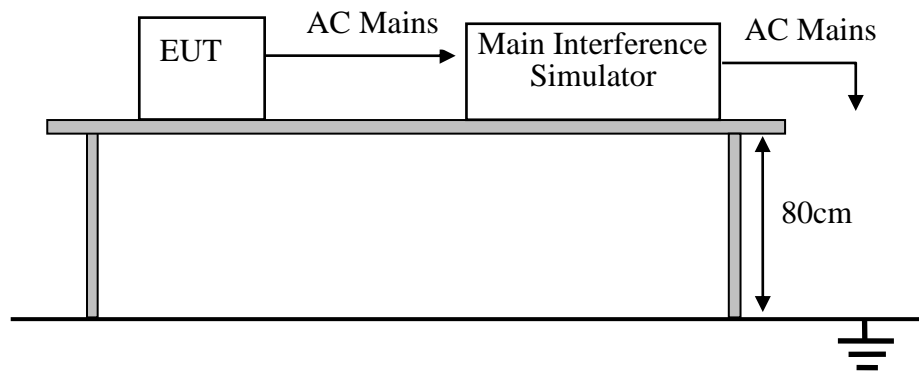

13.3. Test Standard

EN 55035 (IEC 61000-4-11)

13.4. Severity Levels and Performance Criterion

13.4.1. Severity level

Test Level %U _T	Voltage dip and short interruptions %U _T	Performance Criterion	Duration (in period)
0	100	C	250
0	100	B	0.5
30	70	C	25

13.4.2. Performance criterion : C

13.5. EUT Configuration

The configuration of EUT are listed in section 3.5.



13.6. Operating Condition of EUT

Same as conducted test which is listed in section 3.6. except the test set up replaced by section 15.2.

13.7. Test Procedure

- 1) Set up the EUT and test generator as shown on section 15.2.
- 2) The interruptions is introduced at selected phase angles with specified duration.
There is a 3mins minimum interval between each test event.
- 3) After each test a full functional check is performed before the next test.
- 4) Repeat procedures 2 & 3 for voltage dips, only the test level and duration is changed.
- 5) Record any degradation of performance.

13.8. Test Result

PASS.

The EUT was tested and all the test results are listed in next page.



Voltage Dips And Interruptions Test Results

Applicant	: Shenzhen Yongjiu Precision Electronics Co.,Ltd.	Test Date	: Feb. 24, 2023
EUT	: Wall Charger	Temperature	: 24°C
M/N	: YJ-N24	Humidity	: 50%
Test Voltage	: AC230V, 50Hz	Test Mode	: Max. Normal loaded
Test Engineer	: Sunny Yuan	Pressure	: 101.3KPa
Required Performance	: B & C	Actual Performance	: A & B

Test Level % U _T	Voltage Dips & Short Interruptions % U _T	Duration (in period)	Phase Angle	Required	Observation	Result
						(Pass / Fail)
0	100	0.5P	0° -360°	B	A	PASS
70	30	25P	0° -360°	C	B	PASS
0	100	250P	0° -360°	C	C	PASS

Note: U_T is the rated voltage for the equipment.

Test Equipment :
Main Interference Simulator:
(VDG-1105G)

Remark: Class B test picture of EUT was little flicker, and after finishing the test ,it can be self recovery.



Test Photo





14. PHOTO OF THE EUT



Photographs 01: Overall view



Photographs 02: Overall view



Photographs 03: Component side view of PCB

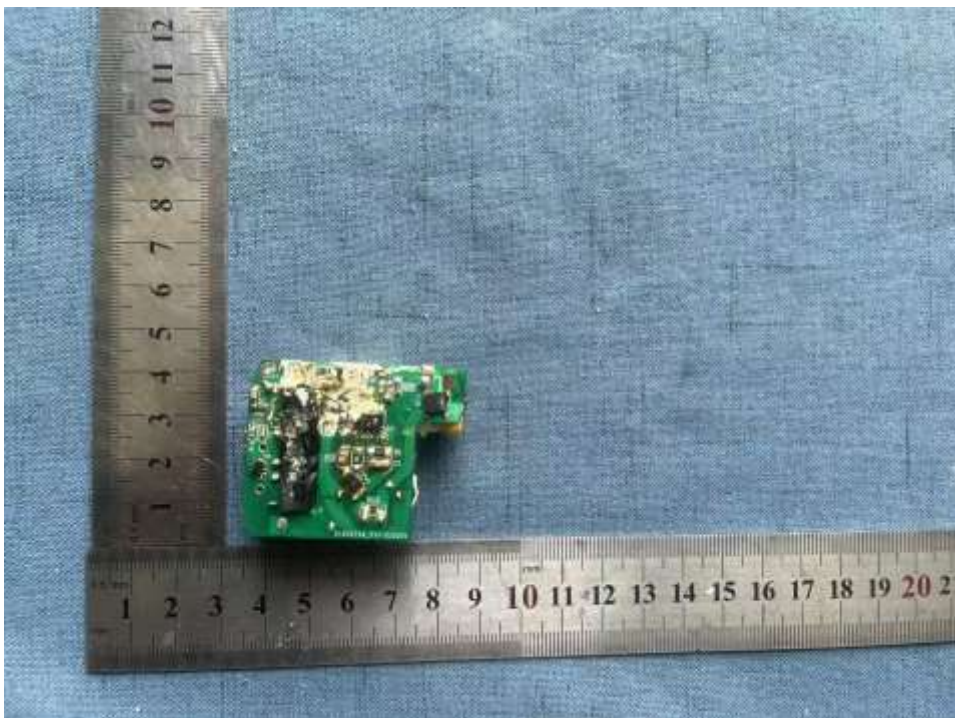

Photographs 04: Trace side view of PCB

-----THE END OF REPORT-----