



RF TEST REPORT

Product Name: Bluetooth Headphones

Model Name: HS-BN928

Issued For : Honsenn Technology Co.Ltd

No.70, Erheng Road, wentang zhuangyao industrial zone,
Dongcheng district,Dongguan City,Guangdong Province.

Issued By : Shenzhen LGT Test Service Co., Ltd.

Room 205, Building 13, Zone B, Chen Hsong Industrial Park,
No.177 Renmin West Road, Jinsha Community, Kengzi
Street, Pingshan New District, Shenzhen, China

Report Number: LGT23D025RF01

Sample Received Date: Apr. 10, 2023

Date of Test: Apr. 10, 2023 – Apr. 20, 2023

Date of Issue: Apr. 20, 2023

The test report is effective only with both signature and specialized stamp. This report shall not be reproduced except in full without the written approval of the Laboratory. The results in this report only apply to the tested sample.



Table of Contents

1. SUMMARY OF TEST RESULTS	6
1.1 TEST FACTORY	7
1.2 MEASUREMENT UNCERTAINTY	7
2. GENERAL INFORMATION	8
2.1 GENERAL DESCRIPTION OF THE EUT	8
2.2 ENVIRONMENTAL CONDITIONS FOR TESTING	13
2.3 TEST MODE	13
2.4 DESCRIPTION OF NECESSARY ACCESSORIES AND SUPPORT UNITS	14
2.5 EQUIPMENTS LIST	15
3. RF OUTPUT POWER	16
3.1 LIMIT	16
3.2 TEST PROCEDURES	16
3.3 TEST SETUP	16
3.4 TEST RESULT	16
4. ACCUMULATED TRANSMIT TIME, FREQUENCY OCCUPATION & HOPPING SEQUENCE	17
4.1 LIMIT	17
4.2 TEST PROCEDURE	18
4.3 TEST SETUP	18
5. HOPPING FREQUENCY SEPARATION	19
5.1 LIMIT	19
5.2 TEST PROCEDURE	19
5.3 TEST SETUP	19
5.4 TEST RESULT	19
6. OCCUPIED CHANNEL BANDWIDTH	20
6.1 LIMIT	20
6.2 TEST PROCEDURES	20
6.3 TEST SETUP	20
7. TRANSMITTER UNWANTED EMISSIONS IN THE OOB DOMAIN	21
7.1 LIMIT	21
7.2 TEST PROCEDURES	21
7.3 TEST SETUP	22
7.4 TEST RESULT	22
8. SPURIOUS EMISSIONS – TRANSMITTER	23

**Table of Contents**

8.1 LIMIT	23
8.2 TEST PROCEDURES	23
8.3 TEST SETUP	24
8.4 EUT OPERATION DURING TEST	25
8.5 TEST RESULT	26
9. SPURIOUS EMISSIONS – RECEIVER	30
9.1 LIMIT	30
9.2 TEST PROCEDURES	30
9.3 EUT OPERATION DURING TEST	31
9.4 TEST SETUP	31
9.5 TEST RESULT	32
10. RECEIVER BLOCKING	34
10.1 LIMIT	34
10.2 TEST PROCEDURES	35
10.3 TEST SETUP	36
10.4 TEST RESULT	37
11. ADAPTIVE (CHANNEL ACCESS MECHANISM)	40
11.1 LIMIT	40
11.2 TEST PROCEDURES	40
11.3 TEST SETUP	41
11.4 TEST RESULTS	41
APPENDIX I - TEST RESULTS	42
Duty Cycle, Tx Sequence, Tx Gap, Medium Utilisation	42
RF Output Power	43
Accumulated Transmit Time	45
Frequency Occupation	48
Hopping Sequence	51
Dwell Time One Burst	53
Hopping Frequency Separation	56
Occupied Channel Bandwidth	59
Transmitter unwanted emissions in the out-of-band domain	62
Transmitter unwanted emissions in the spurious domain	64
Receiver spurious emissions	69
APPENDIX II - MEASUREMENT PHOTOS	72



Revision History

Rev.	Issue Date	Contents
00	Apr. 20, 2023	Initial Issue



TEST REPORT CERTIFICATION

Applicant: Honsenn Technology Co.Ltd
Address: No.70, Erheng Road, wentang zhuangyao industrial zone, Dongcheng district,Dongguan City,Guangdong Province.

Manufacture: Honsenn Technology Co.Ltd
Address: No.70, Erheng Road, wentang zhuangyao industrial zone, Dongcheng district,Dongguan City,Guangdong Province.

Factory: Honsenn Technology Co.Ltd
Address: No.70, Erheng Road, wentang zhuangyao industrial zone, Dongcheng district,Dongguan City,Guangdong Province.

Product Name: Bluetooth Headphones

Trademark: N/A

Model Name: HS-BN928

Sample Status: Normal

APPLICABLE STANDARDS	
STANDARD	TEST RESULTS
ETSI EN 300 328 V2.2.2	PASS

Prepared by:

Zane Shan

Zane Shan
Engineer

Approved by:

Vita Li

Vita Li
Technical Director





1. SUMMARY OF TEST RESULTS

Test procedures according to the technical standards:

ETSI EN 300 328 V2.2.2			
Test Item	Limit	Frequency Range (MHz)	Applicable (Yes/No)
TRANSMITTER PARAMETERS			
RF output power	Clause 4.3.1.2.3	2400-2483.5	Y
Duty Cycle, Tx-sequence, Tx-gap	Clause 4.3.1.3.3		Y
Accumulated Transmit time, Frequency Occupation & Hopping Sequence	Clause 4.3.1.4.3		Y
Hopping Frequency Separation	Clause 4.3.1.5.3		Y
Medium Utilization	Clause 4.3.1.6.3		N
Adaptivity (Adaptive FHSS)	Clause 4.3.1.7		N
Occupied Channel Bandwidth	Clause 4.3.1.8.3		Y
Transmitter unwanted emissions in the OOB domain	Clause 4.3.1.9.3	FL=2400-2BW FH=2483.5+2BW	Y
Transmitter unwanted emissions in the spurious domain (Conducted)	Clause 4.3.1.10.3	30-12750	N
Transmitter unwanted emissions in the spurious domain (Radiated)			Y
RECEIVER PARAMETERS			
Spurious emissions (Conducted)	Clause 4.3.1.11.3	30-12750	N
Spurious emissions (Radiated)			Y
Receiver Blocking	Clause 4.3.1.12.4	2400-2483.5	Y
Geo-location capability	Clause 4.3.1.13.3	--	N



1.1 TEST FACTORY

Company Name:	Shenzhen LGT Test Service Co., Ltd.
Address:	Room 205, Building 13, Zone B, Chen Hsong Industrial Park, No.177 Renmin West Road, Jinsha Community, Kengzi Street, Pingshan New District, Shenzhen, China
Accreditation Certificate	A2LA Certificate No.: 6727.01
	FCC Registration No.: 746540
	CAB ID: CN0136

1.2 MEASUREMENT UNCERTAINTY

The reported uncertainty of measurement $y \pm U$, where expanded uncertainty U is based on a standard uncertainty multiplied by a coverage factor of $k=2$, providing a level of confidence of approximately **95** %.

Parameter	Uncertainty
Occupied Channel Bandwidth	± 3.2 %
RF Output Power, Conducted	± 0.87 dB
Power Spectral Density, Conducted	± 2.11 dB
Unwanted Emission, Conducted	± 0.86 dB
All Emissions, Radiated (Below 1GHz)	± 3.54 dB
All Emissions, Radiated (1GHz-18GHz)	± 4.22 dB
All Emissions, Radiated (18GHz-25GHz)	± 4.81 dB
Temperature	± 0.5 °C
Humidity	± 2 %



2. GENERAL INFORMATION

2.1 GENERAL DESCRIPTION OF THE EUT

Product Name:	Bluetooth Headphones	
Trademark:	N/A	
Model Name:	HS-BN928	
Series Model:	N/A	
Model Difference:	N/A	
Product Description:	The EUT is Bluetooth Headphones	
	Operation Frequency	2402~2480 MHz
	Modulation Type	BT BR(1Mbps): GFSK BT EDR(2Mbps): $\pi/4$ -DQPSK BT EDR(3Mbps): 8DPSK
	Number Of Channel	79CH
	Antenna Designation	chip antenna
	Antenna Gain (Peak)	3.45dBi
	Based on the application, features, or specification exhibited in User Manual, the EUT is considered as an ITE/Computing Device. More details of EUT technical specification, please refer to the User Manual.	
Channel List:	Refer to Note 2.	
Rating:	Input: DC 5V, 1A	
Battery:	Capacity: 900mAh Rated Voltage: 3.7V	
Hardware Version:	V1.3	
Software Version:	V2.0	
Connecting I/O Port(s):	Refer to Note 1.	

Note:

1. For a more detailed features description, please refer to the manufacturer's specifications or the User Manual, the antenna information refer the manufacturer provide report, applicable only to the tested sample identified in the report.



2.

Channel	Frequency (MHz)
00	2402
01	2403
02	2404
.....
39	2441
40	2442
41	2443
.....
77	2479
78	2480

a) The type of modulation used by the equipment:

- FHSS
- non-FHSS

b) In case of FHSS:

- In case of non-Adaptive FHSS equipment:
The number of Hopping Frequencies:
- In case of Adaptive FHSS equipment:
The maximum number of Hopping Frequencies: 79
The minimum number of Hopping Frequencies: 79
- The (average) Dwell Time:

c) Adaptive / non-adaptive equipment:

- non-adaptive Equipment
- adaptive Equipment without the possibility to switch to a non-adaptive mode
- adaptive Equipment which can also operate in a non-adaptive mode

d) In case of adaptive equipment:

- The maximum Channel Occupancy Time implemented by the equipment: ms
- The equipment has implemented an LBT mechanism
- In case of non-FHSS equipment:
 - The equipment is Frame Based equipment
 - The equipment is Load Based equipment
 - The equipment can switch dynamically between Frame Based and Load Based equipment
- The CCA time implemented by the equipment: μ s
- The equipment has implemented a DAA mechanism
- The equipment can operate in more than one adaptive mode

e) In case of non-adaptive Equipment:

- The maximum RF Output Power (e.i.r.p.): dBm
- The maximum (corresponding) Duty Cycle:%
- Equipment with dynamic behavior, that behavior is described here. (e.g. the different combinations of duty cycle and corresponding power levels to be declared):

f) The worst-case operational mode for each of the following tests:

- RF Output Power
GFSK
- Accumulated Transmit Time, Frequency Occupation & Hopping Sequence
GFSK
- Hopping Frequency Separation (only for FHSS equipment)
GFSK
- Occupied Channel Bandwidth
GFSK



- Transmitter unwanted emissions in the OOB domain
 $\pi/4$ -DQPSK
- Transmitter unwanted emissions in the spurious domain
GFSK
- Receiver spurious emissions
GFSK
- Receiver Blocking
GFSK

g) The different transmit operating modes (tick all that apply):

- Operating mode 1: Single Antenna Equipment
- Equipment with only one antenna
- Equipment with two diversity antennas but only one antenna active at any moment in time
- Smart Antenna Systems with two or more antennas, but operating in a (legacy) mode where only one antenna is used. (BT mode in smart antenna systems)
- Operating mode 2: Smart Antenna Systems - Multiple Antennas without beam forming
- Single spatial stream / Standard throughput / (BT mode)
- High Throughput (> 1 spatial stream) using Occupied Channel Bandwidth 1
- High Throughput (> 1 spatial stream) using Occupied Channel Bandwidth 2
- NOTE: Add more lines if more channel bandwidths are supported.
- Operating mode 3: Smart Antenna Systems - Multiple Antennas with beam forming
- Single spatial stream / Standard throughput (BT mode)
- High Throughput (> 1 spatial stream) using Occupied Channel Bandwidth 1
- High Throughput (> 1 spatial stream) using Occupied Channel Bandwidth 2
- NOTE: Add more lines if more channel bandwidths are supported.

h) In case of Smart Antenna Systems:

- The number of Receive chains:
 - The number of Transmit chains:
 - symmetrical power distribution
 - asymmetrical power distribution
- In case of beam forming, the maximum beam forming gain:
- NOTE: Beam forming gain does not include the basic gain of a single antenna.

i) Operating Frequency Range(s) of the equipment:

- Operating Frequency Range 1: 2402 MHz to 2480 MHz
- Operating Frequency Range 2:
NOTE: Add more lines if more Frequency Ranges are supported.

j) Occupied Channel Bandwidth(s):

- Occupied Channel Bandwidth: 0.882MHz
- Occupied Channel Bandwidth: 1.254MHz
- NOTE: Add more lines if more channel bandwidths are supported.

k) Type of Equipment (stand-alone, combined, plug-in radio device, etc.):

- Stand-alone
- Combined Equipment (Equipment where the radio part is fully integrated within another type of equipment)
- Plug-in radio device (Equipment intended for a variety of host systems)
- Other



l) The extreme operating conditions that apply to the equipment:

Operating temperature range: -0°C – 40°C

Operating voltage range: DC 3.3V~ DC 4.2V(Normal: DC 3.7V)

Details provided are for the:

- stand-alone equipment
- combined (or host) equipment
- test jig

m) The intended combination(s) of the radio equipment power settings and one or more antenna assemblies and their corresponding e.i.r.p levels:

• Antenna Type

■ Chip Antenna

Antenna Gain: 3.45dBi

If applicable, additional beamforming gain (excluding basic antenna gain): dB

- Temporary RF connector provided
- No temporary RF connector provided
- Dedicated Antennas (equipment with antenna connector)
- Single power level with corresponding antenna(s)
- Multiple power settings and corresponding antenna(s)
 - Number of different Power Levels:
 - Power Level 1: dBm
 - Power Level 2: dBm
 - Power Level 3: dBm

NOTE 1: Add more lines in case the equipment has more power levels.

NOTE 2: These power levels are conducted power levels (at antenna connector).

•For each of the Power Levels, provide the intended antenna assemblies, their, corresponding gains (G) and the resulting e.i.r.p. levels also taking into account the beamforming gain (Y) if applicable

Power Level 1: dBm

Number of antenna assemblies provided for this power level:

Assembly #	Gain (dBi)	e.i.r.p.(dBm)	Part number or model name
1	3.45	7.21	HS-BN928
2			
3			
4			

NOTE: Add more rows in case more antenna assemblies are supported for this power level.

Power Level 2: dBm

Number of antenna assemblies provided for this power level:

Assembly #	Gain (dBi)	e.i.r.p.(dBm)	Part number or model name
1			
2			
3			
4			

NOTE: Add more rows in case more antenna assemblies are supported for this power level.



Power Level 3: dBm

Number of antenna assemblies provided for this power level:

Assembly #	Gain (dBi)	e.i.r.p.(dBm)	Part number or model name
1			
2			
3			
4			

NOTE: Add more rows in case more antenna assemblies are supported for this power level.

n) The nominal voltages of the stand-alone radio equipment or the nominal voltages of the combined (host) equipment or test jig in case of plug-in devices:

Details provided are for the: stand-alone equipment

combined (or host) equipment

test jig Supply Voltage

AC mains State AC voltage: AC 230V/50Hz

DC State DC voltage: 5V

In case of DC, indicate the type of power source

Internal Power Supply

External Power Supply or AC/DC adapter

Battery: 3.7V

Other:

o) Describe the test modes available which can facilitate testing:

Type	Mode Or Modulation type	ANT Gain(dBi)	Power Class	Software For Testing
BR+EDR	GFSK	3.45	251	BlueTest3
	$\pi/4$ -DQPSK	3.45	251	
	8DPSK	3.45	251	

p) The equipment type (e.g. Bluetooth®, IEEE 802.11™, IEEE 802.15.4™, proprietary, etc.):
BT

q) If applicable, the statistical analysis referred to in clause 5.4.1 q)
(to be provided as separate attachment)

r) If applicable, the statistical analysis referred to in clause 5.4.1 r)
(to be provided as separate attachment)

s) Geo-location capability supported by the equipment:

Yes

The geographical location determined by the equipment as defined in clause 4.3.1.13.2 or clause 4.3.2.12.2 is not accessible to the user

No



2.2 ENVIRONMENTAL CONDITIONS FOR TESTING

Test Condition	Temperature(°C)	Voltage(V)	Relative Humidity (%)
NT/NV	25	3.7V	54%
LT/NV	0	3.7V	/
HT/NV	40	3.7V	/

Note:

- (1) The EUT can only work from LT -0°C to HT 40°C which is declared by the manufacturer, and the EUT can't operate normally at higher or lower temperature than the declared range.
- (2) NV: Normal Voltage; NT: Normal Temperature.
- (3) LT: Low Extreme Test Temperature; HT: High Extreme Test Temperature.

2.3 TEST MODE

The EUT has been tested as an independent unit together with other necessary accessories or support units. The following support units or accessories were used to form a representative test configuration during the tests.

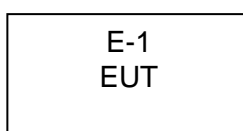

The EUT was programmed to be in continuously transmitting mode.

Test Channel	EUT Channel	Test Frequency (MHz)
lowest	CH00	2402
middle	CH39	2441
highest	CH78	2480



2.4 DESCRIPTION OF NECESSARY ACCESSORIES AND SUPPORT UNITS

The EUT has been tested as an independent unit together with other necessary accessories or support units. The following support units or accessories were used to form a representative test configuration during the tests.

Accessories Equipment

Description	Manufacturer	Model	S/N	Rating

Auxiliary Equipment

Description	Manufacturer	Model	S/N	Rating
Adapter	Tenpao	S005CAU0500100	N/A	Input: 100-240V ~ 50/60Hz 0.2A Output: 5V, 1A
USB-A to USB-C Cable	UGREEN	US287	N/A	1m, shielded, without ferrite core
Mobile phone	SHARK	KSR-10	N/A	N/A
3.5mm to 3.5mm Cable	N/A	N/A	N/A	0.5m

Note:

- (1) For detachable type I/O cable should be specified the length in cm in 『Length』 column.



2.5 EQUIPMENTS LIST

RF Radiated Test equipment					
Equipment	Manufacturer	Model No.	Serial No.	Cal. Date	Cal. Until
EMI Test Receiver	R&S	ESU8	100372	2023.04.10	2024.04.09
Active loop Antenna	ETS	6502	00049544	2022.06.02	2024.06.01
Spectrum Analyzer	Keysight	N9010B	MY60242508	2022.04.29	2023.04.28
Bilog Antenna	SCHAFFNER	CBL6112B	2705	2022.06.05	2024.06.04
Bilog Antenna	SCHAFFNER	VULB 9168	01447	2022.12.12	2023.12.11
Horn Antenna	Schwarzbeck	3115	10SL0060	2022.06.02	2024.06.01
Pre-amplifier (9kHz-1GHz)	EMtrace	RP01A	02017	2023.04.10	2024.04.09
Pre-amplifier (1-26.5G)	Agilent	8449B	3008A4722	2023.04.10	2024.04.09
Wireless Communications Test Set	R&S	CMW 500	137737	2022.04.29	2023.04.28
Temperature & Humidity	KTJ	TA218B	N.A	2022.05.05	2023.05.04
Testing Software	EMC-I_V1.4.0.3_SKET				

RF Conducted Test equipment					
Equipment	Manufacturer	Model No.	Serial No.	Cal. Date	Cal. Until
Signal Analyzer	Keysight	N9010B	MY60242508	2022.04.29	2023.04.28
Signal Analyzer	Keysight	N9020A	MY50530994	2022.12.09	2023.12.08
RF Automatic Test system	MW	MW200-RFCB	MW220322LG	2022.04.29	2023.04.28
MXG Vector Signal Generator	Keysight	N5182B	MY59100717	2022.06.02	2023.06.01
Temperature & Humidity test chamber	AISRY	LX-1000L	171200018	2022.05.10	2023.05.09
Attenuator	eastsheep	90db	N.A	2022.04.29	2023.04.28
Router	TP-LINK(FCC ID:Q87-WRT3 200ACM)	TL-WR885N	1125074010735	N.C.R	N.C.R
Temperature & Humidity	KTJ	TA218B	N.A	2022.05.05	2023.05.04
Testing Software	MTS8310_V2.0.0.0_MW				



3. RF OUTPUT POWER

3.1 LIMIT

FHSS:

The maximum RF output power for adaptive Frequency Hopping equipment shall be equal to or less than 20 dBm. The maximum RF output power for non-adaptive Frequency Hopping equipment shall be declared by the manufacturer. See clause 5.4.1 m). The maximum RF output power for this equipment shall be equal to or less than the value declared by the manufacturer. This declared value shall be equal to or less than 20 dBm.

Other than FHSS:

For adaptive equipment using wide band modulations other than FHSS, the maximum RF output power shall be 20 dBm. The maximum RF output power for non-adaptive equipment shall be declared by the supplier and shall not exceed 20 dBm. See clause 5.4.1 m). For non-adaptive equipment using wide band modulations other than FHSS, the maximum RF output power shall be equal to or less than the value declared by the supplier.

This limit shall apply for any combination of power level and intended antenna assembly.

Limit
20 dBm

Between the start and stop times of each individual burst calculate the RMS power over the burst using the formula below. The start and stop points shall be included. Save these P_{burst} values, as well as the start and stop times for each burst.

$$P_{burst} = \frac{1}{k} \sum_{n=1}^k P_{sample}(n)$$

with k being the total number of samples and n the actual sample number.

3.2 TEST PROCEDURES

1. Please refer to ETSI EN 300 328 (V2.2.2) clause 5.4.2.1 for the test conditions.
2. Please refer to ETSI EN 300 328 (V2.2.2) clause 5.4.2.2 for the measurement method.
 - a) Use a fast power sensor suitable for 2.4 GHz and capable of 1 MS/s.
Use the following settings:
 - Sample speed 1 MS/s or faster.
 - The samples must represent the power of the signal.
 - Measurement duration: For non-adaptive equipment: equal to the observation period defined in b)
 - b) Clause 4.3.1.3.2 or clause 4.3.2.4.2. For adaptive equipment, the measurement duration shall be long enough to ensure a minimum number of bursts (at least 10) is captured.
 - c) Print the plots from power sensor by used power sensor on PC, select the max result and record it.

3.3 TEST SETUP

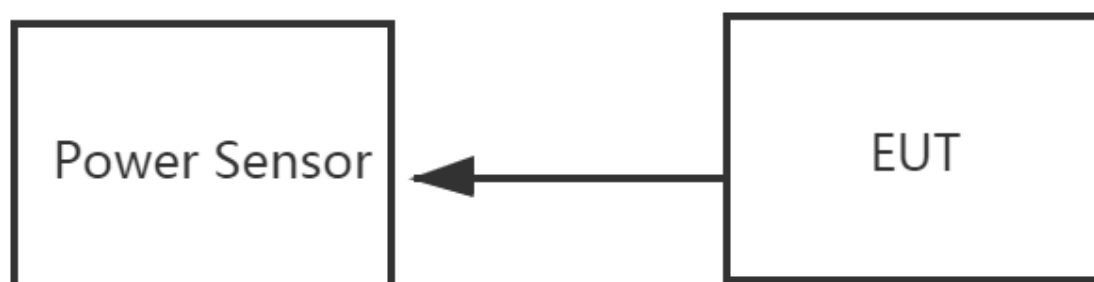

3.4 TEST RESULT

For the measurement records, refer to the appendix I.



4. ACCUMULATED TRANSMIT TIME, FREQUENCY OCCUPATION & HOPPING SEQUENCE

4.1 LIMIT

Non-adaptive frequency hopping systems

The Accumulated Transmit Time on any hopping frequency shall not be greater than 15 ms within any observation period of 15 ms multiplied by the minimum number of hopping frequencies (N) that have to be used.

Non-adaptive medical devices requiring reverse compatibility with other medical devices placed on the market that are compliant with version 2.0.2 or earlier versions of ETSI EN 300 328, are allowed to have an operating mode in which the maximum Accumulated Transmit Time is 400 ms within any observation period of 400 ms multiplied by the minimum number of hopping frequencies (N) that have to be used, only when communicating to these legacy devices

already placed on the market. In order for the equipment to comply with the Frequency Occupation requirement, it shall meet either of the following two options:

Option 1: Each hopping frequency of the hopping sequence shall be occupied at least once within a period not exceeding four times the product of the dwell time and the number of hopping frequencies in use.

Option 2: The occupation probability for each frequency shall be between $((1 / U) \times 25 \%)$ and 77 % where U is the number of hopping frequencies in use.

The hopping sequence(s) shall contain at least N hopping frequencies where N is 15 or 15 divided by the minimum Hopping Frequency Separation in MHz, whichever is the greater.

Adaptive frequency hopping equipment

Adaptive Frequency Hopping equipment shall be capable of operating over a minimum of 70 % of the band specified in clause 1.

The Accumulated Transmit Time on any hopping frequency shall not be greater than 400 ms within any observation period of 400 ms multiplied by the minimum number of hopping frequencies (N) that have to be used. In order for the equipment to comply with the Frequency Occupation requirement, it shall meet either of the following two options:

Option 1: Each hopping frequency of the hopping sequence shall be occupied at least once within a period not exceeding four times the product of the dwell time and the number of hopping frequencies in use.

Option 2: The occupation probability for each frequency shall be between $((1 / U) \times 25 \%)$ and 77 % where U is the number of hopping frequencies in use.

The hopping sequence(s) shall contain at least N hopping frequencies at all times, where N is 15 or 15 divided by the minimum Hopping Frequency Separation in MHz, whichever is the greater.



Other Requirements

For non-Adaptive Frequency Hopping equipment, from the N hopping frequencies defined in clause 4.3.1.4.3.1 above, the equipment shall transmit on at least one hopping frequency while other hopping frequencies are blacklisted. For equipment that blacklists one or more hopping frequencies, these blacklisted frequencies are considered as active transmitting for the calculation of the MU factor of the equipment. See also clause 5.4.2.2.1.3 step 4, second bullet item and clause 5.4.2.2.1.4 step 3, note 2. For Adaptive Frequency Hopping equipment, from the N hopping frequencies defined in clause 4.3.1.4.3.2 above, the equipment shall consider at least one hopping frequency for its transmissions. Providing that there is no interference present on this frequency with a level above the detection threshold defined in clause 4.3.1.7.2.2 point 5 or clause 4.3.1.7.3.2 point 5, then the equipment shall have transmissions on this frequency. For non-Adaptive Frequency Hopping equipment, when not transmitting on a hopping frequency, the equipment has to occupy that frequency for the duration of the typical dwell time (see also definition for blacklisted frequency in clause 3.1).

For Adaptive Frequency Hopping equipment using LBT based DAA, if a signal is detected during the CCA, the equipment may jump immediately to the next frequency in the hopping sequence (see clause 4.3.1.7.2.2 point 2) provided the limit for maximum dwell is respected.

4.2 TEST PROCEDURE

1. Please refer to ETSI EN 300 328 (V2.2.2) clause 5.4.4.1 for the test conditions.
2. Please refer to ETSI EN 300 328 (V2.2.2) clause 5.4.4.2 for the measurement method.
 - a) Set EUT work in hopping mode
 - b) Centre Frequency: Equal to the hopping frequency being investigated
 - c) Frequency Span: 0 Hz
 - d) RBW: ~ 50 % of the Occupied Channel Bandwidth
 - e) VBW: \geq RBW
 - f) Detector Mode: RMS
 - g) Sweep time: Equal to the applicable observation period (see clause 4.3.1.4.3.1 or clause 4.3.1.4.3.2)
 - h) Number of sweep points: 30000
 - j) Trace mode: Clear / Write
 - k) Trigger: Free Run

4.3 TEST SETUP



4.4 TEST RESULT

For the measurement records, refer to the appendix I.



5. HOPPING FREQUENCY SEPARATION

5.1 LIMIT

a. Non-adaptive frequency hopping systems

For non-adaptive Frequency Hopping equipment, the Hopping Frequency Separation shall be equal to or greater than the Occupied Channel Bandwidth (see clause 4.3.1.8), with a minimum separation of 100 kHz.

For equipment with a maximum declared RF Output power level of less than 10 dBm e.i.r.p. or for non-adaptive Frequency Hopping equipment operating in a mode where the RF Output power is less than 10 dBm e.i.r.p. only the minimum Hopping Frequency Separation of 100 kHz applies.

b. Adaptive frequency hopping systems

For adaptive Frequency Hopping equipment, the minimum Hopping Frequency Separation shall be 100 kHz.

Adaptive Frequency Hopping equipment that switched to a non-adaptive mode for one or more hopping frequencies because interference was detected on these hopping frequencies with a level above the threshold level defined in clause 4.3.1.7.2.2, point 5 or clause 4.3.1.7.3.2, point 5, is allowed to continue to operate with a minimum Hopping Frequency Separation of 100 kHz as long as the interference remains present on these hopping frequencies. The equipment shall continue to operate in an adaptive mode on other hopping frequencies.

Adaptive Frequency Hopping equipment which decided to operate in a non-adaptive mode on one or more hopping frequencies without the presence of interference, shall comply with the limit in clause 4.3.1.5.3.1 for these hopping frequencies as well as with all other requirements applicable to non-adaptive frequency hopping equipment.

5.2 TEST PROCEDURE

a. Please refer to ETSI EN 300 328 (V2.2.2) clause 5.4.5.1 for the test conditions.

b. Please refer to ETSI EN 300 328 (V2.2.2) clause 5.4.5.2 for the measurement method.

- Centre Frequency: Centre of the two adjacent hopping frequencies
- Frequency Span: Sufficient to see the complete power envelope of both hopping frequencies
- RBW: 1 % of the Span
- RBW: 20K
- VBW: 62K
- Detector Mode: PK
- Trace Mode: Max Hold
- Sweep time: 1S

5.3 TEST SETUP



5.4 TEST RESULT

For the measurement records, refer to the appendix I.



6. OCCUPIED CHANNEL BANDWIDTH

6.1 LIMIT

The Occupied Channel Bandwidth shall fall completely within the band 2400 MHz to 2483.5 MHz.

For non-adaptive Frequency Hopping equipment with e.i.r.p. greater than 10 dBm, the Occupied Channel Bandwidth for every occupied hopping frequency shall be equal to or less than the Nominal Channel Bandwidth declared by the manufacturer. See clause 5.4.1 j). This declared value shall not be greater than 5 MHz.

6.2 TEST PROCEDURES

1. Please refer to ETSI EN 300 328 (V2.2.2) clause 5.4.7.1 for the test conditions.
2. Please refer to ETSI EN 300 328 (V2.2.2) clause 5.4.7.2 for the measurement method.
 - Centre Frequency: The centre frequency of the channel under test
 - Resolution BW: ~ 1 % of the span without going below 1 %
 - Video BW: 3 × RBW
 - Frequency Span: 2 × Nominal Channel Bandwidth
 - Detector Mode: RMS
 - Trace Mode: Max Hold
 - Sweep time: 1S

6.3 TEST SETUP



6.4 TEST RESULT

For the measurement records, refer to the appendix I.



7. TRANSMITTER UNWANTED EMISSIONS IN THE OOB DOMAIN

7.1 LIMIT

Clause	Frequency	Limit
4.3.1.9.3	2400-BW~2400 2483.5~2483.5+BW	-10dBm/MHz
	2400-2BW~2400-BW 2483.5+BW~2483.5+2BW	-20dBm/MHz
	<2400-2BW >2483.5+2BW	-30dBm/MHz

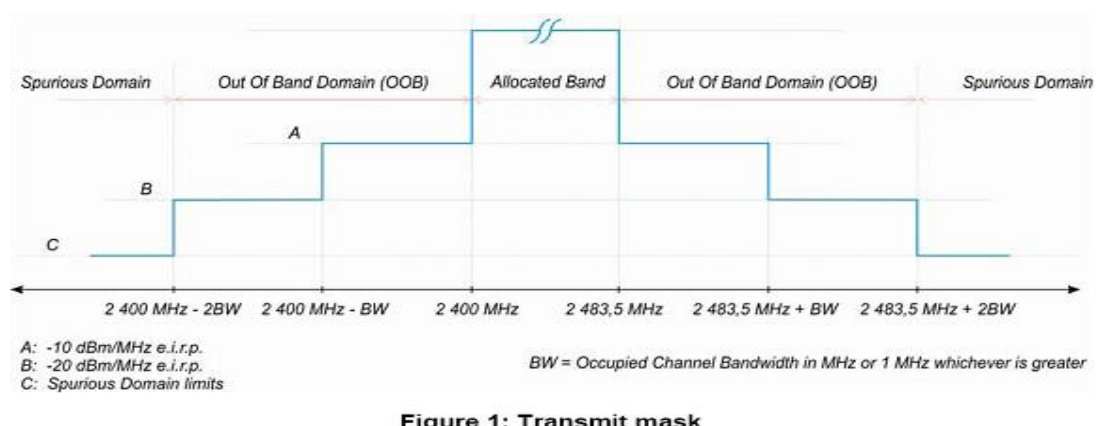

Figure 1: Transmit mask

7.2 TEST PROCEDURES

1. Please refer to ETSI EN 300 328 (V2.2.2) clause 5.4.8.1 for the test conditions.
 2. Please refer to ETSI EN 300 328 (V2.2.2) clause 5.4.8.2 for the measurement method.
- For systems using FHSS modulation, the measurements shall be performed during normal operation (hopping).

Connect the UUT to the spectrum analyser and use the following settings:

- Centre Frequency: 2484 MHz
- Span: 0 Hz
- Resolution BW: 1 MHz
- Filter mode: Channel filter
- Video BW: 3 MHz
- Detector Mode: RMS
- Trace Mode: Max Hold
- Sweep Mode: Continuous
- Sweep Points: Sweep Time [s] / (1 μ s) or 5 000 whichever is greater
- Trigger Mode: Video trigger; in case video triggering is not possible, an external trigger source maybe used
- Sweep Time: > 120 % of the duration of the longest burst detected during the measurement of the RF Output Power



7.3 TEST SETUP



7.4 TEST RESULT

For the measurement records, refer to the appendix I.



8. SPURIOUS EMISSIONS – TRANSMITTER

8.1 LIMIT

Frequency range	Maximum power, e.r.p(≤1 GHz) e.i.r.p(> 1 GHz)	Bandwidth
30 MHz to 47 MHz	-36 dBm	100 KHz
47 MHz to 74 MHz	-54 dBm	100 KHz
74 MHz to 87.5 MHz	-36 dBm	100 KHz
87.5 MHz to 118 MHz	-54 dBm	100 KHz
118 MHz to 174 MHz	-36 dBm	100 KHz
174 MHz to 230 MHz	-54 dBm	100 KHz
230 MHz to 470 MHz	-36 dBm	100 KHz
470 MHz to 694 MHz	-54 dBm	100 KHz
694 MHz to 1 GHz	-36 dBm	100 KHz
1 GHz to 12.75 GHz	-30 dBm	1 MHz

8.2 TEST PROCEDURES

1. Please refer to ETSI EN 300 328 (V2.2.2) clause 5.4.9.1 for the test conditions.
2. Please refer to ETSI EN 300 328 (V2.2.2) clause 5.4.9.2 for the measurement method.

Spectrum analyser settings:

Spectrum Analyzer	Setting	
Frequency Start to Stop	30 MHz to 1000 MHz	1000 MHz to 12750MHz
Resolution Bandwidth	100 kHz	1 MHz
Video Bandwidth	300 kHz	3 MHz
Filter Type	3 dB (Gaussian)	
Detector Mode	Peak	
Trace Mode	Max Hold	
Sweep Points	≥ 19 400 (Set as 20000)	≥ 23 500 (Set as 24000)
Sweep Time	For non continuous transmissions (duty cycle less than 100 %), the sweep time shall be sufficiently long, Below 1GHz such that for each 100 kHz frequency step, Above 1GHz such that for each 1MHz frequency step, the measurement time is greater than two transmissions of the UUT, on any channel.	



- a. The EUT was placed on the top of the turntable (1.5m) in Semi Anechoic Room.
- b. The test shall be made in the transmitting mode. The turntable was rotated by 360 degrees to determine the position of the highest radiation.
- c. This measurement shall be repeated with the transmitter in standby mode where applicable.
- d. For 30~12750MHz spurious emissions measurement, the receiving antenna was placed 3 meters far away from the EUT.
- e. The antenna shall vary between 1 m to 4 m to find each suspected emissions of both horizontal and vertical polarization. Each recorded suspected value is indicated as Read Level.
- f. Replace the EUT by standard antenna and feed the RF port by signal generator.
- g. Adjust the frequency of the signal generator to the suspected emission and slightly rotate the turntable to locate the position with maximum reading.
- h. Adjust the power level of the signal generator to reach the same reading with Read Level.
- i. The level of the spurious emission is the power level of generator plus the gain of the standard antenna in dBi and minus the loss of the cable used between the signal generator and the standard antenna.
- j. Any emissions identified during the sweeps above that fall within the 6 dB range below the applicable limit or above, shall be individually measured using the procedure in ETSI EN 300 328 (V2.2.2) clause 5.4.9.2.1.3 and compared to the limits.
- k. The measurement shall be repeated at the lowest and the highest channel of the stated frequency range.
- l. EUT Orthogonal Axis:
"X" - denotes Laid on Table; "Y" - denotes Vertical Stand; "Z" - denotes Side Stand.

8.3 TEST SETUP

(A) Radiated Emission Test Set-Up, Frequency Below 1000MHz.

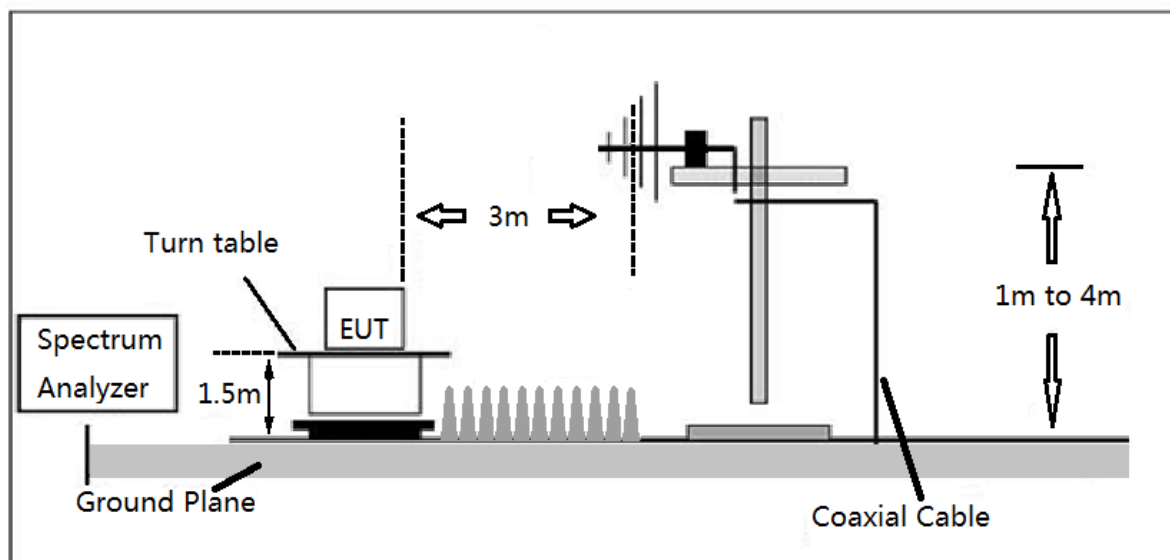



(B) Radiated Emission Test Set-Up Frequency Above 1GHz.

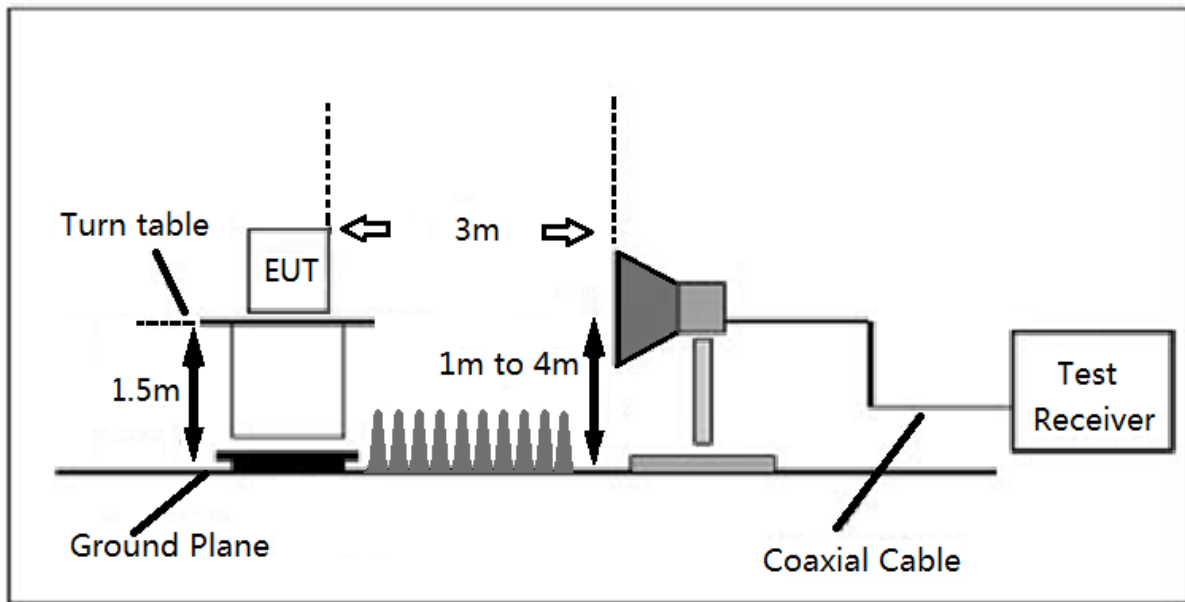

8.4 EUT OPERATION DURING TEST

1. The EUT was programmed to be in continuous transmitting mode.
2. For the initial investigation on the highest, lowest frequency, no significant differences in spurious emissions were observed between these 2 channels. The worst test data was shown.
3. There is a filter used during the test, the fundamental signals will be not shown in the plot.
4. The EUT is connected with the GSM base station when the BT is transmitting.



8.5 TEST RESULT

Remark: The all data rate modes had been test, but only worse test data was recorded in the test report.

Project: LGT23D025	Test Engineer: Dylan.shi
EUT: Bluetooth Headphones	Temperature: 25.4°C
M/N: HS-BN928	Humidity: 61%RH
Test Voltage: Battery	Test Data: 2023-04-14
Test Mode: DH5 2402	
Note:	

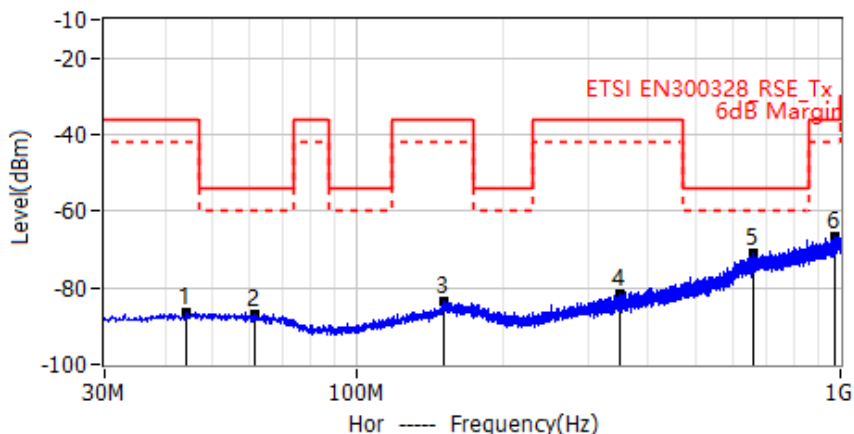

No.	Frequency	Level dBm	Limit dBm	Margin dB	Detector	Polar
1*	44.3075MHz	-86.46	-36.00	-50.46	RMS	Hor
2*	61.5250MHz	-86.98	-54.00	-32.98	RMS	Hor
3*	150.5225MHz	-83.62	-36.00	-47.62	RMS	Hor
4*	349.3725MHz	-81.66	-36.00	-45.66	RMS	Hor
5*	658.8025MHz	-70.82	-54.00	-16.82	RMS	Hor
6*	971.6275MHz	-66.79	-36.00	-30.79	RMS	Hor

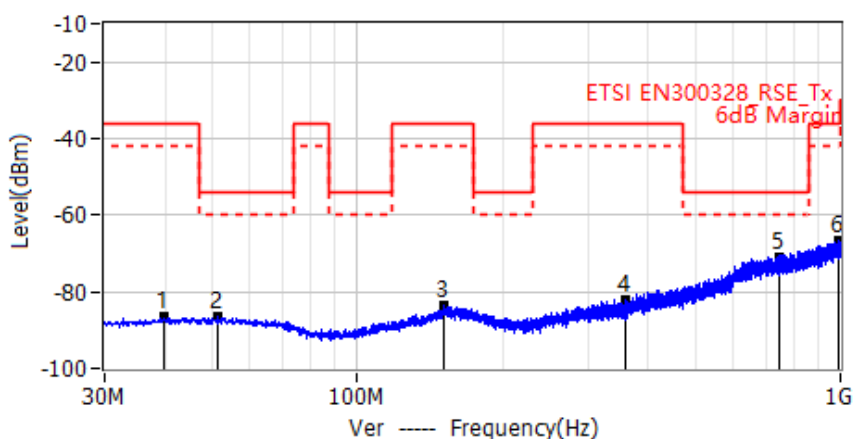

No.	Frequency	Level dBm	Limit dBm	Margin dB	Detector	Polar
1*	39.9425MHz	-86.69	-36.00	-50.69	RMS	Ver
2*	51.4613MHz	-86.57	-54.00	-32.57	RMS	Ver
3*	151.0075MHz	-83.54	-36.00	-47.54	RMS	Ver
4*	359.6788MHz	-82.01	-36.00	-46.01	RMS	Ver
5*	743.9200MHz	-70.81	-54.00	-16.81	RMS	Ver
6*	987.1475MHz	-66.50	-36.00	-30.50	RMS	Ver



Project: LGT23D025	Test Engineer: Dylan.shi
EUT: Bluetooth Headphones	Temperature: 25.4°C
M/N: HS-BN928	Humidity: 61%RH
Test Voltage: Battery	Test Data: 2023-04-14
Test Mode: DH5 2480	
Note:	

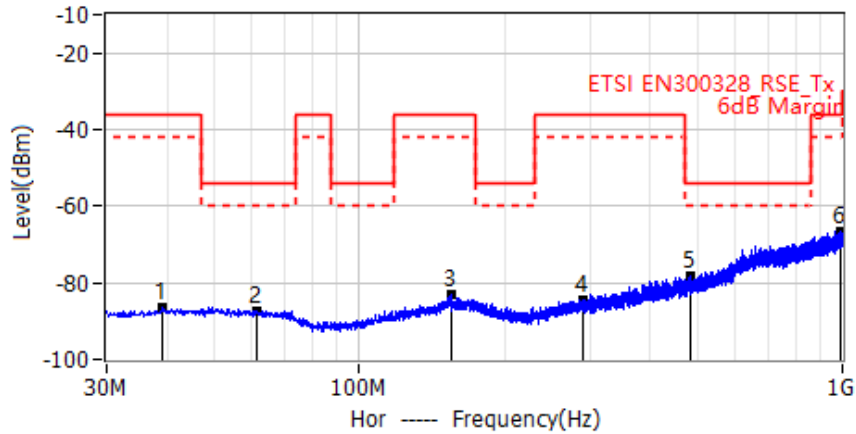

No.	Frequency	Level dBm	Limit dBm	Margin dB	Detector	Polar
1*	38.9725MHz	-86.36	-36.00	-50.36	RMS	Hor
2*	61.5250MHz	-87.45	-54.00	-33.45	RMS	Hor
3*	154.8875MHz	-83.00	-36.00	-47.00	RMS	Hor
4*	289.3538MHz	-84.40	-36.00	-48.40	RMS	Hor
5*	484.6875MHz	-78.43	-54.00	-24.43	RMS	Hor
6*	989.4513MHz	-66.50	-36.00	-30.50	RMS	Hor

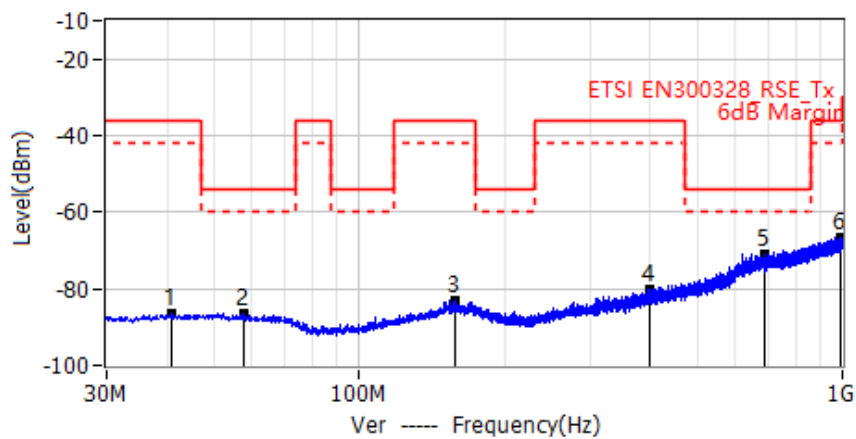

No.	Frequency	Level dBm	Limit dBm	Margin dB	Detector	Polar
1*	41.0338MHz	-86.64	-36.00	-50.64	RMS	Ver
2*	57.5238MHz	-86.66	-54.00	-32.66	RMS	Ver
3*	157.7975MHz	-83.01	-36.00	-47.01	RMS	Ver
4*	400.1763MHz	-80.14	-36.00	-44.14	RMS	Ver
5*	687.5388MHz	-71.11	-54.00	-17.11	RMS	Ver
6*	992.8463MHz	-66.38	-36.00	-30.38	RMS	Ver



Project: LGT23D025	Test Engineer: Dylan.shi
EUT: Bluetooth Headphones	Temperature: 25.3°C
M/N: HS-BN928	Humidity: 55%RH
Test Voltage: Battery	Test Data: 2023-04-17
Test Mode: DH5 2402	
Note:	

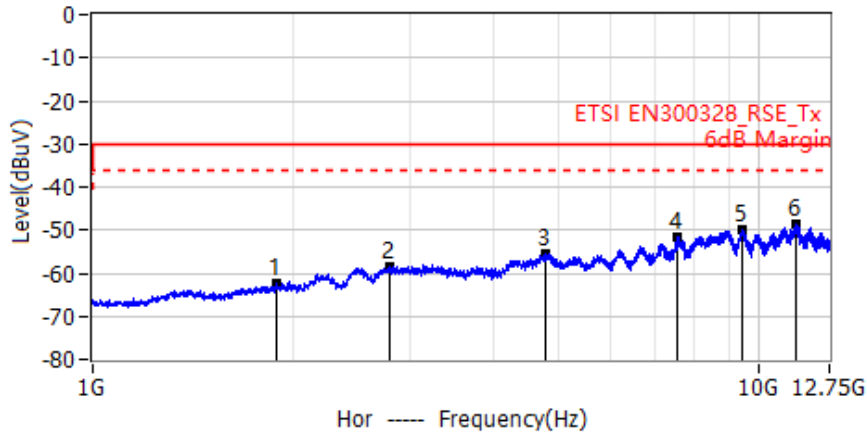

No.	Frequency	Level dBuV	Limit dBuV	Margin dB	Detector	Polar
1*	1.8871GHz	-62.48	-30.00	-32.48	RMS	Hor
2*	2.7875GHz	-58.65	-30.00	-28.65	RMS	Hor
3*	4.7835GHz	-55.69	-30.00	-25.69	RMS	Hor
4*	7.5506GHz	-51.74	-30.00	-21.74	RMS	Hor
5*	9.4086GHz	-49.83	-30.00	-19.83	RMS	Hor
6*	11.3899GHz	-48.62	-30.00	-18.62	RMS	Hor

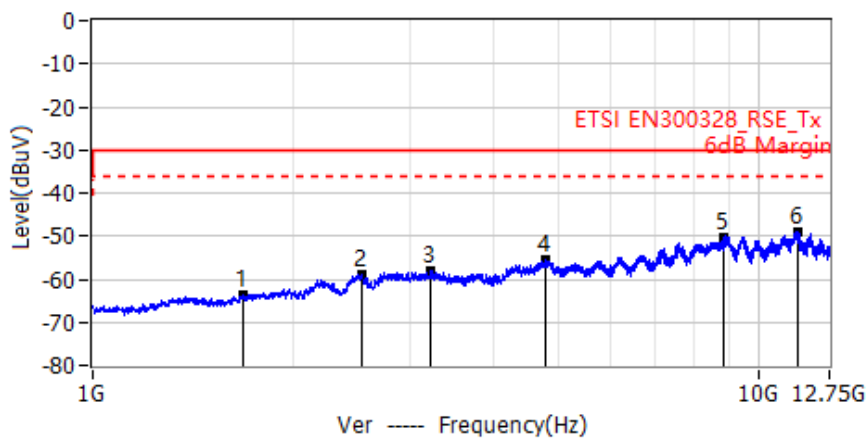

No.	Frequency	Level dBuV	Limit dBuV	Margin dB	Detector	Polar
1*	1.6771GHz	-63.52	-30.00	-33.52	RMS	Ver
2*	2.5304GHz	-58.72	-30.00	-28.72	RMS	Ver
3*	3.2222GHz	-58.11	-30.00	-28.11	RMS	Ver
4*	4.7806GHz	-55.36	-30.00	-25.36	RMS	Ver
5*	8.8681GHz	-50.40	-30.00	-20.40	RMS	Ver
6*	11.4002GHz	-48.92	-30.00	-18.92	RMS	Ver



Project: LGT23D025	Test Engineer: Dylan.shi
EUT: Bluetooth Headphones	Temperature: 25.3°C
M/N: HS-BN928	Humidity: 55%RH
Test Voltage: Battery	Test Data: 2023-04-17
Test Mode: DH5 2480	
Note:	

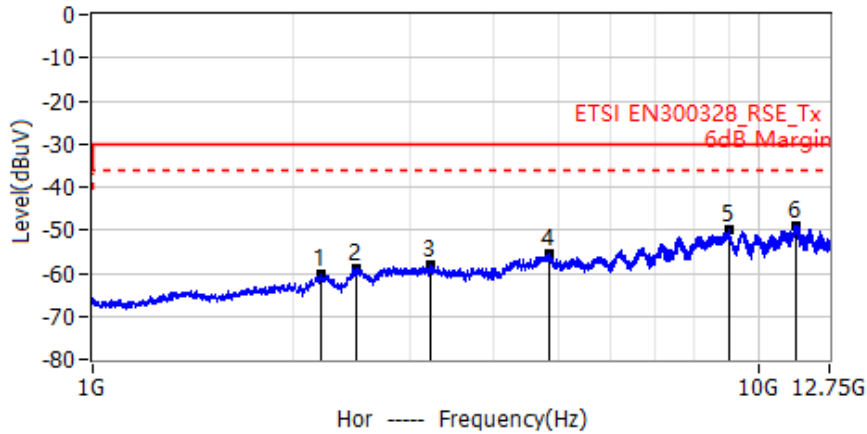

No.	Frequency	Level dBuV	Limit dBuV	Margin dB	Detector	Polar
1*	2.2058GHz	-60.08	-30.00	-30.08	RMS	Hor
2*	2.4922GHz	-58.74	-30.00	-28.74	RMS	Hor
3*	3.2178GHz	-58.11	-30.00	-28.11	RMS	Hor
4*	4.8320GHz	-55.51	-30.00	-25.51	RMS	Hor
5*	9.0091GHz	-49.94	-30.00	-19.94	RMS	Hor
6*	11.3943GHz	-48.83	-30.00	-18.83	RMS	Hor

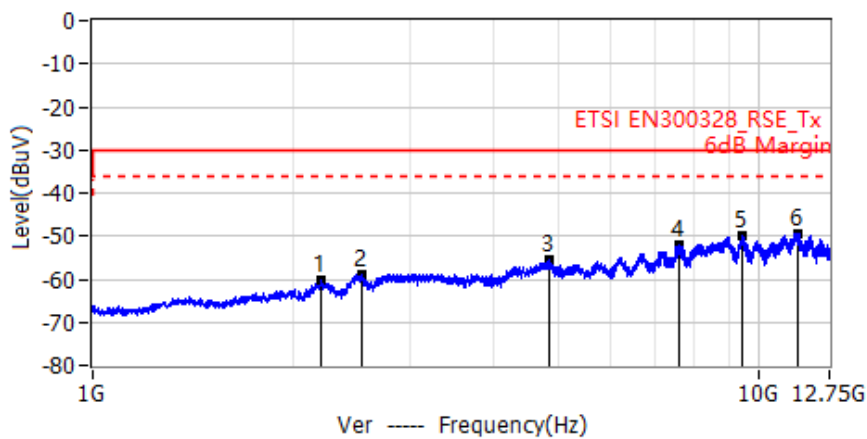

No.	Frequency	Level dBuV	Limit dBuV	Margin dB	Detector	Polar
1*	2.2029GHz	-60.26	-30.00	-30.26	RMS	Ver
2*	2.5378GHz	-58.78	-30.00	-28.78	RMS	Ver
3*	4.8467GHz	-55.66	-30.00	-25.66	RMS	Ver
4*	7.5947GHz	-52.10	-30.00	-22.10	RMS	Ver
5*	9.4159GHz	-50.03	-30.00	-20.03	RMS	Ver
6*	11.4017GHz	-49.40	-30.00	-19.40	RMS	Ver



9. SPURIOUS EMISSIONS – RECEIVER

9.1 LIMIT

Clause	Test Item	Frequency(MHz)	Limit
4.3.1.11.3	Spurious emissions (radiated)	30-1000	-57dBm
		1000-12750	-47dBm

9.2 TEST PROCEDURES

1. Please refer to ETSI EN 300 328 (V2.2.2) clause 5.4.10.1 for the test conditions.
2. Please refer to ETSI EN 300 328 (V2.2.2) clause 5.4.10.2 for the measurement method.

Spectrum analyser settings:

Spectrum Analyzer	Setting	
Frequency Start to Stop	30 MHz to 1000 MHz	1000 MHz to 12750MHz
Resolution Bandwidth	100 kHz	1 MHz
Video Bandwidth	300 kHz	3 MHz
Filter Type	3 dB (Gaussian)	
Detector Mode	Peak	
Trace Mode	Max Hold	
Sweep Points	≥ 19 400 (Set as 20000)	≥ 23 500 (Set as 24000)
Sweep Time	For non continuous transmissions (duty cycle less than 100 %), the sweep time shall be sufficiently long, Below 1GHz such that for each 100 kHz frequency step, Above 1GHz such that for each 1MHz frequency step, the measurement time is greater than two transmissions of the UUT, on any channel.	

- a. The EUT was placed on the top of the turntable (1.5m) in Semi Anechoic Room.
- b. The test shall be made in the transmitting mode. The turntable was rotated by 360 degrees to determine the position of the highest radiation.
- c. This measurement shall be repeated with the transmitter in standby mode where applicable.
- d. For 30~12750MHz spurious emissions measurement, the receiving antenna was placed 3 meters far away from the EUT.
- e. The antenna shall vary between 1 m to 4 m to find each suspected emissions of both horizontal and vertical polarization. Each recorded suspected value is indicated as Read Level.
- f. Replace the EUT by standard antenna and feed the RF port by signal generator.
- g. Adjust the frequency of the signal generator to the suspected emission and slightly rotate the turntable to locate the position with maximum reading.
- h. Adjust the power level of the signal generator to reach the same reading with Read Level.
- i. The level of the spurious emission is the power level of generator plus the gain of the standard antenna in dBi and minus the loss of the cable used between the signal generator and the standard antenna.



- j. Any emissions identified during the sweeps above that fall within the 6 dB range below the applicable limit or above, shall be individually measured using the procedure in ETSI EN 300 328 (V2.2.2) clause 5.4.9.2.1.3 and compared to the limits.
- k. The measurement shall be repeated at the lowest and the highest channel of the stated frequency range.
- l. EUT Orthogonal Axis:
 - “X” - denotes Laid on Table; “Y” - denotes Vertical Stand; “Z” - denotes Side Stand.

9.3 EUT OPERATION DURING TEST

The EUT was programmed to be in continuously receiving mode.

9.4 TEST SETUP

(A) Radiated Emission Test Set-Up, Frequency Below 1000MHz.

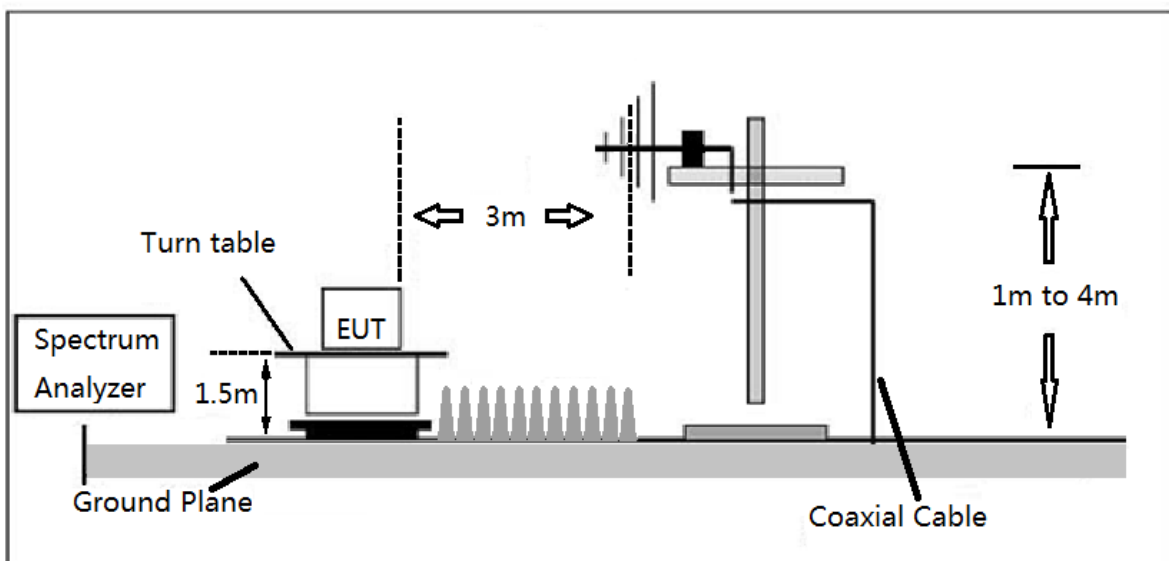

(B) Radiated Emission Test Set-Up Frequency Above 1GHz.

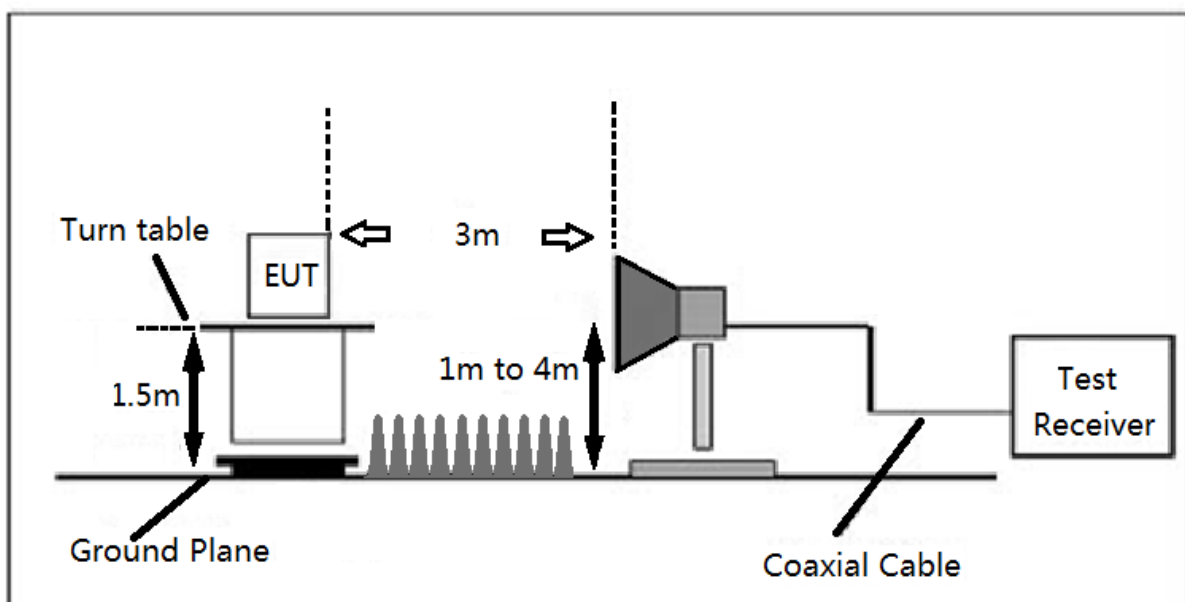



9.5 TEST RESULT

Remark: 1. The all data rate modes had been test, but only worse test data was recorded in the test report.

2. The emissions above 6GHz and below 12.75GHz are too small to be measured and are at least 10 dB below the limit. The signal is mainly from the environmental noise.

Project: LGT23D025	Test Engineer: Dylan.shi
EUT: Bluetooth Headphones	Temperature: 25.4°C
M/N: HS-BN928	Humidity: 61%RH
Test Voltage: Battery	Test Data: 2023-04-14
Test Mode: DH5 2402	
Note:	

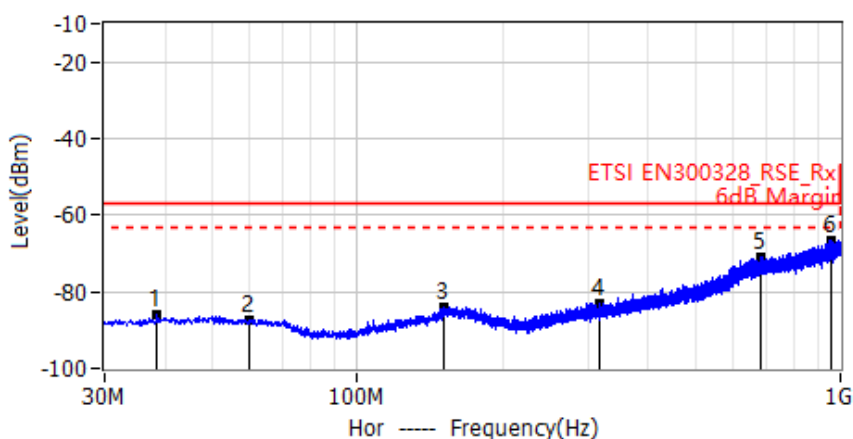

No.	Frequency	Level dBm	Limit dBm	Margin dB	Detector	Polar
1*	38.4875MHz	-85.93	-57.00	-28.93	RMS	Hor
2*	59.8275MHz	-87.26	-57.00	-30.26	RMS	Hor
3*	151.4925MHz	-83.98	-57.00	-26.98	RMS	Hor
4*	316.1500MHz	-83.23	-57.00	-26.23	RMS	Hor
5*	686.0838MHz	-70.75	-57.00	-13.75	RMS	Hor
6*	953.6825MHz	-66.62	-57.00	-9.62	RMS	Hor

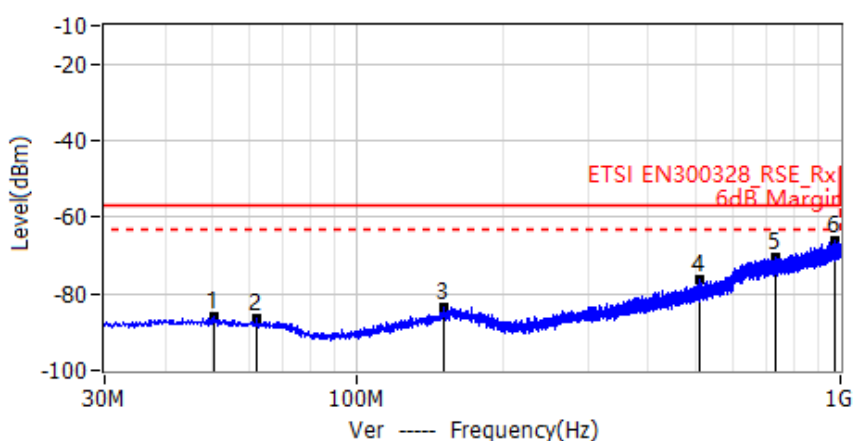

No.	Frequency	Level dBm	Limit dBm	Margin dB	Detector	Polar
1*	50.7338MHz	-86.17	-57.00	-29.17	RMS	Ver
2*	62.0100MHz	-86.49	-57.00	-29.49	RMS	Ver
3*	150.4013MHz	-83.36	-57.00	-26.36	RMS	Ver
4*	513.0600MHz	-76.22	-57.00	-19.22	RMS	Ver
5*	734.2200MHz	-70.53	-57.00	-13.53	RMS	Ver
6*	970.4150MHz	-66.05	-57.00	-9.05	RMS	Ver



Project: LGT23D025	Test Engineer: Dylan.shi
EUT: Bluetooth Headphones	Temperature: 25.3°C
M/N: HS-BN928	Humidity: 55%RH
Test Voltage: Battery	Test Data: 2023-04-17
Test Mode: DH5 2402	
Note:	

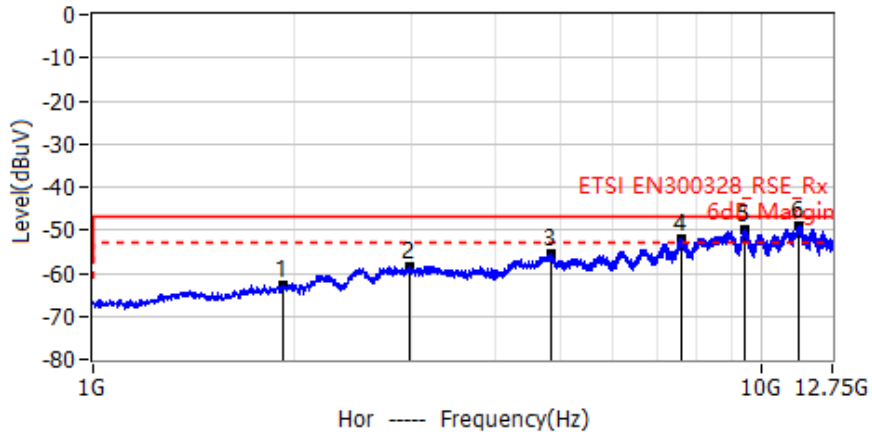

No.	Frequency	Level dBuV	Limit dBuV	Margin dB	Detector	Polar
1*	1.9268GHz	-62.65	-47.00	-15.65	RMS	Hor
2*	2.9696GHz	-58.63	-47.00	-11.63	RMS	Hor
3*	4.8467GHz	-55.69	-47.00	-8.69	RMS	Hor
4*	7.5962GHz	-51.90	-47.00	-4.90	RMS	Hor
5*	9.4262GHz	-49.88	-47.00	-2.88	RMS	Hor
6*	11.3958GHz	-48.93	-47.00	-1.93	RMS	Hor

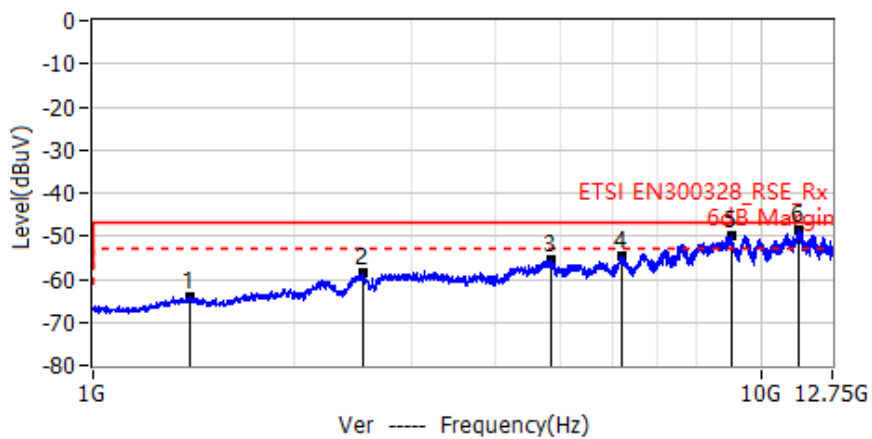

No.	Frequency	Level dBuV	Limit dBuV	Margin dB	Detector	Polar
1*	1.3966GHz	-64.02	-47.00	-17.02	RMS	Ver
2*	2.5290GHz	-58.43	-47.00	-11.43	RMS	Ver
3*	4.8437GHz	-55.61	-47.00	-8.61	RMS	Ver
4*	6.1964GHz	-54.73	-47.00	-7.73	RMS	Ver
5*	8.9929GHz	-49.75	-47.00	-2.75	RMS	Ver
6*	11.3914GHz	-48.72	-47.00	-1.72	RMS	Ver



10. RECEIVER BLOCKING

10.1 LIMIT

While maintaining the minimum performance criteria as defined in clause 4.3.1.12.3, the blocking levels at specified frequency offsets shall be equal to or greater than the limits defined for the applicable receiver category provided in below.

Receiver Category 1

Receiver Blocking parameters for Receiver Category 1 equipment

Wanted signal mean power from companion device (dBm) (see notes 1 and 4)	Blocking signal frequency (MHz)	Blocking signal power (dBm) (see note 4)	Type of blocking signal
$(-133 \text{ dBm} + 10 \times \log_{10}(\text{OCBW}))$ or -68 dBm whichever is less (see note 2)	2 380 2 504	-34	CW
$(-139 \text{ dBm} + 10 \times \log_{10}(\text{OCBW}))$ or -74 dBm whichever is less (see note 3)	2 300 2 330 2 360 2 524 2 584 2 674		

NOTE 1: OCBW is in Hz.

NOTE 2: In case of radiated measurements using a companion device and the level of the wanted signal from the companion device cannot be determined, a relative test may be performed using a wanted signal up to $P_{\text{min}} + 26 \text{ dB}$ where P_{min} is the minimum level of wanted signal required to meet the minimum performance criteria as defined in clause 4.3.1.12.3 in the absence of any blocking signal.

NOTE 3: In case of radiated measurements using a companion device and the level of the wanted signal from the companion device cannot be determined, a relative test may be performed using a wanted signal up to $P_{\text{min}} + 20 \text{ dB}$ where P_{min} is the minimum level of wanted signal required to meet the minimum performance criteria as defined in clause 4.3.1.12.3 in the absence of any blocking signal.

NOTE 4: The level specified is the level at the UUT receiver input assuming a 0 dBi antenna assembly gain. In case of conducted measurements, this level has to be corrected for the (in-band) antenna assembly gain (G). In case of radiated measurements, this level is equivalent to a power flux density (PFD) in front of the UUT antenna with the UUT being configured/positioned as recorded in clause 5.4.3.2.2.



Receiver Category 2

Receiver Blocking parameters receiver Category 2 equipment

Wanted signal mean power from companion device (dBm) (see notes 1 and 3)	Blocking signal frequency (MHz)	Blocking signal power (dBm) (see note 3)	Type of blocking signal
$(-139 \text{ dBm} + 10 \times \log_{10}(\text{OCBW}) + 10 \text{ dB})$ or $(-74 \text{ dBm} + 10 \text{ dB})$ whichever is less (see note 2)	2 380 2 504 2 300 2 584	-34	CW

NOTE 1: OCBW is in Hz.

NOTE 2: In case of radiated measurements using a companion device and the level of the wanted signal from the companion device cannot be determined, a relative test may be performed using a wanted signal up to $P_{\text{min}} + 26 \text{ dB}$ where P_{min} is the minimum level of wanted signal required to meet the minimum performance criteria as defined in clause 4.3.1.12.3 in the absence of any blocking signal.

NOTE 3: The level specified is the level at the UUT receiver input assuming a 0 dBi antenna assembly gain. In case of conducted measurements, this level has to be corrected for the (in-band) antenna assembly gain (G). In case of radiated measurements, this level is equivalent to a power flux density (PFD) in front of the UUT antenna with the UUT being configured/positioned as recorded in clause 5.4.3.2.2.

Receiver Category 3

Receiver Blocking parameters receiver Category 3 equipment

Wanted signal mean power from companion device (dBm) (see notes 1 and 3)	Blocking signal frequency (MHz)	Blocking signal power (dBm) (see note 3)	Type of blocking Signal
$(-139 \text{ dBm} + 10 \times \log_{10}(\text{OCBW}) + 20 \text{ dB})$ or $(-74 \text{ dBm} + 20 \text{ dB})$ whichever is less (see note 2)	2 380 2 504 2 300 2 584	-34	CW

NOTE 1: OCBW is in Hz.

NOTE 2: In case of radiated measurements using a companion device and the level of the wanted signal from the companion device cannot be determined, a relative the test may be performed using a wanted signal up to $P_{\text{min}} + 30 \text{ dB}$ where P_{min} is the minimum level of wanted signal required to meet the minimum performance criteria as defined in clause 4.3.1.12.3 in the absence of any blocking signal.

NOTE 3: The level specified is the level at the UUT receiver input assuming a 0 dBi antenna assembly gain. In case of conducted measurements, this level has to be corrected for the (in-band) antenna assembly gain (G). In case of radiated measurements, this level is equivalent to a power flux density (PFD) in front of the UUT antenna with the UUT being configured/positioned as recorded in clause 5.4.3.2.2.

10.2 TEST PROCEDURES

1. Please refer to ETSI EN 300 328 (V2.2.2) clause 5.4.11.1 for the test conditions.
2. Please refer to ETSI EN 300 328 (V2.2.2) clause 5.4.11.2 for the measurement method.



10.3 TEST SETUP

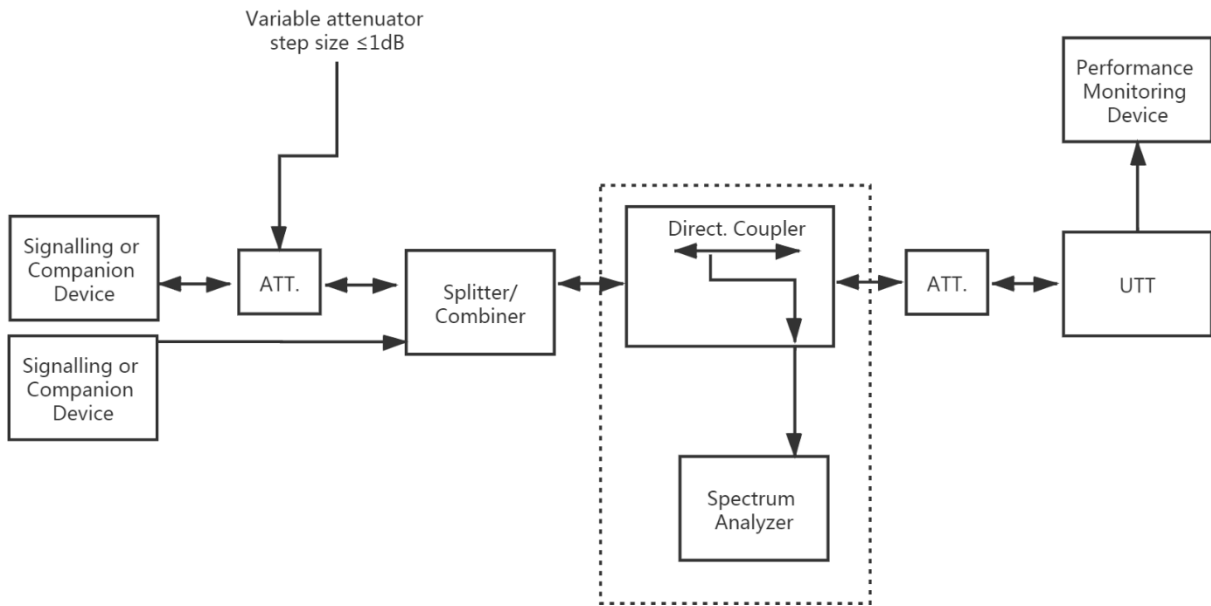



10.4 TEST RESULT

GFSK Hopping Worst

Wanted signal meanpower from companion device (dBm)	Blocking signal frequency (MHz)	Blocking signal power(dBm) CW	PER	Limit	Results
-66.10	2300	-34	0.40%	≤10%	PASS
	2380		0.38%		
	2504		0.68%		
	2584		0.51%		

NOTE 1: In case of radiated measurements using a companion device and the level of the wanted signal from the companion device cannot be determined, a relative test may be performed using a wanted signal up to $P_{min} + 26$ dB where P_{min} is the minimum level of wanted signal required to meet the minimum performance criteria as defined in clause 4.3.1.12.3 in the absence of any blocking signal.

NOTE 2: The level specified is the level at the UUT receiver input assuming a 0 dBi antenna assembly gain. In case of conducted measurements, this level has to be corrected for the (in-band) antenna assembly gain (G). In case of radiated measurements, this level is equivalent to a power flux density (PFD) in front of the UUT antenna with the UUT being configured/positioned as recorded in clause 5.4.3.2.2.



π/4-DQPSK Hopping Worst

Wanted signal meanpower from companion device (dBm)	Blocking signal frequency (MHz)	Blocking signal power(dBm) CW	PER	Limit	Results
-64.57	2300	-34	0.82%	≤10%	PASS
	2380		0.92%		
	2504		0.01%		
	2584		0.25%		

NOTE 1: In case of radiated measurements using a companion device and the level of the wanted signal from the companion device cannot be determined, a relative test may be performed using a wanted signal up to $P_{min} + 26$ dB where P_{min} is the minimum level of wanted signal required to meet the minimum performance criteria as defined in clause 4.3.1.12.3 in the absence of any blocking signal.

NOTE 2: The level specified is the level at the UUT receiver input assuming a 0 dBi antenna assembly gain. In case of conducted measurements, this level has to be corrected for the (in-band) antenna assembly gain (G). In case of radiated measurements, this level is equivalent to a power flux density (PFD) in front of the UUT antenna with the UUT being configured/positioned as recorded in clause 5.4.3.2.2.



8DPSK Hopping Worst

Wanted signal meanpower from companion device (dBm)	Blocking signal frequency (MHz)	Blocking signal power(dBm) CW	PER	Limit	Results
-64.60	2300	-34	0.83%	≤ 10%	PASS
	2380		0.66%		
	2504		0.28%		
	2584		0.46%		

NOTE 1: In case of radiated measurements using a companion device and the level of the wanted signal from the companion device cannot be determined, a relative test may be performed using a wanted signal up to $P_{min} + 26$ dB where P_{min} is the minimum level of wanted signal required to meet the minimum performance criteria as defined in clause 4.3.1.12.3 in the absence of any blocking signal.

NOTE 2: The level specified is the level at the UUT receiver input assuming a 0 dBi antenna assembly gain. In case of conducted measurements, this level has to be corrected for the (in-band) antenna assembly gain (G). In case of radiated measurements, this level is equivalent to a power flux density (PFD) in front of the UUT antenna with the UUT being configured/positioned as recorded in clause 5.4.3.2.2.



11. ADAPTIVE (CHANNEL ACCESS MECHANISM)

11.1 LIMIT

The frequency range of the equipment is determined by the lowest and highest

Adaptive Frequency Hopping using LBT based DAA:

1. $COT \leq 60$ ms;
2. Idle Period = 5% of COT;
3. Detection threshold level = $-70 \text{ dBm/MHz} + (20 \text{ dBm} - P_{out \text{ e.i.r.p.}})/1 \text{ MHz}$ (P_{out} in dBm).

Adaptive Frequency Hopping using other forms of DAA (non-LBT based):

1. The frequency shall remain unavailable for a minimum time equal to 1 second or 5 times the actual number of hopping frequencies in the current (adapted) channel map used by the equipment.
2. $COT \leq 40$ ms;
3. Idle Period = 5% of COT;
4. Detection threshold level = $-70 \text{ dBm/MHz} + (20 \text{ dBm} - P_{out \text{ e.i.r.p.}})/1 \text{ MHz}$ (P_{out} in dBm).

Short Control Signalling Transmissions:

Short Control Signalling Transmissions shall have a maximum duty cycle $T_{xOn} / (T_{xOn} + T_{xOff})$ ratio of 10 % within any observation period of 50 ms.

11.2 TEST PROCEDURES

1. Please refer to ETSI EN 300 328 (V2.2.2) clause 5.4.6.1 for the test conditions.
2. Please refer to ETSI EN 300 328 (V2.2.2) clause 5.4.6.2 for the measurement method.
3. The spectrum analyzer sweep was triggered by the start of the interfering signal, with the interfering signal present, a 100 % duty cycle CW signal is inserted as the blocking signal.
 - RBW: \geq Occupied Channel Bandwidth (if the analyser does not support this setting, the highest available setting shall be used)
 - VBW: $3 \times$ RBW (if the analyser does not support this setting, the highest available setting shall be used)
 - Detector Mode: RMS
 - Centre Frequency: Equal to the centre frequency of the operating channel
 - Span: 0 Hz
 - Sweep time: $>$ maximum Channel Occupancy Time
 - Trace Mode: Clear Write
 - Trigger Mode: Video



11.3 TEST SETUP

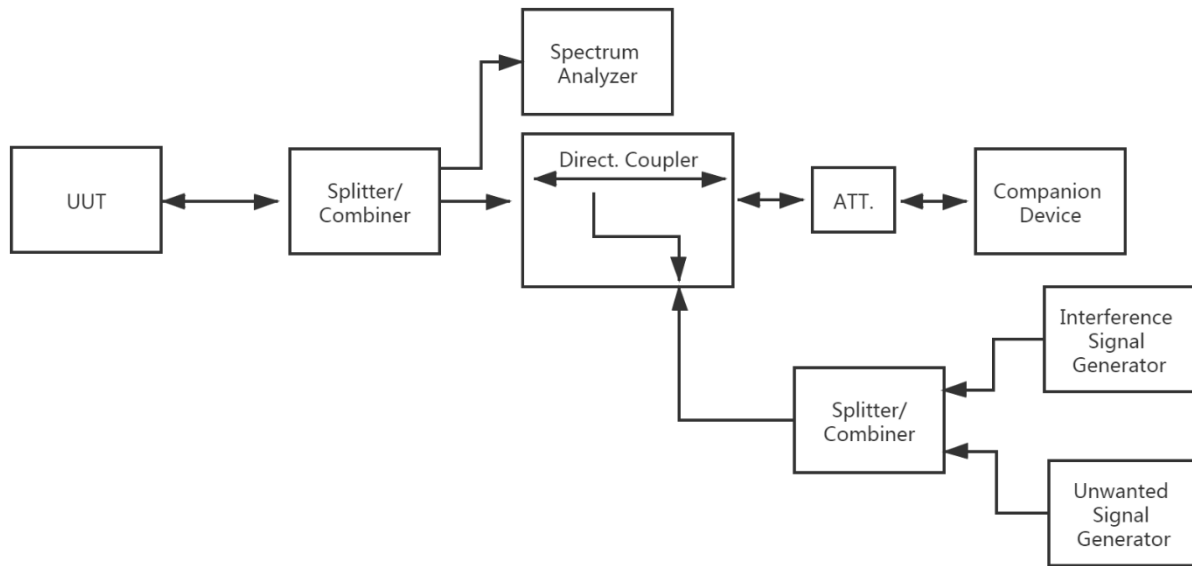

- BT is normal transmission
- Interference shall be injected ->BT shall stop transmission
- Blocking shall be injected ->BT does not resume any normal transmission
- Removing the interference and blocking signal

11.4 TEST RESULTS

Note: The power less than 10dBm, not applicable.



APPENDIX I - TEST RESULTS

Duty Cycle, Tx Sequence, Tx Gap, Medium Utilisation

Condition	Mode	Frequency (MHz)	Antenna	Duty Cycle (%)	Tx-sequence (ms)	Tx Gap (ms)	MU (%)
NVNT	1-DH5	hopping	Ant1	77.56	2.89	0.86	1.8
NVNT	2-DH5	hopping	Ant1	77.17	2.89	0.86	1.83
NVNT	3-DH5	hopping	Ant1	77.6	2.89	0.86	1.81



RF Output Power

Condition	Mode	Frequency (MHz)	Antenna	Max Burst RMS Power (dBm)	Burst Number	Max EIRP (dBm)	Limit (dBm)	Verdict
NVNT	1-DH5	hopping	Ant1	3.65	27	7.10	20	Pass
NVLT	1-DH5	hopping	Ant1	3.33	27	6.78	20	Pass
NVHT	1-DH5	hopping	Ant1	3.48	27	6.93	20	Pass
NVNT	2-DH5	hopping	Ant1	3.76	27	7.21	20	Pass
NVLT	2-DH5	hopping	Ant1	3.30	27	6.75	20	Pass
NVHT	2-DH5	hopping	Ant1	3.74	27	7.19	20	Pass
NVNT	3-DH5	hopping	Ant1	3.68	27	7.13	20	Pass
NVLT	3-DH5	hopping	Ant1	3.59	27	7.04	20	Pass
NVHT	3-DH5	hopping	Ant1	3.56	27	7.01	20	Pass



Test Graphs

Power NVNT 1-DH5 2402MHz Ant1

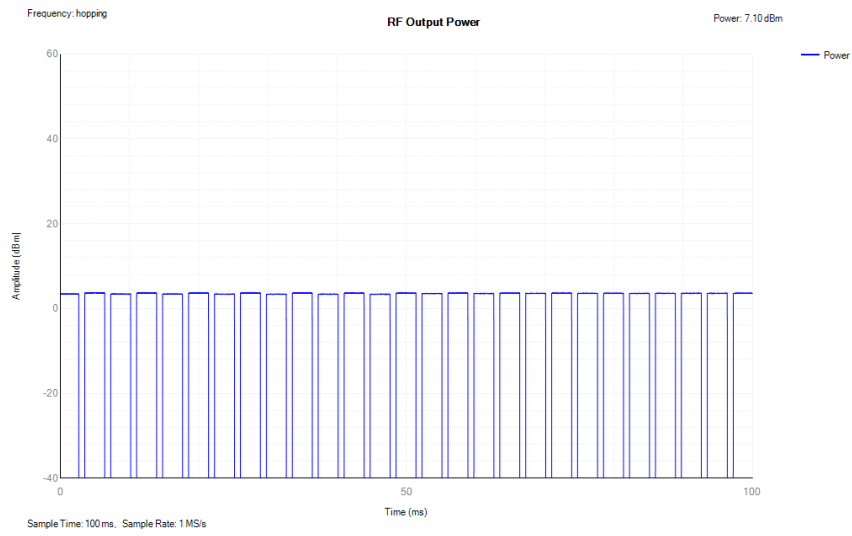

Power NVNT 2-DH5 2402MHz Ant1

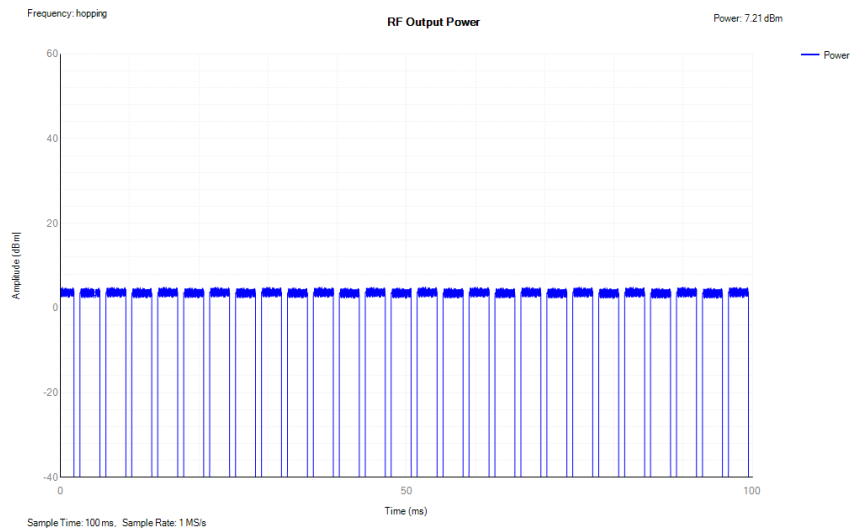

Power NVNT 3-DH5 2402MHz Ant1

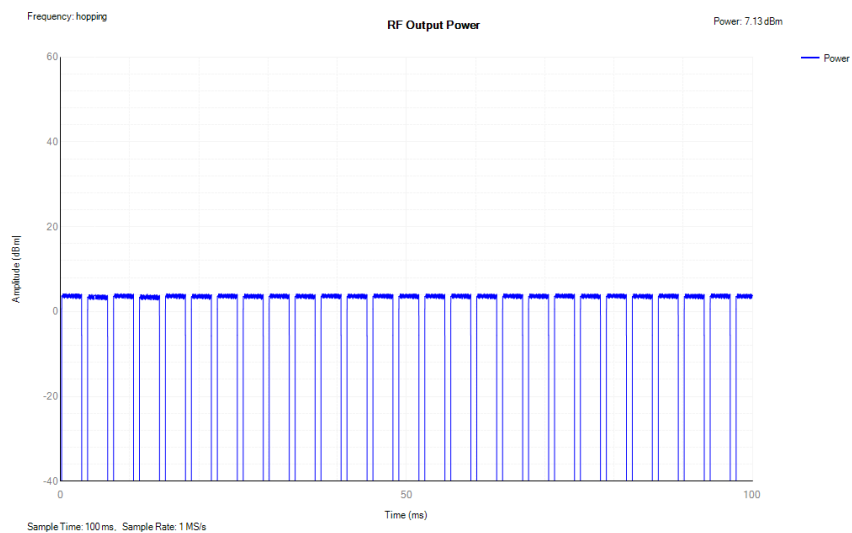



Accumulated Transmit Time

Condition	Mode	Frequency (MHz)	Antenna	Accumulated Transmit Time (ms)	Limit (ms)	Sweep Time (ms)	Burst Number	Verdict
NVNT	1-DH5	2402	Ant1	305.704	400	31600	106	Pass
NVNT	1-DH5	2480	Ant1	306.555	400	31600	107	Pass
NVNT	2-DH5	2402	Ant1	309.337	400	31600	107	Pass
NVNT	2-DH5	2480	Ant1	290.758	400	31600	106	Pass
NVNT	3-DH5	2402	Ant1	309.337	400	31600	107	Pass
NVNT	3-DH5	2480	Ant1	290.44	400	31600	106	Pass

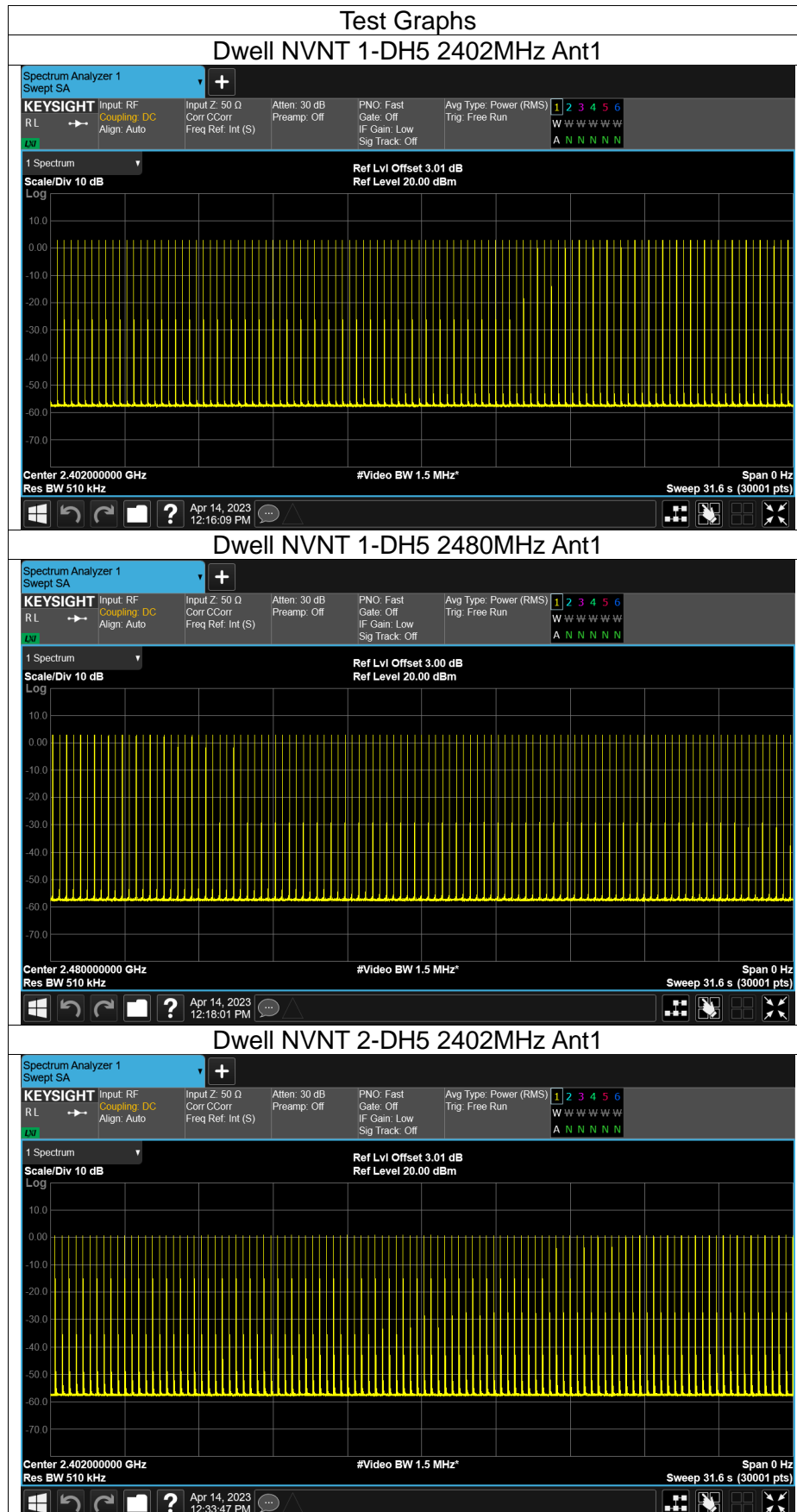

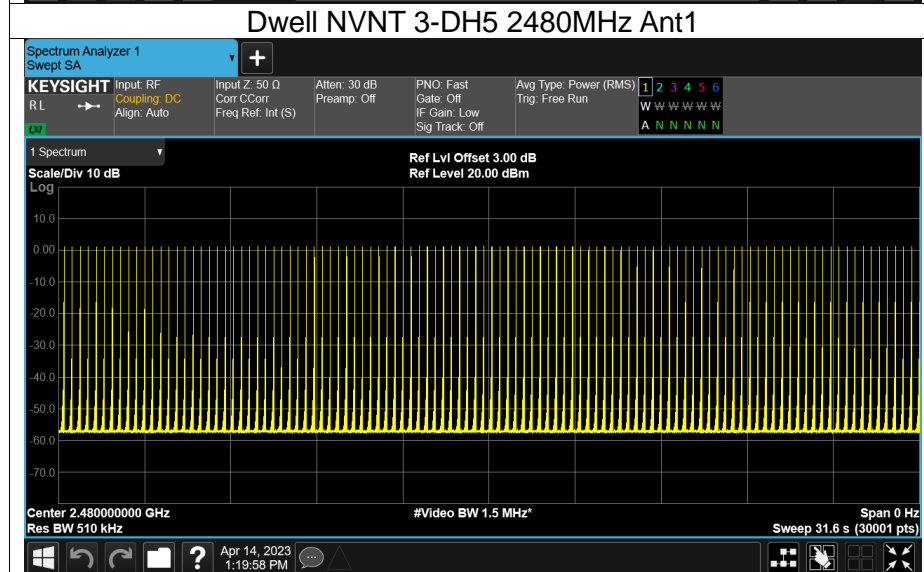
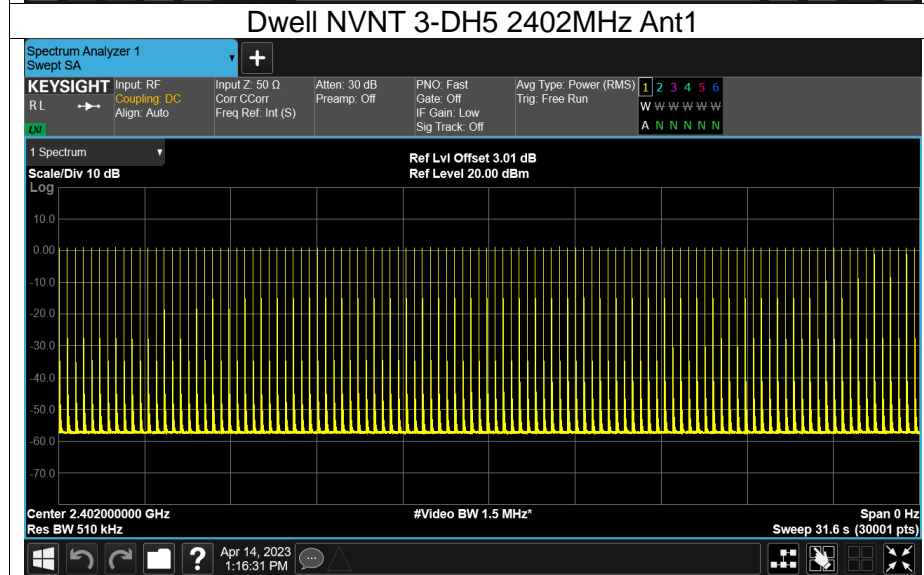
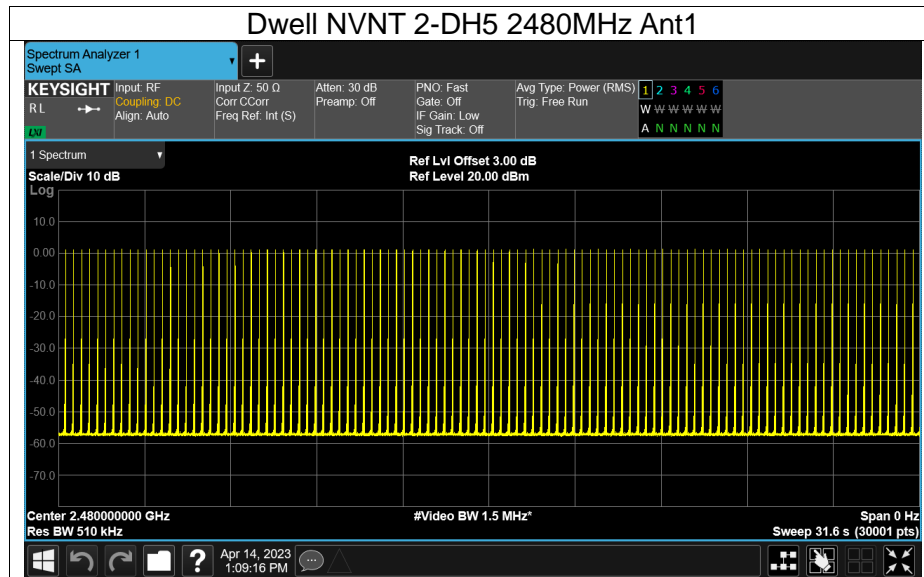



Frequency Occupation

Condition	Mode	Frequency (MHz)	Antenna	Burst Number	Limit	Sweep Time (ms)	Verdict
NVNT	1-DH5	2402	Ant1	3	1	911.344	Pass
NVNT	1-DH5	2480	Ant1	3	1	905.34	Pass
NVNT	2-DH5	2402	Ant1	3	1	913.556	Pass
NVNT	2-DH5	2480	Ant1	3	1	866.788	Pass
NVNT	3-DH5	2402	Ant1	3	1	913.556	Pass
NVNT	3-DH5	2480	Ant1	2	1	865.84	Pass

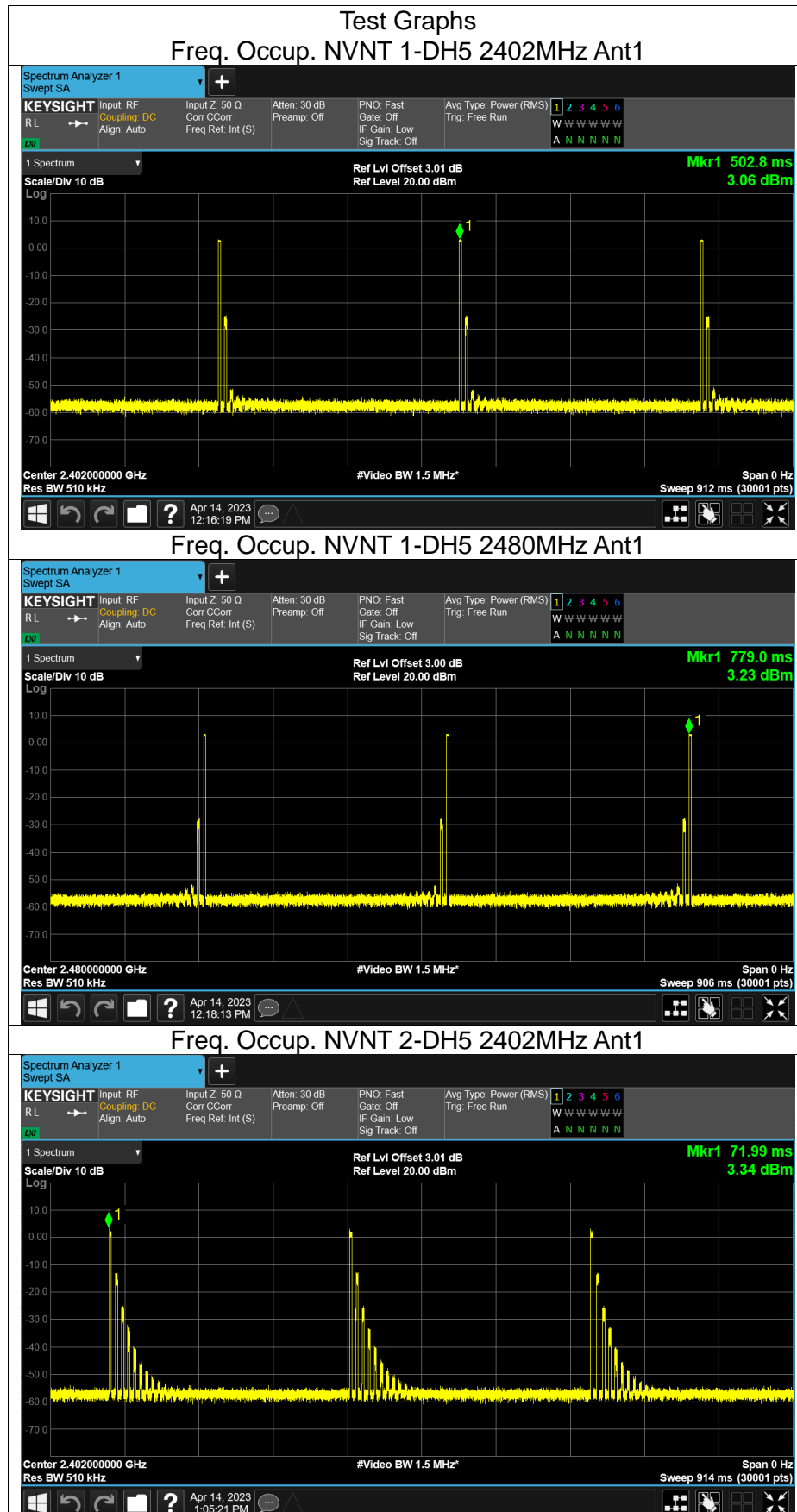

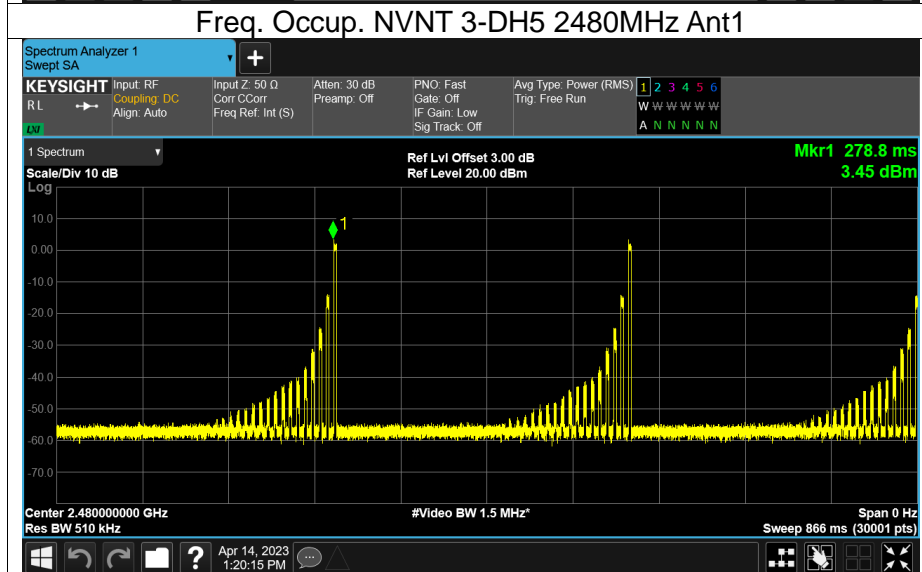
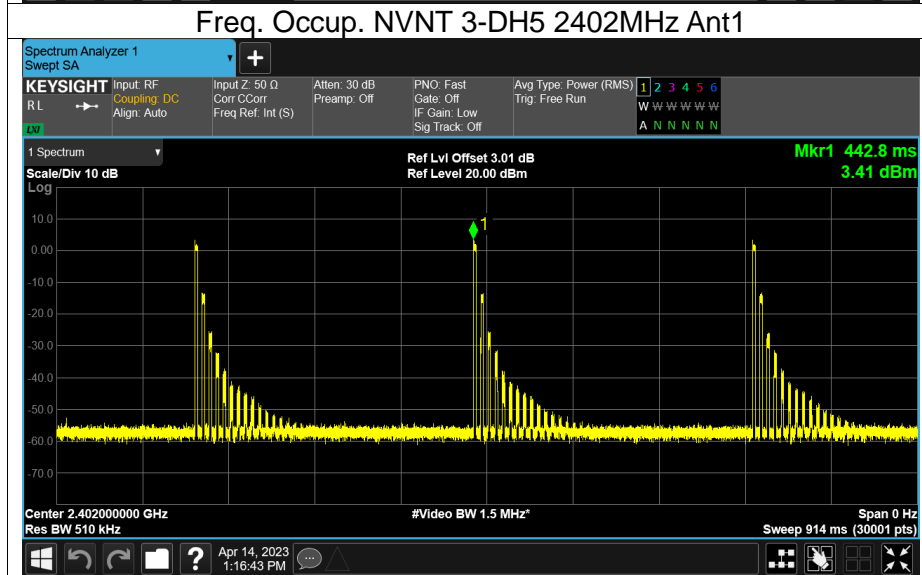
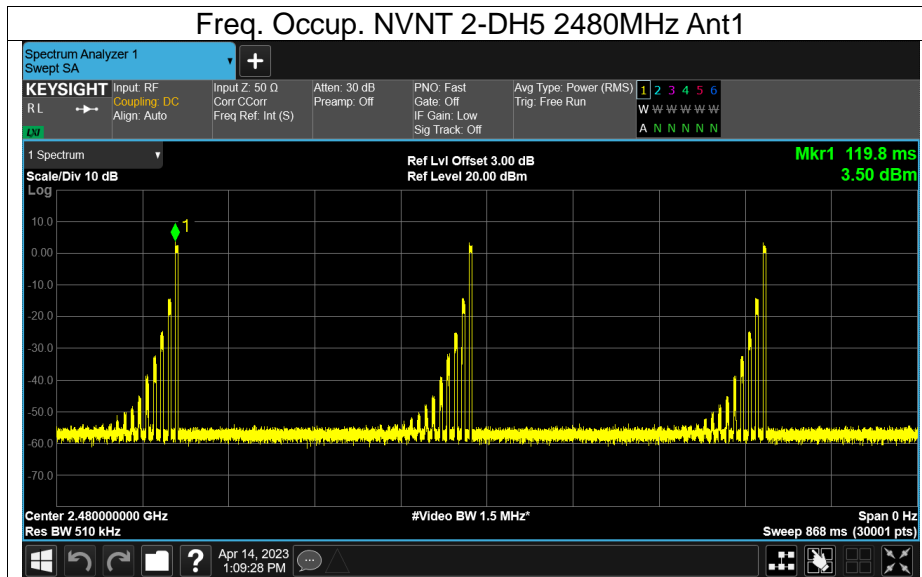



Hopping Sequence

Condition	Mode	Antenna	Hopping Number	Limit	Band Allocation (%)	Limit Band Allocation (%)	Verdict
NVNT	1-DH5	Ant1	79	15	95.4	70	Pass
NVNT	2-DH5	Ant1	79	15	97	70	Pass
NVNT	3-DH5	Ant1	79	15	97.4	70	Pass

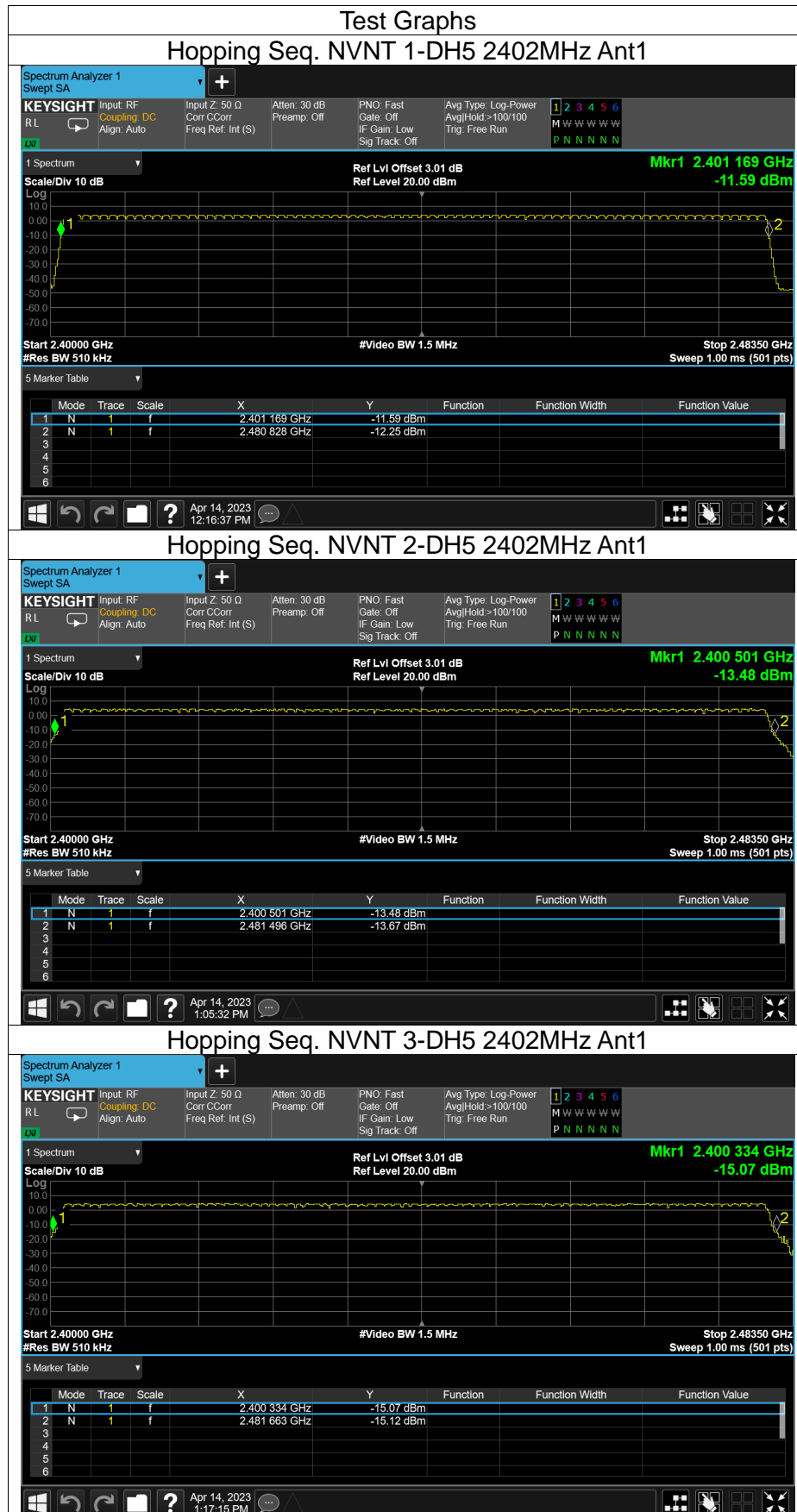



Dwell Time One Burst

Condition	Mode	Frequency (MHz)	Antenna	Pulse Time (ms)
NVNT	1-DH5	2402	Ant1	2.884
NVNT	1-DH5	2480	Ant1	2.865
NVNT	2-DH5	2402	Ant1	2.891
NVNT	2-DH5	2480	Ant1	2.743
NVNT	3-DH5	2402	Ant1	2.891
NVNT	3-DH5	2480	Ant1	2.74

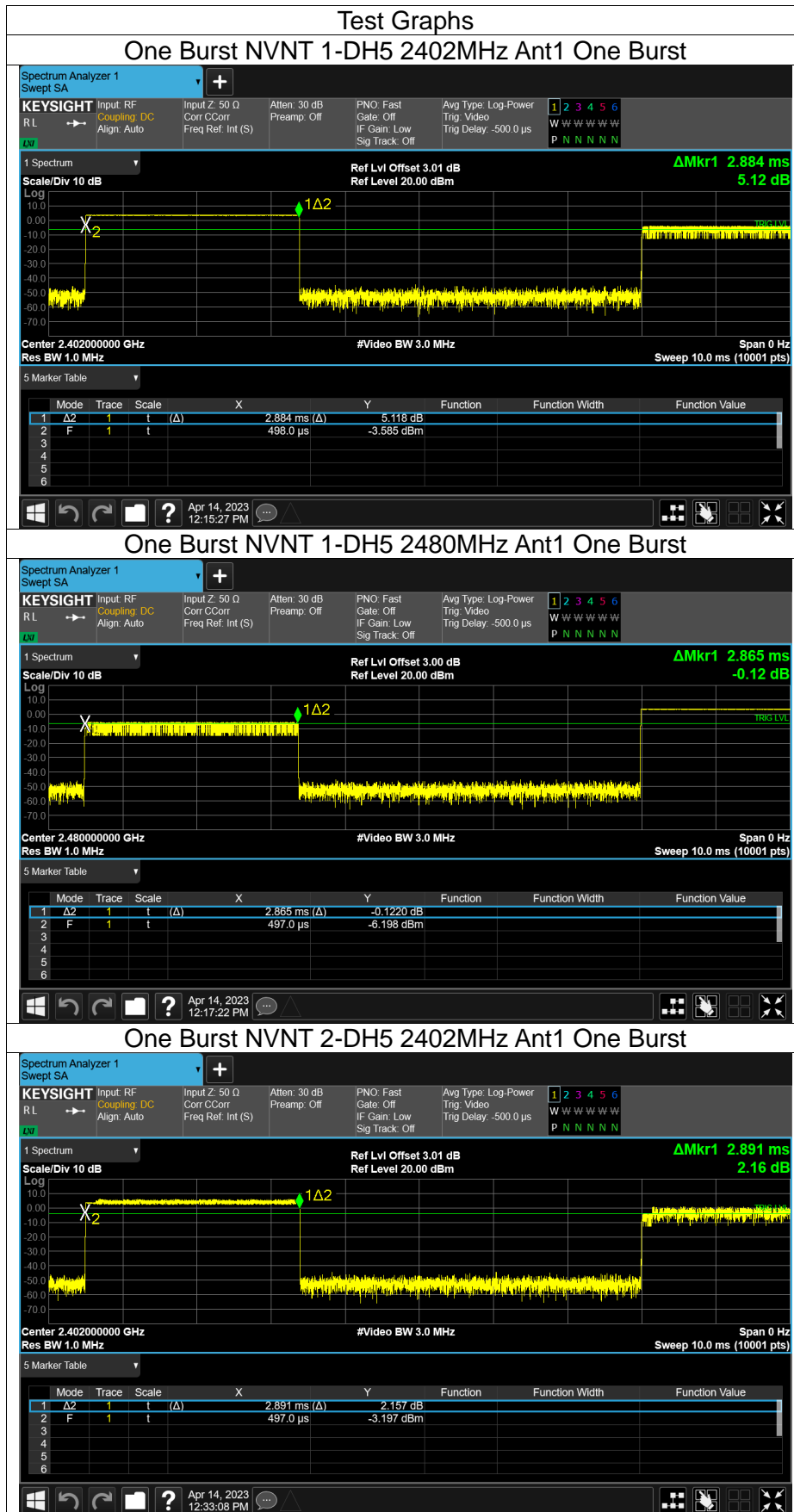

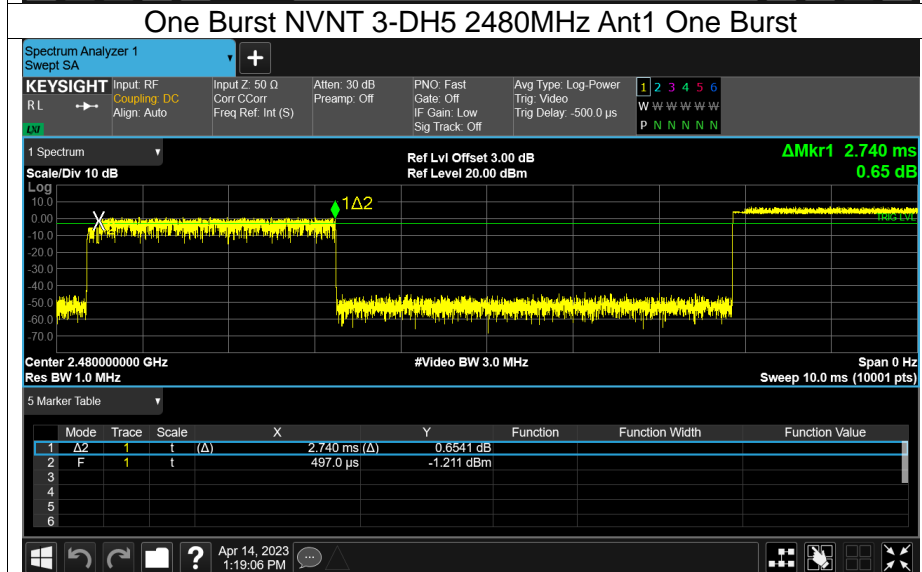
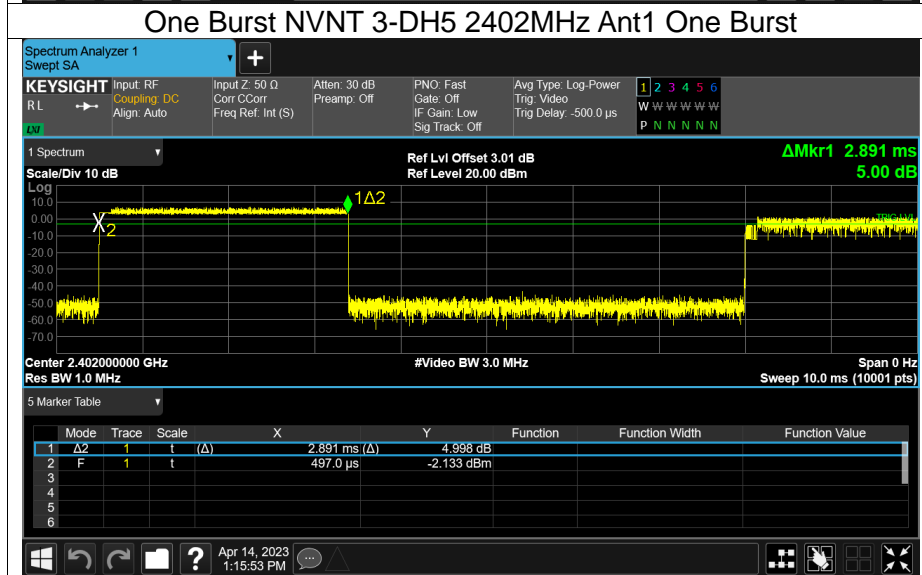
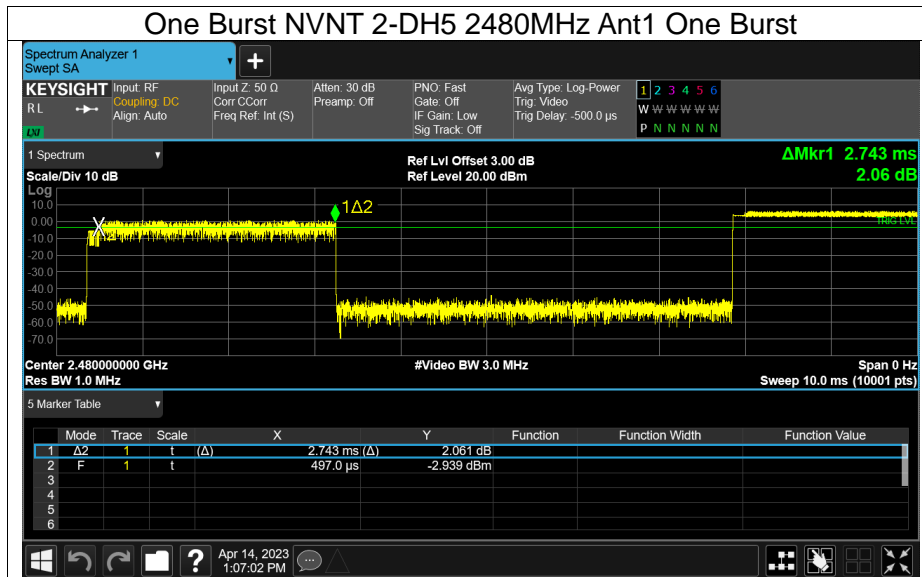



Hopping Frequency Separation

Condition	Mode	Antenna	Hopping Freq1 (MHz)	Hopping Freq2 (MHz)	HFS (MHz)	Limit (MHz)	Verdict
NVNT	1-DH5	Ant1	2401.989	2402.963	0.974	0.1	Pass
NVNT	1-DH5	Ant1	2478.959	2479.966	1.007	0.1	Pass
NVNT	2-DH5	Ant1	2401.986	2403.064	1.078	0.1	Pass
NVNT	2-DH5	Ant1	2479.096	2479.966	0.87	0.1	Pass
NVNT	3-DH5	Ant1	2401.986	2402.968	0.982	0.1	Pass
NVNT	3-DH5	Ant1	2479.005	2480.002	0.997	0.1	Pass

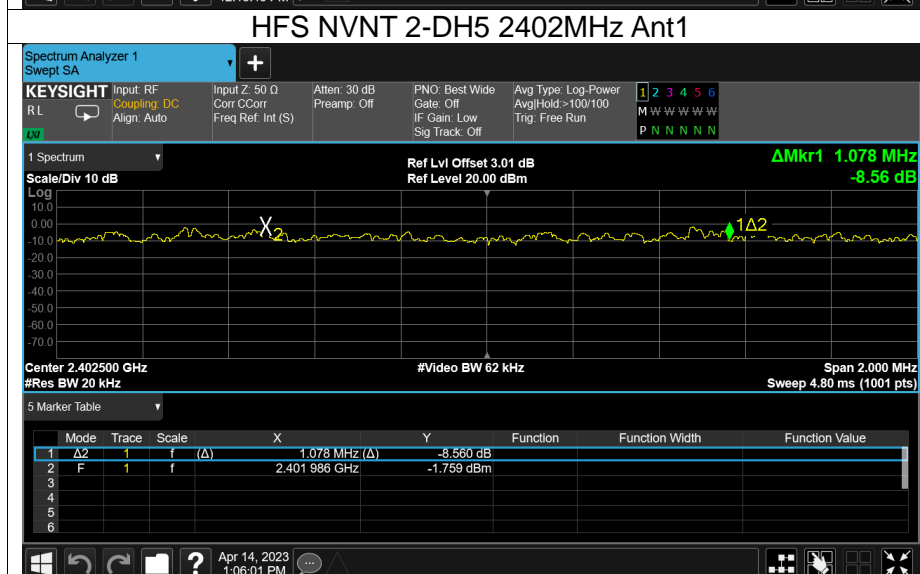
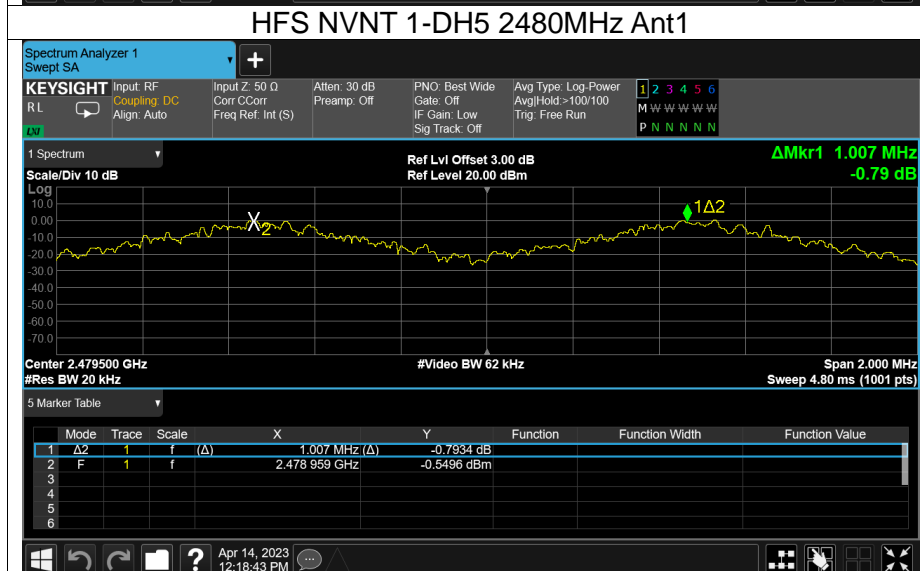
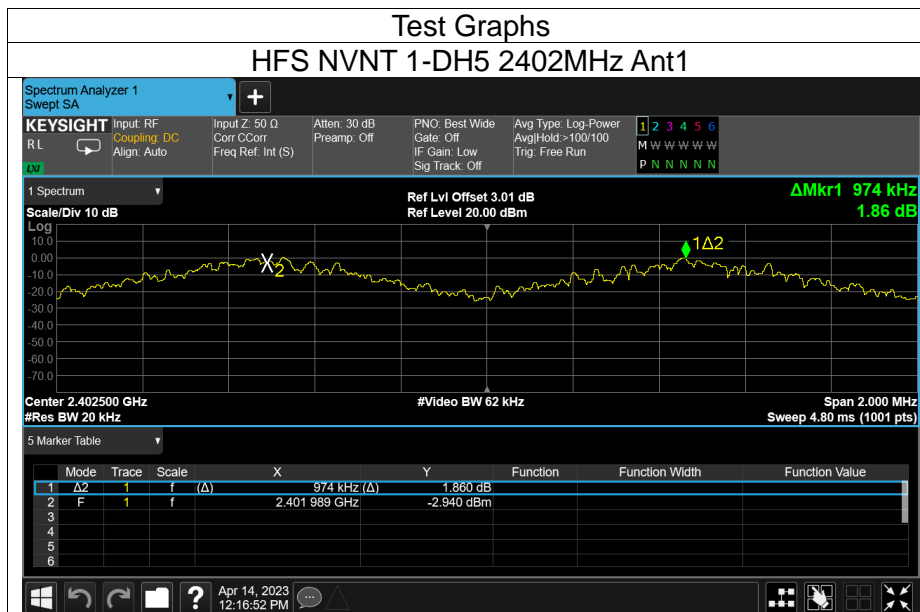

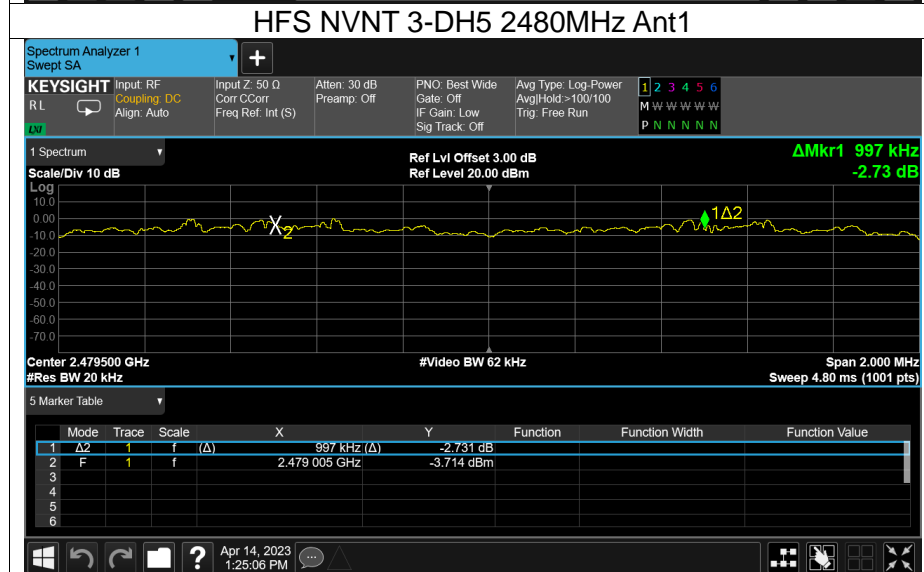
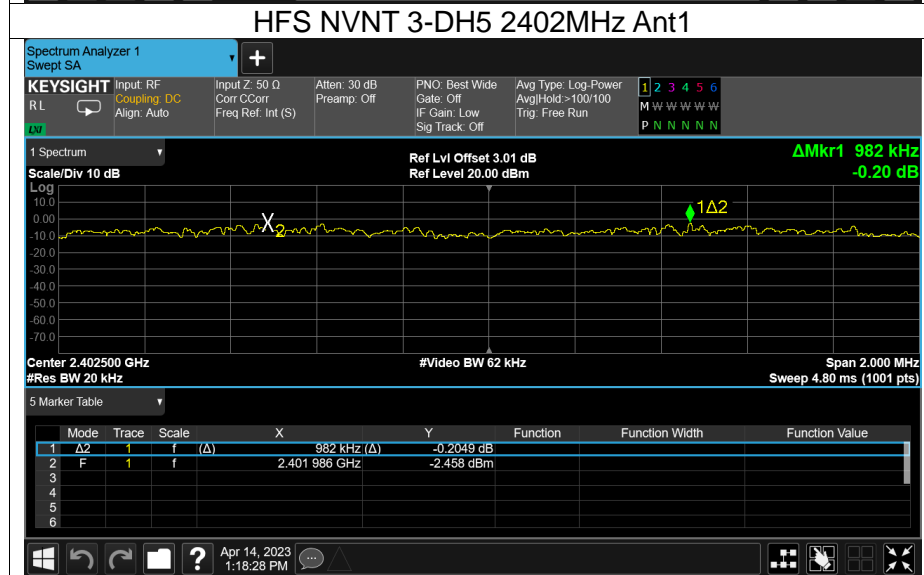
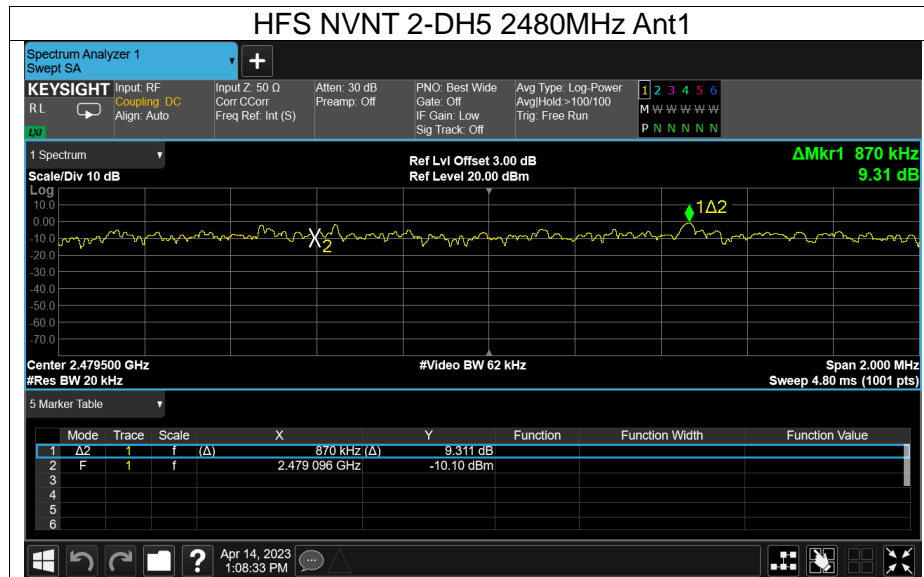



Occupied Channel Bandwidth

Condition	Mode	Frequency (MHz)	Center Frequency (MHz)	OBW (MHz)	Lower Edge (MHz)	Upper Edge (MHz)	Limit OBW (MHz)	Verdict
NVNT	1-DH5	2402	2401.971	0.882	2401.53	2402.412	2400 - 2483.5MHz	Pass
NVNT	1-DH5	2480	2479.97	0.879	2479.531	2480.409	2400 - 2483.5MHz	Pass
NVNT	2-DH5	2402	2401.986	1.252	2401.36	2402.612	2400 - 2483.5MHz	Pass
NVNT	2-DH5	2480	2479.987	1.254	2479.36	2480.614	2400 - 2483.5MHz	Pass
NVNT	3-DH5	2402	2401.975	1.242	2401.355	2402.596	2400 - 2483.5MHz	Pass
NVNT	3-DH5	2480	2479.976	1.245	2479.354	2480.598	2400 - 2483.5MHz	Pass



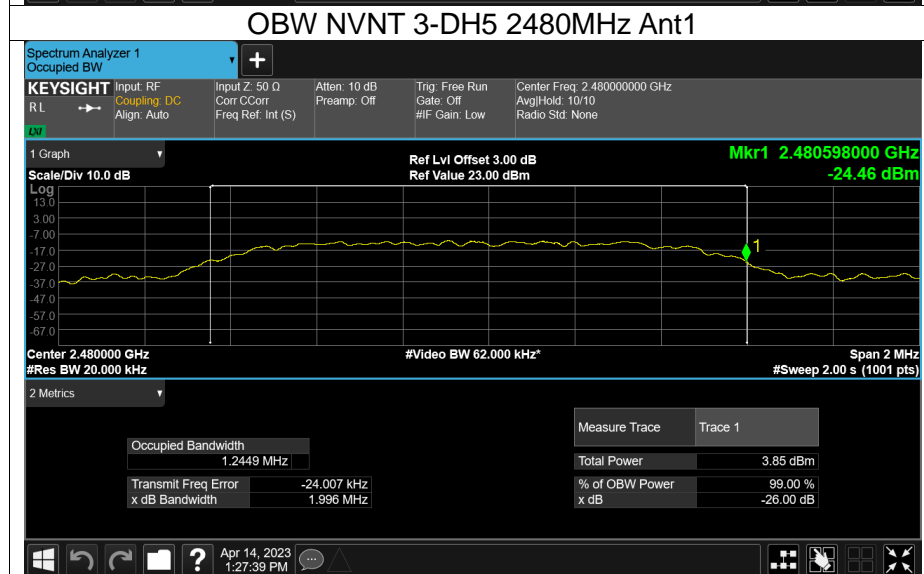
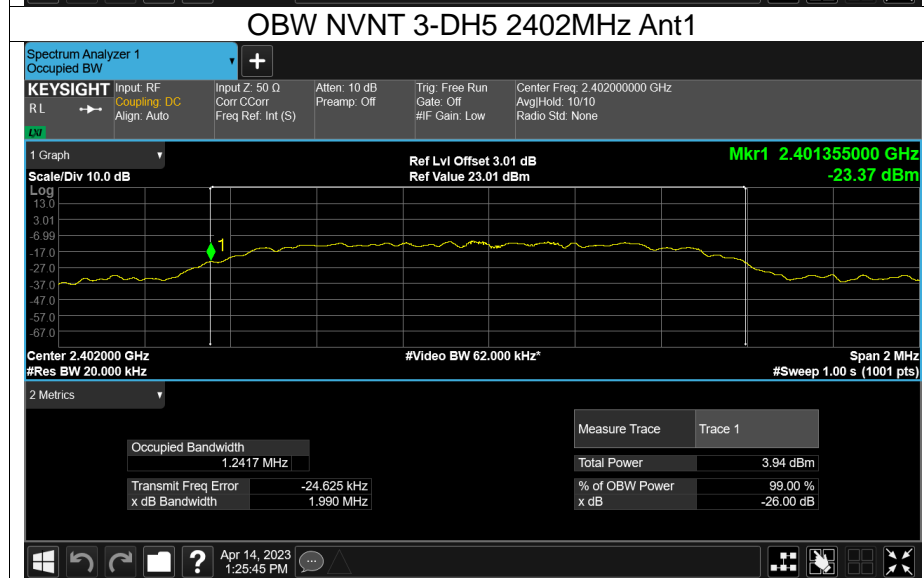
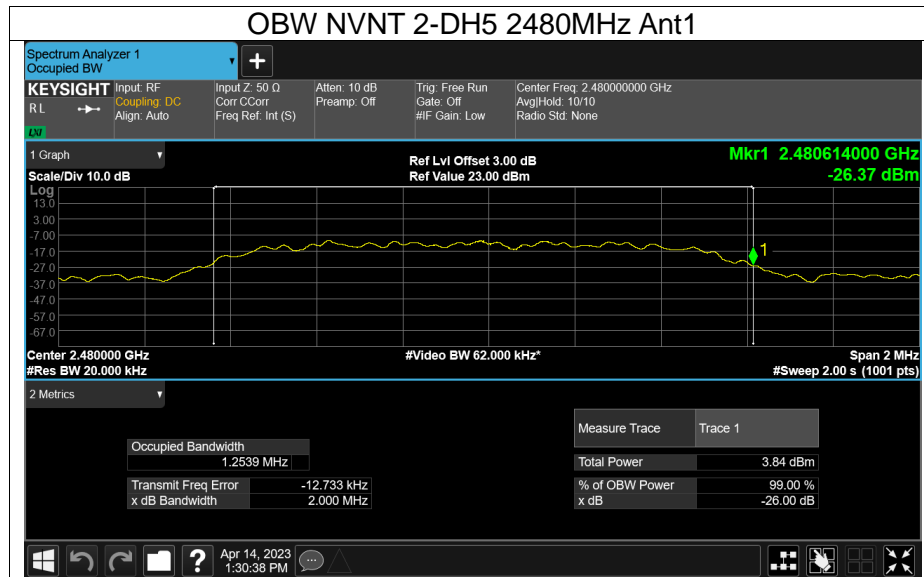



Transmitter unwanted emissions in the out-of-band domain

Condition	Mode	Frequency (MHz)	Antenna	OOB Frequency (MHz)	Level (dBm/MHz)	Limit (dBm/MHz)	Verdict
NVNT	1-DH5	Hopping	Ant1	2399.5	-69.65	-10	Pass
NVNT	1-DH5	Hopping	Ant1	2398.5	-62.82	-20	Pass
NVNT	1-DH5	Hopping	Ant1	2484	-69.65	-10	Pass
NVNT	1-DH5	Hopping	Ant1	2485	-69.65	-20	Pass
NVNT	2-DH5	Hopping	Ant1	2399.5	-63.53	-10	Pass
NVNT	2-DH5	Hopping	Ant1	2398.5	-69.7	-20	Pass
NVNT	2-DH5	Hopping	Ant1	2484	-67.25	-10	Pass
NVNT	2-DH5	Hopping	Ant1	2485	-39.43	-20	Pass
NVNT	3-DH5	Hopping	Ant1	2399.5	-48.63	-10	Pass
NVNT	3-DH5	Hopping	Ant1	2398.5	-65.71	-20	Pass
NVNT	3-DH5	Hopping	Ant1	2484	-65.8	-10	Pass
NVNT	3-DH5	Hopping	Ant1	2485	-55.59	-20	Pass



Test Graphs

Tx. Emissions OOB NVNT 1-DH5 2402MHz Ant1

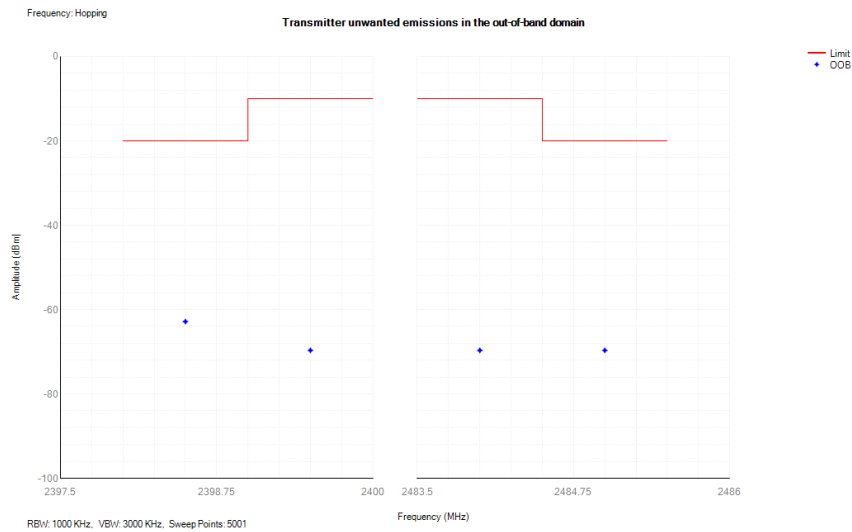

Tx. Emissions OOB NVNT 2-DH5 2402MHz Ant1

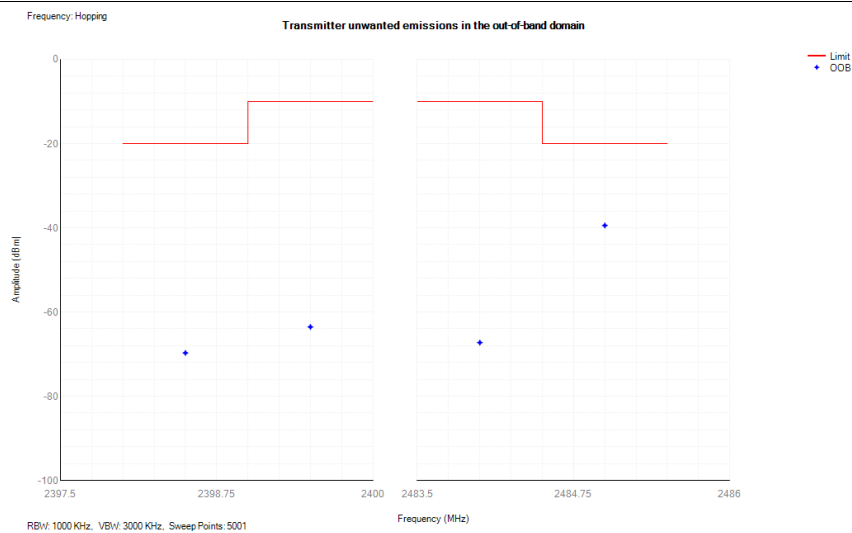

Tx. Emissions OOB NVNT 3-DH5 2402MHz Ant1

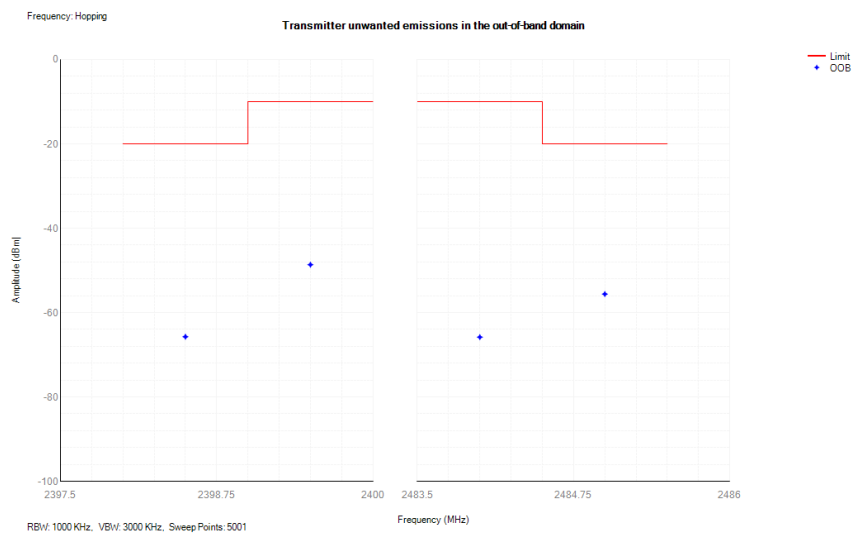



Transmitter unwanted emissions in the spurious domain

Condition	Mode	Frequency (MHz)	Antenna	Range (MHz)	Spur Freq (MHz)	Peak (dBm)	RMS (dBm)	Limit (dBm)	Verdict
NVNT	1-DH5	2402	Ant1	30 -47	32.75	-63.71	NA	-36	Pass
NVNT	1-DH5	2402	Ant1	47 -74	50.00	-62.77	NA	-54	Pass
NVNT	1-DH5	2402	Ant1	74 -87.5	75.80	-62.31	NA	-36	Pass
NVNT	1-DH5	2402	Ant1	87.5 -118	117.10	-60.16	NA	-54	Pass
NVNT	1-DH5	2402	Ant1	118 -174	163.90	-58.62	NA	-36	Pass
NVNT	1-DH5	2402	Ant1	174 -230	183.60	-58.87	-69.13	-54	Pass
NVNT	1-DH5	2402	Ant1	230 -470	282.15	-60.72	NA	-36	Pass
NVNT	1-DH5	2402	Ant1	470 -694	595.75	-66.11	NA	-54	Pass
NVNT	1-DH5	2402	Ant1	694 -1000	731.80	-61.13	NA	-36	Pass
NVNT	1-DH5	2402	Ant1	1000 -2398	2397.50	-49.41	NA	-30	Pass
NVNT	1-DH5	2402	Ant1	2485.5 -12750	4804.00	-46.66	NA	-30	Pass
NVNT	1-DH5	2480	Ant1	30 -47	40.60	-63.87	NA	-36	Pass
NVNT	1-DH5	2480	Ant1	47 -74	67.85	-63.61	NA	-54	Pass
NVNT	1-DH5	2480	Ant1	74 -87.5	79.60	-62.47	NA	-36	Pass
NVNT	1-DH5	2480	Ant1	87.5 -118	103.85	-60.05	NA	-54	Pass
NVNT	1-DH5	2480	Ant1	118 -174	164.30	-59.50	NA	-36	Pass
NVNT	1-DH5	2480	Ant1	174 -230	184.75	-58.89	-69.39	-54	Pass
NVNT	1-DH5	2480	Ant1	230 -470	266.25	-60.62	NA	-36	Pass
NVNT	1-DH5	2480	Ant1	470 -694	687.20	-65.53	NA	-54	Pass
NVNT	1-DH5	2480	Ant1	694 -1000	731.80	-61.08	NA	-36	Pass
NVNT	1-DH5	2480	Ant1	1000 -2398	2062.00	-51.71	NA	-30	Pass
NVNT	1-DH5	2480	Ant1	2485.5 -12750	4960.00	-47.48	NA	-30	Pass
NVNT	2-DH5	2402	Ant1	30 -47	38.25	-63.40	NA	-36	Pass
NVNT	2-DH5	2402	Ant1	47 -74	50.00	-62.75	NA	-54	Pass
NVNT	2-DH5	2402	Ant1	74 -87.5	86.50	-62.83	NA	-36	Pass
NVNT	2-DH5	2402	Ant1	87.5 -118	112.30	-60.26	NA	-54	Pass
NVNT	2-DH5	2402	Ant1	118 -174	142.55	-58.67	NA	-36	Pass
NVNT	2-DH5	2402	Ant1	174 -230	175.10	-58.74	-69.63	-54	Pass



NVNT	2-DH5	2402	Ant1	230 -470	231.60	-60.27	NA	-36	Pass
NVNT	2-DH5	2402	Ant1	470 -694	577.30	-65.74	NA	-54	Pass
NVNT	2-DH5	2402	Ant1	694 -1000	731.75	-61.01	NA	-36	Pass
NVNT	2-DH5	2402	Ant1	1000 -2398	2397.5 0	-26.87	-39.79	-30	Pass
NVNT	2-DH5	2402	Ant1	2485.5 -1275 0	4803.5 0	-46.27	NA	-30	Pass
NVNT	2-DH5	2480	Ant1	30 -47	31.00	-63.98	NA	-36	Pass
NVNT	2-DH5	2480	Ant1	47 -74	65.70	-63.08	NA	-54	Pass
NVNT	2-DH5	2480	Ant1	74 -87.5	84.50	-62.36	NA	-36	Pass
NVNT	2-DH5	2480	Ant1	87.5 -118	100.20	-60.13	NA	-54	Pass
NVNT	2-DH5	2480	Ant1	118 -174	172.85	-58.91	NA	-36	Pass
NVNT	2-DH5	2480	Ant1	174 -230	187.15	-59.26	-69.06	-54	Pass
NVNT	2-DH5	2480	Ant1	230 -470	234.40	-60.36	NA	-36	Pass
NVNT	2-DH5	2480	Ant1	470 -694	682.50	-65.65	NA	-54	Pass
NVNT	2-DH5	2480	Ant1	694 -1000	731.75	-60.99	NA	-36	Pass
NVNT	2-DH5	2480	Ant1	1000 -2398	1995.5 0	-52.23	NA	-30	Pass
NVNT	2-DH5	2480	Ant1	2485.5 -1275 0	2486.0 0	-33.55	-49.11	-30	Pass
NVNT	3-DH5	2402	Ant1	30 -47	39.20	-64.16	NA	-36	Pass
NVNT	3-DH5	2402	Ant1	47 -74	50.00	-62.82	NA	-54	Pass
NVNT	3-DH5	2402	Ant1	74 -87.5	85.20	-60.89	NA	-36	Pass
NVNT	3-DH5	2402	Ant1	87.5 -118	111.05	-60.34	NA	-54	Pass
NVNT	3-DH5	2402	Ant1	118 -174	142.55	-59.32	NA	-36	Pass
NVNT	3-DH5	2402	Ant1	174 -230	185.20	-58.43	-69.23	-54	Pass
NVNT	3-DH5	2402	Ant1	230 -470	251.70	-59.93	NA	-36	Pass
NVNT	3-DH5	2402	Ant1	470 -694	484.45	-65.61	NA	-54	Pass
NVNT	3-DH5	2402	Ant1	694 -1000	731.80	-61.08	NA	-36	Pass
NVNT	3-DH5	2402	Ant1	1000 -2398	2397.5 0	-22.39	-35.04	-30	Pass
NVNT	3-DH5	2402	Ant1	2485.5 -1275 0	4804.0 0	-46.44	NA	-30	Pass
NVNT	3-DH5	2480	Ant1	30 -47	37.40	-63.59	NA	-36	Pass
NVNT	3-DH5	2480	Ant1	47 -74	72.95	-63.31	NA	-54	Pass
NVNT	3-DH5	2480	Ant1	74	87.00	-61.59	NA	-36	Pass



				-87.5					
NVNT	3-DH5	2480	Ant1	87.5 -118	112.75	-60.16	NA	-54	Pass
NVNT	3-DH5	2480	Ant1	118 -174	142.60	-58.69	NA	-36	Pass
NVNT	3-DH5	2480	Ant1	174 -230	191.90	-58.57	-69.1	-54	Pass
NVNT	3-DH5	2480	Ant1	230 -470	234.30	-59.72	NA	-36	Pass
NVNT	3-DH5	2480	Ant1	470 -694	470.10	-65.71	NA	-54	Pass
NVNT	3-DH5	2480	Ant1	694 -1000	731.80	-60.81	NA	-36	Pass
NVNT	3-DH5	2480	Ant1	1000 -2398	2022.5 0	-51.87	NA	-30	Pass
NVNT	3-DH5	2480	Ant1	2485.5 -1275 0	2486.0 0	-26.07	-38.3	-30	Pass



Test Graphs

Tx. Spurious NVNT 1-DH5 2402MHz Ant1

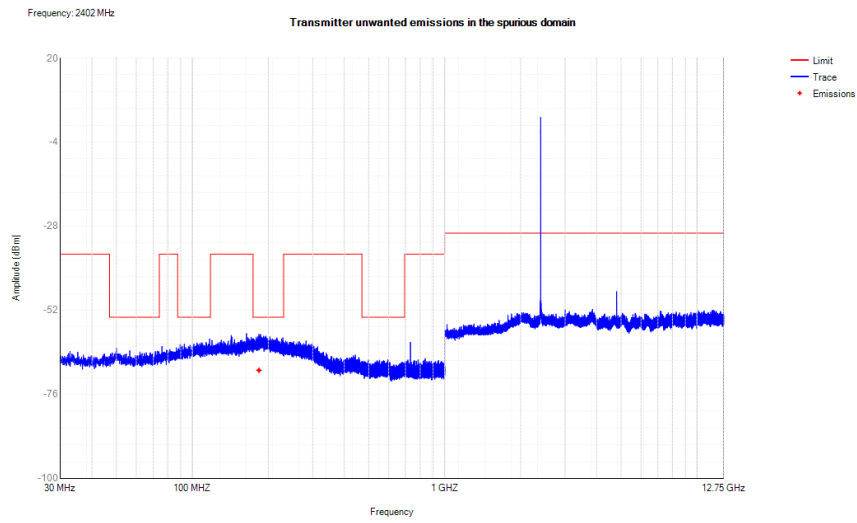

Tx. Spurious NVNT 1-DH5 2480MHz Ant1

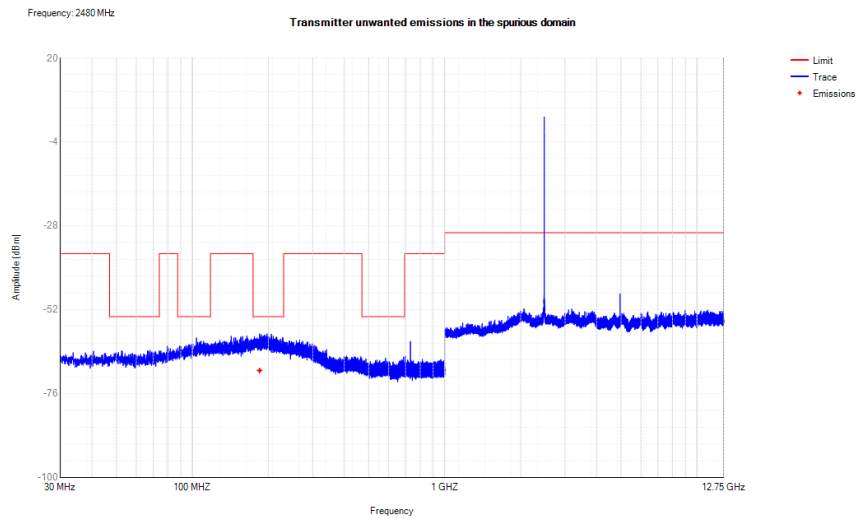

Tx. Spurious NVNT 2-DH5 2402MHz Ant1

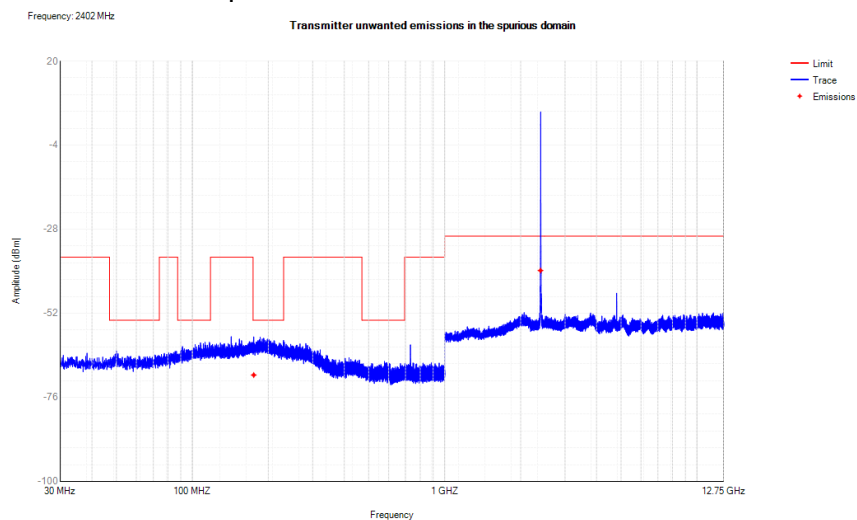



Tx. Spurious NVNT 2-DH5 2480MHz Ant1

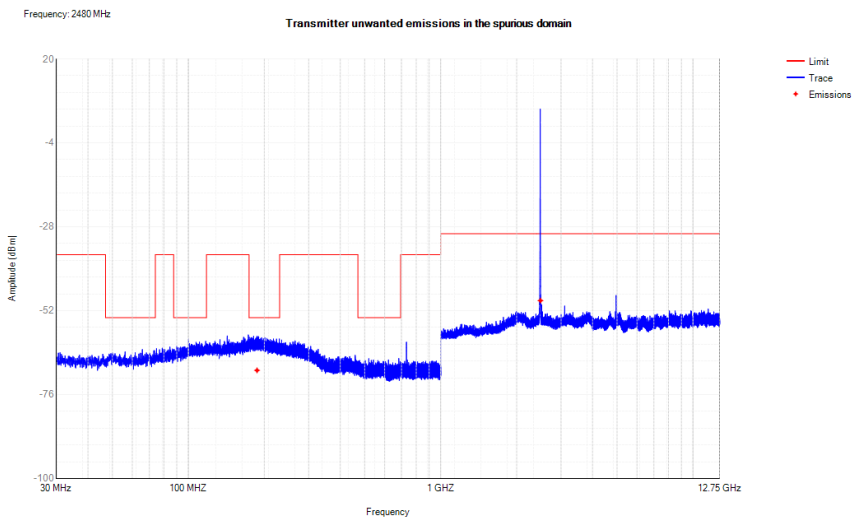

Tx. Spurious NVNT 3-DH5 2402MHz Ant1

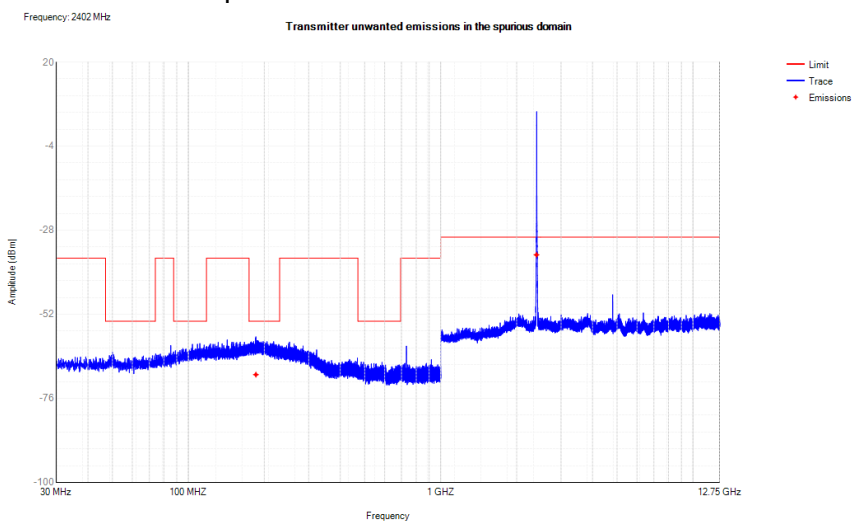

Tx. Spurious NVNT 3-DH5 2480MHz Ant1

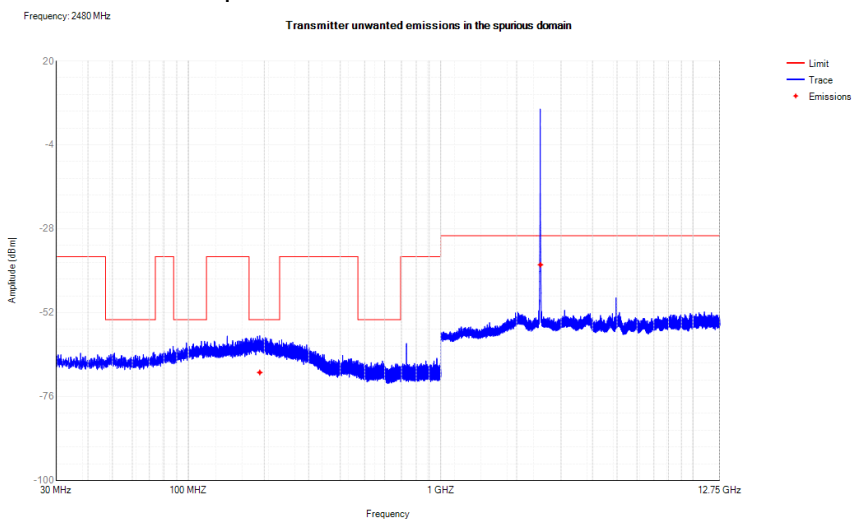



Receiver spurious emissions

Condition	Mode	Frequency (MHz)	Antenna	Range (MHz)	Spur Freq (MHz)	Peak (dBm)	RMS (dBm)	Limit (dBm)	Verdict
NVNT	1-DH5	2402	Ant1	30 -1000	185.1	-70.07	NA	-57	Pass
NVNT	1-DH5	2402	Ant1	1000 -12750	8292	-63.15	NA	-47	Pass
NVNT	1-DH5	2480	Ant1	30 -1000	178.2	-70.40	NA	-57	Pass
NVNT	1-DH5	2480	Ant1	1000 -12750	10680.5	-62.24	NA	-47	Pass
NVNT	2-DH5	2402	Ant1	30 -1000	156.95	-70.56	NA	-57	Pass
NVNT	2-DH5	2402	Ant1	1000 -12750	4761	-63.17	NA	-47	Pass
NVNT	2-DH5	2480	Ant1	30 -1000	140.2	-70.13	NA	-57	Pass
NVNT	2-DH5	2480	Ant1	1000 -12750	3798.5	-63.31	NA	-47	Pass
NVNT	3-DH5	2402	Ant1	30 -1000	202.75	-70.00	NA	-57	Pass
NVNT	3-DH5	2402	Ant1	1000 -12750	10658	-62.97	NA	-47	Pass
NVNT	3-DH5	2480	Ant1	30 -1000	181.65	-68.36	NA	-57	Pass
NVNT	3-DH5	2480	Ant1	1000 -12750	11321	-63.25	NA	-47	Pass



Test Graphs

Rx. Spurious NVNT 1-DH5 2402MHz Ant1

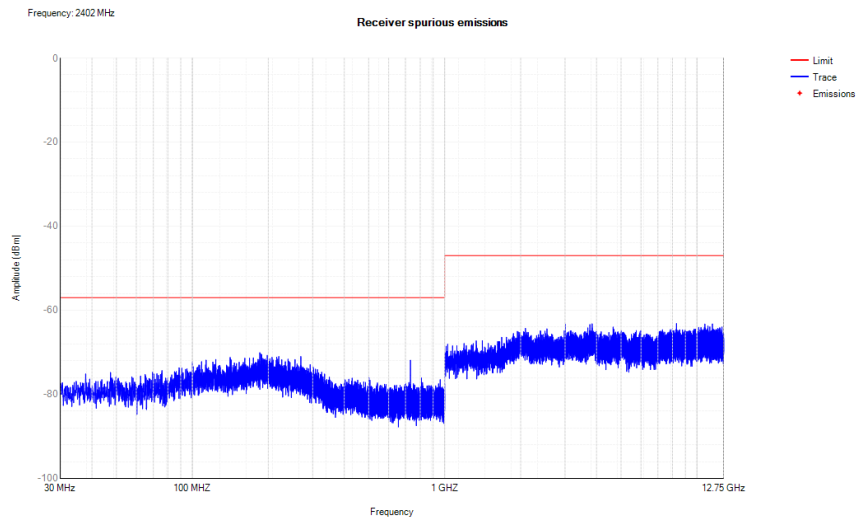

Rx. Spurious NVNT 1-DH5 2480MHz Ant1

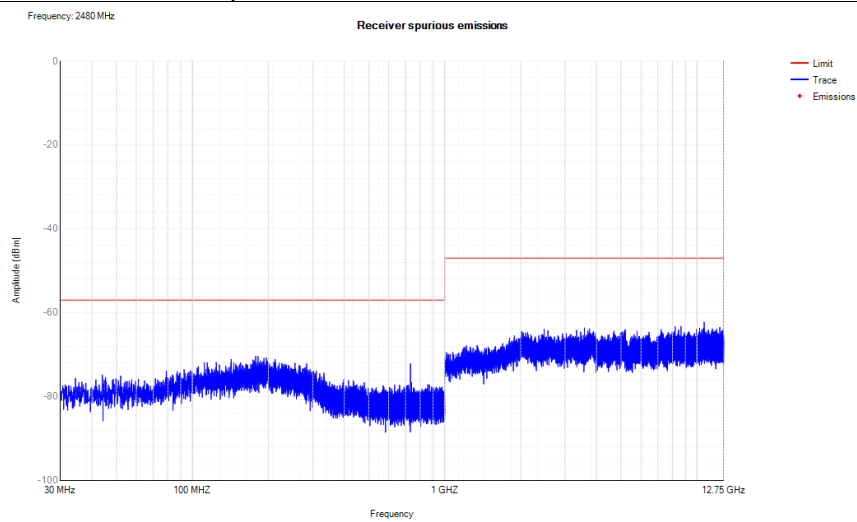

Rx. Spurious NVNT 2-DH5 2402MHz Ant1

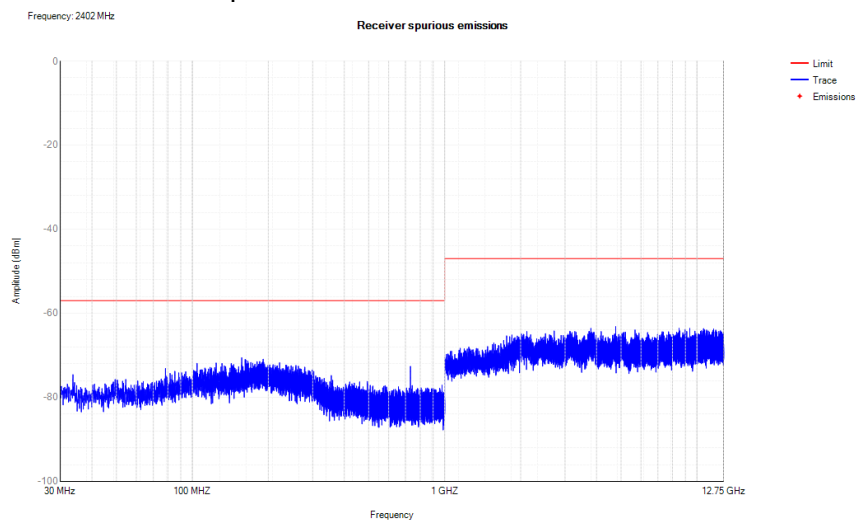



Rx. Spurious NVNT 2-DH5 2480MHz Ant1

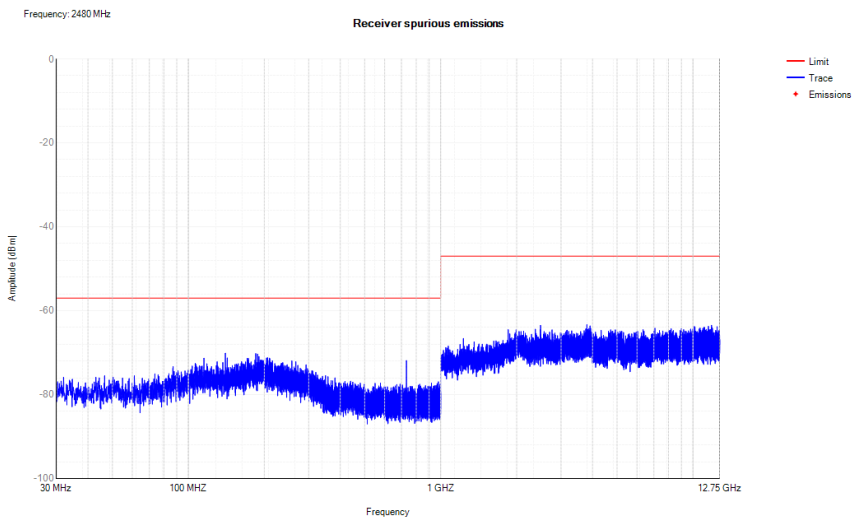

Rx. Spurious NVNT 3-DH5 2402MHz Ant1

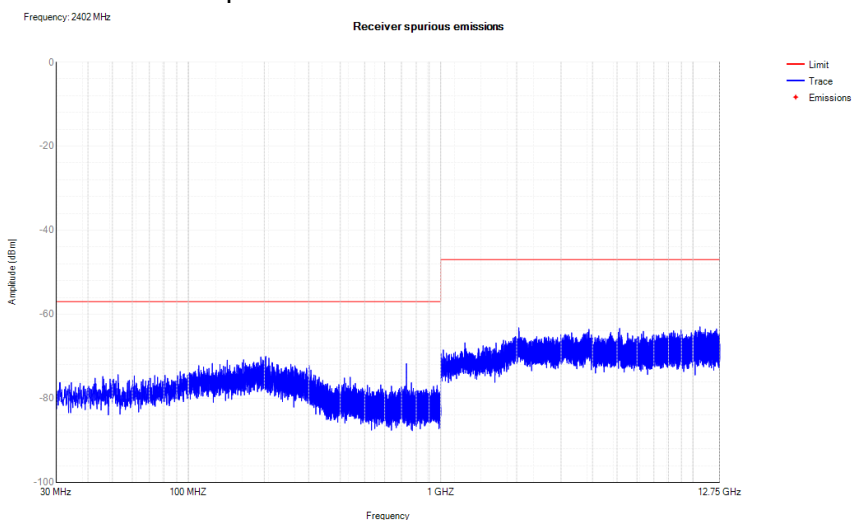

Rx. Spurious NVNT 3-DH5 2480MHz Ant1

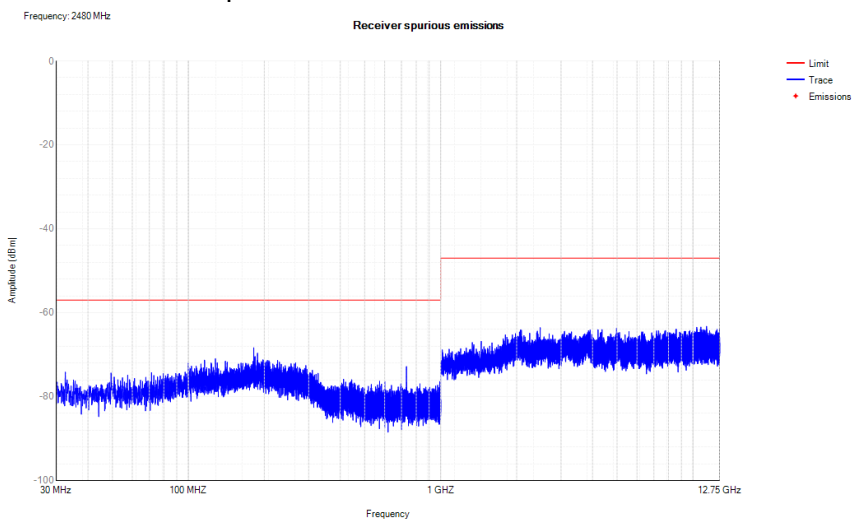



APPENDIX II - MEASUREMENT PHOTOS

Set-up for Transmitter & Receiver Spurious Emissions, Below 1GHz

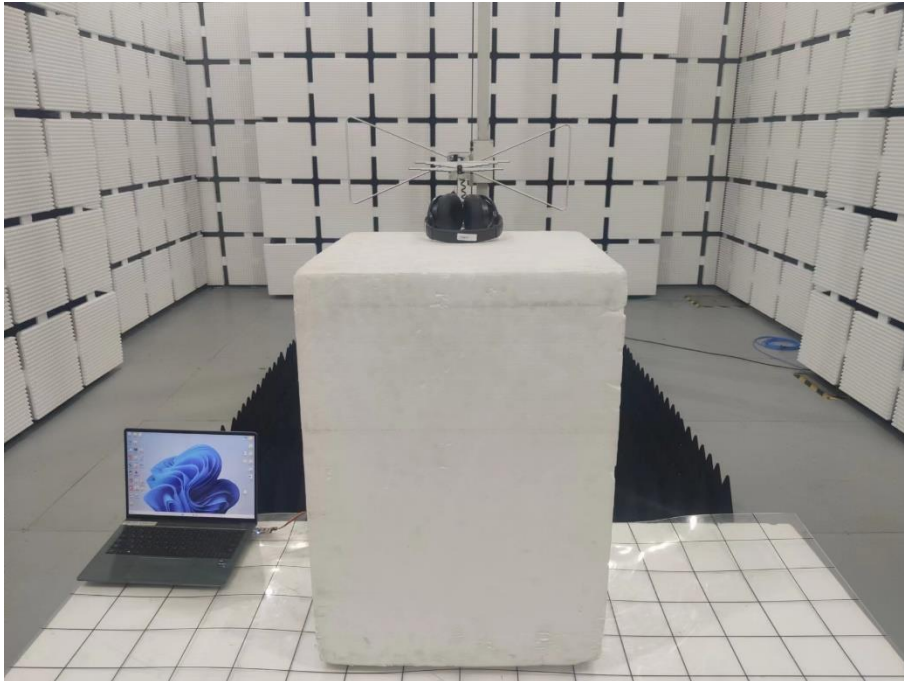

Set-up for Transmitter & Receiver Spurious Emissions, Above 1GHz

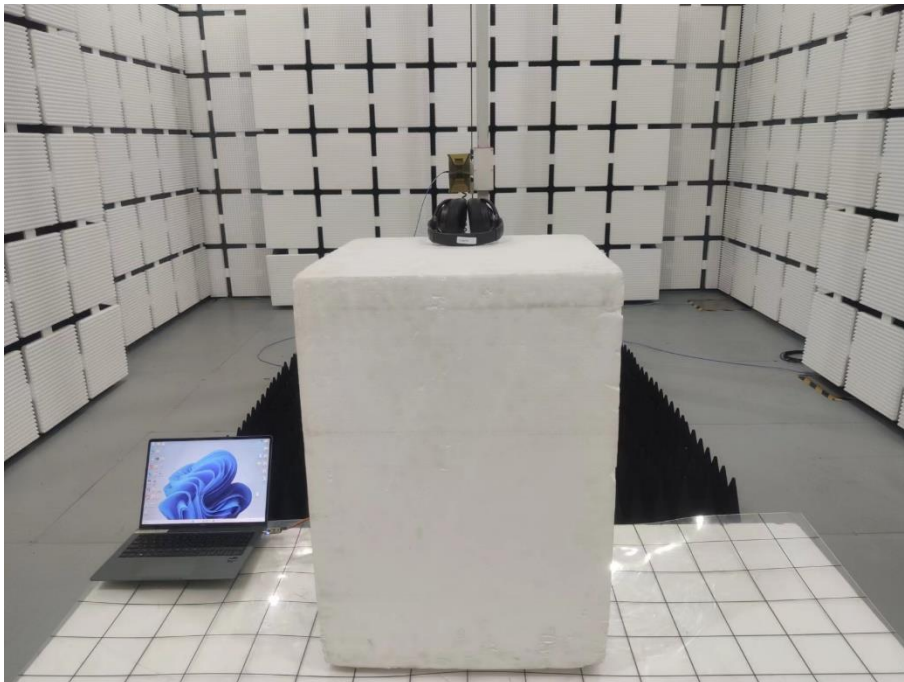

※※※※ END OF THE REPORT ※※※※