



EMC TEST REPORT

Product Name: Bluetooth Headphones

Model Name: HS-BN928

Issued For : Honsenn Technology Co.Ltd

No.70, Erheng Road, wentang zhuangyao industrial zone,
Dongcheng district,Dongguan City,Guangdong Province.

Issued By : Shenzhen LGT Test Service Co., Ltd.

Room 205, Building 13, Zone B, Chen Hsong Industrial Park,
No.177 Renmin West Road, Jinsha Community, Kengzi Street,
Pingshan New District, Shenzhen, China

Report Number: LGT23D025EM02

Sample Received Date: Apr. 10, 2023

Date of Test: Apr. 10, 2023 – Apr. 20, 2023

Date of Issue: Apr. 20, 2023



TEST REPORT CERTIFICATION

Applicant: Honsenn Technology Co.Ltd
Address: No.70, Erheng Road, wentang zhuangyao industrial zone, Dongcheng district, Dongguan City, Guangdong Province.

Manufacture: Honsenn Technology Co.Ltd
Address: No.70, Erheng Road, wentang zhuangyao industrial zone, Dongcheng district, Dongguan City, Guangdong Province.

Factory: Honsenn Technology Co.Ltd
Address: No.70, Erheng Road, wentang zhuangyao industrial zone, Dongcheng district, Dongguan City, Guangdong Province.

Product Name: Bluetooth Headphones

Trademark: N/A

Model Name: HS-BN928

Sample Status: Normal

APPLICABLE STANDARDS	
STANDARD	TEST RESULTS
EN 55032:2015/A11:2020 EN IEC 61000-3-2:2019 EN 61000-3-3:2013+A1:2019 EN 55035:2017/A11:2020	PASS

Prepared by:

Terry Zhao

Terry Zhao
Engineer

Approved by:

Vita Li

Vita Li
Technical Director



- (1) The test report is effective only with both signature and specialized stamp.
- (2) This report shall not be reproduced except in full without the written approval of the Laboratory.
- (3) The results in this report apply to the test sample(s) mentioned above at the time of the testing period only and are not to be used to indicate applicability to other similar products.



TABLE OF CONTENTS

1. TEST SUMMARY	5
1.1 TEST FACTORY	6
1.2 MEASUREMENT UNCERTAINTY	6
2. GENERAL INFORMATION	7
2.1 GENERAL DESCRIPTION OF THE EUT	7
2.2 DESCRIPTION OF THE TEST MODES	8
2.3 DESCRIPTION OF THE SUPPORT UNITS	8
2.4 MEASUREMENT INSTRUMENTS LIST	9
3. EMC EMISSION TEST	11
3.1 CONDUCTED EMISSION MEASUREMENT	11
3.2 RADIATED EMISSION MEASUREMENT	15
3.3 HARMONICS CURRENT	23
3.4 VOLTAGE FLUCTUATION AND FLICKERS	25
4. EMC IMMUNITY TEST	26
4.1 STANDARD COMPLIANCE/SERVRITY LEVEL/CRITERIA	26
4.2 GENERAL PERFORMANCE CRITERIA	27
4.3 ELECTROSTATIC DISCHARGE IMMUNITY TEST (ESD)	28
4.4 RADIATED, RADIO-FREQUENCY, ELECTROMAGNETIC FIELD IMMUNITY TEST (RS)	32
4.5 ELECTRICAL FAST TRANSIENT (EFT)	36
4.6 SURGE TESTING	40
4.7 CONDUCTED RADIO FREQUENCY DISTURBANCES (CS)	43
4.8 VOLTAGE INTERRUPTION/DIPS TESTING (DIPS)	46
APPENDIX 1 - TEST SETUP	48



Revision History

Rev.	Issue Date	Revisions
00	Apr. 20, 2023	Initial Issue



1. TEST SUMMARY

Test procedures according to the technical standards:

EMC Emission				
Standard	Test Item	Limit	Judgement	Remark
EN 55032:2015/A11:2020	Conducted Emission on AC And Telecom Port 150kHz to 30MHz	Class B	PASS	
	Radiated Emissions	Class B	PASS	NOTE (1)
EN IEC 61000-3-2:2019	Harmonic Current Emission	-----	N/A	NOTE (2)
EN 61000-3-3:2013+A1:2019	Voltage Fluctuations & Flicker	-----	N/A	NOTE (2)
EMC Immunity				
Section EN 55035:2017/A11:2020	Test Item	Performance Criteria	Judgement	Remark
EN 61000-4-2:2009	Electrostatic discharges	B	PASS	
EN IEC 61000-4-3:2020	Continuous RF electromagnetic field disturbances	A	PASS	
EN 61000-4-4:2012	Electrical fast transients/burst	B	PASS	
EN 61000-4-5:2014/A1:2017	Surges	B	PASS	
EN 61000-4-6:2014+AC:2015	Continuous induced RF disturbances	A	PASS	
EN 61000-4-8:2010	Power frequency magnetic field	A	N/A	
EN IEC 61000-4-11:2020	Voltage dips and interruptions	B / C / C	PASS	NOTE (3)

- Note:**
- (1) If the highest frequency of the internal sources of the EUT is less than 108 MHz, the measurement shall only be made up to 1 GHz.
 If the highest frequency of the internal sources of the EUT is between 108 MHz and 500 MHz, the measurement shall only be made up to 2 GHz.
 If the highest frequency of the internal sources of the EUT is between 500 MHz and 1GHz, the measurement shall only be made up to 5 GHz.
 If the highest frequency of the internal sources of the EUT is above 1 GHz, the measurement shall be made up to 5 times of the highest frequency or 6 GHz, whichever is less.
 - (2) The power consumption of EUT is less than 75W and no Limits apply.
 - (3) Voltage Dip: 100% reduction – Performance Criteria **B**
 Voltage Dip: 30% reduction – Performance Criteria **C**
 Voltage Interruption: 100% Interruption – Performance Criteria **C**
 - (4) N/A=Not Applicable.



1.1 TEST FACTORY

Company Name:	Shenzhen LGT Test Service Co., Ltd.
Address:	Room 205, Building 13, Zone B, Chen Hsong Industrial Park, No.177 Renmin West Road, Jinsha Community, Kengzi Street, Pingshan New District, Shenzhen, China
Accreditation Certificate	A2LA Certificate No.: 6727.01
	FCC Registration No.: 746540
	CAB ID: CN0136

1.2 MEASUREMENT UNCERTAINTY

The reported uncertainty of measurement $y \pm U$, where expanded uncertainty U is based on a standard uncertainty multiplied by a coverage factor of $k=2$, providing a level of confidence of approximately **95** %.

Test Item	Measurement Frequency Range	Uncertainty
Conducted Emissions	0.009MHz ~ 0.15MHz	3.18
Conducted Emissions	0.15MHz ~ 30MHz	2.70
Radiated Emissions	9KHz ~ 30MHz	2.50
Radiated Emissions	30MHz ~ 1000MHz	4.40
Radiated Emissions	1GHz ~ 6 GHz	5.10
Radiated Emissions	6GHz ~ 18GHz	5.49

Note: This uncertainty represents an expanded uncertainty expressed at approximately the 95% confidence level using a coverage factor of $k=2$.



2. GENERAL INFORMATION

2.1 GENERAL DESCRIPTION OF THE EUT

Product Name:	Bluetooth Headphones
Trademark:	N/A
Model Name:	HS-BN928
Series Model:	N/A
Model Difference:	N/A
Maximum Operating Frequency:	2480MHz
Rating:	Input: DC 5V, 1A
Battery:	Capacity: 900mAh Rated Voltage: 3.7V
Test voltage:	AC 230V/50Hz Battery 3.7V
Hardware Version:	V1.3
Software Version:	V2.0

Note: For a more detailed features description, please refer to the manufacturer's specifications or the User's Manual.



2.2 DESCRIPTION OF THE TEST MODES

To investigate the maximum EMI emission characteristics generated from EUT, the test system was pre-scanned based on the consideration of following EUT operation mode or test configuration mode which possibly have effect on EMI emission level. Each of these EUT operation mode(s) or test configuration mode(s) mentioned above was evaluated respectively.

Test Mode	Description
Mode 1	Charging
Mode 2	Line in
Mode 3	Bluetooth

Note: Only the data of worst case mode 1 was recorded in this report.

2.3 DESCRIPTION OF THE SUPPORT UNITS

The EUT has been tested as an independent unit together with other necessary accessories or support units. The following support units or accessories were used to form a representative test configuration during the tests.

Accessories Equipment

Description	Manufacturer	Model	S/N	Rating

Auxiliary Equipment

Description	Manufacturer	Model	S/N	Rating
Adapter	Tenpao	S005CAU05001 00	N/A	Input: 100-240V ~ 50/60Hz 0.2A Output: 5V, 1A
USB-A to USB-C Cable	UGREEN	US287	N/A	1m, shielded, without ferrite core
Mobile phone	SHARK	KSR-10	N/A	N/A
3.5mm to 3.5mm Cable	N/A	N/A	N/A	0.5m

Note:

- (1) For detachable type I/O cable should be specified the length in cm in 『Length』 column.



2.4 MEASUREMENT INSTRUMENTS LIST

Conducted Emission					
Equipment	Manufacturer	Model No.	Serial No.	Cal. Date	Cal. Until
EMI Test Receiver	R&S	ESU8	100372	2023.04.10	2024.04.09
LISN	COM-POWER	LI-115	02032	2023.04.10	2024.04.09
LISN	SCHWARZBECK	NNLK 8121	00847	2022.08.19	2023.08.18
ISN	FCC	T4-02	91317	2022.06.08	2023.06.07
ISN	SCHWARZBECK	NTFM 8158	00303	2022.08.19	2023.08.18
Transient Limiter	CYBERTEK	EM5010A	E2250100049	2022.08.19	2023.08.18
Temperature & Humidity	KTJ	TA218B	N.A	2022.05.05	2023.05.04
Testing Software	EMC-I_V1.4.0.3_SKET				
Radiated Emission					
Equipment	Manufacturer	Model No.	Serial No.	Cal. Date	Cal. Until
EMI Test Receiver	R&S	ESU8	100372	2023.04.10	2024.04.09
Spectrum Analyzer	Keysight	N9020A	MY50530994	2022.12.09	2023.12.08
Spectrum Analyzer	Keysight	N9010B	MY60242508	2022.04.29	2023.04.28
Active loop Antenna	ETS	6502	00049544	2022.06.02	2024.06.01
Bilog Antenna	SCHAFFNER	CBL6112B	2705	2022.06.05	2024.06.04
Bilog Antenna	SCHWARZBECK	VULB 9168	01447	2022.12.12	2023.12.11
Horn Antenna	SCHWARZBECK	3115	10SL0060	2022.06.02	2024.06.01
Pre-amplifier (9kHz-1GHz)	EMtrace	RP01A	02017	2023.04.10	2024.04.09
Pre-amplifier (1-26.5G)	Agilent	8449B	3008A4722	2023.04.10	2024.04.09
Temperature & Humidity	KTJ	TA218B	N.A	2022.05.05	2023.05.04
Testing Software	EMC-I_V1.4.0.3_SKET				
Harmonic & Flick					
Equipment	Manufacturer	Model No.	Serial No.	Cal. Date	Cal. Until
Harmonic Voltage & Flicker	AMETEK	100-CTS-230	2229A00121	2022.12.09	2023.12.08
AC Power Source	AMETEK	3001iX-208-413	2236A00794	2022.12.09	2023.12.08
Temperature & Humidity	KTJ	TA218B	N.A	2022.05.05	2023.05.04
Electrostatic Discharge (ESD)					
Equipment	Manufacturer	Model No.	Serial No.	Cal. Date	Cal. Until
ESD TEST GENERATOR	EMTEST	ESD-30N	V1051108174	2022.08.22	2023.08.21
Temperature & Humidity	SuWei	ST-W2318	N.A	2022.05.05	2023.05.04
Radio Frequency Electromagnetic Fields (RS)					
Equipment	Manufacturer	Model No.	Serial No.	Cal. Date	Cal. Until
Power Sensor	R&S	Z11	116655	2022.12.09	2023.12.08
Power Sensor	R&S	Z11	121896	2022.12.09	2023.12.08
Signal Generator	Agilent	N5181A	MY47070409	2022.12.09	2023.12.08
Power Amplifier	SKET	HAP_80M01G-250W	S202211402	2022.12.09	2023.12.08
Power Amplifier	SKET	HAP_010G060G-80W	S202211403	2022.12.09	2023.12.08
RS Test Antenna	SKET	STLP 9129 Plus	SK20221012006	N.A	N.A
Radio Frequency Continuous Conducted (CS)					
Equipment	Manufacturer	Model No.	Serial No.	Cal. Date	Cal. Until
Conducted	PRIMA	CRF61006A	PR211281052	2022.04.29	2023.04.28



Radio-frequency Test System					
CDN	PRIMA	CRF-CDN-M2 16	PR220281070	2022.04.29	2023.04.28
CDN	PRIMA	CRF-CDN-M3 16	PR220281074	2022.04.29	2023.04.28
Attenuator	PRIMA	ATT-6DB-100	W2198770001	2022.04.29	2023.04.28
Electromagnetic Injection Clamp	ZHINAN	ZN23203	PR211281055	2022.04.29	2023.04.28
Temperature & Humidity	KTJ	TA218B	N.A	2022.05.05	2023.05.04
Fast Transients Common Mode (EFT)					
Equipment	Manufacturer	Model No.	Serial No.	Cal. Date	Cal. Until
Fast Transient Burst Simulator	PRIMA	EFT61004TA	PR220243451	2022.04.29	2023.04.28
EFT CAPACITIVE COUPLING CLAMP	PRIMA	EFT-CLAMP	457	2022.04.29	2023.04.28
Temperature & Humidity	KTJ	TA218B	N.A	2022.05.05	2023.05.04
Surge					
Equipment	Manufacturer	Model No.	Serial No.	Cal. Date	Cal. Until
Lightning Surge Generator (1.2us.50us)	PRIMA	SUG61005TA X	PR211155290	2022.04.29	2023.04.28
Lightning Surge Generator (10us.700us)	PRIMA	SUG10/700TA	PR211255516	2022.04.29	2023.04.28
Signal line decoupling network	PRIMA	DATA-CDN-8 B	PR211255479	2022.12.26	2023.12.25
Temperature & Humidity	KTJ	TA218B	N.A	2022.05.05	2023.05.04
Voltage Dips and Interruptions					
Equipment	Manufacturer	Model No.	Serial No.	Cal. Date	Cal. Until
Cycle Sag Simulator	PRIMA	DRP61011TA	PR21126644	2022.04.29	2023.04.28
Temperature & Humidity	KTJ	TA218B	N.A	2022.05.05	2023.05.04
PFMF					
Equipment	Manufacturer	Model No.	Serial No.	Cal. Date	Cal. Until
Power Frequency Magnetic Field Generator	PRIMA	PFM61008TG	PR211281444	2022.04.29	2023.04.28
Temperature & Humidity	KTJ	TA218B	N.A	2022.05.05	2023.05.04



3. EMC EMISSION TEST

3.1 CONDUCTED EMISSION MEASUREMENT

3.1.1 REQUIREMENTS FOR CONDUCTED EMISSIONS FROM THE AC MAINS POWER PORTS OF THE CLASS A EQUIPMENT

FREQUENCY (MHz)	Coupling device	Detector type / bandwidth	Class A limits dB(μ V)
0.15 ~ 0.5	AMN	Quasi Peak / 9 kHz	79
0.5 ~ 30			73
0.15 ~ 0.5	AMN	Average / 9 kHz	66
0.5 ~ 30			60

3.1.2 REQUIREMENTS FOR CONDUCTED EMISSIONS FROM THE AC MAINS POWER PORTS OF THE CLASS B EQUIPMENT

FREQUENCY (MHz)	Coupling device	Detector type / bandwidth	Class B limits dB(μ V)
0.15 ~ 0.5	AMN	Quasi Peak / 9 kHz	66 - 56*
0.5 ~ 5			56
5 ~ 30			60
0.15 ~ 0.5	AMN	Average / 9 kHz	56 - 46*
0.5 ~ 5			46
5 ~ 30			50

Note:

- (1) The tighter limit applies at the band edges.
- (2) The limit of " * " marked band means the limitation decreases linearly with the logarithm of the frequency in the range.

The following table is the setting of the receiver

Receiver Parameters	Setting
Attenuation	10 dB
Start Frequency	0.15 MHz
Stop Frequency	30 MHz
IF Bandwidth	9 kHz



3.1.3 TEST PROCEDURE

- a. The EUT was placed 0.4 meters from the conducting wall of the shielded room with EUT being connected to the power mains through a line impedance stabilization network (LISN). Other support units were connected to the power mains through another LISN. The two LISNs provide 50 Ohm/ 50uH of coupling impedance for the measuring instrument.
- b. Interconnecting cables that hang closer than 40 cm to the ground plane shall be folded back and forth in the center forming a bundle 30 to 40 cm long.
- c. I/O cables that are not connected to a peripheral shall be bundled in the center. The end of the cable may be terminated, if required, using the correct terminating impedance. The overall length shall not exceed 1 m.
- d. For the actual test configuration, please refer to the related Item –EUT Test Photos.

3.1.4 TEST SETUP

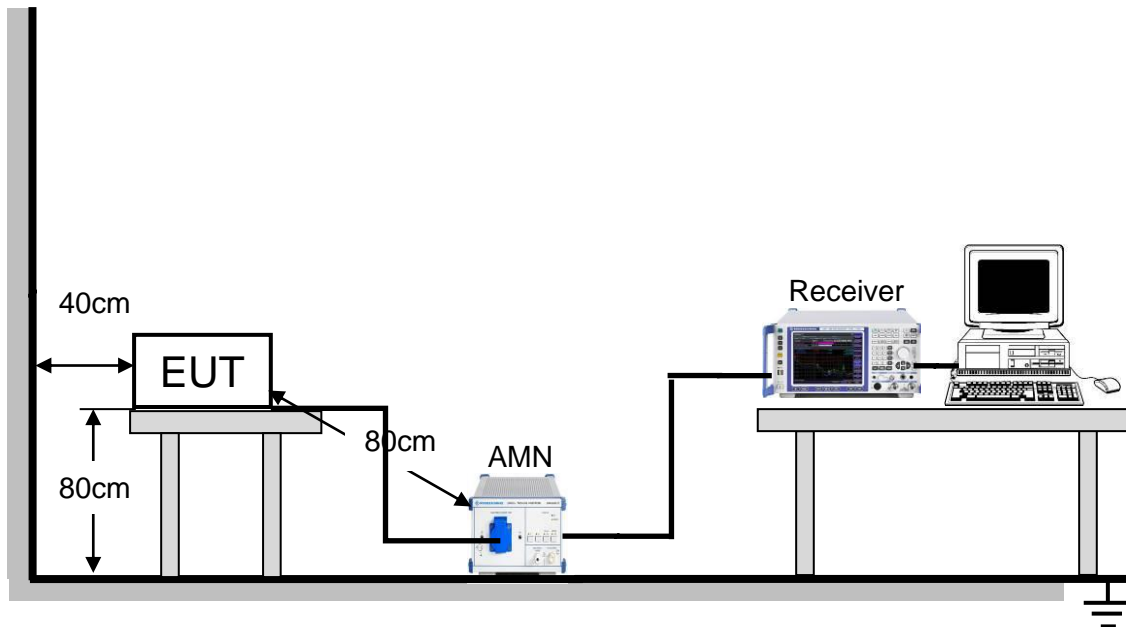

3.1.5 EUT OPERATING CONDITIONS

The EUT tested system was configured as the statements of **2.3** described unless otherwise a special operating condition is specified in the following during the testing.



3.1.6 TEST RESULTS

Project: LGT23D025	Test Engineer: Dylan.shi
EUT: Bluetooth Headphones	Temperature: 26.3°C
M/N: HS-BN928	Humidity: 60%RH
Test Voltage: AC 230V/50Hz	Test Data: 2023-04-12
Test Mode: Charging	
Note:	

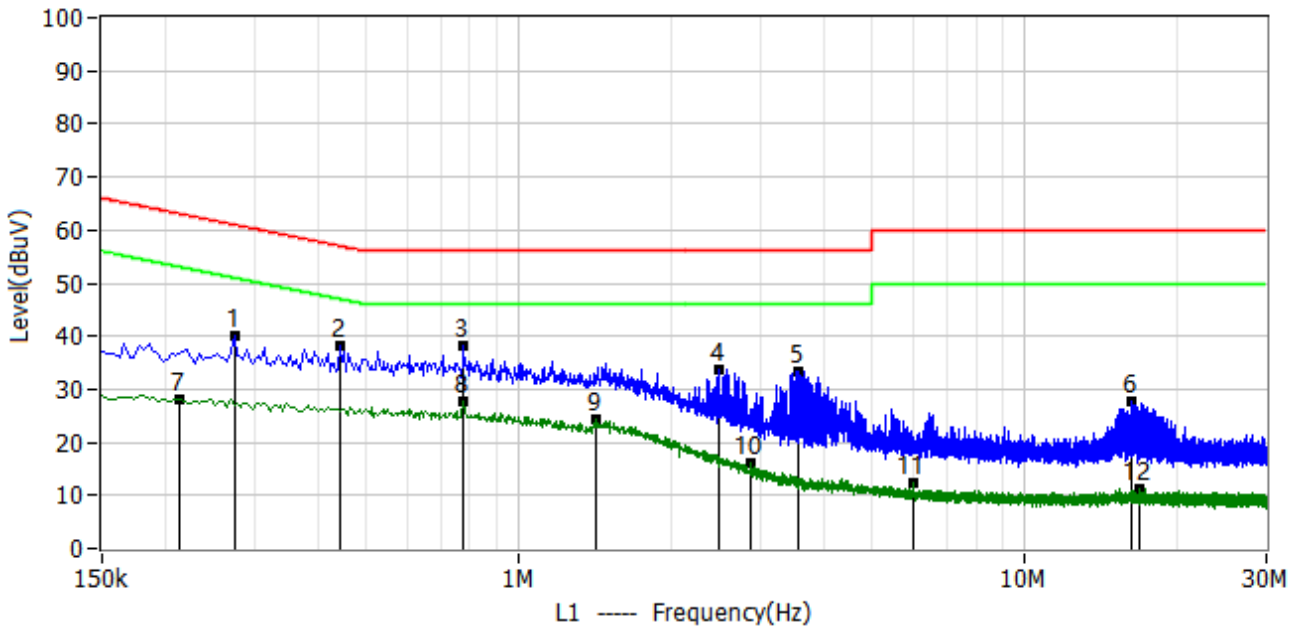

No.	Frequency	Reading dBuV	Factor dB	Level dBuV	Limit dBuV	Margin dB	Detector	Polar
1*	274.000kHz	29.34	10.59	39.93	61.00	-21.06	QP	L1
2*	442.000kHz	27.63	10.58	38.21	57.02	-18.82	QP	L1
3*	778.000kHz	27.49	10.58	38.07	56.00	-17.93	QP	L1
4*	2.494MHz	23.11	10.74	33.85	56.00	-22.15	QP	L1
5*	3.558MHz	22.79	10.72	33.51	56.00	-22.49	QP	L1
6*	16.202MHz	16.41	11.14	27.55	60.00	-32.45	QP	L1
7*	214.000kHz	17.59	10.60	28.19	53.05	-24.85	AV	L1
8*	774.000kHz	17.23	10.58	27.81	46.00	-18.19	AV	L1
9*	1.422MHz	13.77	10.66	24.43	46.00	-21.57	AV	L1
10*	2.866MHz	5.37	10.74	16.11	46.00	-29.89	AV	L1
11*	6.030MHz	1.56	10.73	12.29	50.00	-37.71	AV	L1
12*	16.766MHz	0.01	11.17	11.18	50.00	-38.82	AV	L1



Project: LGT23D025	Test Engineer: Dylan.shi
EUT: Bluetooth Headphones	Temperature: 26.3°C
M/N: HS-BN928	Humidity: 60%RH
Test Voltage: AC 230V/50Hz	Test Data: 2023-04-12
Test Mode: Charging	
Note:	

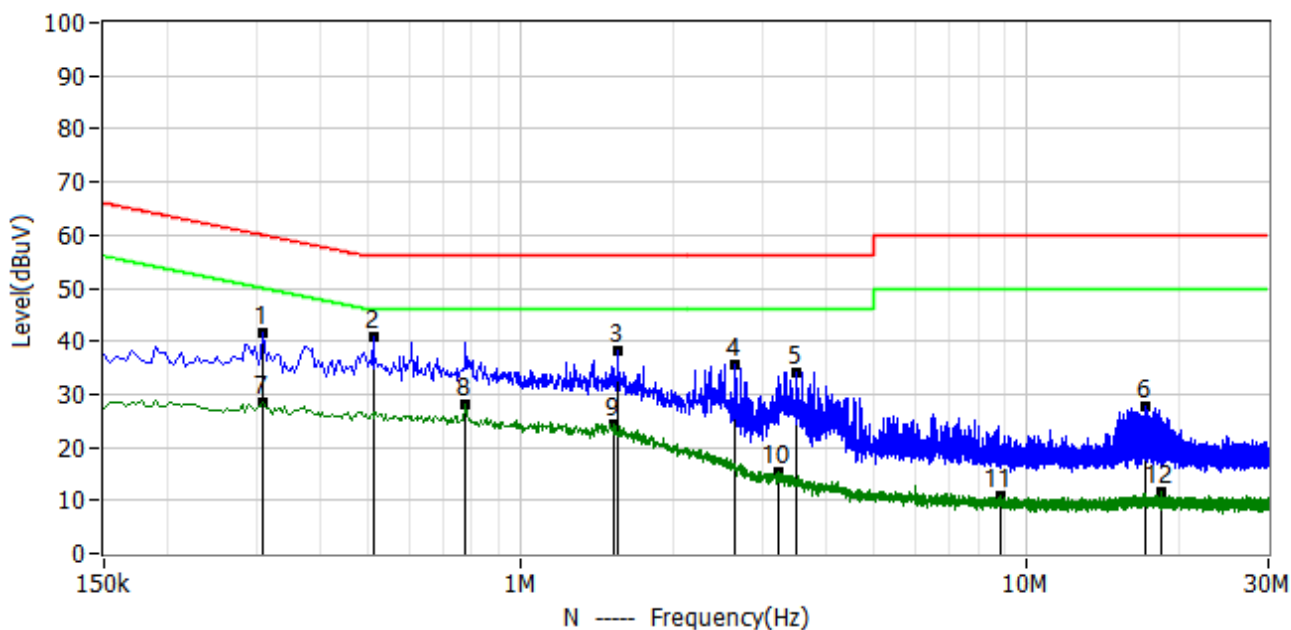

No.	Frequency	Reading dBuV	Factor dB	Level dBuV	Limit dBuV	Margin dB	Detector	Polar
1*	310.000kHz	31.09	10.59	41.68	59.97	-18.29	QP	N
2*	510.000kHz	30.14	10.58	40.72	56.00	-15.28	QP	N
3*	1.558MHz	27.49	10.68	38.17	56.00	-17.83	QP	N
4*	2.646MHz	24.73	10.74	35.47	56.00	-20.53	QP	N
5*	3.502MHz	23.53	10.73	34.26	56.00	-21.74	QP	N
6*	17.114MHz	16.48	11.25	27.73	60.00	-32.27	QP	N
7*	310.000kHz	17.69	10.59	28.28	49.97	-21.69	AV	N
8*	778.000kHz	17.63	10.58	28.21	46.00	-17.79	AV	N
9*	1.526MHz	13.83	10.67	24.50	46.00	-21.50	AV	N
10*	3.234MHz	4.44	10.73	15.17	46.00	-30.83	AV	N
11*	8.898MHz	0.15	10.86	11.01	50.00	-38.99	AV	N
12*	18.434MHz	0.22	11.30	11.52	50.00	-38.48	AV	N



3.2 RADIATED EMISSION MEASUREMENT

3.2.1 LIMITS OF THE RADIATED EMISSION MEASUREMENT

FREQUENCY (MHz)	Distance (m)	Detector type/ bandwidth	Class A	Class B
			dBuV/m	dBuV/m
30 ~ 230	3	Quasi peak/ 120 KHz	50	40
230 ~ 1000	3	Quasi peak/ 120 KHz	57	47
1000 ~ 3000	3	Peak /1 MHz	76	70
3000 ~ 6000	3	Peak /1 MHz	80	74
1000 ~ 3000	3	AV/1 MHz	56	50
3000 ~ 6000	3	AV/1 MHz	60	54

Notes:

- (1) The tighter limit applies at the band edges.
- (2) Emission level (dBuV/m) = 20log Emission level (uV/m).

3.2.3 TEST PROCEDURE

- a. The EUT was placed on the top of a rotating table 0.8 meter above the ground at a 3 meter semi-anechoic chamber room. The table was rotated 360 degrees to determine the position of the highest radiation.
- b. EUT as the center to the edge of the auxiliary device, the distance from the maximum edge to the center of the antenna is 3 meter.
- c. The height of antenna is varied from 1 meter to 4 meter above the ground to determine the maximum value of the field strength. Both horizontal and vertical polarizations of the antenna are set to make the measurement.
- d. For each suspected emission, the EUT was arranged to its worst case and then the antenna was tuned to heights from 1 meter to 4 meter and the rotatable table was turned from 0 degrees to 360 degree to find the maximum reading.
- e. The test-receiver system was set to quasi-peak detect function and specified bandwidth with maximum hold mode when the test frequency is below 1GHz.
- f. For the actual test configuration, please refer to the related Item –EUT Test Photos.

3.2.4 TEST SETUP

(A) Radiated Emission Test Set-Up Frequency Below 1 GHz

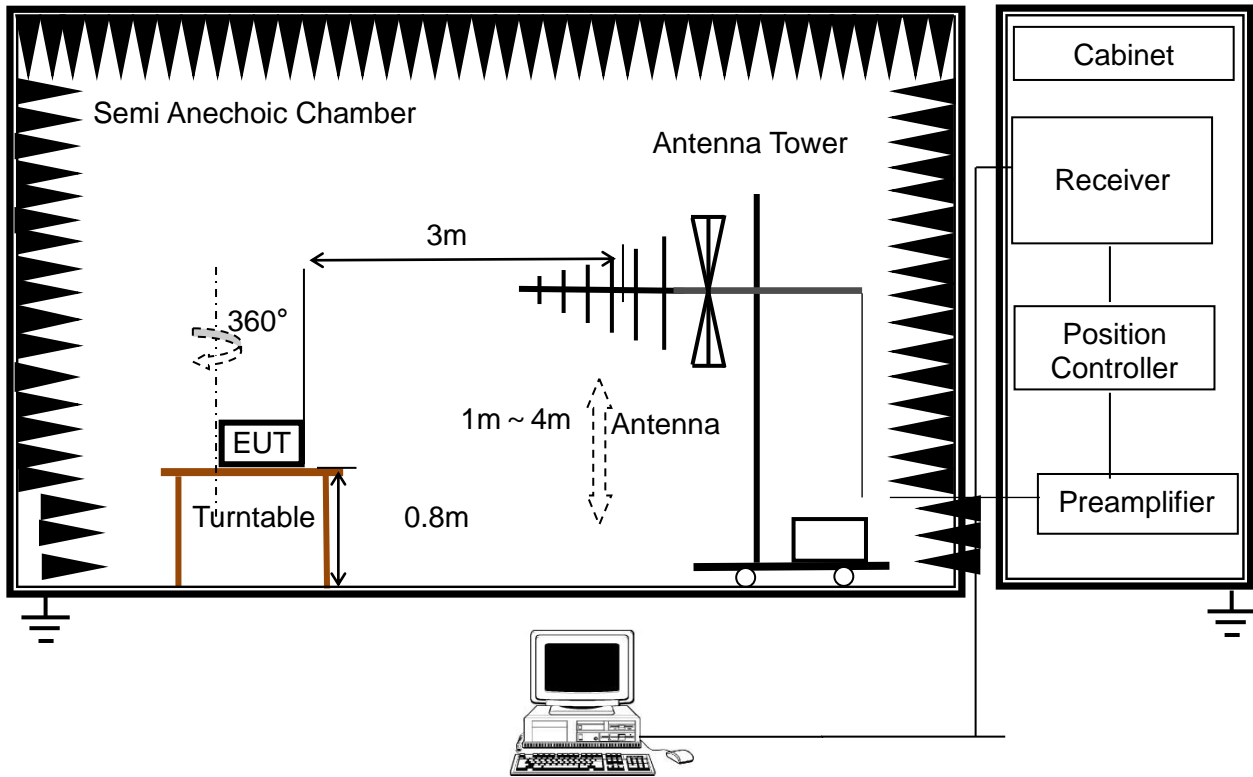

(B) Radiated Emission Test Set-Up Frequency Above 1GHz

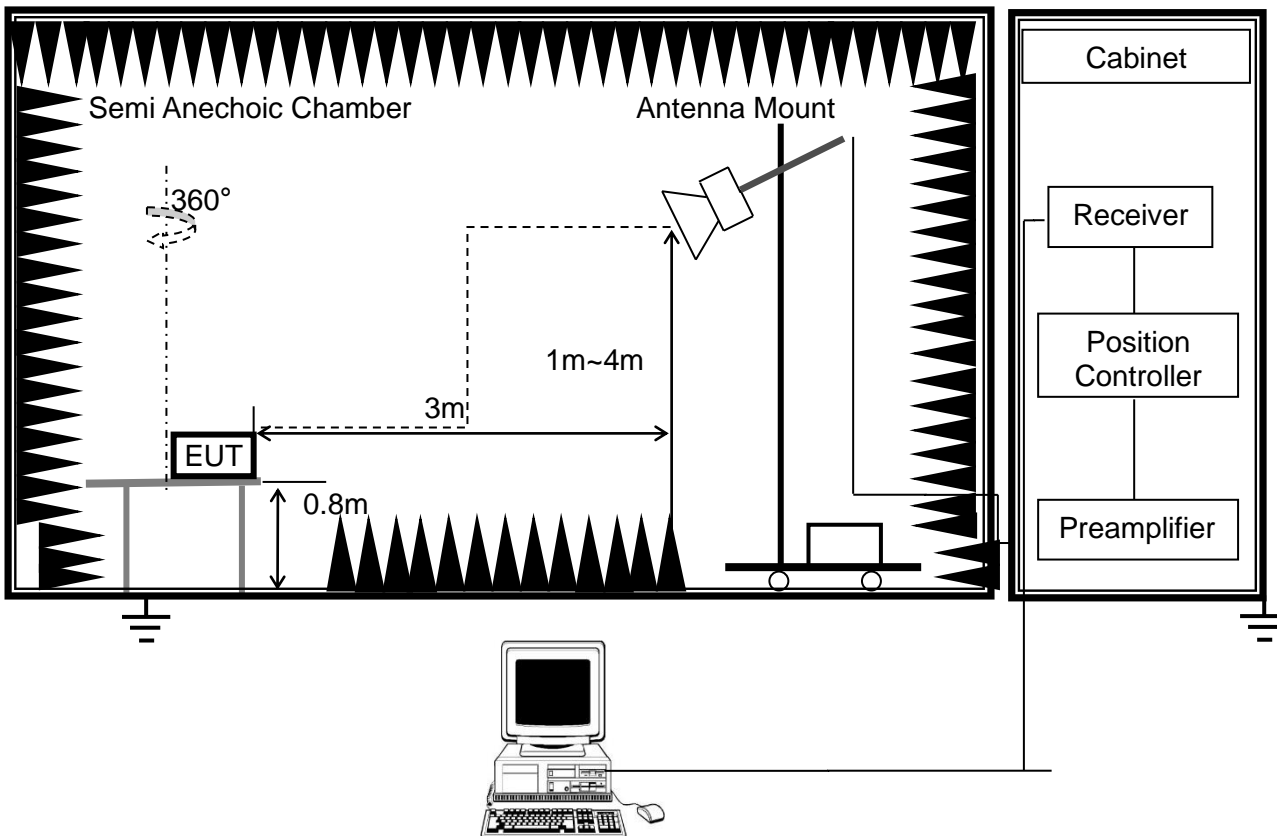



3.2.6 TEST RESULTS

Project: LGT23D025	Test Engineer: Dylan.shi
EUT: Bluetooth Headphones	Temperature: 28.3°C
M/N: HS-BN928	Humidity: 55%RH
Test Voltage: Battery	Test Data: 2023-04-12
Test Mode: Bluetooth	
Note:	

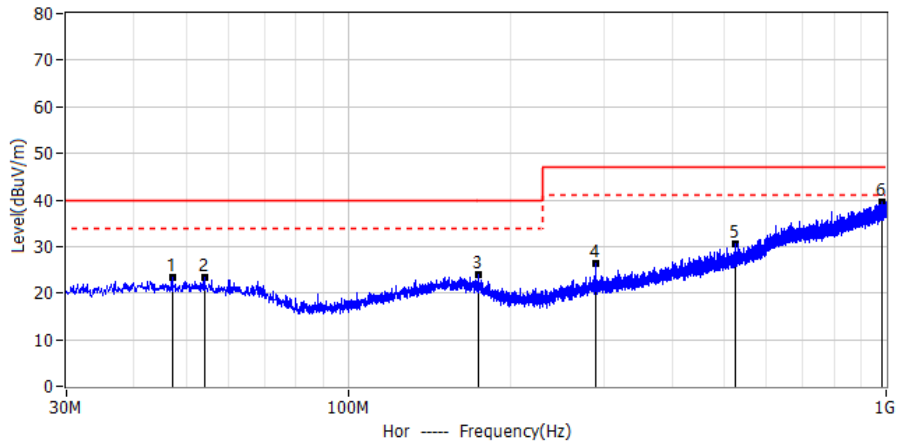

No.	Frequency	Reading dBuV	Factor dB/m	Level dBuV/m	Limit dBuV/m	Margin dB	Detector	Polar
1*	47.218MHz	4.03	19.28	23.31	40.00	-16.69	QP	Hor
2*	54.129MHz	4.20	19.06	23.26	40.00	-16.74	QP	Hor
3*	175.015MHz	4.55	19.31	23.86	40.00	-16.14	QP	Hor
4*	287.899MHz	6.76	19.67	26.43	47.00	-20.57	QP	Hor
5*	524.700MHz	4.97	25.51	30.48	47.00	-16.52	QP	Hor
6*	982.055MHz	5.17	34.49	39.66	47.00	-7.34	QP	Hor

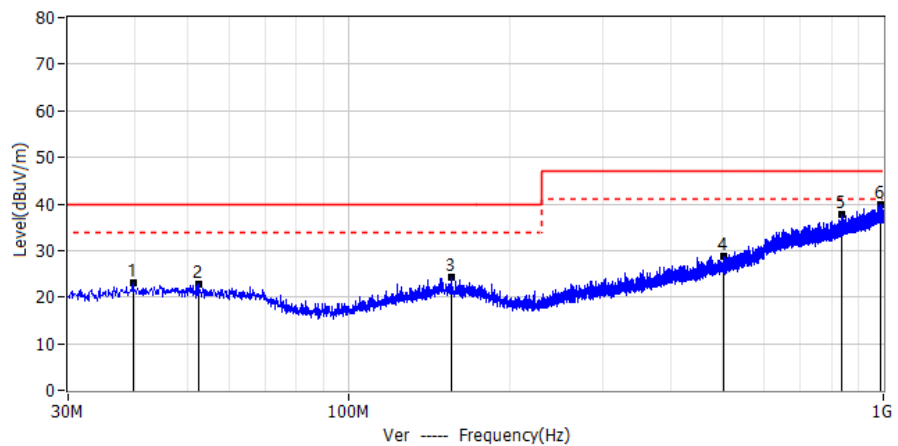

No.	Frequency	Reading dBuV	Factor dB/m	Level dBuV/m	Limit dBuV/m	Margin dB	Detector	Polar
1*	39.700MHz	3.83	19.33	23.16	40.00	-16.84	QP	Ver
2*	52.674MHz	3.74	19.17	22.91	40.00	-17.09	QP	Ver
3*	155.615MHz	4.28	19.91	24.19	40.00	-15.81	QP	Ver
4*	502.875MHz	3.89	24.92	28.81	47.00	-18.19	QP	Ver
5*	835.949MHz	5.72	32.01	37.73	47.00	-9.27	QP	Ver
6*	989.451MHz	5.32	34.52	39.84	47.00	-7.16	QP	Ver



Project: LGT23D025	Test Engineer: Dylan.shi
EUT: Bluetooth Headphones	Temperature: 28.3°C
M/N: HS-BN928	Humidity: 55%RH
Test Voltage: AC 230V/50Hz	Test Data: 2023-04-12
Test Mode: Charging	
Note:	

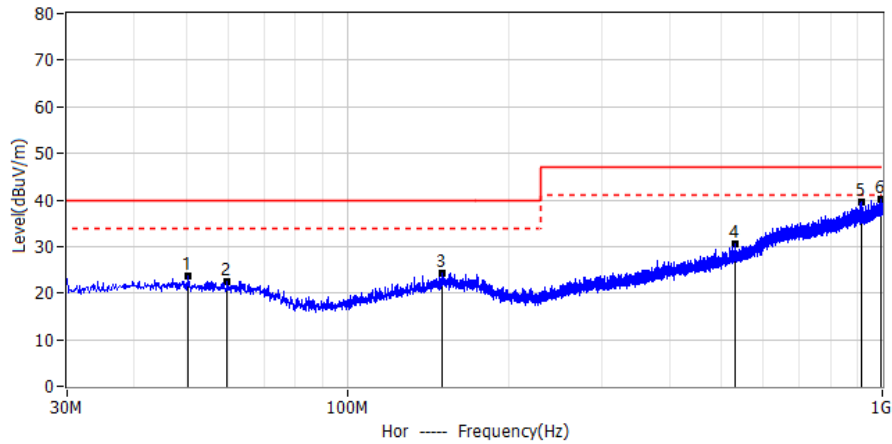

No.	Frequency	Reading dBuV	Factor dB/m	Level dBuV/m	Limit dBuV/m	Margin dB	Detector	Polar
1*	50.491MHz	4.32	19.32	23.64	40.00	-16.40	QP	Hor
2*	59.585MHz	3.83	18.67	22.50	40.00	-17.50	QP	Hor
3*	150.159MHz	4.26	19.99	24.25	40.00	-15.80	QP	Hor
4*	529.914MHz	4.97	25.65	30.62	47.00	-16.40	QP	Hor
5*	911.851MHz	6.20	33.30	39.50	47.00	-7.50	QP	Hor
6*	995.756MHz	5.58	34.55	40.13	47.00	-6.90	QP	Hor

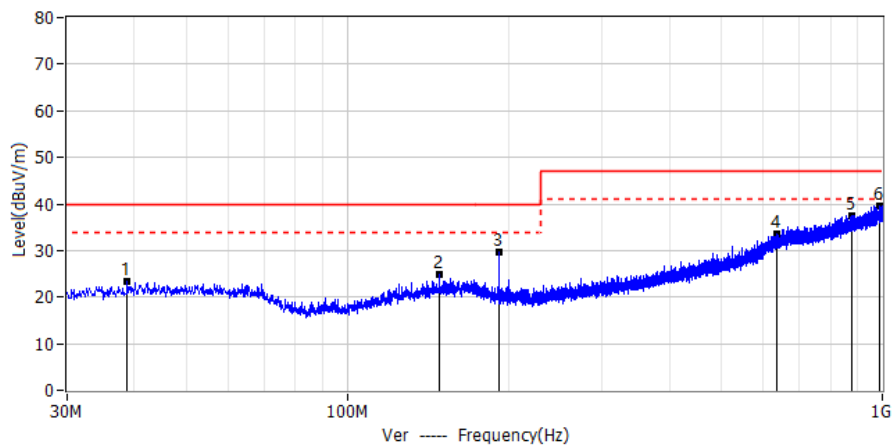

No.	Frequency	Reading dBuV	Factor dB/m	Level dBuV/m	Limit dBuV/m	Margin dB	Detector	Polar
1*	38.851MHz	4.08	19.19	23.27	40.00	-16.73	QP	Ver
2*	148.461MHz	5.16	19.85	25.01	40.00	-14.99	QP	Ver
3*	191.990MHz	11.97	17.57	29.54	40.00	-10.46	QP	Ver
4*	635.886MHz	4.68	28.88	33.56	47.00	-13.44	QP	Ver
5*	875.476MHz	4.66	32.89	37.55	47.00	-9.45	QP	Ver
6*	986.663MHz	5.04	34.51	39.55	47.00	-7.45	QP	Ver



Project: LGT23D025	Test Engineer: Dylan.shi
EUT: Bluetooth Headphones	Temperature: 28.3°C
M/N: HS-BN928	Humidity: 55%RH
Test Voltage: Battery	Test Data: 2023-04-12
Test Mode: Line in	
Note:	

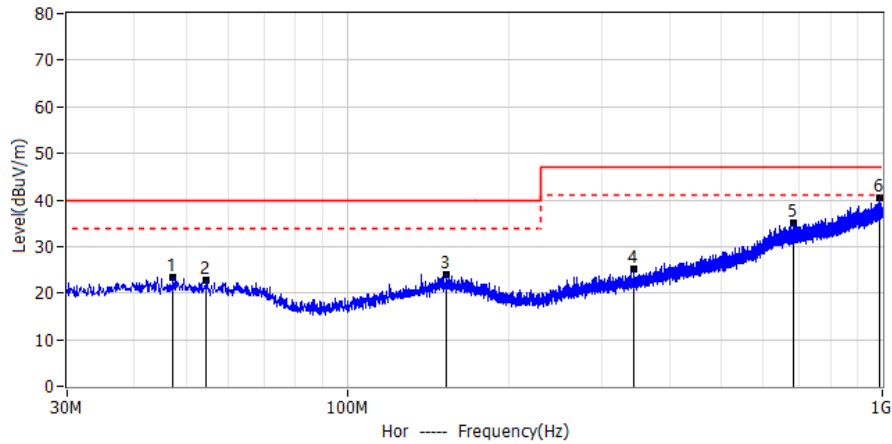

No.	Frequency	Reading dBuV	Factor dB/m	Level dBuV/m	Limit dBuV/m	Margin dB	Detector	Polar
1*	47.339MHz	4.22	19.29	23.51	40.00	-16.49	QP	Hor
2*	54.614MHz	3.89	19.03	22.92	40.00	-17.08	QP	Hor
3*	153.190MHz	3.97	19.94	23.91	40.00	-16.09	QP	Hor
4*	342.461MHz	4.23	21.04	25.27	47.00	-21.73	QP	Hor
5*	684.265MHz	5.49	29.64	35.13	47.00	-11.87	QP	Hor
6*	989.815MHz	6.07	34.52	40.59	47.00	-6.41	QP	Hor

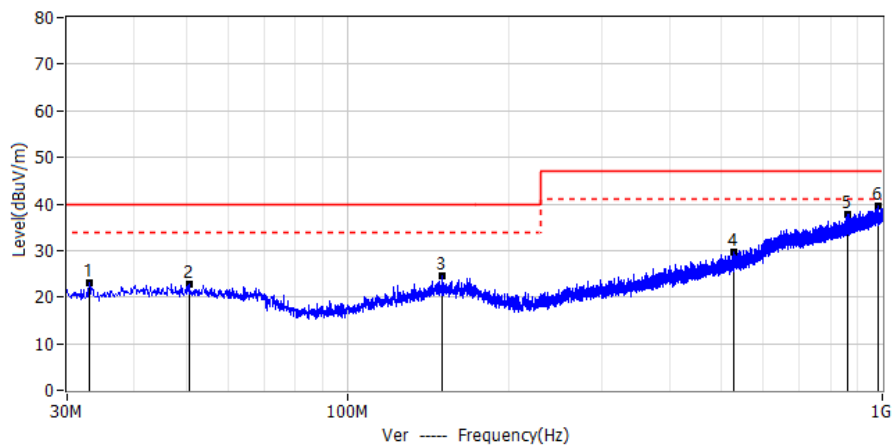

No.	Frequency	Reading dBuV	Factor dB/m	Level dBuV/m	Limit dBuV/m	Margin dB	Detector	Polar
1*	33.031MHz	4.74	18.41	23.15	40.00	-16.85	QP	Ver
2*	50.613MHz	3.45	19.32	22.77	40.00	-17.23	QP	Ver
3*	150.644MHz	4.47	19.98	24.45	40.00	-15.55	QP	Ver
4*	527.974MHz	4.08	25.60	29.68	47.00	-17.32	QP	Ver
5*	860.320MHz	5.20	32.56	37.76	47.00	-9.24	QP	Ver
6*	980.358MHz	5.05	34.48	39.53	47.00	-7.47	QP	Ver



Project: LGT23D025	Test Engineer: Dylan.shi
EUT: Bluetooth Headphones	Temperature: 22.5°C
M/N: HS-BN928	Humidity: 56%RH
Test Voltage: Battery	Test Data: 2023-04-12
Test Mode: Bluetooth	
Note:	

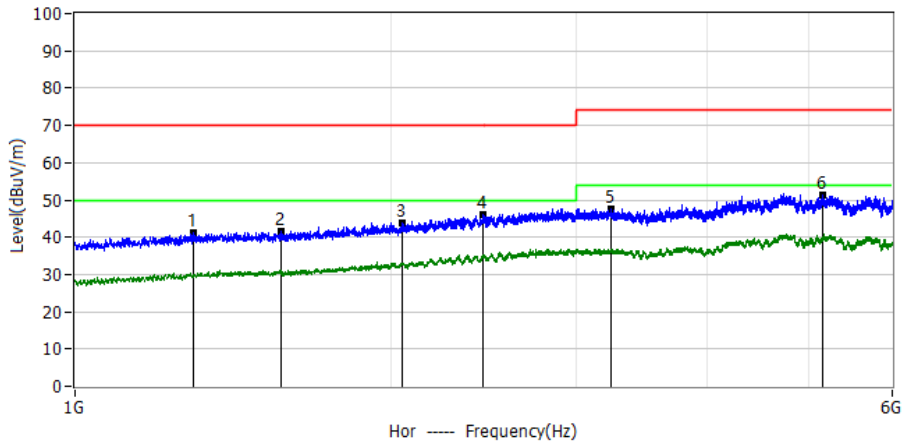

No.	Frequency	Reading dBuV	Factor dB/m	Level dBuV/m	Limit dBuV/m	Margin dB	Detector	Polar
1*	1.298GHz	63.33	-22.19	41.14	70.00	-28.86	PK	Hor
2*	1.569GHz	62.07	-20.38	41.69	70.00	-28.31	PK	Hor
3*	2.046GHz	59.57	-15.74	43.83	70.00	-26.17	PK	Hor
4*	2.444GHz	57.49	-11.58	45.91	70.00	-24.09	PK	Hor
5*	3.236GHz	56.12	-8.42	47.70	74.00	-26.30	PK	Hor
6*	5.144GHz	57.78	-6.60	51.18	74.00	-22.82	PK	Hor

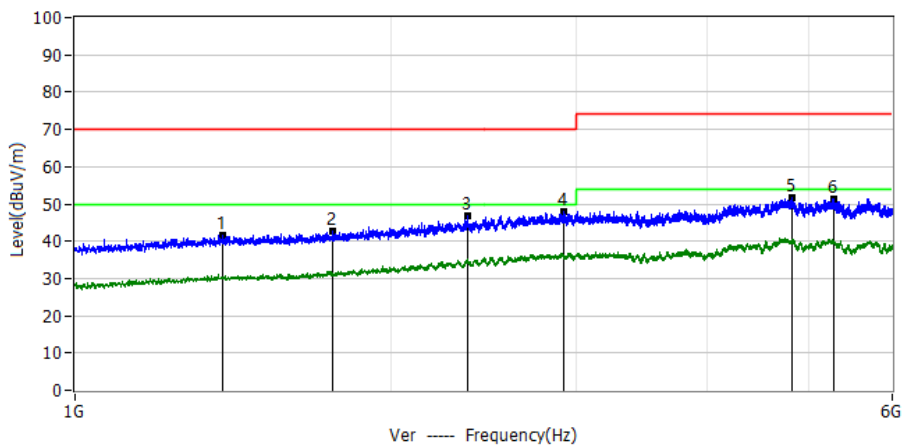

No.	Frequency	Reading dBuV	Factor dB/m	Level dBuV/m	Limit dBuV/m	Margin dB	Detector	Polar
1*	1.380GHz	63.21	-21.54	41.67	70.00	-28.33	PK	Ver
2*	1.757GHz	61.25	-18.67	42.58	70.00	-27.42	PK	Ver
3*	2.362GHz	59.08	-12.43	46.65	70.00	-23.35	PK	Ver
4*	2.916GHz	56.83	-8.79	48.04	70.00	-21.96	PK	Ver
5*	4.813GHz	57.53	-6.00	51.53	74.00	-22.47	PK	Ver
6*	5.281GHz	58.53	-7.04	51.49	74.00	-22.51	PK	Ver



Project: LGT23D025	Test Engineer: Dylan.shi
EUT: Bluetooth Headphones	Temperature: 22.5°C
M/N: HS-BN928	Humidity: 56%RH
Test Voltage: AC 230V/50Hz	Test Data: 2023-04-12
Test Mode: Charging	
Note:	

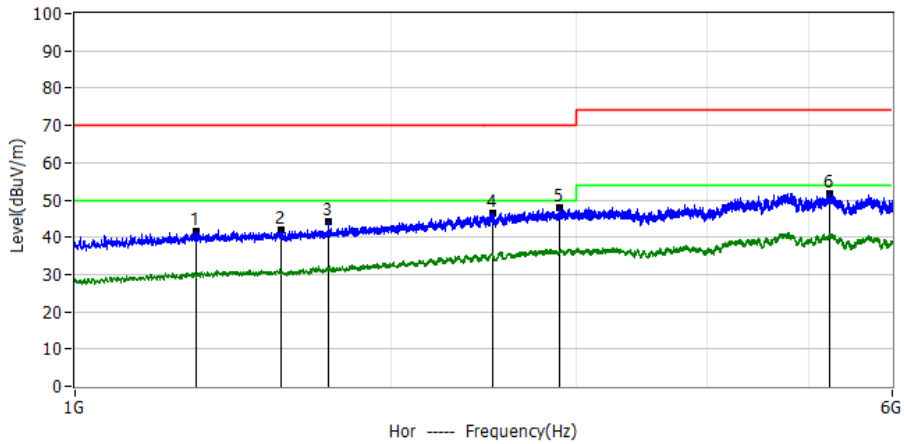

No.	Frequency	Reading dBuV	Factor dB/m	Level dBuV/m	Limit dBuV/m	Margin dB	Detector	Polar
1*	1.306GHz	63.76	-22.13	41.63	70.00	-28.37	PK	Hor
2*	1.573GHz	62.43	-20.36	42.07	70.00	-27.93	PK	Hor
3*	1.744GHz	62.98	-18.80	44.18	70.00	-25.82	PK	Hor
4*	2.497GHz	57.60	-11.02	46.58	70.00	-23.42	PK	Hor
5*	2.889GHz	56.69	-8.93	47.76	70.00	-22.24	PK	Hor
6*	5.229GHz	58.66	-6.87	51.79	74.00	-22.21	PK	Hor

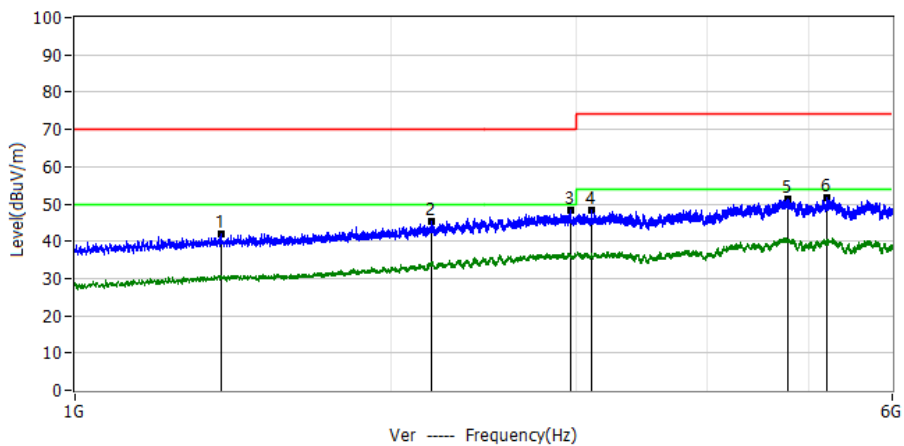

No.	Frequency	Reading dBuV	Factor dB/m	Level dBuV/m	Limit dBuV/m	Margin dB	Detector	Polar
1*	1.378GHz	63.46	-21.56	41.90	70.00	-28.10	PK	Ver
2*	2.184GHz	59.55	-14.30	45.25	70.00	-24.75	PK	Ver
3*	2.961GHz	56.70	-8.55	48.15	70.00	-21.85	PK	Ver
4*	3.107GHz	56.64	-8.38	48.26	74.00	-25.74	PK	Ver
5*	4.771GHz	57.43	-5.96	51.47	74.00	-22.53	PK	Ver
6*	5.204GHz	58.55	-6.79	51.76	74.00	-22.24	PK	Ver



Project: LGT23D025	Test Engineer: Dylan.shi
EUT: Bluetooth Headphones	Temperature: 22.5°C
M/N: HS-BN928	Humidity: 56%RH
Test Voltage: Battery	Test Data: 2023-04-12
Test Mode: Line in	
Note:	

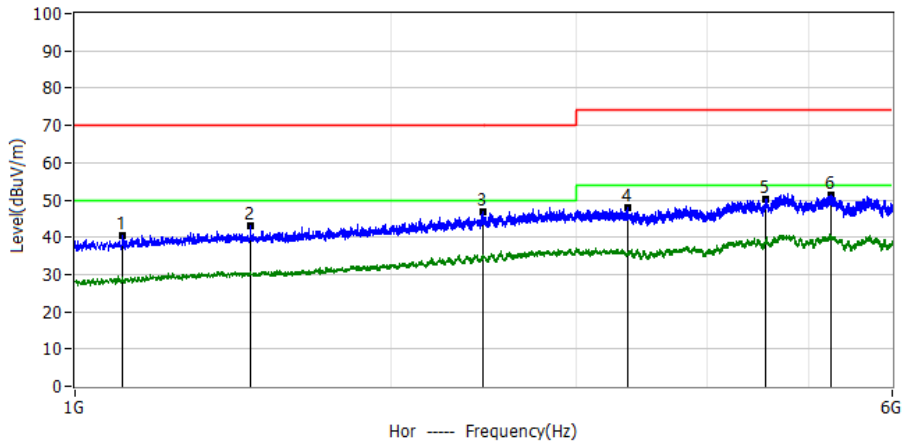

No.	Frequency	Reading dBuV	Factor dB/m	Level dBuV/m	Limit dBuV/m	Margin dB	Detector	Polar
1*	1.109GHz	64.18	-23.77	40.41	70.00	-29.59	PK	Hor
2*	1.471GHz	64.10	-21.00	43.10	70.00	-26.90	PK	Hor
3*	2.444GHz	58.24	-11.57	46.67	70.00	-23.33	PK	Hor
4*	3.364GHz	56.32	-8.46	47.86	74.00	-26.14	PK	Hor
5*	4.546GHz	55.96	-5.79	50.17	74.00	-23.83	PK	Hor
6*	5.252GHz	58.13	-6.95	51.18	74.00	-22.82	PK	Hor

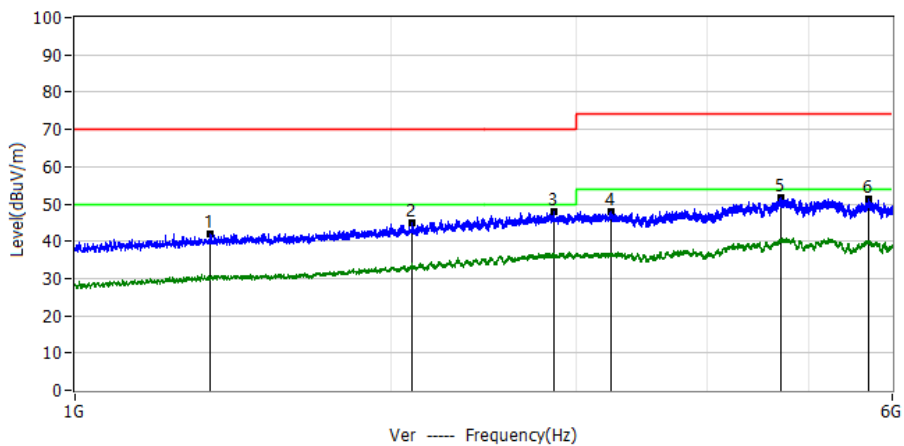

No.	Frequency	Reading dBuV	Factor dB/m	Level dBuV/m	Limit dBuV/m	Margin dB	Detector	Polar
1*	1.344GHz	63.86	-21.83	42.03	70.00	-27.97	PK	Ver
2*	2.091GHz	60.07	-15.27	44.80	70.00	-25.20	PK	Ver
3*	2.856GHz	56.90	-9.10	47.80	70.00	-22.20	PK	Ver
4*	3.235GHz	56.43	-8.42	48.01	74.00	-25.99	PK	Ver
5*	4.698GHz	57.47	-5.91	51.56	74.00	-22.44	PK	Ver
6*	5.694GHz	58.86	-7.66	51.20	74.00	-22.80	PK	Ver



3.3 HARMONICS CURRENT

3.3.1 LIMITS OF THE HARMONICS CURRENT

IEC 555-2					
Table - I			Table - II		
Equipment Category	Harmonic Order n	Max. Permissible Harmonic Current (in Amperes)	Equipment Category	Harmonic Order n	Max. Permissible Harmonic Current (in Amperes)
Non Portable Tools or TV Receivers	Odd Harmonics		TV Receivers	Odd Harmonics	
	3	2.30		3	0.80
	5	1.14		5	0.60
	7	0.77		7	0.45
	9	0.40		9	0.30
	11	0.33		11	0.17
	13	0.21		13	0.12
	15 ≤ n ≤ 39	0.15 · 15/n		15 ≤ n ≤ 39	0.10 · 15/n
	Even Harmonics			Even Harmonics	
	2	1.08		2	0.30
4	0.43	4	0.15		
8	0.30				
8 ≤ n ≤ 40	0.23 · 8/n	DC	0.05		

EN 61000-3-2/IEC 61000-3-2					
Equipment Category	Max. Permissible Harmonic Current (in Amperes)	Equipment Category	Harmonic Order n	Max. Permissible Harmonic Current (in A) (mA/w)	
Class A	Same as Limits Specified in 4-2.1, Table - I, but only odd harmonics required	Class D	3	2.30	3.4
			5	1.14	1.9
			7	0.77	1.0
			9	0.40	0.5
			11	0.33	0.35
			13 ≤ n ≤ 39	see Table I	3.85/n
only odd harmonics required					



3.3.2 TEST PROCEDURE

- a. The EUT was placed on the top of a wooden table 0.8 meter above the ground and operated to produce the maximum harmonic components under normal operating conditions.
- b. The classification of EUT is according to section 5 of EN IEC 61000-3-2. The EUT is classified as follows:
 - Class A: Balanced three-phase equipment, Household appliances excluding equipment as Class D, Tools excluding portable tools, Dimmers for incandescent lamps, audio equipment, equipment not specified in one of the three other classes.
 - Class B: Portable tools. Portable tools; Arc welding equipment which is not professional equipment.
 - Class C: Lighting equipment.
 - Class D: Equipment having a specified power less than or equal to 600W of the following types: Personal computers and personal computer monitors and television receivers.
- c. The correspondent test program of test instrument to measure the current harmonics emanated from EUT is chosen. The measure time shall be not less than the time necessary for the EUT to be exercised.

3.3.3 EUT OPERATING CONDITIONS

The EUT tested system was configured as the statements of **2.3** described unless otherwise a special operating condition is specified in the following during the testing.

3.3.4 TEST SETUP

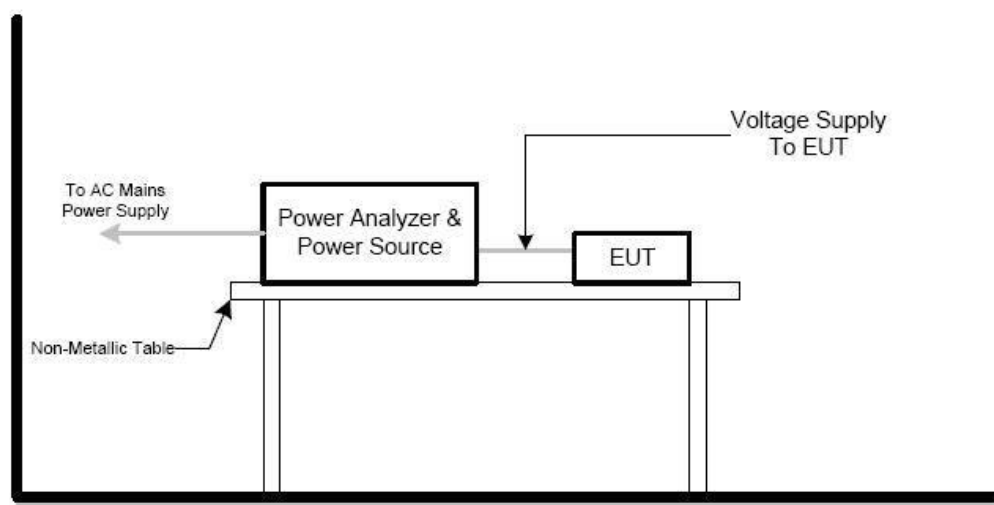

3.3.5 TEST RESULTS

N/A. This part is applicable to the power input terminals of equipment intended to be connected to 220/380 V, 230/400 V and 240/415 V systems operating at 50 Hz or 60 Hz. Requirements and limits for other cases are not yet specified.



3.4 VOLTAGE FLUCTUATION AND FLICKERS

3.4.1 LIMITS OF THE VOLTAGE FLUCTUATION AND FLICKERS

Tests	Measurement Value	Limit	Descriptions
	IEC555-3	IEC/EN 61000-3-3	
P_{st}	$\leq 1.0, T_p = 10 \text{ min.}$	$\leq 1.0, T_p = 10 \text{ min.}$	Short Term Flicker Indicator
P_{lt}	N/A	$\leq 0.65, T_p = 2 \text{ hr.}$	Long Term Flicker Indicator
$T_{dt(s)}$	$\leq 3\%$	$\leq 3.3\%$	Relative Steady-State V-Chang
$d_{max}(\%)$	$\leq 4\%$	$\leq 4\%$	Maximum Relative V-Chang
$d_c(\%)$	N/A	$\leq 3.3\%$ for $> 500\text{ms}$	Relative V-change Characteristic

3.4.2 TEST PROCEDURE

a. Fluctuation and Flickers Test:

Tests was performed according to the Test Conditions/Assessment of Voltage Fluctuations specified in Clause 5.0/6.0 of IEC555-3 and/or Clause 6.0/4.0 of IEC/EN 61000-3-3 depend on which standard adopted for compliance measurement.

b. All types of voltage fluctuation in this report are assessed by direct measurement using flicker-meter.

3.4.3 EUT OPERATING CONDITIONS

The EUT tested system was configured as the statements of 2.3 described unless otherwise a special operating condition is specified in the following during the testing.

3.4.4 TEST SETUP

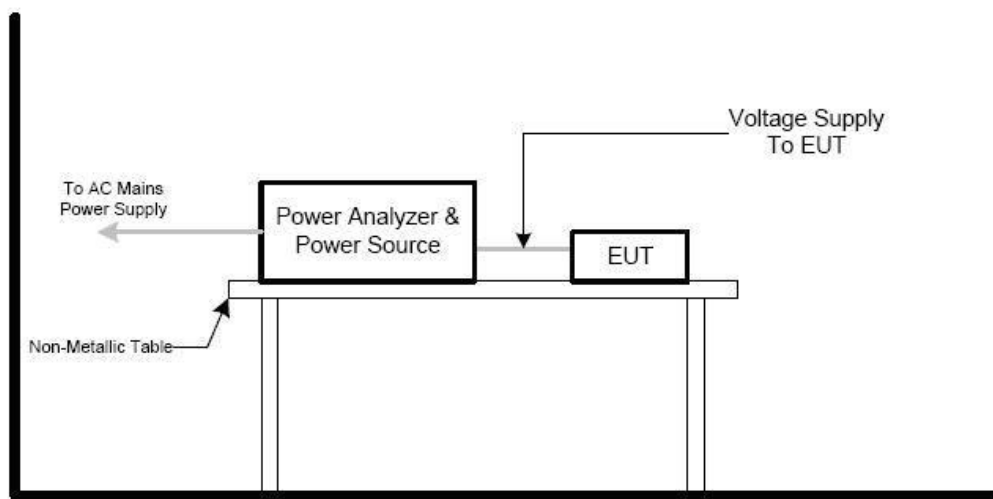

3.4.5 TEST RESULTS

N/A. This part is applicable to electrical and electronic equipment having an input current equal to or less than 16 A per phase, intended to be connected to public low-voltage distribution systems of between 220 V and 250 V line to neutral at 50 Hz, and not subject to conditional connection.



4. EMC IMMUNITY TEST

4.1 STANDARD COMPLIANCE/SERVIRITY LEVEL/CRITERIA

Tests Standard No.	TEST SPECIFICATION	Test Mode Test Ports	Perform. Criteria
1. ESD IEC/EN 61000-4-2	8KV air discharge 4KV contact discharge	Direct Mode	B
	4KV HCP discharge 4KV VCP discharge	Indirect Mode	B
2. RS IEC/EN 61000-4-3	80 MHz - 1000 MHz, 1800MHz, 2600MHz, 3500MHz, 5000MHz, 1000Hz, 80%, AM modulated	Enclosure	A
3. EFT/Burst IEC/EN 61000-4-4	5/50ns Tr/Th 5KHz Repetition Freq.	Power Supply Port	B
	5/50ns Tr/Th 5KHz Repetition Freq.	CTL/Signal Data Line Port	B
4. Surges IEC/EN 61000-4-5	1.2/50(8/20) Tr/Th us	L-N	B
	1.2/50(8/20) Tr/Th us	L-PE N-PE	B
5. Injected Current IEC/EN 61000-4-6	0.15 MHz to 80 MHz, 1000Hz 80 % , AM Modulated 150Ω source impedance	CTL/Signal Port	A
	0.15 MHz to 80 MHz, 1000Hz 80 % , AM Modulated 150Ω source impedance	AC Power Port	A
	0.15 MHz to 80 MHz, 1000Hz 80 % , AM Modulated 150Ω source impedance	DC Power Port	A
6. Power Frequency Magnetic Field IEC/EN 61000-4-8	50 Hz,	Enclosure	A
7. Volt. Interruptions Volt. Dips IEC/EN 61000-4-11	Voltage dip 100%	AC Power Port	B
	Voltage dip 30%		C
	Interruption 100%		C



4.2 GENERAL PERFORMANCE CRITERIA

According to **EN 55035** standard, the general performance criteria are as follows:

Criterion A	The equipment shall continue to operate as intended without operator intervention. No degradation of performance, loss of function or change of operating state is allowed below a performance level specified by the manufacturer when the equipment is used as intended. The performance level may be replaced by a permissible loss of performance. If the minimum performance level or the permissible performance loss is not specified by the manufacturer, then either of these may be derived from the product description and documentation, and by what the user may reasonably expect from the equipment if used as intended.
Criterion B	During the application of the disturbance, degradation of performance is allowed. However, no unintended change of actual operating state or stored data is allowed to persist after the test. After the test, the equipment shall continue to operate as intended without operator intervention; no degradation of performance or loss of function is allowed, below a performance level specified by the manufacturer, when the equipment is used as intended. The performance level may be replaced by a permissible loss of performance. If the minimum performance level (or the permissible performance loss), or recovery time, is not specified by the manufacturer, then either of these may be derived from the product description and documentation, and by what the user may reasonably expect from the equipment if used as intended.
Criterion C	Loss of function is allowed, provided the function is self-recoverable, or can be restored by the operation of the controls by the user in accordance with the manufacturer's instructions. A reboot or re-start operation is allowed. Information stored in non-volatile memory, or protected by a battery backup, shall not be lost.

4.2.1 GENERAL PERFORMANCE CRITERIA TEST SETUP

The EUT tested system was configured as the statements of **2.2** or **2.3** unless otherwise a special operating condition is specified in the following during the testing.



4.3 ELECTROSTATIC DISCHARGE IMMUNITY TEST (ESD)

4.3.1 TEST SPECIFICATION

Basic Standard:	IEC/EN 61000-4-2
Discharge Impedance:	330 ohm / 150 pF
Required Performance:	B
Discharge Voltage:	Air Discharge: 2KV/4KV/8KV (Direct) Contact Discharge: 4KV (Direct/Indirect)
Polarity:	Positive & Negative
Number of Discharge:	Air Discharge: at least 10 times on each point Contact Discharge: at least 10 times on each point 20 times at each test point
Discharge Mode:	Single Discharge
Discharge Period:	1 second minimum

4.3.2 TEST PROCEDURE

The test generator necessary to perform direct and indirect application of discharges to the EUT in the following manners:

- a. Electrostatic discharges were applied only to those points and surfaces of the EUT that are accessible to users during normal operation
The test was performed with at least ten single discharges on the pre-selected points in the most sensitive polarity.

The time interval between two successive single discharges was at least 1 second.

The ESD generator was held perpendicularly to the surface to which the discharge was applied and the return cable was at least 0.2 meter from the EUT.

Contact discharges were applied to the non-insulating coating, with the pointed tip of the generator penetrating the coating and contacting the conducting substrate.

Air discharges were applied with the round discharge tip of the discharge electrode approaching the EUT as fast as possible (without causing mechanical damage) to touch the EUT. After each discharge, the ESD generator was removed from the EUT and re-triggered for a new single discharge. The test was repeated until all discharges were complete.

Vertical Coupling Plane (VCP):

The coupling plane of dimensions 0.5m x 0.5m, is placed parallel to and positioned at a distance 0.1m from the EUT, with the Discharge Electrode touching the coupling plane.

The four faces of the EUT will be performed with electrostatic discharge.

Horizontal Coupling Plane (HCP):

The coupling plane is placed under to the EUT. The generator shall be positioned vertically at a distance of 0.1m from the EUT, with the Discharge Electrode touching the coupling plane.

The four faces of the EUT will be performed with electrostatic discharge.

- b. Air discharges at insulation surfaces of the EUT.
It was at least ten single discharges with positive and negative at the same selected point.



4.3.3 TEST SETUP

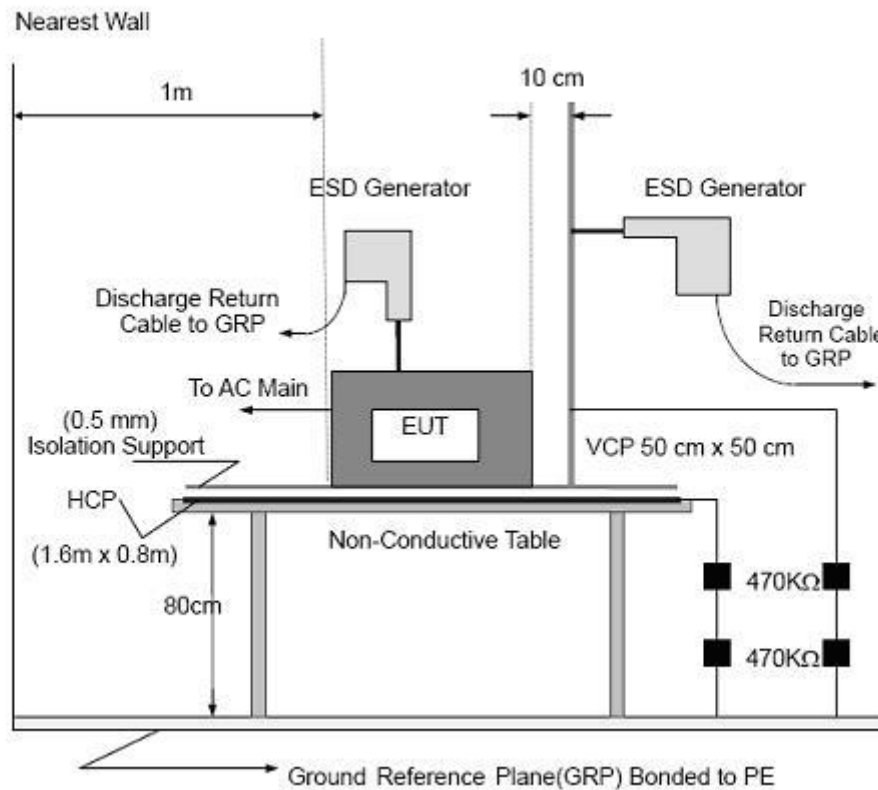

Note:

TABLE-TOP EQUIPMENT

The configuration consisted of a wooden table 0.8 meter high standing on the Ground Reference Plane. The GRP consisted of a sheet of aluminum at least 0.25mm thick. A Horizontal Coupling Plane (1.6m x 0.8m) was placed on the table and attached to the GRP by means of a cable with 940k Ω total impedance. The equipment under test was installed in a representative system as described in section 7 of IEC /EN 61000-4-2, and its cables were placed on the HCP and isolated by an insulating support of 0.5mm thickness. A distance of 0.8-meter minimum was provided between the EUT and the walls of the laboratory and any other metallic structure.



FLOOR-STANDING EQUIPMENT

The equipment under test was installed in a representative system as described in section 7 of IEC/EN 61000-4-2, and its cables were isolated from the Ground Reference Plane by an insulating support of 0.1 meter thickness. The GRP was consisted of a sheet of aluminum that is at least 0.25mm thick, and extended at least 0.5 meter from the EUT on all sides.



4.3.4 TEST RESULTS

Temperature:	24.4°C	Relative Humidity:	58%
Pressure:	1017.8hPa	Test Date:	2023.04.14

Discharge times	Contact discharge: minimum 10 times (+/--respectively) at each point Air discharge: minimum 10 times (+/- respectively) at each point					
Discharge Level/KV	Polarity	Test Points	Contact Discharge	Air Discharge	Criterion	Test Result
2,4	+/-	HCP/VCP	A	NA	B	Pass
2,4,	+/-	Green Dot	A	NA	B	Pass
2,4,8	+/-	Red Dot	NA	A	B	Pass
Note 1: EUT operate as intended during the test Normal performance within limits specified by the manufacturer, request or purchaser						
Note 2:  Red Dot_Air Discharged,  Green Dot_Contact Discharged						

The Photo for Discharge Points of EUT





4.4 RADIATED, RADIO-FREQUENCY, ELECTROMAGNETIC FIELD IMMUNITY TEST (RS)

4.4.1 TEST SPECIFICATION

Basic Standard:	IEEN 61000-4-3
Required Performance:	A
Test Frequency Range:	80 MHz-1000 MHz, 1800MHz, 2600MHz, 3500MHz, 5000MHz
Primary Function Of Telephony Test Frequencies:	80 MHz; 120 MHz; 160 MHz; 230 MHz; 434 MHz; 460 MHz; 600 MHz; 863 MHz and 900 MHz
Field Strength:	3 V/m
Modulation:	1kHz Sine Wave, 80%, AM Modulation
Frequency Step:	1 % of fundamental
Polarity of Antenna:	Horizontal and Vertical
Test Distance:	3 m
Antenna Height:	1.5 m
Dwell Time:	1.5×10^{-3} decade/s

4.4.2 TEST PROCEDURE

- a. The testing was performed in a fully anechoic chamber. The transmit antenna was located at a distance of 3 meters from the EUT.
- b. The frequency range is swept from 80 MHz to 1000 MHz, 1800MHz, 2600MHz, 3500MHz, 5000MHz, with the signal 80% amplitude modulated with a 1kHz sine-wave. The rate of sweep did not exceed 1.5×10^{-3} decade/s, where the frequency range is swept incrementally, the step size was 1% of preceding frequency value.
- c. The dwell time at each frequency shall be not less than the time necessary for the EUT to be able to respond.
- e. The test was performed with the EUT exposed to both vertically and horizontally polarized fields on each of the four sides.

4.4.3 TEST SETUP

(A) RS Test Set-Up Frequency Below 1GHz

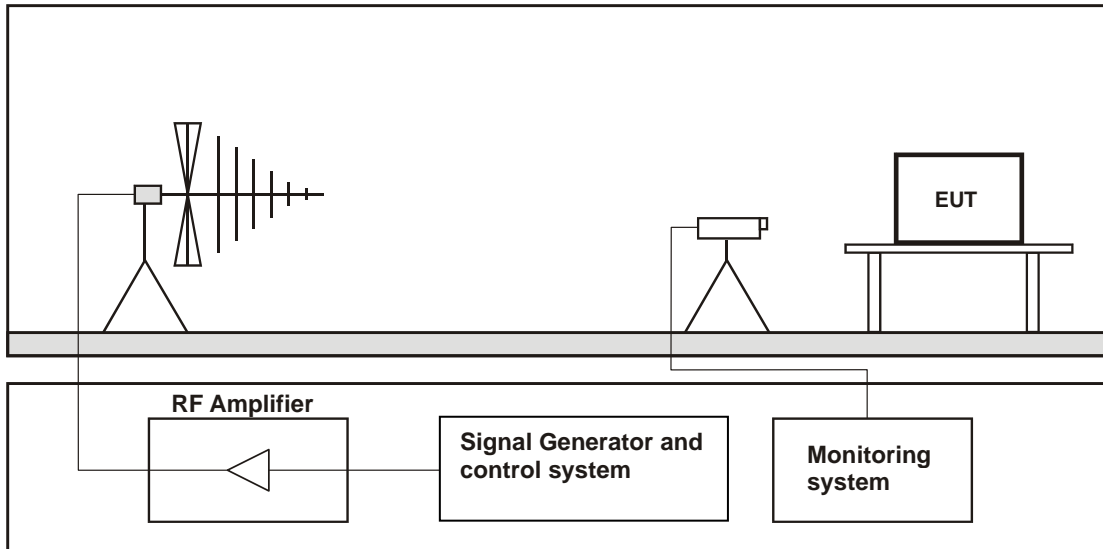

(B) RS Test Set-Up Frequency Above 1GHz

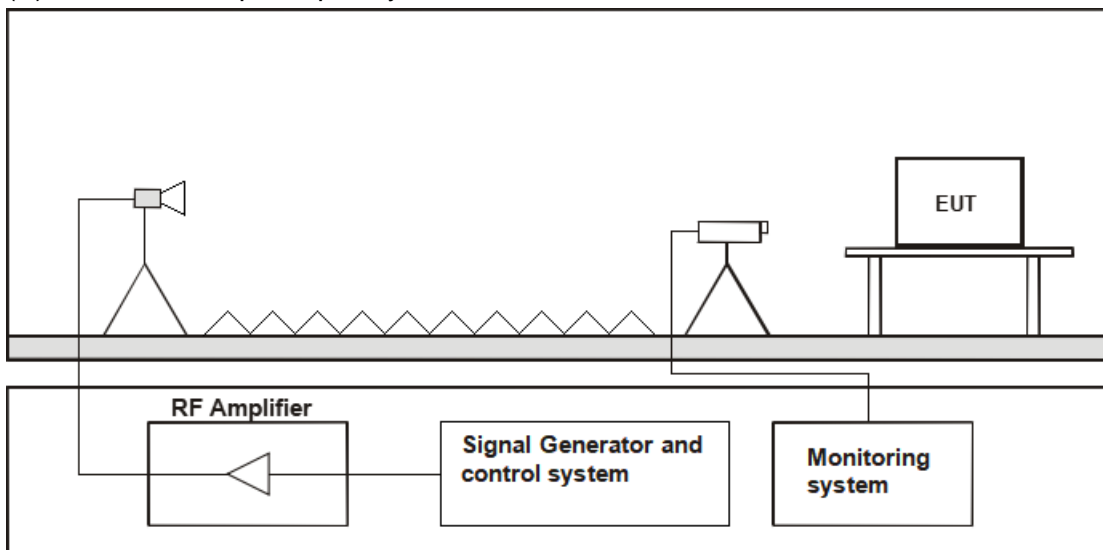

Note:

TABLE-TOP EQUIPMENT

The EUT installed in a representative system as described in section 7 of IEC/EN 61000-4-3 was placed on a non-conductive table 0.8 meter in height. The system under test was connected to the power and signal wire according to the relevant installation instructions.

FLOOR-STANDING EQUIPMENT

The EUT installed in a representative system as described in section 7 of IEC/EN 61000-4-3 was placed on a non-conductive wood support 0.1 meter in height. The system under test was connected to the power and signal wire according to the relevant installation instructions.

For Audio output function use below setting

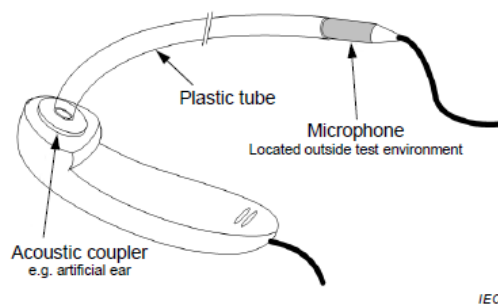

NOTE 1 The microphone is connected via the cable to a suitable amplifier.

NOTE 2 This setup is suitable for radiated immunity testing. See G.6.3

Figure G.5 – Example test setup for on-ear acoustic measurements, microphone located away from earpiece transducer



4.4.4 TEST RESULTS

Temperature:	24.4°C	Relative Humidity:	58%
Test Power:	AC 230V/50Hz	Test Date:	2023.04.14

Test Level	3 V r.m.s. (unmodulated) 1 kHz, 80 % AM, sine wave		Criterion	A
Frequency Range(MHz)	Antenna polarity	Modulation	EUT position	Result
80MH-1000MHz	Horizontal Vertical	1KHz, 80% AM	Front	PASS
			Rear	PASS
			Left	PASS
			Right	PASS
1000MHz-6000MHz	Horizontal Vertical	1KHz, 80% AM	Front	PASS
			Rear	PASS
			Left	PASS
			Right	PASS

Note: EUT operate as intended during the test Normal performance within limits specified by the manufacturer, request or purchaser

Note: According to EN 55035, Annex A, A.2 Applicability, the EUT belongs to Group 2. And then according to EN 55035, Annex A, A.4 Modified test levels and performance criteria, Table A.2 – Modified test levels for performance criterion A for the broadcast reception function, no test requirements apply to this EUT.



4.5 ELECTRICAL FAST TRANSIENT (EFT)

4.5.1 TEST SPECIFICATION

Basic Standard:	IEC/EN 61000-4-4
Required Performance:	B
Test Voltage:	Power Line: 1 KV Signal/Control Line: 0.5 KV DC network power port: 0.5 KV
Polarity:	Positive & Negative
Impulse Frequency:	5 kHz
Impulse Wave shape :	5/50 ns
Burst Duration:	15ms
Burst Period:	300ms
Test Duration:	Not less than 1 min

4.5.2 TEST PROCEDURE

The ground reference plane shall be a metallic sheet (copper or aluminum) of 0.25 mm minimum thickness; other metallic materials may be used, but they shall have at least 0.65 mm minimum thickness.

The other conditions required in the following manners:

- a. The length of power cord between the coupling device and the EUT should not exceed 1 meter.
- b. Both positive and negative polarity discharges were applied.
- c. The duration time of each test sequential was 1 minutes.



4.5.3 TEST SETUP

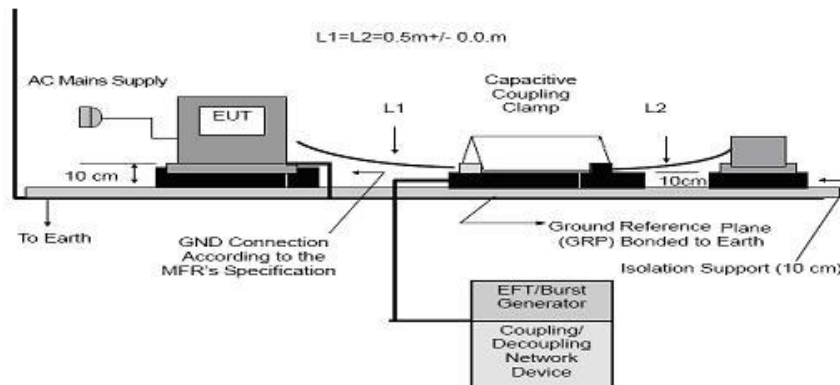
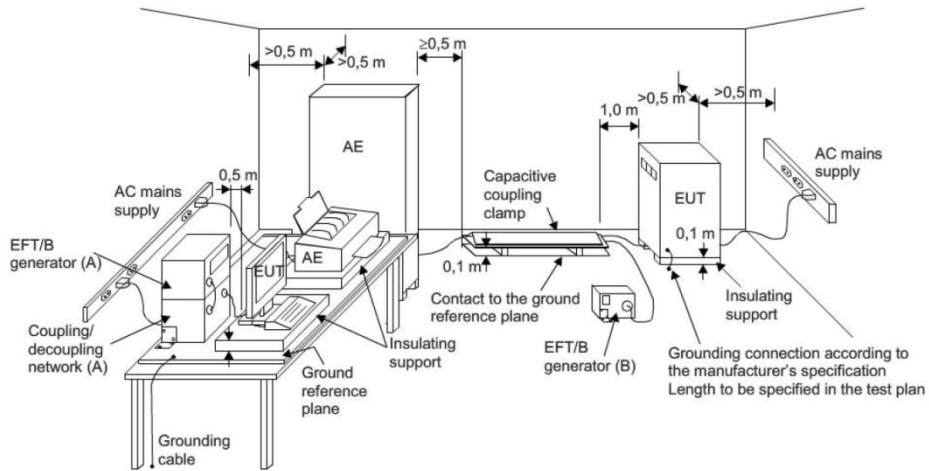



Note:

TABLE-TOP EQUIPMENT

- a. Table-top equipment and equipment normally mounted on ceilings or walls as well as built-in equipment shall be tested with the EUT located (0.1 ± 0.01) m above the ground reference plane.
- b. Testing of large table-top equipment or multiple systems can be performed on the floor; maintaining the same distances as for the test setup of table-top equipment.
- c. The test generator and the coupling/decoupling network shall be bonded to the ground reference plane.
- d. The ground reference plane shall be a metallic sheet (copper or aluminum) of 0.25mm minimum thickness; other metallic materials may be used, but they shall have at least 0.65 mm minimum thickness.
- e. The minimum size of the ground reference plane is 0.8m x 1m. The actual size depends on the dimension of the EUT.
- f. The ground reference plane shall project beyond the EUT by at least 0.1m on all sides.
- g. The ground reference plane shall be connected to the earth (PE) for safety reasons.
- h. The EUT shall be arranged and connected to satisfy its functional requirements according to the equipment installation specifications.
- i. The minimum distance between the EUT and all other conductive structures (including the generator, AE and the walls of a shielded room), except the ground reference plane, shall be more than 0.5m.
- j. All cables to the EUT shall be placed on the insulation support 0.1m above the ground reference plane. Cables not subject to electrical fast transients shall be routed as far as possible from the cable under test to minimize the coupling between the cables.
- k. The EUT shall be connected to the earth system in accordance with the manufacturer's installation specifications; no additional earth connections are allowed.
- l. The connection impedance of the coupling/decoupling network earth cables to the ground reference plane and all connectors shall provide a low inductance.
- m. Either a direct coupling network or a capacitive clamp shall be used for the application of the test voltages. The test voltages shall be coupled to all of the EUT ports in turn including those between two units of equipment involved in the test, unless the length of the interconnecting cable makes it impossible to test.

FLOOR-STANDING EQUIPMENT

When using the coupling clamp, the minimum distance between the coupling plates and all other conductive surfaces (including the generator), except the ground reference plane beneath the coupling clamp and beneath the EUT, shall be at least 0.5m.

The distance between any coupling devices and the EUT shall be ($0.5 - 0/+0.1$) m for tabletop equipment testing, and (1.0 ± 0.1) m for floor standing equipment, unless otherwise specified in product standards. When it is not physically possible to apply the distances mentioned above, other distances can be used and shall be recorded in the test report.

The cable between the EUT and the coupling device, if detachable, shall be as short as possible to comply with the requirements of this clause. If the manufacturer provides a cable exceeding the distance between the coupling device and the point of entry of the EUT, the excess length of this cable shall be bundled and situated at a distance of 0.1m above the ground reference plane. When a capacitive clamp is used as a coupling device, the excess cable length shall be bundled at the AE side. Parts of the EUT with interconnecting cables of a length less than 3m, which are not tested, shall be placed on the insulating support. The parts of the EUT shall have a distance of 0.5m between them. Excess cable length shall be bundled.



4.5.4 TEST RESULTS

Temperature:	24.4°C	Relative Humidity:	58%
Test Power:	AC 230V/50Hz	Test Date:	2023.04.14

Coupling Line		Test level (kV)								Performance Criterion	Result
		0.5		1		2		4			
		+	-	+	-	+	-	+	-		
I/O AC power ports	L	A	A	A	A					B	PASS
	N	A	A	A	A						PASS
	PE										
	L+N	A	A	A	A						PASS
	L+PE										
	N+PE										
	L+N+PE										
I/O DC Power ports										B	
analogue/digital data ports										B	
Note: EUT operate as intended during the test Normal performance within limits specified by the manufacturer, request or purchaser											



4.6 SURGE TESTING

4.6.1 TEST SPECIFICATION

Basic Standard:	IEC/EN 61000-4-5
Required Performance:	B
Wave-Shape:	Combination Wave 1.2/50us Open Circuit Voltage
Test Voltage:	Power line ~ line to line: 1 KV line to ground: 2 KV Telecommunication line: 0.5 KV DC network power port: 0.5 KV
Surge Input/Output:	L-N, L-PE, N-PE
Generator Source:	(L-N)2 ohm between networks
Impedance:	(L-PE, N-PE)12 ohm between network and ground
Polarity:	Positive/Negative
Phase Angle:	90°/270°
Pulse Repetition Rate:	1 time / min. (maximum)
Number of Tests:	5 positive and 5 negative at selected points

4.6.2 TEST PROCEDURE

- a. For EUT power supply:
The surge is to be applied to the EUT power supply terminals via the capacitive coupling network. Decoupling networks are required in order to avoid possible adverse effects on equipment not under test that may be powered by the same lines, and to provide sufficient decoupling impedance to the surge wave. The power cord between the EUT and the coupling/decoupling networks shall be 2meter in length (or shorter).
- b. For test applied to unshielded unsymmetrical operated interconnection lines of EUT:
The surge is applied to the lines via the capacitive coupling. The coupling /decoupling networks shall not influence the specified functional conditions of the EUT. The interconnection line between the EUT and the coupling/decoupling networks shall be 2 meter in length (or shorter).



4.6.3 TEST SETUP

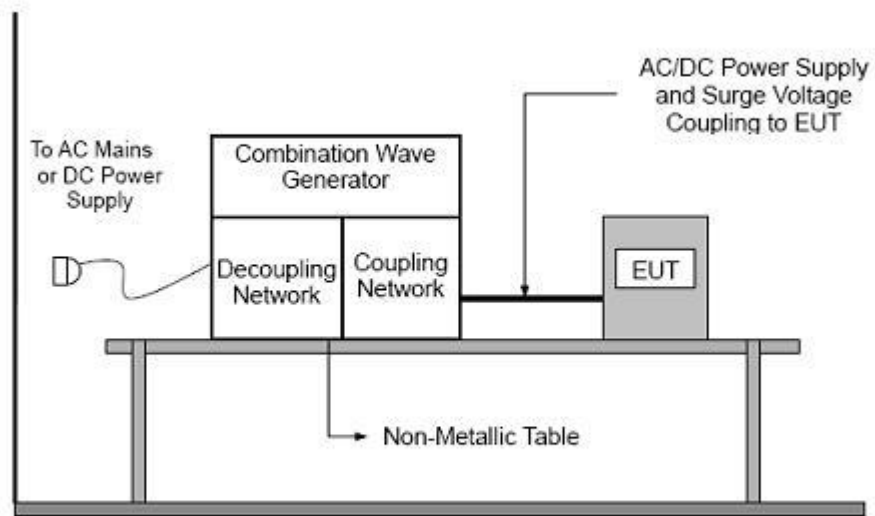



4.6.4 TEST RESULTS

Temperature:	24.4°C	Relative Humidity:	58%
Test Power:	AC 230V/50Hz	Test Date:	2023.04.14

Coupling Line			Test level								Criterion	Result
			0.5 kV		1 kV		2 kV		4 kV			
			+	-	+	-	+	-	+	-		
Input AC power ports	L-N	0°									B	
		90°	A		A							PASS
		180°										
		270°		A		A						PASS
	L-PE	0°										
		90°										
		180°										
		270°										
	N-PE	0°										
		90°										
		180°										
		270°										

Note: EUT operate as intended during the test Normal performance within limits specified by the manufacturer, request or purchaser



4.7 CONDUCTED RADIO FREQUENCY DISTURBANCES (CS)

4.7.1 TEST SPECIFICATION

Basic Standard:	IEC/EN 61000-4-6
Required Performance:	A
Test Frequency Range:	0.15 MHz-80 MHz
Primary Function Of Telephony Test Frequencies:	0.2 MHz; 1 MHz; 7.1 MHz; 13.56 MHz; 21 MHz; 27.12 MHz and 40.68 MHz
Field Strength:	0.15 MHz - 10 MHz, 3V 10 MHz - 30 MHz, 3V to 1V 30 MHz - 80 MHz, 1V
Modulation:	1kHz Sine Wave, 80%, AM Modulation
Frequency Step:	1 % of fundamental
Dwell Time:	1.5×10^{-3} decade/s

4.7.2 TEST PROCEDURE

The EUT shall be tested within its intended operating and climatic conditions.

The test shall be performed with the test generator connected to each of the coupling and decoupling devices in turn, while the other non-excited RF input ports of the coupling devices are terminated by a 50-ohm load resistor.

The frequency range was swept from 150 kHz to 10 MHz, 10 MHz to 30 MHz, 30 MHz to 80 MHz using the signal level established during the setting process and with a disturbance signal of 80 % amplitude. The signal was modulated with a 1 kHz sine wave, pausing to adjust the RF signal level or the switch coupling devices as necessary. The sweep rate was 1.5×10^{-3} decades/s. Where the frequency range is swept incrementally, the step size was 1 % of preceding frequency value from 150 kHz to 80MHz.

The dwell time at each frequency was less than the time necessary for the EUT to be exercised, and able to respond. Sensitive frequencies such as clock frequency (ies) and harmonics or frequencies of dominant interest, was analyzed separately.

Attempts were made to fully exercise the EUT during testing, and to fully interrogate all exercise modes selected for susceptibility.

4.7.3 TEST SETUP

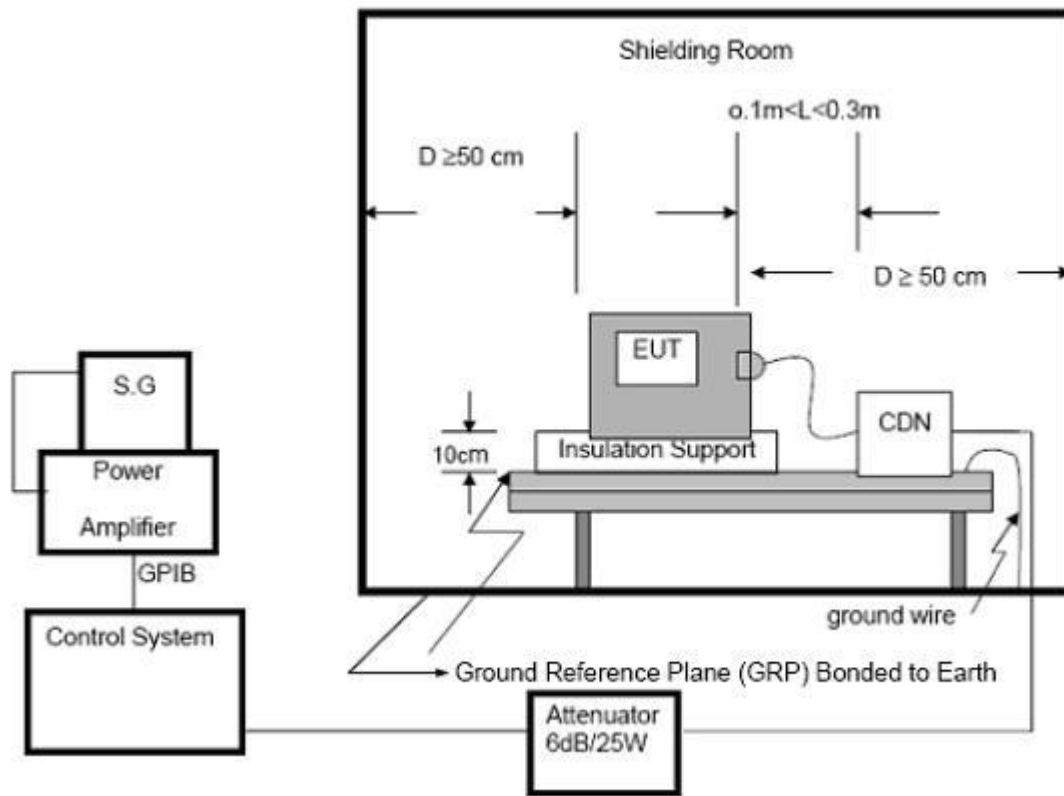

NOTE:

FLOOR-STANDING EQUIPMENT

The equipment to be tested is placed on an insulating support of 0.1 meter height above a ground reference plane. All relevant cables shall be provided with the appropriate coupling and decoupling devices at a distance between 0.1 meter and 0.3 meter from the projected geometry of the EUT on the ground reference plane.

For Audio output function use below setting

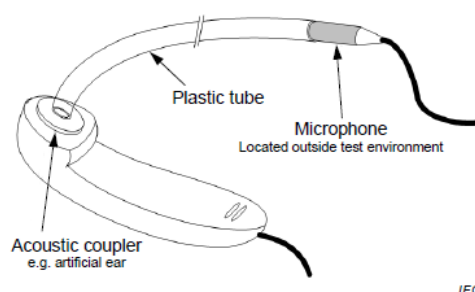

NOTE 1 The microphone is connected via the cable to a suitable amplifier.

NOTE 2 This setup is suitable for radiated immunity testing. See G.6.3

Figure G.5 – Example test setup for on-ear acoustic measurements, microphone located away from earpiece transducer



4.7.4 TEST RESULTS

Temperature:	24.4°C	Relative Humidity:	58%
Test Power:	AC 230V/50Hz	Test Date:	2023.04.14

Frequency Step:	1%		Dwell Time:	2000 ms	
Test Ports (Mode)	Freq. Range MHz)	Field Strength	Perform. Criteria	Results	Result
Input / Output AC Power Port	0.15~10	3V r.m.s.	A	A	PASS
	10~30	3~1V r.m.s.		A	PASS
	30~80	1V r.m.s.		A	PASS
Input / Output DC Power Port	0.15~10	3V r.m.s.	A	N/A	N/A
	10~30	3~1V r.m.s.		N/A	N/A
	30~80	1V r.m.s.		N/A	N/A
Analogue/digital data ports	0.15~10	3V r.m.s.	A	N/A	N/A
	10~30	3~1V r.m.s.		N/A	N/A
	30~80	1V r.m.s.		N/A	N/A

Note: EUT operate as intended during the test Normal performance within limits specified by the manufacturer, request or purchaser

Note: According to EN 55035, Annex A, A.2 Applicability, the EUT belongs to Group 2. And then according to EN 55035, Annex A, A.4 Modified test levels and performance criteria, Table A.2 – Modified test levels for performance criterion A for the broadcast reception function, no test requirements apply to this EUT.



4.8 VOLTAGE INTERRUPTION/DIPS TESTING (DIPS)

4.8.1 TEST SPECIFICATION

Basic Standard:	IEC/EN 61000-4-11
Required Performance:	B (For 100% Voltage Dips, 0.5 Cycle) C (For 30% Voltage Dips, 25 Cycles) C (For 100% Voltage Interruptions, 250 Cycles)
Test Duration Time:	Minimum 3 test events in sequence
Interval between Event:	Minimum 10 seconds
Phase Angle:	0°/45°/90°/135°/180°/225°/270°/315°/360°
Test Cycle:	3 times

4.8.2 TEST PROCEDURE

The EUT shall be tested for each selected combination of test levels and duration with a sequence of three dips/interruptions with intervals of 10 s minimum (between each test event). Each representative mode of operation shall be tested. Abrupt changes in supply voltage shall occur at zero crossings of the voltage waveform.

4.8.3 TEST SETUP

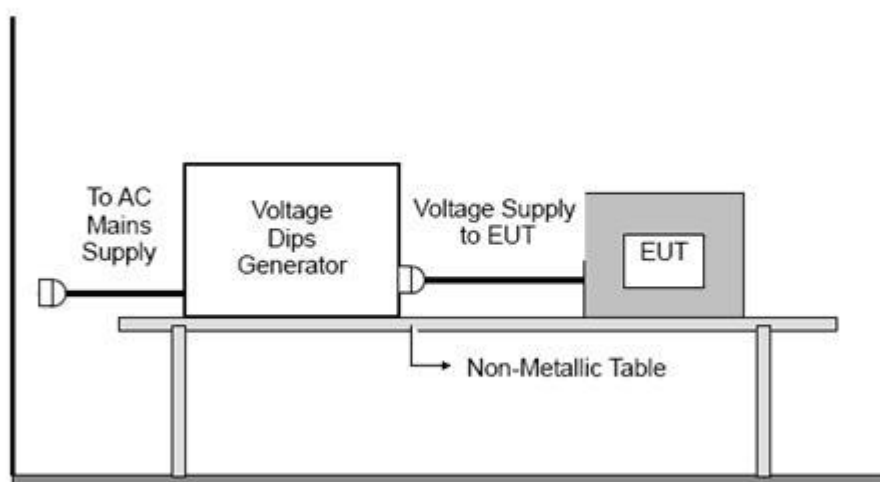



4.8.4 TEST RESULTS

Temperature:	24.4°C	Relative Humidity:	58%
Test Power:	AC 230V/50Hz	Test Date:	2023.04.14

Interruption & Dips	Duration (T)	Perform Criteria	Results	Judgment
Voltage dip 70%	25	C	A	PASS
Voltage dip 0%	0.5	B	A	PASS
Interruption 0%	250	C	B	PASS

EUT operate as intended during the test Normal performance within limits specified by the manufacturer, request or purchaser



APPENDIX 1 - TEST SETUP

Set-up for Conducted Emission on AC Mains (CE)



Set-up for Radiated Emission (RE), Below 1GHz

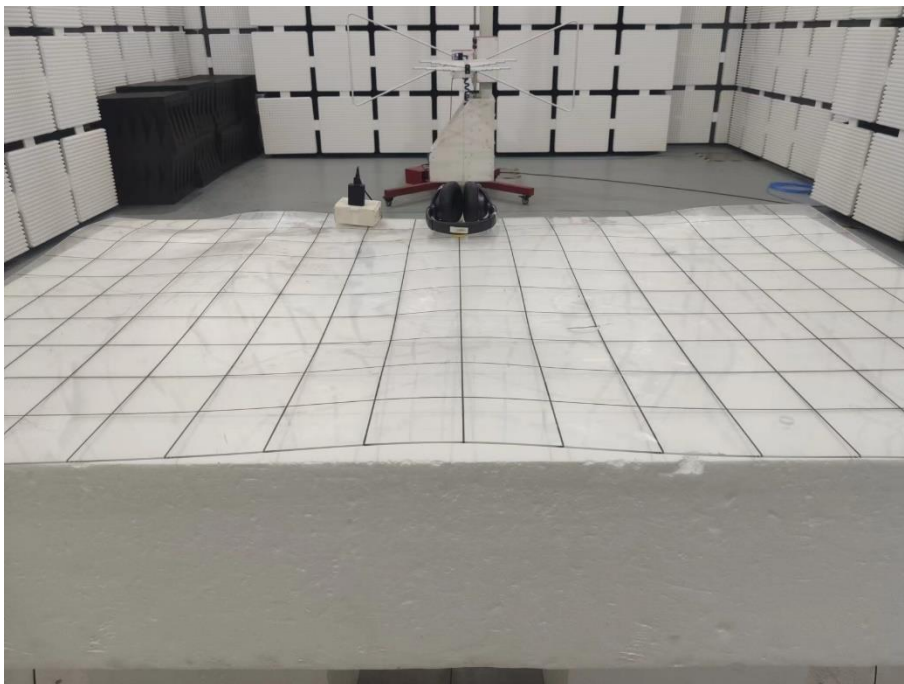



Set-up for Radiated Emission (RE), Above 1GHz



Set-up for Radio Frequency Electromagnetic Fields (RS)

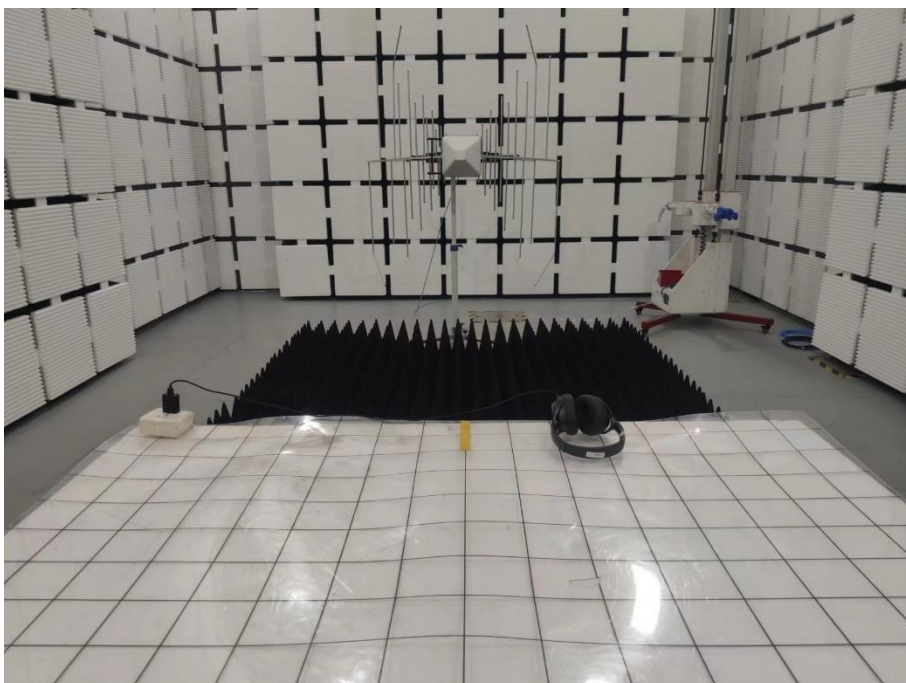

Set-up for Radio Frequency Continuous Conducted (CS)

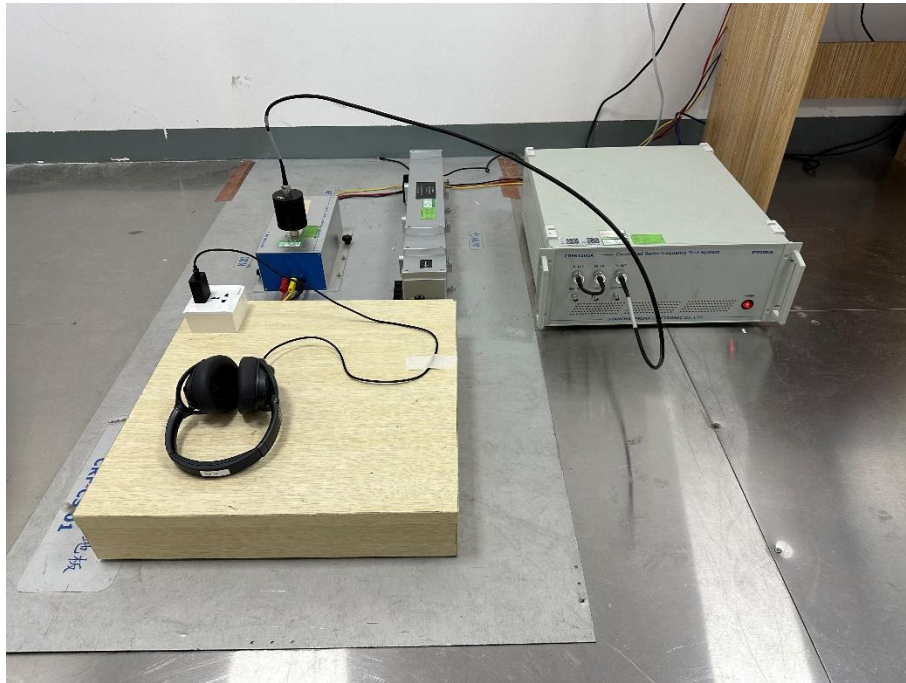

Set-up for Electrostatic Discharges (ESD)





Set-up for Electrical Fast Transients (EFT)

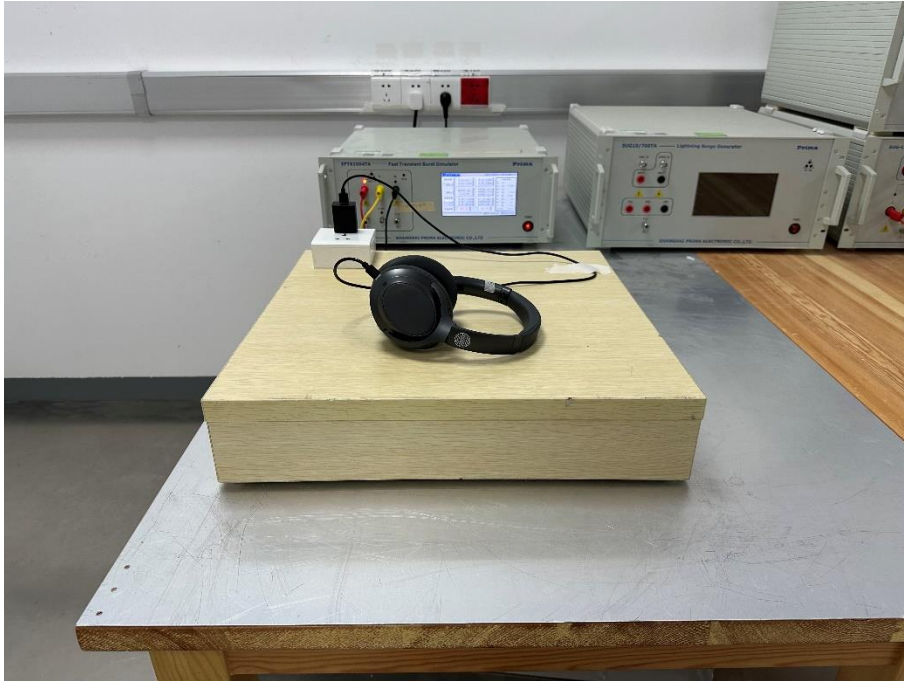

Set-up for Surge

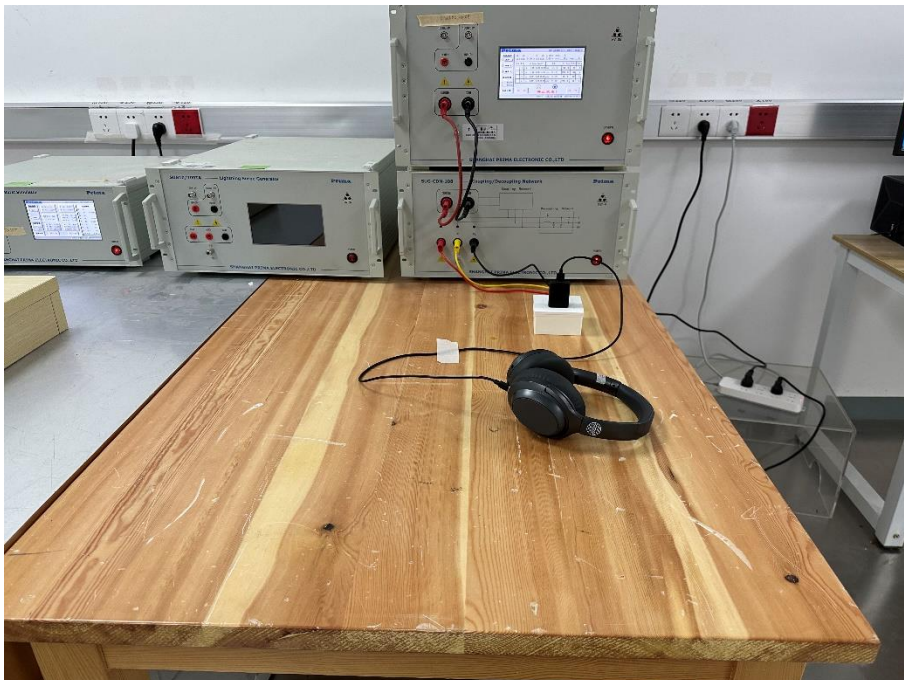



Set-up for Voltage Dips and Interruptions

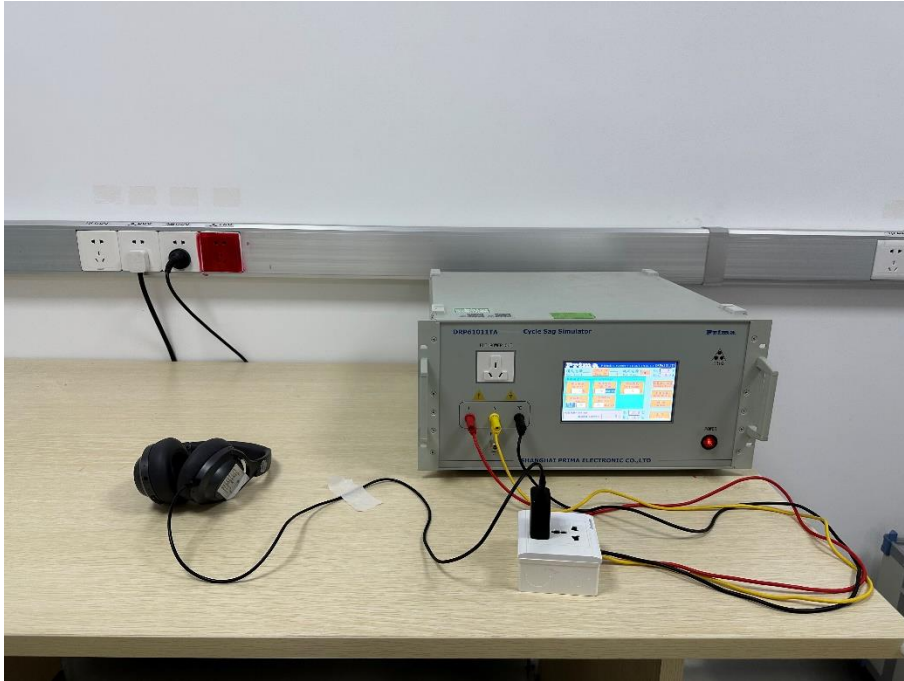

※※※※※END OF THE REPORT※※※※※