



<b>TEST REPORT</b> <b>IEC 62133-2</b> <b>Secondary cells and batteries containing alkaline or other non-acid electrolytes – Safety requirements for portable sealed secondary cells, and for batteries made from them, for use in portable applications –</b> <b>Part 2: Lithium systems</b>	
<b>Report Number</b> .....	MTST20120979 Rev.0
<b>Date of issue</b> .....	2020-12-17
<b>Total number of pages</b> .....	28 pages
<b>Name of Testing Laboratory preparing the Report</b> .....	Shenzhen Most Technology Service Co., Ltd.
<b>Applicant's name</b> .....	Topway EM Enterprise Ltd.
<b>Address</b> .....	8F., Block B, Building 6, Baoneng Science and technology park, Qingxiang RD., Qinghu Industrial Park, Longhua New District, Shenzhen, GD, China 518109
<b>Test specification:</b>	
<b>Standard</b> .....	IEC 62133-2:2017
<b>Test procedure</b> .....	Test Report
<b>Non-standard test method</b> .....	N/A
<b>Test Report Form No</b> .....	IEC62133_2A
<b>Test Report Form(s) Originator</b> .....	DEKRA
<b>Master TRF</b> .....	Dated 2017-08-10
<b>Copyright © 2017 IEC System of Conformity Assessment Schemes for Electrotechnical Equipment and Components (IECEE System). All rights reserved.</b>	
This publication may be reproduced in whole or in part for non-commercial purposes as long as the IECEE is acknowledged as copyright owner and source of the material. IECEE takes no responsibility for and will not assume liability for damages resulting from the reader's interpretation of the reproduced material due to its placement and context.	
<b>This report is not valid as a Test Report unless signed by Testing Laboratory.</b>	
<b>General disclaimer:</b>	
The test results presented in this report relate only to the object tested. This report shall not be reproduced, except in full, without the written approval of the Issuing Testing Laboratory.	

<b>Test item description</b> .....	Polymer Lithium Ion Battery	
<b>Trade Mark</b> .....	N/A	
<b>Manufacturer</b> .....	Shenzhen Kulihang Technology Co., Ltd. No.17, Lane 6, Tangjia New Village, Tangjia Community, Fenghuang Street, Guangming New District, Shenzhen, China	
<b>Model/Type reference</b> .....	402030	
<b>Ratings</b> .....	3.7V, 180mAh, 0.666Wh	
<b>Responsible Testing Laboratory (as applicable), testing procedure and testing location(s):</b>		
<input checked="" type="checkbox"/> <b>Testing Laboratory:</b>	Shenzhen Most Technology Service Co., Ltd.	
<b>Testing location/ address</b> .....	No.5, 2nd Langshan Road, North District, Hi-tech Industry Park, Nanshan, Shenzhen, Guangdong, China	
<b>Tested by (name, function, signature) .....</b>	Qinghua Hu 	QAH
<b>Approved by (name, function, signature) ..</b>	Yvette Zhou 	
<input type="checkbox"/> <b>Testing procedure: CTF Stage 1:</b>		
<b>Testing location/ address</b> .....		
<b>Tested by (name, function, signature) .....</b>		
<b>Approved by (name, function, signature) ..</b>		
<input type="checkbox"/> <b>Testing procedure: CTF Stage 2:</b>		
<b>Testing location/ address</b> .....		
<b>Tested by (name + signature).....</b>		
<b>Witnessed by (name, function, signature) . :</b>		
<b>Approved by (name, function, signature) .. :</b>		
<input type="checkbox"/> <b>Testing procedure: CTF Stage 3:</b>		
<input type="checkbox"/> <b>Testing procedure: CTF Stage 4:</b>		
<b>Testing location/ address</b> .....		
<b>Tested by (name, function, signature) .....</b>		
<b>Witnessed by (name, function, signature) . :</b>		
<b>Approved by (name, function, signature) .. :</b>		
<b>Supervised by (name, function, signature) :</b>		

<p><b>List of Attachments (including a total number of pages in each attachment):</b> Attachment 1: Photo documentation (4 pages).</p>	
<p><b>Summary of testing:</b></p>	
<p><b>Tests performed (name of test and test clause):</b>            cl.5.6.2 Design recommendation;            cl.7.1 Charging procedure for test purposes (for Cells and Batteries);            cl.7.2.1 Continuous charging at constant voltage (Cells);            cl.7.2.2 Case stress at high ambient temperature (Batteries);            cl.7.3.1 External short circuit (Cells);            cl.7.3.2 External short circuit (Batteries);            cl.7.3.3 Free fall (Cells and Batteries);            cl.7.3.4 Thermal abuse (Cells);            cl.7.3.5 Crush (Cells);            cl.7.3.6 Over-charging of battery;            cl.7.3.7 Forced discharge (Cells);            cl.7.3.8 Mechanical tests (Batteries);            cl.7.3.9 Design evaluation -Forced internal short-circuit (cells);</p> <p>Tests are made with the number of cells and batteries specified in IEC 62133-2: 2017 Table 1.</p>	<p><b>Testing location:</b>  <b>Shenzhen Most Technology Service Co., Ltd.</b>            No.5, 2nd Langshan Road, North District, Hi-tech Industry Park, Nanshan, Shenzhen, Guangdong, China</p>
<p><b>Summary of compliance with National Differences (List of countries addressed):</b> N/A</p>	

**Copy of marking plate:**

**The artwork below may be only a draft.**

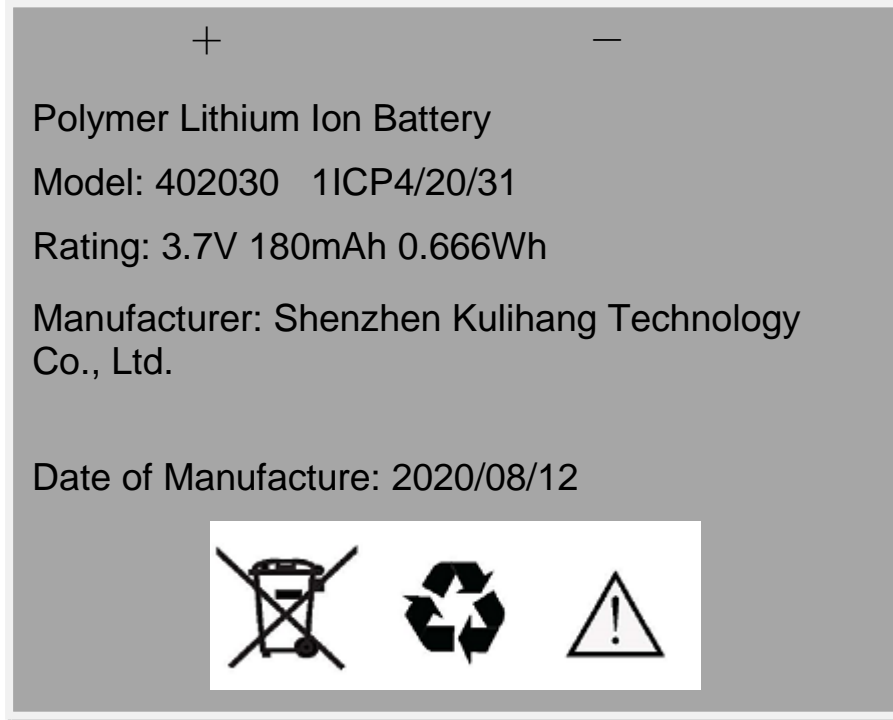

<b>Test item particulars</b> .....	
<b>Classification of installation and use</b> .....	N/A
<b>Supply Connection</b> .....	DC lead wire
<b>Recommend charging method declared by the manufacturer</b> .....	Charging the battery with 36mA constant current and 4.2V constant voltage until the current reduces to 1.8mA at ambient 20°C±5°C.
<b>Discharge current (0,2 It A)</b> .....	36mA
<b>Specified final voltage</b> .....	3.0V
<b>Upper limit charging voltage per cell</b> .....	4.2V
<b>Maximum charging current</b> .....	180mA
<b>Charging temperature upper limit</b> .....	45°C
<b>Charging temperature lower limit</b> .....	0°C
<b>Polymer cell electrolyte type</b> .....	<input checked="" type="checkbox"/> gel polymer <input type="checkbox"/> solid polymer <input type="checkbox"/> N/A
<b>Possible test case verdicts:</b>	
- test case does not apply to the test object .....	N/A
- test object does meet the requirement .....	P (Pass)
- test object does not meet the requirement .....	F (Fail)
<b>Testing</b> .....	
<b>Date of receipt of test item</b> .....	2020-12-03
<b>Date (s) of performance of tests</b> .....	2020-12-05 to 2020-12-15
<b>General remarks:</b>	
<p>"(See Enclosure #)" refers to additional information appended to the report.          "(See appended table)" refers to a table appended to the report.</p> <p>Throughout this report a <input type="checkbox"/> comma / <input checked="" type="checkbox"/> point is used as the decimal separator.</p>	
<b>Manufacturer's Declaration per sub-clause 4.2.5 of IEC 60335-1:</b>	
The application for obtaining a CB Test Certificate includes more than one factory location and a declaration from the Manufacturer stating that the sample(s) submitted for evaluation is (are) representative of the products from each factory has been provided .....	<input type="checkbox"/> Yes <input checked="" type="checkbox"/> Not applicable
<b>When differences exist; they shall be identified in the General product information section.</b>	
<b>Name and address of factory (ies)</b> .....	Same as manufacturer

**General product information and other remarks:**

This battery is constructed with one li-ion cell and has overcharge, over-discharge, over current and short-circuits proof circuit.

The main features of the battery pack are shown as below (clause 7.1.1):

Model	Nominal capacity	Nominal voltage	Nominal Charge Current	Nominal Discharge Current	Maximum Charge Current	Maximum Discharge Current	Maximum Charge Voltage	Cut-off Voltage
402030	180mAh	3.7V	36mA	36mA	180mA	180mA	4.2V	3.0V

The main features of the battery pack are shown as below (clause 7.1.2):

Model	Upper limit charge voltage	Taper-off current	Lower charge temperature	Upper charge temperature
402030	4.2V	1.8mA	0°C	45°C

The main features of the cell built in the battery pack are shown as below (clause 7.1.1):

Model	Nominal capacity	Nominal voltage	Nominal Charge Current	Nominal Discharge Current	Maximum Charge Current	Maximum Discharge Current	Maximum Charge Voltage	Cut-off Voltage
402030P	180mAh	3.7V	90mA	90mA	90mA	90mA	4.2V	3.0V

The main features of the cell built in the battery pack are shown as below (clause 7.1.2):

Model	Upper limit charge voltage	Taper-off current	Lower charge temperature	Upper charge temperature
402030P	4.2V	1.8mA	10°C	45°C

**Construction:**

Picture of battery (Unit: mm)

Picture of single cell:

Item	S	W	M	H	L	B	A
Size	4.0	20	30.5	7~9	0.5~1.5	2±0.1	12±2

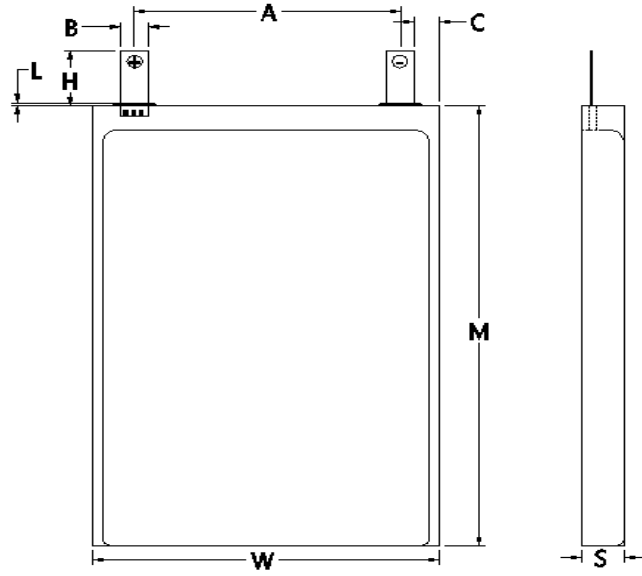

Picture of assembled battery:

Item	T	W	L+E	F	C	L
Size	4.2	20.2	33	13±2	3±0.1	30±5

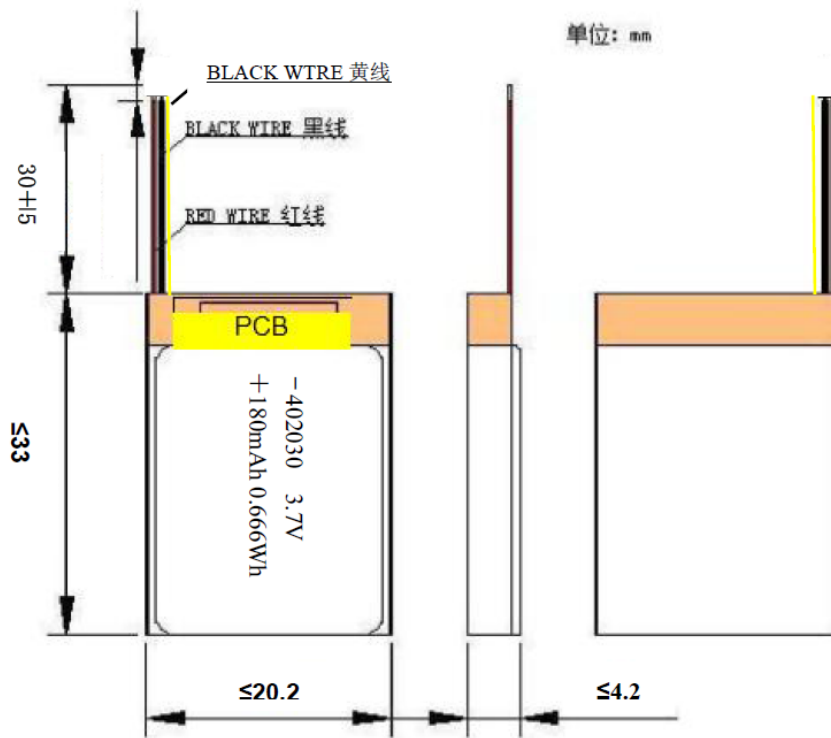

**Circuit diagram:**

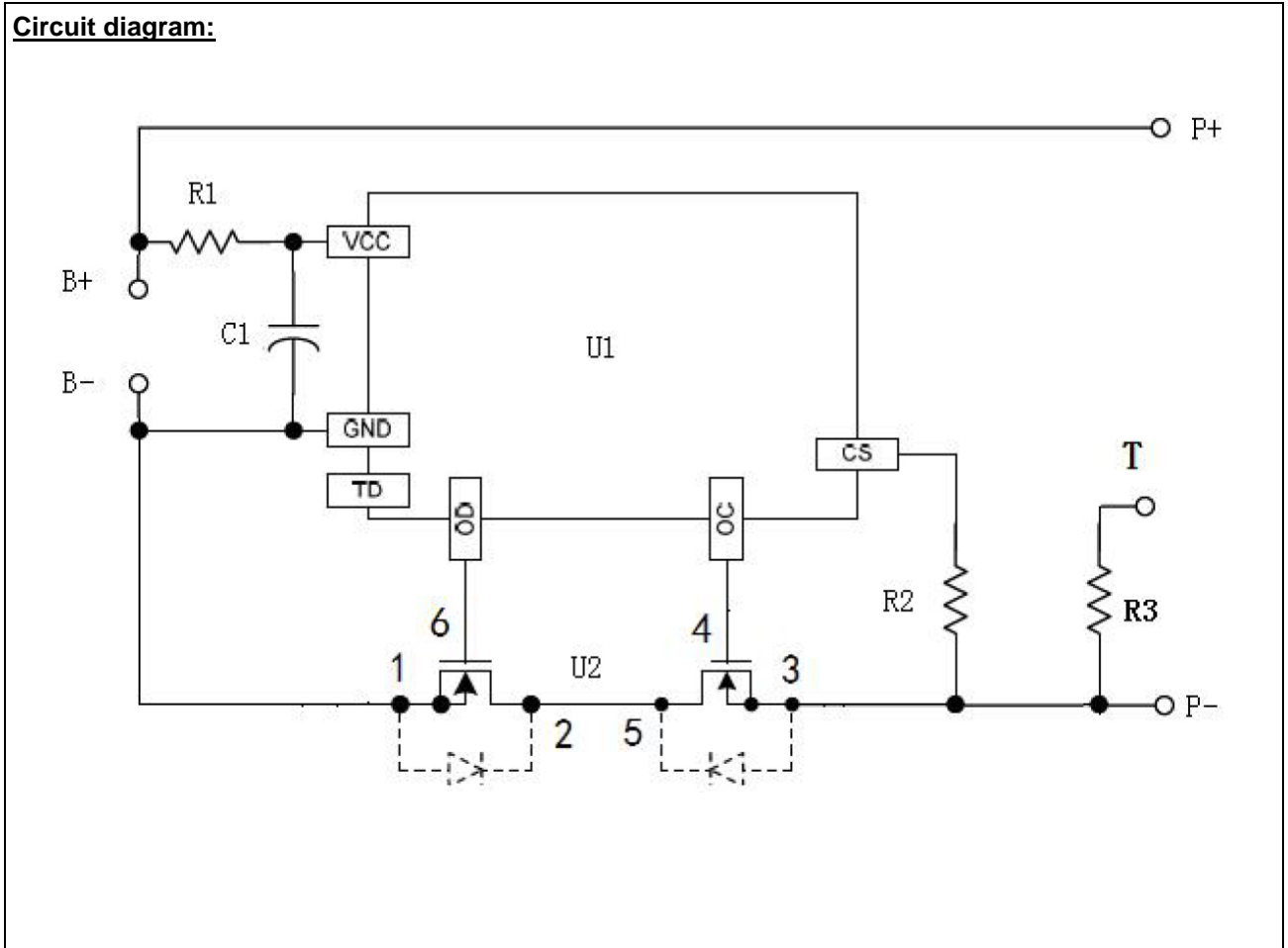



IEC 62133-2			
Clause	Requirement + Test	Result - Remark	Verdict
<b>4</b>	<b>PARAMETER MEASUREMENT TOLERANCES</b>		P
	Parameter measurement tolerances		P
<b>5</b>	<b>GENERAL SAFETY CONSIDERATIONS</b>		P
<b>5.1</b>	<b>General</b>		P
	Cells and batteries so designed and constructed that they are safe under conditions of both intended use and reasonably foreseeable misuse		P
<b>5.2</b>	<b>Insulation and wiring</b>		P
	The insulation resistance between the positive terminal and externally exposed metal surfaces of the battery (excluding electrical contact surfaces) is not less than 5 MΩ	No metal surface exists.	N/A
	Insulation resistance (MΩ) ..... :		—
	Internal wiring and insulation are sufficient to withstand maximum anticipated current, voltage and temperature requirements		P
	Orientation of wiring maintains adequate clearance and creepage distances between conductors		P
	Mechanical integrity of internal connections accommodates reasonably foreseeable misuse		P
<b>5.3</b>	<b>Venting</b>		P
	Battery cases and cells incorporate a pressure relief mechanism or are constructed so that they relieve excessive internal pressure at a value and rate that will preclude rupture, explosion and self-ignition	Venting mechanism exists on the narrow side of pouch cell.	P
	Encapsulation used to support cells within an outer casing does not cause the battery to overheat during normal operation nor inhibit pressure relief		N/A
<b>5.4</b>	<b>Temperature, voltage and current management</b>		P
	Batteries are designed such that abnormal temperature rise conditions are prevented	Overcharge, over discharge, over current and short-circuit proof circuit used in this battery, see tests of clause 7.	P
	Batteries are designed to be within temperature, voltage and current limits specified by the cell manufacturer	See above.	P
	Batteries are provided with specifications and charging instructions for equipment manufacturers so that specified chargers are designed to maintain charging within the temperature, voltage and current limits specified	The charging limits specified in the user manual.	P
<b>5.5</b>	<b>Terminal contacts</b>		P
	The size and shape of the terminal contacts ensure that they can carry the maximum anticipated current	Lead wire terminal complied.	P

IEC 62133-2			
Clause	Requirement + Test	Result - Remark	Verdict
	External terminal contact surfaces are formed from conductive materials with good mechanical strength and corrosion resistance		P
	Terminal contacts are arranged to minimize the risk of short-circuit		P
<b>5.6</b>	<b>Assembly of cells into batteries</b>		P
5.6.1	General		P
	Each battery have an independent control and protection for current, voltage, temperature and any other parameter required for safety and to maintain the cells within their operating region	Protective circuit equipped on battery.	P
	This protection may be provided external to the battery such as within the charger or the end devices		N/A
	If protection is external to the battery, the manufacturer of the battery provide this safety relevant information to the external device manufacturer for implementation		N/A
	If there is more than one battery housed in a single battery case, each battery have protective circuitry that can maintain the cells within their operating regions		N/A
	Manufacturers of cells specify current, voltage and temperature limits so that the battery manufacturer/designer may ensure proper design and assembly	Current, voltage and temperature limits specified by cell manufacturer.	P
	Batteries that are designed for the selective discharge of a portion of their series connected cells incorporate circuitry to prevent operation of cells outside the limits specified by the cell manufacturer		N/A
	Protective circuit components added as appropriate and consideration given to the end-device application		P
	The manufacturer of the battery provide a safety analysis of the battery safety circuitry with a test report including a fault analysis of the protection circuit under both charging and discharging conditions confirming the compliance	Safety analysis report provided by manufacturer.	P
5.6.2	Design recommendation		P
	For the battery consisting of a single cell or a single cellblock, it is recommended that the charging voltage of the cell does not exceed the upper limit of the charging voltage specified in Table 2	Charging voltage of cell: 4.2V, not exceed upper limit charging voltage specified in Clause 7.1.2, Table 2.	P

IEC 62133-2			
Clause	Requirement + Test	Result - Remark	Verdict
	For the battery consisting of series-connected plural single cells or series-connected plural cellblocks, it is recommended that the voltages of any one of the single cells or single cellblocks does not exceed the upper limit of the charging voltage, specified in Table 2, by monitoring the voltage of every single cell or the single cellblocks		N/A
	For the battery consisting of series-connected plural single cells or series-connected plural cellblocks, it is recommended that charging is stopped when the upper limit of the charging voltage is exceeded for any one of the single cells or single cellblocks by measuring the voltage of every single cell or the single cellblocks		N/A
	For batteries consisting of series-connected cells or cell blocks, nominal charge voltage not be counted as an overcharge protection		N/A
	For batteries consisting of series-connected cells or cell blocks, cells have closely matched capacities, be of the same design, be of the same chemistry and be from the same manufacturer		N/A
	It is recommended that the cells and cell blocks not discharged beyond the cell manufacturer's specified final voltage	Final voltage of battery: 3.0V, not exceed the final voltage specified by cell manufacturer.	P
	For batteries consisting of series-connected cells or cell blocks, cell balancing circuitry incorporated into the battery management system		N/A
5.6.3	Mechanical protection for cells and components of batteries		P
	Mechanical protection for cells, cell connections and control circuits within the battery provided to prevent damage as a result of intended use and reasonably foreseeable misuse	Mechanical protection for cell connections and control circuits provided.	P
	The mechanical protection can be provided by the battery case or it can be provided by the end product enclosure for those batteries intended for building into an end product	Build-in batteries, mechanical protection for cells should be provided by end product.	N/A
	The battery case and compartments housing cells designed to accommodate cell dimensional tolerances during charging and discharging as recommended by the cell manufacturer	To be evaluated in final system.	N/A
	For batteries intended for building into a portable end product, testing with the battery installed within the end product considered when conducting mechanical tests		N/A
5.7	<b>Quality plan</b>	Complied.	P

IEC 62133-2			
Clause	Requirement + Test	Result - Remark	Verdict
	The manufacturer prepares and implements a quality plan that defines procedures for the inspection of materials, components, cells and batteries and which covers the whole process of producing each type of cell or battery	Quality plan provided.	P
<b>5.8</b>	<b>Battery safety components</b>		N/A
	According annex F	See TABLE: Critical components information	N/A

<b>6</b>	<b>TYPE TEST AND SAMPLE SIZE</b>		P
	Tests are made with the number of cells or batteries specified in Table 1 using cells or batteries that are not more than six months old		P
	Coin cells with resistance $\leq 3 \Omega$ (measured according annex D) are tested according table 1	Not coin cells	N/A
	Unless otherwise specified, tests are carried out in an ambient temperature of $20 \text{ }^\circ\text{C} \pm 5 \text{ }^\circ\text{C}$		P
	The safety analysis of 5.6.1 identify those components of the protection circuit that are critical for short-circuit, overcharge and overdischarge protection		P
	When conducting the short-circuit test, consideration given to the simulation of any single fault condition that is likely to occur in the protecting circuit that would affect the short-circuit test	See clause 7.3.2.	P

<b>7</b>	<b>SPECIFIC REQUIREMENTS AND TESTS</b>		P
<b>7.1</b>	<b>Charging procedure for test purposes</b>		P
7.1.1	First procedure		P
	This charging procedure applies to subclauses other than those specified in 7.1.2		P
	Unless otherwise stated in this document, the charging procedure for test purposes is carried out in an ambient temperature of $20 \text{ }^\circ\text{C} \pm 5 \text{ }^\circ\text{C}$ , using the method declared by the manufacturer	See page 5.	P
	Prior to charging, the battery have been discharged at $20 \text{ }^\circ\text{C} \pm 5 \text{ }^\circ\text{C}$ at a constant current of 0,2 It A down to a specified final voltage	See page 5.	P
7.1.2	Second procedure		P
	This charging procedure applies only to 7.3.1, 7.3.4, 7.3.5, and 7.3.9		P

IEC 62133-2			
Clause	Requirement + Test	Result - Remark	Verdict
	After stabilization for 1 h and 4 h, respectively, at ambient temperature of highest test temperature and lowest test temperature, as specified in Table 2, cells are charged by using the upper limit charging voltage and maximum charging current, until the charging current is reduced to 0,05 It A, using a constant voltage charging method	Charge temperature specified by manufacturer: 10-45°C; 45°C used for upper limit tests; 10°C used for lower limit tests.	P
<b>7.2</b>	<b>Intended use</b>		P
7.2.1	Continuous charging at constant voltage (cells)	Tested complied.	P
	Fully charged cells are subjected for 7 days to a charge using the charging method for current and standard voltage specified by the cell manufacturer	Charging for 7 days with 90mA.	P
	Results: No fire. No explosion. No leakage..... :	(See appended table 7.2.1)	P
7.2.2	Case stress at high ambient temperature (battery)	Tested as client requested.	P
	Oven temperature (°C)..... :	70°C	—
	Results: No physical distortion of the battery case resulting in exposure of internal protective components and cells	No physical distortion of the battery casing	P
<b>7.3</b>	<b>Reasonably foreseeable misuse</b>		P
7.3.1	External short-circuit (cell)	Tested complied.	P
	The cells were tested until one of the following occurred:		P
	- 24 hours elapsed; or		N/A
	- The case temperature declined by 20 % of the maximum temperature rise		P
	Results: No fire. No explosion..... :	(See appended table 7.3.1)	P
7.3.2	External short-circuit (battery)	Tested complied.	P
	The batteries were tested until one of the following occurred:		P
	- 24 hours elapsed; or		N/A
	- The case temperature declined by 20 % of the maximum temperature rise		N/A
	In case of rapid decline in short circuit current, the battery pack remained on test for an additional one hour after the current reached a low end steady state condition		P
	A single fault in the discharge protection circuit conducted on one to four (depending upon the protection circuit) of the five samples before conducting the short-circuit test	Single fault conducted on two samples.	P
	A single fault applies to protective component parts such as MOSFET, fuse, thermostat or positive temperature coefficient (PTC) thermistor	Single fault applies on MOSFET U2, IC U1	P
	Results: No fire. No explosion..... :	(See appended table 7.3.2)	P

IEC 62133-2			
Clause	Requirement + Test	Result - Remark	Verdict
7.3.3	Free fall	Tested complied.	P
	Results: No fire. No explosion	No fire. No explosion	P
7.3.4	Thermal abuse (cells)	Tested complied.	P
	Oven temperature (°C) ..... : 130°C		—
	Results: No fire. No explosion	No fire. No explosion	P
7.3.5	Crush (cells)	Tested complied.	P
	The crushing force was released upon:		P
	- The maximum force of 13 kN ± 0,78 kN has been applied; or		P
	- An abrupt voltage drop of one-third of the original voltage has been obtained		N/A
	Results: No fire. No explosion..... : (See appended table 7.3.5)		P
7.3.6	Over-charging of battery	Tested complied.	P
	The supply voltage which is:		P
	- 1,4 times the upper limit charging voltage presented in Table A.1 (but not to exceed 6,0 V) for single cell/cell block batteries or	5.88V applied.	P
	- 1,2 times the upper limit charging voltage resented in Table A.1 per cell for series connected multi-cell batteries, and		N/A
	- Sufficient to maintain a current of 2,0 It A throughout the duration of the test or until the supply voltage is reached		P
	Test was continued until the temperature of the outer casing:		P
	- Reached steady state conditions (less than 10 °C change in 30-minute period); or		N/A
	- Returned to ambient		P
	Results: No fire. No explosion..... : (See appended table 7.3.6)		P
7.3.7	Forced discharge (cells)	Tested complied.	P
	If the discharge voltage reaches the negative value of upper limit charging voltage within the testing duration, the voltage is maintained at the negative value of the upper limit charging voltage by reducing the current for the remainder of the testing duration		N/A
	If the discharge voltage does not reach the negative value of upper limit charging voltage within the testing duration, the test is terminated at the end of the testing duration		P
	Results: No fire. No explosion..... : (See appended table 7.3.7)		P
7.3.8	Mechanical tests (batteries)		P
7.3.8.1	Vibration	Tested complied.	P

IEC 62133-2			
Clause	Requirement + Test	Result - Remark	Verdict
	Results: No fire, no explosion, no rupture, no leakage or venting. .... :	(See appended table 7.3.8.1)	P
7.3.8.2	Mechanical shock	Tested complied.	P
	Results: No leakage, no venting, no rupture, no explosion and no fire ..... :	(See appended table 7.3.8.2)	P
7.3.9	Design evaluation – Forced internal short-circuit (cells)	Tested complied	P
	The cells complied with national requirement for ..... :	France, Japan, Republic of Korea, Switzerland	—
	The pressing was stopped upon:		P
	- A voltage drop of 50 mV has been detected; or		N/A
	- The pressing force of 800 N (cylindrical cells) or 400 N (prismatic cells) has been reached	400N for prismatic cells	P
	Results: No fire ..... :	(See appended table 7.3.9)	P

<b>8</b>	<b>INFORMATION FOR SAFETY</b>		P
<b>8.1</b>	<b>General</b>		P
	Manufacturers of secondary cells ensure that information is provided about current, voltage and temperature limits of their products	Information for safety mentioned in manufacturer's specifications.	P
	Manufacturers of batteries ensure that equipment manufacturers and, in the case of direct sales, end-users are provided with information to minimize and mitigate hazards	Information for safety mentioned in manufacturer's specifications.	P
	Systems analyses performed by device manufacturers to ensure that a particular battery design prevents hazards from occurring during use of a product		N/A
	As appropriate, any information relating to hazard avoidance resulting from a system analysis provided to the end user		N/A
	Do not allow children to replace batteries without adult supervision		P
<b>8.2</b>	<b>Small cell and battery safety information</b>	Not small cell and battery.	N/A
	The following warning language is to be provided with the information packaged with the small cells and batteries or equipment using them:		N/A
	- Keep small cells and batteries which are considered swallowable out of the reach of children		N/A
	- Swallowing may lead to burns, perforation of soft tissue, and death. Severe burns can occur within 2 h of ingestion		N/A
	- In case of ingestion of a cell or battery, seek medical assistance promptly		N/A

IEC 62133-2			
Clause	Requirement + Test	Result - Remark	Verdict
<b>9</b>	<b>MARKING</b>		P
<b>9.1</b>	<b>Cell marking</b>	The final product is battery	N/A
	Cells marked as specified in IEC 61960, except coin cells		N/A
	Coin cells whose external surface area is too small to accommodate the markings on the cells show the designation and polarity		N/A
	By agreement between the cell manufacturer and the battery and/or end product manufacturer, component cells used in the manufacture of a battery need not be marked		N/A
<b>9.2</b>	<b>Battery marking</b>		P
	Batteries marked as specified in IEC 61960, except for coin batteries	See marking plate on page 4.	P
	Coin batteries whose external surface area is too small to accommodate the markings on the batteries show the designation and polarity. Batteries also marked with an appropriate caution statement		N/A
	Terminals have clear polarity marking on the external surface of the battery		P
	Batteries with keyed external connectors designed for connection to specific end products need not be marked with polarity markings if the design of the external connector prevents reverse polarity connections		N/A
<b>9.3</b>	<b>Caution for ingestion of small cells and batteries</b>	Not small cell and battery.	N/A
	Coin cells and batteries identified as small batteries according to 8.2 include a caution statement regarding the hazards of ingestion in accordance with 8.2		N/A
	When small cells and batteries are intended for direct sale in consumer-replaceable applications, caution for ingestion given on the immediate package		N/A
<b>9.4</b>	<b>Other information</b>		P
	Storage and disposal instructions	Information for storage and disposal instructions mentioned in manufacturer's specifications.	P
	Recommended charging instructions	Information for recommended charging instructions mentioned in manufacturer's specifications.	P
<b>10</b>	<b>PACKAGING AND TRANSPORT</b>		P



IEC 62133-2			
Clause	Requirement + Test	Result - Remark	Verdict
	Packaging for coin cells not small enough to fit within the limits of the ingestion gauge of Figure 3	Not coin cells.	N/A
	The materials and packaging design are chosen so as to prevent the development of unintentional electrical conduction, corrosion of the terminals and ingress of environmental contaminants		P

<b>ANNEX A</b>	<b>CHARGING AND DISCHARGING RANGE OF SECONDARY LITHIUM ION CELLS FOR SAFE USE</b>		<b>P</b>
<b>A.1</b>	<b>General</b>		<b>P</b>
<b>A.2</b>	<b>Safety of lithium ion secondary battery</b>	Complied.	<b>P</b>
<b>A.3</b>	<b>Consideration on charging voltage</b>	Complied.	<b>P</b>
A.3.1	General		<b>P</b>
A.3.2	Upper limit charging voltage	4.2V.	<b>P</b>
A.3.2.1	General		<b>P</b>
A.3.2.2	Explanation of safety viewpoint		<b>N/A</b>
A.3.2.3	Safety requirements, when different upper limit charging voltage is applied		<b>N/A</b>
<b>A.4</b>	<b>Consideration of temperature and charging current</b>		<b>P</b>
A.4.1	General		<b>P</b>
A.4.2	Recommended temperature range	See A.4.2.2.	<b>P</b>
A.4.2.1	General		<b>P</b>
A.4.2.2	Safety consideration when a different recommended temperature range is applied	Charging temperature declared by client is: 10-45°C	<b>N/A</b>
A.4.3	High temperature range	Not higher than the temperature range specific in this standard.	<b>N/A</b>
A.4.3.1	General		<b>N/A</b>
A.4.3.2	Explanation of safety viewpoint		<b>N/A</b>
A.4.3.3	Safety considerations when specifying charging conditions in the high temperature range		<b>N/A</b>
A.4.3.4	Safety considerations when specifying a new upper limit in the high temperature range		<b>N/A</b>
A.4.4	Low temperature range	Charging lower temperature declared by client is: 10°C	<b>N/A</b>
A.4.4.1	General		<b>N/A</b>
A.4.4.2	Explanation of safety viewpoint		<b>N/A</b>
A.4.4.3	Safety considerations, when specifying charging conditions in the low temperature range		<b>N/A</b>
A.4.4.4	Safety considerations when specifying a new lower limit in the low temperature range		<b>N/A</b>

IEC 62133-2			
Clause	Requirement + Test	Result - Remark	Verdict
A.4.5	Scope of the application of charging current		P
A.4.6	Consideration of discharge		P
A.4.6.1	<b>General</b>		P
A.4.6.2	Final discharge voltage and explanation of safety viewpoint	Battery specified final voltage 3.0V, not exceed the final voltage specified by cell manufacturer.	P
A.4.6.3	Discharge current and temperature range		P
A.4.6.4	Scope of application of the discharging current		P
<b>A.5</b>	<b>Sample preparation</b>		P
A.5.1	General		P
A.5.2	Insertion procedure for nickel particle to generate internal short		P
A.5.3	Disassembly of charged cell		P
A.5.4	Shape of nickel particle		P
A.5.5	Insertion of nickel particle in cylindrical cell		N/A
A.5.5.1	Insertion of nickel particle in winding core		N/A
A.5.5.2	Marking the position of the nickel particle on both ends of the winding core of the separator		N/A
A.5.6	Insertion of nickel particle in prismatic cell		P
<b>A.6</b>	<b>Experimental procedure of the forced internal short-circuit test</b>		P
A.6.1	Material and tools for preparation of nickel particle		P
A.6.2	Example of a nickel particle preparation procedure		P
A.6.3	Positioning (or placement) of a nickel particle		P
A.6.4	Damaged separator precaution		P
A.6.5	Caution for rewinding separator and electrode		P
A.6.6	Insulation film for preventing short-circuit		P
A.6.7	Caution when disassembling a cell		P
A.6.8	Protective equipment for safety		P
A.6.9	Caution in the case of fire during disassembling		P
A.6.10	Caution for the disassembling process and pressing the electrode core		P
A.6.11	Recommended specifications for the pressing device		P
<b>ANNEX B</b>	<b>RECOMMENDATIONS TO EQUIPMENT MANUFACTURERS AND BATTERY ASSEMBLERS</b>		N/A
<b>ANNEX C</b>	<b>RECOMMENDATIONS TO THE END-USERS</b>		N/A

IEC 62133-2			
Clause	Requirement + Test	Result - Remark	Verdict

<b>ANNEX D</b>		<b>MEASUREMENT OF THE INTERNAL AC RESISTANCE FOR COIN CELLS</b>		N/A
<b>D.1</b>	<b>General</b>	Not coin cells.		N/A
<b>D.2</b>	<b>Method</b>			N/A
	A sample size of three coin cells is required for this measurement..... :	(See appended table D.2)		N/A
	Coin cells with an internal resistance of less than or equal to 3 $\Omega$ are subjected to the testing according to Clause 6 and Table 1			N/A
	Coin cells with an internal resistance greater than 3 $\Omega$ require no further testing			N/A

<b>ANNEX E</b>		<b>PACKAGING AND TRANSPORT</b>		N/A
----------------	--	--------------------------------	--	-----

<b>ANNEX F</b>		<b>COMPONENT STANDARDS REFERENCES</b>		N/A
----------------	--	---------------------------------------	--	-----

TABLE: Critical components information					P
Object/part no.	Manufacturer/trademark	Type/model	Technical data	Standard	Mark(s) of conformity <sup>1)</sup>
PCB	Shenzhen Depu Micro Electronics Co., Ltd.	LS-1635	Thickness min. 0.6mm, ,94vo	--	UL E255989
IC	Shenzhen Depu Micro Electronics Co., Ltd.	DW01 SOT-23-6	Overcharge protection voltage: 4.28±0.05V, Over discharge protection voltage: 2.4±0.1V, Discharging overcurrent detection voltage: 0.15V±0.08V	--	Test with appliance
MOSFET	Shenzhen Depu Micro Electronics Co., Ltd.	8205A TSSOP-8	VDS= 20V, VGS= ±8V, Id= 4A	--	Tested with appliance
Wire	Dong guan Huiwang Electronic Technoigy Co.,Ltd	UL1007 30AWG	30V 80°C	--	--
Cell	Zaoyang Shuoyue Electronics Co., Ltd.	402030-180mAh	Rated Voltage: 3,7 Vd.c., Rated Capacity:180 mAh	IEC 62133 - 2: 2017	Tested with appliance
- Electrolyte	Dongguan Tianfeng Power Material Co.Ltd.	TF-3105B	LiPF6,EC,DEC,EMC	--	--
-Separator	Shenzhen Yitu New material Industry Co., Ltd.	YT16	PP · 16µm(Thickness) ×38mm (Width) ×336mm(Length Shutdown temperature:120°C	--	--
-Positive electrode	Jiangmen KANHO O Industry Co., LTD.	LCO-103	LiCoO2,Specific surface area: 0.21m2/g,Vibration solid density: 3.38g/cm3 Particle size D50: 12.43µm	--	--
-Negative electrode	Shenzhen Xingmao New Energy Tech Co., LTD.	Q20	Graphite, Particle size D50: 17.63µm Tap density: 0.95g/ml, Specific surface area: 5.8 m2/g	--	--
-Positive electrode tab	Dongguan Yingyue Electronic Co., Ltd.	0.1mm(T)*1.5 mm(W)	aluminum	--	--
-Negative electrode tab	Dongguan Yingyue Electronic Co., Ltd.	0.1mm(T)*1.5 mm(W)	nickel	--	--
-Aluminum plastic film	Dai Nippon Printing Co.,Ltd	D-EL40H(3)A	Thickness:0.111±0.010mm	--	--
<b>Supplementary information:</b>					
<sup>1)</sup> Provided evidence ensures the agreed level of compliance. See OD-CB2039.					

7.2.1	TABLE: Continuous charging at constant voltage (cells)				P
Sample no.	Recommended charging voltage Vc (Vdc)	Recommended charging current I <sub>rec</sub> (A)	OCV before test (Vdc)	Results	
Cell #1	4.20	0.09	4.19	P	
Cell #2	4.20	0.09	4.18	P	
Cell #3	4.20	0.09	4.19	P	
Cell #4	4.20	0.09	4.18	P	
Cell #5	4.20	0.09	4.19	P	
<b>Supplementary information:</b>					
- No fire or explosion					
- No leakage					

7.3.1	TABLE: External short-circuit (cell)					P
Sample no.	Ambient T (°C)	OCV before test (Vdc)	Resistance of circuit (mΩ)	Maximum case temperature rise ΔT, °C	Results	
<b>Samples charged at charging temperature upper limit (45°C)</b>						
Cell 6#	55.3	4.15	88.0	87.1	P	
Cell 7#	55.3	4.14	86.0	91.2	P	
Cell 8#	55.3	4.15	88.0	87.6	P	
Cell 9#	55.3	4.15	84.0	84.3	P	
Cell 10#	55.3	4.14	89.0	89.3	P	
<b>Samples charged at charging temperature lower limit (10°C)</b>						
Cell 11#	55.5	4.06	86.0	82.7	P	
Cell 12#	55.5	4.05	87.0	82.4	P	
Cell 13#	55.5	4.05	86.0	89.4	P	
Cell 14#	55.5	4.04	87.0	90.6	P	
Cell 15#	55.5	4.05	85.0	93.9	P	
<b>Supplementary information:</b>						
- No fire or explosion						

7.3.2	TABLE: External short-circuit (battery)					P
Sample no.	Ambient T (°C)	OCV before test (Vdc)	Resistance of circuit (mΩ)	Maximum case temperature rise $\Delta T$ , °C	Component single fault condition	Results
Battery 4#	23.7	4.18	85.0	58.1	SC-MOS(U2)	P
Battery 5#	23.7	4.18	83.0	56.9	SC-IC(U1)	P
Battery 6#	23.7	4.17	81.0	23.9	No	P
Battery 7#	23.7	4.17	88.0	23.8	No	P
Battery 8#	23.7	4.18	89.0	24.1	No	P
<b>Supplementary information:</b>						
- No fire or explosion						

7.3.5	TABLE: Crush (cells)				P
Sample no.	OCV before test (Vdc)	OCV at removal of crushing force (Vdc)	Maximum force applied to the cell during crush (kN)	Results	
<b>Samples charged at charging temperature upper limit (45°C)</b>					
Cell 29#	4.14	4.13	13.0	P	
Cell 30#	4.14	4.14	13.0	P	
Cell 31#	4.15	4.14	13.0	P	
Cell 32#	4.16	4.15	13.0	P	
Cell 33#	4.15	4.14	13.0	P	
<b>Samples charged at charging temperature lower limit (10°C)</b>					
Cell 34#	4.05	4.05	13.0	P	
Cell 35#	4.04	4.04	13.0	P	
Cell 36#	4.05	4.04	13.0	P	
Cell 37#	4.06	4.05	13.0	P	
Cell 38#	4.06	4.06	13.0	P	
<b>Supplementary information:</b>					
- No fire or explosion					

7.3.6		TABLE: Over-charging of battery			P
Constant charging current (A) .....		0.36			—
Supply voltage (Vdc) .....		5.88			—
Sample no.	OCV before charging (Vdc)	Total charging time (minute)	Maximum outer case temperature (°C)	Results	
Battery 12#	3.15	165	29.3	P	
Battery 13#	3.16	160	26.5	P	
Battery 14#	3.16	153	26.8	P	
Battery 15#	3.15	169	26.6	P	
Battery 16#	3.16	167	29.2	P	
<b>Supplementary information:</b>					
- No fire or explosion					

7.3.7		TABLE: Forced discharge (cells)			P
Sample no.	OCV before application of reverse charge (Vdc)	Measured reverse charge $I_t$ (A)	Lower limit discharge voltage (Vdc)	Results	
Cell 39#	3.16	0.18	3.0	P	
Cell 40#	3.17	0.18	3.0	P	
Cell 41#	3.16	0.18	3.0	P	
Cell 42#	3.16	0.18	3.0	P	
Cell 43#	3.15	0.18	3.0	P	
<b>Supplementary information:</b>					
- No fire or explosion					

7.3.8.1		TABLE: Vibration				P
Sample no.	OCV before test (Vdc)	OCV after test (Vdc)	Mass before test (g)	Mass after test (g)	Results	
Battery 17#	4.18	4.18	4.451	4.405	P	
Battery 18#	4.19	4.18	4.677	4.614	P	
Battery 19#	4.18	4.18	4.626	4.580	P	
<b>Supplementary information:</b>						
- No fire or explosion						
- No rupture						
- No leakage						
- No venting						

7.3.8.2	TABLE: Mechanical shock					P
Sample no.	OCV before test (Vdc)	OCV after test (Vdc)	Mass before test (g)	Mass after test (g)	Results	
Battery 20#	4.19	4.18	4.636	4.591	P	
Battery 21#	4.18	4.17	4.480	4.439	P	
Battery 22#	4.18	4.18	4.505	4.461	P	
<b>Supplementary information:</b>						
<ul style="list-style-type: none"> <li>- No fire or explosion</li> <li>- No rupture</li> <li>- No leakage</li> <li>- No venting</li> </ul>						

7.3.9	TABLE: Forced internal short circuit (cells)					P
Sample no.	Chamber ambient T (°C)	OCV before test (Vdc)	Particle location <sup>1)</sup>	Maximum applied pressure (N)	Results	
<b>Samples charged at charging temperature upper limit (45°C)</b>						
Cell 44#	45	4.14	1	400	P	
Cell 45#	45	4.15	1	400	P	
Cell 46#	45	4.14	1	400	P	
Cell 47#	45	4.14	1	400	P	
Cell 48#	45	4.15	1	400	P	
<b>Samples charged at charging temperature lower limit (10°C)</b>						
Cell 49#	10	4.06	1	400	P	
Cell 50#	10	4.05	1	400	P	
Cell 51#	10	4.06	1	400	P	
Cell 52#	10	4.05	1	400	P	
Cell 53#	10	4.05	1	400	P	
<b>Supplementary information:</b>						
<sup>1)</sup> Identify one of the following: <ul style="list-style-type: none"> <li>1: Nickel particle inserted between positive and negative (active material) coated area.</li> <li>2: Nickel particle inserted between positive aluminium foil and negative active material coated area.</li> </ul> <ul style="list-style-type: none"> <li>- No fire</li> </ul>						

D.2	TABLE: Internal AC resistance for coin cells				N/A
Sample no.	Ambient T (°C)	Store time (h)	Resistance Rac (Ω)	Results <sup>1)</sup>	
<b>Supplementary information:</b>					
<sup>1)</sup> Coin cells with internal resistance less than or equal to 3 Ω, see test result on corresponding tables					



**Attachment: Photos of the product:**

Product: Polymer Lithium Ion Battery

Type Designation: 402030

Figure 1 Front view of battery

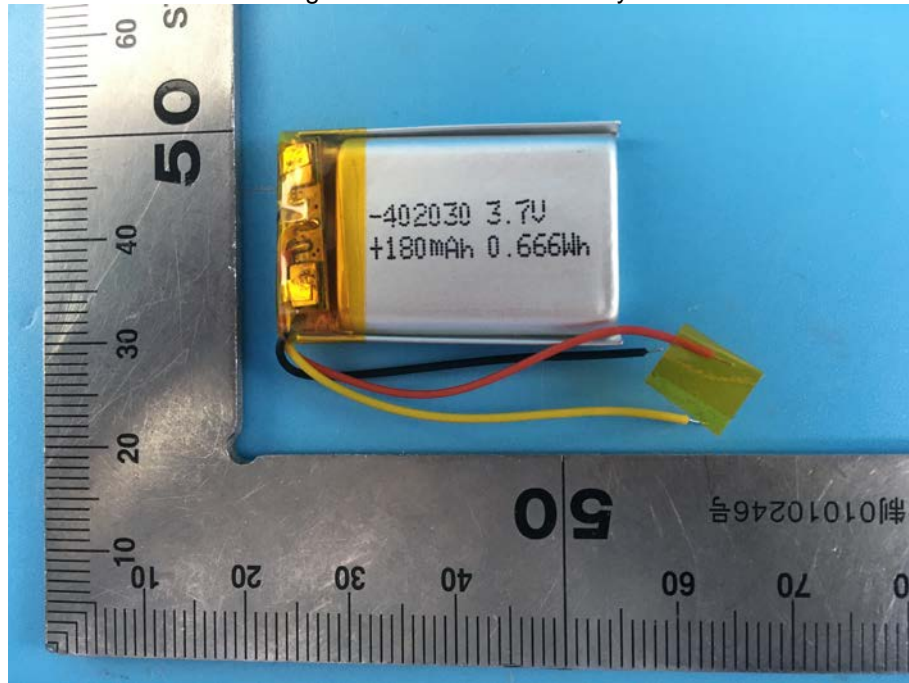
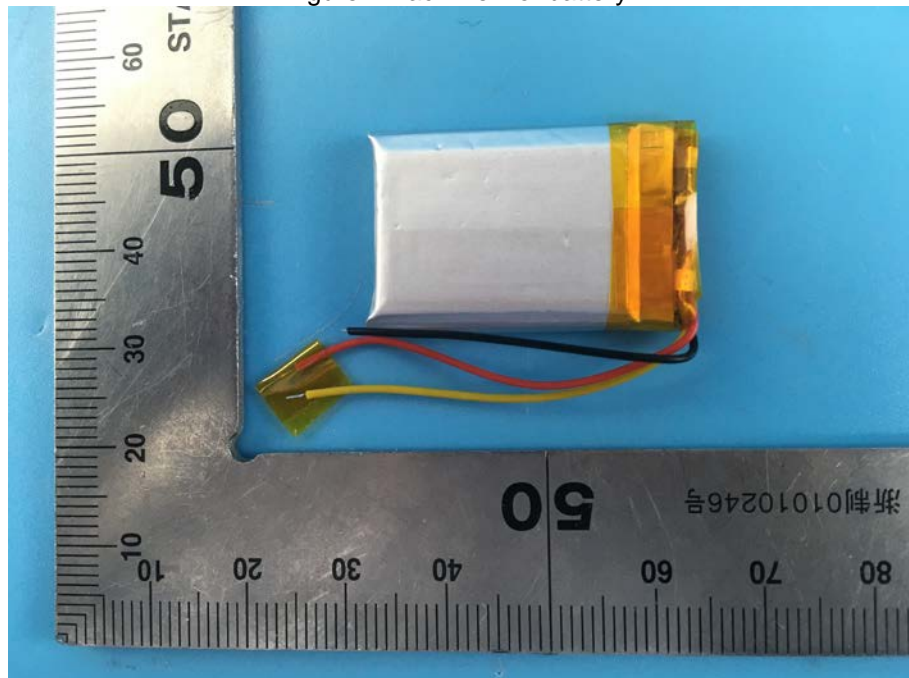

Figure 2 Back view of battery



**Attachment: Photos of the product:**

Product: Polymer Lithium Ion Battery

Type Designation: 402030

Figure 3 Internal view of battery pack A

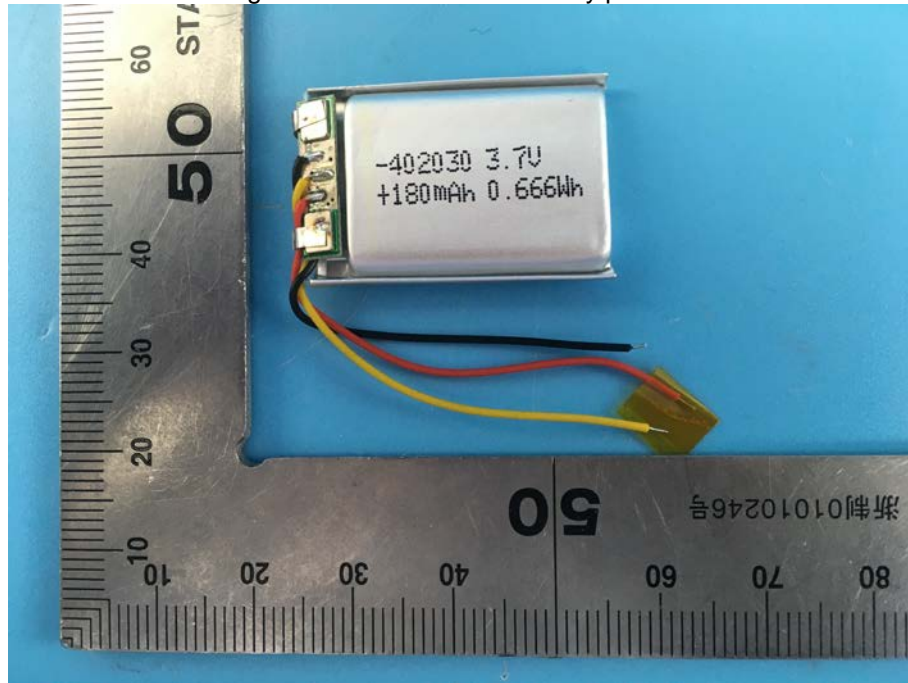
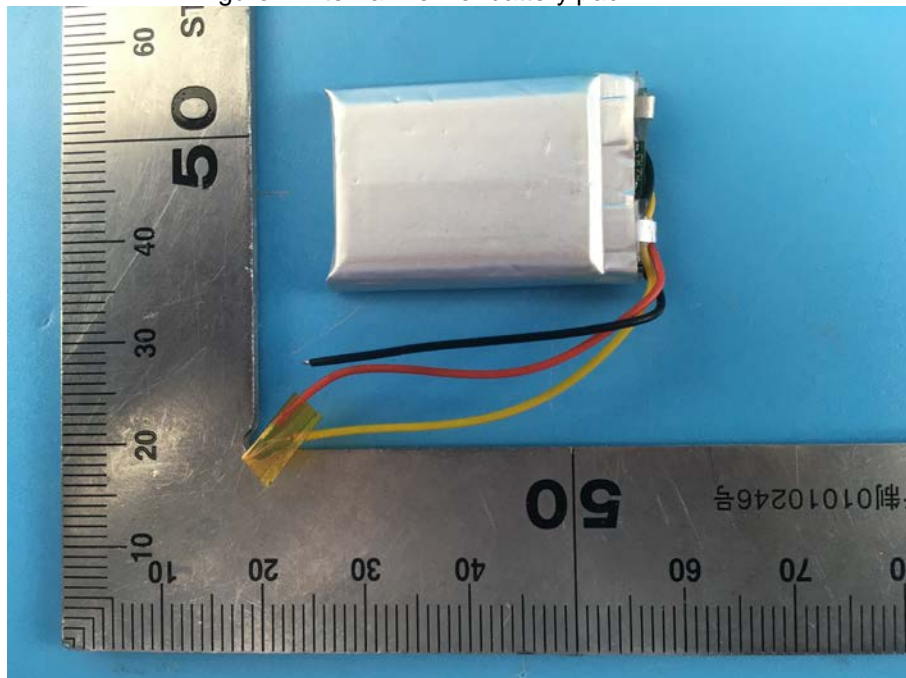

Figure 4 Internal view of battery pack B



**Attachment: Photos of the product:**

Product: Polymer Lithium Ion Battery

Type Designation: 402030

Figure 5 PCB View of side A

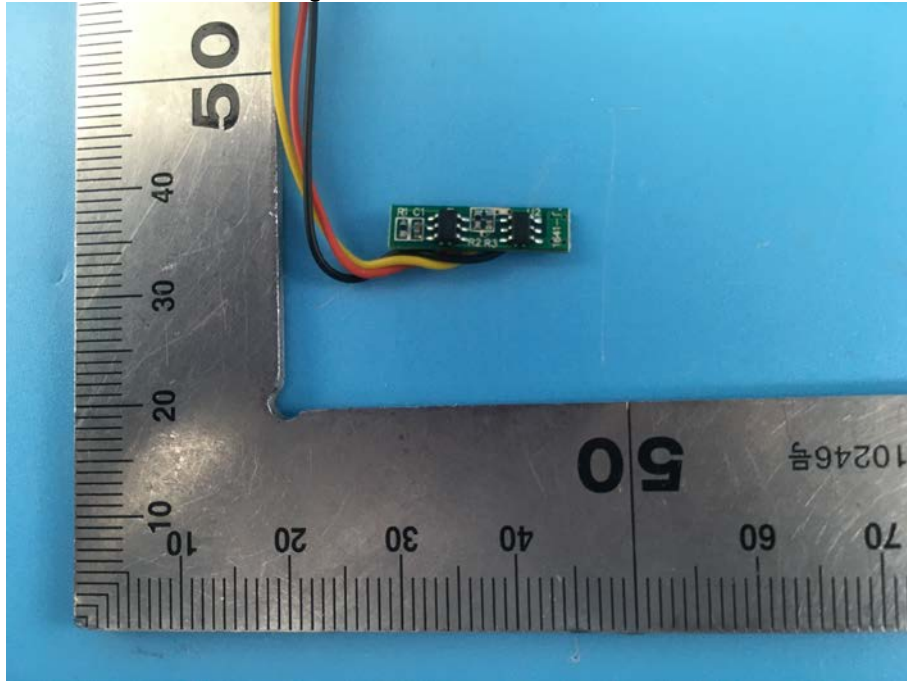
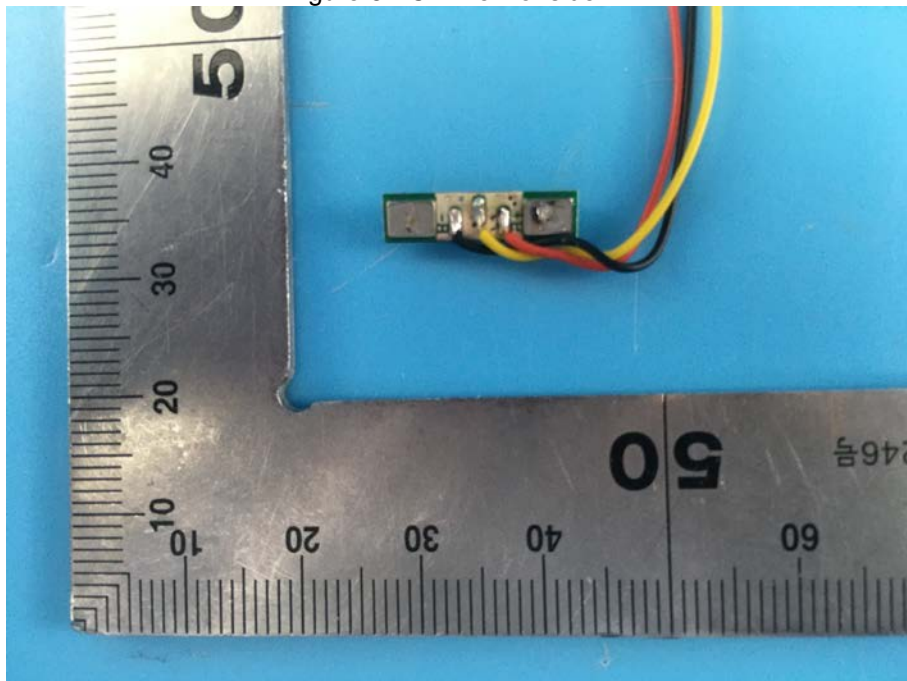

Figure 6 PCB View of side B





**Attachment: Photos of the product:**

Product: Polymer Lithium Ion Battery

Type Designation: 402030

Figure 7 Front view of component cell

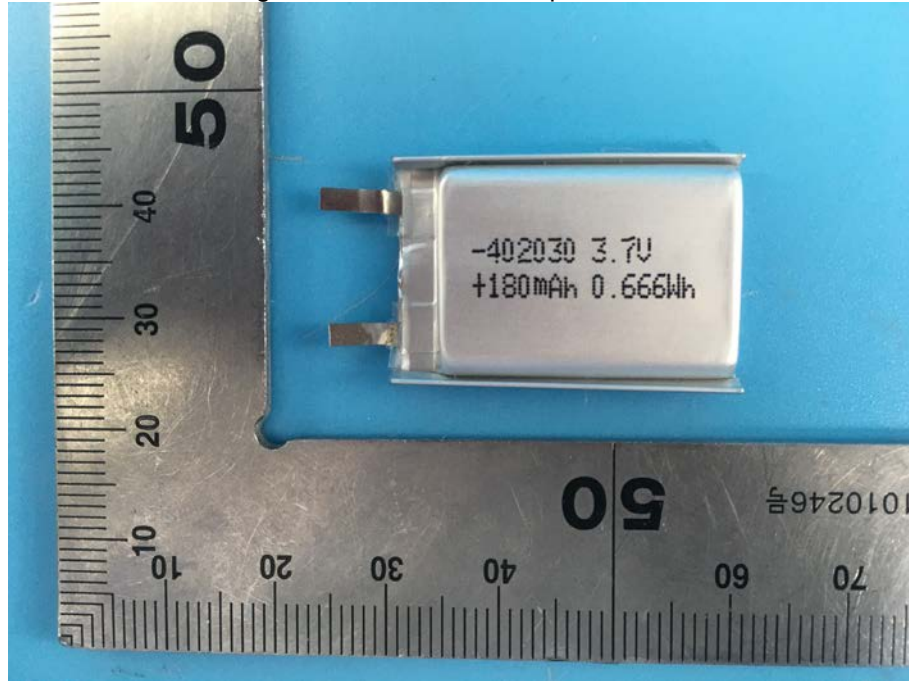
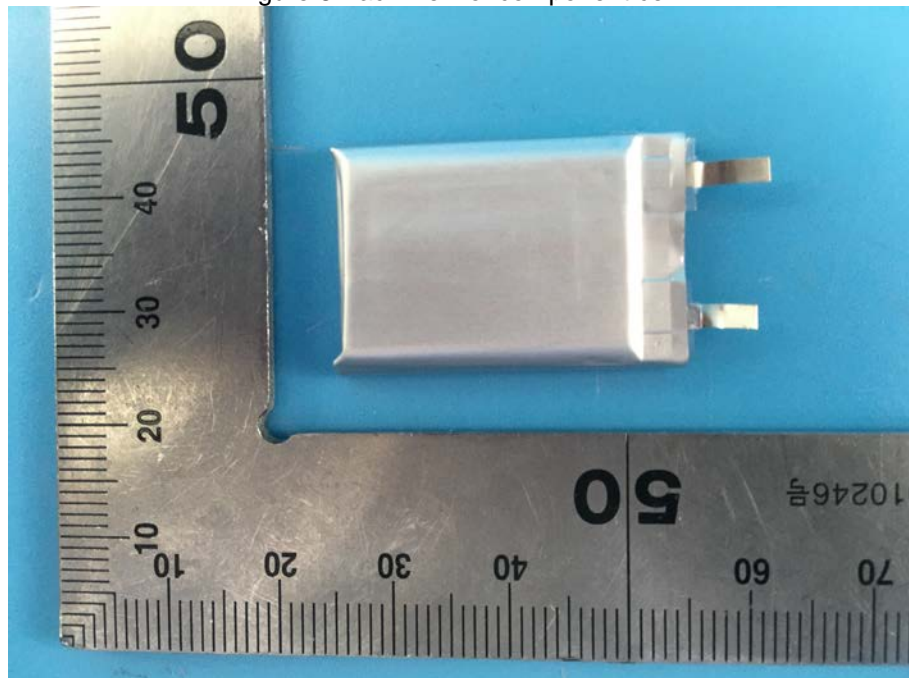

Figure 8 Back view of component cell



-- End of Report --