



TEST REPORT

Reference No...... : WTX22X07147399E
Applicant : SHENZHEN MONOKO TECHNOLOGY CO.,LTD.
Address : Room 507, Building 10, Yungu Phase 2, No.2, Pingshan First Road,
Taoyuan street, Nanshan District, Shenzhen, China
Manufacturer : SHENZHEN MONOKO TECHNOLOGY CO.,LTD.
Address : Room 507, Building 10, Yungu Phase 2, No.2, Pingshan First Road,
Taoyuan street, Nanshan District, Shenzhen, China
Product Name : aluminium alloy nylon braided cable
Model No...... : US220-01, US220-02, US220-03, US220-04
Standards : **EN 55032:2015+A11:2020**
EN 55035:2017+A11:2020
Date of Receipt sample : 2022-05-16
Date of Test..... : 2022-05-16 to 2022-05-24
Date of Issue : 2022-07-20
Test Report Form No. : WTX_EN 55032_2015B
Test Result..... : **Pass**

Remarks:

The results shown in this test report refer only to the sample(s) tested, this test report cannot be reproduced, except in full, without prior written permission of the company. The report would be invalid without specific stamp of test institute and the signatures of approver.

Prepared By:

Waltek Testing Group (Shenzhen) Co., Ltd.

Address: 1/F., Room 101, Building 1, Hongwei Industrial Park, Liuxian 2nd Road,
Block 70 Bao'an District, Shenzhen, Guangdong, China

Tel.: +86-755-33663308 Fax.: +86-755-33663309 Email: sem@waltek.com.cn

Tested by:

Dace huang

Approved by:

Silin Chen



TABLE OF CONTENTS

REVISION HISTORY4

1. GENERAL INFORMATION.....5

1.1 PRODUCT DESCRIPTION FOR EQUIPMENT UNDER TEST (EUT).....5

1.2 TEST STANDARDS.....6

1.3 TEST METHODOLOGY.....6

1.4 EUT SETUP AND OPERATION MODE7

1.5 PERFORMANCE CRITERIA FOR EMS7

1.6 TEST EQUIPMENT LIST AND DETAILS8

2. SUMMARY OF TEST RESULTS10

3. CONDUCTED EMISSION.....11

3.1 MEASUREMENT UNCERTAINTY11

3.2 BASIC TEST SETUP BLOCK DIAGRAM.....11

3.3 ENVIRONMENTAL CONDITIONS12

3.4 SUMMARY OF TEST RESULTS12

4. RADIATED EMISSION15

4.1 MEASUREMENT UNCERTAINTY15

4.2 BASIC TEST SETUP BLOCK DIAGRAM.....15

4.3 CORRECTED AMPLITUDE & MARGIN CALCULATION.....16

4.4 ENVIRONMENTAL CONDITIONS16

4.5 SUMMARY OF TEST RESULTS16

5. ELECTROSTATIC DISCHARGES (ESD)21

5.1 TEST PROCEDURE.....21

5.2 TEST PERFORMANCE21

5.3 ENVIRONMENTAL CONDITIONS.....21

5.4 BASIC TEST SETUP BLOCK DIAGRAM.....21

5.5 ELECTROSTATIC DISCHARGE IMMUNITY TEST DATA22

6. CONTINUOUS RF ELECTROMAGNETIC FIELD DISTURBANCES (RS)23

6.1 TEST PROCEDURE.....23

6.2 TEST PERFORMANCE23

6.3 ENVIRONMENTAL CONDITIONS23

6.4 BASIC TEST SETUP BLOCK DIAGRAM.....23

6.5 CONTINUOUS RADIATED DISTURBANCES TEST DATA24

7. ELECTRICAL FAST TRANSIENTS (EFT)25

7.1 TEST PROCEDURE.....25

7.2 TEST PERFORMANCE25

7.3 ENVIRONMENTAL CONDITIONS.....25

7.4 BASIC TEST SETUP BLOCK DIAGRAM.....25

7.5 ELECTRICAL FAST TRANSIENTS TEST DATA.....26

8. SURGES27

8.1 TEST PROCEDURE.....27

8.2 TEST PERFORMANCE27

8.3 ENVIRONMENTAL CONDITIONS.....27

8.4 BASIC TEST SETUP BLOCK DIAGRAM.....27

8.5 SURGE TEST DATA.....28

9. CONTINUOUS INDUCED RF DISTURBANCES (C/S)29

9.1 TEST PROCEDURE.....29

9.2 TEST PERFORMANCE29

9.3 ENVIRONMENTAL CONDITIONS.....29

9.4 BASIC TEST SETUP BLOCK DIAGRAM.....29

9.5 CONTINUOUS CONDUCTED DISTURBANCES TEST DATA30

10. POWER-FREQUENCY MAGNETIC FIELDS (PFMF)31



Reference No.: WTX22X07147399E

10.1 TEST PROCEDURE.....	31
10.2 TEST PERFORMANCE	31
10.3 ENVIRONMENTAL CONDITIONS.....	31
10.4 BASIC TEST SETUP BLOCK DIAGRAM.....	31
10.5 POWER-FREQUENCY MAGNETIC FIELD TEST DATA.....	32
EXHIBIT 1 - PRODUCT LABELING	33
PROPOSED CE LABEL FORMAT	33
PROPOSED LABEL LOCATION ON EUT	33
EXHIBIT 2 - EUT PHOTOGRAPHS.....	34
EXHIBIT 3 - TEST SETUP PHOTOGRAPHS.....	37

WALTEK



Revision History

Report No.	Version	Description	Issue Date	Note
WTX22X05093402E	Original	Initial report	2022-05-24	Invalid
WTX22X07147399E	Re.1	1. Increase the reported models	2022-07-20	Valid

WALTEK



1. GENERAL INFORMATION

1.1 Product Description for Equipment Under Test (EUT)

General Description of EUT	
Product Name:	aluminium alloy nylon braided cable
Trade Name:	/
Model No.:	US220-01, US220-02, US220-03, US220-04
Adding Model(s):	US320-02, UC422-24, UC420, UC419, UC418, UC417, UC416, UC415, UC415-21R, UC415-22R, UC415-23R, UC415-24R, UC413, UC412, UC410, UC408, UC407, UC406, UC405, UC403, UC402, UC401, UC201, UC103, UC102, UC101, UC101-44, UA401-31, UA402-32, UA402-22, UC302, UC301, US401, UC501-2C, UC502, UC421-28, UC101-28, UC409-2A, UC409-2B, UC409-2C, UC409-2D, UC409-2E, UC409, US130-04, UC411
<p><i>Note: The test data is gathered from a production sample, provided by the manufacturer. The appearance of others models listed in the report is different from main-test model US220-01, US220-02, US220-03, US220-04, but the circuit and the electronic construction do not change, declared by the manufacturer.</i></p>	

Technical Characteristics of EUT	
Rated Voltage:	DC 20V MAX
Rated Current:	/
Rated Power:	/
Power Adaptor Model:	/
Highest Internal Frequency:	Below 108MHz
Classification of Equipment:	Class B



1.2 Test Standards

The tests were performed according to following standards:

EN 55032:2015+A11:2020: Electromagnetic compatibility of multimedia equipment - Emission requirements.

EN 55035:2017+A11:2020: Electromagnetic compatibility of multimedia equipment - Immunity requirements.

Maintenance of compliance is the responsibility of the manufacturer. Any modification of the product maybe which result in lowering the emission/immunity should be checked to ensure compliance has been maintained.

1.3 Test Methodology

All measurements contained in this report were conducted with the standards EN 55032 and EN 55035 for electromagnetic compatibility of multimedia equipment, and all related testing and measurement techniques intentional standards.

WALTEK



1.4 EUT Setup and Operation Mode

The equipment under test (EUT) was configured to measure its highest possible emission/immunity level. The test modes were adapted according to the operation manual for use, more detailed description as follows:

Test Mode List			
Test Mode	Description	Remark	Power Supply Mode
TM1	Working mode	USB connection adapter Type-c Connects to a mobile phone	DC 20V connection adapter work (AC230V/50Hz power supply)
TM2	Working mode	Connect laptop data transfer	DC 5V

EUT Cable List and Details				
Cable Description	Length (m)	Shielded/Unshielded	With / Without Ferrite	With / Without Chip
Cable	1.2	Shielded	Without	With

Special Cable List and Details				
Cable Description	Length (m)	Shielded/Unshielded	With / Without Ferrite	With / Without Chip
/	/	/	/	/

Auxiliary Equipment List and Details			
Description	Manufacturer	Model	Serial Number
iQOO	iQOO5	V2024A	/
adapter	Xiaomi	MDY-12-EQ	/
Notebook	Lenovo	XiaoXinPro 14IHU 2021	/

1.5 Performance Criteria for EMS

All the test data has been collected, reduced, and analyzed within this report in accordance with Immunity requires the following as specific performance criteria:

- A. The apparatus shall continue to operate as intended during and after the test. The manufacturer specifies some minimum performance level. The performance level may be specified by the manufacturer as a permissible loss of performance.
- B. The apparatus shall continue to operate as intended after the test. This indicates that the EUT does not need to function at normal performance levels during the test, but must recover. Again some minimal performance is defined by the manufacturer. No change in operating state or loss of data is permitted.
- C. Temporary loss of function is allowed. Operation of the EUT may stop as long as it is either automatically reset or can be manually restored by operation of the controls.



1.6 Test Equipment List and Details

Description	Manufacturer	Model	Serial No.	Cal. Date	Due. Date
<input type="checkbox"/> Chamber A: Below 1GHz					
Spectrum Analyzer	Rohde & Schwarz	FSP30	836079/035	2022-03-22	2023-03-21
EMI Test Receiver	Rohde & Schwarz	ESVB	825471/005	2022-03-22	2023-03-21
Trilog Broadband Antenna	Schwarz beck	VULB9163	9163-333	2021-03-20	2023-03-19
Loop Antenna	Schwarz beck	FMZB 1516	9773	2021-03-20	2023-03-19
Amplifier	HP	8447F	2805A03475	2022-01-07	2023-01-06
<input type="checkbox"/> Chamber A: Above 1GHz					
Amplifier	C&D	PAP-1G18	2002	2022-03-22	2023-03-21
Horn Antenna	ETS	3117	00086197	2021-03-19	2023-03-18
<input checked="" type="checkbox"/> Chamber B: Below 1GHz					
Trilog Broadband Antenna	Schwarz beck	VULB9163(B)	9163-635	2021-04-09	2023-04-08
Amplifier	Agilent	8447D	2944A10179	2022-03-22	2023-03-21
EMI Test Receiver	Rohde & Schwarz	ESPI	101391	2022-03-25	2023-03-24
<input type="checkbox"/> Chamber C: Below 1GHz					
EMI Test Receiver	Rohde & Schwarz	ESIB 26	100401	2022-01-07	2023-01-06
Trilog Broadband Antenna	Schwarz beck	VULB 9168	1194	2021-05-28	2023-05-27
Amplifier	HP	8447F	2944A03869	2022-03-22	2023-03-21
<input checked="" type="checkbox"/> Conducted Room 1#					
EMI Test Receiver	Rohde & Schwarz	ESPI	101611	2022-03-22	2023-03-21
Pulse Limiter	Rohde & Schwarz	ESH3-Z2	100911	2022-03-25	2023-03-24
AC LISN	Schwarz beck	NSLK8126	8126-224	2022-03-22	2023-03-21
8-WIRE LISN	Schwarz beck	8158	CAT3-8158-0059	2022-03-22	2023-03-21
8-WIRE LISN	Schwarz beck	8158	CAT5-8158-0117	2022-03-22	2023-03-21
<input type="checkbox"/> Conducted Room 2#					
EMI Test Receiver	Rohde & Schwarz	ESPI	10129	2022-03-22	2023-03-21
LISN	Rohde & Schwarz	ENV 216	100097	2022-03-22	2023-03-21
<input type="checkbox"/> Harmonics & Flicker					
Digital Power Analyzer	California Instrument	CTS	72831	2022-03-22	2023-03-21
Power Source	California Instrument	5001IX-CTS-400	25965	2022-03-22	2023-03-21
<input checked="" type="checkbox"/> Electrostatic discharges					
ESD Generator	LIONCEL	ESD-203B	0170901	2022-03-28	2023-03-27
<input checked="" type="checkbox"/> Power-frequency magnetic field (PFMF)					
PMF Generator	LIONCEL	PMF-801C-C	0171101	2022-03-22	2023-03-21
PMF Antenna	LIONCEL	PMF-801C-A	0180302	2022-03-22	2023-03-21



Instantaneous PMF Generator Module	LIONCEL	PMF-801C-T	0171001	2022-03-22	2023-03-21
<input type="checkbox"/> Electronic fast transient(EFT)/Surges/Dips					
Transient 2000	EMC PARTNER	TRA2000	863	2022-03-22	2023-03-21
Couple Clamp	EMC PARTNER	CN-EFT1000	513	2022-03-22	2023-03-21
<input type="checkbox"/> Radio frequency, continuous conducted (C/S)					
CONDUCTED IMMUNITY TEST SYSTEM	FRANKONIA	CIT-10/75	126B1247/2013	2022-01-07	2023-01-06
Attenuator	EMTEST	MA-5100/6BF2	1009	2022-03-22	2023-03-21
CDN	Luthi	L-801M2/M3	2665	2022-03-22	2023-03-21
CDN	LIONCEL	CDN-T8	0210401	2022-03-25	2023-03-24
EM Clamp	TESEQ	KEMZ801A	45028	2022-03-25	2023-03-24
<input checked="" type="checkbox"/> Radio frequency electromagnetic Field (R/S)					
Signal Generator	HP	8688B	3438A00604	2022-03-22	2023-03-21
Power Sensor	Agilent	E9301A	MY52450001	2022-03-25	2023-03-24
Power Sensor	Agilent	E9304A	MY55081055	2022-03-25	2023-03-24
RF Power Amplifier	MicoTop	MPA-80-1000-250	MPA1906239	2022-03-22	2023-03-21
RF Power Amplifier	MicoTop	MPA-1000-6000-100	MPA1906238	2022-03-22	2023-03-21
Antenna	SCHWARZBECK	STLP 9129	9129 114	N/A	N/A
Power Meter	Agilent	E4419B	GB42420578	2022-03-22	2023-03-21



2. SUMMARY OF TEST RESULTS

Standards	Description of Test Item	Result
EN 55032	Conducted Emission	Compliant
	Radiated Emission	Compliant
EN IEC 61000-3-2	Harmonic Current Emission	N/A
EN 61000-3-3	Voltage Fluctuation and Flicker	N/A
EN 55035	Electrostatic Discharge Immunity in accordance with EN 61000-4-2	Compliant
	Continuous RF electromagnetic field Disturbances Immunity in accordance with EN 61000-4-3	Compliant
	Electrical Fast Transient/Burst Immunity in accordance with EN 61000-4-4	N/A
	Surges Immunity in accordance with EN 61000-4-5	N/A
	Continuous induced RF disturbances Immunity in accordance with EN 61000-4-6	N/A
	Power-frequency Magnetic Fields Immunity in accordance With EN 61000-4-8	Compliant
	Voltage Dips/Interruptions Immunity in accordance with EN 61000-4-11	N/A
	Broadband impulse noise disturbances, repetitive	N/A
Broadband impulse noise disturbances, isolated	N/A	

N/A: not applicable



3. Conducted Emission

3.1 Measurement Uncertainty

Base on NIS 81, The Treatment of Uncertainty in EMC Measurements, the best estimate of the uncertainty of any conducted emissions measurement:

Measurement uncertainty		
Parameter	Conditions	Uncertainty
Conducted Emissions	Conducted	9-150kHz ±3.74dB
		0.15-30MHz ±3.34dB

3.2 Basic Test Setup Block Diagram

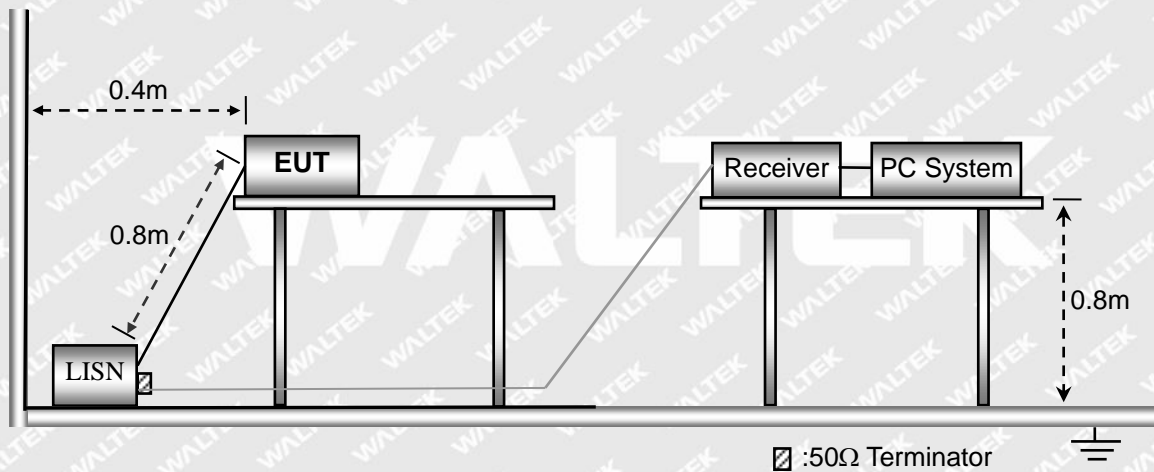



3.3 Environmental Conditions

Temperature:	21.5 °C
Relative Humidity:	48 %
ATM Pressure:	1012 mbar

3.4 Summary of Test Results

Please find the results below:

WALTEK



Test mode:	TM1	Polarity:	Line
------------	-----	-----------	------

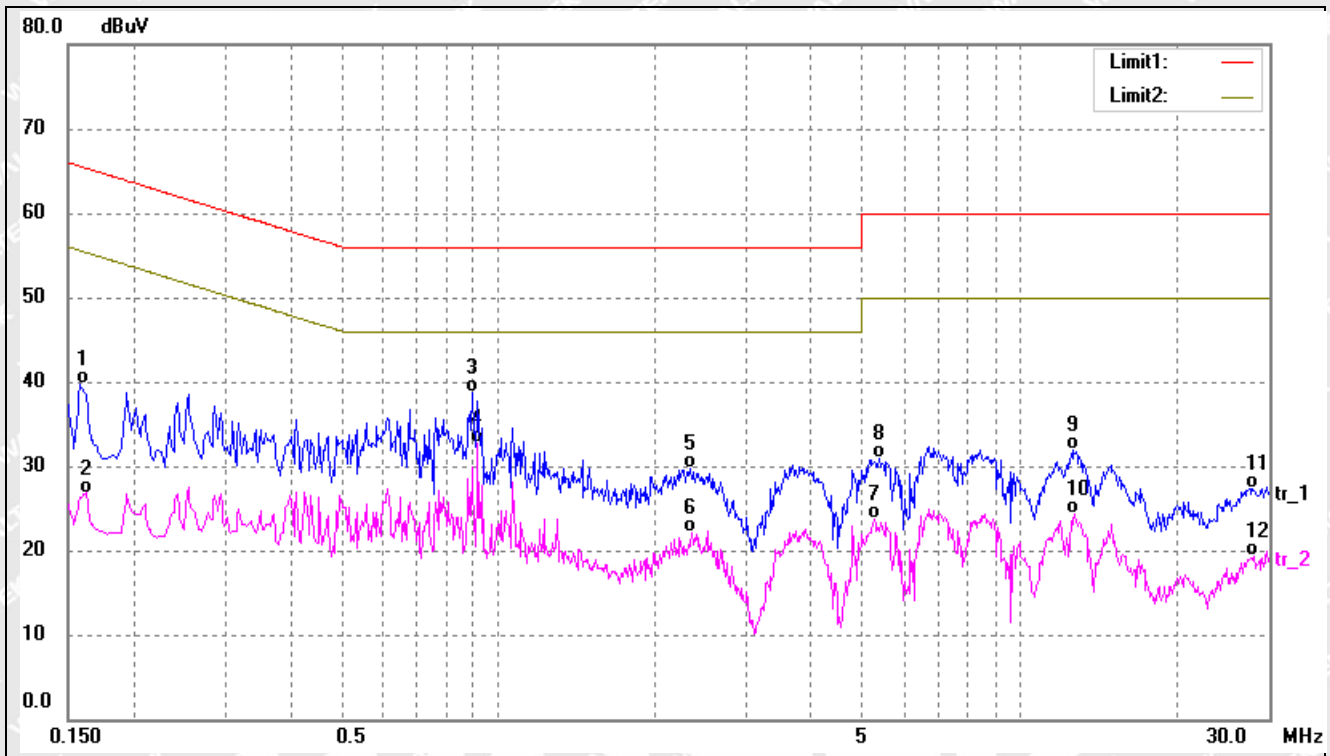

No.	Frequency (MHz)	Reading (dBuV)	Correct (dB)	Result (dBuV)	Limit (dBuV)	Margin (dB)	Detector
1	0.1580	29.24	10.37	39.61	65.56	-25.95	QP
2	0.1620	16.43	10.37	26.80	55.36	-28.56	AVG
3	0.8900	28.24	10.49	38.73	56.00	-17.27	QP
4*	0.9140	22.26	10.51	32.77	46.00	-13.23	AVG
5	2.3420	19.50	10.12	29.62	56.00	-26.38	QP
6	2.3500	12.04	10.11	22.15	46.00	-23.85	AVG
7	5.2580	13.68	9.99	23.67	50.00	-26.33	AVG
8	5.3820	20.93	9.99	30.92	60.00	-29.08	QP
9	12.7060	21.81	10.02	31.83	60.00	-28.17	QP
10	12.7700	14.20	10.03	24.23	50.00	-25.77	AVG
11	27.9260	17.06	10.23	27.29	60.00	-32.71	QP
12	28.0660	9.00	10.23	19.23	50.00	-30.77	AVG



Test mode:	TM1	Polarity:	Neutral
------------	-----	-----------	---------

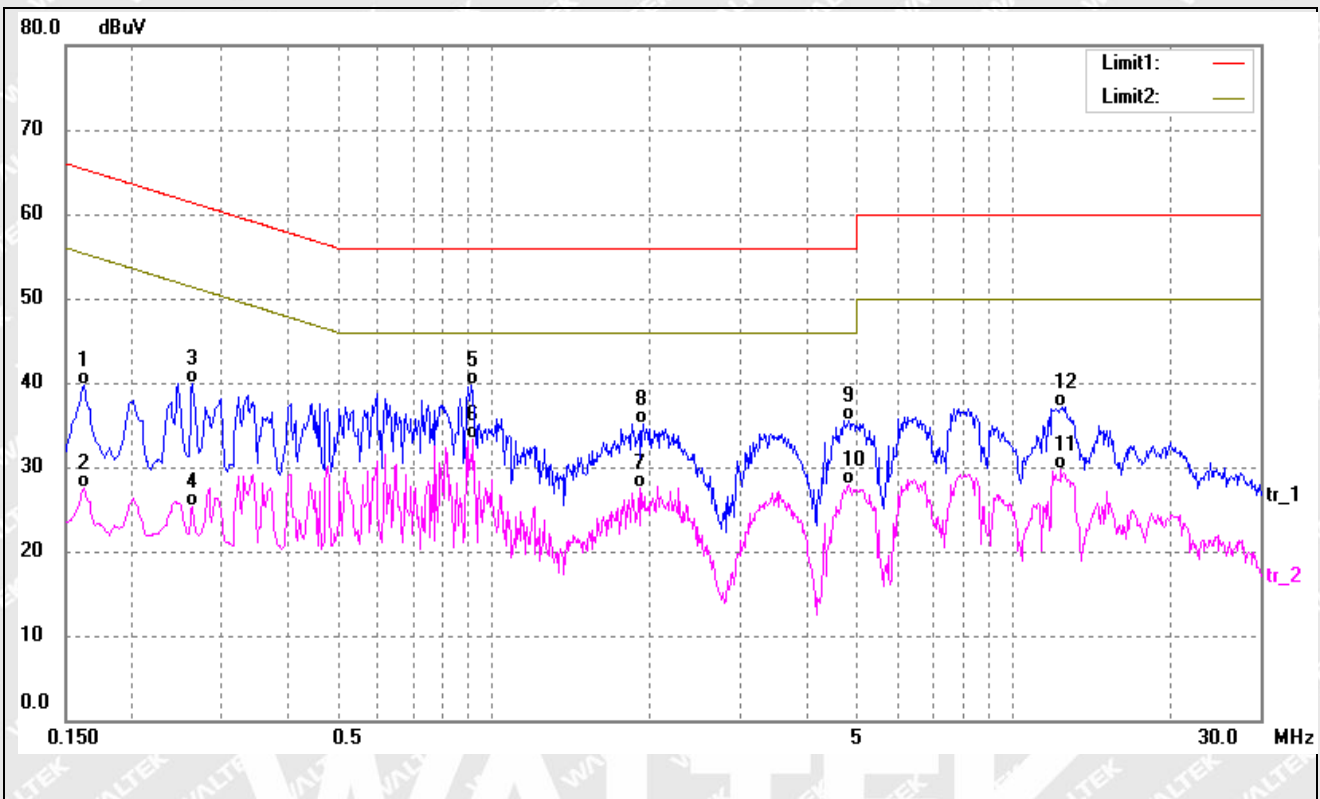

No.	Frequency (MHz)	Reading (dBuV)	Correct (dB)	Result (dBuV)	Limit (dBuV)	Margin (dB)	Detector
1	0.1620	29.40	10.37	39.77	65.36	-25.59	QP
2	0.1620	17.16	10.37	27.53	55.36	-27.83	AVG
3	0.2620	29.53	10.35	39.88	61.36	-21.48	QP
4	0.2620	14.96	10.35	25.31	51.36	-26.05	AVG
5	0.9060	29.11	10.50	39.61	56.00	-16.39	QP
6*	0.9140	22.84	10.51	33.35	46.00	-12.65	AVG
7	1.9100	17.38	10.17	27.55	46.00	-18.45	AVG
8	1.9460	24.93	10.15	35.08	56.00	-20.92	QP
9	4.8380	25.45	10.01	35.46	56.00	-20.54	QP
10	4.8380	17.80	10.01	27.81	46.00	-18.19	AVG
11	12.4460	19.73	10.01	29.74	50.00	-20.26	AVG
12	12.4780	27.04	10.01	37.05	60.00	-22.95	QP



4. Radiated Emission

4.1 Measurement Uncertainty

Base on NIS 81, The Treatment of Uncertainty in EMC Measurements, the best estimate of the uncertainty of any radiation emissions measurement:

Measurement uncertainty		
Parameter	Conditions	Uncertainty
Radiated Emissions	Radiated	30-200MHz $\pm 4.52\text{dB}$
		0.2-1GHz $\pm 5.56\text{dB}$
		1-6GHz $\pm 3.84\text{dB}$
		6-18GHz $\pm 3.92\text{dB}$

4.2 Basic Test Setup Block Diagram

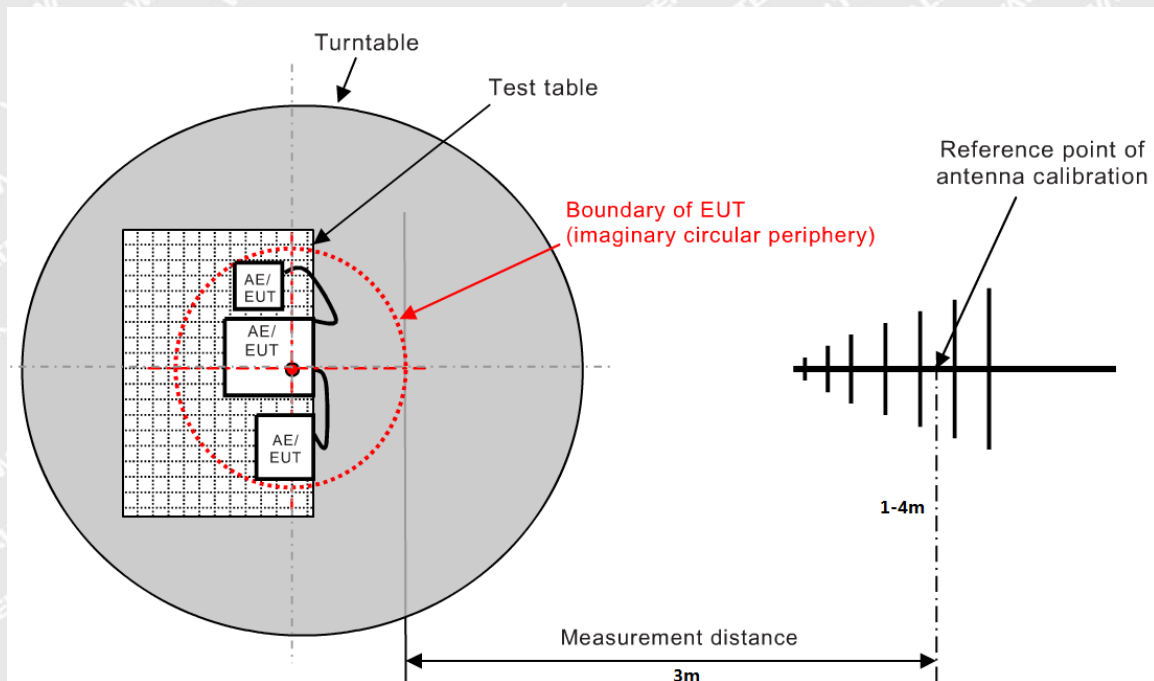



4.3 Corrected Amplitude & Margin Calculation

The Corrected Amplitude is calculated by adding the Antenna Factor and the Cable Factor, and subtracting the Amplifier Gain from the Amplitude reading. The basic equation is as follows:

$$\text{Corr. Ampl.} = \text{Indicated Reading} + \text{Correct Correct} = \text{Ant. Factor} + \text{Cable Loss} - \text{Ampl. Gain}$$

The “**Margin**” column of the following data tables indicates the degree of compliance with the applicable limit. For example, a margin of -6dB μ V means the emission is 6dB μ V below the maximum limit for Class B device. The equation for margin calculation is as follows:

$$\text{Margin} = \text{Corr. Ampl.} - \text{EN 55032 Class B Limit}$$

4.4 Environmental Conditions

Temperature:	22.5 °C
Relative Humidity:	51 %
ATM Pressure:	1010 mbar

4.5 Summary of Test Results

Please find the results below:



Test mode:	TM1	Polarity:	Horizontal
------------	-----	-----------	------------

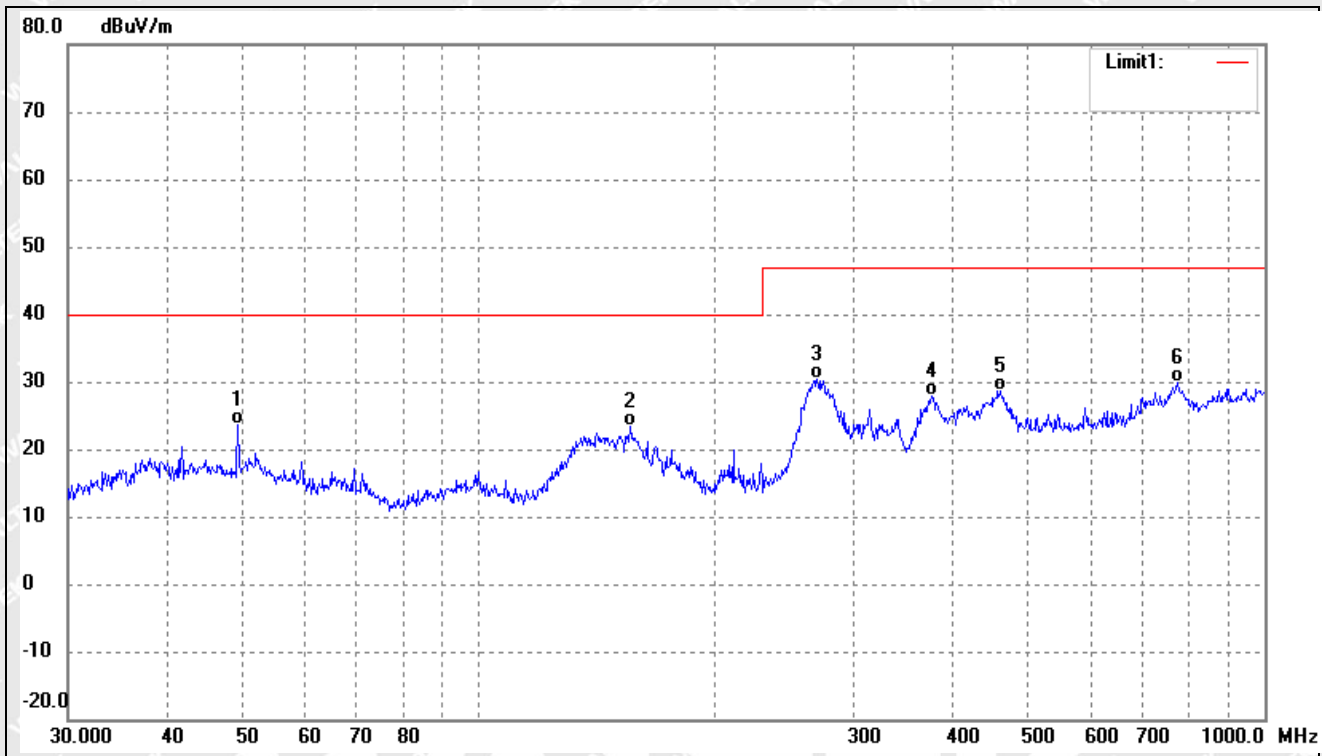

No.	Frequency (MHz)	Reading (dBuV/m)	Correct (dB/m)	Result (dBuV/m)	Limit (dBuV/m)	Margin (dB)	Degree ()	Height (cm)	Remark
1	49.3594	34.57	-10.89	23.68	40.00	-16.32	281	100	QP
2	155.9101	38.44	-15.01	23.43	40.00	-16.57	92	100	QP
3	269.4284	40.73	-10.28	30.45	47.00	-16.55	331	100	QP
4	377.2591	34.75	-6.89	27.86	47.00	-19.14	97	100	QP
5	460.7271	34.23	-5.51	28.72	47.00	-18.28	217	100	QP
6	774.1584	31.63	-1.79	29.84	47.00	-17.16	115	100	QP



Test mode:	TM1	Polarity:	Vertical
------------	-----	-----------	----------

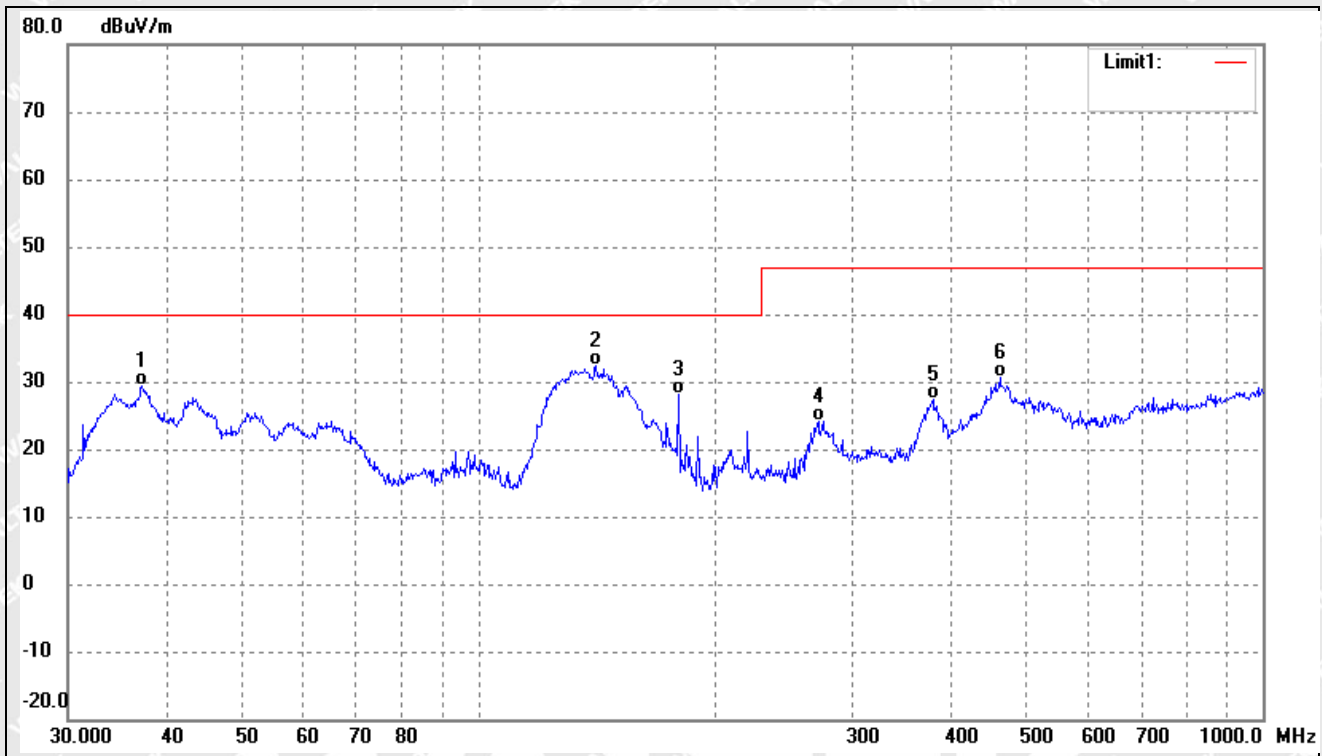

No.	Frequency (MHz)	Reading (dBuV/m)	Correct (dB/m)	Result (dBuV/m)	Limit (dBuV/m)	Margin (dB)	Degree ()	Height (cm)	Remark
1	37.2855	40.70	-11.39	29.31	40.00	-10.69	149	100	QP
2	141.3298	47.58	-15.19	32.39	40.00	-7.61	114	100	QP
3	180.0165	42.24	-14.02	28.22	40.00	-11.78	97	100	QP
4	271.3246	34.40	-10.23	24.17	47.00	-22.83	132	100	QP
5	379.9141	34.10	-6.78	27.32	47.00	-19.68	184	100	QP
6	462.3455	36.07	-5.48	30.59	47.00	-16.41	308	100	QP



Test mode:	TM2	Polarity:	Horizontal
------------	-----	-----------	------------

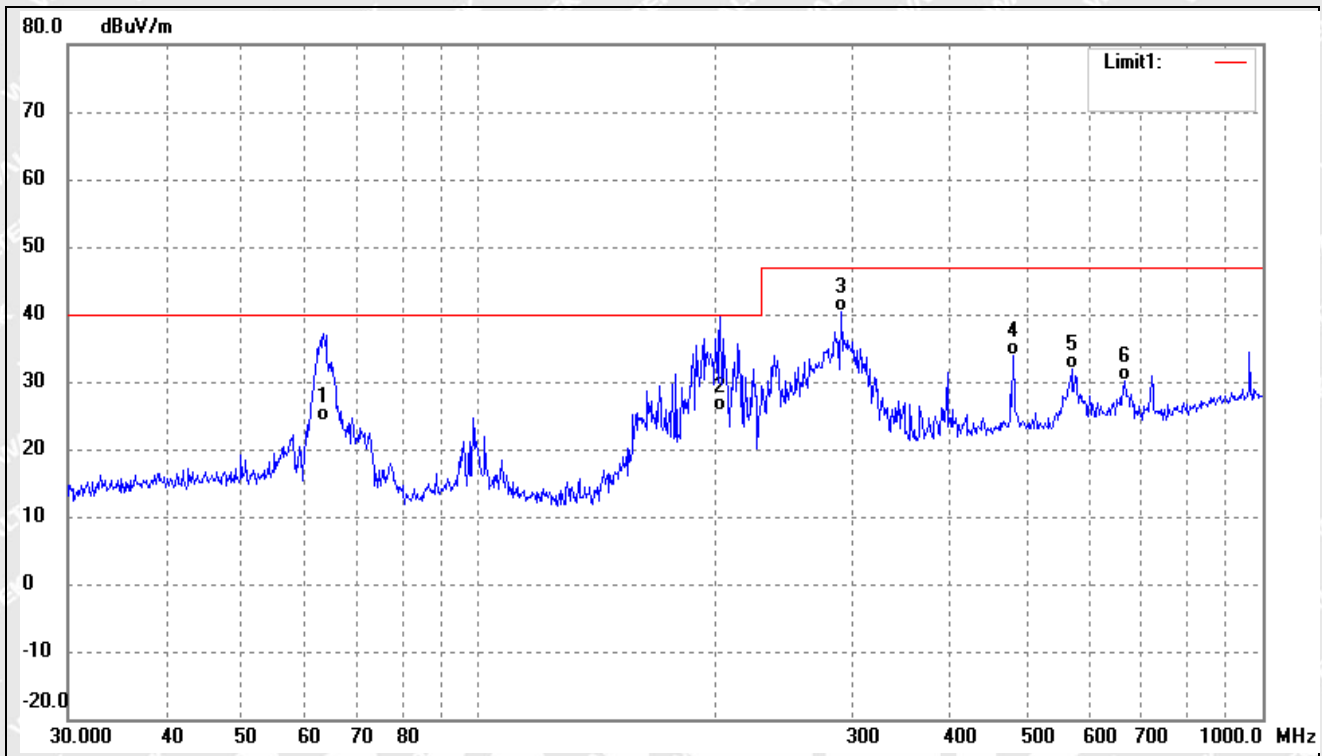

No.	Frequency (MHz)	Reading (dBuV/m)	Correct (dB/m)	Result (dBuV/m)	Limit (dBuV/m)	Margin (dB)	Degree ()	Height (cm)	Remark
1	63.5356	37.71	-13.63	24.08	40.00	-15.92	94	100	QP
2	203.5227	37.99	-12.29	25.70	40.00	-14.30	160	100	QP
3	290.0172	50.14	-9.64	40.50	47.00	-6.50	90	100	QP
4	480.5276	39.04	-5.20	33.84	47.00	-13.16	345	100	QP
5	570.6100	36.13	-4.30	31.83	47.00	-15.17	275	100	QP
6	668.1422	33.46	-3.21	30.25	47.00	-16.75	303	100	QP



Test mode:	TM2	Polarity:	Vertical
------------	-----	-----------	----------

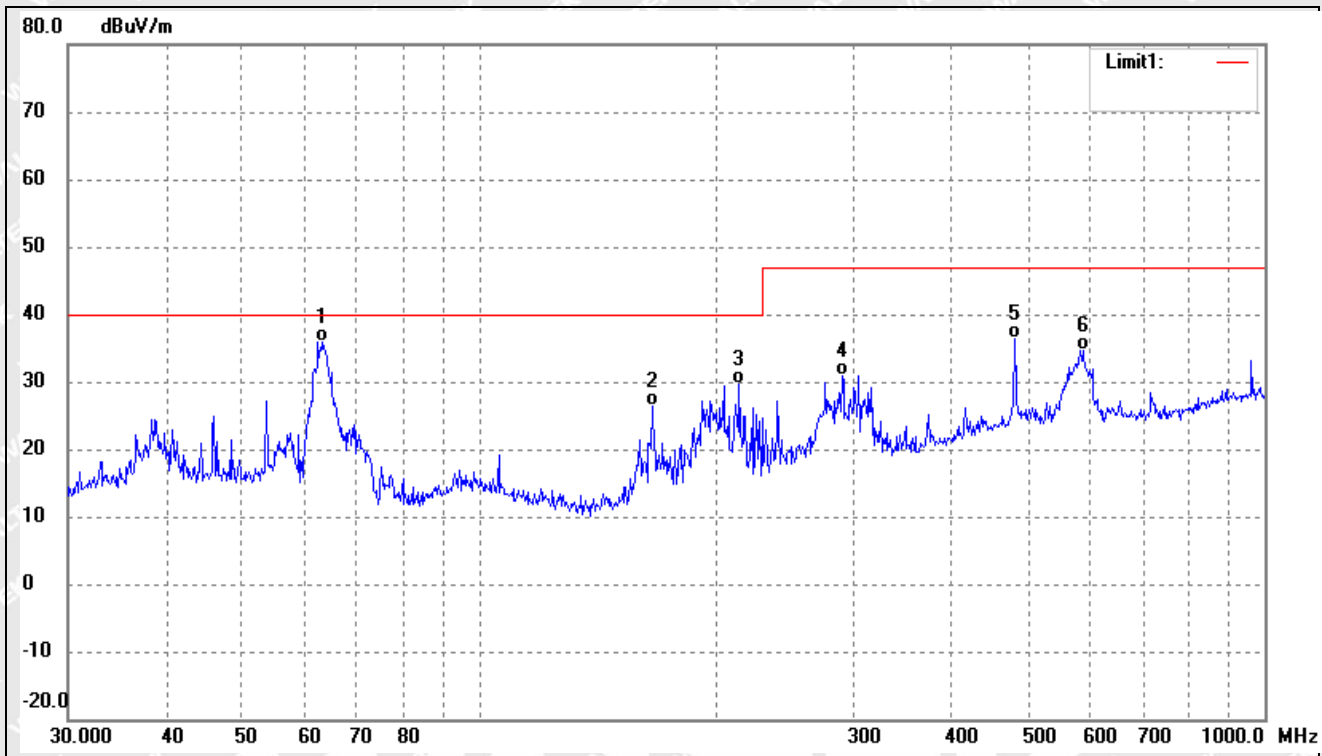

No.	Frequency (MHz)	Reading (dBuV/m)	Correct (dB/m)	Result (dBuV/m)	Limit (dBuV/m)	Margin (dB)	Degree ()	Height (cm)	Remark
1	63.3132	49.48	-13.58	35.90	40.00	-4.10	269	100	QP
2	166.0680	41.04	-14.58	26.46	40.00	-13.54	161	100	QP
3	214.5143	41.57	-11.97	29.60	40.00	-10.40	97	100	QP
4	290.0172	40.57	-9.64	30.93	47.00	-16.07	311	100	QP
5	480.5276	41.49	-5.20	36.29	47.00	-10.71	140	100	QP
6	586.8437	38.68	-4.00	34.68	47.00	-12.32	230	100	QP



5. Electrostatic Discharges (ESD)

5.1 Test Procedure

Test is conducted under the description of EN 61000-4-2.

5.2 Test Performance

Performance Criterion: B

5.3 Environmental Conditions

Temperature:	20.5 °C
Relative Humidity:	47 %
ATM Pressure:	1012 mbar

5.4 Basic Test Setup Block Diagram

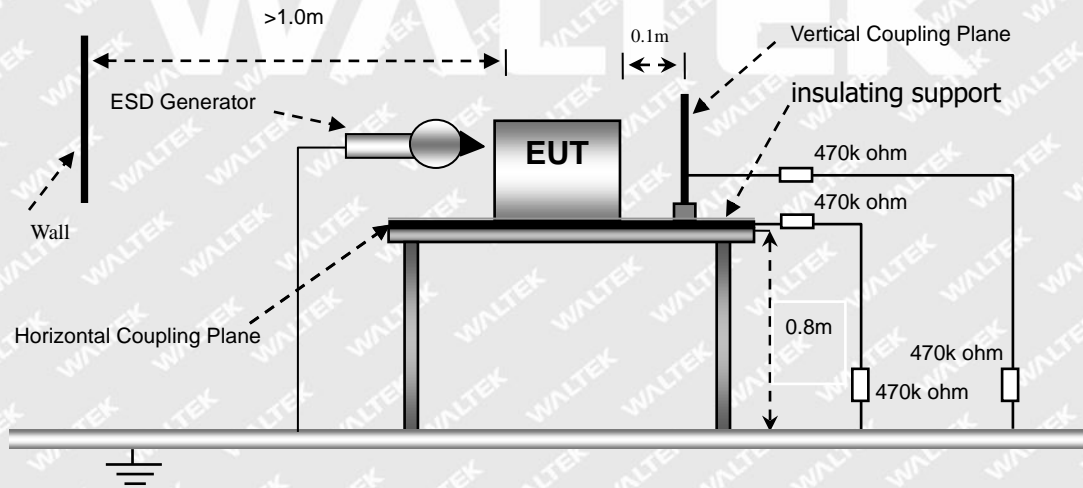



5.5 Electrostatic Discharge Immunity Test Data

Table 1: Electrostatic Discharge Immunity (Air Discharge)

EN 61000-4-2 Test Points	Test Voltage (kV)									
	-2	+2	-4	+4	-6	+6	-8	+8	-15	+15
Surface crack	A	A	A	A	A	A	A	A	/	/

Table 2: Electrostatic Discharge Immunity (Direct Contact)

EN 61000-4-2 Test Points	Test Voltage (kV)									
	-2	+2	-4	+4	-6	+6	-8	+8	-15	+15
/	/	/	/	/	/	/	/	/	/	/

Table 3: Electrostatic Discharge Immunity (Indirect Contact HCP & VCP)

EN 61000-4-2 Test Points	Test Voltage (kV)									
	-2	+2	-4	+4	-6	+6	-8	+8	-15	+15
HCP (6 Sides)	A	A	A	A	/	/	/	/	/	/
VCP (4 Sides)	A	A	A	A	/	/	/	/	/	/

Test Result: Pass



6. Continuous RF Electromagnetic Field Disturbances (RS)

6.1 Test Procedure

Test is conducted under the description of EN 61000-4-3.

6.2 Test Performance

Performance Criterion: A

6.3 Environmental Conditions

Temperature:	23.5 °C
Relative Humidity:	54 %
ATM Pressure:	1011 mbar

6.4 Basic Test Setup Block Diagram

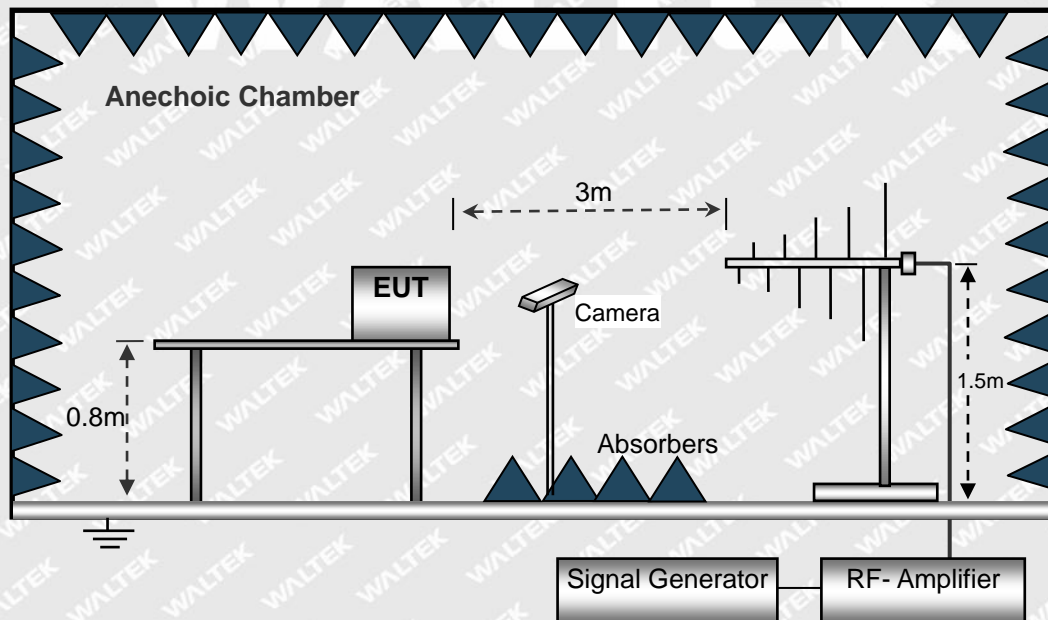



6.5 Continuous Radiated Disturbances Test Data

Frequency step: 1% of fundamental

Dwell time: 1 second

Modulation: AM by 1kHz sine wave with 80% modulation depth

Frequency Range(MHz)	Field (V/m)	Front		Rear		Left Side		Right Side	
		VERT	HORI	VERT	HORI	VERT	HORI	VERT	HORI
80-1000	3	A	A	A	A	A	A	A	A

Spot frequencies (MHz)	Field (V/m)	Front		Rear		Left Side		Right Side	
		VERT	HORI	VERT	HORI	VERT	HORI	VERT	HORI
1800	3	A	A	A	A	A	A	A	A
2600	3	A	A	A	A	A	A	A	A
3500	3	A	A	A	A	A	A	A	A
5000	3	A	A	A	A	A	A	A	A

Test Result: Pass



7. Electrical Fast Transients (EFT)

7.1 Test Procedure

Test is conducted under the description of EN 61000-4-4.

7.2 Test Performance

Performance Criterion: B

7.3 Environmental Conditions

Temperature:	23.5 °C
Relative Humidity:	54 %
ATM Pressure:	1011 mbar

7.4 Basic Test Setup Block Diagram

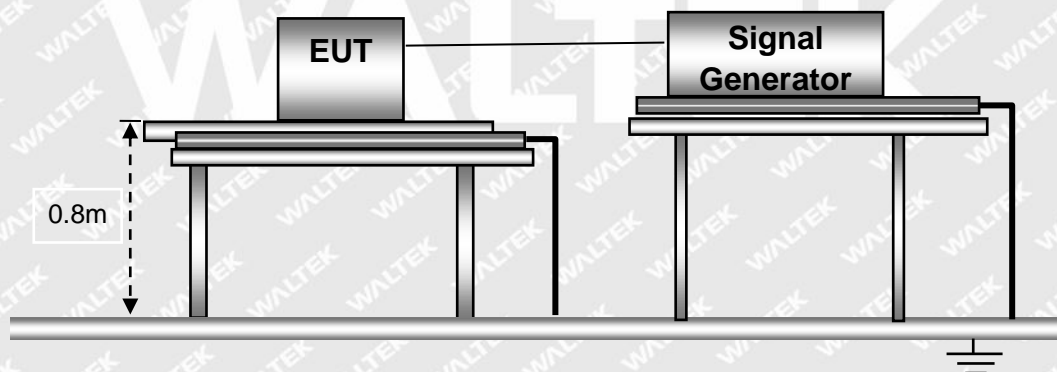



7.5 Electrical Fast Transients Test Data

EN 61000-4-4 Test Points		Test Voltage (kV)							
		+0.5	-0.5	+1.0	-1.0	+2.0	-2.0	+4.0	-4.0
Power Supply Power Port of EUT	L1	/	/	B	B	/	/	/	/
	L2	/	/	B	B	/	/	/	/
	PE	/	/	/	/	/	/	/	/
	L1+L2	/	/	B	B	/	/	/	/
	L1 + PE	/	/	/	/	/	/	/	/
	L2 + PE	/	/	/	/	/	/	/	/
	L1+L2+PE	/	/	/	/	/	/	/	/
Signal ports	RJ45	/	/	/	/	/	/	/	/

Test Result: Pass





8. Surges

8.1 Test Procedure

Test is conducted under the description of EN 61000-4-5.

8.2 Test Performance

Performance Criterion: B for AC Mains;C for RJ45 Port.

8.3 Environmental Conditions

Temperature:	23.5 °C
Relative Humidity:	54 %
ATM Pressure:	1011 mbar

8.4 Basic Test Setup Block Diagram

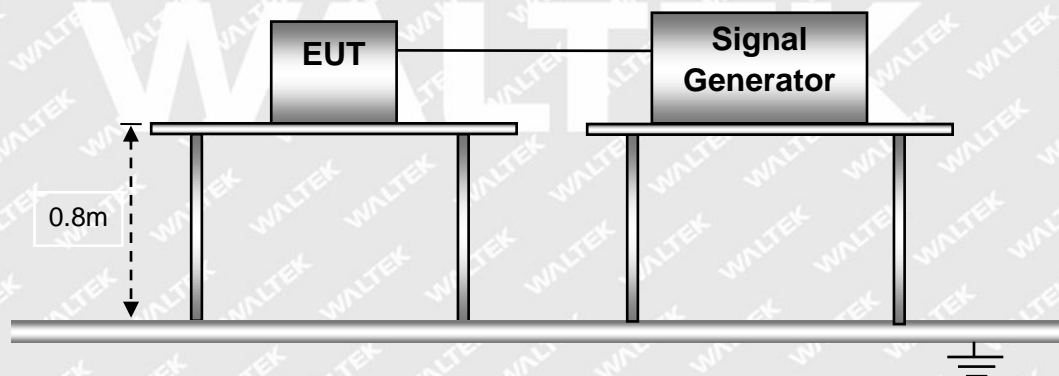



8.5 Surge Test Data

AC Port

Test Voltage (kV)	Poll	Path	Pass	Fail
0.5kV	±	L-N	/	/
1kV	±	L-N	B	/
2kV	±	L-PE, N-PE	/	/
4kV	±	L-N, L-PE, N-PE	/	/

Test Result: Pass

WALTEK



9. Continuous Induced RF Disturbances (C/S)

9.1 Test Procedure

Test is conducted under the description of EN 61000-4-6.

9.2 Test Performance

Performance Criterion: A

9.3 Environmental Conditions

Temperature:	23.5 °C
Relative Humidity:	54 %
ATM Pressure:	1011 mbar

9.4 Basic Test Setup Block Diagram

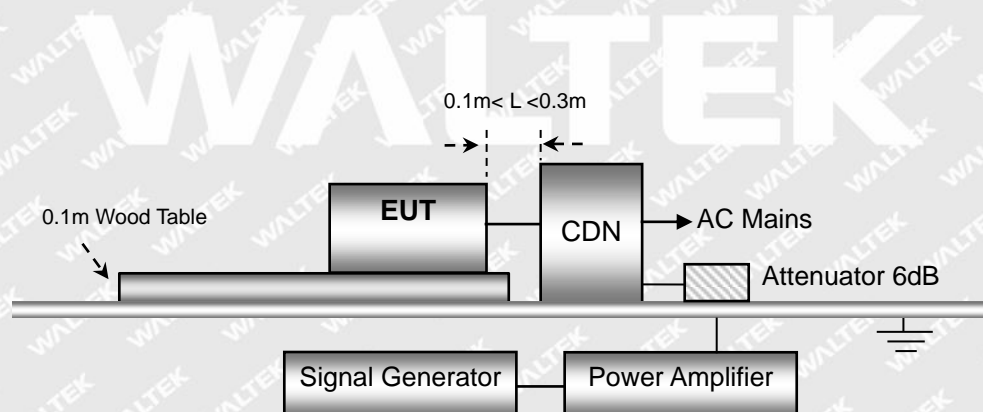



9.5 Continuous Conducted Disturbances Test Data

Sweep frequency range: 0.15MHz to 10MHz 3V; 10MHz to 30MHz 3V to 1V; 30MHz to 80MHz 1V

Frequency step: 1% of fundamental

Dwell time: 1 second

AC Port

Frequency MHz	Injected Position	Voltage level (e.m.f.)	Observations (Performance Criterion)	Result
0.15-10	AC Mains	3V	A	Pass
10-30	AC Mains	3-1V	A	Pass
30-80	AC Mains	1V	A	Pass

Test Result: Pass

WALTEK



10. Power-Frequency Magnetic Fields (PFMF)

10.1 Test Procedure

Test is conducted under the description of EN 61000-4-8.

10.2 Test Performance

Performance Criterion: A

10.3 Environmental Conditions

Temperature:	23.0 °C
Relative Humidity:	52 %
ATM Pressure:	1013 mbar

10.4 Basic Test Setup Block Diagram

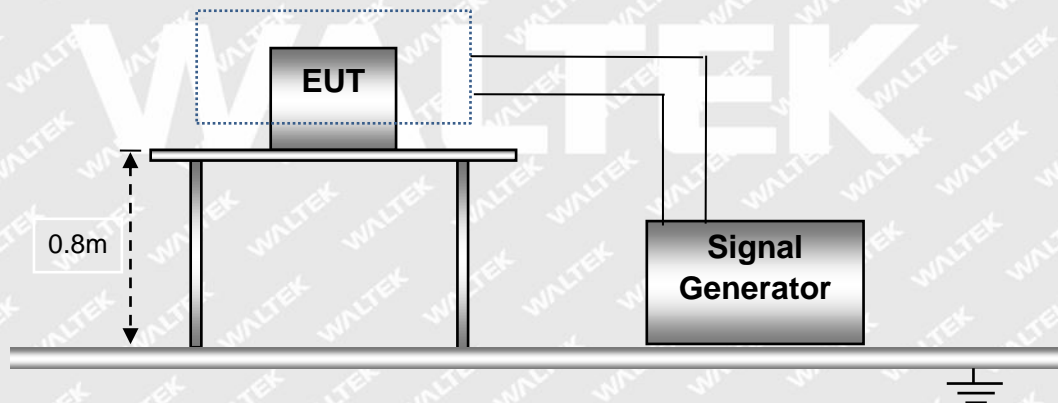



10.5 Power-Frequency Magnetic Field Test Data

Level	Magnetic Field Strength (r.m.s) A/m	Frequency Hz	Induction Coil Position	Pass	Fail
1	1	50	X, Y, Z	A	/
2	3	50	X, Y, Z	/	/
3	10	50	X, Y, Z	/	/
X	Special	/	/	/	/

Test Result: Pass





EXHIBIT 1 - PRODUCT LABELING

Proposed CE Label Format

<p>aluminium alloy nylon braided cable Model: UC409 Brand: / Importer Name: XXX Importer Address: XXX SHENZHEN MONOKO TECHNOLOGY CO.,LTD. Room 507, Building 10, Yungu Phase 2, No.2, Pingshan First Road, Taoyuan street, Nanshan District, Shenzhen, China</p>	
---	--

Specifications: Text is Black in color and is justified. Labels are printed in indelible ink on permanent adhesive backing or silk-screened onto the EUT or shall be affixed at a conspicuous location on the EUT. The 'CE' marking must be affixed to the EUT or to its data plate. Where this is not possible or not warranted on account of the nature of the apparatus, it must be affixed to the packaging, if any, and to the accompanying documents. The 'CE' marking must have a height of at least 5 mm. If the 'CE' marking is reduced or enlarged the proportions given in the above graduated drawing must be respected. The Importer name, address and Manufacturer name and address should indicate on marking label or packaging or in a document accompanying.

Proposed Label Location on EUT

CE Label Location



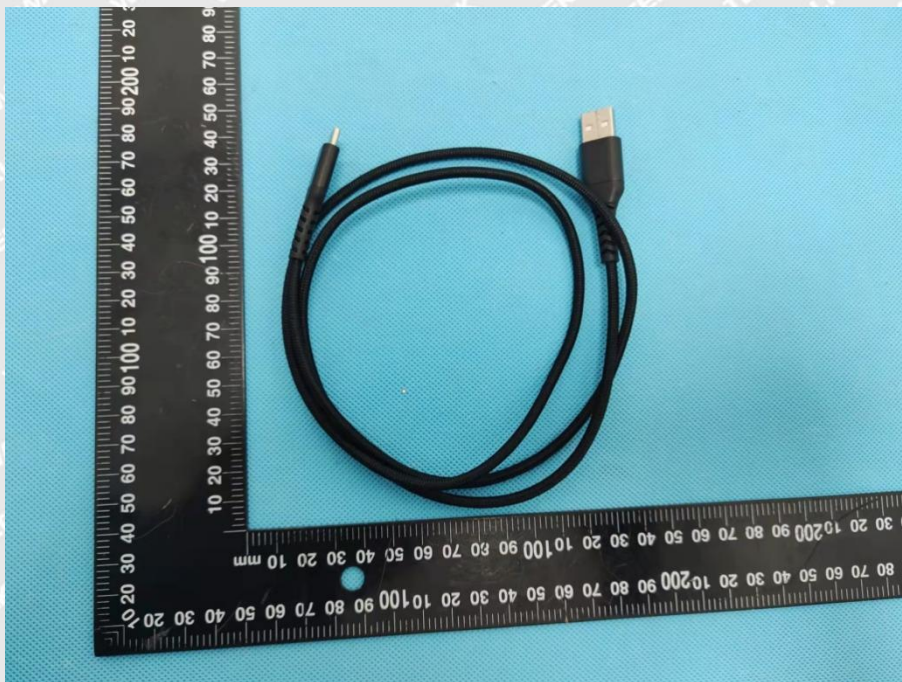

EXHIBIT 2 - EUT PHOTOGRAPHS

EUT View 1



EUT View 2





Reference No.: WTX22X07147399E

EUT View 3

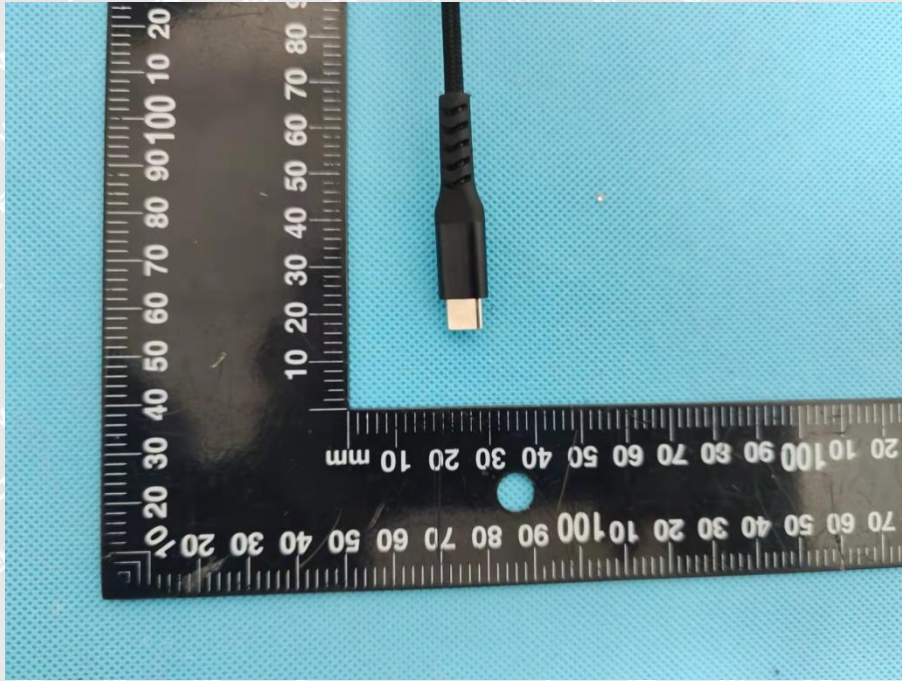

EUT View 4

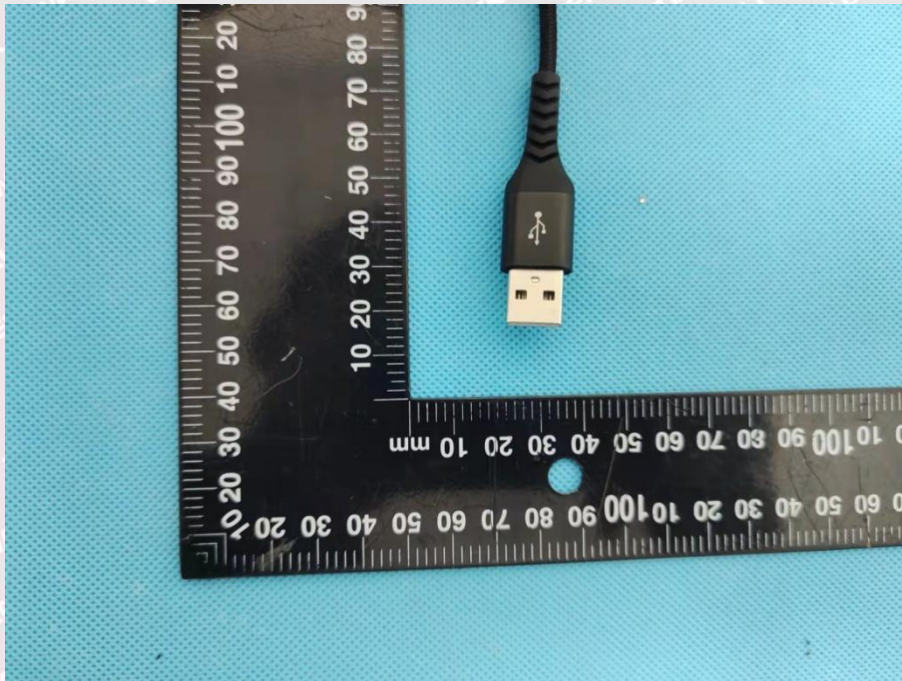



EUT Housing and Board View 1

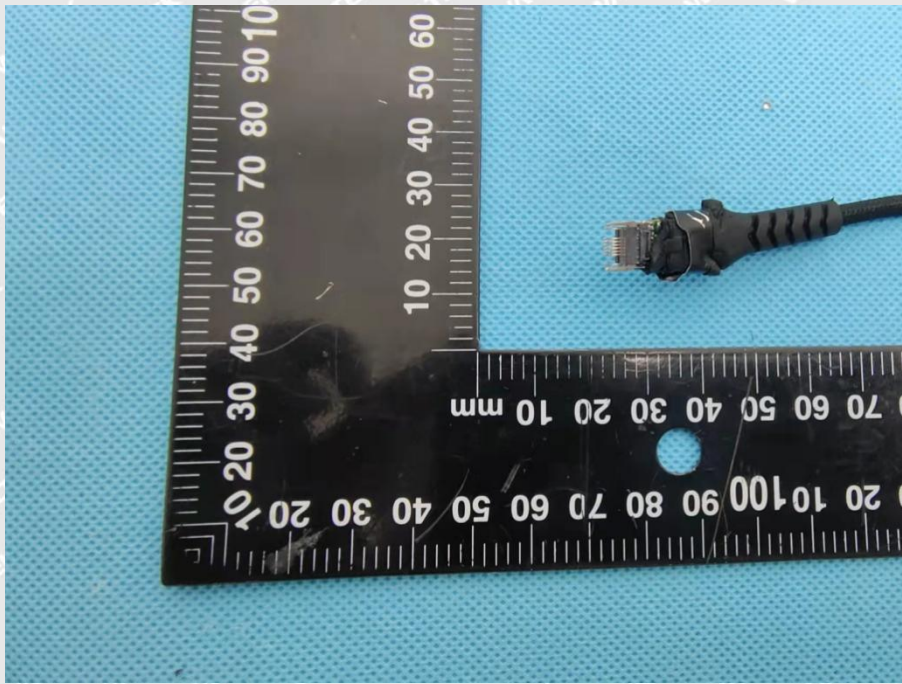

Solder Board-Component View 2

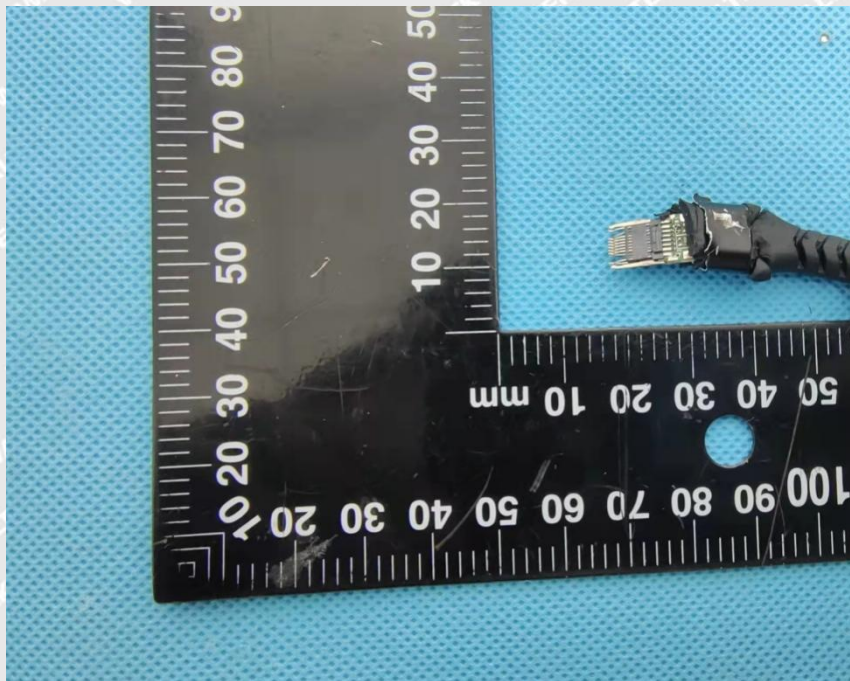
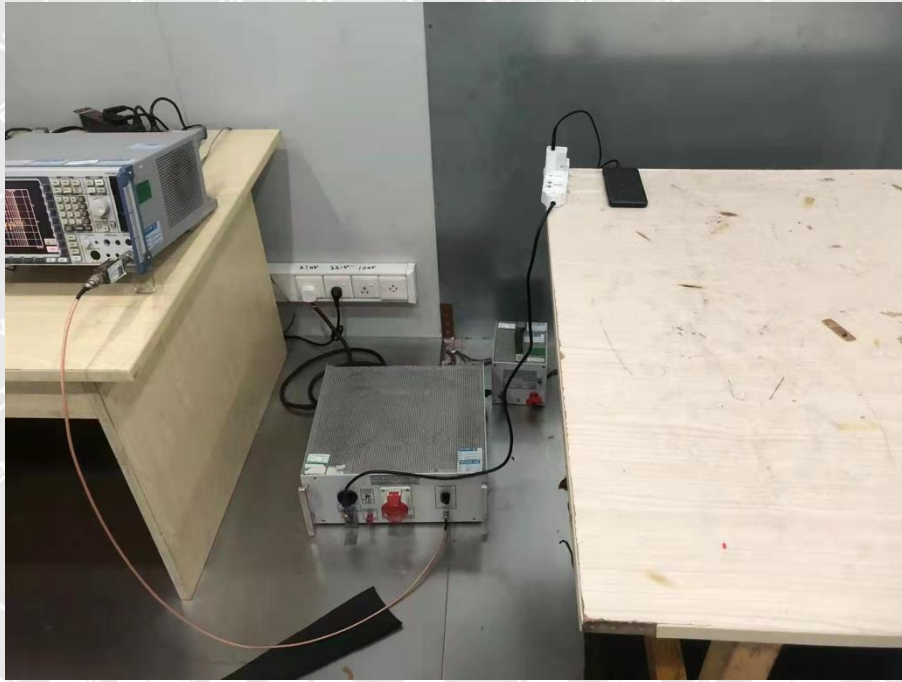

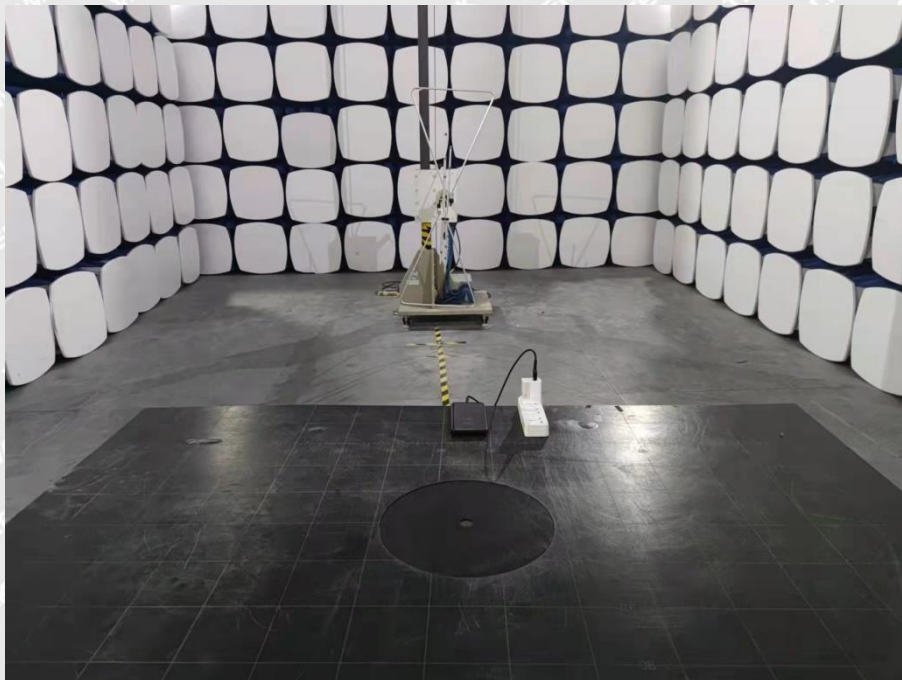

EXHIBIT 3 - TEST SETUP PHOTOGRAPHS

Conduction Emission Test View



Radiation Emission Test View





Reference No.: WTX22X07147399E

EN 61000-4-2 Test View

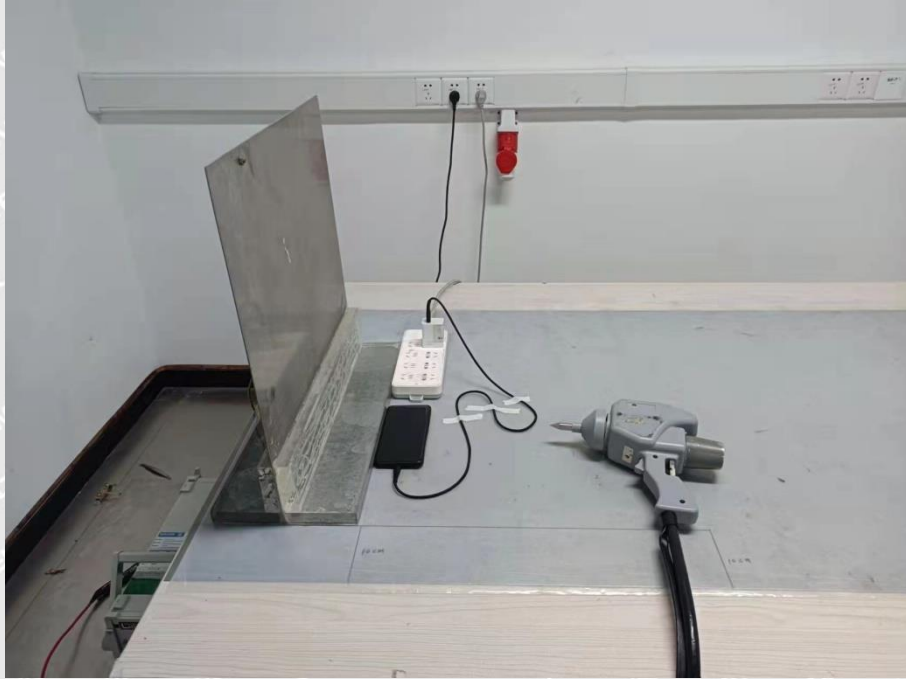

WALTEK

EN 61000-4-3 Test View

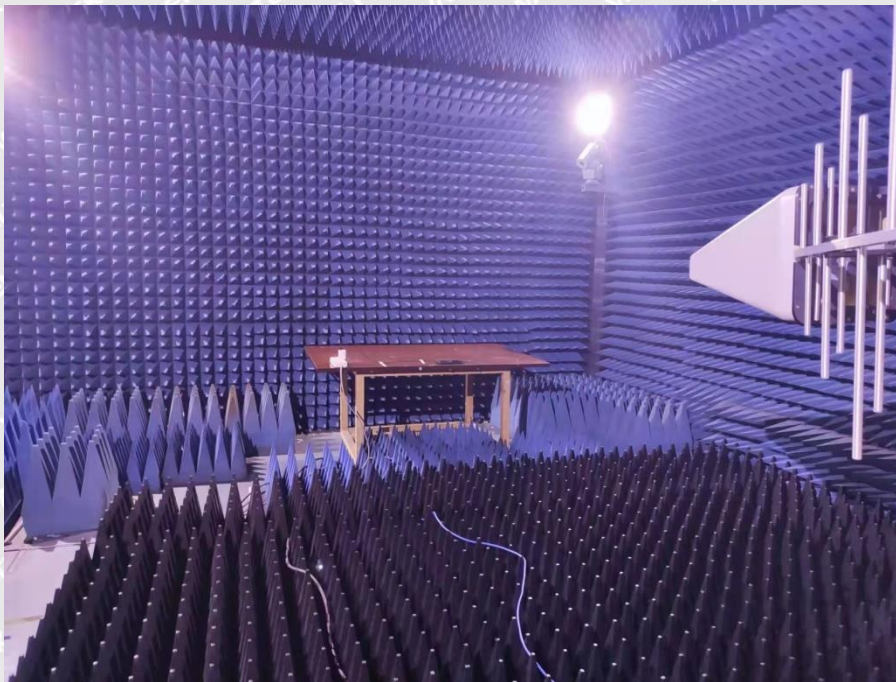



Reference No.: WTX22X07147399E

EN 61000-4-4/5 Test View

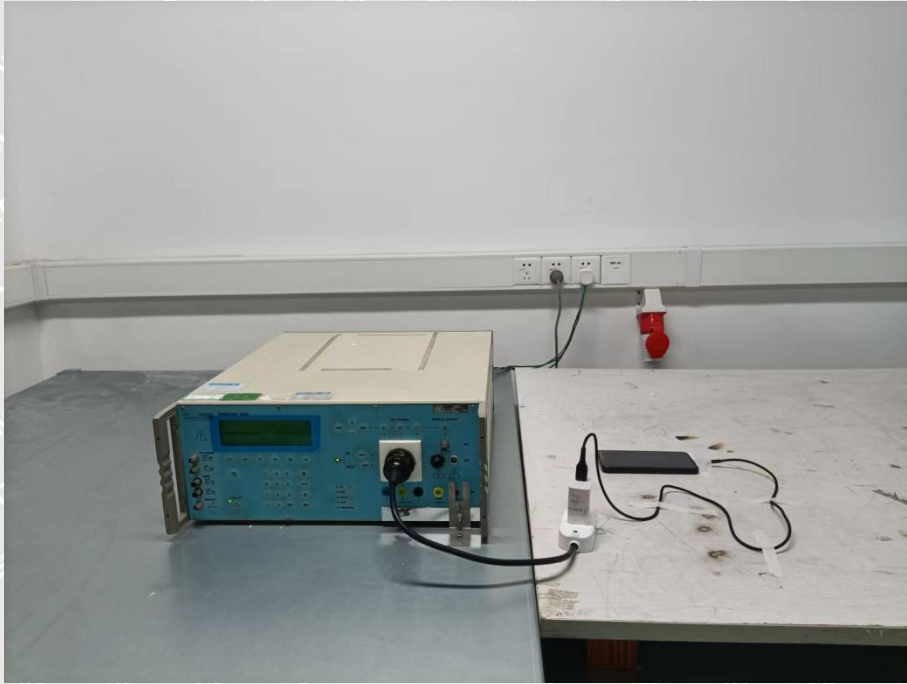

EN 61000-4-6 Test View

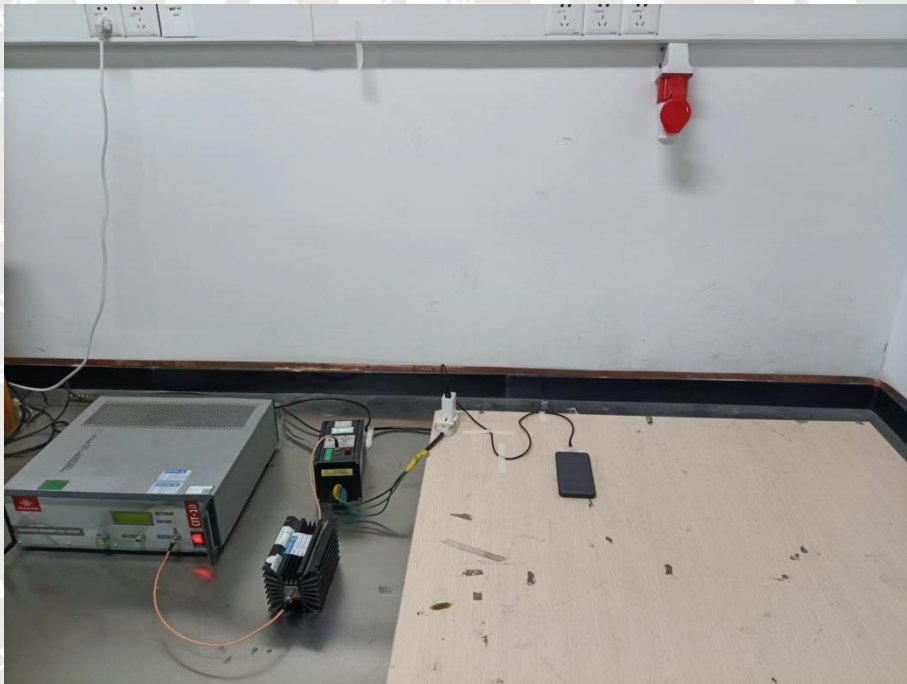



Reference No.: WTX22X07147399E

EN 61000-4-8 Test View

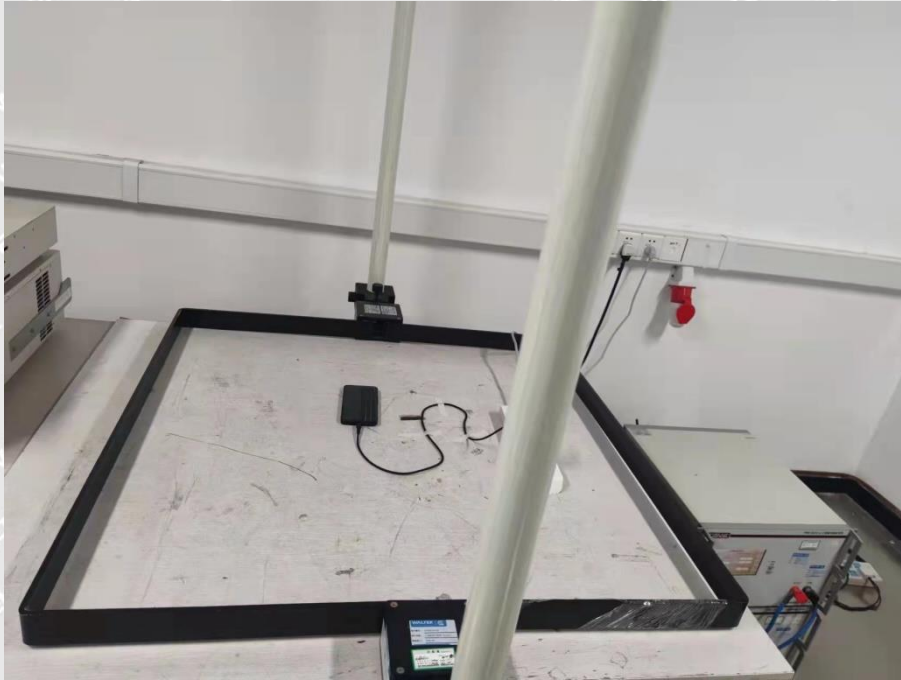

***** END OF REPORT *****

WALTEK